

CHEMISTRY

SENIOR 5

Teacher's guide

Copyright

© 2024 Rwanda Basic Education Board

All rights reserved.

This book is a property of Rwanda Basic Education Board

Credit should be given to REB when the source of this book is quoted.

FOREWORD

Dear teacher,

Rwanda Basic Education Board is honoured to present Senior 5 Chemistry teacher's guide which serves as a guide to competence-based teaching and learning to ensure consistency and coherence in the learning of the chemistry subject. The Rwandan educational philosophy is to ensure that learners achieve full potential at every level of education which will prepare them to be well integrated in society and exploit employment opportunities.

In line with efforts to improve the quality of education, the government of Rwanda emphasizes the importance of aligning teaching and learning materials with the syllabus to facilitate their learning process. Many factors influence what they learn, how well they learn and the competences they acquire. Those factors include the relevance of the specific content, the quality of teachers' pedagogical approaches, the assessment strategies and the instructional materials available. We paid special attention to the activities that facilitate the learning process in which learners can develop ideas and make new discoveries during concrete activities carried out individually or with peers. With the help of the teachers, learners will gain appropriate skills and be able to apply what they have learnt in real life situations. Hence, they will be able to develop certain values and attitudes allowing them to make a difference not only to their own life but also to the nation.

This is in contrast to traditional learning theories which view learning mainly as a process of acquiring knowledge from the more knowledgeable who is mostly the teacher. In competence-based curriculum, learning is considered as a process of active building and developing of knowledge and understanding, skills and values and attitude by the learner where concepts are mainly introduced by an activity, situation or scenario that helps the learner to construct knowledge, develop skills and acquire positive attitudes and values.

In addition, such active learning engages learners in doing things and thinking about the things they are doing and they are encouraged to bring their own real experiences and knowledge into the learning processes. In view of this, your role is to:

- Plan your lessons and prepare appropriate teaching materials.
- Organize group discussions for learners considering the importance of social constructivism suggesting that learning occurs more effectively when the learner works collaboratively with more knowledgeable and experienced people.
- Engage learners through active learning methods such as inquiry methods, group discussions, research, investigative activities and group and individual work activities.

- Provide supervised opportunities for learners to develop different competences by giving tasks which enhance critical thinking, problem solving, research, creativity and innovation, communication and cooperation.
- Support and facilitate the learning process by valuing learners' contributions in the class activities.
- Guide learners towards the harmonization of their findings.
- Encourage individual, peer and group evaluation of the work done in the classroom and use appropriate competence-based assessment approaches and methods.

To facilitate you in your teaching activities, the content of this teacher's guide is self-explanatory so that you can easily use it. It is divided in 3 parts:

The part 1: Explains the structure of this book and gives you the methodological guidance;

The part 2: Gives the sample lesson plans as reference for your lesson planning process;

The part 3: Provides details the teaching guidance for each concept given in the student book.

Even though this teacher's guide contains the answers for all activities given in the learner's book, you are requested to work through each question and activity before judging learner's findings.

I wish to sincerely appreciate all people who contributed towards the development of this teacher's guide, particularly REB staff who organized the whole process from its inception. Special gratitude goes to the University of Rwanda which provided experts in design and layout services, illustrations and image anti-plagiarism, lecturers and teachers who diligently worked to successful completion of this book. Any comment or contribution would be welcome for the improvement of this textbook for the next edition.



Dr. MBARUSHIMANA Nelson
Director General, REB

ACKNOWLEDGEMENT

I wish to express my appreciation to all the people who played a major role in development of this Chemistry textbook for senior five. It would not have been successful without active participation of different education stakeholders.

I owe gratitude to different Universities and schools in Rwanda that allowed their staff to work with REB in the in-house textbooks production project. I wish to extend my sincere gratitude to lecturers, teachers and all other individuals whose efforts in one way or the other contributed to the success of writing of this textbook.

Special acknowledgement goes to the University of Rwanda which provided experts in design and layout services, illustrations and image anti-plagiarism.

Finally, my word of gratitude goes to the Rwanda Basic Education Board staff particularly those from the Curriculum, Teaching and Learning Resources Department (CTLRD) who were involved in the whole process of in-house textbook writing.



Joan MURUNGI,

Head of Curriculum, Teaching and Learning Resources Department

Contents

FOREWORD	i
ACKNOWLEDGEMENT	iii
PART I. GENERAL INTRODUCTION	xi
1.1 The structure of the guide	xi
1.2 Methodological guidance	xiii
PART II: SAMPLE LESSON PLAN	xxv
PART III: UNIT DEVELOPMENT	xxix
UNIT 1: INTRODUCTION TO ORGANIC CHEMISTRY	1
1.1 Key unit competency	1
1.2 Prerequisites (knowledge, skills, attitudes and values)	1
1.3 Cross-cutting issues to be addressed	1
1.4. Guidance on the introductory activity	3
1.5. List of lessons	4
1.6 Guidance on different lessons	5
1.7. Summary of the unit	13
1.8. End unit assessment	14
1.9. Additional activities	16
UNIT 2: ALKANES	19
2.1. Key unit competency	19
2.2. Prerequisites	19
2.3. Cross-cutting Issues to be addressed	19
2.4. Guidance on the introductory activity	20
2.5. List of lessons	21
2.6 Guidance on different lessons	22
2.7. Unit Summary	30
2.8. Additional Information for teachers	30
2.9. End Unit assessment	31
2.10. Additional activities	32
UNIT 3: ALKENES AND ALKYNES	35

3.1 Key unit competency	35
3.2 Prerequisite (knowledge, skills, attitudes and values)	35
3.3 Cross-cutting issues to be addressed	35
3.4. Guidance on the introductory activity	37
3.5. List of lessons	37
3.6. Guidance on different lessons	39
3.7. Unit summary	57
3.8. Additional Information	58
3.9 .End unit assessment	59
3.10. Additional activities	62
UNIT 4: HALOGENOALKANES	67
4.1.Key unit competency	67
4.2. Prerequisite knowledge and skills	67
4.3. Cross-cutting issues to be addressed	67
4.4. Guidance on introductory activity	68
4.5. List of lessons	69
4.6. Guidance on different lessons	70
4.8. Additional Information	82
4.9. End unit assessment	82
4.10. Additional activities	85
UNIT 5: ALCOHOLS AND ETHERS	87
5.1. Key unit competency	87
5.2. Prerequisite (knowledge, skills, attitudes and values)	87
5.3. Cross-cutting issues to be addressed	87
5.4. Guidance on the introductory activity	87
5.5. List of lessons	88
5.6. Guidance on the lessons	90
5.7. Unit summary	103
5.8. Additional information	103
5.9. Unit assessment	104
5.10. Additional activities	106
UNIT 6: CARBONYL COMPOUNDS: ALDEHYDES AND KETONES	111

6.1. Key unit competency	111
6.2. Prerequisite (knowledge, skills, attitudes and values)	111
6.3. Cross-cutting issues to be addressed	111
6.4. Guidance on the introductory activity	111
6.5. List of lesson	112
6.6. Guidance on the lessons	113
6.7. Summary of the unit	129
6.8. Additional information for the teacher	130
6.9. End unit assessment	131
6.10. Additional activities	136
UNIT 7: CARBOXYLIC ACIDS AND ACYL CHLORIDES	144
7.1. Key unit competence	144
7.2. Prerequisite	144
7.3. Cross-cutting issues to be addressed	144
7.4. Guidance on introductory activity	144
7.5. List of lessons	145
7.6. Guidance on the lessons	146
7.7. Summary of the unit	163
7.8. Additional information for the teacher	164
7.9. End unit assessment	166
7.10. Additional activities	168
UNIT 8: ESTERS, ACID ANHYDRIDES, AMIDES AND NITRILES	173
8.1. Key unit competence	173
8.2. Introduction	173
8.3. Cross-cutting issues to be addressed	173
8.4. Guidance on the introductory activity	174
8.5. List of lessons	175
8.6. Guidance on the lessons	176
8.7. Summary of the unit	195
8.8. Additional information for the teacher	196
8.9. End unit assessment (Answers)	196
8.10. Additional activities	200
UNIT 9: AMINES AND AMINO ACIDS	210
9.1. Key unit competence	210

9.2 Prerequisites	210
9.3 Cross-cutting issues to be addressed	210
9.4 Guidance on introductory activity	211
9.5 List of lessons	212
9.6. Guidance on the lessons	213
9.7 Summary of the unit	231
9.8 Additional Information for teachers	233
9.9 Answers to the end unit assessment	241
9.10 Additional activities	243
UNIT 10: PHASE DIAGRAMS	250
10.1. Key unit competency	250
10.2. Prerequisite	250
10.3. Cross-cutting issues to be addressed	250
10.4. Guidance on introductory activity	250
10.5. List of lessons	251
10.6. Guidance on the lessons	252
10.7 Summary of the unit	261
10.8. End unit assessment	262
10.9 Additional activities	263
UNIT 11: SOLUTIONS AND TITRATION	268
11.1 Key unit competency:	268
11.2 Prerequisite (knowledge, skills, attitudes and values)	268
11.3 Cross-cutting issues to be addressed	268
11.4 Guidance on the introductory activity	269
11.5 List of lessons (including assessment).	271
11.6 Guidance on different lessons	272
11.7 Summary of the unit	295
11.8 Additional information	296
11.9 End unit assessment (answers) (80minutes)	297
11.10 Additional activities	303
UNIT 12: CONDUCTIVITY OF SOLUTIONS	310
12.1 Key unit competency:	310
12.2. Prerequisite (knowledge, skills, attitudes and values)	310

12. 3. Cross-cutting issues to be addressed	310
12.4. Guidance on the introductory activity	312
12.5. List of lessons (including assessment).	313
12.6. Guidance on different lessons	314
12.7. End unit assessment answers	325
12.8. Additional content	333
12.8. Additional activities	338
Unit 13: ELECTROLYSIS	344
13.1 Key unit competence	344
13.2 Prerequisite knowledge and skills	344
13.3 Cross-cutting issues to be addressed	344
13.4 Guidance on introductory activity	344
13.5 List of lessons (including assessment).	346
13.6 Unit Summary	362
UNIT 14: ENTHALPY CHANGE OF REACTIONS	368
14.1 Key unit competence:	368
14.2 Prerequisite knowledge and skills	368
14.3 Cross-cutting issues to be addressed	368
14.4. Guidance on the introductory activity	370
14.5. List of lessons (including assessment).	371
14.8. Unit summary	399
14.9. Additional Information	400
14.10. End unit assessment	401
14.11. Additional activities	407
UNIT 15: ENTROPY AND FREE ENERGY	419
15.1. Key unit competency:	419
15. 2. Prerequisite (knowledge, skills, attitudes and values)	419
15. 3. Cross-cutting issues to be addressed	419
15. 4. Guidance on the introductory activity	420
15.5. List of lessons (including assessment).	421
15. 6. Guidance on different lessons	422
15.7. Unit summary	428
15.8. Answers to end unit questions	429
15.9. Additional activities	433

PART I. GENERAL INTRODUCTION

About the teacher's guide

This book is a teacher's guide for chemistry senior five in advanced level. It is designed to accompany senior four student's book and intends to help teachers in the implementation of competence based curriculum specifically Chemistry syllabus.

As the name says, it is a guide that teachers can refer to when preparing their lessons. Teachers may prefer to adopt the guidance provided but they are also expected to be more creative and consider their specific classes' contexts and prepare accordingly.

1.1 The structure of the guide

This section presents the overall structure, the unit and sub-heading structure to help teachers to understand the different sections of this guide and what they will find in each section.

Overall structure

The whole guide has three main parts as follows:

- **Part I: General Introduction**

This part provides general guidance on how to develop the generic competences, how to integrate cross cutting issues, how to cater for learners with special educational needs, active methods and techniques of teaching chemistry and guidance on assessment.

- **Part II: Sample lesson plan**

This part provides a sample lesson plan, developed and designed to help the teacher develop their own lesson plans.

- **Part III: Unit development**

This is the core part of the guide. Each unit is developed following the structure below. The guide ends with references.

Structure of a unit

Each unit is made of the following sections:

- **Unit title:** from the syllabus
- **Key unit competency:** from the syllabus
- **Prerequisites (knowledge, skills, attitudes and values)**

This section indicates knowledge, skills and attitudes required for the success of the unit. The competence-based approach calls for connections between units/topics within a subject and interconnections between different subjects. The teacher will find an indication of those prerequisites and guidance on how to establish connections.

– **Cross-cutting issues to be addressed**

This section suggests cross cutting issues that can be integrated depending on the unit content. It provides guidance on how to come up with the integration of the issue. Note that the issue indicated is a suggestion; teachers are free to take another cross-cutting issue taking into consideration the learning environment.

– **Guidance on the introductory activity :**

Each unit starts with an introductory activity in the learner’s book. This section of the teacher’s guide provides guidance on how to conduct this activity and related answers. Note that learners may not be able to find the right solution but they are invited to predict possible solutions or answers. Solutions are provided by learners gradually through discovery activities organized at the beginning of lessons or during the lesson.

– **List of lessons/sub-heading**

This section presents in a table suggestion on the list of lessons, lesson objectives copied or adapted from the syllabus and duration for each lesson. Each lesson / subheading is then developed.

– **End of each unit**

At the end of each unit the teacher’s guide provides the following sections:

- Summary of the unit which provides the key points of content developed in the student’s book.
- Additional information which provides additional content compared to the student’s book for the teacher to have a deeper understanding of the topic.
- End unit assessment which provides the answers to questions of end unit assessment in the textbook and suggests additional questions and related answers to assess the Key unit competency.
- Additional activities: remedial, consolidation and extended activities). The purpose of these activities is to accommodate each learner (slow, average and gifted) based on end unit assessment results.

Structure of a lesson / sub heading

Each lesson/sub-heading is made of the following sections:

Lesson Sub heading title:.....

– **Prerequisites/Revision/Introduction:**

This section gives a clear instruction to teacher on how to start the lesson

– **Teaching resources**

This section suggests the teaching aids or other resources needed in line with the activities to achieve the learning objectives. Teachers are encouraged to replace the suggested teaching aids by the available ones in their respective schools and based on learning environment.

– **Learning activities**

This section provides a short description of the methodology and any important aspect to consider. It provides also answers to learning activities with cross reference to text book:

– **Exercises/Checking up**

This provides questions and answers for exercises/ application activities/

1.2 Methodological guidance

1.2.1 Developing competences

Since 2015 Rwanda shifted from a knowledge based to a competency based curriculum for pre-primary, primary and general secondary education. This called for changing the way of learning by shifting from teacher centered to a learner centered approach. Teachers are not only responsible for knowledge transfer but also for fostering student’s learning achievement, and creating safe and supportive learning environment. It implies also that a learner has to demonstrate what he/she is able to do using the knowledge, skills, values and attitude acquired in a new or different or given situation.

The competence-based curriculum employs an approach of teaching and learning based on discrete skills rather than dwelling on only knowledge or the cognitive domain of learning. It focuses on what learner can do rather than what learners know. Learners develop basic competences through specific subject unit competences with specific learning objectives broken down into knowledge, skills and attitudes. These competences are developed through learning activities disseminated in learner-centered rather than the traditional didactic approach. The student is evaluated against set standards to achieve before moving on.

In addition to specific subject competences, learners also develop generic competences which are transferable throughout a range of learning areas and situations in life. Below are examples of how generic competences can be developed in Chemistry:

Generic competence	Examples of activities that develop generic competences
Critical thinking	<ul style="list-style-type: none"> – Classifying organic compounds – Observe, record, interpret data recorded during experiments – Choose the best reagent to test for a substance or to distinguish substances
Research and Problem solving	<ul style="list-style-type: none"> – Research using internet or books from the library – Design a project for making bioplastics – Design a questionnaire for data collection during field visit
Innovation and creativity	<ul style="list-style-type: none"> – Create an experiment procedure to prove a point – Develop a graph to illustrate information – Design a data collection survey/questionnaire – Conduct experiments with objectives, methodology, observations, results, conclusions – Identify local problems and ways to resolve them
Cooperation, Personal and Interpersonal management and life skills	<ul style="list-style-type: none"> – Work in Pairs – Small group work – Large group work
Communication	<ul style="list-style-type: none"> – Organise and present in writing and verbally a complete and clear report of an experiment – Observe, record, interpret the results of a measurement accurately. – Select and use appropriate formats and presentations, such as tables, graphs and diagrams.
Lifelong learning	<ul style="list-style-type: none"> – Exploit all opportunities available to improve on knowledge and skills. Reading scientific journals to keep updated.

1.1.2 Addressing cross cutting issues

Among the changes in the competence based curriculum is the integration of cross cutting issues as an integral part of the teaching learning process-as they relate to and must be considered within all subjects to be appropriately addressed. The eight cross cutting issues identified in the national curriculum framework are: genocide studies, environment and sustainability, gender, comprehensive sexuality education (CSE), peace and values education, financial education, standardization culture and inclusive education.

Some cross cutting issues may seem specific to particular learning areas or subjects but the teacher need to address all of them whenever an opportunity arises. In addition, learners should always be given an opportunity during the learning process to address these cross cutting issues both within and out of the classroom so as to progressively develop related attitudes and values.

Below are examples on how crosscutting issues can be addressed in Chemistry:

Cross-cutting issue	Examples on how to integrate the cross-cutting issue
Inclusive education	Involve all learners in all activities without any bias. Eg: allow a learner with physical disability (using wheelchair) to take notes or lead the team during an experiment.
Gender	Involve both girls and boys in all activities: No activity is reserved only to girls or boys. Teachers should ensure equal participation of both girls and boys during experiments as well as during cleaning and tidying up related activities after experiments.
Peace and Values Education	During group activities, debates and presentations, the teacher will encourage learners to help each other and to respect opinions of colleagues.
Standardization culture	Some lessons involve carrying out experiments. Instructions should be clear for learners to always check if they are not using expired chemicals or defective apparatus. In addition, when performing experiments learners have to record data accurately. For tasks involving calculations, they have to always present accurate results.

Environment and sustainability	In order to avoid the environment pollution, before, during or after experiments learners avoid throwing away chemicals anywhere; special places or appropriate containers should be used. Learners also have to be aware of the impacts of the use of hydrocarbons as fuels, halogenoalkanes, plastics,... on the environment.
Financial Education	When performing experiments, learners avoid waste of chemicals: they have to use the amounts that are just required.

1.1.2. Attention to special needs in the classroom

In the classroom, students learn in different way depending to their learning pace, needs or any other special problem they might have. However, the teacher has the responsibility to know how to adopt his/her methodologies and approaches in order to meet the learning need of each student in the classroom. Also teachers need to understand that student with special needs, need to be taught differently or need some accommodations to enhance the learning environment. This will be done depending to the subject and the nature of the lesson.

In order to create a well-rounded learning atmosphere, teachers need to:

- Remember that children learn in different ways so they have to offer a variety of activities (e.g. role-play, music and singing, word games and quizzes, and outdoor activities)
- Maintain an organized classroom and limits distraction. This will help students with special needs to stay on track during lesson and follow instruction easily.
- Vary the pace of teaching to meet the needs of each child. Some children process information and learn more slowly than others.
- Break down instructions into smaller, manageable tasks. Students with special needs often have difficulty understanding long-winded or several instructions at once. It is better to use simple, concrete sentences in order to facilitate them understand what you are asking.
- Use clear consistent language to explain the meaning (and demonstrate or show pictures) if you introduce new words or concepts.
- Make full use of facial expressions, gestures and body language.
- Pair a child who has a disability with a friend. Let them do things together and learn from each other. Make sure the friend is not over protective and does not do everything for the child. Both children will benefit from this strategy
- Use multi-sensory strategies. As all children learn in different ways, it is important

to make every lesson as multi-sensory as possible. Students with learning disabilities might have difficulty in one area, while they might excel in another. For example, use both visual and auditory cues.

Below are general strategies related to each main category of disabilities and how to deal with every situation that may arise in the classroom. However, the list is not exhaustive because each child is unique with different needs and that should be handled differently.

Strategy to help student with developmental impairment:

- Use simple words and sentences when giving instructions.
- Use real objects that the student can feel and handle. Rather than just working abstractly with pen and paper.
- Break a task down into small steps or learning objectives. The student should start with an activity that s/he can do already before moving on to something that is more difficult.
- Gradually give the student less help.
- Let the student work in the same group with those without disability.

Strategy to help student with visual impairment:

- Help children to use their other senses (hearing, touch, smell and taste) to play and carry out activities that will promote their learning and development.
- Use simple, clear and consistent language.
- Use tactile objects to help explain a concept.
- If the child has some sight, ask them what they can see. Get information from parents/caregivers on how the child manages their remaining sight at home.
- Make sure the child has a group of friends who are helpful and who allow the child to be as independent as possible.
- Plan activities so that children work in pairs or groups whenever possible

Strategy to help student with hearing impairment:

- Strategies to help children with hearing disabilities or communication difficulties
- Always get the child's attention before you begin to speak.
- Encourage the child to look at your face.
- Use gestures, body language and facial expressions.

- Use pictures and objects as much as possible.
- Ask the parents/caregivers to show you the signs they use at home for communication use the same signs yourself and encourage other children to also use them.
- Keep background noise to a minimum.

Strategies to help children with physical disabilities or mobility difficulties:

- Adapt activities so that children who use wheelchairs or other mobility aids, or other children who have difficulty moving, can participate.
- Ask parents/caregivers to assist with adapting furniture e.g. The height of a table may need to be changed to make it easier for a child to reach it or fit their legs or wheelchair under.
- Encourage peer support friends can help friends.
- Get advice from parents or a health professional about assistive devices.

1.1.3 Guidance on assessment

Assessment is an integral part of teaching and learning process. The main purpose of assessment is for improvement. Assessment for learning/ continuous/ formative assessment intends to improve learners’ learning and teacher’s teaching whereas assessment of learning/summative assessment intends to improve the entire school’s performance and education system in general.

Continuous/ formative assessment

It is an ongoing process that arises out of interaction during teaching and learning process. It includes lesson evaluation and end of sub unit assessment. This formative assessment should play a big role in teaching and learning process. The teacher should encourage individual, peer and group evaluation of the work done in the classroom and uses appropriate competence-based assessment approaches and methods.

In Senior five Chemistry textbook, formative assessment principle is applied through checking up activities that are planned in each lesson to ensure that lesson objectives are achieved before moving on. At the end of each unit, the end unit assessment is formative when it is done to give information on the progress of students and from there decide what adjustments need to be done. Assessment standards are taken into consideration when setting tasks.

Summative assessment:

The assessment done at the end of the term, end of year, is considered as summative. The teacher, school and parents are informed on the achievement of educational

objectives and think of improvement strategies. There is also end of level/ cycle assessment in form of national examinations.

1.1.4 Students' learning styles and strategies to conduct teaching and learning process

There are different teaching styles and techniques that should be catered for. The selection of teaching method should be done with the greatest care and some of the factors to be considered are: the uniqueness of subjects; the type of lessons; the particular learning objectives to be achieved; the allocated time to achieve the objective; instructional available materials; the physical/sitting arrangement of the classroom, individual students' needs, abilities and learning styles.

There are mainly four different learning styles as explained below:

a) Active and reflective learners

Active learners tend to retain and understand information best by doing something active with it, discussing or applying it or explaining it to others. Reflective learners prefer to think about it quietly first.

b) Sensing and intuitive learners

Sensing learners tend to like learning facts; intuitive learners often prefer discovering possibilities and relationships. Sensors often like solving problems by well-established methods and dislike complications and surprises; intuitive learners like innovation and dislike repetition.

c) Visual and verbal learners

Visual learners remember best what they see—pictures, diagrams, flow charts, time lines, films, demonstrations, etc.; verbal learners get more out of words—written and spoken explanations.

d) Sequential and global learners

Sequential learners tend to gain understanding in linear steps, with each step following logically from the previous one. Global learners tend to learn in large jumps, absorbing material almost randomly without seeing connections, and then suddenly “getting it.”

1.1.5 Teaching methods and techniques that promote the active learning

The different student learning styles mentioned above can be catered for, if the teacher uses active learning whereby learners are really engaged in the learning process.

What is Active learning?

Active learning is a pedagogical approach that engages students in doing things and thinking about the things they are doing. In active learning, learners are encouraged to bring their own experience and knowledge into the learning process.

The role of the teacher in active learning

- The teacher engages learners through active learning methods such as inquiry methods, group discussions, research, investigative activities and group and individual work activities.
- He/she encourages individual, peer and group evaluation of the work done in the classroom and uses appropriate competence-based assessment approaches and methods.
- He provides supervised opportunities for learners to develop different competences by giving tasks which enhance critical thinking, problem solving, research, creativity and innovation, communication and cooperation.
- Teacher supports and facilitates the learning process by valuing learners' contributions in the class activities.

The role of learners in active learning

Learners are key in the active learning process. They are not empty vessels to fill but people with ideas, capacity and skills to build on for effective learning. A learner engaged in active learning:

- Communicates and shares relevant information with other learners through presentations, discussions, group work and other learner-centred activities (role play, case studies, project work, research and investigation)
- Actively participates and takes responsibility for their own learning
- Develops knowledge and skills in active ways
- Carries out research/investigation by consulting print/online documents and resourceful people, and presents their findings
- Ensures the effective contribution of each group member in assigned tasks through clear explanation and arguments, critical thinking, responsibility and confidence in public speaking
- Draws conclusions based on the findings from the learning activities.

Some active techniques that can be used in Chemistry

The teaching methods strongly emphasised in the competence Based Curriculum (CBC) are active methods. Below are some active techniques that apply in sciences:

- **Practical work/ experiments:**

Many of the activities suggested in the chemistry curriculum as well as in the student's book are practical work or experiments.

Practical work is vital in learning chemistry; this method gives the learner the opportunity to implement a series of activities and leads to the development of both cognitive and hands-on skills. The experiments and questions given should target the development of the following skills in students: observation; recording and report writing; manipulation; measuring; planning & designing.

A practical lesson/Experiment is done in three main stages:

- **Preparation:** Checking materials to ensure they are available and at good state; try the experiment before the lesson; think of safety rules and give instructions to lab technician if you have any.
- **Performance:** sitting or standing arrangement of students; introduction of the experiment: aims and objectives; setting up the apparatus; performing the experiment; write and record the data.
- **Discussion:** observations and interpreting data; make generalisations and assignment: writing out the experiment report and further practice and research.

In some cases, demonstration by the teacher is recommended when for example the experiment requires the use of sophisticated materials or very expensive materials or when safety is a major factor like dangerous experiments and it needs specific skills to be learnt first.

In case your school does not have enough laboratory materials and chemicals, experiments can be done in groups but make sure every student participates. In case your school does not have materials make arrangements with the neighbouring science school of excellence and take your students there for a number of experiments.

Research work

Each learner or group of learners is given a research topic. They have to gather information from internet, available books in the library or ask experienced people and then the results are presented in verbal or written form and discussed in class.

- **Project work**

Chemistry teachers are encouraged to sample and prepare project works and engage their students in, as many as possible. Learners in groups or individually, are engaged in a self-directed work for an extended period of time to investigate and respond to a complex question, problem, or challenge. The work can be presented to classmates or other people beyond the school. Projects are based on real-world problems that capture learners' interest. This technique develops higher order thinking as the learners acquire and apply new knowledge in a problem-solving context.

• **Field trip**

One of the main aims of teaching chemistry in Rwanda is to apply its knowledge for development. To achieve this aim we need to show to students the relationship between classroom chemistry lessons and applied chemistry. This helps them see the link between chemical principles and technological applications.

To be successful, the field visit should be well prepared and well exploited after the visit:

Before the visit the teacher and learners:

- agree on aims and objectives
- gather relevant information prior to visit
- brainstorm on key questions and share responsibilities
- discuss materials needed and other logistical and administrative issues ;
- discuss and agree on accepted behaviours during the visit
- Visit the area before the trip if possible to familiarise yourself with the place

After the visit

When students come back from trip, the teacher should plan for follow-up. The follow-up should allow students to share experiences and relate them to the prior chemistry knowledge. This can be done in several ways; either: Students write a report individually or in groups and give to the teacher for marking. The teacher then arranges for discussion to explain possible misconceptions and fill gaps. Or: Students write reports in groups and display them on the class notice board for everyone to read.

Main steps for a lesson in active learning approach

All the principles and characteristics of the active learning process highlighted above are reflected in steps of a lesson as displayed below. Generally the lesson is divided into three main parts whereby each one is divided into smaller steps to make sure that learners are involved in the learning process. Below are those main part and their small steps:

1) Introduction

Introduction is a part where the teacher makes connection between the current and previous lesson through appropriate technique. The teacher opens short discussions to encourage learners to think about the previous learning experience and connect it with the current instructional objective. The teacher reviews the prior knowledge, skills and attitudes which have a link with the new concepts to create good foundation and logical sequencings.

2) Development of the new lesson

The development of a lesson that introduces a new concept will go through the following small steps: discovery activities, presentation of learners' findings, exploitation, synthesis/summary and exercises/application activities, explained below:

- **Discovery activity**

Step 1

- The teacher discusses convincingly with students to take responsibility of their learning
- He/she distributes the task/activity and gives instructions related to the tasks (working in groups, pairs, or individual to instigate collaborative learning, to discover knowledge to be learned)

Step 2

- The teacher let the students work collaboratively on the task.
- During this period the teacher refrains to intervene directly on the knowledge
- He/she then monitors how the students are progressing towards the knowledge to be learned and boost those who are still behind (but without communicating to them the knowledge).

- **Presentation of learners' productions**

- In this episode, the teacher invites representatives of groups to presents the students' productions/findings.
- After three/four or an acceptable number of presentations, the teacher decides to engage the class into exploitation of the students' productions.

- **Exploitation of learner's productions**

- The teacher asks the students to evaluate the productions: which ones are correct, incomplete or false
- Then the teacher judges the logic of the students' products, corrects those which are false, completes those which are incomplete, and confirms those which correct.

- **Institutionalization (summary/conclusion/ and examples)**

- The teacher summarises the learned knowledge and gives examples which illustrate the learned content.

- **Exercises/Application activities**

- Exercises of applying processes and products/objects related to learned unit/sub-unit
- Exercises in real life contexts
- Teacher guides learners to make the connection of what they learnt to real life situations. At this level, the role of teacher is to monitor the fixation of process and product/object being learned.

3) Assessment

In this step the teacher asks some questions to assess achievement of instructional objective. During assessment activity, learners work individually on the task/activity. The teacher avoids intervening directly. In fact, results from this assessment inform the teacher on next steps for the whole class and individuals. In some cases the teacher can end with a homework assignment.

PART II: SAMPLE LESSON PLAN

School Name: Teacher's name:

Term	Date	Subject	Class	Unit No	Lesson No	Duration	Class size
II	... /.../2018	Chemistry	S5	5	9 of 14	40	45
Type of Special Educational Needs to be catered for in this lesson and number of learners in each category				None			
Unit title		Alcohols and ethers					
Key unit competency:		Compare the physical and chemical properties of alcohols and ethers to their preparation methods, reactivity and uses.					
Title of the lesson		Uses of alcohols					
Instructional Objective		Provided with textbooks, learners will be able to explain clearly the uses and dangers of alcohols in our society.					
Plan for this Class (location: in / outside)		Classroom					
Learning Materials (for ALL learners)		Textbooks, blackboard, chalks and internet.					
References		E.N.Ramsden (2000), A_level CHEMISTRY, FOURTH EDITION, Nelson Thornes					

Timing for each step	Description of teaching and learning activity		Generic competences and cross cutting issues to be addressed + a short explanation
	Teacher activities	Learner activities	
Introduction 5 min	Through group discussions, research using textbooks and or internet, learners explain different uses of alcohols and point out their dangers in our everyday life.		Cooperation and communication skills developed through group discussions.
	The teacher asks students to discuss in groups of four the chemical properties of alcohols.	In groups learners discuss within five minutes on the mechanism of the reaction between propan-2-ol and sulphuric acid at about 170°C.	

Development of the lesson			
<p>2.1 Discovery activity</p> <p>10 min</p>	<p>The teacher distributes the tasks and gives instructions related to the tasks (working in groups of 4 learners).</p> <p>Lets the learners work collaboratively on the tasks and monitors how performing their tasks.</p>	<p>In groups, learners follow the teacher’s instructions and from the scenario:</p> <p>a) Analyse the consequences of the misuse of alcohol in terms of human health, people cohesion and economy.</p> <p>b) Discuss the uses of alcohols as drinks, solvents and motor fuels.</p>	<p>Generic competences</p> <p>Cooperation and communication skills through discussions</p> <p>Lifelong learning by developing research culture</p> <p>Cross-cutting issues</p> <p>Financial education through consuming limited amounts of alcohols and paying taxes</p> <p>Environment and sustainability through using alcohols as fuels.</p> <p>- Peace and values education; Cooperation , mutual respect, tolerance through discussions with people with different views</p> <p>- Sharing during discussions and ceremonies using alcohols as drink</p>

<p>2.2 Presentation of learner's productions</p> <p>10 min</p>	<p>Teachers invites representatives of groups to present their findings</p> <p>The teacher encourage learners to make attention on presentation</p> <p>Teacher takes notes on key points from learners presentation.</p>	<p>Learners present their findings:</p> <p>Expected answers:</p> <ul style="list-style-type: none"> - misuses of alcohols increases blood pressure - vomiting and diarrhea - lack of school fees for children - alcohol may increase of criminal problems, traffic accidents or violence - reducing of productivity 	<p>Generic competences</p> <ul style="list-style-type: none"> - Cooperation and communication/ attentive listening during presentations and group discussions
<p>2.3 Exploitation</p>	<p>The teacher asks the learners to evaluate their findings and then judge the logic of the learners' production, corrects those which are false, completes those which are incomplete and confirms those which correct.</p>	<p>Each group evaluates the findings of other groups.</p>	<p>Generic competences</p> <ul style="list-style-type: none"> - Cooperation and communication skills through discussions - Critical thinking through evaluating other's ideas/ findings.

<p>2.4.Conclusion/ Summary</p>	<p>Teacher gives the summary of expected feedback based on the findings of learners.</p>	<p>Learners write the summary on their notes books:</p> <p>a)</p> <ul style="list-style-type: none"> - Heavy drinkers may suffer related economic problems such as lower wages and lost employment opportunities, increased medical and legal expenses. - Alcohol plays a role in a substantial number of domestic violence incidents - Misuses of alcohols increases blood pressure <p>b) Alcohol is used as solvents in marker pens, medecines and perfumes.</p> <ul style="list-style-type: none"> - Ethanol is the alcohol found in alcoholic drinks such as wine and beer. - Methanol, ethan- nol, and propanol are highly flamma- ble, making them as useful as fuels. 	<p>Cross-cutting issues</p> <ul style="list-style-type: none"> - Environment and sus- tainability through using alcohols as fuels.
---------------------------------------	--	---	--

Assessment 5 minutes	Teacher assesses the learned content.	Learners answer to the question; discuss the disadvantages of consuming alcoholic drinks for people who are under 18 years.	
Observation on lesson delivery	The lesson is well delivered.		
<p>Case study/scenario: <i>Kanyeshyamba is a man who has a wife and six children. He likes so much beer that he spends almost all his wages to buy alcoholic drinks. His family cannot get enough food. Moreover, this man cannot buy school supplies and pay school fees for their children. He himself has got tuberculosis and can get adequate treatment because he never saved for it. Worse still, he almost always in a fight with his wife who cannot stand such behaviour.</i></p>			

PART III: UNIT DEVELOPMENT

1.1 Key unit competency

Apply IUPAC rules to name organic compounds and explain types of isomers for organic compounds

1.2 Prerequisites (knowledge, skills, attitudes and values)

Students will learn better the introduction to organic chemistry if they have understanding on: The symbols of elements and their valencies, concepts of mole, chemical bonding and particularly molecular structures. The teacher will help learners to recap the concepts above.

1.3 Cross-cutting issues to be addressed

a) Inclusive education:

- This unit involves a number of formulae on organic compounds, the writing of formulae. This may be challenging to students with special educational needs especially students with visual impairment or visual difficulties. However, the teacher can make some arrangements like:
- **Grouping students.** Students with special educational needs are grouped with others and assigned roles basing on individual student's abilities.
- If a teacher has students with visual difficulties, when writing on the blackboard, write in large, clear writing, especially when it comes to formulae. Read out what you are writing, for the benefit of those who are not able to see the blackboard clearly.
- If learners are sharing textbooks, try to arrange for those with visual difficulties to have their own copies, as far as this is possible.
- Give extra time for them to write summary notes or write down observations after experiments.
- Every important point is written and spoken.
- Remember to repeat the main points of the lessons.
- For students with visual impairment teacher can write of them a summary

using the Braille alphabet if possible.

- For learners with **hearing difficulties**, the teacher has to encourage them to sit closer to the front of the classroom. Stop every so often while teaching to ask learners whether they have understood, or if they need you to repeat a point. Encourage learners not to be afraid to ask questions. When teaching, speak clearly and ensure that all the learners can hear your voice. Avoid speaking hurriedly as this will make it difficult for learners with hearing difficulties to make sense of what you are saying.
- **Learners with mobility difficulties:**
 - These include learners in crutches, wheelchairs, or with walking difficulties. Encourage other learners to look out for and help their classmates. Ask their fellow learners to help them with their notes, if their conditions hinder them from writing well.
- **Learners with reading difficulties:**
 - Learners with this kind of difficulties struggle to make sense of words or understand written work and take longer to read than other learners. Encourage them to pay careful attention during class time and participate for example by asking questions, answering questions, so that they can make the most of what they hear and observe. Instead of repeating word for word what is in the textbook, simplify the concepts to ease their understanding, so that when they have already understood.

b) Gender:

During group activities try to form heterogeneous groups (with boys and girls) or when students start to present their findings encourage both (boys and girls) to present.

c) Financial education:

As the unit deals with the importance of organic chemistry in daily life, the teacher will draw the learners' attention on the economical impact of the making of common items made using knowledge of chemistry.

d) Peace and values education:

During group activities, the teacher will encourage learners to help each other and to respect opinions of colleagues.

1. 4. Guidance on the introductory activity

- For this activity, the teacher forms groups of five students that are as heterogeneous as possible.
- He/she lets them to perform experiments described in the activity 1.1 in the student book.
- The teacher makes sure that each student from each group performs at least one experiment.
- The teacher provides a clear sheet for reporting. On this, there is among others the title of experiment, the observations and deductions.
- The teacher asks randomly representative of two or three groups to present their findings.
- After presentation, the teacher decides to engage the class into exploitation of the students' findings.
- After presentation the teacher asks the students to judge findings from different groups and harmonise their work.
- The teacher summarises their findings and introduces the new unit

Answers to the introductory activity

- sodium chloride: it melts and finally evaporates
 - starch : formation of black residue
 - table sugar: formation of black residue
 - magnesium carbonate: formation a white powder
 - glucose: formation of black residue
 - sodium hydrogen carbonate: formation of white powder
 - water: complete evaporation into vapours
- 3- 4: There are two sets of substances:
- Substances forming black residue on heating
 - substances forming forming white powder or evaporate
5. Those substances forming black residues are organic while those with white powder and those evaporating are inorganic

1.5. List of lessons

#	Lesson title	Learning objectives	Number of periods
1	Classification of organic compounds	Classify organic compounds as aliphatic, alicyclic and aromatic	1
2	Types of formulae for organic compounds	Determine different formulae for given organic compounds	1
3	Functional groups and homologous series	Describe the common functional groups and relate them to the homologous series	1
4	General rules of nomenclature of organic compounds according to IUPAC system	Use IUPAC rules to name different organic compounds	1
5	Isomerism in organic compounds	Describe the isomers of organic compounds	2
6	Summative assessment	Apply IUPAC rules to name organic compounds and explain the types of isomers for organic compounds	1

1.6 Guidance on different lessons

Lesson 1: Classification of organic compounds (40 minutes)

This is the first lesson of unit 1 and is a single lesson. That is to say it has only one period (40 minutes). The first lesson also covers the introduction of the whole unit.

a. Prerequisites (10 minutes)

Students will learn better the classification of organic compounds if they have understanding on the concept of bonding, valencies of elements and electronic configuration of at least the first 20 elements.

b. Teaching resources

Use the atomic models or draw the compounds to be classified on a manila paper.





c. Learning activities

Before introducing the lesson, you will have to introduce the whole unit. Let learners therefore attempt activity 1.1 first then 1.2 which leads students to the first lesson of the unit.

Methodological steps

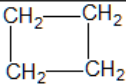
As a facilitator, the teacher is expected to guide learners through the following steps:

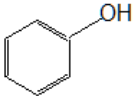
Activity 1.1: Expected answers

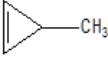
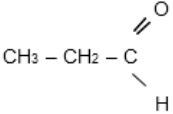
Aliphatic	Alicyclic	Aromatic
$\text{CH}_3\text{-CH}_2\text{-CH}_2\text{-CH}_2\text{-CH}_2\text{-CH}_3$,		 , 
$\text{CH}_3\text{-CH}_2\text{-CH=CH}_2$,	 	
$\begin{array}{c} \text{CH}_3 - \text{CH} - \text{CH} - \text{CH}_3 \\ \quad \\ \text{CH}_3 \quad \text{CH}_3 \end{array}$		
$\text{CH}_3 - \text{CH}_2 - \text{C} \equiv \text{C} - \text{H}$		
		

Make a summary of the lesson (short notes) and assess your lesson, let students do checking up 1.1.

Answers to checking up 1. 1

Aliphatic	Alicyclic	Aromatic
a), b), e), g)	c), d)	f), h)

Lesson 2: Types of formulae for organic compounds (40 minutes)

a. Prerequisites

Students will learn better the types of formulae for organic compounds if they have understanding on: Mole concept (chemistry S₂ unit 7), Covalent bonding and molecular structures (chemistry S₄ unit 4).

b. Teaching resources

Use atomic models to show structures of molecules or draw them on a manila paper or flip charts.

c. Learning activities:(25minutes)

Before introducing the lesson, let learners therefore attempt activity 1.3 which leads students to the second lesson of the unit

Activity 1.2

- This activity introduces students to know different types of formulae for organic compounds.
- Divide your class into groups of five students and let students follow the working procedures to obtain the results.
- Let the learners perform the activity using their prior knowledge about types of formulae as they have studied in S₂ unit 7.
- Have sample group present their work to the class.
- Check learners' responses to review the learners' plans and ideas to continue the discussion with a brief brainstorming of the concepts using learners' work and book.
- Comment on students' responses written in their note books, and give them the summary of expected feedback based on their findings.

Answers to activity 1.2

See student book

Assess the lesson by letting learners to do checking up 1.2 (15minutes)

Answers to checking up 1. 2

1) a)

Element	C	H	O
% composition	80	6.7	100-(80+6.7)= 13,3
Relative mole ratio	$\frac{80}{12} = 6.66$	$\frac{6.7}{1} = 6.7$	$\frac{13.3}{16} = 0.83$
Atomic ratio	$\frac{6.66}{0.83} = 8.03$	$\frac{6.7}{0.83} = 8.07$	$\frac{0.83}{0.83} = 1.00$
Empirical formula	C ₈ H ₈		

$$b) n = \frac{\text{molecular mass}}{\text{empirical mass}} = \frac{120}{120} = 1$$

Thus, empirical formula = molecular formula, C₈H₈O

$$2. a) \text{ Percentage of carbon in carbon dioxide} = \frac{12}{44} \times \frac{17.8}{7.5} \times 100 = 64.73\%$$

$$\text{Percentage of hydrogen in water} = \frac{2}{18} \times \frac{9.27}{7.5} \times 100 = 13.73\%$$



$$\text{Percentage of oxygen} = 100 - (64.73 + 13.73) = 21.54\%$$

Element	C	H	O
percentage	64.73	13.73	21.54
Relative number of atoms	$\frac{64.73}{12} = 5.39$	$\frac{13.73}{1} = 13.73$	$\frac{21.54}{16} = 1.35$
Atomic ratio	$\frac{5.39}{1.35} = 4$	$\frac{13.73}{1.35} = 10$	$\frac{1.35}{1.35} = 1$
Empirical formula	C ₄ H ₁₀ O		

$$n = \frac{\text{molecular mass}}{\text{empirical mass}} = \frac{74}{74} = 1$$

Thus, molecular formula = empirical formula = C₄H₁₀O

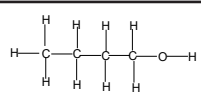
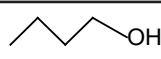
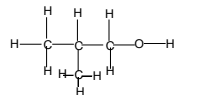
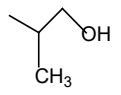
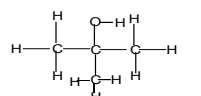
b) Possible structural formulae

Condensed	Displayed	Skeletal
$\text{CH}_3\text{-CH}_2\text{-CH}_2\text{-CH}_2\text{-OH}$		
$\text{CH}_3\text{-CH(CH}_3\text{)-CH}_2\text{-OH}$		
$\text{CH}_3\text{C(CH}_3\text{)(OH)CH}_3$		

Lesson 3: Functional groups and homologous series (40 minutes)

a. Prerequisites (10 minutes)

Students will learn better the types of formulae for organic compounds if they have understanding on: Covalent bonding and molecular structures (chemistry S4 unit 4).

b. Teaching resources

Use atomic models to show functional groups or draw them on a manila paper or flip charts.

c. Learning activities

This is the time for introducing the lesson three, before introducing it, let learners therefore attempt activity 1.4 which leads to the third lesson of the unit.

Activity 1.3.1: (20 minutes)

- This activity introduces students to know the atmosphere and its composition
- Divide your class into groups, and let students follow the working procedures to obtain the results.
- Let the learner(s) perform the activity using their prior knowledge about molecular structures and write the ideas in the note book.
- Have sample group present their work to the class.
- Check student's responses to review the students' plans and ideas to continue the discussion with a brief brainstorming of the concepts using student's work and book.

- Comment on students' responses written in their notebooks, and give them the summary of expected feedback based on their findings.

Expected answers to the activity 1.3: See student book

Activity 1.3.2:

The guidance for this activity see that of activity 1.3.1 above

Expected answers: See student book

Answers to checking up 1. 3 (10minutes)

Functional group: atom or group of atoms in a molecule which determines the characteristic properties of that molecule.

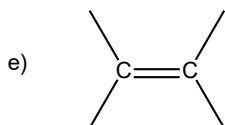
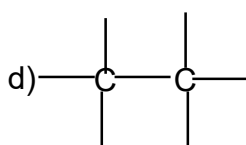
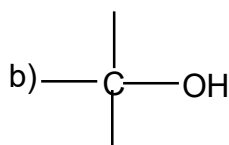
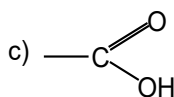
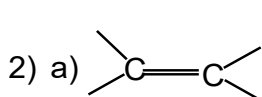

3) Compound e) has higher boiling point because of increasing in molecular mass which causes increase in Van der waals forces.

Lesson 4: General rules of nomenclature of organic compounds according to IUPAC (40min)

a. Prerequisites (10 minutes)

Students will learn better the types of formulae for organic compounds if they have understanding on: Covalent bonding and molecular structures (chemistry S₄ unit 4), alkanes (chemistry S₂ unit 10), functional groups and homologous series (chemistry S₅ unit 1)

b. Teaching resources

Use books especially books of organic chemistry, flip charts and chalkboard.

c. Learning activities

Before introducing the lesson, let learners attempt activity 1.6 which leads learners to

the lesson four.

As a facilitator, you are expected to guide learners through the following steps:

Activity 1.4: (20 minutes)

- This activity introduces students to know different rules of nomenclature of organic compounds according to IUPAC system.
- Brainstorm with your students if they have any information of prior knowledge of homologous series and nomenclature of alkanes as they have studied in senior two unit 10 before doing the activity 1.6.
- Your discussions should include different views about homologous series and nomenclature of alkanes up to C_4 as they have seen in S_2 unit 10.
- Let learners perform activity in **pairs** using their prior knowledge and write their ideas on sheet.
- Have sample group present their work to the class.
- Checking students' responses to review the students' plans and ideas to continue the discussions with a brief brainstorming of the concepts using students' work and book.
- Comment on students' responses and give them the summary of expected feedback based on their findings.

Expected answers for activity 1.4: see student book.

Assess the lesson by letting learners to do checking up 1.5

Answers of checking up 1. 4 (10minutes)

1. International Union of Pure and Applied Chemistry (IUPAC)

1. Prefix, root, suffix

3. a) 2,3-dimethylpentane

b) n-decane

c) 6-ethyl-2,2,4-trimethylnonane

d) 2-methylbutanal

Lesson 5: Isomerism in organic compounds (80 minutes)

a. Prerequisites (10 minutes)

Students will learn better the types of formulae for organic compounds if they have understanding on:

- Covalent bonding and molecular structures (chemistry S₄ unit 4),
- Alkanes (chemistry S₂ unit 10),
- Functional groups and homologous series (chemistry S₅ unit 1),
- General rules of nomenclature of organic compounds according to IUPAC system (chemistry S₅ unit 1)

b. Teaching resources

Atomic models, books, flipcharts, blackboard

c. Learning activities

Before introducing the lesson, let learners attempt activity 1.7 which leads learners to the lesson five.

As a facilitator, you are expected to guide learners through the following steps:

Activity 1.5: (20 minutes)

- Divide your class into groups, and let students follow the working procedures to obtain the results.
- Let the learner(s) perform the activity using their prior knowledge about functional groups and homologous series, general rules of nomenclature of organic compounds according to IUPAC system and write their ideas on the answer sheet.
- Have sample group present their work to the class.
- Check student's responses to review the students' plans and ideas to continue the discussion with a brief brainstorming of the concepts using student's work and book.
- Comment on students' responses written in their notebooks, and give them the summary of expected feedback based on their findings.

Expected answers on the activity 1.5:

1. Compounds b) and n)

2. (i) b), g), j), n)

(ii) a), o), p)

(iii) e) and l)

(iv) f) and i)

3. a) (i) a), o), p)
(ii) e) and l)
(iii) b) and g)
(iv) f) and i)
- b) (i) a), o) and p) have different arrangements of atoms
(ii) e) and l) differ in spatial arrangement of the groups around the double bond
(iii) b) and g) have different positions of the OH group
(iv) f) and i) have different functional groups
- c) (i) a), o), p) are chain isomers
(ii) e) and l) are geometrical isomers
(iii) b) and g) are position isomers
(iv) f) and i) are functional isomers
4. They behave differently because isomers have different physical and chemical properties.

Activity 1.5.1: (10minutes)

For guidance on this activity see the guidance on activity 1.7.

Expected answers on activity 1.5.1

1. Chain isomers
2. Position isomers
3. Functional isomers
4. Ring isomers

Activity 1.5.2: (10 minutes)

Guidance on this activity see that of activity 1.7.

Expected answer on activity 1.5.2:

1. They are geometrical isomers
2. Cis and trans-hex-3-ene

Activity 1.5.3:(10minutes)

Guidance on this activity see that of activity 1.5

Expected answers on activity 1.5.3:

1. They are mirror images of one another
2. Presence of an unsymmetric carbon atom
1. They are enantiomers

Answers to checking up 1.5: (20minutes)

1. Isomers are compounds with the same molecular formula but different arrangements of atoms.
2. Structural isomers are compounds with the same molecular formula but different structural formulae. Stereoisomers are compounds with the same molecular formula but different spatial arrangement of some atoms. For the examples and the description of the sub-classes of isomers, see student book.
3. The rotation around the carbon-carbon double is restricted and therefore, substituents attached to the carbon atoms doubly bonded occupy fixed positions.
4. Hex-2-ene and hex-3-ene.
5. Compound c) because it contains an asymmetrical carbon atoms.
6. Shoes, gloves,

1.7. Summary of the unit

Organic chemistry **is** the study of the structure and properties of carbon containing compounds.

Organic compounds are classified as aliphatic, alicyclic and aromatic. They may be represented by molecular or structural formulae. Structural formulae may be displayed, condensed or skeletal.

Organic compounds exhibit isomerism. **Isomerism** is the existence of compounds with the same molecular formula but different arrangement of atoms. Such compounds are referred as **isomers**.

There two main types of isomers: structural isomers and stereoisomers.

A functional group is an atom or group of atoms which dictates the chemical behaviour of an organic compound.

A homologous series is a group of organic compounds having the same functional group.

Organic compounds are named following rules set by the International Union of Pure and Applied Chemistry. A name of an organic compound consists of three parts: a prefix that shows the nature and numbers of substituents, a root which indicate the size of the major chain and a suffix that indicate the homologous series.

1.8. End unit assessment

Standard of performance: Correctly classify organic compounds as aliphatic, alicyclic and aromatic and apply IUPAC rules to name organic compounds and explain the types of isomers for organic compounds.

Answers to questions of end unit assessment

10 a) functional group

b) homologous series

c) optically active

2) True

3) False

4) B

5) C

6) B

7)

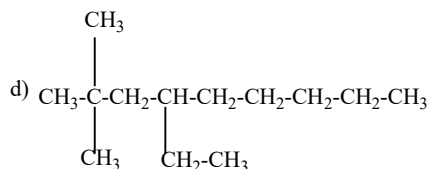
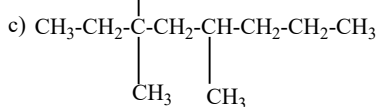
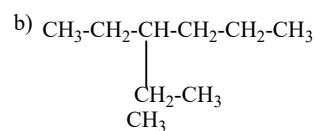
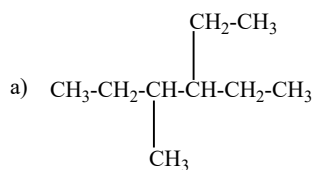

8)

Element	C	H	O
%composition	64.86	13.51	21.62

b)

Element	C	H	O
percentage	64.73	13.73	21.54
Relative number of atoms	$\frac{64.73}{12} = 5.39$	$\frac{13.73}{1} = 13.73$	$\frac{21.54}{16} = 1.35$
Atomic ratio	$\frac{5.39}{1.35} = 4$	$\frac{13.73}{1.35} = 10$	$\frac{1.35}{1.35} = 1$
Empirical formula	C ₄ H ₁₀ O		

C) $M_m = 48 + 10 + 16 = 74g$

$$n = \frac{\text{molecular weight}}{\text{empirical weight}} = \frac{74}{74} = 1$$

Thus, molecular formula = empirical formula = C₄H₁₀O

d)

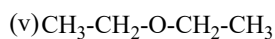
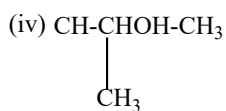
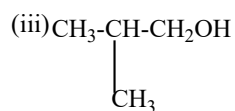
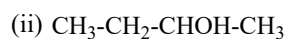
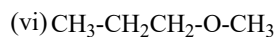
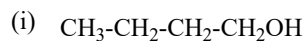

e) Name the isomers in d) according to the IUPAC system.

i) Butan-1-ol

ii) Butan-2-ol

iii) 2-methylpropan-1-ol

iv) 2-methylpropan-2-ol

v) Diethylether

vi) methoxypropane

f) (i) From the results in d) classify the isomers as chain, position, functional and optical isomers.

Compounds (i) and (ii), (v) and (vi) are position isomers

Compounds (i) and (ii); (ii) and (iv), are chain isomers

Compounds (i) and (v) or (vi) are functional isomers

(ii) Compound (ii) can exhibit optical isomerism.

1.9. Additional activities

1.9.1. Remedial Activities

1) Say which of the following structures may show optical isomerism?

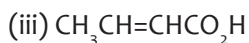
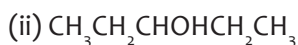
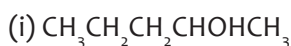

Answer: The structure which may show optical isomerism is (i), $\text{CH}_3\text{CH}_2\text{CH}_2\text{CHOHCH}_3$ because it contains asymmetric carbon.

2) Name the following compounds according to IUPAC system.

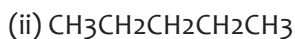

Answer: (i) Butan-2-ol



3) By giving 2 examples, explain the term homologous series.

Answer: A homologous series is a series of organic compounds with the same functional group but with each successive member differing by $-\text{CH}_2-$

Examples: (i) for alkanes:

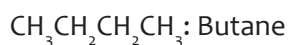
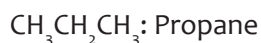
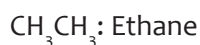

(ii) for alcohols:

$\text{CH}_3\text{CH}_2\text{OH}$: Ethanol

$\text{CH}_3\text{CH}_2\text{CH}_2\text{OH}$: Propan-1-ol

$\text{CH}_3\text{CH}_2\text{CH}_2\text{CH}_2\text{OH}$: Butan-1-ol

1.9.2. Consolidation activities

1) Give the names according to IUPAC of all possible isomers of C_6H_{14} .

Answer: (i) n-Hexane

(ii) 2-Methylpentane

(iii) 3-Methylpentane

(iv) 2,2-Dimethylbutane

(v) 2,3-Dimethylbutane

2) Write structural formulae for:

(i) Heptane

(ii) 2-Chloro-3-iodohexane

(iii) Hex-2-ene

(iv) Pentan-2-ol

Answer: (i) $\text{CH}_3\text{CH}_2\text{CH}_2\text{CH}_2\text{CH}_2\text{CH}_2\text{CH}_3$

(ii) $\text{CH}_3\text{CHClCHICH}_2\text{CH}_2\text{CH}_3$

(iii) $\text{CH}_3\text{CH}=\text{CHCH}_2\text{CH}_2\text{CH}_3$

(iv) $\text{CH}_3\text{CHOHCH}_2\text{CH}_2\text{CH}_3$

Extended activities

1. Name the following compounds:

(i) $\text{HC}\equiv\text{C}-\text{CH}_2-\text{CH}=\text{CH}_2$

(ii) $\text{CH}_2=\text{CH}-\text{C}\equiv\text{C}-\text{CO}-\text{CH}_3$

(iii) $\text{CF}_3-\text{CH}_2-\text{CH}=\text{CH}-\text{CHI}-\text{COOH}$

Answer:

(i) 1-Penten-4-yne

(ii) 5-Hexen-3-yn-2-one

(iv) 6,6,6-Trifluoro-2-iodo-3-pentenoic acid

2.1. Key unit competency

Relate the physical and chemical properties of the alkanes to the preparation methods, uses and isomerism.

2.2. Prerequisites

Students will learn better the introduction to organic chemistry if they have understanding on:

- The symbols of elements and their valencies,
- Chemical bonding and particularly molecular structures.
- Types of formulae of organic compounds.
- Isomerism
- Classification of organic compounds
- General rules of nomenclature of organic compounds according to IUPAC.
- The teacher will help learners to recap the concepts above.

2.3. Cross-cutting Issues to be addressed

a) Inclusive education:

This unit involves a number of formulae on organic compounds, the writing of formulae. This may be challenging to students with special educational needs especially students with visual impairment or visual difficulties. However, the teacher can make some arrangements like:

Grouping students. Students with special educational needs are grouped with others and assigned roles basing on individual student's abilities.

- If a teacher has students with visual difficulties, when writing on the blackboard, write in large, clear writing, especially when it comes to formulae. Read out what you are writing, for the benefit of those who are not able to see the blackboard clearly.
- If learners are sharing textbooks, try to arrange for those with visual difficulties to have their own copies, as far as this is possible.
- Give extra time for them to write summary notes or write down observations after experiments.
- Every important point is written and spoken.
- Remember to repeat the main points of the lessons.
- For students with visual impairment teacher can write of them a summary using the braille alphabet if possible.
- For learners with hearing difficulties, the teacher has to encourage them to sit closer to the front of the classroom. Stop every so often while teaching to ask learners whether they have understood, or if they need you to repeat a point. Encourage learners not to be afraid to ask questions. When teaching, speak clearly and ensure that all the learners can hear your voice. Avoid speaking hurriedly as this will make it difficult for learners with hearing difficulties to make sense of what you are saying.
- Learners with mobility difficulties: Encourage other learners to look out for and help their classmates. For example when working in the laboratory, ensure that they are able to participate, for example, making sure that they can reach the tables and other laboratory equipment comfortably.

b) Financial education:

As the unit deals with the importance of alkanes in modern life, the teacher will draw the learners' attention on the economical impact of the making of common useful substances made using knowledge of chemistry.

2.4. Guidance on the introductory activity

- The teacher forms groups of five students for each.
- He/she distributes the activity and gives instructions related to the tasks.
- The teacher lets the students work collaboratively on the activity.
- The teacher then monitors how the students are progressing towards the knowledge to be learned.
- The teacher invites representatives of groups to present the students' findings.

- The teacher decides to engage the class into exploitation of the students' findings.
- Then the teacher judges the logic of the students' findings, corrects those which are false, completes those which are incomplete, and confirms those which are correct. After these judgements, the teacher gives the short summary about the activity and gives the introduction of the new unit.

Proposed answers to introductory activity

The picture shows the factory and a lorry polluting environment by releasing large amount of gases in air. The people are sneezing and coughing due to that pollution

The source is that they have been combustion reactions in the reactors of the factory and the burning of fuel from the reservoir of the lorry, resulting in gases such as hydrocarbons (HC), Nitrogen oxides (NO_x), carbon monoxide (CO), Sulfur dioxide (SO₂), hazardous air pollutants (toxics),....

To avoid this problem, the factory may collect the gases and recycle them to obtain other useful products. People must use good quality fuel such as those without or with small amount of lead.

2.5. List of lessons

#	Lesson title	Learning objectives	Number of periods
1	Nomenclature of alkanes using IUPAC system and isomerism	-Name straight chain alkanes up to carbon-20 -Define homologous series -Use IUPAC system to name straight and branched alkanes	2
2	Preparation of alkanes	-Describe the preparation methods of the alkanes -Prepare and collect methane gas -Respect of procedure in experiment to carry out preparation of methane or propane	2
3	Physical properties of alkanes	-Describe and explain the trend in physical properties of homologous series of alkanes	1

4	Chemical properties	<ul style="list-style-type: none"> -Be aware of the dangers associated with combustion reactions of the alkanes -Write reaction for free radical mechanism for a photochemical reaction -State the chemical properties of the alkanes -Develop practical skills, interpret results and make appropriate deductions. 	2
5	Uses of alkanes	<ul style="list-style-type: none"> -Appreciate the importance of the alkanes in daily life -Appreciate the dangers caused by the alkanes to the environment as major sources of air contaminants -State the uses of the alkanes 	2
6	End unit assessment		1

2.6 Guidance on different lessons

LESSON 1: Nomenclature of alkanes using IUPAC system (80 minutes)

a) Prerequisites (10 minutes)

Students will learn better the nomenclature of alkanes using IUPAC system if they have understanding on:

- General rules of naming organic compounds using IUPAC system (S5unit 1)
- Covalent bonding and molecular structures (S4 unit 4)

b) Teaching resources

- Atomic models
- Manila papers
- blackboard

c) Learning activities

Before introducing the lesson one, let learners therefore attempt activity 2.1 which leads students to the first lesson of the unit.

Answers to checking up 2.1:(15 minutes)

1. Expected answer refers to student's book
2. a. n-octane
b. 5-ethyl-8-methyltridecane
c. 1-ethyl-4-propylcyclohexane
d. Butylcyclopentane
e. 6-isopropyl-8-sec-butyl-3-methyldodecane
f. 5-sec-butyl-3-methyloctane

Activity 2.2: (10minutes)

The guidance on this activity, see the guidance of activity 2.1 above

Expected answers on activity 2.2: See student book

Answers to checking up 2.2 (15minutes)

- 1) $\text{CH}_3\text{-CH}_2\text{-CH}_2\text{-CH}_2\text{-CH}_2\text{-CH}_2\text{-CH}_3$: n-Heptane
- 2) $\begin{array}{c} \text{CH}_3\text{-CH-CH}_2\text{-CH}_2\text{-CH}_2\text{-CH}_3 \\ | \\ \text{CH}_3 \end{array}$: 2-methylhexane
- 3) $\begin{array}{c} \text{CH}_3\text{-CH}_2\text{-CH-CH}_2\text{-CH}_2\text{-CH}_3 \\ | \\ \text{CH}_3 \end{array}$: 3-methylhexane
- 4) $\begin{array}{c} \text{CH}_3\text{-CH-CH-CH}_2\text{-CH}_3 \\ | \quad | \\ \text{CH}_3 \quad \text{CH}_3 \end{array}$: 2,3-Dimethylpentane
- 5) $\begin{array}{c} \text{CH}_3\text{-CH-CH}_2\text{-CH-CH}_3 \\ | \quad \quad | \\ \text{CH}_3 \quad \quad \text{CH}_3 \end{array}$: 2,4-Dimethylpentane

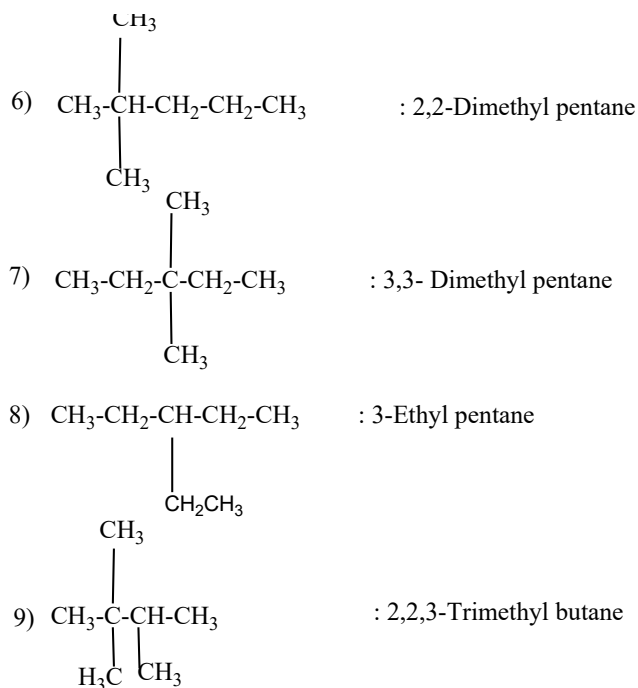

LESSON 2: Preparation of alkanes (80minutes)

a. Prerequisites (10minutes)

Students will learn better different methods of preparation of alkanes if they understanding on types of reactions (chemistry S2 unit 5)

b. Teaching resources

- Stand and accessories
- NaOH(s)
- Delivery tube
- Sodium acetate(s)
- Calcium oxide(s)

c) Learning activities

Before introducing the lesson two let learners perform the activity 2.3 which leads students to the second lesson of the unit. As facilitator the teacher is expected to guide learners through the following steps:

Activity 2.3: (10minutes)

Guidance on this activity, see the guidance on activity 2.1 above

Expected answers on activity 2.3: See student book

Answers on checking up 2.3:

See student book

Activity 2.4 (50minutes)

- Form groups of five students each.
- Provide and explain the procedure of experiment, and distribute all requirements needed to perform experiment (apparatus and chemicals).
- Monitor and verify how the setup is made by students.
- Let students perform the experiment.
- Schedule the presentation for sample and let them compare their findings.
- Help learners to comprehend their findings and give them summarised feedback

Expected answers on activity 2.4: See student book

Answers to checking up 2.4:

See student book

Lesson 3: Physical properties of alkanes (40minutes)

a. Prerequisites (10minutes)

Students will learn better the physical properties of alkanes if they have understanding on covalent bonding and molecular structures

b. Teaching resources

- Water
- Test tube
- Cyclohexane
- Heptane
- Ruler

c) Learning activities

Activity 2.5: (15minutes)

The guidance on this activity 2.5 is the same as that of activity 2.4

Expected answers on the activity 2.5

See student book

d) Answers on checking up 2.5: (15minutes)

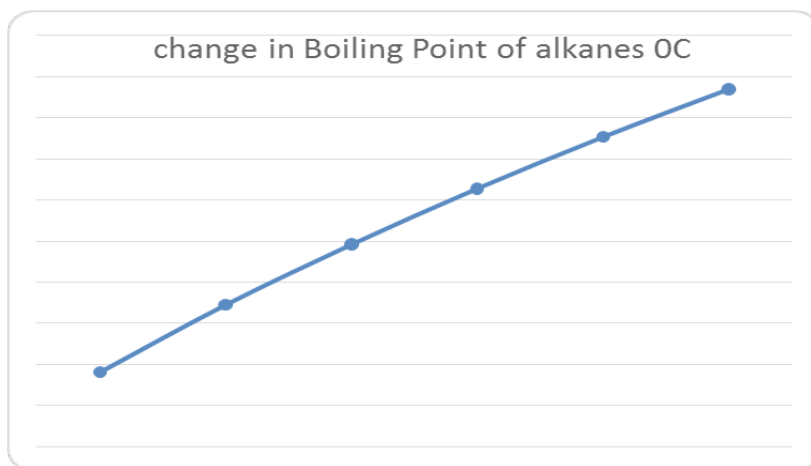
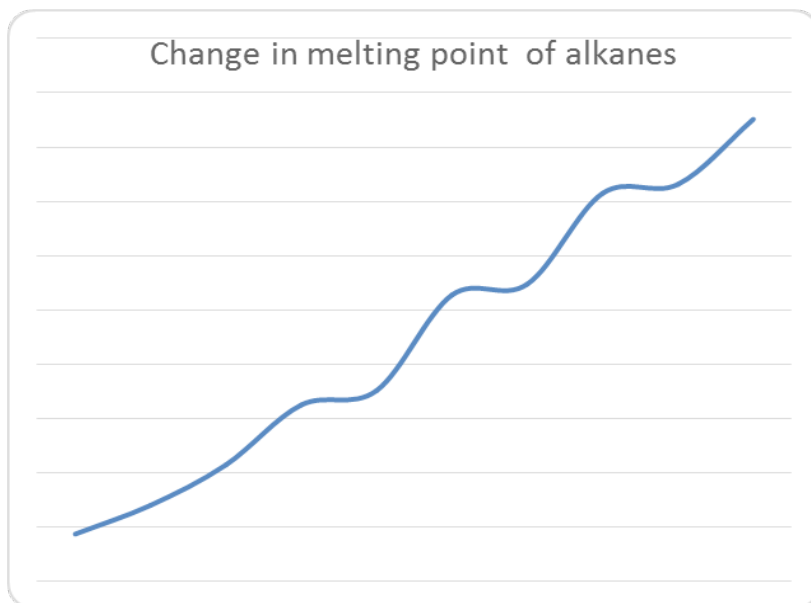

Lesson 4: Chemical properties of alkanes (80minutes)

a. Prerequisites (10minutes)

Students will learn better the chemical properties of alkanes, if they have understanding on types of reactions (chemistry S2 unit5)

b. Teaching resources

- Hexane
- Test tube
- KOH (aq)
- Bromine water
- Octane

c) Learning activities

As a facilitator, the teacher is expected to guide learners through the following steps:

Activity 2.6.1 (40minutes)

- Form groups of 4-5 students and explain to the students, instructions related to the task.
- Distribute the activity sheets and let students work collaboratively on the task.
- Monitor how the students are performing the task.
- Invite representatives of groups to present the students' findings.
- Decide to engage the class into exploitation of the students' findings.
- Ask students to evaluate the correct findings
- Judge the logic of the students' findings, correct those which are false, complete those which are incomplete, and confirm those which are correct
- Give the summary of expected feedback based on their findings.

Expected answers to activity 2.6.1

Reaction of	Evolution of a gas	Change in colour	Formation of a precipitate	Release of heat
Hexane with KOH	No	No	No	No
Hexane with bromine water	No	No	No	No
octane with KOH	No	No	No	No
Octane with bromine water	No	No	No	No
Activity 2.6.2 (15minutes) Expected answers to activity 2.6.2 See student book				

The guidance on this activity is the same as that of activity 2.6.1

d) Answers to checking up 2.6: (15minutes) See student book

Lesson 5: Uses of alkanes

Prerequisites

Students will learn better the uses of alkanes if they have understanding on their physical and chemical properties

Teaching resources

- Flipcharts and blackboard

c) Learning activities

Activity 2.7: The guidance on this activity see that of activity 2.6.1

Expected answers to activity 2.7:

See student book

2.7. Unit Summary

- Alkanes form the homologous series of general formula C_nH_{2n+2} .
- They show structural (chain, position), and in some cases optical, isomerism.
- They can be extracted from crude oil by fractional distillation.
- Alkanes are unreactive towards polar or ionic reagent. But, they react with reagents such as oxygen and halogens.
- The reaction with halogens follows a free radical mechanism. It is a free radical substitution.
- Alkane molecules break down to smaller molecules at high temperature or in the presence of a catalyst. The reaction called cracking. It is important the petrochemical industry.
- Their main use is as sources of energy by combustion; many of them are used as solvents.
- They react with chlorine and bromine in a free radical substitution reaction, giving chloro or bromoalkanes.
- There are three stages to a radical chain reaction: initiation, propagation and termination.

2.8. Additional Information for teachers

When alkyl magnesium bromide or iodides are treated with water, alcohol or amines, pure alkanes are formed.

i.e.

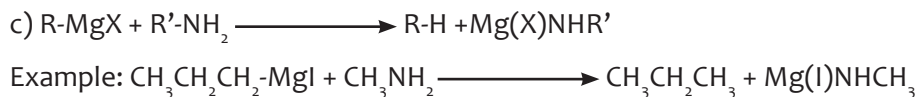
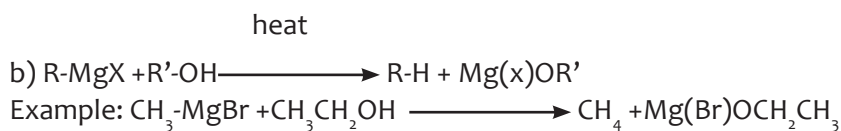
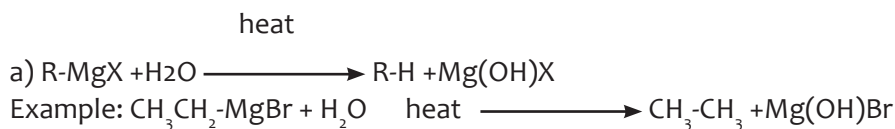

2.9. End Unit assessment

Standard of performance:

Articulate relate the physical and chemical properties of the alkanes to preparation methods, uses and isomerism.

Answers to end unit assessment questions

- C_nH_{2n+2}
- Answer the following questions by True or False
 - True
 - True
 - False
- Draw the structures of the following

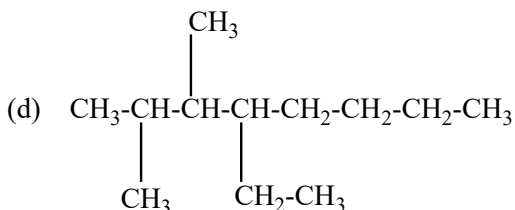
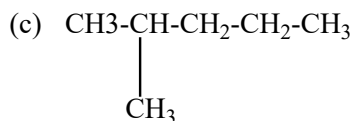
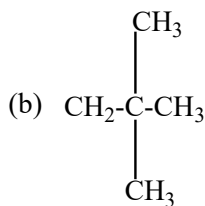
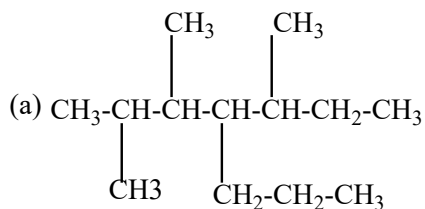

4. See student book

5. $C_nH_{2n+2} = 72$ $14n + 2 = 72$, Thus, $\frac{n=72-2}{14} = 5$

Possible structural formulae

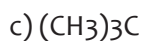
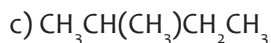
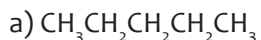

6. a) Hydrocarbon: organic compound that is made of carbon and hydrogen only.

b) The boiling point of a hydrocarbon increases with increasing number of carbon atoms.

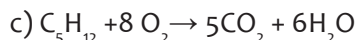

d) greenhouse effect

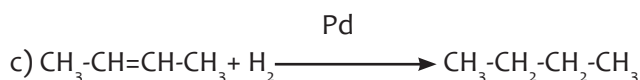
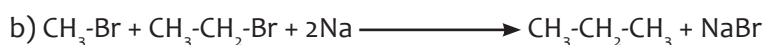
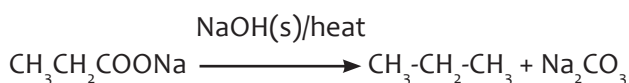
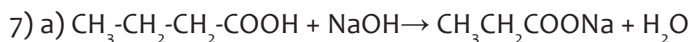

9. a) See student book

b) Methane is used as alternative fuel in heating and for the electricity generation.

It can be used as raw material for urea production.

2.10. Additional activities

A. Remedial activities

1) Explain the following terms:

a) Cracking

b) fractional distillation

Answers:

a) Cracking is the breaking down of long-chained saturated hydrocarbons to form a mixture of shorter-chained alkanes and alkenes.

b) Fractional distillation separates liquids from a mixture according to their different boiling points.

2) a) Write an equation for the combustion of hexane in a plentiful supply of oxygen.

b) Which different products would be formed if the supply of oxygen were limited.



c) If the supply of oxygen were limited, carbon monoxide (CO) would be produced instead of carbon dioxide.

B. Consolidation activities

1. Name three greenhouse gases. For each gas, state the bonds that absorb infrared radiation.

Answers: -**Carbon dioxide:** C=O bonds absorb infrared radiation.

-**Water vapour:** O-H bonds absorb infrared radiation.

-**Methane:** C-H bonds absorb infrared radiation

2) A deodorant contains a mixture of butane, 2-methylpropane and propane as propellant.

a) Suggest a property of these alkanes that makes them suitable as the propellant.

b) Why alkanes now being used as propellants in aerosol sprays?

Answers: a) Liquid under pressure but vaporise when pressure is released.

c) Alkanes have replaced CFCs which cause damage to the ozone layer.

C. Extended activities

1) a) What are the constituents of crude oil.

b) Describe how they are separated.

c) Briefly explain cracking and state its use in petroleum industry

Answers:

a) Gas, petrol, kerosene, diesel oil, lubricating oil.

b) Crude petroleum is first freed from solid impurities by filtration. It is then first heated in a separate furnace to about 400°C after which the hot liquid is then passed into a fractionating tower. As the hot mixture of gasses ascend the tower various vapours condense at different levels of the tower depending on their boiling points. These products are then separately tapped off.

c) Cracking is the process in the petroleum refinery where less volatile hydrocarbon of the kerosene or diesel fractions are converted to more volatile hydrocarbon (petrol) by application of heat. Cracking can be classified as thermal and catalytic. In thermal cracking the hydrocarbon fractions of long carbon chains (C₁₂-C₁₈) are broken down into shorter chains of petrol by heating to about 500°C under pressure of about 200 atmospheres.

3.1 Key unit competency

Relate the physical and chemical properties of alkenes and alkynes to their reactivity and uses

3.2 Prerequisite (knowledge, skills, attitudes and values)

Students will learn better the content related to alkenes and alkynes if they have understanding on: chemical bonding, (unit 4 senior 4) concepts isomerism (unit 1 senior 5) the nomenclature of organic compounds (unit 1 senior 5). The teacher will help learners to recap the concepts above.

Learners have the skills to use effectively the common laboratory apparatus and are aware of the safety precautions to take when working in a chemistry laboratory.

3.3 Cross-cutting issues to be addressed

a) Inclusive education

This unit involves a number of formulae on organic compounds and experiments. This may be challenging to students with special educational needs especially students with visual and physical impairment or visual difficulties. However, the teacher can make some arrangements like:

(i) Learners with visual difficulties

Students with special educational needs are grouped with others who can help him.

- If a teacher has students with visual difficulties, when writing on the blackboard, he/she may write in large, and clear writing.
- If learners are sharing textbooks, try to arrange for those with visual difficulties to have their own copies, as far as this is possible.

- Give extra time for them to write summary notes or write down observations after experiments.
- Remember to repeat the main points of the lessons.
- For students with visual impairment teacher can write of them a summary using the braille alphabet if possible.

(ii) Learners with hearing difficulties, the teacher has to encourage them to sit closer to the front of the classroom. Encourage learners not to be afraid to ask questions. When teaching, speak clearly and ensure that all the learners can hear you.

(iii) Learners with mobility difficulties:

These include learners on crutches, in wheelchairs, or with walking difficulties. These learners can be helped by their classmates. Ask their fellow learners to help them with their notes, if their conditions hinder them from writing well.

(iv) Learners with reading difficulties:

Learners with this kind of difficulties struggle to make sense of words or understand written work and take longer to read than other learners. Encourage them to pay careful attention during class time and participate for example by asking questions and answering questions, so that they can make the most of what they hear and observe. Instead of repeating word for word what is in the textbook, simplify the concepts to ease their understanding, so that when they have already understood.

b) Gender

During group activities try to form heterogeneous groups (with boys and girls) or when students start to present their findings encourage both (boys and girls) to present.

c) Financial education

As the unit deals with the importance of organic chemistry in modern life, the teacher will draw the learners' attention on the economical impact of the making of common items made using knowledge of chemistry.

When performing experiment they have to avoid waste of chemicals: they have to use the amounts that are just required.

d) Peace and values education

During group activities, the teacher will encourage learners to help each other and to respect opinions of colleagues.

e) Standardisation culture

Some lessons involve carrying out experiments. Learners have to always check if they are not using expired chemicals or defective apparatus.

In addition, when performing experiments learners have to record data accurately.

For tasks involving calculations, they have to always present accurate results.

f) Environment and sustainability

In order to avoid the environment pollution, before, during or after experiments learners have to not throw away chemicals anywhere.

Learners also have to be aware of the impacts of the use plastics on the environment.

3.4. Guidance on the introductory activity

- Provide learners with items made in plastics
- Ask them to recall the concept of hydrocarbons.
- Ask learners to identify the classes of the hydrocarbons that are the raw materials for making identified items.

Answers to introductory activity

1. Collective name of the substances used in the making of the suggested items: plastics
2. a) The raw materials used in the making of plastics are hydrocarbons containing double bonds (alkenes).
b) These alkenes are obtained by cracking alkanes.
c) As they are hydrocarbons, they possess non polar bonds and therefore are not water soluble.
3. Plastics help in different ways: for examples items may be packaged or transported easily. However, most plastics are not decayed and this leads to their accumulation in the environment. This can have a negative impact on agricultural activities

3.5. List of lessons

#	Lesson title	Learning objectives	Number of periods
1	Definition, structure and nomenclature of alkenes	Write the structural formulae of straight chain alkenes Apply IUPAC rules to name alkenes	2

2	Isomerism in alkenes	Explain the existence of geometrical isomerism in alkenes	1
3	Preparation of alkenes	Describe the industrial process of preparing alkenes	2
4	Laboratory preparation and chemical test for ethane	Carry out an experiment to prepare and test ethene gas	1
5	Physical properties of alkenes	Explain the physical properties of alkenes	1
6	Chemical properties: addition reactions	Outline the mechanisms for Electrophilic addition reactions for alkenes and alkynes. Apply Markovnikov's rule to predict the product of hydrohalogenation of Alkenes	2
7	Chemical reactions: oxidation reactions	Explain the oxidation reaction of alkenes Appreciate the combustion reaction as source of fuels	2
8	Chemical reactions: addition polymerisation	Appreciate the uses and dangers of addition polymers	2
9	Structure, classification and nomenclature of alkynes	Classify alkynes as terminal and non-terminal alkynes using their different structures Apply IUPAC rules to name alkynes	1

10	Laboratory and industrial preparation of alkynes	Describe the industrial process of preparing alkynes	2
11	Physical properties of alkynes	Explain the physical properties of alkynes	1
12	Chemical reactions of alkynes	Outline the mechanisms for electrophilic addition reactions for alkynes	2
13	Uses of alkenes and alkynes	Appreciate the uses of alkenes and alkynes	1
14	End unit assessment		2

3.6 Guidance on different lessons

Lesson 1: Definition, structure and nomenclature of alkenes (80minutes)

a. Prerequisites (10min)

Learners will get a better understanding of the content of this lesson if they refer to the covalent bonding and molecular structures (Senior 4, unit 4), general rules for naming organic compounds (senior 5, unit1)

Form groups and ask learners to discuss in group about the formation of multiples bond in covalent compounds in general and related shapes.

b. Teaching resources

Atomic models, flip charts or chalk board,

c. Learning activities

- This lesson 1 in alkenes and alkynes introduces learners to the concept of structure and the naming of alkenes.
- Let students attempt activity 3.1.1

Activity 3.1.1 (35min)

- Form groups and ask learner to describe the formation of a carbon-carbon bond.

- Provide learners with atomic models and ask them to construct models of compounds containing a carbon-carbon double bond.
- Let learners observe carefully the shape of the molecules they have constructed, specifically the structure made of the two carbon atoms doubly bonded and the four atoms attached to them.
- Ask each group to record in a note book the findings.
- Ask randomly three groups to present their findings to the whole class
- Ask learners to point out the structure of alkenes.
- From answers suggested by learners, write a short summary about the definition and the structure of alkenes

Expected answers

See student book

Activity 3.1.2 (25min)

- Let learners to brainstorm on the rules used in naming organic compounds
- Encourage them to name compounds that appear in activity 3.1.2
- Each group write on a paper names of the suggest answers
- Move around the class, listening to students as they discuss and looking at their answers
- Ask randomly three groups different from the previous ones to share their answers
- Let learners analyse the suggested answers.

Expected answers

- Hex-1-ene
- 2-methylpent-2-ene
- 6-ethylnon-4-ene
- 6-ethyldec-3-ene
- 3-methylcyclohexene
- Hexa-1,4-diene

Assess the lesson by letting learners to do checking up 3.2

Answers to checking up 3.1 (10min)

Expected answers:

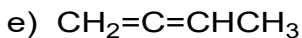
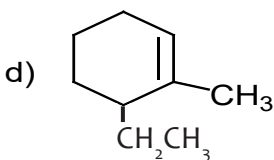
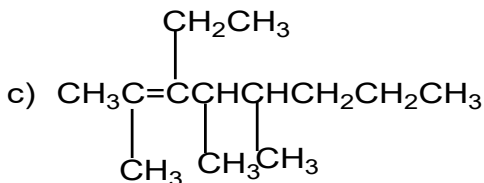
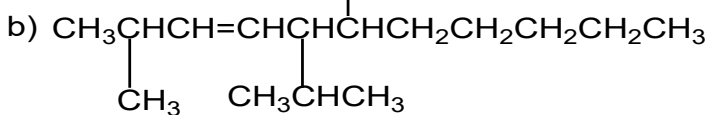
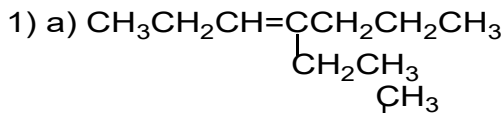

2) a) Hept-2-ene

b) 4,7-dimethyloct-3-ene

c) 6-ethyl-3,8-dimethylnon-4-ene

d) 6-butyl-10-methyldodec-3-ene

e) 3-ethyl-5-isopropylcyclohexene

Lesson 2: Isomerism in alkenes (40minutes)

a. Prerequisites (5min)

Learners will get a better understanding of the content of this lesson if they refer to the covalent bonding and molecular structures (Senior 4, unit 4), isomerism (senior 5, unit1) Ask learners to recall the types and sub-types of isomerism

b. Teaching resources

Molecular models, flip charts or chalk board,

c. Learning activities (25min)

- This lesson 1 in alkenes and alkynes recalls the concept geometrical isomerism.
- Ask learners to discuss in group about the types of isomerisms
- Let students attempt activity 3.2
- Ask learners to construct using molecular models, structures of compounds containing one double bond and five carbon atoms.
- Ask them to attempt different arrangements of atoms.
- Let them distinguish in the structures the constructed in between structural and stereoisomers.
- Suggest them to construct a structure of a cyclic alkane containing 5 carbon atoms
- Let them discuss and draw their own conclusions.
- Let 4 groups present their findings.
- Let the class harmonise ideas about isomerism in alkenes.
- From the ideas provided by the students, write a short summary.

Expected answers: See student book

Answers to checking up 3.2 (10min)

Expected answers

1. Each carbon doubly bonded is attached to two different groups
2. Compounds b), c) and f).

Lesson 3: Preparation of alkenes (80minutes)

a. Prerequisites (10min)

For a better understanding of this lesson, learners will refer to:

- Chemical equations (Senior 1 unit 10)
- Types of reactions (Senior unit 5)
- Covalent bonding (senior 4,unit 4)
- Types of formulas in organic compounds, concept of homologous series (Senior 5, unit 1), concept of reaction mechanism.

- Form groups and ask learners to distinguish between addition and elimination reactions and types of formulae.

b. Teaching resources

Textbooks, flip charts or chalk board,

c. Learning activities (50 min)

- The lesson 3 introduces learners to the preparation methods of alkenes.
- Let them find if alkenes could be prepared by addition or elimination reaction.
- Let students attempt activity 3.3

Activity 3.3 (50min)

- Ask learners to use textbooks or internet to point out and discuss methods of preparation of alkenes.
- If they have to do research using internet the task could be provided some days before the lesson and let them discuss their findings.
- Let them explain the reaction mechanism involved in this preparation.
- Let learners present their findings to the whole class.
- Let them clarify the ideas about the preparation of alkenes.
- As a facilitator points out from the ideas of the students, the key facts identified for the preparation of alcohols.

Expected answers to activity 3.3: See student book

Answers to checking up 3.3 (20min)

Expected answers:

- 1) a) pent-2-ene
- b) 2-methylpropene
- c) 2,3-dimethylbut-2-ene
- d) 1-methylcyclohexene
- e) 2-methylbut-2-ene

- 2) a) 2-methylpropene
b) 3-methylpent-2-ene
c) 2,3-dimethylbut-2-ene
d) 3-ethylpent-2-ene
- 3) a) $(\text{CH}_3)_2\text{CHCH}=\text{CHCH}_3$, 4-methylpent-2-ene
b) $\text{CH}_3\text{CH}_2\text{C}(\text{CH}_3)=\text{CHCH}_2\text{CH}_3$, 3-methylhex-3-ene
c) 1,2-dimethylcyclopentane

Lesson 4: Laboratory preparation and chemical test for ethene (40minutes)

a. Prerequisites (5min)

For a better understanding of this lesson, learners will refer to:

- Chemical equations (Senior 1 unit 10)
- Preparation and collection of different gases (Senior 1, unit 13)
- Types of reactions (Senior unit 5)
- Ask learners how gas are prepared and collected.

b. Teaching resources

Chemicals

- Ethanol
- Aluminium oxide
- Lime water
- Mineral wool
- Bromine water
- Water
- Acidified potassium permanganate solution (very dilute).

Apparatus:

- Boiling tube
- Rubber stopper with hole

- Delivery tube
- Trough
- Test- tube rack
- 5 test tubes
- 5 rubber stoppers for test tubes
- Spatula
- Bunsen burner
- Glass rod
- Splint
- Matches

c. Learning activities (30min)

The lesson 4 is about the preparation of ethene by dehydration of ethanol

- Form groups and ask learners to discuss about the preparation and collect of different gases.
- Let students attempt activity 3.4

Activity 3.4 (30min)

- Provide each group with all requirements for this experiment. These must be availed before the lesson.
- Provide learners with the procedure (this could be provided in advance) and explain it.
- Provide each group with a reporting sheet.
- Let learners perform the experiment as described in the procedure.
- Move around to make sure that the safety precautions are respected.
- Every group record their observations and make an interpretation.
- Call upon randomly four groups to share their results.
- Let the class harmonise ideas. From ideas write a short summary about the preparation and testing of ethene.

Expected answers to activity 3.4: See students book

Assess the lesson by letting learners to do checking up 3.4

Answers to checking up 3.4 (5min)

Expected answers

1. By dehydration of ethanol in the presence of sulphuric acid or by partial hydrogenation of ethyne
2. When bromine water is added to ethene the brown colour of bromine is discharged.
3. Carbon dioxide turns milky lime water but ethene does not.

Lesson 5: Physical properties of alkenes (40 minutes)

a) Prerequisites (5min)

Students will better learn the physical properties of alkenes if they have a good understanding on the chemical bonding (Senior 4, unit 3 and 4: covalent bonding and molecular structures), geometrical isomerism (senior 5, unit 1)

Form groups and ask learners to discuss about intermolecular forces

b) Teaching resources

Atomic models, flip charts/chalk board, required chemicals: tetrachloromethane, cyclohexene, water, pentene

c) Learning activities (30 min)

Let students attempt activity 3.5

Activity 3.5 (30 min)

- Provide the required chemicals and let the students perform the experiment described in activity 3.5
- Provide each group with a reporting sheet.
- Let learners perform the experiment as described in the procedure.
- Move around to make sure that the safety precautions are respected.
- Every group record their observations and make an interpretation.
- Call upon randomly three groups to share their results.
- Let the class analyse presenters' ideas.

- From ideas write a short summary about the physical properties of alkenes.

Expected answers to activity 3.5: See student book

Checking up 3.5 (5 min)

Expected answers: see student's book

Lesson 6: Addition reactions (80minutes)

a) Prerequisites (5min)

For a better understanding of the additions on alkenes and mechanisms related, learners have to review the concepts of:

- Types of reactions (Senior 2, unit 5)
- Covalent bonding (senior 4, unit 4) and more specifically topic about the Lewis structures, Lewis acid
- From groups and let learners discuss the concept of Lewis acid and the types of reactions

b) Teaching resources

Textbooks, internet connection, flip charts/chalkboard

c) Learning activities (55min)

- The lesson 6 is about the addition reactions in alkenes
- Let learners to use textbooks and relate the addition reactions to electrophilic additions on alkenes and mechanism related.
- Each group make a report.
- Call upon five groups to share their findings with emphasis on the reaction mechanisms.
- Let the class analyse the explanations of electrophilic additions on alkenes brought out by their colleagues.
- From learners ideas, write a summary of the key points on electrophilic additions on the carbon-carbon double bond.

Expected answers to activity 3.6.1

- 1) a) Addition reaction, reaction in which two or more substances react to form one compound without loss of any atom.
b) Lewis acid, an atom or group of atoms which is electron deficient. It is a cation or a molecule with empty orbitals and which can accommodate additional electrons.

Examples: H^+ , CH_3CH_2^+ , AlCl_3 , BF_3 ,...

c) Electrophile

- 2) Lewis acids cannot add to alkanes because alkanes are saturated hydrocarbons and have no lone electron pairs in their molecules.
- 3) Lewis acids can add to alkenes because alkenes are unsaturated and possess a region of high electron density (the double bond)
- 4) Alkenes are more reactive than alkanes because as unsaturated compounds, they can add other atoms in their structure and the double bond which is electron rich can give rise to many reactions.

Assess the lesson by letting learners to do checking up 3.6.1

Answers to checking up 3.6.1 (20min)

Expected answers:

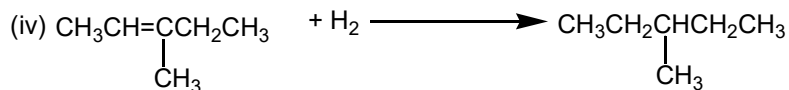
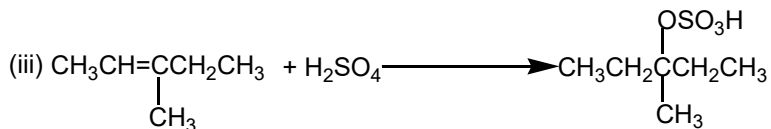
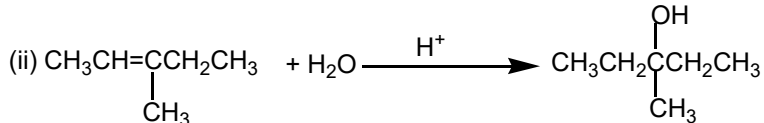
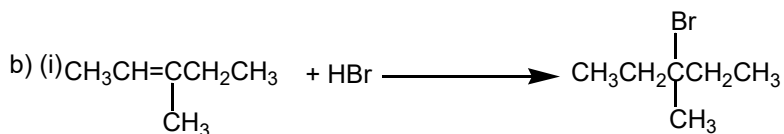

Reducing agent is a substance which donates electrons to another substance

Examples: carbon, magnesium, iron (II) sulphate, thiosulphate ions,...

(3) Carbon dioxide and water

(4) Alkenes can react with oxidising agents because each carbon doubly bonded is not in its highest oxidation state.

For the chemical equations of the reactions with various oxidising agents, see the student book.

Assess the lesson by allowing learners to do the checking up 3.6

Answers to checking up 3.6.2 (15min)

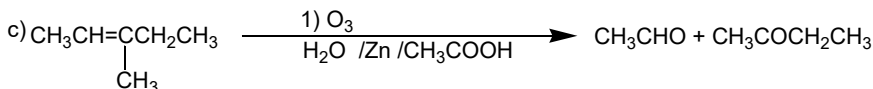
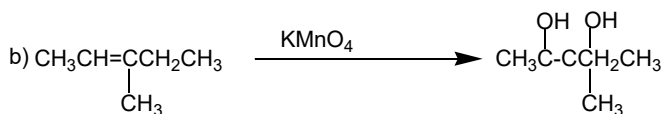
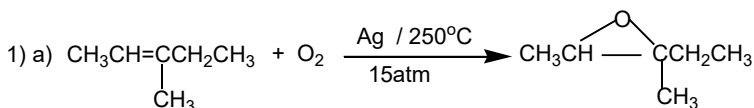

- a) The ozonolysis reaction helps to identify the position of the double bond in an alkene.
2. Butane has no effect on a dilute solution of KMnO_4 whereas but-2-ene decolourises the purple KMnO_4 solution.

Lesson 8: Addition polymerisation (80minutes)

a) Prerequisites (10)

For a better understanding of the addition polymerisation in alkenes learners have to review the concepts of types of reactions (Senior 2, unit 5)

b) Teaching resources

- Textbooks, internet connection, flip charts/chalkboard, items made in plastics

c) Learning activities (65min)

- Allow learners to form pairs and ask them to perform the scenario described in activity
- Let them predict discuss what will happen if many molecules of alkenes

add to each others.

- Allow them to do research using textbooks to clarify the concept of polymer and polymerisation, its steps and the importance of some polymerisation products.
- Each pair record their findings
- Call upon randomly five pairs to share their findings
- Let learners harmonise the key points.
- From their ideas write a short summary on the addition polymerisation of alkenes.

Expected answers to activity 3.6.3

- The people will form a long line occupying more space than each individual couple.

If many molecules of an alkene or different alkenes add to each others, they form a large molecule with physical properties different from those of each single molecule.

Verify the understanding by letting the learners do the checking point 3.7

Answers to checking up 3.6.3(10min)

1. See student book
2. They are non biodegradable substances. That is, they do not decay on attack by microorganisms. As they last for a long time they pollute the environment and agriculture is negatively affected. Thus, it is recommended to use biodegradable plastics, where it is possible. These plastics which are eco-friendly could be made using local starch containing materials.

Lesson 9: Structure, classification and nomenclature of alkynes (40minutes)

a) Prerequisites (5min)

- Students will learn better this lesson if they have a good understanding on covalent bonding and molecular structures, rules of naming organic compounds.
- Ask learners to brainstorm and recall the general rules for the naming of organic compounds

b) Teaching resources

- Atomic models, flip charts/chalkboard

c) Learning activities (30min)

Form groups and provide each group with atomic models.

Ask them to construct a molecule containing 5 carbon atoms and one triple bond and let them do activity 3.7

Move around to make sure that all learners participate actively.

Call upon three groups to present their findings.

Let the learners to point the ideas about the structure, the classification and nomenclature of alkynes.

From their ideas, write a summary

Expected answers: See student book

Assess the lesson by allowing them to checking up 3.7

Answers to checking up 3.7(5min)

Expected answers

1. a) hex-1-yne
b) hex-3-yne
c) 6-ethyl-3-methylnon-4-yne
d) 6-buthyl-12-methyl-11-propyltetradec-3-yne

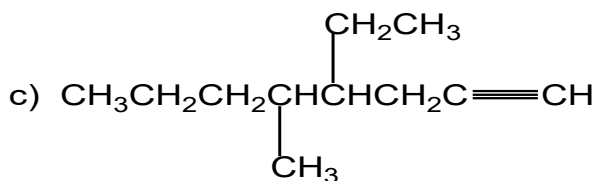
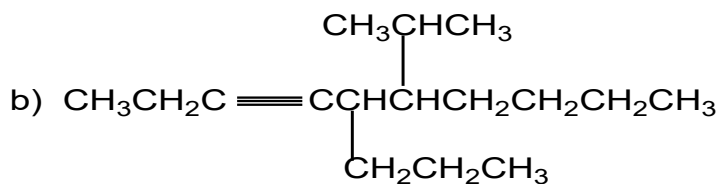
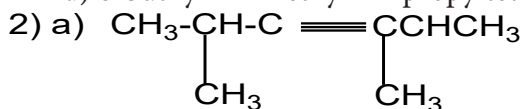

Lesson 10: Laboratory and industrial preparation of alkynes (40minutes)

a) Prerequisites (5min)

Students will learn better this lesson if they have a good understanding

Preparation of different gases to illustrate different methods of collection

(Senior 1, unit 15)

Ask learners to brainstorm about the preparation of gas by downward and upward displacement of water.

b) Teaching resources

Textbooks, flip charts/ blackboard

c) Learning activities (35min)

(i) Preparation of ethyne

- Provide each group with all requirements for this experiment as identified in activity 3.8 these must be availed before the lesson.
- Provide learners with the procedure (this could be provided in advance) and explain it.
- Provide each group with a reporting sheet.
- Let learners perform the experiment as described in the procedure.
- Move around to make sure that the safety precautions are respected.
- Every group record their observations and make an interpretation.
- Call upon randomly four groups to share their results.
- Let the class analyse results presented.
- Write a short summary about the preparation and testing of ethyne

Expected answers 3.8: See student book

(ii) Preparation of other alkynes(30)

- Allow learner to do research using test books and discuss about the preparation of other alkynes.
- Move around to make sure that all learners participate.
- Call upon three groups to share their findings.
- Let learners analyse the keys ideas about the preparation of alkynes.

- From the learners' write a brief content about the preparation of alkynes.
- Assess the lesson by asking learners to do the checking up 3.8

Answers to checking up 3.8 (10 min)

1. See student book
2. See student book
- 3) a) $2\text{CH}\equiv\text{CH} + 2\text{Na} \rightarrow 2\text{CH}\equiv\text{CNa} + \text{H}_2$

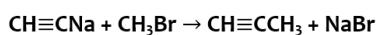

- b) $\text{CH}\equiv\text{CH} + 2\text{Na} \rightarrow \text{NaCH}\equiv\text{CNa} + \text{H}_2$

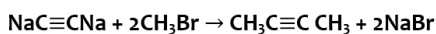

- c) $2\text{CH}\equiv\text{CH} + 2\text{Na} \rightarrow 2\text{CH}\equiv\text{CNa} + \text{H}_2$

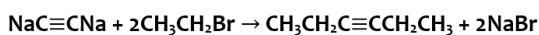

LESSON 11: Physical properties of alkynes (40minutes)

a) Prerequisites (5min)

Students will better learn the physical properties of alkynes if they have a good understanding on the chemical bonding (Senior 4, unit3 and 4: covalent bonding and molecular structures) the structure of alkynes (senior 5, unit 3, lesson 9)

Form groups and ask learners to discuss about intermolecular forces

b) Teaching resources

Atomic models, flip charts/chalk board

c) Learning activities (30min)

- The lesson 11 is about the physical properties of alkynes.
- Let students attempt activity 3.9.
- Activity 3.9 (30 min)
- Allow learners to do research using books and discuss freely about the physical properties of alkynes.
- Ask representatives of three groups to share their findings and let colleagues assess the relevance of their ideas.
- Conclude by summarising the learners' ideas about the physical properties of alkynes.

Expected answers: See student book

Evaluate the understanding of the learners by letting them do checking up 3.10.

Answers to checking up 3.9 (5min)

1. 3, 4, 4-trimethylpent-1-yne has a higher volatility than oct-3-yne because its like spherical shape does not allow its molecules to pack as closely as do oct-3-yne molecules.
2. Table salt is an ionic compound that can interact with water molecules but hex-2-yne which is a non-polar covalent compound cannot.

Lesson 12: Chemical reactions of alkynes (80minutes)

a) Prerequisites (5min)

Good understanding on the covalent bonding and molecular structures) (Senior 4, unit 4: the addition polymerisation of alkenes (senior 5, unit 3, lesson 8)

Form groups and ask learners to discuss about intermolecular forces and addition reactions.

b) Teaching resources

Items made in plastics

c) Learning activities (30min)

Activity 3.10

- For this activity, form groups and ask students to discuss about the question.
- Call upon group representatives to present their findings
- Let learner harmonize their ideas
- Institutionalize the learners' ideas

Expected answers: See student's book

Activity 3.10

- For this activity, form groups and ask students to discuss about the question.
- Call upon group representatives to present their findings

- Let learner harmonize their ideas
- Institutionalize the learners' ideas

Expected answers: See student's book

For the guidance about this lesson, see lesson 6 above

Answers to checking up 3.10

1) a) pentan-2-one

b) 2,2-dichloropentane

c) $\text{CH}_3\text{CH}_2\text{CH}_2\text{CH}_2\text{C}\equiv\text{C}^-\text{Na}^+$

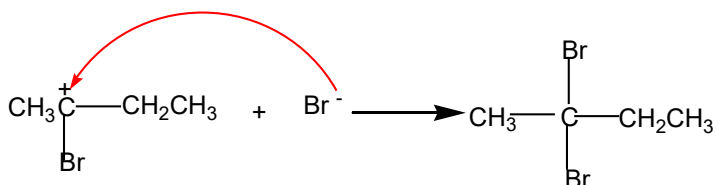
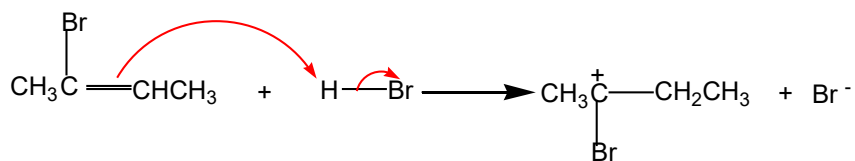
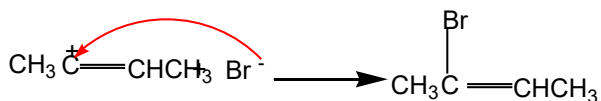
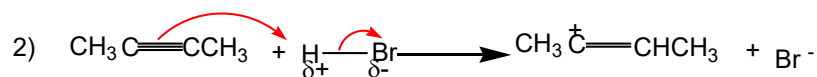

Activity 3.11 (30min)

- Form groups and let learners do activity 3.11
- Monitor the progress of the learners' activity
- Allow four groups to share their ideas.
- Let the learners appreciate the wide range of uses of alkenes and alkynes.
- Summarise their ideas.

Assess the lesson by letting them to do checking up 3.11.

Answers to checking up 3.11 (5min)

See student's book

Lesson 13: End unit assessment (80minutes)

Set an assessment questionnaire to be given to learners.

Set integrative questions respecting the blooms taxonomy so that so that the Key unit competency can be fully assessed.

For the detailed questionnaire, see point below.

3.7. Unit summary

- Alkenes are unsaturated hydrocarbons containing at list carbon-carbon double bond. They have the general formula C_nH_{2n} .
- As the rotation around the double bond is restricted, alkenes exhibit a cis-trans isomerism. The cis-trans isomers differ in the way their substituents are arranged around the double bond.
- They are widely present in the nature where the play many roles.
- For example ethene is a plant hormone in the fruit ripening, seed germination ...
- Alkenes are industrially obtained by cracking of large alkanes.
- They are also obtained by elimination reactions from alcohols, halogenoalkanes or partial hydrogenation of alkynes.
- As unsaturated hydrocarbon, they undergo addition reactions. Having a region of high density of electrons, they undergo electrophilic addition reactions.
- They form epoxydes when they react with oxygen in the presence of silver catalyst.
- The unsaturated is tested using bromine water and/or potassium manganite (VII).
- Alkenes undergo addition polymerisation reactions to yield plastics having a wide range of applications.
- Some reactions of alkenes are summarised in the table below.

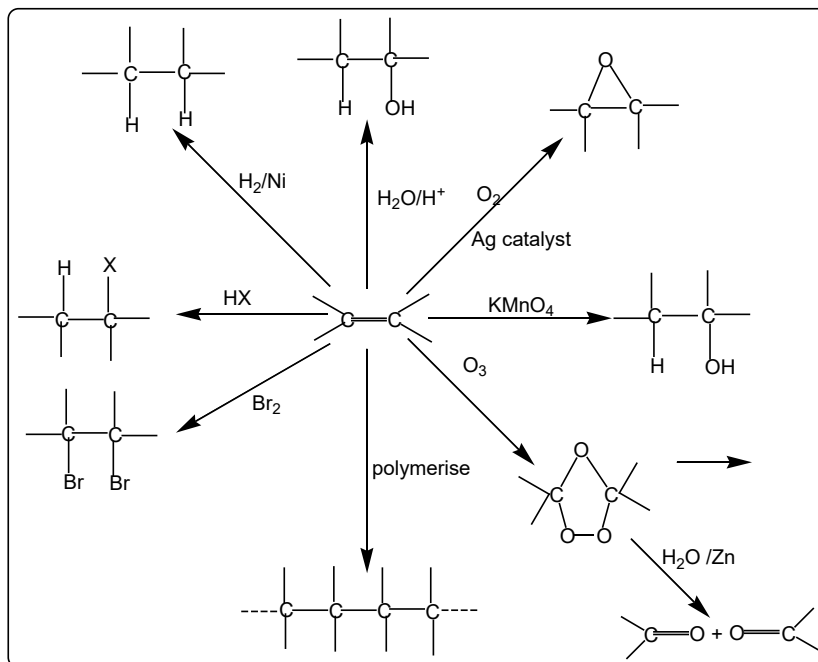

- Alkynes are unsaturated hydrocarbons with a carbon-carbon triple bond. Their general formula is C_nH_{2n-2} .
- There are two classes of alkynes: terminal and non-terminal alkynes.
- Alkynes are less volatile than alkenes because their linear structure allows them to pack together more closely than alkenes.
- Like other hydrocarbon alkynes are insoluble in water.
- Alkynes undergo addition reactions to give alkenes, alkene derivatives or alkanes.

3.8. Additional Information

This section provides additional content for the teacher to have a deeper understanding of the topic.

Oxidising agents that are effective against the carbon-carbon double bond are also effective against the carbon-carbon triple bond. But the carbon-carbon triple bond which is shorter than the carbon-carbon double bond is less reactive because electrons are more strongly attracted by the nuclei.

The oxidation of alkynes with hot alkaline potassium manganate (VII) cleaves the molecule at the site of the triple bond.

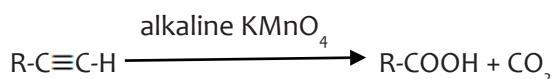

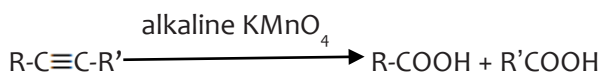

Alkynes react with ozone to yield ozonides which on decomposition with water yield carboxylic acids

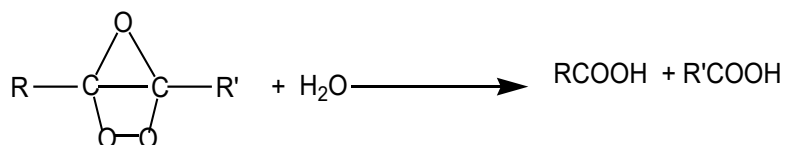
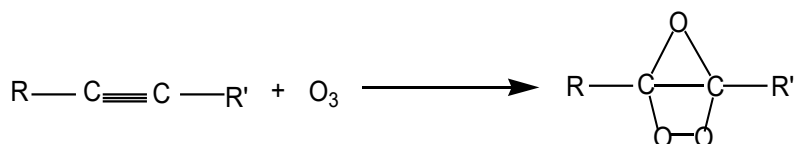
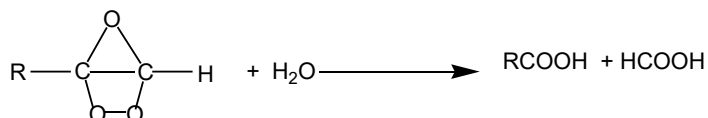
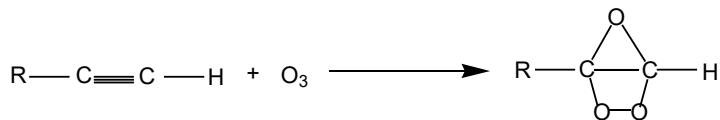

When alkynes are passed through a red hot quartz or iron tube, they polymerise to yield aromatic compounds.

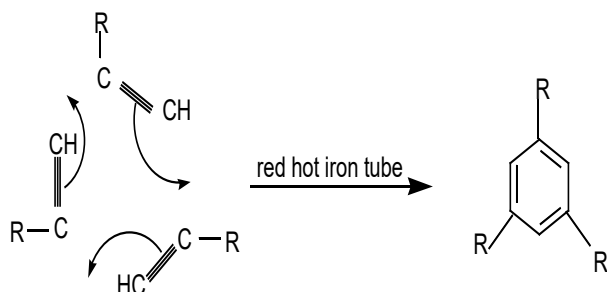

3.9 .End unit assessment

Standard of performance: Articulate the physical and chemical properties of the alkenes and alkynes to their reactivity and uses.

Answers to questions:

I. Multiple choice questions. Choose the best answer in the following by noting the corresponding letter.

1) b)

- 2) c)
- 3) a)
- 4) b)
- 5) a)
- 6) c)
- 7) c)
- 8) c)
- 9) a)
- 10) b)

II. Open questions

- 11) \equiv
- pent-1-ene
 - Pent-2-ene
 - 3-methylbut-1-ene
 - 2-methylbut-1-ene
 - 2-methylbut-2-ene
 - Methylclobutane
 - Ethylcyclopropane
 - 1,2-dimethylcyclopropane
 - 1,1-dimethylcyclopropane
 - Cyclopentan.

12)

- a) Dichloromethane is a inert solvent and therefore there is no competitive nucleophile to react with the intermediate carbocation and therefore the only product is 1,2-dibromopropane.
- b) When bromine water ($\text{Br}_2/\text{H}_2\text{O}$) is added to propene, water which is also a nucleophile react with the intermediate carbocation and two products are formed: 1,2-dibromopropane and bromopropane-2-ol are obtained.
- c) When bromine in presence of carbon tetrachloride and sodium chloride is added to propene, both water and chloride ions which are better nucleophiles than

bromide ion lead to competitive reactions and a mixture of products namely, bromopropane-2-ol, bromo-2-chloropropane, 1,2-dibromopropane and are formed.

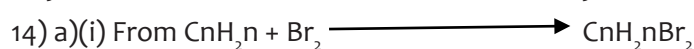
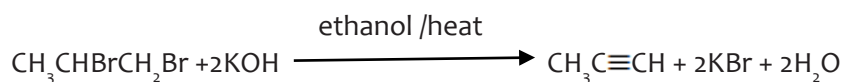
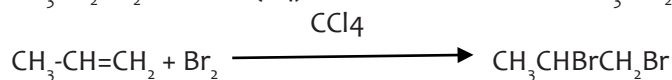
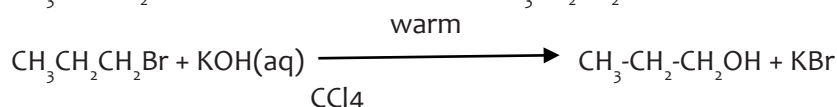
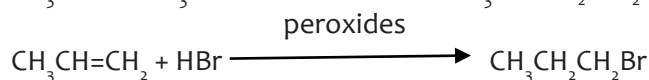
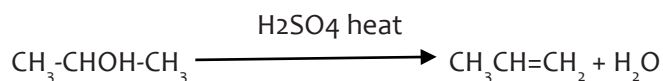
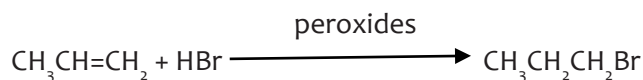
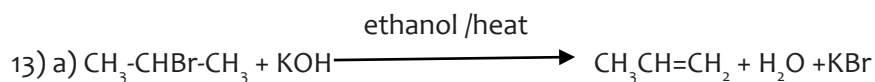

100g of Br₂ reacted with 35g of alkene

160g (mass of 1mole of Br₂) react with $\frac{35}{100} \times 160 = 56\text{g}$ of alkene

Thus, molecular mass of alkene = 56g/mol

(ii) C_nH_{2n} = 56

$$12n + 2 = 56 \quad 14n = 56, \text{ thus, } n = 14$$

Molecular formula of alkene = C₄H₈

(iii) Possible structural formulae and systematic names of one of any two alkenes

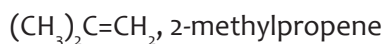
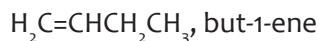

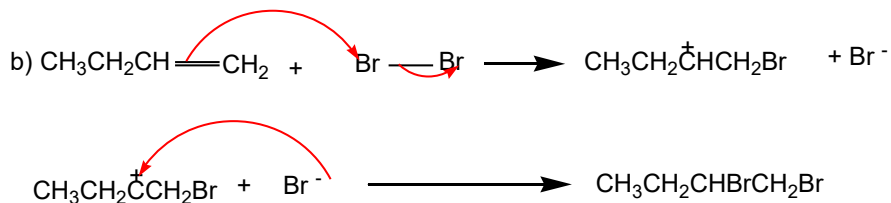

15) A = $\text{CH}_3\text{CH}_2\text{CH}=\text{CHCH}_2\text{CH}_3$, hex-3-ene

B = $\text{H}_2\text{C}=\text{CHCH}_2\text{CH}_2\text{CH}_2\text{CH}_3$, hex-1-ene

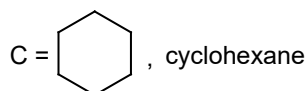

16) a) Alkenes such as ethene and propene have been described as the building blocks of the

organic chemical industry because they can undergo addition polymerisation to give a large range of plastics which have many applications.

Examples

Polyethene which is for making bags, cups, bottles,,...

Polypropene which is used for wrapping, insulator, ropes,,...

In addition ethene and propene are starting materials for the preparation of carbonyl compounds, carboxylic acids,

b) Presence of a double bond

3.10. Additional activities

Remedial Activities:

- 1) Write the structural formula for:
 - a. 4-ethylhex-2-ene
 - b. 3-ethyl-2,5-dimethylhept-3-ene
 - c. 5-isopropyl dec-4-ene
 - d. 5-propylnon-3-yne

Answers:

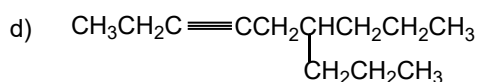
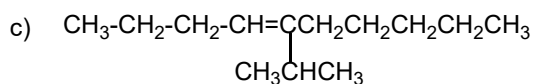
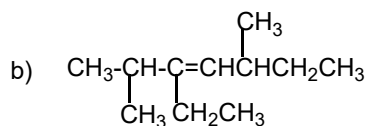
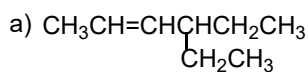

2) Write the formula or the name of the product of the reaction between pent-1-yne and:

- Hydrogen bromide(excess)
- 2moles of hydrogen
- Sodium amide
- $\text{H}_3\text{O}^+/\text{Hg}^{2+}$
- Ammoniacal copper (I)chloride

Answers:

- 2,2-dibromopentane
- Pentane
- $\text{CH}_3\text{CH}_2\text{CH}_2\text{C}\equiv\text{C}-\text{Na}^+$
- $\text{CH}_3\text{CH}_2\text{CH}_2\text{COCH}_3$
- $\text{CH}_3\text{CH}_2\text{CH}_2\text{C}\equiv\text{C}-\text{Cu}^+$

3) What the product of the ozonolysis of :

- But-2-ene
- 2-methylpent-2-ene

Answers:

- a. Ethanal
- b. Propanone and propanal

c) Consolidation activities:

a) Define the term “Electrophile”

b) Explain why alkenes and alkynes are readily attacked by electrophiles.

Outline the mechanism of the electrophilic addition of HCl on 2-methylbut-2-ene

Answers:

- a. An electrophile is a chemical species which is electron deficient.
- b. Alkenes are readily attacked by electrophiles because the carbon-carbon double bond is an electron rich region.

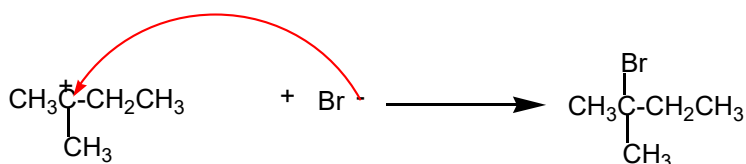
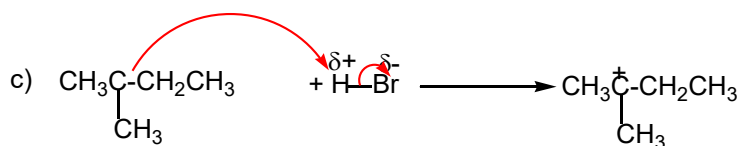

2. Give all structural formulae of alkynes with molecular formula C_6H_{10} .

Answer:

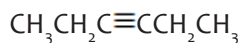
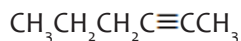
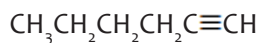

Explain how, using chemical tests:

a) propene could be differentiated from propane

b) propene could be differentiated from propyne

c) propene could be differentiated from carbon dioxide

Answers:

a) Propene decolourises bromine water but propane does not.

b) Propyne reacts with sodium amide but propene does not.

c) Carbon dioxide turns milky lime water but propene does not.

d) Extended activities:

1. Using ethanol as the only starting organic substance and inorganic reagents, write equations to show how 5-methylhept-3-yne could be prepared.

Answer:

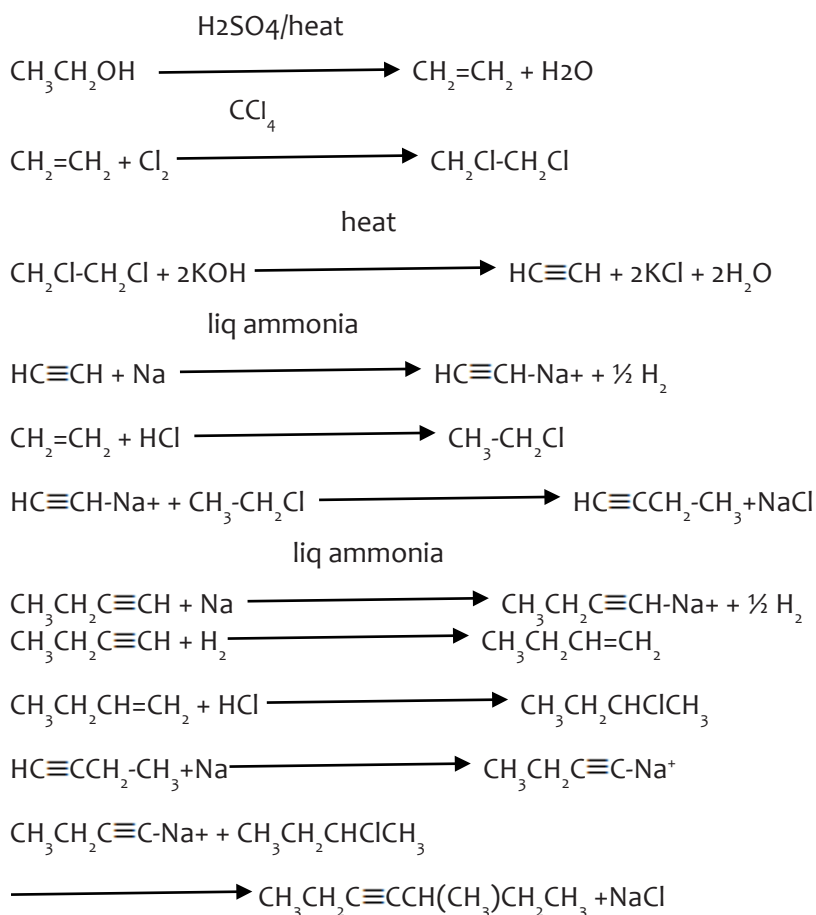

4.1. Key unit competency

The learner should be able to relate the physical and chemical properties of halogenoalkanes to their reactivity and their uses.

4.2. Prerequisite knowledge and skills

Students will learn better the formation of Halogenoalkanes or alkyl halides if they have a good understanding on: alkanes, hydrogen halides and concept of bonding.

4.3. Cross-cutting issues to be addressed

Inclusive education

This unit involves a number of experiments on the properties of halogenoalkanes compounds. The experiments require assembling of apparatus and observation of the results. This may be challenging to students with special educational needs especially children with visual impairment. However, the teacher can make some arrangements like:

- **Grouping students.** Students with special educational needs are grouped with others and assigned roles basing on individual student's abilities.
- **Providing procedure earlier before the experiment so that students get familiar with them.** They can be written on the chalkboard or printed depending on available resources. If you have children with low vision remember to print in appropriate fonts.
- **Every important point is written and spoken.** The written points helps students with hearing impairment and speaking aloud helps students with visual impairment
- **Remember to repeat the main points of the lessons.**

4.4. Guidance on introductory activity

Before introducing the first lesson of this unit (Definition and nomenclature of halogenoalkanes or alkyl halides), let learners attempt introductory activity

This activity intends to:

1. Relate the unit with learners' daily life to capture their attention.
2. Assess learners understanding of the concept of halogens and alkanes.

Answer to introductory activity

- a. In both pictures, substances are used to cure diseases
- b. The difference between them is that in picture 4.1 the substances are used for human being while in picture 4.2 other substances are used for plants
- c. Knowing that in both cases, the substances used result from reactions between alkanes and halogens, they belong to halogenoalkane homologous series.

Methodological steps

- As a facilitator, the teacher is expected to guide learners to:
- Carefully observe the pictures.
- Then individually answer the questions.
- Each student records his or her answers.
- Appoint some learners to share their answers as you record the main points on the chalkboard.

4.5. List of lessons

#	Lesson title	Learning objectives	Number of periods
1	Definition and Nomenclature of halogenoalkanes	Draw displayed structural formulae of Halogenoalkanes and give names using IUPAC system.	1
2	Classification and isomerism	Classify halogenoalkanes according to developed formula as primary, secondary and tertiary.	2
3	Physical properties	Explain the physical properties of halogenoalkanes.	2
4	Preparation methods of halogenoalkanes	Describe preparation methods for halogenoalkanes.	2
5	Chemical properties : substitution reaction	Write reaction mechanisms of halogenoalkanes as SN1, SN2, E1 and E2	2
6	Chemical properties of halogenoalkane: elimination reaction	Explain different mechanisms in halogenoalkanes	2
7	Chemical test for the presence of halogenoalkanes	Test for the presence halogenoalkanes in a given sample organic compound.	2
8	Uses of halogenoalkane and dangers associated with CFC	Explain the uses and dangers associated with halogenoalkanes	2
9	End unit assessment		1

4.6. Guidance on different lessons

Lesson 1: Definition and nomenclature of halogenoalkanes or alkyl halides.(40minutes)

This is the first lesson of unit 4 and is a single lesson. That is to say it has only one period (40 Minutes). The first lesson also covers the introduction of the whole unit.

a. Prerequisites:(5 minutes)

Students will learn better the definition and nomenclature of halogenoalkanes if they have understanding on: halogen halides and alkanes.

b. Teaching resources:

- Chalkboard or manila paper
- Use the illustrations in the students' book.

c. Learning activities : (25 minutes)

Before introducing the lesson, you will have to introduce the whole unit. Let learners therefore attempt general activity first then activity 4.1 which leads students to the first lesson of the unit. As a facilitator, the teacher is expected to guide learners through the following steps:

- Ask students to observe carefully the pictures 4.1 and 4.2 then individually answer the questions.
- Each student records his or her answers.
- Select some learners (4) to share their answers to the whole class, the class discusses on the presentation as you record the main points on the chalkboard.
- Remember to even say whatever you write so that learners with visual and hearing impairment benefits.

Activity 4.1

- **Let learners in pairs answer questions 1 of activity 4.1.**
- **Move around the class, listening to students as they discuss and looking at their answers. Mark their work as they complete each sub question and make general corrections to the whole class.**
- **This is diagnostic activity; the next step will greatly depend on your judgment. If your class cannot correctly answer the questions, extra explanations and**

exercises are necessary. But if they are correctly answered then the teacher can proceed to the actual content of the lesson.

Make a summary of the lesson (short notes) and assess your lesson

Expected answers:

(i) a) c) and e)

(ii) They all contain at least one atom of halogen in their structure

(iii) $C_nH_{2n}X$

Checking up:4.1 (10 minutes)

1. Name these compounds

a. $CH_3CH_2CHICH_3$

b. CH_3CHCl_2

c. CCl_4

d. $CHCl_3$

e. $(CH_3)_3CBr$

Answers:

a. 2-iodobutane

b. 1,1-dichloroethane

c. Tetrachloromethane

d. Trichloromethane

e. 2-bromo-2-methylpropane

2. Write structural formulae for the following compounds

a. 1,2-dibromo-3-chloropropane

b. 1, 1, 2-trichloro-1, 2, 2-trifluoroethane.

Answers:

a. $CH_2ClCHBrCH_2Br$

b. CCl_2FCClF_2

Lesson 2: Classification and isomerism (80 minutes)

Classification and isomerism is the second lesson of the unit, is a double lesson.

a. Prerequisites(10 minutes)

Students will learn better the classification and Isomerism of halogenoalkanes if they have understanding on naming of halogenoalkanes compounds.

b. Teaching resources:

- Chalkboard
- Where possible use manila papers, flipcharts.

c. Learning activities (60 minutes)

Learning activity 4.2 is suggested in students' book. However the teacher is free to add more.

Activity 4.2: Consider the different compounds and based on the carbon atom attached to the halogen atom, classify them.

- Form groups of 2-4 students. The number of groups and members will depend on your class size.
- In the groups, students attempt activity 4.2. Discuss and record their answers.
- Each group representative presents the answers to the whole class.
- During the presentation ask some questions that lead to lesson conclusion.
- Guide students to make the summary of the lesson themselves. Make sure types or classes of halogenoalkanes are emphasized on.

Expected answers:

- A primary halogenoalkane has a halogen atom attached to the ended carbon atom of the chain: a), and e)
- A secondary halogenoalkane has a halogen atom attached to a carbon bonded to two other carbon atoms : b), c) and g)
- A tertiary halogenoalkane has a halogen atom attached to a carbon bonded to three other carbon atoms: d) and f)
- a) 1-bromopentane, b) 2-chlorobutane, c) 2-iodo-5-methylhexane
b) 3-fluoro-3-methylhexane, e) 1-iodo-2,3-dimethylbutane
c) 1-chloro-1-methylcyclohexane, g) bromocyclobutane

Make the final conclusion of the lesson.

Assess the lesson. Students can do this exercise either in the course of this lesson if there is still time or as home work. Make sure you mark the students' work.

Answers to checking up 4.2: (10 minutes)

1. Five positional isomers

Three isomers :

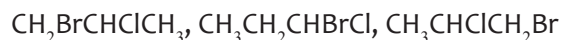

2. Draw the structural formulas of :

- a) 1,1,2-trichloropropane
- b) 2-chloro-2-methylpropane

Answer:

- a) $\text{CHCl}_2\text{CHClCH}_3$
- b) $\text{CH}_3\text{-CHCl}(\text{CH}_3)\text{-CH}_3$

Lesson 3: Physical properties of halogenoalkanes (80 minutes)

a. Prerequisites: (10 minutes)

Before beginning this lesson, learners should be able to recall some of the properties of halogenoalkanes studied in senior three. The teacher may ask oral questions to name and explain some of the physical properties of halogenoalkanes compounds. If the learners are able to mention some, then he can proceed. If not he/she can ask some probing questions.

Teaching resources

Activity	Materials
Activity 4.3	Flip chart papers or chalkboard, textbooks, chalk, markers, Sodium chloride, potassium bromide, hexane, pentane, trichloromethane, tetrachloromethane a pair of scissors.

After carrying out experiment, fill the table below

	sodium chloride	potassium bromide	hexane	pentane	trichloromethane	tetrachloromethane
observation						
conclusions						
boiling points						
conclusions on boiling point						

c. Learning activities

Learners should carry out the experiments in activity 4.3 (2), (3), (4) and (5). They should also do the study questions from each of the experiments performed in activity 4.3.

Answers to checking up 4.3

1. a) Tribromomethane>dibromomethane>bromomethane>chloromethane
b)1-chlorobutane> 2-chloro-2-methylpropane> 1-chloropropane

This is because with the increase in size and mass of halogen atom, the magnitude of van der Waal forces increases.

2. Propane has a smaller molar mass and, it is a hydrocarbon. Chloropropane, not only has a higher molar mass but also it is polar and therefore it has stronger intermolecular forces than hydrocarbons.

Lesson 4: Preparation methods of halogenoalkanes (80minutes)

a. Prerequisites

The previous lessons therefore, make sure it was well understood. can give learners some quick revision questions.

b. Teaching resources

- Textbooks
- chalkboard
- internet resources

c. Learning activities

Students are asked to do research on preparation methods of halogenoalkanes and answer questions in activity 4.4.2 The teacher may help learners by giving them a list of important reference books available in the school library.

- Research work (activity 4.4.2) is done prior to the lesson time.
- Prepare it before and give to learners clear instructions keeping in mind that in addition to subject matter skills and knowledge.
- The lesson starts with correction of the activity 4.4.1 questions.

Activity 4.4.1

On each question you will have to first give learners time to share their answers then agree on what is right.

Expected answers:

- 1.a. $\text{CH}_3\text{CH}_2\text{CHBr-CH}_3$
 - b. $\text{CH}_3\text{CHI-CH}_2\text{CH}_3$
 - c. $(\text{CH}_3)_2\text{CCl-CH}_2\text{CH}_3$
 - d. $\text{CH}_3\text{CHBr-CHBrCH}_3$
 - e. $\text{CH}_3\text{CCl}_2\text{CH}_3$
2. Secondary halogenoalkanes are: a, b, d and e

Tertiary halogenoalkanes is: c

Having answered study questions in activity 4.4.1 then learners brainstorm on the questions in activity 4.4.2

Activity 4.4.2

- Guide their discussions.

Expected answers:

- a. The product is : $\text{CH}_3\text{-CH}_2\text{Br} + \text{H}_2\text{O}$
 - b. Sulphuric acid plays a role of a catalyst
 - c. Water plays the role of cooling
- Assess the lesson using checking up 4.4

Answers to cheking up 4.4:

Complete the following chemical reactions :

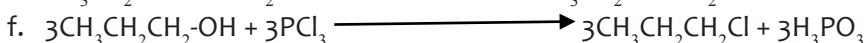
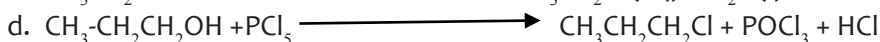
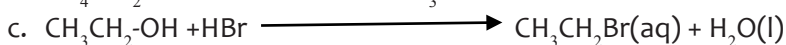
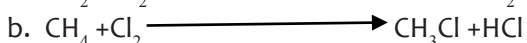
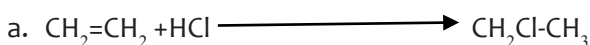

- g. Write a chemical equation for the preparation of a halogenoalkane from an aldehyde.

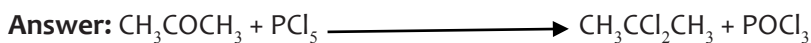

2. Give the reagents and conditions needed to make 1-bromopropane from the following compounds:

a. propan-1-ol

b. propene

Answer:

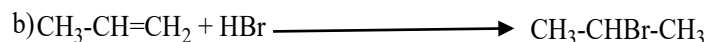
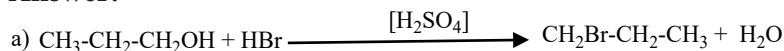

Lesson 5: Chemical properties: substitution reaction (80 minutes)

a. Prerequisites: (10 minutes)

The teacher will introduce the lesson by allowing learners to do the introductory activity 4.5.1 in groups. This activity is diagnostic i.e. intended to check on the previous information about preparation of halogenoalkanes.

b. Teaching resources

Activity	Materials
Activity 4.5.1	Sodium hydroxide, 1-bromobutane, nitric acid, silver nitrate, test tube, dropper, source of heat.

c. Learning activities: (70 minutes)

- Let learners do the activity (experiment To investigate some reactions of halogenoalkanes)
- The lesson also targets practical/experimental skills (manipulation, observation, recording and interpretation, making inferences, generalisation and conclusion) in addition to basic and generic competences. If possible the experiments can be done individually to develop manipulation skills but if they are few form manageable groups and make sure every learner participates. However, when learners perform a task together in groups it is also an opportunity to develop interpersonal skills, therefore, it should be considered during group formation.
- After experiments learners will do study questions that will help them to make conclusions.

Activity 4.5.1

Expected answers: observation must be written and conclusion drawn after the experiment is carried out by the teacher first and later by the students guided by the teacher.

Lesson 6: Chemical properties of halogenoalkane: elimination reaction (80minutes)

4. Prerequisites: (10 minutes)

The lesson 5: Chemical properties: substitution reaction therefore, makes sure it was well understood. can give learners some quick revision questions.

b. Teaching resources

- Textbook and internet resource

Learning activities: (40 minutes)

- Form groups of 2-4 students. The number of groups and members will depend on your class size.
- In the groups students discuss and record their answers.
- Each group representative presents their answers to the whole class.
- During the presentation ask some questions that lead to lesson conclusion. Guide students to make the summary of the lesson themselves.

Activity 4.5.2

Expected answers: See student's book

Answers to checking up 4.5

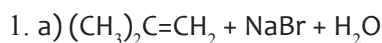

2. Because the carbon atom attached to the halogen atom is deprived of its electron, it carries a partial positive charge $-\text{C}^{\delta+} - \text{X}^{\delta-}$. Thus when electron rich substrates called nucleophiles, approach the carbon atom, the halogen atom leaves as a halide ion. Hence alkyl halides undergo nucleophilic substitution reaction.

Answer:

3. (a). A nucleophile is a chemical species that donates an electron pair to an electrophile to form a chemical bond in relation to a reaction. All molecules or ions with a free pair of electrons or at least one pi bond can act as **nucleophiles**. Because nucleophiles donate electrons, they are by definition Lewis bases.

Examples of nucleophiles are anions such as Cl^- , or a compound with a lone pair of electrons such as NH_3 (ammonia).

(b) Why do nucleophiles attack halogenoalkanes?

Answer:

Their electronegativity puts a partial positive charge on the α carbon atom. All the halogens except iodine are more electronegative than carbon. The positive charge makes that carbon susceptible to attack by a nucleophile.

(c) What two types of reaction are in competition when a halogenoalkane reacts with a nucleophile? Name two products which can be formed from 1-bromopropane by these reactions.

Answer:

Elimination and nucleophilic substitution, two products formed: $\text{CH}_3\text{CH}_2\text{CH}_2\text{OH}$, $\text{CH}_3\text{-CH=CH}_2$

4. 2-Chloro-2-methylpropane reacts with aqueous sodium hydroxide to form 2-methylpropan-2-ol

Answer:

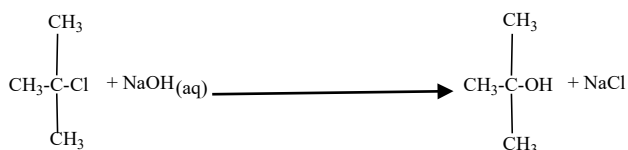

a. Draw what should be the energy diagram for the reaction.

b. Write the mechanism for the reaction.

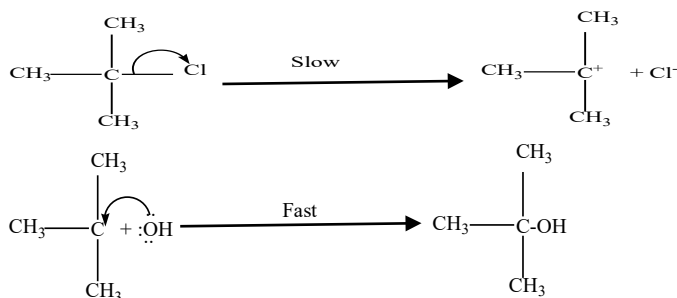

(i) Sketch an energy diagram for the reaction of aqueous sodium hydroxide and chloromethane.

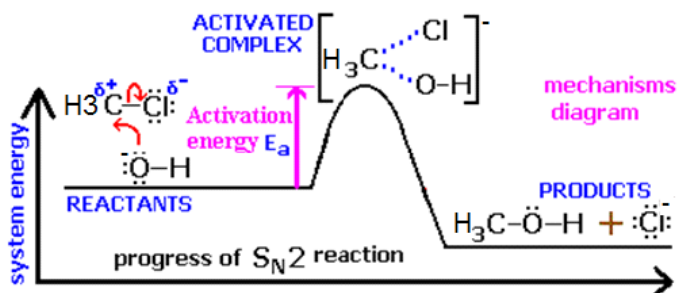

(ii) Outline the mechanism for the reaction.

Mechanisms

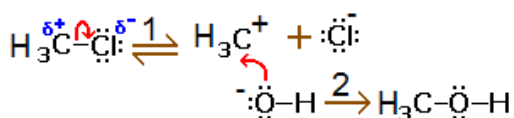

Lesson 7: Chemical test for the presence of halogenoalkanes(80 minutes)

a. Prerequisites: (10 minutes)

Students will learn better the chemical test for the presence of halogenoalkanes if they have understanding on: The two previous lesson i.e chemical properties of halogenoalkanes: substitution reaction and Elimination reaction.

b. Teaching resources:

Use the illustrations in the students' book or draw them on a manila paper.

c. Learning activities (60minutes)

Students are asked to do research on chemical test for halogenoalkanes and answer questions in activity 4.6.

As a facilitator, the teacher is expected to guide learners through the following steps:

- Carefully observe the pictures then in group of two answer the questions.
- Each group records his answers.
- Select some learners (2-4) to share their answers to the whole class, the class discusses on the presentation as you record the main points on the chalkboard.
- Remember to even say whatever you write so that learners with visual and

impairment and hearing impairment benefits.

Activity 4.6

Expected answers:

a. Observations:

- The 1-iodobutane reacts immediately. A pale yellow precipitate is formed.
- After a few minutes the 1-bromobutane reacts to form a white precipitate
- After at least 30 minutes the 1-chlorobutane reacts to form very a thin white precipitate.

b. Rate of reaction of RI > rate of reaction of RBr > rate of reaction of RCl

Answers to checking up 4.6 (20 minutes)

Sample A = $(\text{CH}_3)_2\text{CHI}$

Sample B = $(\text{CH}_3)_2\text{CHCl}$

Lesson 8: Uses of halogenoalkanes and dangers associated with CFCs (80 minutes)

a. Prerequisites:

Students will learn better the uses of halogenoalkanes and dangers associated with CFCs if they have understanding in all previous lesson on halogenoalkanes

b. Teaching resources:

- Chalk board.
- Where possible use manila papers.

c. Learning activities

Learning activity 4.7 is suggested in students' book.

- Let learners in pairs answer questions 1-4 of activity 4.7.
- Move around the class, listening to students as they discuss and looking at their answers. Mark their work as they complete each question and make general corrections to the whole class.
- This is diagnostic activity; the next step will greatly depend on your judgment. If your class cannot correctly answer the questions, extra explanations and exercises are necessary. But if they are correctly answered then the teacher can proceed to the actual content of the lesson.

Activity 4.7

Expected answers: See student's book

- Make a summary of the lesson (short notes) and assess your lesson.

Answers to checking up 4.7

- They were used as refrigerants, propellants for aerosols, for generating foamed plastics like expanded polystyrene or polyurethane foam, and as solvents for dry cleaning and for general degreasing purposes. Unfortunately, CFCs are largely responsible for destroying the ozone layer. ... CFCs can also cause global warming.
- Volatile fluorohalogenoalkanes tend to disappear as they threaten the ozone layer. *Fluoroalkanes* replace them where possible and until they get banned too. Gaseous fluorohalogenoalkanes can combat fires. Volatile *fluoroalkanes* make good refrigerant fluids to replace flammable alkanes.

4.8. Unit summary

- Halogenoalkanes contain a δ^+ carbon atom
- Their most common reaction is nucleophilic substitution. They also undergo elimination reaction to give alkenes.
- These reaction may be monomolecular (S_N1 and $E1$) or bimolecular (S_N2 and $E2$) depending on the class of the halogenoalkanes and the reaction conditions).
- Their reactivity increases in order $CF < CCl < CBr < CI$.
- Fluoro and chloroalkanes are used as solvents, aerosol propellants and refrigerants. CFCs damage the ozone layer by being photolysed to chlorine atoms, which initiate chain reactions destroying ozone.
- Halogenoalkanes can be made from alkanes and alcohols.

KEY REACTIONS :

(R= Primary, secondary or tertiary alkyl group unless otherwise stated. All reactions also work with Cl instead of Br, but much more slowly.)

- **Elimination:**

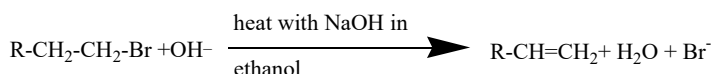

- **Nucleophilic substitutions:**

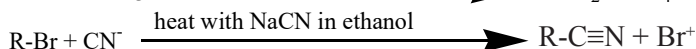
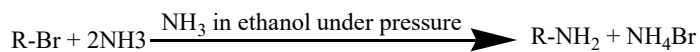
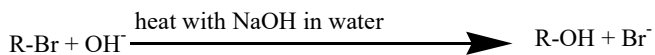

4.8. Additional Information

Preparation of Grignard reagents

This is an alkyl magnesium bromide or iodide prepared by refluxing an alkyl or iodide with magnesium turnings in the presence of dry ether.

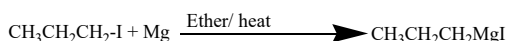
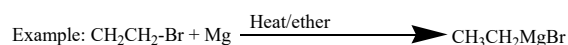
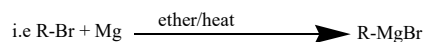

4.9. End unit assessment

Standard of performance: articulately relate the physical and chemical properties of halogenoalkanes to their reactivity and uses.

1. a) 1, 3, 5-tribromobenzene
2. Choose from a list of words and fill in the missing words in the text below

Halogenoalkanes, iodine, alkyl halide, haloarene, thyroxine

Halogenoalkanes compound are compounds in which the halogen atoms like chlorine, bromine, iodine or fluorine are attached to a hydrocarbon chain. When the halogen atom is attached to a hydrocarbon chain the compound is called an **Alkyl halides or halogenoalkanes**.

3. a) false
b) false
c) true
d) true
e) false
f) false
g) True
h) true
i) true

4. a) 2-chloro-3-methylbutane
 b) 1-iodo-2,2-dimethylbutane
 c) 1-bromo-2,2-dimethylpropane
 d) 2-bromo-3-methylbutane
 e) 4-bromo-4-methylpent-2-ene
 f) 3-chloro-5-methylhex-2-ene

5.

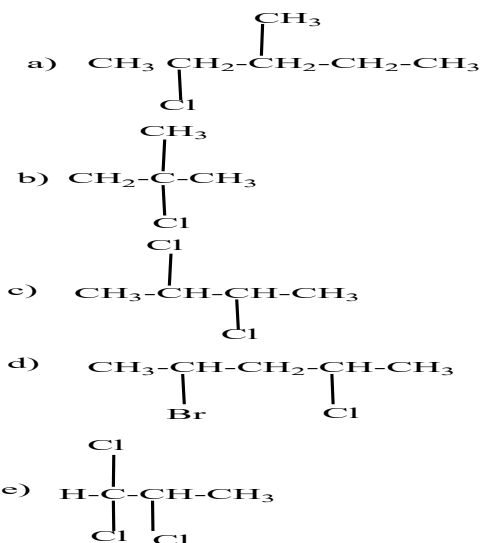

6. C-Br bond is weaker than C-Cl bond

7. C-Br bond is polar, C-H bonds are not polar

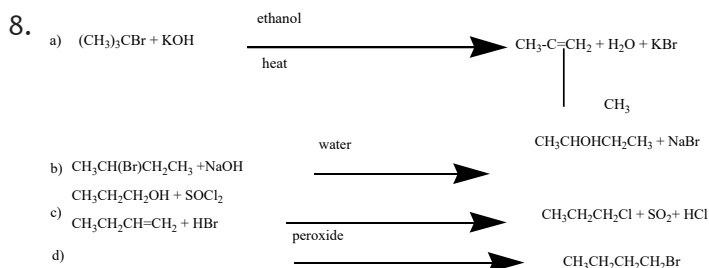

10.

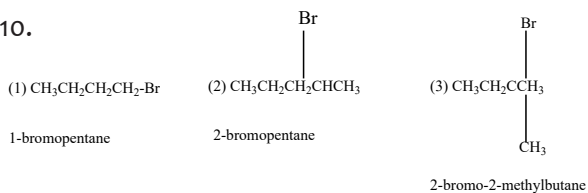

a) An $\text{S}_{\text{N}}2$ reaction involves the approaching of the nucleophile to the carbon atom to which the leaving group is attached. When the nucleophile is sterically hindered, then the reactivity towards $\text{S}_{\text{N}}2$ displacement decreases. Due to the presence of

substituents, hindrance to the approaching nucleophile increases in the following order.

1-Bromopentane < 2-bromopentane < 2-Bromo-2-methylbutane

Hence, the increasing order of reactivity towards S_N2 displacement is:

2-Bromo-2-methylbutane < 2-Bromopentane < 1-Bromopentane

b)

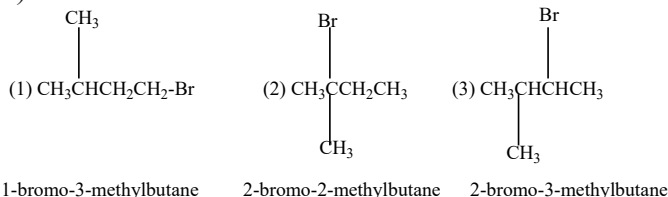

Since steric hindrance in alkyl halides increases in the order of (1) < (2) < (3), the increasing order of reactivity towards S_N2 displacement is (3) < (2) < (1).

Hence, the given set of compounds can be arranged in the increasing order of their reactivity towards S_N2 displacement as:

2-Bromo-2-methylbutane < 2-Bromo-3-methylbutane < 1-Bromo-3-methylbutane

c)

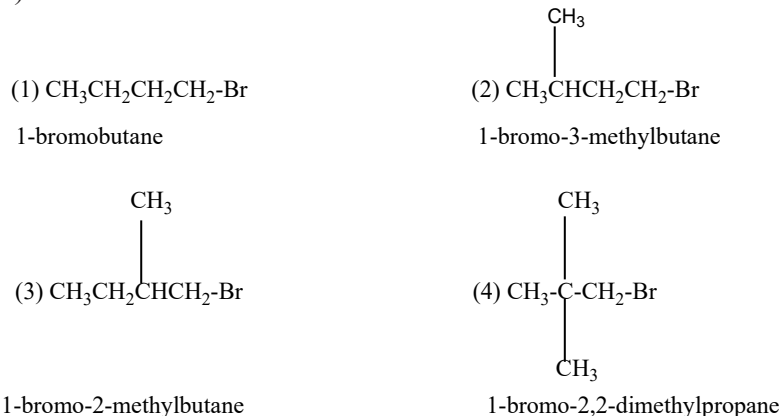

The steric hindrance to the nucleophile in the S_N2 mechanism increases with a decrease in the distance of the substituents from the atom containing the leaving group. Further, the steric hindrance increases with an increase in the number of substituents. Therefore, the increasing order of steric hindrances in the given compounds is as below:

1-Bromobutane < 1-Bromo-3-methylbutane < 1-Bromo-2-methylbutane

< 1-Bromo-2,2-dimethylpropane

Hence, the increasing order of reactivity of the given compounds towards S_N2 displacement is:

1-Bromo-2,2-dimethylpropane < 1-Bromo-2-methylbutane < 1-Bromo-3-methylbutane < 1-Bromobutane

11.a) i)

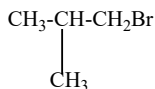
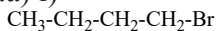

ii) 2-bromobutane

(b) i) substitution reaction

ii)

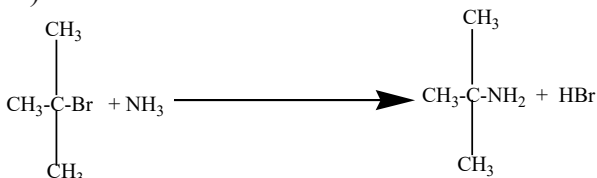

iii) $\text{CH}_3\text{CH}_2\text{CH}_2\text{CH}_2\text{-Br}$

(c) i) hot KOH in ethanol

ii) $\text{CH}_3\text{CH}_2\text{CH}=\text{CH}_2$, KBr and H_2O

d) i) ionic mechanism

ii)

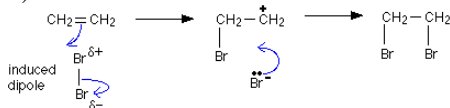

4.10. Additional activities

A. Remedial Activities:

1. Using suitable examples, define the terms:

- Nucleophile
- Substitution

Answer: a nucleophile is an electron pair donor. Substitution is reaction in which an atom or group of atoms is replaced by another atom Or group of atoms.

1-bromobutane is refluxed with aqueous potassium hydroxide to form an alcohol. Write a balanced equation for this reaction and name the alcohol formed.



Alcohol: butan-1-ol

B. Consolidation activities:

Suggest the structural formulae of the possible alkenes produced when 2-chloro-2-methylbutane is treated with hot KOH in ethanol. Which of the possible product alkenes will be found in greatest yield?

Answer:

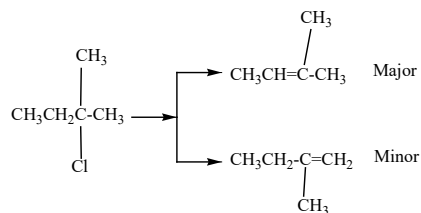

2. Why are halogenoalkanes attacked by nucleophiles?

Answer:

The halogenoalkanes contain a slightly positive carbon atom, part of the carbon-halogen bond. This carbon atom can be attacked by an electron-rich nucleophile.

C. Extended activities:

1. Use of CFCs has been declining due to concern over the possible effects on the environment. It is thought that this damage is a result of a light catalysed radical process involving chlorine radicals.

- State one possible type of damage caused by CFCs to the environment.
- Explain what is meant by a radical.
- Give an equation for the formation of a radical from the chlorofluorocarbon



Answer:

- CFCs deplete the ozone layer
- A radical is a species with an unpaired electron.
- $$\text{CCl}_2\text{F}_2 \xrightarrow{\text{light}} \text{CF}_2\text{Cl}\cdot + \text{Cl}\cdot$$

5.1. Key unit competency

Compare the physical and chemical properties of alcohols and ethers to their preparation methods, reactivity and uses.

5.2. Prerequisite (knowledge, skills, attitudes and values)

The students will learn better if they have knowledge on mechanism of hydration of alkenes and the products of hydration, (Unit 3, S5); mechanism of nucleophilic substitution reaction of halogen alkanes, (Unit 4, S5);

5.3. Cross-cutting issues to be addressed

In addition to what we saw in unity one the study of alcohols and ethers will be:

- a) **Standardization culture:** the students will be taught about the standard of the alcoholic drinks and other beverages by giving them the example of how none standardized things are harmful to organism, give them the examples on how some local beers are prepared in unknown way and how the government fight non-standardised drinks.
- b) **Gender:** The students in their groups guided by the teacher will taught about gender violence as the cause of alcohol abuse when drunk in non-controlled way the women or men can be violated due to the alcohol abuse.
- c) **Peace and values:** Self-respect even while taking the alcohol not to be directed by it but also to have self-control while drinking but also advise them to leave it completely.

d) Financial education:

While discussing in their groups or while harmonizing the work, you have to reinforce on the finance of alcohols, how alcohols bring money for the sellers and distributors of beer

5.4. Guidance on the introductory activity

- Form groups by respecting the heterogeneity (boys and girls and the students with special needs)
- Distribute the book in each group

- Give the instructions to select a leader as well as the secretary of the group who will moderate the group activities as well as to write the summary of the group, after give them time to discuss on the picture and answer to the questions (here you will be supervising the group discussion silently to allow them to think deeply on the photo and interpret it.
- After they have discussed in their groups then give them time for presentation, each group will present
- After all the group presentation, you will give the time to students so that each will evaluate the suggestion on the answers of others by adding or criticizing the answers others.
- After you will tell them to draw their own conclusion in order to discover the definition of alcohols, functional group and the general idea about alcohols.
- The intervention of the teacher will be here by adding the comments. And relate it with the content

Answer to introductory activity

Image

1. A: - This is a bar selling several kinds of beer

- People are drinking beer in the bar
- While enjoying their beer, they are playing some games

B - The picture B shows drunker people /clients fighting, throwing bottles of beer, chairs and tables on the floor.

2. Tables, Chairs, bottles,...
3. Since people are fighting, they may cause injuries to each other and end up to hospital.

5.5. List of lessons

#	Lesson title	Objectives	Periods
1	Definition and nomenclature of alcohols	Write and name alcohols according to IUPAC system.	2
2	Classification and isomerism	Classify alcohols as primary, secondary and tertiary.	1
3	Physical properties	Explain the physical properties of alcohols and ethers	1

4	Preparation of alcohols	Explain and carry out the experiments about preparation of alcohols, eg Ethanol	2
5	Preparation of ethanol by fermentation	Describe and make practice about preparation of ethanol by fermentation (urwagwa, ikigage)	2
6	Chemical properties of alcohols: reaction with concentrated sulphuric acid	Explain the mechanism of dehydration of alcohols and that reaction with hydrogen chloride and their differences	2
7	Chemical properties of alcohols: oxidation and esterification reactions	Carry out an experiment to compare the oxidation reactions of primary, secondary and tertiary alcohol.	2
8	Chemical properties of alcohols: reaction with strong electropositive metals and sodium hydroxide	Explain the mechanism of of reacting metals to alcohols	2
9	Uses of alcohols	Describe the economic use of alcohols and other uses as fuels	2
10	Nomenclature and isomerism of ethers	Describe the physical, chemical properties and preparation methods of ethers.	1
11	Physical properties of ethers	Give the physical properties of ethers	1
12	Preparation of ethers	Explain Preparation of ethers by differents methods	1
13	Chemical properties and uses	Explain and carry out the experiment about chemical properties of ethers	1
14	End unit assessment	Compare the physical and chemical properties of alcohols and ethers to their preparation methods, reactivity and uses.	2

5.6. Guidance on the lessons

Lesson1: Definition and nomenclature of alcohols (80min)

a) Prerequisite: (20min)

The learning of this lesson will be better if the students have knowledge on:

Functional groups (unit 1, Introduction to organic chemistry S5), rules of naming organic compound, (unit 1, S5), isomerism in organic chemistry (unit 1, S5), ask a question about nomenclature of alkanes

b) Teaching resources :

The teacher will avail the following resources:

- Molecular models
- Chalkboard or whiteboard or Flipcharts
- Chemistry Books from the library

c) Learning activities (60min)

- Organise the students and by using your own method help them to form groups;
- After groups have been formed, distribute tasks and give clear orientation about the task;
- Tell the students to carry out the activity 5.1 which is in their books and discuss about structures and isomers of $C_5H_{12}O$ (while they are discussing you will be moving around) (10 min);
- Allow group representative to represent the findings;
- Let the students evaluate ideas or findings
- Discuss about the answers by comparing the answers of different groups while confirming correct answers;
- Relate the answers with the real life and then,
- As teacher you have to add your content by enriching those given by the students
- Relate the content with the daily life by introducing the mechanism of naming alcohols and the isomers of the alcohols.

Answers to activity 5.1: See student's book

Answers to checking up. 5.1

1. n- octan-1-ol
2. butan-1,3- diol
3. 2-methylhexan-3-ol
4. 4,6-dimethyloctan-1,6-diol
5. 3,3-dimethylbutan-1,2-diol

Lesson2: classification and isomerism (80minutes)

a) Prerequisite

Learning of this lesson will be better if the students have knowledge on:

Electrophilic addition (unit 3, senior 5); rules of naming organic compound, (unit 1, senior 5); isomerism and stereoisomerism in organic chemistry seen in unity one organic chemistry s5 (unit 1, senior 5); types of formulae (Unit 1, S5)

Give an evaluation about isomers of halogenoalkanes (10min)

b) Teaching resources

Molecular models; flipcharts; chalkboard or whiteboard; books from library

c) Learning activities (30min)

The teacher will organize the groups and distribute tasks to students

- Tell the learners to attempt the activity 5.2 and then discuss in their groups
- The teacher will be moving around while facilitating the students
- Teacher will limit them according to the time and allow them to present the isomers found in the molecule given in the activity and related answers.
- The group will be given presentation by writing the molecules of isomers found in $C_5H_{12}O$
- When all groups finish to present, the teacher will harmonize the work by discussing with the students and add the other content, then also explain the concepts of isomerism and structures

- Teacher after adding content will tell the student to write summary and refer to their books and read even do the checking point

Answers to activity 5.2

1.

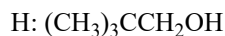
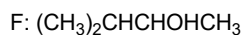

1.

2. A, D, E and H are primary alcohols, B, C and F are secondary alcohols, G is a tertiary alcohol
3. A, E and H are chain isomers, B and C are position isomers; The same D and E
4. B, D and F can exhibit optical isomerism

Lesson3: Physical properties ((40minutes)

a) Prerequisite:

The learning of this lesson requires the students to have knowledge on:

Covalent bonding and molecular structures (Unit 4, senior 4) Heat and temperature, (unit 5, senior3) (10min)

b) Teaching resources :

The teacher will use the following resources:

- Molecular models
- Chalkboard or whiteboard or Flipcharts
- Books from library
- Ruler

c) Learning activities

- The teacher will guide students to form groups and select a leader and a secretary

- The teacher will distribute the task of the activity
- The teacher will tell the students to answer related questions by comparing the boiling points and melting points of alkanes and alcohols (better to use a graph)
- In their group they have to discuss on the shape diagram found while comparing the variation of boiling points of alkanes and alcohols
- And tell them to draw conclusion about their discussion.
- The teacher will limit the time and allow them to present what they discovered
- The group will present the findings and then discuss with other groups
- The teacher will draw conclusion about change in melting point of alcohols
- The teacher will tell the student to read for more detail the physical properties of alcohols.

Expected answers to the activity 5.3

According to the data in the table:

1. As the number of carbon atoms increases, the boiling point of alcohols also increases, this means that the boiling point will increase as the molecular mass increases
2. The boiling point of alcohols of the same number of carbon atoms to alkanes, is greater than greater due to the presence of H-bond between alcohol molecule.

Expected answers to Checking up 5.3

1. See student book
2. See student book
3. No. Because they are not dissociated in water

Lesson 4: Preparation of alcohols (40minutes)

a) Prerequisite

Better learning to take place the students might have knowledge on:

Hydration of alkenes in presence of concentrated sulphuric acid (unit 3 alkenes and alkynes, senior 5); Nucleophilic substitution reaction of halogenoalkanes (unity 4 S5).

Give an evaluation on hydration of alkenes in presence of concentrated sulphuric acid (10min).

b) Teaching resources

Chalkboard or whiteboard; Books from library; Chemicals

c) Learning activities

- The teacher will ask the student to join groups and give them the instructions
- Ask the student to discuss while answering to the activity 3.4 in their book
- The teacher will be moving around while helping them to apply the prerequisite
- The teacher will supervise and help the students
- The students will present the work done in their group on the chalk board or white board
- The teacher will harmonize the work done and add the other additional content while teaching them the other methods of preparation of alcohols and ask students to use for further information their book

Activity 5.4

Proposed answers to the activity

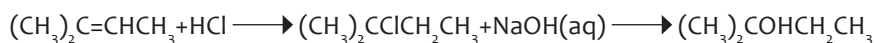
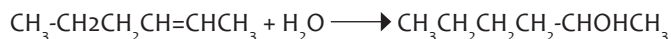

Proposed answers to checking up 5. 4

a) From alkenes

Hydration in presence of sulphuric acid

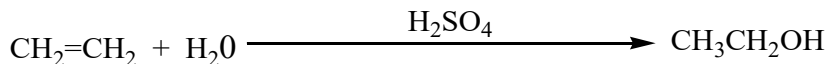

b) By a reaction between a carbonyl compound and a Grignard reagent.

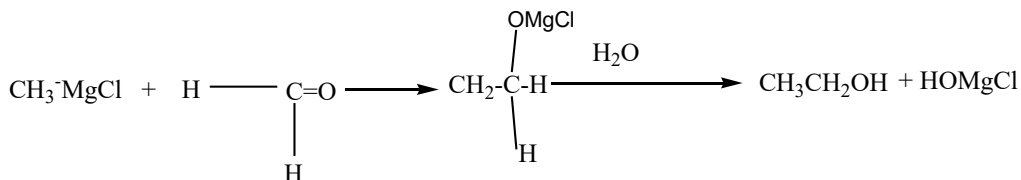

c) From halogeno alkane, it is a substitution of halogen by OH after addition of water

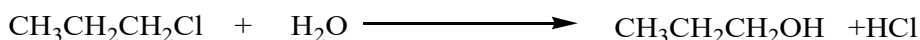

d) it is the reduction of carbonyl compound by adding oxygen for example



Lesson 5: preparation of ethanol by fermentation (80minutes)

a) Prerequisite:

better learning to take place the students might have knowledge on:

Cellular respiration (aerobic and anaerobic respiration) in biology, unity 9 senior 3

b) Teaching resources :

Flipcharts, Chalkboard or whiteboard, Books

c) Learning activities

- The teacher will tell the students to join the groups by respecting the heterogeneity.
- Distribute tasks by asking student to analyse the images on the activity 5.5 and interpret it seriously and answer to the related questions
- While moving around the teacher will facilitate the students to discuss the activity and answer to the related questions
- The students will present the work by interpreting what activities are observing on the pictures

Proposed answers to the activity 5.5

Proposed answers to the activity 5.5, we have different pictures that are formed by two people (a man and a woman) and there are doing the activity of extracting banana juice from banana.

1st picture: they are peeling yellow banana

2nd picture they are extracting banana juice from yellow banana (kwenga)

3rd picture they are taking the banana juice and putting it into umuvure

4th they are covering umuvure by using banana leaves (amakoma)

5th picture here the banana juice has been transformed to banana beer (urwagwa) and they removed the banana leaves and collecting the banana beer urwagwa.

6th picture they are sharing with colleagues

1. The main component of the final product is urwagwa made by alcohol and other ingredients
2. The process on the photo is called alcoholic fermentation
3. The product shown on the photo can again be synthesized in laboratory by using starch and glucose.

Proposed answers to checking up 5.5: See student book

N.B: Lessons 5, 6, 7 and 8 are conducted in the same way, summarized as “Chemical properties of alcohols” but you have to conduct them into different times

Lesson 6: chemical properties of alcohols (120min)

N.B you have to divide the lessons according to the table above

a) Prerequisite:

Better learning to take place the students might have knowledge on:

- Preparation of alkenes seen in unit 3, senior 5
- Properties of concentrated and diluted sulphuric acid, UNITY 3 senior 3
- Acid and bases and pH, unit 11 senior one give

b) Teaching resources

Methanol, ethanol, 2M sulphuric acid, potassium dichromate solution, test tubes, burner, droppers, propan-2-ol and 2-methylpropan-2-ol.

c) Learning activities

- Organise the student in the pair in order to carry out the experiments properly
- Give them materials and chemicals
- Give them the instructions of how to proceed by referring to the activity 5.6.1 by using some chemicals and materials given.
- The student will present the results pair by pair and lesson by lesson
- The teacher will harmonize the works done and add additional content by relating it to the real life and experimental result by interpreting and harmonizing the findings of the students

d) Proposed answers to the activity 5.6.1

The colour of the solution pass from orange to green due to the reduction of Cr⁶⁺ to Cr³⁺

Change of colour

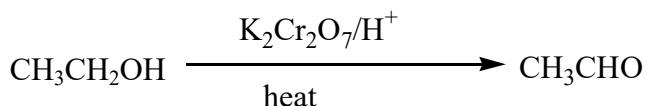

Activity 5.6.2:

See student's book

The alcohol at the temperature of 170°C, they are dehydrated forming an alkene

Mechanism see student book

Activity 5.6.5

It is about substitution reaction, see student book (alkyl halide)



d) Proposed answers to the activity 5.6.1

The colour of the solution pass from orange to green due to the reduction of Cr⁶⁺ to Cr³⁺

Change of colour

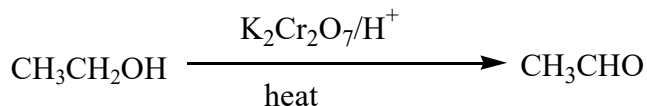

Activity 5.6.2:

See student's book

The alcohol at the temperature of 1700C, they are dehydrated forming an alkene

Mechanism see student book

Activity.5.6.5

It is about substitution reaction, see student book (alkyl halide



Proposed answers to Checking up 5. 6

1.

Element	C	H
% composition	87.6	100-87.6=13.3
Relative mole ratio	$\frac{87.687.6}{12 \ 12} = 7.14$	$\frac{13.313.3}{1 \ 1} = 13.3$
Atomic ratio	$\frac{7.147.14}{7.147.14} = 1$	$\frac{13.3.713.3.7}{7.14 \ 7.14} = 1.997=2$
Empirical formula	CH ₂	

Empirical mass x n = molecular mass

$$(\text{CH}_2)_n = 56$$

$$14n = 56$$

$$n=4$$

Lesson 7: Uses of alcohols (80min)

a) Prerequisite:

Better learning to take place the students might have knowledge on: Central nervous system, biology and health sciences unit 2 senior 3, Solution and solubility, chemistry unit 3 senior three (give the evaluation about effect of alcohols on nervous system (30min)

b) Teaching resources

Text Books; Chalkboard; Black board or white board

c) Learning activities (40min)

- Teacher will make groups according to his or her own method of group formation
- Teacher will ask the student to read the case study as activity 5.6.2 and answer to the related questions
- The teacher will be moving around while facilitating the students in reading and better understanding on the concept
- The students will represent the different answers found on their findings
- The teacher will harmonize the work by relating the work to the real life about the use of alcohols in the daily life as solvents, energy producers, ...

Answer to activity 5.7

- Whereas kanyanga is not standard and it is not advised to drink.
- The effect of using non certified alcoholic drinks, because they are considered as drug and can harm the organism
- The difference between alcoholic drinks and non-alcoholic drinks are

Alcoholic	Non alcoholic
Bitter	Sweet
Expensive	Cheap
Some effect to drink	Less effect to drunk

Here the project has to be carried out in or after the lesson

Lesson 8: Nomenclature and isomerism of ethers (40min)

a) Prerequisite

Better learning to take place the students might have knowledge on:

Chemical properties of alcohols lesson 5.6 about reaction of alcohols with sulphuric acid (give evaluation about intermolecular dehydration)

b) Teaching resources

Books; chalks or markers; chalkboard or white board

c) Learning activities

- Teacher will organize the students into the groups of students
- Give them books and tell them to carry out the activity 5.6.3
- The teacher will guide the students while moving around and facilitating them
- The time limit will be given to stop discussion
- The students will start presenting about their results on the isomers found and the other groups
- The students evaluate the work of their colleagues and try to take their conclusion
- The teacher will confirm or modify the work of the students by relating them to the contents

Expected answers to the activity 5.8.1

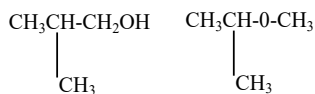
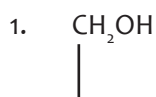

b) See student book

2. Ethers and alcohols

Expected answers to checking up 5. 8

See student book

Lesson 9: Preparation of ethers (40min)

a) Prerequisite:

Better learning to take place the students might have knowledge on:

Chemical bonding (covalent) Van Der Waals forces unit 5 chemistry senior 4; H-bonding chemistry unit3 chemistry S4; Heat and temperature, (unit 5, senior3, thermal physics) (give an evaluation about covalent bonding (10min))

b) Teaching resources

- Books from library
- Chalkboard, white board or flipchart

c) Learning activities (30min)

- You will ask the students to join their groups better if it is a pair
- Distribute tasks while giving the instruction
- Ask them to carry out the activity 5.8.2 in their groups then start discussion
- While discussing you will be moving around
- Ask the group representative to present the work done
- The students will discuss and evaluate the work of their colleagues then take conclusion themselves
- The teacher will draw confirm and add the non-added content from students
- Relate the lesson to the real life

Proposed answers to activity 5.8.2

1. Intermolecular dehydration reaction is the reaction of alcohols which produce symmetric ethers due to addition of sulphuric acid at 1400C (see student book)
2. The condition and reagents are: conc H₂SO₄ at 1400C

Lesson 10: chemical properties and uses of ethers (40min)

Those are two lessons but they are taught in a single period

a) Prerequisite:

Better learning to take place the students might have knowledge on

- Intermolecular dehydration of alcohols; (unit 4&5)
- Cleavage of O-H bond of alcohols and nucleophilic substitution reaction

(unit 4 & 5)

- Combustion reaction (unit 2 & 5)

b) Teaching resources

Molecular models, books from library, chalks, white board or black board

c) Learning activities

- Ask the students to join their groups;
- Give students instructions and materials (molecular model and books);
- Tell them to discuss in their groups about the activities 5.9 and 5.10
- While discussing and interpreting the photo 5.10 you will be moving around by facilitating them to accomplish the task;
- Give them the time to represent by writing their answers on the black board;
- When all groups will finish to present, you allow the students to discuss on the answers of their colleagues while controlling the discussion;
- The teacher will enrich the content and add non given ideas;
- The teacher will ask the students to take summary in their book

Expected answers to activity 5.9

Molecular formula: C_3H_8O

Its three isomers are: $CH_3CH_2-CH_2-OH$

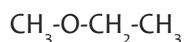
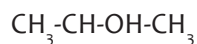

The one which does not react with sodium metal is: $CH_3-O-CH_2-CH_3$

d) Activity 5.10

Proposed answers

The molecule is $CH_3-OCH_2CH_3$

3. Anesthesia keeps patient from feeling pain during the procedure of surgery

4. The anesthesia is injected to the patient when he/she is going to be operated

Expected answers to checking up 5.10: See student book

Lesson 14: End unit assessment (80min)

The teacher will set an integrative assessment that cover the whole unity and that allow him to verify the Key unit competencys

5.7. Unit summary

Alcohols are aliphatic compounds containing the OH group. They are named using the suffix **-ol**

Primary alcohols are of the form RCH_2OH ; secondary alcohol are of the form

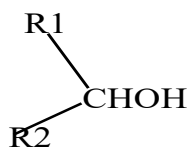

Tertiary alcohols are of the form

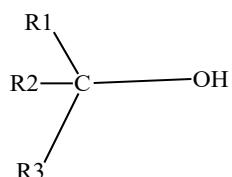

- The physical properties of alcohols, especially the early members of the series are strongly influenced by Hydrogen bonding
- Alcohol act as proton donor but are weaker acid than water.
- Alcohols act as bases becoming protonated on the oxygen atom. This lead to the formation of carbocation and subsequent dehydration.
- Primary alcohols can be oxidized to aldehydes, then acids, secondary alcohol are oxidized to ketones, tertiary alcohol are not oxidized without fermenting the molecule
- Some alcoholic drinks are sometimes prepared using traditional methods.

5.8. Additional information

Polyhydric alcohols

Those are the molecules of alcohols which are characterised by the presence of many OH groups, the IUPAC system of naming them is started with the prefix di, tri... depending to the number of hydroxyl group, where as their common name is glycols(greek glycy: sweet) since they have a sweet taste

Formula	Common Name	IUPAC Name
HOCH ₂ CH ₂ OH	Ethylene glucol	1,2ethanediol
HOCH ₂ CH(OH)CH ₃	Propylene glycol	1,2 propanediol
HOCH ₂ CH ₂ CH ₂ OH	Trimetylen glycol	1,3 propanediol

Glycerol is a by-product in the manufacture of soaps by alkaline hydrolysis of fats. It is used in the manufacture of the esters which it forms with nitric acid, propane-1,2,3-triyltrinitrate or glyceryl trinitrate

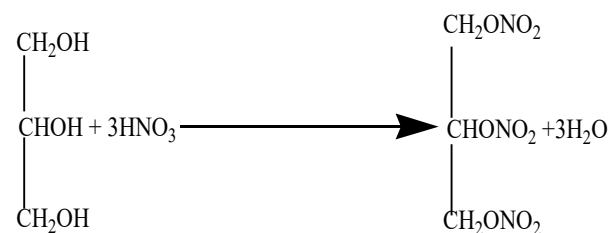

Propane-1,2,3-triol
(glycerol)

Propane-1,2,3-triyl trinitrate
(glyceryl trinitrate)

This ester, also called nitro-glycerine is an explosive which is detonated by shock. When nitroglucerol is in contact with a clay of the type kieselguhr, it is called dynamite. It is still powerful explosive but it is less sensitive to shock.

Phenols

Phenols are characterised by the presence of OH or hydroxyl group located on the benzene ring. Phenols react differently from the alcohols and they are acidic. They are able to react with NaOH.

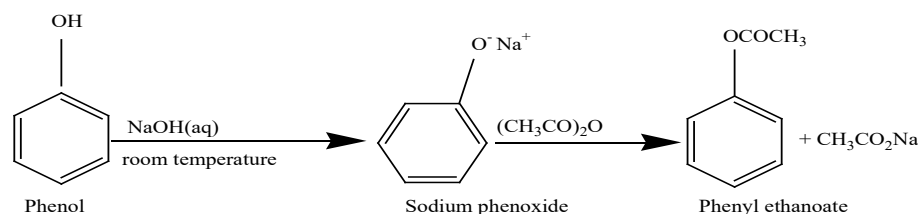

5.9. Unit assessment

Standard of performance: Articulate the physical and chemical properties of alcohols and ethers to their preparation methods identification reactivity and uses

I. Multiple choice questions

- C

2. B
3. A
4. B

II. Open questions

5. The compound is an ether which is symmetric because. It yields an alkyl iodide

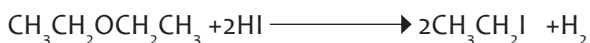
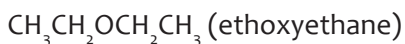

6. % of hydrogen = $100 - 86 = 14\%$

Element	C	H
Percentage	86	14
Relative number of atoms	$86/12 = 7.1$	$14/1 = 14$
Atomic ratio	$7.1/7.1 = 1$	$14/7.1 = 2$
Empirical formula	CH_2	

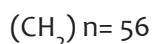

$14n=56$, $n=4$, the molecule formula is C_4H_8

Isomers Of **Y** are: $\text{CH}_3\text{CH}_2\text{CH}=\text{CH}_2$, $\text{CH}_3\text{CH}=\text{CHCH}_3$, $\text{CH}_3(\text{CH}_3)\text{C}=\text{CH}_2$

Isomers of **M** are: $\text{CH}_3\text{CH}_2\text{CHCH}_2\text{OH}$, $\text{CH}_3\text{CHOHCH}_2\text{CH}_3$, $\text{CH}_3(\text{CH}_3)\text{COHCH}_3$

Isomers of **N** are ethers of the above molecules $\text{CH}_3\text{CH}_2\text{CH}_2\text{CH}_2\text{OCH}_2\text{CH}_2\text{CH}_2\text{CH}_3$, $\text{CH}_3\text{CH}_2\text{CH}(\text{CH}_3)\text{OCH}(\text{CH}_3)\text{CH}_2\text{CH}_3$

$$7. \text{ Percentage of carbon in carbon dioxide} = \frac{12}{44} \times \frac{0.592}{0.25} \times 100 = 65\%$$

$$\text{percentage of hydrogen in water} = \frac{2}{19} \times \frac{0.30}{0.25} \times 100 = 13.33\%$$

$$\text{percentage of oxygen} = 100 - (65 + 13.33) = 21.54\%$$

Element	C	H	O
Percentage	64.73	13.73	21.54
Relative number of atoms	$\frac{64.73}{12} = 5.39$	$\frac{13.73}{1} = 13.73$	$\frac{21.54}{16} = 1.35$

Atomic ratio	$\frac{5.39}{1.35} = 4$	$\frac{13.79}{1.35} = 10$	$\frac{1.35}{1.35} = 1$
Empirical formula	$C_4H_{10}O$		

$$n = \frac{\text{molecular weight}}{\text{empirical weight}} = \frac{74}{74} = 1$$

Thus, molecular formula = empirical formula = $C_4H_{10}O$

isomers of M

- $CH_3CH_2CH_2CH_2OH$
- $CH_3CHOHCH_2CH_3$
- $(CH_3)_2CHCH_2OH$
- $(CH_3)_2COHCH_3$

8. Comparison between the preparation of ethanol by hydration and by fermentation

	Preparation by hydration of ethene	Preparation by fermentation
Advantages	Pure product Fast reaction	Use renewable resources Low energy cost
Disadvantages	Use non renewable resources High energy cost	Slow reaction impure product

5.10. Additional activities

a) Remedial Activities:

1. What is the general formula of alcohols and classify the types of alcohols?

Answer: $C_nH_{2n+1}OH$ or $R-OH$

Alcohols are classified in: Primary: RCH_2OH

Secondary:

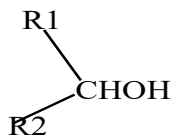

and tertiary

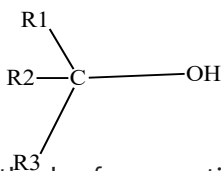

2. Give at least 3 methods of preparation of alcohols

Answer:

- (i) hydration of alkenes in presence of sulphuric acid; mechanism see student book
- (ii) addition of water to an halogenoalkane, this is a substitution reaction where the OH group from water replaces the halogen atom of halide: mechanism see student book
- (iii)

3. Describe the method of alcoholic fermentation:

Answer: see student book

b) Consolidation activities:

1. Butanol reacts with sodium, there are four isomers formed by the same molecules which are alcohols
 - a) Write the alcohols of butanol
 - b) Write a reaction of isomers of butanol and sodium metal
 - c) One of the isomers, react with ethanoic acid to form ester, establish the reaction
 - d) Butan-1-ol react with sulphuric acid to form possible 3 products. Establish reactions and conditions to form the said products
 - e) One of the compounds in (d) has the empirical formula CH_2 , and the relative molecular mass is 56 g/mol. Use this information to deduce that formula.
2. Propanol can be formed by the hydration of an alkene in presence of a suitable catalyst.

(i) Suggest the catalyst used in the reaction

(ii) Establish the mechanism of reaction

Answers

a. i) $\text{CH}_3\text{CH}_2\text{CH}_2\text{CH}_2\text{OH}$ butan-1-ol

ii) $\text{CH}_3\text{CH}_2\text{CHOHCH}_3$ butan-2-ol

iii) $\text{CH}_3\text{CH}(\text{CH}_3)\text{CH}_2\text{OH}$ 2-methylpropan-1-ol

iv) $\text{CH}_3\text{C}(\text{OH})(\text{CH}_3)\text{CH}_3$ 2-methylpropan-2-ol

b. Reaction of isomer with Na

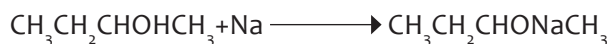

c. $\text{CH}_3\text{CH}_2\text{CH}_2\text{CH}_2\text{OH} + \text{HOOC-CH}_3 \longrightarrow \text{CH}_3\text{COOCH}_2\text{CH}_2\text{CH}_2\text{CH}_3$

d. The possible products are: by using concentrated sulphuric acid at 170°C alkene is produced

by using sulphuric acid at 140°C, ether is formed

by using sulphuric acid diluted and cold, alkyl hydrogen sulphate is formed

e. $(\text{CH}_2)_n = 56$; $14n = 56$, $n = 56/14 = 4$

f. The molecular formula is C_4H_8

3. The catalyst used is concentrated sulphuric acid

Mechanism: see student book

c) Extended activities:

1. A compound (A) $\text{C}_6\text{H}_{14}\text{O}$ liberate H gas when treated with sodium metal, A doesn't react with NaOH, gives positive Lucas test in several minutes. When A treated with PBr_5 the compound (B) $\text{C}_6\text{H}_{13}\text{Br}$ is formed when B is treated with alcoholic KOH compound (C) and (D) both having the formula of C_6H_{12} are formed (C) is the major reaction product while (D) is the minor product. When (C) is treated with ozone, followed by hydrolysis only a single ketone is

obtained. This ketone can be shown to be identical to the compound produced by hydration of propyne in presence of sulphuric acid and mercuric sulphate from the information deduce and write the structural formula of (a) to (d).

Answer:

Because the molecule $C_6H_{14}O$ liberate the hydrogen gas when reacted with Na, shows that it is an alcohol, but also because of its behaviour when it is identified by Lucas test, that shows that this alcohol is a tertiary alcohol

(A) is **2,3 dimethylbutan-2-ol** or any tertiary alcohol

to the molecule of (A), the addition of PBr_5 show a substitution reaction, so the molecule

(B) is **2-bromo 2,3 dimethyl butane**

the addition of alcoholic KOH compound is added to (B), there is an elimination reaction

(C) is **2, 3 dimethyl but-2-ene (cis or trans)**

(D) is **2,3 dimethylbut-1-ene**

2. a) a compound X has molecular formula C_3H_8O , write the structural isomer and names of X

b) x react with iodine and aqueous sodium hydroxide to form a yellow precipitate

(i) identify

(ii) write the equation of reaction between X and iodine in the presence of sodium hydroxide

(iii) State what would be observed if X were reacted with acidified chromium (VI) oxide , write the equation of the reaction to show the main product

a) When X is heated with with excess concentrated sulphuric acid a gas Y which decolourise bromine water was evolved , write the equation of the reaction between

(i) X and sulphuric acid

(ii) Y and bromine water and name the product

Answer:

a) The molecule C_3H_8O conform the general formula for monohydric alcohols and ethers therefore the possible formula are:

$\text{CH}_3\text{CH}_2\text{CH}_2\text{OH}$ propan_1_ol

$\text{CH}_3\text{CHOHCH}_3$ propan_2_ol

$\text{CH}_3\text{-OCH}_2\text{CH}_3$ methoxyethane

b) The fact X gives positivedoform test implies that it should be a secondary alcohol with CH_3 group attached to carbon atom carrying OH group, therefore the molecule is $\text{CH}_3\text{CHOHCH}_3$

Reaction



Observation the yellow colour turns green

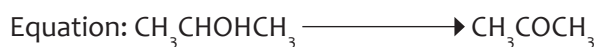

The name of the product is propanone



UNIT 6: CARBONYL COMPOUNDS: ALDEHYDES AND KETONES

6

6.1. Key unit competency

to be able to: Compare the chemical nature of carbonyl compounds to their reactivity and uses.

6.2. Prerequisite (knowledge, skills, attitudes and values)

The students will learn better if they have knowledge on Mechanism of electrophilic addition of alkenes and the products of the hydrogen halides addition of alkenes (Unit 3, S5) and reduction and oxidation reactions (Unit 17, S4), (unit 1, Introduction to organic chemistry S5).

6.3. Cross-cutting issues to be addressed

a. Environment protection: Environment protection, polymers formed from aldehyde for example bakelite is harmful to environment but materials formed by cellulose, trees, are not harmful to environment.

b. Standardization culture: the students will be taught about the standard of the table sugar and how some local beers are oxidized in aldehyde and carboxylic acids when are exposed on air

c. Gender: The students in their groups guided by the teacher will be taught about gender violence as the cause of alcohol abuse when drunk in non-controlled way the women or men can be violated due to the alcohol abuse.

6.4. Guidance on the introductory activity

- Form groups by respecting the heterogeneity (boys and girls and the students with special needs)
- Distribute the book in each group
- Give the instructions to select a leader as well as the secretary of the group who will moderate the group activities as well as to write the summary of the group, after give them time to discuss on the picture, molecules and answer to the questions (here you will be supervising the group discussion silently to help learners to think deeply on the photo, molecules and interpret it.

- After they have discussed in their groups then give them time for presentation, each group will present
- After all the group presentation, you will give the time to the learners so that each will evaluate the suggestion on the answers of others by adding or criticizing the answers of others.
- After you will tell them to draw their own conclusion in order to discover the definition of aldehyde and ketone and the general idea about carbonyl functional group.
- The intervention of the teacher will be here by adding the comments. And relate it with the content

6.5. LIST OF LESSONS

#	Lesson title	Objectives	Number of Periods
1	Definition and nomenclature of carbonyl compounds	Write and name carbonyl compounds according to IUPAC system.	1
2	Classification and isomerism	Classify carbonyl compounds as aldehydes and ketones	1
3	Physical properties of aldehydes and ketones	Explain the physical properties of aldehydes and ketones	2
4	Chemical properties: nucleophilic addition reactions	Explain the mechanism of nucleophilic addition of aldehydes and ketones	2
5	Chemical properties: condensation reactions	Carry out an experiment to test presence of aldehydes and ketones by 2,4-dinitrophenylhydrazine (Brady's reagent).	2
6	Chemical properties: oxidation reactions using KMnO_4/H^+ and $\text{K}_2\text{Cr}_2\text{O}_7/\text{H}^+$	Carry out an experiment to distinguish between aldehydes and ketones using $\text{K}_2\text{Cr}_2\text{O}_7/\text{H}^+$.	2

7	Chemical properties: oxidation reactions using Fehling or Benedict solution	Carry out an experiment to distinguish between aldehydes and ketones using Fehling's solution or Benedict's solution.	2
8	Chemical properties: oxidation reactions using Tollens' reagent	Carry out an experiment to distinguish between aldehydes and ketones using Tollens' reagent,	2
9	Chemical properties: iodoform reactions	Using triiodomethane (iodoform) reaction to identify the presence of a CH_3CO group in aldehydes and ketones.	2
10	Preparation methods of aldehydes and ketones	Explain and carry out the experiments about preparation of aldehydes and ketones	2
11	Uses of aldehydes and ketones	Describe the economic use of aldehydes and ketones And their importance in living things.	2
13	Summative assessment	Compare the chemical nature of carbonyl compounds to their reactivity and uses.	2

6.6. Guidance on the lessons

Lesson: Definition and nomenclature of carbonyl compounds. (40min)

a) Prerequisite/introduction: (10min)

The learning of this lesson will be better if the students have knowledge on: Functional groups (unit 1, Introduction to organic chemistry S5), rules of naming organic compound, (unit 1, S5), isomerism in organic chemistry (unit 1, S5), ask a question about nomenclature of alkanes and functional groups

b) Teaching resources:

The teacher will avail the following resources:

- Molecular models
- Chalkboard or whiteboard or Flipcharts
- Chemistry Books from the library

c) Learning activities (30min)

- Organize the students and by using your own method help them to form groups;
- After groups have been formed, distribute tasks and give clear orientation about the task;
- Tell the students to carry out the activity 6.2 which is in their books and discuss about names of

Set of molecules A

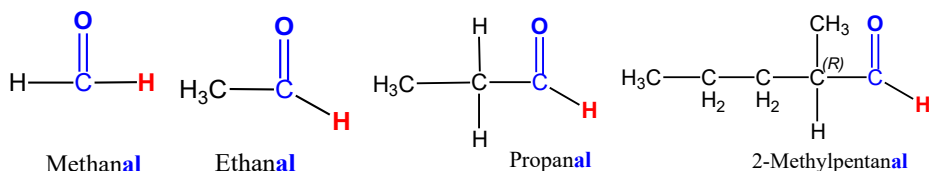

Set of molecules B

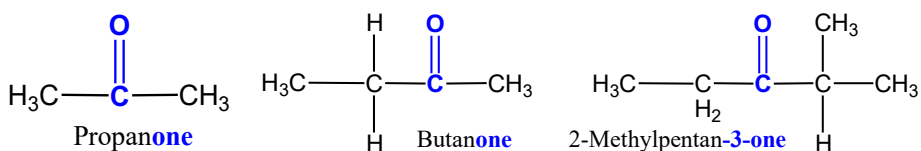

- Allow group representative to represent the findings;
- Let the students evaluate ideas or findings
- Discuss about the answers by comparing the answers of different groups while confirming correct answers;
- As teacher you have to add your content by enriching those given by the students

d) Answers to introductory activity: See student book.

1. Functional groups found in these molecules are:

Aldehyde, ketone and alcohol

2.

Yellow bananas

Potatoes,...

3.

Similarity	Difference
Both have carbonyl functional group	Glucose has aldehyde functional group but fructose has ketone functional group.
Both are sugars	For glucose Carbonyl group is at 1st carbon but for fructose carbon is at 2nd carbon.
Both have hydroxide group	

4.

Similarity	Difference
Both undergoes addition reaction	Aldehyde could be oxidized easily but ketone couldn't.
Both react with 2,4-dinitrophenylhydrazine	

e) **Answers to activity 6.1:** See student book.

Suffix "al" indicates aldehyde functional group.

Prefix indicates number of carbons for every molecule

Others two molecules: $\text{CH}_3\text{CH}_2\text{CH}_2\text{CHO}$: butanal and

$\text{CH}_3\text{CH}_2\text{CH}_2\text{CH}_2\text{CHO}$: pentanal.

Suffix "**one**" indicates ketone functional group, **Prefix** indicates number of carbons for every molecule

Others two molecules: $\text{CH}_3\text{CH}_2\text{CH}_2\text{CHOCH}_2\text{CH}_3$: hexan-3-one and

$\text{CH}_3\text{CH}_2\text{CH}_2\text{CH}_2\text{CHOCH}_2\text{CH}_3$: heptan-3-one.

Answers to checking up 6.1

Aldehyde and name	Ketone and name
A: butanal	B. Butanone
C: hexanal	D.Pentan-2-one

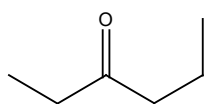

i. Hexan-3-one

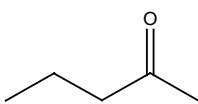

ii. pentan-2-one

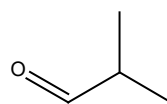

iii. 2-methylpropanal

Lesson2: Classification and isomerism (40minutes)

a) Prerequisite/ introduction: (10min)

The learning of this lesson will be better if the students have knowledge on: Functional groups (unit 1, Introduction to organic chemistry S5), isomerism in organic chemistry (unit 1, S5), types of formulae (Unit 1, S5) ask questions about types of formulae of organic compounds.

b) Learning activities (30min)

- Organize the students and by using your own method help them to form groups;
- After groups have been formed, distribute tasks and give clear orientation about the task;
- Tell the students to carry out the activity 6.2 which is in their books and discuss about structures and isomers of

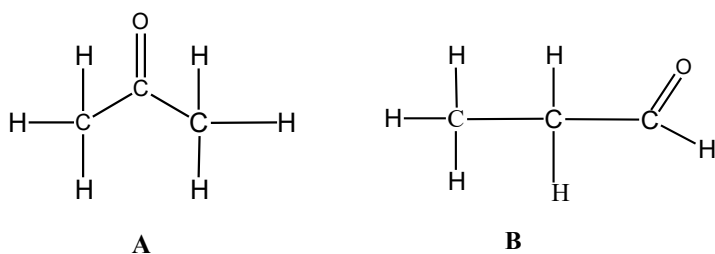

(10 min)

- Allow group representative to represent the findings;
- Let the students evaluate ideas or findings
- Discuss about the answers by comparing the answers of different groups while confirming correct answers;
- As teacher you have to add your content by enriching those given by the students

c) Answers to activity 6.2

1. Numbers of atoms in molecule B; C=3; H=6; O=1
2. Numbers of atoms in molecule A; C=3; H=6; O=1
3. Molecular formulae of B: C_3H_6O ; Molecular formulae of A: C_3H_6O
4. Molecular formulae A and B are same

5. A and B have different structure formulae.
6. Term that can be used to describe relationship between molecules A and B is isomerism
7. $\text{CH}_3\text{CH}_2\text{CH}_2\text{CH}_2\text{CHO}$ and $\text{CH}_3\text{CH}_2\text{CH}_2\text{CHOCH}_3$
 $\text{CH}_3\text{CH}_2\text{CH}_2\text{CHO}$: and $\text{CH}_3\text{CH}_2\text{CHOCH}_3$

d) Answers to checking up 6.2

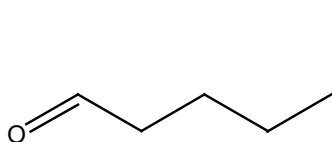

i. pentanal

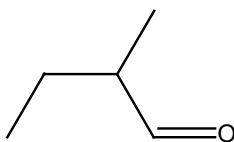

ii. 2-methylbutanal

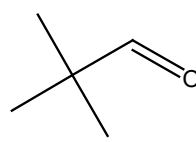

iii. 2,2-dimethylpropanal

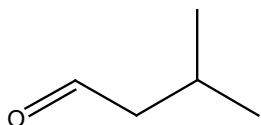

3-methylbutanal

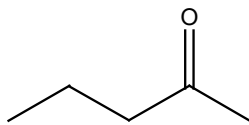

iv. pentan-2-one

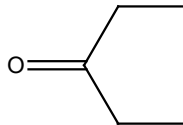

v. pentan-3-one

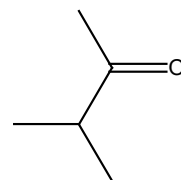

vi. 3-methylbutanone

Lesson 3: Physical properties (80min)

a) Prerequisite/introduction:

The learning of this lesson requires the students to have knowledge on: Covalent bonding and molecular structures (Unit 4, senior 4), Types and origin of intermolecular (van der Waals forces/London dispersion forces, dipole dipole interactions and hydrogen bonding) (Unit 4, senior 4), Heat and temperature, (unit 5, senior3) (30min)

b) Teaching resources:

The teacher will use the following resources:

Molecular models

Chalkboard or whiteboard or Flipcharts

Books from library

Ruler

c) Learning activities

- The teacher will guide students to form groups and select a leader and a secretary
- The teacher will distribute the task of the activity
- The teacher will tell the students to answer related questions by comparing the solubility and of aldehyde and ketone.
- In their group they have to discuss on the shape diagram found while comparing the variation of boiling points of alkanes and alcohols
- And tell them to draw conclusion about their discussion.
- The teacher will limit the time and allow them to present what they discovered
- The group will present the findings and then discuss with other groups
- The teacher will draw conclusion about change in solubility, melting point and boiling points of aldehyde and ketone.

d) Expected answers to the activity 6.3

1. ethanol and propanone have high solubility than butanal
2. van der Waals forces(London dispersion forces), dipole dipole interactions
3. intermolecular force between molecules of water break down by consuming energy and new intermolecular force formed between solute and solvent molecules by releasing energy, if energy released is greater than energy consumed the solubility occur but if is less the solubility doesn't occur.
4. Strong intermolecular forces make substance to have high melting point and boiling points but weak intermolecular force make substance to have low melting point and boiling points.
5. As the number of carbon atoms increases, the boiling point of aldehyde and ketone also increases, this means that the boiling point will increase as the molecular mass increases
6. The boiling point of aldehyde and ketone of the same number of carbon atoms to alkanes is greater.

e) Answers to checking up 6.3

- a) The alkane only has dispersion forces between its molecules, but the aldehyde has permanent dipole-dipole attractions as well.

- b) The alcohol has dispersion forces and dipole-dipole attractions, but also has hydrogen bonds between its molecules.
- c) Aldehydes and ketones can't hydrogen bond with themselves, because they don't have a hydrogen atom attached directly to a very electronegative atom. But they can hydrogen bond with water molecules, forming a hydrogen bond between a lone pair on the oxygen and the fairly positively charged hydrogen on a water molecule. So when you mix a small aldehyde or ketone with water, you have to break hydrogen bonds between the water molecules, but they are replaced by similar bonds involving the aldehyde or ketone.

In the case of an alkane, you don't get hydrogen bonds between it and water, and so the hydrogen bonds in the water can only be replaced by much weaker dispersion forces. It isn't energetically profitable to do this.

- d) As the chains get bigger, you have to break more hydrogen bonds in the water to fit the aldehyde or ketone between the water molecules, but you only get one hydrogen formed in exchange. Mixing becomes less energetically profitable.

Lesson 4: Nucleophilic addition reactions (80min)

a) Prerequisite/introduction:

The learning of this lesson requires the students to have knowledge on: Covalent bonding, pi bond, (Unit 4, senior 4), Functional groups (unit 1, Introduction to organic chemistry S5), and Nucleophilic substitution reaction of halogenoalkanes (unity 4 S5). Give an evaluation on Nucleophilic substitution reaction.

b) Teaching resources:

The teacher will use the following resources:

Molecular models

Chalkboard or whiteboard or Flipcharts

Books from library

c) Learning activities

- The teacher will ask the student to join groups and give them the instructions
- Ask the student to discuss while answering to the activity 6.4.1 in their book

- The teacher will be moving around while helping them to apply the prerequisite
- The teacher will supervise and help the students
- The students will present the work done in their group on the chalk board or white board
- The teacher will harmonize the work done and add the other additional content.

d) Proposed answers to the activity 6.4.1

1. The polar arise because of different in electronegativity between carbon and oxygen
2. CN⁻ will add to carbon with partial positive charge
3. H⁺ will add to oxygen with partial negative charge

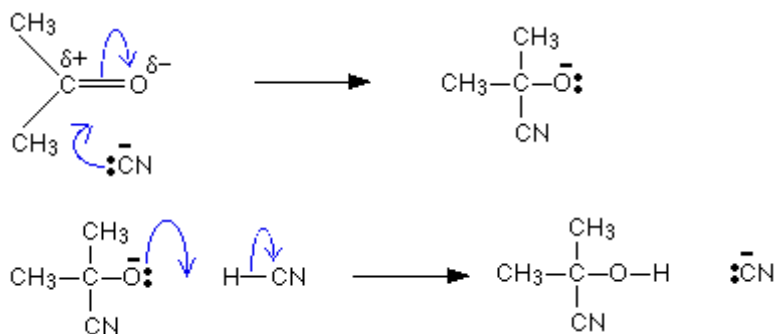

e) Answers to checking up 6.4.1

- a) Hydrogen cyanide is an extremely poisonous gas.
- b) A solution of sodium or potassium cyanide in water with a little dilute sulphuric acid added to give a pH of 4 to 5.
- c) i.

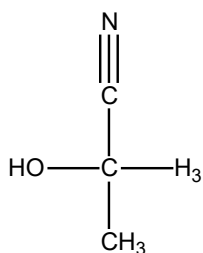

2-hydroxy-2-methylpropanenitrile

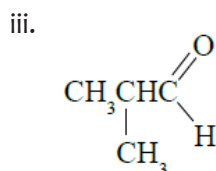
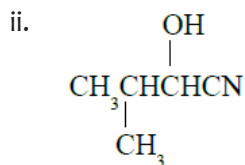

Lesson 5: Condensation reactions (80min).

a) Prerequisite/introduction:

The learning of this lesson requires the students to have knowledge on: Covalent bonding, pi bond, (Unit 4, senior 4), Functional groups (unit 1, Introduction to organic chemistry S5), and types of reactions (unity S2). Give an evaluation on Functional groups.

b) Teaching resources:

The teacher will use the following resources:

- Molecular models
- Chalkboard or whiteboard or Flipcharts
- Books from library

c) Learning activities

- The teacher will ask the student to join groups and give them the instructions
- Ask the student to discuss while answering to the activity 6.4.2 in their book
- The teacher will be moving around while helping them to apply the prerequisite
- The teacher will supervise and help the students
- The students will present the work done in their group on the chalk board or white board
- The teacher will harmonize the work done and add the other additional content while teaching them the other methods similar reactions ask students to use for further information.

d) Proposed answers to the activity 6.4.2

Substance	observations	Deductions
Aldehydes (Ethanal)	A bright orange or yellow precipitate	shows the presence of the carbon-oxygen double bond in an aldehyde or ketone
Ketones (propanone)	A bright orange or yellow precipitate	shows the presence of the carbon-oxygen double bond in an aldehyde or ketone
Alcohol (ethanol)	No change	shows the absence of the carbon-oxygen double bond in an aldehyde or ketone
Glucose	A bright orange or yellow precipitate	shows the presence of the carbon-oxygen double bond in an aldehyde or ketone

- The students will present the work done in their group on the chalk board or white board
- The teacher will harmonize the work done and add the other additional content while teaching them the other methods of preparation of alcohols and ask students to use for further information their book.

e) Answers to checking up 6.4.2

a. If you add a few drops of an unknown compound to Brady's reagent and get a bright orange or yellow precipitate, the compound is an aldehyde or ketone.

b. i)

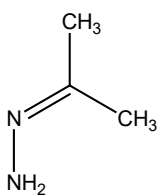

ii)

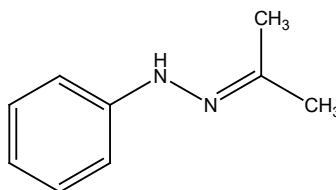

Lesson 6: oxidation reactions using KMnO_4/H^+ and $\text{K}_2\text{Cr}_2\text{O}_7/\text{H}^+$ (80min)

a) Prerequisite:

The learning of this lesson requires the students to have knowledge on: Reduction and oxidation reactions (Unit 4, senior 17), Functional groups (unit 1, Introduction to organic chemistry S5), Give an evaluation on Reduction and oxidation reactions.

b) Teaching resources:

The teacher will use the following resources:

Molecular models

Chalkboard or whiteboard or Flipcharts

Books from library

c) Learning activities

- The teacher will ask the student to join groups and give them the instructions about experiment.
- Ask the student to observe carefully change occur in test tube before answering to the activity 6.5 in their book
- Ask the student to discuss while answering to the activity 6.4.3 in their book
- The teacher will be moving around while helping them to apply the prerequisite
- The teacher will supervise and help the students

d) Proposed answers to the activity 6.4.3

Substance	observations	Deductions
Aldehydes(propanal)	Orange color of $K_2Cr_2O_7$ solution turns green of Cr_3^+ solution.	Presence of aldehyde
Ketones(propanone)	Orange color of $K_2Cr_2O_7$ solution doesn't change.	Absence of aldehyde

e) Answers to checking up 6.4.3

ethanoic acid (CH_3COOH)

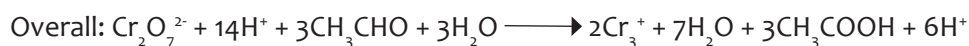
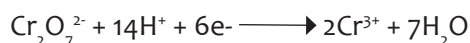
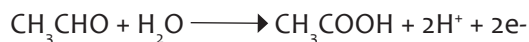

Lesson 7: oxidation reactions using tollens' reagent

a) Prerequisite:

The learning of this lesson requires the students to have knowledge on: Reduction and oxidation reactions (Unit 4, senior 17), Functional groups (unit 1, Introduction to organic chemistry S5), Give an evaluation on Reduction and oxidation reactions.

b) Teaching resources:

The teacher will use the following resources:

Molecular models

Chalkboard or whiteboard or Flipcharts

Books from library

c) Learning activities

- The teacher will ask the student to join groups and give them the instructions about experiment.
- Ask the student to observe carefully change occur in test tube before answering to the activity 6.6 in their book
- Ask the student to discuss while answering to the activity 6.4.4 in their book
- The teacher will be moving around while helping them to apply the prerequisite
- The teacher will supervise and help the students

d) Proposed answers to the activity 6.4.4

Substance	observations	Deductions
Aldehydes (propanal)	The colourless solution produces a grey precipitate of silver, or a silver mirror on the test tube. Reaction occurs.	Presence of aldehyde
Ketones (propanone)	Colourless solution doesn't change. no reaction	Absence of aldehyde
Sugar (glucose)	The colourless solution produces a grey precipitate of silver, or a silver mirror on the test tube. Reaction occurs.	Presence of aldehyde

Proposed answers to checking up 6.4.4

a) Propanoate ions ($\text{CH}_3\text{CH}_2\text{COO}^-$).

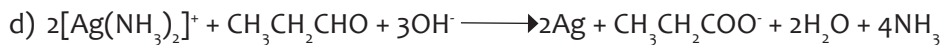
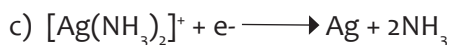

Lesson 8: iodoform reaction with aldehydes and ketones (80minutes)

a) Prerequisite/introduction:

The learning of this lesson requires the students to have knowledge on: Reduction and oxidation reactions (Unit 4, senior 17), Functional groups (unit 1, Introduction to organic chemistry S5), Give an evaluation on Reduction and oxidation reactions.

b) Teaching resources:

The teacher will use the following resources:

Molecular models

Chalkboard or whiteboard or Flipcharts

Books from library

c) Learning activities

- The teacher will ask the student to join groups and give them the instructions about experiment.
- Ask the student to observe carefully change occur in test tube before answering to the activity 6.4.2 in their book
- Ask the student to discuss while answering to the activity 6.4.5 in their book
- The teacher will be moving around while helping them to apply the prerequisite
- The teacher will supervise and help the students

d) Proposed answers to the activity 6.4.5

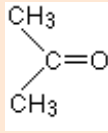
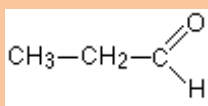
Substance	observations	Deductions
	pale yellow precipitate of iodoform	Presence of methyl group attached to carbonyl functional group
	Colourless solution doesn't change.	Absence of methyl group attached to carbonyl functional group

e) Proposed answers to checking up 6.4.5



Lesson 9: oxidation reactions using Fehling or benedict solution (80minutes)

a) Prerequisite/introduction:

The learning of this lesson requires the students to have knowledge on: Reduction and oxidation reactions (Unit 4, senior 17), Functional groups (unit 1, Introduction to organic chemistry S5), Give an evaluation on Reduction and oxidation reactions.

b) Teaching resources:

The teacher will use the following resources:

Molecular models

Chalkboard or whiteboard or Flipcharts

Books from library

c) Learning activities

- The teacher will ask the student to join groups and give them the instructions about experiment.
- Ask the student to observe carefully change occur in test tube before answering to the activity 6.4.6 in their book
- Ask the student to discuss while answering to the activity 6.6 in their book

- The teacher will be moving around while helping them to apply the prerequisite
- The teacher will supervise and help the students

d) Proposed answers to the activity 6.4.6

Substance	observations	Deductions
Aldehydes (propanal)	The colourless solution produces a grey precipitate of silver, or a silver mirror on the test tube. Reaction occurs.	Presence of aldehyde
Ketones (propanone)	Colourless solution doesn't change. no reaction	Absence of aldehyde

Proposed answer to checking up 6.4.6

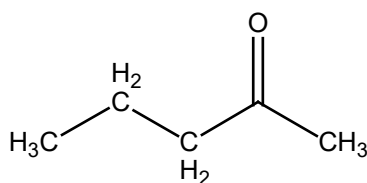

A: pentan-2-one

Lesson 10: Preparation methods of aldehydes and ketones (80minutes)

a) Prerequisite/introduction:

The learning of this lesson requires the students to have knowledge on: Reduction and oxidation reactions (Unit 4, senior 17), Alcohol (Unit 5, s5), Functional groups (unit 1, Introduction to organic chemistry S5), Give an evaluation on oxidation of alkene by KMnO_4/H^+ .

b) Teaching resources:

The teacher will use the following resources:

Molecular models

Chalkboard or whiteboard or Flipcharts

Books from library

c) Learning activities

- The teacher will ask the student to join groups and give them the instructions.
- Ask the students to answer to the activity 6.7 in their book
- Ask the student to discuss while answering to the activity 6.6 in their book
- The teacher will be moving around while helping them to apply the prerequisite
- The teacher will supervise and help the students

d) Proposed answers to the activity 6.5.1

1. Oxidation

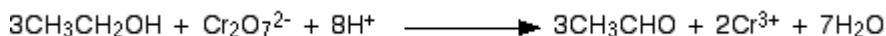

2. Distil off the aldehyde as soon as it forms. Removing the aldehyde as soon as it is formed this means that aldehyde is removed from solution where oxidizing agent is, to prevent further oxidation.

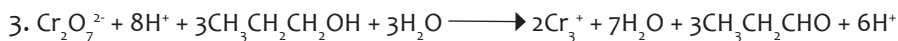

Proposed answers to checking up 6.5

a)

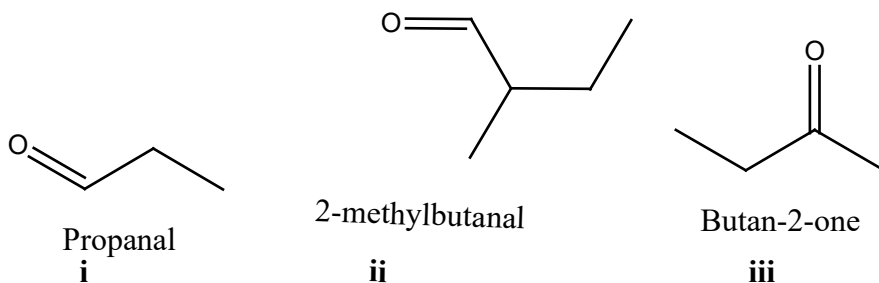

b)

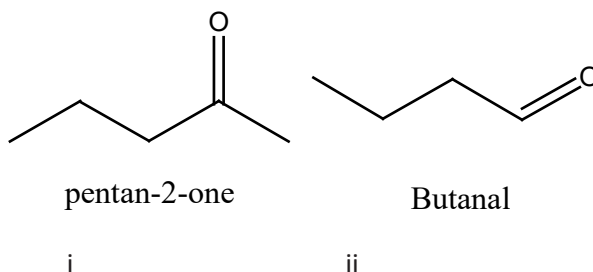

c) You should use $K_2Cr_2O_7$

d) Use an excess of the alcohol than potassium dichromate (VI). Potassium dichromate (VI) is limiting reactant hence there isn't enough oxidising agent present to carry out the second stage of oxidize the aldehyde formed to a carboxylic acid.

Distil off the aldehyde as soon as it forms. Removing the aldehyde as soon as it is formed this means that aldehyde is removed from solution where oxidizing agent is, to prevent further oxidation.

6.7. SUMMARY OF THE UNIT

The carbonyl group, $C=O$, is present in aldehyde and ketone. In aldehyde is in a terminal position in the carbon chain. In ketone is in a non-terminal position.

Aldehydes and ketones are named using the suffixes "al" and "one", respectively.

The carbonyl group undergoes nucleophilic addition. This is sometimes followed by the elimination of a small like water, resulting in a condensation reaction.

Aldehydes are generally more reactive than ketones. Aldehyde can be oxidized by to carboxylic acids by variety reagents like acidified potassium chromate, Tollens reagent, Fehling reagent. Ketones are not readily oxidized.

Carbonyl group activates the methyl hydrogen on neighbouring carbon atoms, making them more readily substituted than those in alkanes.

Aldehydes are prepared by oxidizing primary alcohol and ketones are prepared by oxidizing secondary alcohol.

The following table represents important reactions of aldehyde and ketone

Reagent	Reaction type	Product from ethanal	Product from Propanone
HCN	Addition	$H_3C-CH \begin{array}{l} \nearrow OH \\ \searrow CN \end{array}$	$H_3C-\overset{\overset{OH}{ }}{\underset{\underset{CN}{ }}{C}}-CH_3$
NaHSO ₃	Addition	$H_3C-CH \begin{array}{l} \nearrow OH \\ \searrow SO_3Na \end{array}$	$H_3C-\overset{\overset{OH}{ }}{\underset{\underset{SO_3Na}{ }}{C}}-CH_3$
NH ₂ OH	Condensation	$H_3C-\overset{\overset{H}{ }}{C}=\overset{\overset{H}{ }}{N}OH$	$H_3C-\overset{\overset{H}{ }}{\underset{\underset{NOH}{ }}{C}}-CH_3$

NH_2NH_2	Condensation	$\text{H}_3\text{C}-\underset{\text{H}}{\text{C}}=\text{NNH}_2$	$\text{H}_3\text{C}-\underset{\text{NN}_2}{\text{C}}-\text{CH}_3$
2,4-Dinitrophenyl hydrazine	Condensation	Yellow precipitate of combination ethanal and 2,4-Dinitrophenyl hydrazine	Yellow precipitate of combination ethanal and 2,4-Dinitrophenyl hydrazine
Tollens reagent	Oxidation	CH_3COOH	No reaction
Fehling reagent or Benedict's reagent	Oxidation	CH_3COOH	No reaction
I_2/OH^-	Iodoform reaction	Yellow precipitate of CHI_3	Yellow precipitate of CHI_3

6.8 ADDITIONAL INFORMATION FOR TEACHER

a. The Cannizzaro reaction

The Cannizzaro reaction is an example of Disproportionation reaction in which two molecules of an aldehyde are reacted to produce a primary alcohol and a carboxylic acid in presence of base like NaOH or KOH.

Example:

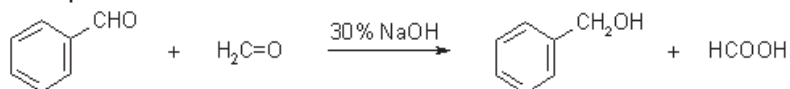

b. The reduction of an aldehyde

Reducing agent used are tetrahydridoaluminate or sodium tetrahydridoborate.

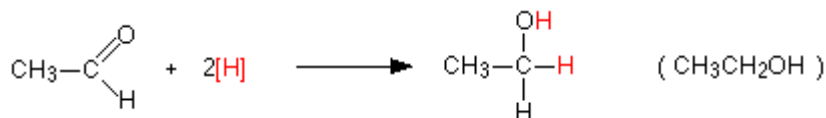

Where $[\text{H}]$ is "hydrogen from a reducing agent"; tetrahydridoaluminate or sodium tetrahydridoborate. In general terms, reduction of an aldehyde leads to a primary alcohol.

c. The reduction of a ketone

Reduction of a ketone leads to a secondary alcohol. The product is the same whichever of the two reducing agents you use.

For example

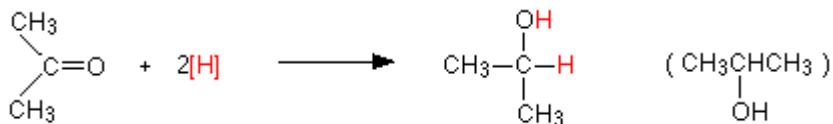

d. The reduction of a carboxylic acid

The reaction takes place in two stages:

1st an aldehyde is formed and 2nd a primary alcohol. Because lithium tetrahydridoaluminate reacts rapidly with aldehydes, it is impossible to stop reaction at the aldehyde. This reason why aldehydes don't be prepared by reduction of carboxylic acid method, equation for reaction is:



Where [H] represent "hydrogen from a reducing agent"; tetrahydridoaluminate; the sodium tetrahydridoborate isn't reactive enough to reduce carboxylic acids.

6.9 END UNIT ASSESSMENT

1. An aliphatic aldehyde **A** has the formula RCHO .
 - a. **A** react with 2,4-dinitrophenylhydrazine. Explain what happens and name the type of reaction. Say how the product of reaction could be used to identify **A**
 - b. When **A** is treated with warm, acidified $\text{K}_2\text{Cr}_2\text{O}_7$ solution, **B** is formed. Give the structural formula of **B**.
 - c. When **A** is treated with lithium tetrahydridoaluminate (reducing agent) in ethoxyethane solution **C** is formed. Give the structural formula of **C**.
 - d. **A** is warmed gently with ammoniacal silver nitrate. Explain what happens, and says what is observed.
 - e. **B** and **C** react to form **D**. write the structural formula of **D**.
 - f. Of the compounds **A**, **B**, **C**, and **D**, which would you expect to have
 - i. Highest boiling point
 - ii. Lowest boiling point

Answer

- a. **A** must be an aldehyde RCHO , not ketone, **A** is oxidized to **B**, a carboxylic acid, RCOOH
- b. **A** is reduced to alcohol, **C**, RCH_2OH .

c. **A** reduce Ag^+ to Ag . **A** is oxidized to **B**

d. $\text{RCO}_2\text{CH}_2\text{R}$

i. RCOOH : strong hydrogen bonds between the molecules.

ii. RCOOCH_2R there is no way to form hydrogen bonds.

2. a. Three compounds **E**, **F**, and **G** all have the molecular formula $\text{C}_3\text{H}_6\text{O}$. **E** is an alcohol, **F** is ketone and **G** is aldehyde.

i. Draw all possible structural formulae for **E**, **F**, and **G**.

ii. Describe tests (reagents and conditions and observations with each compounds) that would allow you to show that.

1. **E** is an alcohol whereas **F** and **G** aren't

2. **F** and **G** are carbonyl compounds whereas **E** isn't

3. **G** is aldehyde, whereas **E** and **F** aren't.

4. Write balanced equations for all reactions that occur.

b. One of the compounds responsible for the flavor of butter is butane-2,3-dione.

Give the structural formula butane-2,3-dione.

Give the structural formula of the organic products formed when butane-2,3-dione react with

i. H_2/Ni

ii. I_2/OH^-

Answer

a) i. $\text{E} = \text{CH}_3\text{CH}=\text{CHOH}$ or $\text{CH}_2=\text{CHCH}_2\text{OH}$

$\text{F} = \text{CH}_3\text{COCH}_3$, $\text{G} = \text{CH}_3\text{CH}_2\text{CHO}$

ii.

1. With $\text{CH}_3\text{COOH} + \text{conc } \text{H}_2\text{SO}_4$ gives a sweet-smelling ester; **F** and **G**, **F** and **G** don't react.

2. With 2,4-Dinitrophenylhydrazine **F** and **G** give yellow precipitate, **E** doesn't react.

3. With Tollens reagent, **G** give silver mirror; **E** and **F** don't react.

i.

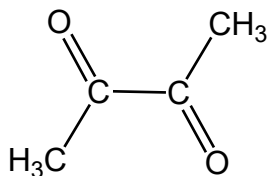

Butane-2,3-dione

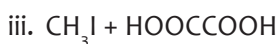

3. Carbonyl compounds **X** undergoes the following reactions

X gives an orange precipitate with 2, 4-dinitrophenylhydrazine.

X gives pale yellow precipitate with mixture of potassium iodide and sodium iodate(I)

X Doesn't react with warm acidified $\text{K}_2\text{Cr}_2\text{O}_7$ solution.

X doesn't react with aqueous bromine.

X is reduced by hydrogen in the presence of catalyst to a mixture of isomers **Y** and **Z** of formula $\text{C}_4\text{H}_{10}\text{O}$. Identify **X**, and give the structural formulae of **X**, **Y** and **Z**.

Answer

The evidence shows: **x** is a carbonyl compound (adds 2,4-Dinitrophenylhydrazine). **X** contains a CH_3CO - group (gives positive iodoform test). It isn't aldehyde. It has no $\text{C}=\text{C}$ bond (doesn't Br_2)

Hydrogen must reduce $\text{C}=\text{O}$ group to $>\text{CHOH}$.

X is $\text{CH}_3\text{C}^*\text{OCH}_2\text{CH}_3$, **Y** and **Z** is $\text{CH}_3\text{C}^*\text{HOCH}_2\text{CH}_3$. Since C^* is chiral, a mixture of stereoisomerisms is formed.

4.

P has the formula $\text{C}_5\text{H}_8\text{O}_2$. It forms a compound by reaction with hydrogen cyanide which has the formula $\text{C}_7\text{H}_{10}\text{O}_2\text{N}_2$. **P** gives a positive iodoform test, a silver mirror with Tollens' reagent and can be reduced to pentane. What is **P**?

Answer



5.

Warfarin is an oral anticoagulant, a drug that inhibits the clotting of blood. It prevents the formation of blood clots by reducing the production of factors by the liver that promote clotting, factors II, VII, IX, and X, and the anticoagulant proteins C and S. The structural formula of Warfarin is:

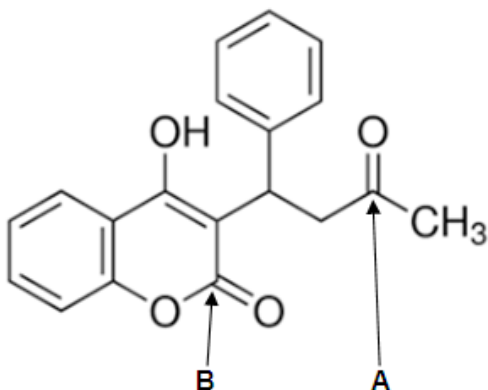

- Name any three different functional groups present in the Warfarin molecule
- State what would be expected to be observed is treated under appropriate conditions with each of the following reagents. In each case give a reason for your prediction
 - Bromine in tetrachloromethane in absence of Lewis acid.
 - Iodine and aqueous solutions of NaOH.
- The structural shows two groups the carbon atoms of which are labeled **A** and **B**

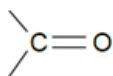

State how many molecules of 2, 4-dinitrophenylhydrazine would react with one molecule of Warfarin. Give a reason for your answer.

- State, giving a reason, whether you would expect Warfarin to reduce Tollens reagent.

Answer

A. Ketone, Alkene, Alcohol, Ester

B.

- i. Red change to colorless
- ii. Formation of yellow precipitate

C.

- i. One, there is one functional group of ketone
- ii. No. Warfarin doesn't reduce to Tollens reagent.

6.

- a) Draw the structure of hydroxylamine.
- b) Draw the structure of the organic product of the reaction between hydroxylamine and propanone.

Answer

a)

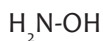

b)

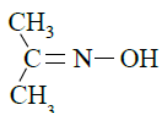

6.10. ADDITIONAL ACTIVITIES

6.10.1 Remedial activities

Which of the following compounds will react with Tollens reagent?

- a) $\text{CH}_3\text{-CHO}$
- b) $\text{CH}_3\text{-COOH}$
- c) $\text{CH}_3\text{-CH-CH}_3$
- d) $\text{CH}_3\text{-CO-CH}_2\text{-CH}_3$

2.

Primary alcohol is gently heated to produce aldehyde in presence of solution of acidified

- a) hydroxide

- b) dichromate
- c) ethanol
- d) all of them

Further addition of ethanol will lead to different product as

- a) ethanoic acid
- b) ketones
- c) benzaldehyde
- d) all of them

Acetone reacts with HCN to form a cyanohydrin. It is an example of

- electrophilic addition
- nucleophilic addition
- electrophilic substitution
- nucleophilic substitution

Which of the following substances does not give iodoform test?

- a) Methyl alcohol
- b) Ethanal
- c) Propanone

6.10. ADDITIONAL ACTIVITIES

6.10.1 Remedial activities

1. Which of the following compounds will react with Tollens reagent?

- a) $\text{CH}_3\text{-CHO}$
- b) $\text{CH}_3\text{-COOH}$
- c) $\text{CH}_3\text{-CH-CH}_3$
- d) $\text{CH}_3\text{-CO-CH}_2\text{-CH}_3$

2. Primary alcohol is gently heated to produce aldehyde in presence of solution of acidified

- a) hydroxide
- b) dichromate
- c) ethanol

- d) all of them
3. Further addition of ethanol will lead to different product as
- a) ethanoic acid
 - b) ketones
 - c) benzaldehyde
 - d) all of them
4. Acetone reacts with HCN to form a cyanohydrin. It is an example of
- a) electrophilic addition
 - b) nucleophilic addition
 - c) electrophilic substitution
 - d) nucleophilic substitution
5. Which of the following substances does not give iodoform test?
- a) Methyl alcohol
 - b) Ethanal
 - c) Propanone
 - d) Propanal
6. Which of the following will have the highest boiling point?
- a) Methanol
 - b) Propanol
 - c) Ethanol
 - d) Hexanone
7. Which of the following reaction is not shown by ketones?
- a) Reaction with HCN
 - b) Reaction with 2,4-dinitrophenyl hydrazine
 - c) Reaction with NaHSO_3
 - d) Reaction with Fehling solution

Answers of remedial activities

	Q1	Q2	Q3	Q4	Q5	Q6	Q7
Answer	a	B	a	b	d	d	d

6.10.2 Consolidation activities

1. An organic compound, A, of molecular formula $C_2H_4O_2$ contains two functional groups.

a) The first functional group was tested as follows:

i) The dry compound, A, reacts with sodium to give hydrogen gas and a compound of molecular formula $C_2H_3O_2Na$.

ii) When A was heated with ethanoic acid and a few drops of concentrated sulphuric acid the product, of molecular formula $C_4H_6O_3$, had a sweet smell.

Give the formula and name of the first functional group

Give the name of the functional group formed in (a) (ii) above.

b) The second functional group was tested as follows

i) A few drops of A were added to 2,4-dinitrophenyl hydrazine which gave a yellow/ orange precipitate.

ii) One drop of A was mixed with a solution containing $[Ag(NH_3)_2]^+$ (Tollen's reagent) and warmed. A deposit of silver was formed on the inner sides of the test tube.

Give the name and the formula of the second functional group.

c) Give the structural formula for compound A.

d) Give the structural formulae of two possible geometric isomers of molecular formula $C_2H_4O_2$.

e) Compound A is oxidized to give an acid of molecular formula $C_2H_2O_4$. Give the structural formula of $C_2H_2O_4$,

f) Compound A is reduced to give a compound of molecular formula $C_2H_6O_2$. Give the structural formula of $C_2H_6O_2$.

g) Suggest the formula of the compound formed by reacting $C_2H_6O_2$, with excess HBr.

h) Give the structural formula of a possible compound formed when one mole of $C_2H_6O_2$, reacts with two moles of ethanoic acid.

Answers:

a) First functional group; Alcohol

In a (ii), An ester is formed:

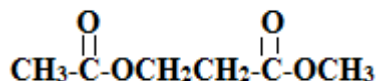
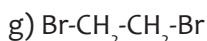
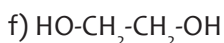
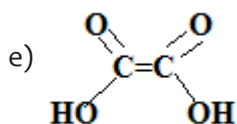
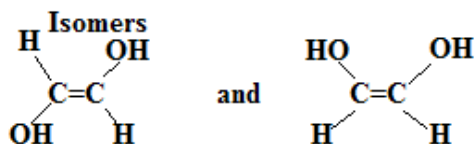
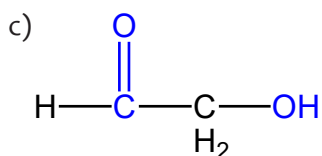
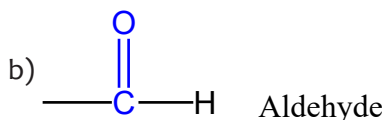
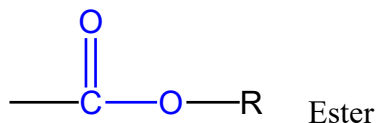

2. a) The formation of a triiodomethane precipitate from a ketone such as propanone happens in two stages. In the first stage, iodine in the presence of hydroxide ions replaces the hydrogens in one of the CH₃ groups. Write the ionic equation for this reaction.

b) In the second stage, there is a further reaction involving a hydroxide ion in which the iodine containing group is broken off to form triiodomethane. Write the ionic equation for this reaction.

c) Combine the equations you have written in (a) and (b) to give the overall equation for the reaction.

Answers:

3. Carbonyl compounds contain the carbon-oxygen double bond, C=O. The simplest one is methanal:

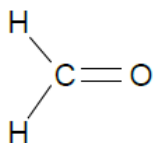

This question is about the bonding in methanal.

a) Write the electronic structure for a carbon atom in its ground (unexcited) state.

b) Describe the changes to the electronic structure of the carbon before it bonds to the oxygen and hydrogens. Use diagrams where necessary.

c) Write the electronic structure for an oxygen atom in its ground state.

d) Describe the changes to the electronic structure of the oxygen before it bonds to the carbon. Use diagrams where necessary.

e) Describe what happens when the carbon bonds with the hydrogens and oxygen, using diagrams where necessary. Explain why the arrangement of electrons between the carbon and the oxygen isn't exactly the same as the arrangement of the electrons in a carbon-carbon double bond

Answers

a) $1s^2 2s^2 2p^2$

b) One of the 2s electrons is promoted by moving it into the slightly higher energy 2p_z orbital to give the structure $1s^2 2s^1 2p^3$.

Each carbon atom has to join to three other things (two hydrogen atoms and an oxygen atom). It reorganises 3 of its s and p electrons into 3 sp² hybrid orbitals with the same shape and energy. The other p orbital is left unchanged.

The sp² hybrids arrange themselves as far apart as possible with the remaining p orbital at right angles to them.

c) $1s^2 2s^2 2p^4$

d) Hybridisation occurs to give three sp² hybrid orbitals and an unchanged p orbital.

Two of the hybrid orbitals have lone pairs in them

Sigma bonds are formed between two of the sp^2 hybrid orbitals on the carbon and the two hydrogen atoms, and between the remaining sp^2 orbital on the carbon and the one on the oxygen.

Finally, a pi bond is made by sideways overlap between the p orbitals. Because the oxygen is more electronegative than the carbon, the electrons in the pi bond are distorted so that they spend more time at the oxygen end of the bond. That is different from the more even distribution in a carbon-carbon double bond.

6.10.3 Extended activities

The reaction is done by shaking a ketone containing at least one methyl group or any aldehyde with a saturated solution of sodium hydrogensulphite in water.

a) What would you see if a reaction occurred?

b) Write the equation for the reaction between propanone and sodium hydrogensulphite showing the essential structure of the product. You don't need to show the structure of the sulphur-containing group.

c) How can this reaction be used during the purification of an aldehyde?

Answers

a)

A white crystalline precipitate.

b)

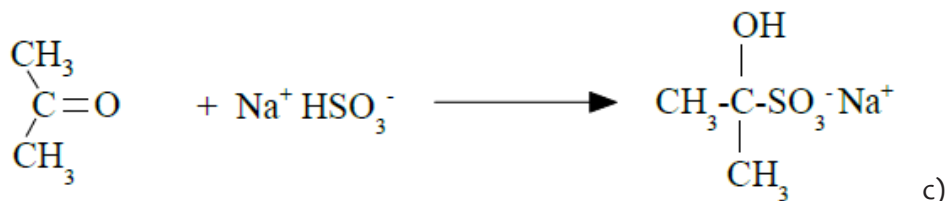

Shake the impure aldehyde with sodium hydrogensulphite solution to produce the crystals. Filter and wash the crystals, and then add a dilute acid or alkali to regenerate the aldehyde.

5.

Draw the structural formulae for

- Propanone hydrazone
- Propanone phenylhydrazone
- Pentan-2-one phenylhydrazone
- Butanone 2,4-dinitrophenylhydrazone

Answers

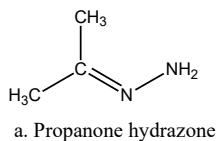

a. Propanone hydrazone

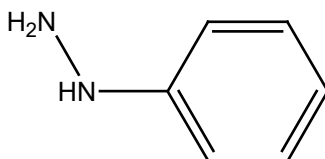

b. Propanone phenylhydrazone

b. Propanone phenylhydrazone

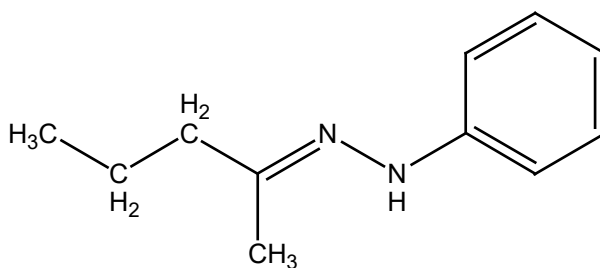

c. Pentan-2-one phenylhydrazone

c. Pentan-2-one phenylhydrazone

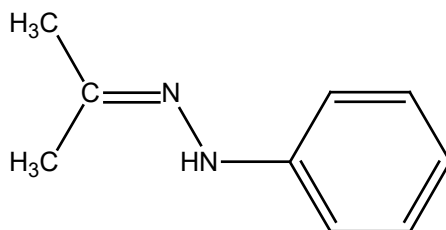

b. Propanone phenylhydrazone

d. Propanone phenylhydrazone

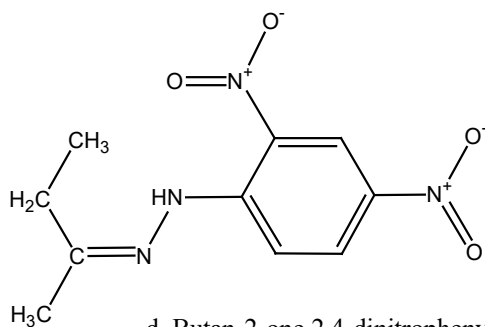

d. Butan-2-one 2,4-dinitrophenylhydrazone

UNIT 7: CARBOXYLIC ACIDS AND ACYL CHLORIDES

7

7.1. Key unit competence

The learner should be able to compare the chemical nature of the carboxylic acids and acid halides to their reactivity

7.2. Prerequisite

In general, the study of carboxylic acids acyl chlorides will require the prior knowledge about general IUPAC rules that are used in the nomenclature of organic compounds, types of formulae that are used to represent organic compounds, inductive effects of different atoms and group of atoms, diverse ways of bond fission and types of reaction mechanism.

7.3. Cross-cutting issues to be addressed

The cross-cutting issues that can be addressed in this unit are specifically:

- **Gender**

The teacher has always to mind about the gender balance in assignment of roles during learning activities. He/she must make sure that both genders are represented and avoid using examples that minimize/praise any of them (boys or girls).

- **Financial education**

In the lesson 7.9, about uses of carboxylic acids, the teacher must emphasize on industrial applications of carboxylic acids, where they are used to manufacture many more useful products such as pharmaceuticals, foods and drinks which are sources of income for many business owners. This cross-cutting issue should be addressed at the end of the lesson 7.9, not as the focus of the lesson. It has also to be underlined that in the laboratory students should avoid wasting chemicals. They must use them economically.

7.4. Guidance on introductory activity

This activity has the objective of making students think critically about the phenomenon and the observations they always encounter in their daily life. Then they try to interpret

those observations by using scientific concepts. To help the students in this regard, the teacher will start by challenging the students with the questions given in introductory activity as a way of awakening their curiosity. Here students will give diverse opinions, but at the end the teacher will guide them towards a collective understanding.

Answers to introductory activity

1. Fresh juice taste is sweet, but after some time the taste changes to sour, the same is observed for milk. The explanation is that after some time in either juice or fresh milk glucose undergo fermentation that forms ethanol which gets oxidized by oxygen in air to form acetic acid. It is the one responsible for the sour taste.
2. a) The ants' sting causes an injury of the part of the body affected.
 b) Ants inject formic acid (methanoic acid) in the part their stings and it is that acid that is responsible for the swelling and painful sensation.
 a) They are used to burn the vegetables so that they can be a little bit soft and to change the vegetables' taste.
 b) They burn the vegetables because of their acidity and the same property is responsible for their sour taste.
 c) They all have carboxylic functional group -COOH , in their structure.

7.5. List of lessons

Lesson No	Lesson title	Learning objectives	Number of periods
1	Nomenclature and isomerism	Apply the IUPAC rules to name different carboxylic acids Write the structural formula and isomers of the carboxylic acids.	2
2	Physical properties of Carboxylic acids	Explain the physical properties and uses of the carboxylic acids and acyl chlorides. Compare the physical properties of the carboxylic acids to those of alcohols.	2

3	Acidity of carboxylic acids	Describe the inductive effect on the acidity of the carboxylic acids.	2
4	Preparation of carboxylic acids	Prepare carboxylic acids from oxidation of aldehydes or primary alcohols.	2
5	Reactions of carboxylic acids	Explain the reactions of the carboxylic acids Outline the mechanisms of esterification. Distinguish between the carboxylic acids from other organic compounds using appropriate chemical test.	2
6	Uses of carboxylic acid	Appreciate the uses of the carboxylic acids as the intermediate compounds in the industrial processes such as aspirin, vinegar and perfumes	1
7	Acyl chlorides and nomenclature	Apply IUPAC rules to name acyl chlorides	1
8	Physical properties of acyl chlorides	Explain the physical properties acyl chlorides.	1
9	Reactions of acyl chlorides	Outline the mechanisms of esterification of reaction of acyl chlorides with ammonia, amines and alcohols.	2
10	Summative assessment		2

7.6. Guidance on the lessons

Lesson 1: Nomenclature and isomerism (80 minutes)

a) Introduction

Carboxylic acids consist of organic compounds that are characterized by the carboxyl functional group in their structure. The study of carboxylic acids requires a prior knowledge of:

- IUPAC general rules of naming organic compounds that will help student in the nomenclature of carboxylic acids. This was studied in senior 5, unit 1.
- Isomerism and types of isomerism in organic compounds that was seen in senior 5, unit one.

- Different formulae that used to represent organic compounds discussed in senior 5, unit 1 are important to represent diverse molecules of carboxylic acids.

b) Teaching resources

The teaching and learning resources that are needed for this lesson are:

Student's textbooks

Chalk board and pieces of chalk

c) Learning activities

Guidance

- Since it is not their first time to deal with nomenclature and isomerism of organic compounds, start by giving students the questions in activity 7.1. for them to discuss in small groups of five or six students.
- Students should apply general rules of naming organic compounds in naming carboxylic acids given and identify the types of isomers that are possible in carboxylic acids.
- After discussion, students will be asked to suggest their answers from which the teacher will build his/her whole lesson by simply emphasizing on the points where students demonstrated some difficulties.
- Focus on the fact that the side branches and substituents on the carboxylic longest carbon chain are given position by starting from the carboxylic functional group.
- Clearly explain how optical isomers arise in carboxylic acids and how to distinguish them by using plane polarized light in a polarimeter.

Answers to activity 7.1.

1.

- Ethanoic acid
- 2-Methylpropanoic acid
- Methanoic acid
- Etanedioic acid
- 2-Methylbutanoic acid
- $\text{CH}_3\text{C}(\text{CH}_2)_2\text{COOH}$
- $\text{CH}_3\text{CH}(\text{CH}_3)\text{CH}_2\text{COOH}$

2.

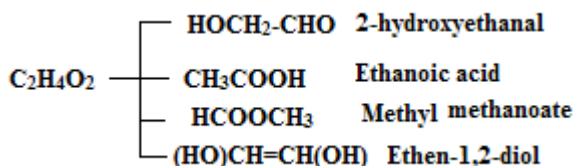

3.

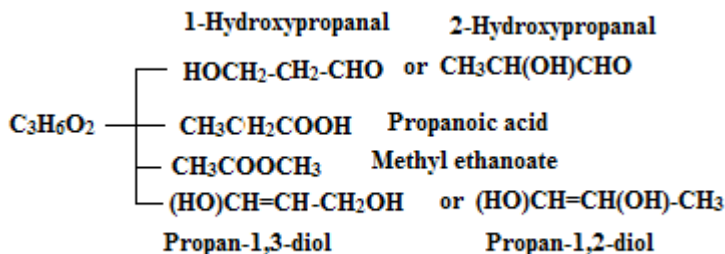

4. a) One is the mirror-image of one another and they non-superimposable like right and left hands.

b) They can be distinguished using a polarimeter, where L-lactic acid rotates plane polarized light to left and D-lactic acid rotates plane polarized light to the right.

d) Checking up activity

The teacher will give the evaluation questions in checking up activity 7.1 to individual students and finally ask them to exchange their exercise book for peer marking. This will be done about what they will have corrected on the chalk board, together as a whole class.

Answers to checking up 7.1.

- $CH_3-CH_2-CH(CH_3)-CH_2-COOH$
- $HOOC-CH(CH_3)-CH_2-CH_2-CH_2-COOH$

1.

- 6-Methylhept-4-enoic acid
- 3-Hydroxybutanoic acid

2.

- Functional group isomers

b. Chain isomers

3.

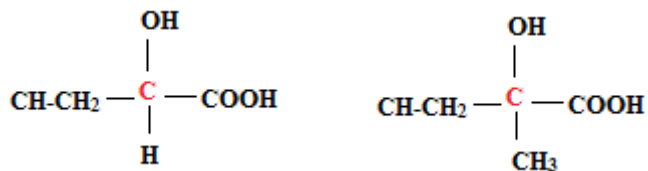

4. and

are optically active because they have asymmetric carbon (in red).

Lesson 2: Physical properties of carboxylic acids (80minutes)

a) Introduction

Physical properties of chemical substances in general are determined either by the chemical bonds, the structure or the intermolecular forces. To understand the physical properties of carboxylic acids requires a prior knowledge of:

- » Chemical bonding and structure of molecules which were studied in unit 3 and 4 of senior 4
- » Type of intermolecular forces learnt in unit 4 of senior 4.

b) Teaching resources

The teaching and learning resources that are needed for this lesson are:

- Student's textbooks
- Chalk board and pieces of chalk
- Samples of carboxylic acids such as acetic acid/vinegar

c) Learning activities

Guidance

- Start the lesson by asking students to brainstorm the answers and their ideas about the questions in activity 7.2. The questions are asked to the class and students can give their own ideas.

- Put the focus on the fact that molecules held together by strong intermolecular forces are likely to be liquids and solids, they also have high melting and boiling points.
- Use the answers given to compare the boiling and melting points of carboxylic acids with those of alcohols and other homologous series learnt in the previous units.
- Emphasize on the dimeric structure of molecules of carboxylic acids because of double hydrogen bonds. Highlight that this fact makes carboxylic acids have higher boiling and melting points than alcohols even though they all interact by hydrogen bonding as intermolecular forces.

Answers to activity 7.2.

1. Consider the ideas that the balls held together strong metallic wire are hard to be separated. They require more energy.
2. Refer to student book
3. Refer to student book

d) Checking up activities

Ask students to discuss the questions in checking up point 7.2. The activity will be conducted in a way that students work in pairs to ensure that there are active discussions among students. Then collect different answers from diverse groups and after the groups will exchange the worksheets for peer marking with reference to answers the whole class has agreed on. This will help the teacher to evaluate the achievement of his/her objectives by seeing how conversant the students are with doing these questions.

Answers to checking up 7.2.

1. Octadecanoic acid has higher melting point because it has greater molecular mass (greater size) than that of hexadecenoic acid. Van der Waals forces become stronger as the molecular mass of the molecule increases.
2. Butanoic acid has higher boiling point than that of pentan-2-one because of two main reasons:
 - Butanoic acid molecules interact with strong hydrogen bonds while pentan-2-one molecules interact with Van der Waals forces (dipole-dipole interactions) that are weaker.
 - Butanoic acid has greater molecular mass than that of pentan-2-one, which also favor the stronger Van der Waals forces in butanoic acid.
3. Yes, butanoic acid has higher solubility in water than butan-1-ol because carboxylic acids form stronger hydrogen bonds with the molecules of water.

Lesson 3: Acidity of carboxylic acids (80minutes)

a) Introduction

Acidity is one of the important chemical properties of carboxylic acids which can easily be understood after that the following concepts have been covered because they are prerequisite knowledge of this lesson:

Acid-base theories, unit 16 in senior four.

Positive and negative inductive effects of diverse atoms or group of atoms.

b) Teaching resources

The teaching and learning resources that are needed for this lesson are:

- Student's textbooks
- Chalk board and pieces of chalk
- Samples of carboxylic acids such as acetic acid/vinegar
- Methyl orange indicator/litmus paper
- Strong mineral acids (HCl or H₂SO₄)

d) Learning activities

Guidance

- To effectively conduct this activity, the teacher starts by asking students to tell the characteristics of an acidic substances as in question 1 of activity 7.3. He/she allows students to brainstorm what they think about an acidic substance.
- For the practical activity, the teacher groups the students appropriately, a group of more than 6 students would be very large. The group should be heterogeneous in a way that boys and girls, brilliant and slow learner are mixed.
- The teacher provides students with indicated apparatus and chemicals; and ask them to follow the procedure suggested in the student's book while carrying out activity 7.3. After that diverse groups have presented their findings, ask the students to evaluate the productions; the teacher judges the logic of the students' products, corrects those which are false, completes those which are incomplete, and confirms those which correct.
- It must also be explained that the strength of the acidity depends on the atoms or group atoms that are in the molecule, if they have a positive inductive effect or a negative inductive effect. Here relevant examples are

needed to explain this concept (see student's book, lesson 7.3).

Answers to activity 7.3.

1. Carboxylic acids:

- Have a sour test
- Have ionizable hydrogen
- Can release hydrogen ions in aqueous solution
- Accepts lone pair of electrons
- Are proton donors
- Have effect on indicators

2.

a) Arrhenius acid releases hydrogen ions in aqueous solution

b) Bronsted-Lowry acid is a proton donor

c) Lewis acid is lone pair of electrons acceptor

3. Both theories well define the acidity of carboxylic acids:

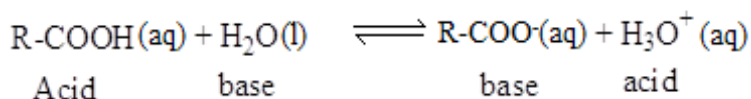

4. For this activity, group students appropriately, a group of more than 6 students would be very large. Then provide them with indicated apparatus and chemicals; and ask them to follow the procedure suggested. Emphasize on the following points:

- Carboxylic acids have acidic properties as mineral acids. Their solutions, all change blue litmus/methyl orange indicator to red
- Carboxylic acids are weaker acids than most of mineral acids. The intensity of the color is different.

d) Checking up activities

The teacher asks students to do questions in checking up 7.3. The activity will be conducted in a way that two or three students work together to ensure that there are active discussions among students. Then the teacher will collect different answers from diverse groups and after the groups will exchange the worksheets for peer marking with reference to answers that the whole class has agreed on.

Answers to checking up 7.3.

1. Refer to student book, section about electron resonance in carboxylate ion.
2.
 - a. Refer to student book section 7.2 about positive inductive effect of alkyl groups.
 - b. Refer to student book section 7.2 about negative inductive effect of halogens.
3. The increasing order of the acidity strength follows the same order of increasing acid dissociation constant, as:

Butanoic acid < 4-chlorobutanoic acid < 3-chlorobutanoic acid < 2-chlorobutanoic acid

The explanation by using the location of the chloro-group which has negative inductive effect can also be used.

Lesson 4: Preparations of carboxylic acids

a) Introduction

Carboxylic acids are commonly prepared from the oxidation of alcohols and aldehydes or by hydrolysis of diverse acids' derivatives such as acyl chlorides, acid anhydrides, and esters.

- Oxidation of alcohols seen in unit 5, senior five.
- Oxidation of aldehydes seen in unit 6, senior five.
- Reactions of organomagnesium with carbon dioxide followed by hydrolysis in acidic medium.
- Hydrolysis of nitriles in acidic/alkaline medium.
- Cleavage oxidation of alkenes seen in unit 3, senior five.

b) Teaching resources

The teaching and learning resources that are needed for this lesson are:

- Student's textbooks
- Chalk board and pieces of chalk

c) Learning activities

Guidance

- This activity 7.4 can be carried out in a way that the teacher starts developing an awareness of the students about the need of preparing carboxylic acids by asking them question 1 of activity 7.4.
- He continues by guiding them to realize that they might already know some methods of preparation of carboxylic acids that they learnt in previous units. He/she asks them to have discussions in their groups and come up with some answers about question 2 of the activity 7.4.
- Ask students to present the results of their group discussions to the whole class.
- Then to the methods that students will have suggested during presentations add more others which are in the student's book, lesson 7.4. Emphasize on the fact that in case of carboxylation of organomagnesium compound or reaction of metal cyanides with alkyl halides, the carboxylic acid formed has one carbon atom more than those of the starting organic compound.

Answers to activity 7.4.

1. There is no specific correct answer, accept any relevant opinion of the student.
2. Refer to the student book section 7.4 about preparation of carboxylic acids. The students may suggest some of the methods given this content (specifically oxidation of alcohols and aldehydes).

d) Checking up activity

The questions in the checking up 7.4 which are found in student's book are given to students and they are asked to do them individually in their exercises books. The role of the teacher in this activity will be to assist those who prove the difficulties.

Answers to checking up 7.4.

Two stages preparation of propanoic acid from bromoethane.

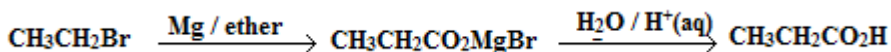

Or

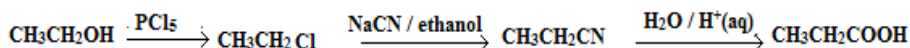
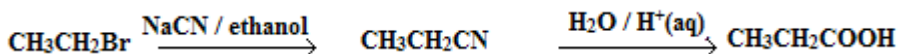

Or

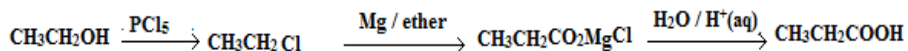

Banana beer tastes sour after some time because ethanol in banana beer gets oxidized by oxygen into ethanoic acid which is responsible for the sour taste.

Lesson 5: Reactions of carboxylic acids (80 minutes)

a) Introduction

The reactions of carboxylic acids are classified into three main categories depending on the part of carboxylic acid that reacts: the reactions that break the O-H bond, the reactions that break the C-O bond and the reaction that concerns the carbonyl group. The reactions of carboxylic acids require the prior knowledge of:

- Acid-base reactions (neutralization reactions), seen two.
- Oxidation-reduction reactions, seen in unit 17 of senior 4.
- Reactions of alcohols (reaction with PCl_5 , SOCl_2 and esterification reaction) seen in unit 4, senior five.

b) Teaching resources

The teaching and learning resources that are needed for this lesson are:

- Student's textbooks
- Chalk board and pieces of chalk
- Chemicals: sodium carbonate, lime water and acetic acid
- Apparatus: test tubes, rubber stopper and delivery tubes

c) Learning activities

Guidance

- This activity 7.5 starts by the teacher who creates an awareness of the students about the usefulness of the reactions of carboxylic acids in synthesis of many more useful materials (question 1 and 2 of activity 7.5).
- The teacher asks the students to discuss question 3 of activity 7.5 in groups of 5 or 6 students. Here the objective is to give students the opportunity of using the knowledge they have acquired in previous units as it was indicated in prerequisite knowledge.
- Students will present the results of the group discussions from which the teacher will build her/his lesson.

- The emphasis should be put on the mechanism of esterification of alcohols and on the fact that the reaction of carboxylic acids with carbonates and bicarbonates is used as a chemical test to distinguish carboxylic acids from other functional groups, especially phenols.

Answers to activity 7.5.

1. Carboxylic acids can be transformed into other more useful substances because they can undergo chemical reactions. The property that is exploited in this case is their reactivity.
2. It is possible because fatty acids can react with appropriate reagents, under appropriate conditions to form soap.
3. Refer to student's book, section 7.4 about reactions of carboxylic acids.

d) Checking up activity

The questions in the checking up 7.5 which are found in student's book are given to students and they are asked to do them individually in their exercises books. The role of the teacher in this activity will be to assist those who are struggling with finding answers.

Answers to checking up 7.5.

1. For this activity, group students appropriately, a group of more than 6 students would be very large. Then provide them with indicated apparatus and chemicals; and ask them to follow the procedure suggested. Emphasize on the following points:
 - Carboxylic acids react with carbonates and bicarbonates like mineral acids do.
 - Emphasize on the importance of this reaction in qualitative analysis to test for the presence of carboxylic acids and to distinguish carboxylic acids from functional groups.

Equations:

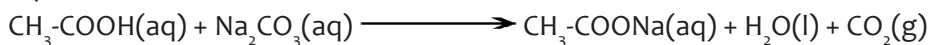

Lime water turns milky

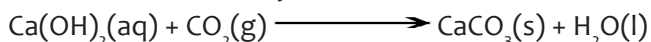

a) Sodium hydroxide reacts with carboxylic acids in a neutralization reaction, but there

is no reaction of sodium hydroxide with alcohols.

B. During the process potassium hydroxide was neutralized by acetic acid. Since the equimolar amount of the base and the acid were mixed there was complete neutralization.

2. Refer to student's book, lesson 7.5
3. Keza would advise Mugabo to take a sample from each of the liquids and test them either using solution of sodium carbonate or methyl orange indicator. Emphasis should be put on acidic nature of carboxylic acids, unlike alcohols.
4. a) The same idea as in question 3 of this check point
b) Use sodium carbonate as a chemical test that will give a positive test with carboxylic acid, but there no observable change in case of a phenol. Note that the indicator is not appropriate because it would give similar observations in both compounds.

Lesson 6: Uses of carboxylic acid (80minutes)

a) Introduction

Carboxylic acids are used in diverse domains of our daily life such in food industry, pharmaceutical industry in plastic industry, cosmetic industry, etc.

b) Teaching resources

The teaching and learning resources that are needed for this lesson are:

- Student's textbooks
- Chalk board and pieces of chalk
- Internet connection

c) Learning activities

Guidance

- This activity 7.6 has the aim of raising the interests of the students to learn carboxylic acids and other organic compounds that derivate from them with the ideas in mind that they are important as far as their applications are concerned. The activity will be carried out in groups of 5 students.
- Before giving this activity, it would be better if the teacher asks students to make research about the uses of carboxylic acids in general and they come

in class when they have enough information to use in the discussion.

- Students will present the results of the group discussions from which the teacher will extract a take away summary for students after the lesson.
- Right at the end of the lesson take the opportunity of showing the relationship between this lesson and the cross-cutting issue of financial education.

Answers to activity 7.6.

1. The carboxylic may not be the only chemical that is used in making these materials, but it also used in the process. Refer to student's book, section 7.6 about uses of carboxylic acids.
2. Refer to student book, section 7.6

d) Checking up activity

The questions in the checking up 7.5 which are found in student's book are given to students and they are asked to do them individually in their exercises books. The role of the teacher in this activity will be to assist those who are struggling with finding answers.

Answers to checking up 7.6.

1. For this check up, group students appropriately, a group 5 students would be large. Then provide them clear instruction on topics to research on. After research allow each group to present their findings.

Answers: Refer to student book, section 7.6

Lesson 7: Acyl chlorides and nomenclature (80minutes)

a) Introduction

Acyl chlorides are derivatives of carboxylic acids which are obtained by substituting -OH group of carboxylic acids by Cl-atom. The prerequisite knowledge to name acyl chlorides is:

- IUPAC general rules of naming organic compounds that will help student in the nomenclature of acyl chlorides. This was studied in senior 5, unit 1.
- Nomenclature of carboxylic acids.

- Isomerism and types of isomerism in organic compounds that was seen in senior 5, unit one.
- Different formulae that used to represent organic compounds discussed in senior 5, unit 1 are important to represent diverse molecules of acyl chlorides.

b) Teaching resources

The teaching and learning resources that are needed for this lesson are:

- Student's textbooks
- Chalk board and pieces of chalk

c) Learning activities

Guidance

- Since the content of this lesson is not quite new to students, activity 7.7. is given to students so that they can discuss it in groups by using the information of what they studied in the previous lessons of this unit and other units mentioned in prerequisites.
- Give chance students to explain what they have discussed. The only thing to be précised by the teacher is that in giving positions to side branches the acyl chloride functional group is prioritized.

Answers to activity 7.7.

a) Reactions of carboxylic acids. Example:

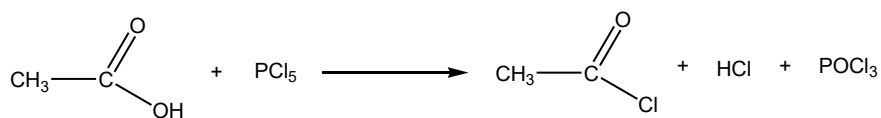

b) The functional group is acyl chloride

c) The compound is named as ethanoyl chloride

d) Replace 'ic acid' by '-yl chloride'

d) Checking up activity

The questions in the checking up activity 7.7 which are found in student's book are given to students and they are asked to do them individually in their exercises books. The role of the teacher in this activity will be to assist those who have difficulties and are struggling with finding answers.

Answers to checking up 7.7

- a) $\text{CH}_3\text{CH}_2\text{COCl}$
- b) $\text{CH}_3\text{CH}_2\text{CH}_2\text{COCl}$
- c) $\text{CH}_3\text{CH}(\text{CH}_3)\text{CH}_2\text{CH}_2\text{COCl}$

1.

- a) False. The functional group is given priority, it should take the lowest position possible.
- a) True. The following molecule of acyl chloride has a chiral carbon and it can show optical isomerism.

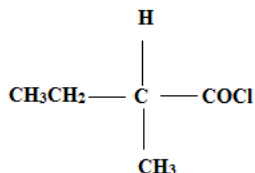

2. The name is: 3-methylbutanoyl chloride

Lesson 8: Physical properties of acyl chlorides (80 minutes)

a) Introduction

Acyl chlorides consist of discrete polar molecules do not have hydrogen bonds, they interact by Van der Waals forces.

- Chemical bonding and structure of molecules which were studied in unit 3 and 4 of senior 4
- Type of intermolecular forces learnt in unit 4 of senior 4.

b) Teaching resources

The teaching and learning resources that are needed for this lesson are:

- Student's textbooks
- Chalk board and pieces of chalk

c) Learning activities

Guidance

- Since the content of this lesson is not quite new to students, activity 7.7.1 is given to students so that they can discuss it in groups by using the information of what they studied in the previous lessons of this unit and other units mentioned in prerequisites.

- Give chance to students to explain what they have discussed in their respective groups. Finally, emphasize on the fact that acyl chlorides do not actually dissolve in water rather they undergo hydrolysis by water.

Answers to activity 7.7.1

Acyl chlorides molecules are loosely held together by weak Van der Waals forces, whereas carboxylic acids are held together by double strong hydrogen bonds in a dimeric structure. This results in that carboxylic acids have higher melting and boiling points than acyl chlorides. Since carboxylic acids can form hydrogen bonds with molecules of water they also more soluble in water than carboxylic acids.

Answers to checking up 7.7.1

1. Refer to student's book, section 7.7 about physical properties of acyl chlorides.

Lesson 9: Reactions of acyl chlorides (80minutes)

a) Introduction

The chemistry of acyl chlorides is dominated by nucleophilic substitutions where the chlorine atom is replaced by another nucleophile. The reactivity of acyl chlorides requires the prior knowledge of:

- Types of chemical reactions in organic chemistry (especially nucleophilic substitution reaction).
- Reaction of carboxylic acids especially those that break the bonds between C-

b) Teaching resources

The teaching and learning resources that are needed for this lesson are:

- Student's textbooks
- Chalk board and pieces of chalk

d) Learning activities

Guidance

- The fact that the content of this lesson is closely related to the other lessons discussed previously, especially reaction of carboxylic acid with alcohols, the activity 7.7.2 is given to students so that they can discuss it in groups by using the information of what they studied in the previous lessons of this unit.
- Allow students to present the results of their discussions. From the information given by students, explain all the types of reactions of acyl chlorides by focusing on the mechanisms of nucleophilic substitution reactions.

Answers to activity 7.7.2

- a) The mechanism is called nucleophilic substitution
- b) The mechanism is as follows:

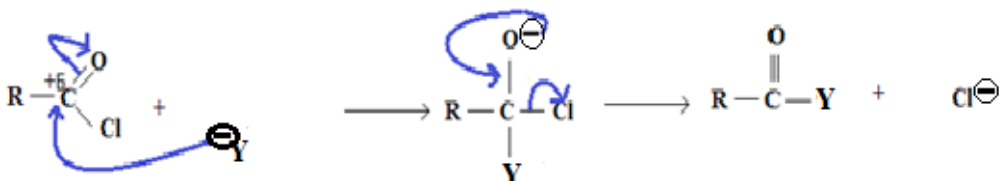

The incoming atom Y- should have a pair of electrons to donate and must have higher electronegativity than that of chlorine so that it can form stronger bond with carbon (C-Y) than that of chlorine with carbon C-Cl.

d) Checking up activity

The questions in the checking up activity 7.7.2 which are found in student's book are given to students and they are asked to do them individually in their exercises books. The role of the teacher in this activity will be to assist those who have difficulties and are struggling with finding the correct answers.

Answers to checking up 7.7.2

1. Tertiary amines do not react with acyl chlorides because their lone pair is stabilized by positive inductive effect of many alkyl groups (they do not easily give their lone pair of electrons) and they lack hydrogen on the nitrogen atom.
2. Acyl chlorides are acid derivatives because they are obtained from carboxylic acids by substituting -OH group by Cl-atom.
3.
 - a) The carbon atom in acyl group is very deficient in electrons due to O-atom and Cl-atom attached to it. It has a greater pulling force on the electron lone pairs of water molecules than the carbon which bears halogen in alkyl

halides.

- b) Acyl chlorides have a better leaving group Cl-atom than that of carboxylic acids -OH group, because oxygen has greater electronegativity than chlorine.

7.7. Summary of the unit

- Carboxylic acid is a class of organic compounds that are characterized by the presence of carboxyl group in their chemical formula.
- Carboxylic acids naturally occur in different substances that we normally encounter in our daily life and are also used to make various useful materials.
- Carboxylic acids are named by following the general rules of naming organic compounds, where the suffix 'oic acid' is added to the stem name of the longest carbon chain that contains the acid functional group.
- For diacids, the suffix of the IUPAC name becomes 'dioic acid'. They have a general formula of $\text{HOO-C}_n\text{H}_{2n}\text{-COOH}$.
- Unsaturated acids (alkenoic acids) are systematically named by changing the stem suffix '-an' to '-en'.
- Hydroxy-acids are named by considering -hydroxyl group as a substituent on the longest carbon chain that contains carboxylic functional group.
- Carboxylic acids show diverse types of isomers either among themselves or with other compounds that have different functional groups. The common isomers are chain isomers, functional isomers, and optical isomers.
- Carboxylic acids are polar molecules that interact by double strong hydrogen bonds in a dimeric structure. Many carboxylic acids are colorless liquids with disagreeable odors at room temperature and pressure.
- Carboxylic acids have high melting and boiling points which increases as the molecular weight increases, because the molecules interact by strong hydrogen bonds.
- The boiling and melting points of carboxylic acids are higher than those of their alcohols counterparts due the formation of a strong dimer by carboxylic molecules.
- They are generally soluble in water because they form hydrogen bonds with molecules of water.
- Carboxylic acids are acidic because they have ionizable hydrogen and they

dissociate in water to release very few hydrogen ions. They are weak acids.

- The presence of a group with positive inductive effect in the structure of the molecule reduces the acidity strength, whereas the group with a negative inductive effect increases their acidity strength.
- Carboxylic acids are common and vital functional group; found in amino acids, fatty acids etc. and provide the starting raw material for acid derivatives such as acyl chlorides, amides, esters and acid anhydrides.
- Different carboxylic acids can be prepared by oxidation of either primary alcohols or aldehydes. In the process, the mixture of alcohol is heated under reflux with an oxidizing agent such acidified potassium permanganate or potassium dichromate.
- Carboxylic acids can be prepared from oxidation of either primary alcohols or aldehydes by oxidizing agent such acidified potassium permanganate or potassium dichromate.
- Hydrolysis of nitriles in acidic or alkaline conditions forms carboxylic acids.
- Carboxylation of Grignard reagents leads to formation of carboxylic acid with one carbon atom more than the number of carbon atoms in the original organic compound.
- Hydrolysis of diverse derivatives of carboxylic acids also form the parent carboxylic acid.
- Reactions that break the bond between O-H bond are typical reactions of a carboxylic acid compound as an acid (reaction with metals and bases).
- Reactions that break the C-O bond are considered as nucleophilic substitution reactions (esterification, reaction with ammonia and amines, PCl_3 , SOCl_2 ...)
- Reducing agents such as LiAlH_4 in dry ether or H_2 in the presence of nickel catalyst yields primary alcohols.
- Carboxylic acids occur naturally in fats, acidic dairy and citrus fruits, they are mainly used in food industry, pharmaceutical and other industries directly or as the starting material to synthesize other materials that are used in those industries.

7.8 Additional information for the teacher

7.8.1 Acidity of carboxylic acids

The acidity of carboxylic acids can be explained by the fact that the carboxylate ion formed when the acid releases hydrogen ion is stable. The carboxylate ion formed by ionization of the acid is more stable than the acid because it has many resonance

structures.

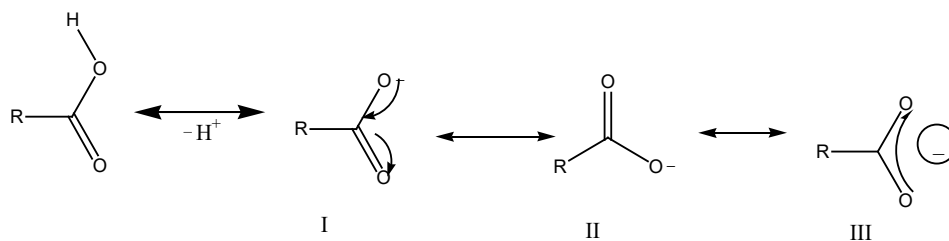

Structures I, II, III are results of the resonance of the carboxylate ion, where the carbon-oxygen bond lengths are equal and C-O length is between than of C-O and pure C=O.

The values of acid dissociation constant, K_a , express the acidity strength. The greater the K_a value, the stronger the acid and vice versa. On the other hand, pK_a which is defined as the negative log of K_a , as its value becomes smaller if the acid is stronger and vice versa.

Table: Dissociation constants of some carboxylic acids

Molecule	K_a value	$pK_a = -\log K_a$
H-COOH	1.77×10^{-4}	3.80
CH ₃ -COOH	1.75×10^{-5}	4.75
CH ₃ CH ₂ -COOH	1.8×10^{-5}	4.90
CH ₃ CH ₂ CH ₂ -COOH	1.5×10^{-5}	5.20
ClCH ₂ -COOH	1.36×10^{-3}	2.9
Cl ₂ CH-COOH	4.5×10^{-2}	1.25
Cl ₃ C-COOH	2.2×10^{-1}	0.70
HOOC-COOH	1.47×10^{-4}	1.2
F ₃ C-COOH	3.0×10^{-1}	0.52

For example, methanoic acid with bigger K_a value is stronger acid than ethanoic acid whose smaller K_a value.

Different K_a values given in the above table can be explained by inductive effect which is the tendency of an atom or group of atoms to either donate or withdraw electrons from the atom they are attached to.

7.8.2 Reaction of carboxylic acids with alcohols (80minutes)

To understand the mechanism of esterification they used an alcohol with oxygen-18 isotope and in carboxylic acid oxygen-16 isotope and after the reaction the ester was

found to contain oxygen-18 and in water there was oxygen-16. The conclusion about these observations was that in esterification reaction the acid loses -OH while the alcohol loses H-atom.

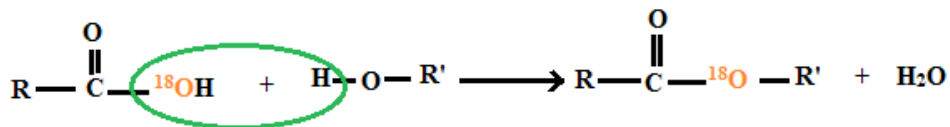

7.9. End unit assessment

Multiple choice questions

1. A
2. A
3. D
4. A
5. D

Open questions

6. Increasing order of the boiling point is: Propanal < propan-1-ol < Propanoic acid

- Propanal: Has low boiling point because molecules interact by weak Van der Waals
- Propan-1-ol: molecules interact with strong hydrogen bonding
- Propanoic acid: has the highest boiling point because molecules interact by double hydrogen bonding that leads to formation of dimeric structure.

7.

a) The strongest acidic isomer of dichlorobutanoic acid is

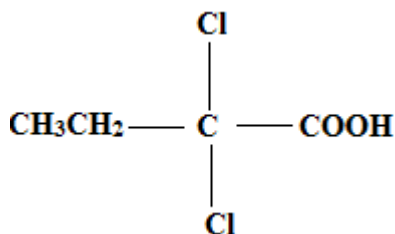

b) The least acidic isomer fluoropentanoic acid is

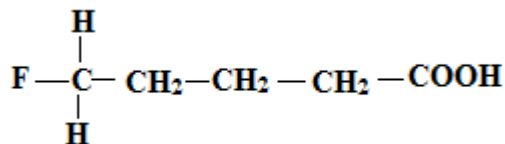

8.

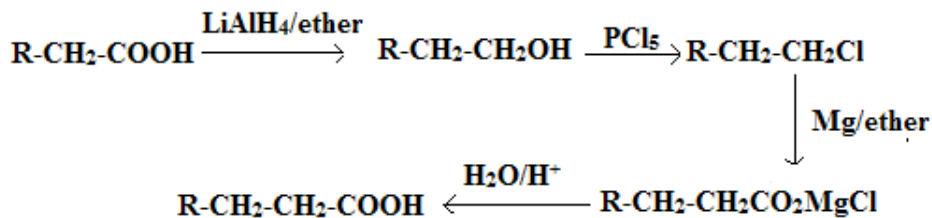

9.

a) The names and the formula of compounds:

CH_3COCl : Ethanoyl chloride

CH_3CONH_2 : Ethanamide

$\text{CH}_3\text{COOCH}_2\text{CH}_3$: Ethyl ethanoate

b) Refer to the student's book, section 7.9 about reaction of acyl chlorides.

10. Use the idea that the boiling point increases as the molecular mass increases

Formula	Boiling point (°C)
$\text{CH}_3\text{-CO}_2\text{H}$	1410C
$\text{CH}_3(\text{CH}_2)_{10}\text{-CO}_2\text{H}$	2990C
$\text{CH}_3(\text{CH}_2)_3\text{-CO}_2\text{H}$	1860C
$\text{CH}_3\text{CH}_2\text{-CO}_2\text{H}$	1180C

11.

a. Refer to student's book, lesson 7 about reactions of carboxylic acids.

b. Refer to student's book, lesson 7 about preparations of carboxylic acids.

12. Given the samples of A and B, after the tests and the observations noted;

a) A is an acyl chloride because it the derivative of carboxylic acid that

produces white fumes of HCl when it is reacted with water.

- b) B is a carboxylic acid because it is the organic compound that reacts with carbonates or bicarbonates and effervescence is observed.

7.10 Additional activities

7.10.1 Remedial activities

These remedial activities are given to students that are struggling with the understanding of the concepts learnt in the lesson. They are to help those learners to catch up with what they did not well understand.

Questions

1. Give the systematic names of the following organic compounds
 - a) $\text{CH}_3\text{-CH}(\text{CH}_3)\text{-CH}_2\text{-CH}(\text{CH}_3)\text{-COOH}$
 - b) $\text{CH}_3\text{-CH}(\text{OH})\text{-CH}_2\text{-CH}_2\text{-COOH}$
 - c) $\text{HOO-CH}_2\text{-CH}_2\text{-CH}_2\text{-COOH}$
2. Explain the following observations:
 - a) Propanoic acid has lower boiling point than that of pentanoic acid
 - b) Ethanol is much more volatile than ethanoic acid
 - c) The palmitic acid forms two layer with water when they are mixed, but acetic acid mixes with water in all proportions.
3. Acetic acid, unlike ethanol, readily reacts with ammonia solution to form ammonium and acetate ion. Explain the property that acetic acid has which makes it behave in this way.
4. Complete the following reactions:
 - a) $\text{CH}_3\text{-CH}_2\text{-CH}_2\text{-COOH} \xrightarrow{\text{Mg/ether}} \text{H}_3\text{O}^+_{(\text{aq})}$
 - b) $\text{CH}_3\text{COOH} + \text{CH}_3\text{CH}(\text{OH})\text{CH}_3 \longrightarrow$
 - c) $\text{CH}_3\text{COOH}(\text{aq}) + \text{NaHCO}_3(\text{aq}) \longrightarrow$
5. Describe how you can prepare;

a) Propanoic acid from propan-1-ol

b) Acetic acid from bromomethane

Answers

1.

c) 2,4-dimethylpentanoic acid

b) 4-hydroxypentanoic acid

c) Butanedioic acid

2.

a) Propanoic acid has lower boiling point than pentanoic acid because pentanoic acid has stronger Van der Waals forces due to its higher molecular mass than that of propanoic acid.

b) Ethanol is more volatile than ethanoic acid because the hydrogen bonds in ethanol are weaker. Ethanoic acid molecules form double hydrogen bonds that result in the formation of dimeric structure, and this makes it less volatile.

c) The solubility of carboxylic acids decreases as the molecular size increases. This causes the Van der Waals forces between the hydrophobic part of the molecule to dominate hydrogen bonds between molecules of water. Palmitic acid being a large molecule is less soluble in water than acetic acid that is very small.

3. Acetic acid readily reacts with ammonia solution because it has acidic properties, where it readily donates a proton to ammonia which is a base.

4. Complete the following reactions:

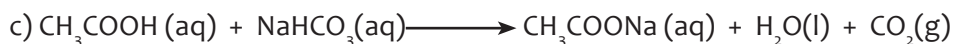
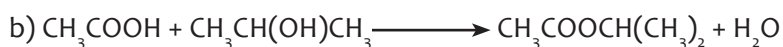

5.

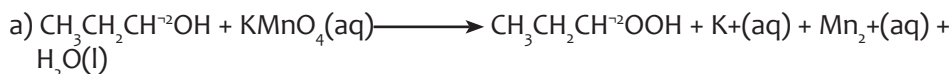

7.10.2 Consolidation activities

These are additional activities given to all students for more practice about all the lessons learnt.

Questions

1. Complete the following reactions and identify the compounds represented by the bold letters:

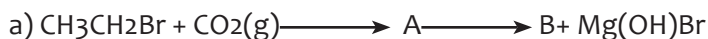

b)

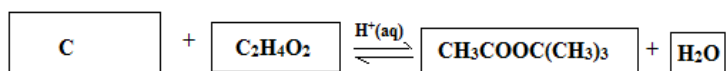

2. Use the following experiment information to answer related questions:

Formula	Molar mass (g/mol)	Melting point (°C)	Boiling point (°C)
HCOOH	46	8	100.5
CH ₃ COOH	60	17	118
CH ₃ OH	36	-98	65
CH ₃ CH ₂ OH	46	-114.1	78.4

- a) How is the boiling point of ethanoic acid greater than that of methanoic acid?
- B) Explain why the boiling point of methanoic acid is greater than that of ethanol despite of their molecular masses that are the same.

Answers

1.

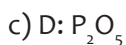

2.C

- a) The boiling point of carboxylic acids increases as the molecular mass

increases. Since ethanoic acid has greater molecular mass than that of methanoic acid, it has greater boiling point.

b) Methanoic acid molecules interact by stronger double hydrogen bonds in dimeric structure, which is not formed in ethanol.

1.1.7 Extended activities

Questions

- Suggest a series of reactions by which ethanol can be converted to 2-hydroxypropanoic acid. For each reaction specify the reagents and conditions necessary.
 - Explain whether the solution of 2-hydroxypropanoic acid, made in this way, would have any effect on plane polarized light.
 - 2-hydroxypropanoic acid reacts with lithium tetrahydridoaluminate (III), LiAlH_4 . State the conditions necessary for this reaction and give the structure of the organic product formed.
- Esters are products of the reaction between carboxylic acids and alcohols.
 - Draw the structure of the organic product of the reaction between propan-2-ol with propanoic acid
 - Explain the alternative way this ester can be prepared by using another reagent in place of propanoic acid.
- Describe how the following pairs of compounds can be distinguished by a chemical test.
 - CH_3COOH and CH_3COCl
 - Propanoic acid and propan-2-ol

Answers

- $\text{CH}_3\text{CH}_2\text{OH} \longrightarrow \text{CH}_3\text{CHO} \longrightarrow \text{CH}_3\text{CH}(\text{OH})\text{CN} \longrightarrow \text{CH}_3\text{CH}(\text{OH})\text{COOH}$
 - Refer to student's book, lesson 7.1 about nomenclature and isomerism
 - This reaction takes place in dry ether. The organic product formed is propan-1,2-diol: $\text{CH}_3\text{CH}(\text{OH})\text{CH}_2\text{OH}$
 - a)

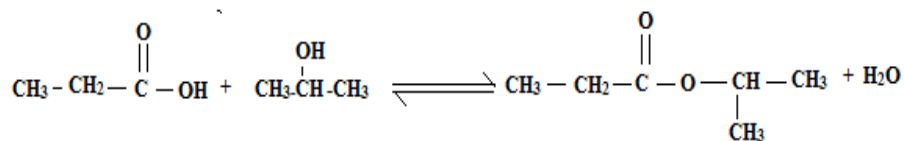

b) The same ester can be prepared by using propanoyl chloride.

3.

a) The chemical test that can be used is Sodium carbonate (Na_2CO_3).

With ethanoic acid, there is formation of carbon dioxide that results in effervescence

With ethanoyl chloride, there is no effervescence

b) Acidified potassium permanganate/dichromate can be used.

With propan-2-ol, orange/purple color turns to green/colorless color

With propanoic acid, there is observable change.

Or

The chemical test that can be used is Sodium carbonate (Na_2CO_3).

With propanoic acid, there is formation of carbon dioxide that results in effervescence

With propan-2-ol, there is no effervescence.

UNIT 8: ESTERS, ACID ANHYDRIDES, AMIDES AND NITRILES

8

8.1. Key unit competence

To be able to relate the functional groups of esters, acid anhydrides, amides and nitriles to their reactivity, preparation methods and uses.

8.2. Introduction

Students will learn better esters, acid anhydrides, amides and nitriles if, in the previous units, they have understood chemical bonding (S4: unit 4), chemistry of alcohols (S5: unit 5) and chemistry of carboxylic acids (S5: unit 7). You will use various techniques such as discussions, you will help learners to recap the above concepts before you start unit 8.

8.3. Cross-cutting issues to be addressed

a) Inclusive education: This unit will involve the physical and chemical properties of acid derivatives and their uses in our everyday life and then, the use of molecular structures and many practical activities is obvious. This may be challenging to students with special educational needs especially students with visual and upper and lower limb impairment. However, these students can be catered for in every lesson by using different techniques which are explained in the general introduction. Refer to the general introduction of this book for more information.

b) Gender: You should always remember that there is no activity reserved for boys only or girls only. Try to involve both of them in each and every learning activity.

c) Financial education: This unit tackles the chemistry and uses of esters, acid anhydrides, amides and nitriles, the teacher will explain how processes such as saponification are income generating. S/He shall also indicate various manufactures which use acid derivatives and that can make a good starting point for young entrepreneurs.

d) Peace and values education: During group activities, you will encourage learners to help each other and to respect other's opinions.

e) Standardization culture

You should remind learners to always check if they are not using expired chemicals or defective apparatus.

In addition, they must be trained to record data accurately and present accurate results.

f) Environment and sustainability

In order to avoid the environment pollution, before, during or after experiments learners have to not throw away chemicals anywhere.

During the lesson of saponification you will tell learners the impacts of using soapless detergents on the environment.

8.4. Guidance on the introductory activity

Introductory activity (15 minutes)

- Help learners to form groups of four members, explain what is to be done, and then let them work out the introductory activity.
- You must be sure that all group members are participating.
- Each group will note down the observations made from the pictures in the activity and write answers for the given questions in their books.
- Randomly, you will choose 2 to 3 groups to present the outcomes of their work to the others. Here you should take note of the key points from presentations as they help you to know what to add, what to correct...
- After presentations, you have to engage the class into exploitation of the students' productions. They discuss on the presentations to decide if they are correct, complete and if more information is needed. Here you will act as a moderator but you will also have to add, correct or remove some information. After harmonization you will provide a short summary of the activity and start the new unit.

Expected answers for the questions in the introductory activity

1. Nylon textile is used to make umbrella because it is impermeable
2. Urea is synthesized by reacting ammonia and carbon dioxide. It can also be prepared from calcium carbide.
3. Since the beginning of production of artificial esters which have fruity smells, the food industry has become able to make artificial drinks with fruity flavors. To the sugary liquid they prepare, they add flavors of various fruits.
4. The pain killer drug, aspirin, is manufactured by a reaction between salicylic acid and ethanoic anhydride. It is an example of one of the methods of preparing esters.
5. Chemicals which give fragrances to perfumes are esters.

8.5. List of lessons

#	Lesson title	Learning objectives	Number of periods
1	Introduction to Esters	<ul style="list-style-type: none"> -Apply IUPAC rules to name esters -Compare physical properties of esters to those of alcohols and carboxylic acids -State uses of esters 	2
2	Preparation and chemical properties of esters	Describe the chemical properties and preparation methods of esters	2
3	Saponification	Make soap and compare its properties with those of soapless detergents.	2
4	Introduction to Acid anhydrides	<ul style="list-style-type: none"> -Apply IUPAC rules to name acid anhydrides -Describe the physical properties of acid anhydrides -State and explain the uses of acid anhydrides 	2
5	Preparation and chemical properties of acid anhydrides	<ul style="list-style-type: none"> -Compare the reactivity of acid anhydrides to that of acyl chlorides and esters. -Describe the chemical properties and preparation methods of acid anhydrides 	2
6	Introduction to amides	<ul style="list-style-type: none"> - Classify amides as primary, secondary and tertiary - Apply IUPAC rules to name amides - Describe the physical properties of amides -State and explain the uses of amides 	3
7	Preparation and chemical properties of amides	<ul style="list-style-type: none"> - Compare the reactivity of amides to that of esters and acid chlorides - Describe the preparation methods of amides - Describe the chemical properties of amides 	3
8	Introduction to Nitriles	<ul style="list-style-type: none"> - Apply IUPAC rules to name nitriles - Describe the physical properties of nitriles - State the uses of nitriles 	2

9	Preparation and chemical properties of nitriles	<ul style="list-style-type: none"> - Describe the preparation methods of nitriles - Describe the chemical properties of nitriles 	2
---	---	--	---

8.6. Guidance on the lessons

Lesson 1: Introduction to Esters

This is the first lesson of unit 8 which has 80 minutes (2 periods) and it must involve the introductory activity of the whole unit.

a) Introduction (5minutes)

This lesson will be well delivered if students have a good understanding of how to draw structures of organic compounds and the reactions of carboxylic acids. You should find a way of testing the understanding level of your learners. You can use an exercise or a short discussion.

b) Teaching resources

Student book and reference books from library or internet

c) Learning activities

You will have to introduce briefly the unit. After that learners will attempt the introductory activity first and then activity 8.1.

Methodological steps

As a facilitator, the teacher is expected to guide learners through the following steps:

Activity 8.1: 10minutes

- In groups learners used in the introductory activity, they will discuss on questions in activity 8.1 answer them. The discussion will be done in groups but let each learner write answers in her/his exercise book. The teacher must be sure that all learners are involved in the activity. Each group must have a leader who will be moderator and a secretary who writes the report and will present findings of the group.
- Move around the class, listening to students as they discuss and provide support where needed.
- Have a sample group present their findings to the class.

- Valuing learners' presentations(judgment and discovery of possible mistakes by students)
- This is diagnostic activity; the next step will greatly depend on your judgment. If your class can not correctly answer the question, extra explanations and exercises are necessary. But if they are correctly answered then the teacher can proceed and give a summary of the first part of the lesson. A summary of the content must be written on the board.

Expected answers to activity 8.1

Acid derivatives	Carboxylic acids	Alcohols	Carbonyl compounds
$\text{CH}_3\text{CH}_2\text{CH}_2\text{CONHCH}_3$	$\text{CH}_3\text{CH}_2\text{CH}_2\text{COOH}$		
$\text{CH}_3\text{CH}_2\text{CH}_2\text{COOC}(\text{CH}_2)_2\text{CH}_3$	$\text{CH}_3\text{CH}(\text{CH}_3)\text{COOH}$	$\text{CH}_3\text{CH}_2\text{CH}_2\text{CH}_2\text{OH}$	$\text{CH}_3\text{CH}_2\text{COCH}_3$
$\text{CH}_3\text{CH}_2\text{CH}_2\text{CONH}_2$		$\text{CH}_3\text{CHOHCH}_2\text{CH}_3$	$\text{CH}_3\text{CH}_2\text{CH}_2\text{COH}$
$\text{CH}_3\text{CH}(\text{CH}_3)\text{CN}$			

2. Isomers of molecular formula $\text{C}_4\text{H}_8\text{O}_2$

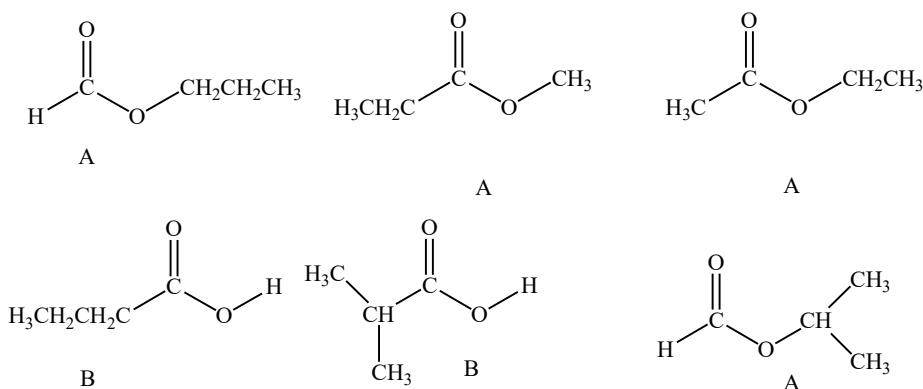

Experiment. 35minutes

- As the second part involves an experiment this lesson must be taught in the school laboratory.
- The teacher will prepare necessary apparatus and chemicals. Note: It is always better for the teacher to carry out the experiment before you bring learners in the laboratory.
- Learners will work in groups. Here groups can be changed to help students with special educational needs who may be present. Learners

with visual or mobility impairment must be with colleagues who can help them. These students will not manipulate but they can be allowed to give instructions of how to proceed.

- Each group performs the experiment and record the results.
- When time is up, the teacher will choose some groups to present their observations.
- All students will take time to discuss, guided by the teacher, the inferences of each observation.
- The teacher must provide the necessary extra information and explanations.
- A summary of the second part of the lesson should be written next to that of the first part on the board.

Expected findings for the experiment in lesson 8.1.

Refer to the student's book. Conclusion of activity 8.1

Next will be an assessment of the lesson. Learners will attempt checking up 8.1.
15minutes

Answers to checking up 8.1.

1. Names

- (i) methyl propanoate
- (ii) ethyl propanoate
- (iii) propyl propanoate
- (iv) isopropyl methanoate

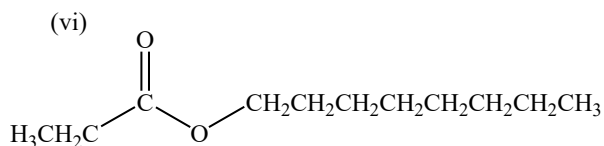
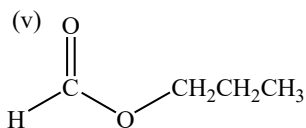

2. Like all organic compounds esters are insoluble in water but soluble in organic solvents. However lower esters are slightly soluble in water because they can hydrogen bond to water molecules but this solubility decreases as the size of the hydrocarbon part increases.

3. Esters are used in food industry to give fruity flavors various products. They are also used in perfume industry because of their pleasant odors...
4. Compound A is an ester, it lacks hydrogen bond. Compound B is a carboxylic acid with strong hydrogen bond.

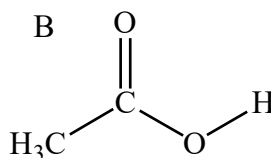
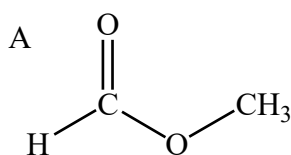

5. These compounds are functional group isomers. This is because they have same molecular formula but belong to different homologous series. Mark the work of learners to evaluate the achievement of your objectives.

Lesson 2: Preparation and Chemical properties of Esters

This lesson has 80 minutes (2periods). It will describe different methods of preparing esters and their reactions. The reactivity of esters will be compared to that of acyl chlorides.

a) Introduction (5minutes)

This lesson will be well delivered if students have a good understanding of how to draw structures of organic compounds and reactions of carboxylic acids with alcohols as well as the preparation of alcohols or carboxylic acids from esters, covered in unit 5 and unit 7. Give some exercises to help learners recap reactions of alcohols and carboxylic acids.

b) Teaching resources

Student book, reference books or internet, ethanol, ethanoic acid and concentrated sulphuric acid and the set up shown below:

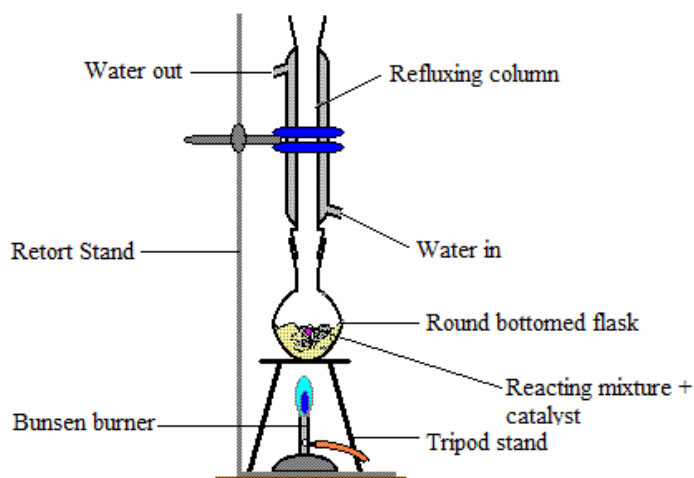

d) Learning activities

Briefly explain what students are going to do and let them carry out the experiment described on point number 4 of activity 8.2 in the student's book.

Methodological steps

As a facilitator, the teacher is expected to guide learners through the following steps:

Activity 8.2

- You will prepare necessary apparatus and chemicals, help learners make groups and give a brief explanation of what is to be done.
- **Note:** It is always better for the teacher to carry out the experiment before you bring learners in the laboratory. You should also find ways of helping learners with various special needs.
- For points 1, 2 and 3 of the activity the discussion will be done in groups and the report will be written by the secretary of the group. However, you should encourage all group members to keep a copy of the report in their own exercise books.
- Point number 4 of this activity is practical. Learners will prepare ethyl ethanoate guided by the teacher. Each group will need an esterification set up (shown in the teaching activity above), 20ml of acetic acid and 20ml of ethanol and 3 drops of concentrated sulphuric acid. They will mix them carefully and heat the mixture for ten minutes. The mixture will then be

poured into cold water and students will smell the resulting solution. You should remind learners to be careful when handling concentrated sulphuric acid.

- Move around the class, listening to students as they discuss and help groups which may have difficulties in starting the activity.
- Choose 2 to 3 groups to present their findings to other students.
- After presentation, engage learners in a discussion on the answers given by different groups provide necessary complementary information and explanations. From this discussion a summary of the lesson must be given to students.
- Before closing your lesson, should reserve some minutes to discuss with students the environmental impacts of acidic wastes.

Expected answers to activity 8.2.

1. (i) Physical method:

Mixing different available esters to produce a new odor which is an intermediate of the odors of the mixed esters.

2. (ii) Chemical method.

Produce new esters chemically by reacting alcohols and carboxylic acids to produce new esters. Use available esters and transform them chemically by reacting them with alcohols through trans Esterification.

2. Organic compounds used are: ethanol and propanoic acid.

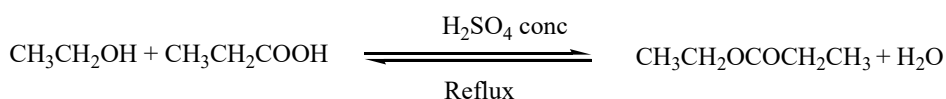

For questions 3, 4 and 5 refer to the student's book unit 8, summary of lesson 4.

Learners will attempt checking up 8.2 to assess the achievement of your learning objectives.

Expected answers to checking up 8.2.

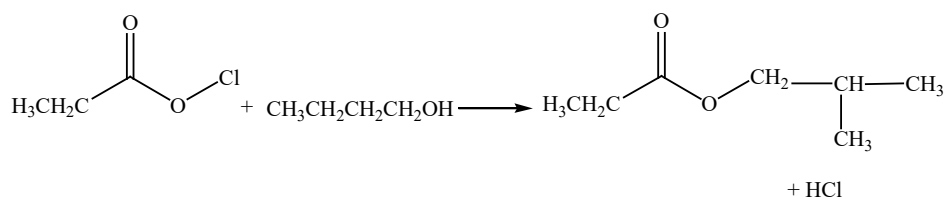

Name of the product: Isobutyl propanoate

2.

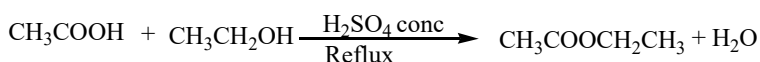
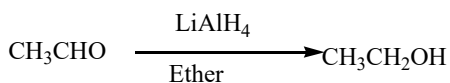
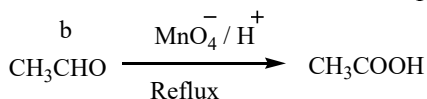
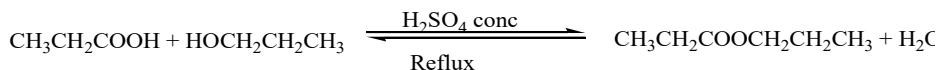
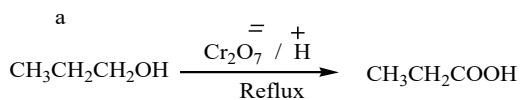

3.

(a) Structure of the alcohol

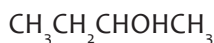

(b) Structure of the ester

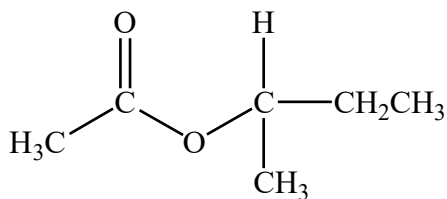

4.

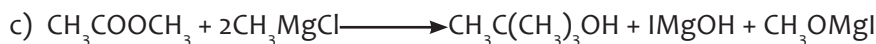

5. Conditions for reaction 1.a: NaOH must be in aqueous solution and heat must be provided.

6. This reaction produces amides but with a small yield so that it is not preferred. Instead acid chlorides are used for the same purpose as they give more yield. Esters react faster with acid chlorides than with amines.

7. Given ethyl ethanoate to prepare isobutyl ethanoate you can carry out a trans-esterification using 2-methylpropan-1-ol.

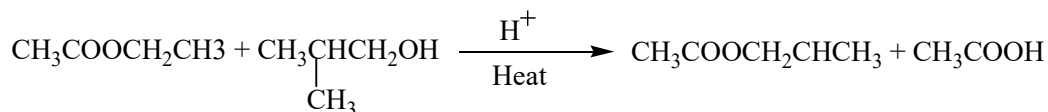

Find an appropriate method of marking the work of learners to find out how the lesson was understood.

Lesson 3: Saponification and Detergents

This lesson has 80 minutes (2periods). It will describe saponification process, properties of soap and soapless detergents.

a) Introduction (5minutes)

This lesson will be well delivered if students have a good understanding of alkaline the knowledge of triglyceride structures will also help much. This lesson is linked to biology (lipids). Find a way of checking the understanding of your learners.

b) Teaching resources

Student book, NaOH, cooking oil, ethanol, NaCl, heater and glassware.

c) Learning activities

Give a brief introduction on the lesson and explain the objective of the experiment (the practical part of the activity). You should set up instructions and a protocol which will guide learners during the practical work.

Methodological steps

As a facilitator the teacher is expected to guide learners through the following steps:

Activity 8.3.

- This activity is similar to activity 8.2 and you may refer to it for an appropriate preparation. However, in addition to the guidance provided in activity 8.2, you will provide to each group some cooking oil and concentrated aqueous caustic soda.
- They will mix the two liquids and add some ethanol to facilitate dissolution of oil. The resulting mixture will be heated for ten minutes in a borosilicate beaker. The mixture will then be poured into cold water and students will smell the resulting solution. From the smell they will try to identify the

product.

- Choose sample groups to present their findings to other students and after presentation, engage learners in a discussion on the answers given by different groups provide necessary complementary information and explanations. From this discussion you will give a summary of the lesson.
- Before closing your lesson, should reserve some minutes to discuss with students the environmental impacts of acidic wastes.
- Saponification is an economically important reaction and time should be provided to discuss about the benefits of knowing this reaction and being able to make soaps. You should also discuss about the dangers of using soapless detergents.

Expected answers to activity 8.3.

1. Soaps and detergents are used in our everyday life for cleaning.
2. Their molecule has two parts: the hydrophobic part which is insoluble but soluble in oil and the hydrophilic part which is soluble in water.
3. Soaps are manufactured by reacting oil of fat with a strong base such as NaOH or KOH. Detergents are prepared by using petroleum derivatives (which have hydrophobic and hydrophilic parts) and NaOH.
4. Both have cleaning properties and molecules made of two parts cited above. Detergents are not prepared by saponification because we do not use oil or fat. Detergents are more effective than soaps because they do not form scum with water. Their magnesium and calcium salts are soluble in water. They foam very easily so that they are used in small quantity.
5. Take some oil mix with NaOH (aq) and heat the mixture. It is better to add some ethanol to facilitate dissolution of oil. After heating, pour the mixture in a concentrated solution of NaCl to precipitate out the salt.

To assess your lesson, let students work out checking up 8.3.

Expected answers to checking up 8.3.

1. (a)

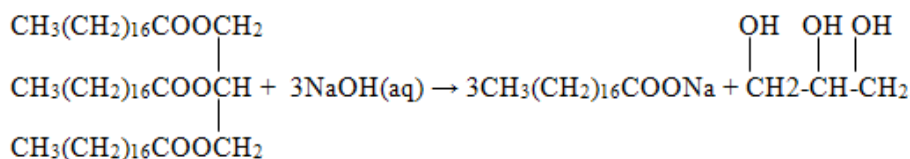

(b) Molecular mass of propyl tristearate: 891g/mol

From the balanced equation 819g of oil react with 120g of NaOH

4000g will react with = $(4000 \times 120) : 891 = 538.72\text{g}$ of NaOH

Mass of soap produced:

From the balanced equation 891g of oil produce 918g of soap.

4000g will produce = $(4000 \times 918) : 891 = 4121.21\text{g}$ of soap

2. Liquid soap is produced by reacting oil or fat with KOH but solid soap is prepared by reacting oil or fat with NaOH. Electrostatic forces between the hydrophilic part of soap and sodium cation are stronger than with potassium cation.
3. Soap is prepared by using oil or fat but detergent are prepared using other chemicals such as sulfonic acids.
4. Detergents are more effective than soaps because they do not form scum with hard water. Their calcium or magnesium salts are soluble in water. They produce foam easily so that they are used in smaller quantity than normal soap in hard water.
5. Refer to the student's book point 8.3.
6. Soaps and detergents are cleaning agents that help us getting rid of dirt, harmful microorganisms. However they may also be a source of pollution. Most detergents are non biodegradable.

Note: the teacher should consider answers of students with the same information as the one given here but written in other words. Mark the work of learners or make a correction and ask them to correct one another to find out how the lesson was understood

Lesson 4: Introduction to Acid anhydrides

This lesson has 80 minutes (2 periods). It will describe different methods of preparing esters and their reactions. The reactivity of esters will be compared to that of acyl chlorides.

a) Introduction (5 minutes)

This lesson will be well delivered if students have a good understanding of how to draw structures of organic compounds and reactions of carboxylic acids. Find a way of checking the understanding of your learners.

b) Teaching resources

Student's book, reference books or internet

c) Learning activities

After checking the prerequisites of your learners, you will let them work out activity 8.4.

Methodological steps

You are expected to guide learners through the following steps:

Activity 8.4

- Organize the class in groups for the activity. Provide necessary instructions and let them discuss. After discussion you will choose sample groups and invite their representatives to present the findings. Remember to help learners with disabilities
- Move around the class, listening to students as they discuss and help groups which may have difficulties in starting the activity.
- After presentation you will ask learners to evaluate the given answers. They must will decide which results are correct, incorrect, poor, ...
- After learners' evaluation, you will summarize the knowledge and give some examples which illustrate the content learnt.
- Before closing your lesson, should reserve some minutes to discuss with students the need of standardization culture. One of the uses of acid anhydrides is to synthesize aspirin. Based this use, remind learners to always check the expiry dates on medicines.

Expected answers to activity 8.4

1. Acetic anhydride or ethanoic anhydride
2. Preparing aspirin using ethanoic acid would require an acidic catalyst which also catalyzes the reverse reaction, hydrolysis of the produced ester hence reducing the yield.
3. $\text{CH}_3\text{COOOCCH}_3$
4. It is prepared by dehydration of acetic acid using P_2O_5 or SOCl_2 .

Tell students to attempt individually checking up 8.4.

Expected answers to checking up 8.4

1. $\text{C}_6\text{H}_{10}\text{O}_3$
1. $\text{CH}_3\text{CH}_2\text{COOOCCH}_2\text{CH}_3$ (A) or $\text{CH}_3\text{COOOCCH}_2\text{CH}_2\text{CH}_3$ (B) Straight isomers

1. $\text{CH}_3\text{CH}(\text{CH}_3)\text{COOOCCH}_3$ (C) Branched isomer
2. A: propanoic anhydride B: butanoic ethanoic anhydride C: ethanoic 2-methylpropanoic anhydride. You can mark the work of learners or make a correction and ask them to correct one another to find out how the lesson was understood

Lesson 5: Preparation and chemical properties of acid anhydrides

This lesson has 80 minutes (2 periods). It will describe different methods of preparing acid anhydrides and their reactions.

a) Introduction (5 minutes)

A good understanding of reactions of carboxylic acids and preparation methods of esters will help learners in this lesson. You should then organize a short discussion to help them recall those two points.

b) Teaching resources

Internet or reference books and student's book

c) Learning activities

Invite students to try to answer questions in activity 8.5.

Methodological steps

In this lesson you will guide learners through the following steps:

Activity 8.5.

Follow the methodological steps used in activity 8.4 and in addition to that remind your learners the need of proper waste disposal for environmental sustainability.

Expected answers to activity 8.5

1. This is because in addition to the desired acid anhydride, two symmetrical acid anhydrides of the parent acids used in the preparation will be produced.
2. A better method of preparing mixed acid anhydrides is to use a salt of one carboxylic acid and an acid chloride of another acid.
3. $\text{CH}_3\text{COCl} + \text{CH}_3\text{CH}_2\text{COONa} \longrightarrow \text{CH}_3\text{COOOCCH}_2\text{CH}_3 + \text{NaCl}$
4. Refer to the student's book. Lesson 8.5.1
5. Refer to the student's book. Lesson 8.5.2

Next will be the assessment time. They will attempt all questions in activity 8.5.

Expected answers to checking up 8.5

1.(a)

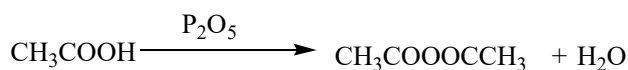
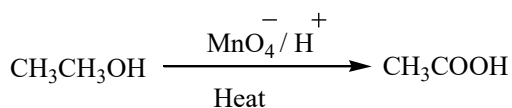

(b)

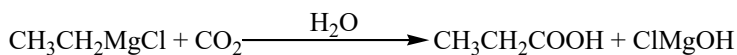
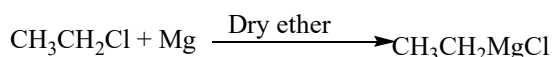
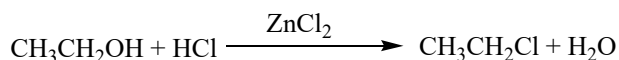

(c) The preparation of ethanoic acid and propanoic acid is shown in (a) and (b) in addition to those preparation the reaction below is used

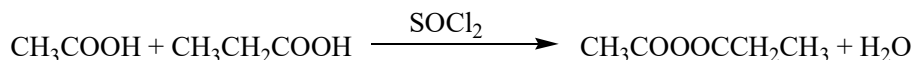

- Group A made a better choice. This is because this method will produce the desired acid anhydride only. Dehydration would produce butanoic anhydride and propanoic anhydride in addition to butanoic propanoic anhydride.
- $(\text{CH}_3\text{CH}_2\text{CO})_2\text{O} + \text{NH}_3 \longrightarrow \text{CH}_3\text{CH}_2\text{CONH}_2 + \text{CH}_3\text{CH}_2\text{COOH}$
- $\text{CH}_3\text{CH}_2\text{COOOCCH}_2\text{CH}(\text{CH}_3)_2 \xrightarrow{\text{LiAlH}_4} \text{CH}_3\text{CH}_2\text{CH}_2\text{OH} + \text{CH}_3\text{CH}(\text{CH}_3)\text{CH}_2\text{CH}_2\text{OH}$
- $\text{CH}_3\text{CH}_2\text{COO}^{18}\text{OCCH}_3 + \text{H}_2\text{O} \xrightarrow{\text{H}^+} \text{CH}_3\text{CH}_2\text{COOH} + \text{CH}_3\text{CH}_2^{18}\text{OH}$
- $\text{CH}_3\text{CH}_2\text{COOC}(\text{CH}_3)_3 + \text{CH}_3\text{COOH}$
- Chemicals: salicylic acid and ethanoic anhydride, conditions: concentrated sulfuric acid to speed up the reaction and heat.
- Esters can be prepared by using an acid chloride or an acid anhydride with an alcohol. The reaction with an acid chloride is very fast at room temperature but that of the anhydride is slow and must be speeded up by heating. Though the reaction involving

the acid chloride is faster it is not preferred by chemists simply because it produces huge amounts of gaseous hydrochloric acid making working conditions bad.

Lesson 6: Introduction to amides (80minutes)

This lesson has 120 minutes (3 periods). The lesson defines amides, explains how they are classified and named. It also covers their physical properties and uses.

a) Prerequisites (5 minutes)

Students need to have a good understanding of the reactions and preparation methods of carboxylic acids.

b) Teaching resources

Student's book, reference books and charts

c) Learning activities

Learners will work out activity 8.6. You are supposed to give them a brief introduction to make clear what they have to do.

Methodological steps

You will guide learners through the following steps:

Activity 8.6

For the methodological steps follow, refer to activity 8.4. Remember to talk about gender education and the application of inclusive education as explained in the general introduction.

Expected answers to activity 8.6

1.

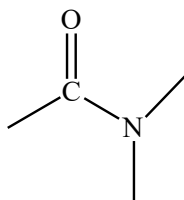

Amide group

2.

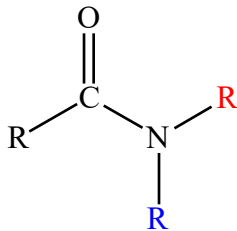

R, R and R may be hydrogen atoms or alkyl groups (identical or different). General molecular formula: $C_nH_{2n+1}ON$

- Natural polymer: proteins, Artificial: nylon
- They would have relatively higher boiling points than esters of the same mass because of hydrogen bonding except tertiary amides.
- It is Nylon-6,6, a polyamide.

Learners have to attempt checking up 8.6. to assess their understanding .

Expected answers to checking up 8.6

- $C_6H_{13}NO$
- $CH_3CH_2CH_2CONH_2$ (A), $CH_3CH(CH_3)CONH_2$ (B), $CH_3CH_2CONHCH_3$ (C),
 $CH_3CONHCH_2CH_3$ (D), $HCONHCH_2CH_2CH_3$ (E), $CH_3CON(CH_3)_2$ (F), $HCON(CH_3)CH_2CH_3$ (G)
- A: butanamide, B: 2-methylpropanamide, C: N-methylpropanamide, D: N-ethylethanamide, E: N-propylmethanamide, F: N,N-dimethylethanamide, G: N-ethyl-N-methylmethanamide
- Butanamide is more soluble in water than N,N-dimethylethanamide because it forms more hydrogen bonding with water molecules due to the hydrogen atoms it has on nitrogen. The other compound does not have any hydrogen atom and this reduces the magnitude of hydrogen bonds it can make with water molecules.
- Solubility of amides decreases with an increase in molecular mass because the size of hydrocarbon part increases and it is insoluble.
- Ethanol.

6. It will have a higher boiling point because the hydrogen bonding involving oxygen atom is stronger than that involving nitrogen atom due to the lower electronegativity of nitrogen.
7. Animal urine can be used as a fertilizer as it contains urea, a source of nitrogen. This must be slightly diluted before being used as it may make plants wither. Too much application causes an accumulation of sodium (Na) and/or nitrogen (N) in soil and eventually inhibits plant growth. Urine can also be a source of water pollution as it may be containing harmful microorganism from the animal body.

Lesson 7: Preparation and chemical properties of amides

This lesson has 120 minutes (3periods). It will describe the preparation methods and reactions of amides.

a) Introduction (5 minutes)

Learners need to have a good understanding of the chemical properties of carboxylic acids and reactions of acyl chlorides. You will find a way of helping your learners recall these points.

b) Teaching resources

Reference books, internet and student's book

c) Learning activities

Briefly explain what students are going to do and let discuss on activity 8.7 and answer the asked questions.

Methodological steps

During the lesson you will provide guidance to your learners through the following steps:

Activity 8.7

Make reference to activity 8.4 and the general introduction for methodological steps and cross-cutting issues to be addressed.

Expected answers to activity 8.7

1. $\text{CH}_3\text{CH}_2\text{CONH}_2$
2. Propanamide can be prepared by reacting propanoic acid and ammonia.
$$\text{CH}_3\text{CH}_2\text{COOH} + \text{NH}_3 \longrightarrow \text{CH}_3\text{CH}_2\text{CONH}_2 + \text{H}_2\text{O}$$

Conditions: Heat
3. $\text{CH}_3\text{COCl} + \text{CH}_3\text{NH}_2 \longrightarrow \text{CH}_3\text{CONHCH}_3 + \text{HCl}$
4. Refer to the student's book. Point 8.7.1.
5. $\text{LiAlH}_4/\text{ether}$ or H_2/Pd

Let students attempt checking up 8.7 individually.

Expected answers to checking up 8.7

1.
$$\begin{array}{c} \text{R}-\text{C}=\text{NH} \\ | \\ \text{OH} \end{array}$$
2. A: $\text{CH}_3\text{CH}_2\text{Br}$, B: $\text{CH}_3\text{CH}_2\text{MgBr}$, C: $\text{CH}_3\text{CH}_2\text{COOH}$, D: $\text{CH}_3\text{CH}_2\text{CONHCH}_2\text{CH}_3$, E: $\text{CH}_3\text{CH}(\text{CH}_3)\text{COOH}$, F: $\text{CH}_3\text{CH}(\text{CH}_3)\text{COCl}$
3. (a) Use Hofmann degradation.

Reagents: NaOH and Br_2 Observation: colorless gas which turns milky lime water, CO_2 for the amide but no observation for the ester.

(b) Use any aqueous acid (a strong acid is better). For Na_2CO_3 (aq) one will observe an effervescence caused by the evolution of CO_2 gas. For the amide there will be formation of a soluble salt (no observable change).
4. (a)

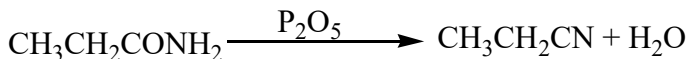
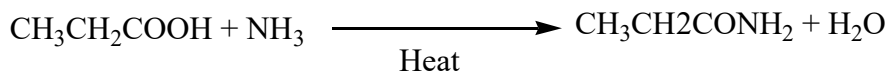
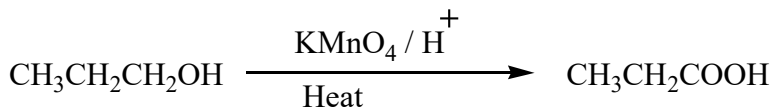

(b)

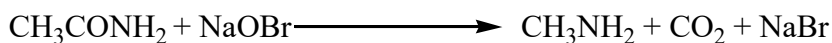
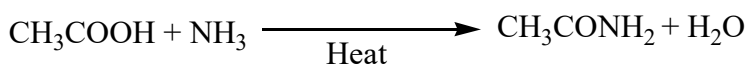
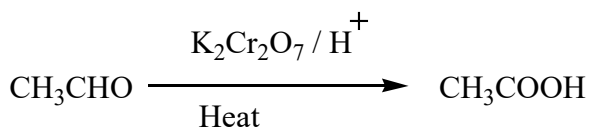

Lesson 8: Introduction to Nitriles

This lesson has 80 minutes (2periods). It will define what nitriles are, how they are named and their physical properties.

a) Introduction (5minutes)

Nitriles are acid derivatives and for a better understanding of their chemistry, learners need to know reactions of amides and preparation methods of carboxylic acids. Find a way of checking if they remember these points.

b) Teaching resources

Molecular structure Charts, Reference books, student's book or internet.

c) Learning activities

Give a brief introduction of the activity to be done and give time to learners to work collaboratively on the activity 8.8.

Methodological steps

You will guide learners through the following steps:

Activity 8.8

Refer to activity 8.4 and the general introduction for methodological steps and cross-cutting issues to be addressed.

Expected answers to activity 8.8

1. $\text{CH}_3\text{C}=\text{N}$
2. Nitriles
3. $\text{C}_2\text{H}_3\text{N}$
4. General structure: $\text{R}-\text{C}=\text{N}$, General Molecular formula: $\text{C}_n\text{H}_{2n-1}\text{N}$
5. These compounds are liquids or solids at room temperature even though they lack hydrogen bonding because they have strong dipole-dipole forces. The $\text{C}=\text{N}$ bond is highly polar.

Expected answers to checking up 8.8

1. (a) $\text{CH}_3\text{CH}_2\text{CH}_2\text{CN}$ (b) $\text{CH}_3\text{CH}_2\text{CH}(\text{CH}_3)\text{CH}_2\text{CN}$
2. (a) 2-methylpentanenitrile (b) 2,3-dimethylbutanenitrile
3. $\text{CH}_3\text{CH}_2\text{CH}_2\text{CN}$: butanenitrile, $\text{CH}_3\text{CH}(\text{CH}_3)\text{CN}$: 2-methylpropanenitrile

Choose the appropriate method of marking the work of your learners.

Lesson 9: Preparation and chemical properties of nitriles

This lesson has 80 minutes (2periods). It will describe the preparation methods, reduction and hydrolysis of nitriles.

a) Introduction (5minutes)

This lesson will be well delivered if students have understood the preparation of carboxylic acids and the meaning of reduction. They also need to know nucleophilic substitution of alkyl halides. As a facilitator you are supposed to find an appropriate method of helping your learners recall all of these points.

b) Learning activities

Briefly explain the task assigned to the learners and allow them to work on activity 8.9. in groups.

Methodological steps

You will guide learners through the following steps:

Activity 8.9

Refer to activity 8.4 and the general introduction for methodological steps and cross-cutting issues to be addressed.

Expected answerstoactivity 8.8

1. Halogenoalkanes react with -CN (aq) to produce nitriles. The halogen is substituted by the -CN ion.
2. The reaction mechanism for reaction in (1) is called **nucleophilic substitution**.
3. $\text{CH}_3\text{CH}_2\text{Cl} + \text{KCN(aq)} \longrightarrow \text{CH}_3\text{CH}_2\text{CN} + \text{KCl(aq)}$

Expectxted answers to checking up 8.9

1. (a) LiAlH_4 / Ether

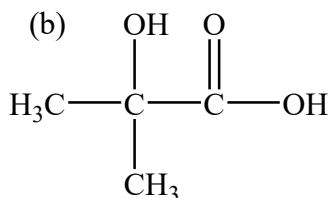

2. Hydrolysis is a chemical breakdown of a compound as a result of reacting with water.
3. This is because they undergo hydrolysis to produce a carboxylic acid.

8.7. Summary of the unit

In this unit you learnt esters, amides, acid anhydrides and nitriles. The figure below compares the reactivity of these compounds.

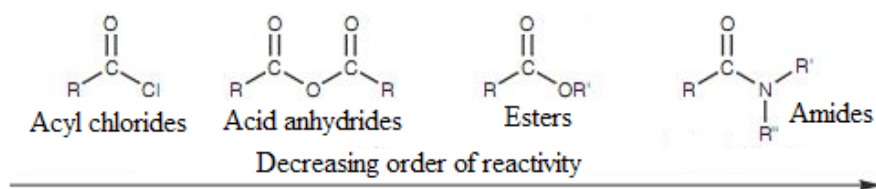

Esters contain the group

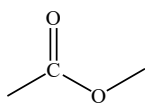

and they are known for their pleasant smells. They are prepared by a reaction of a carboxylic acid and an alcohol. They react with sodium hydroxide to produce a salt and an alcohol (this reaction is known as saponification and when oils and fats are used soap is produced). Esters are reduced to alcohols and hydrolyzed to

acids and alcohols.

Acid anhydrides contain the group

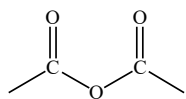

and they are prepared by dehydration of carboxylic acids. They are hydrolyzed to produce parent carboxylic acids. They react with alcohols and ammonia/amines to produce esters and amides respectively. Ethanoic anhydride is very important in the manufacture of aspirin.

Amides contain the group

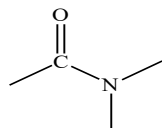

They are hydrolyzed to carboxylic acids, dehydrated to nitriles reduced by LiAlH_4 to amines and degraded to amines by NaOBr .

They are prepared from carboxylic acids and other acid derivatives when they react with ammonia or primary and secondary amines. Nylon textile is a polyamide.

Nitriles are also considered to be acid derivatives because they undergo hydrolysis to produce carboxylic acids. They are prepared by dehydrating amides and by nucleophilic substitution of the halogen in alkyl halides by CN^- from NaCN or KCN . In addition to hydrolysis, they are also reduced to amines.

8.8. Additional information for the teacher

- Some carboxylic acids containing the hydroxyl group can undergo esterification to produce cyclic esters. The latter are called lactones. Eg: 5-hydroxypentanoic acid.
- Oils and fats are both esters. Oils are less saturated and are liquids at rtp while fats are solids because they are more saturated. Saturation favors generation of strong intermolecular forces, Van der Waals forces.
- Saponification produces soap and glycerol. However, most soap factories do not produce glycerol because its separation is expensive. They mix oil and the base to get the soap without separating it with glycerol. The glycerin sold on market in the country is imported.
- Polyesters are polymers containing the ester functional group. They are used to make a variety of products. An example of this polymer is Terylene.
- There are two types of nylon: nylon-6 and nylon-6,6. Nylon-6 is produced by joining molecules of $\text{H}_2\text{N}(\text{CH}_2)_5\text{COOH}$ and nylon-6,6 is made by reacting $\text{H}_2\text{N}(\text{CH}_2)_6\text{NH}_2$ and $\text{HOOC}(\text{CH}_2)_4\text{COOH}$

8.9. End unit assessment (Answers)

Part I: Objective questions

1.C 2.C 3.D 4.C 5.C 6.D 7.A 8.D 9.C 10.B

Part II: Structured questions

15. a.methyl propanoate, b.N-methylpropanamide, c.ethanoic propanoic anhydride, d.propanenitrile, e.N,N-dimethylethanamide

16. a. $\text{CH}_3\text{ClCONH}_2$, b. $\text{CH}_3\text{OOCCH}_2\text{CH}_2\text{CH}_2\text{CH}_3$, c. $(\text{CH}_3\text{CH}_2\text{CH}_2\text{CO})_2\text{O}$, d. $\text{CH}_3\text{CH}_2\text{COCl}$,
e. $\text{CH}_3\text{CH}_2\text{CH}_2\text{CON}(\text{CH}_2\text{CH}_3)\text{CH}_2\text{CH}_2\text{CH}_3$

17. a. $\text{CH}_3\text{CH}_2\text{CONH}_2$, b. $\text{CH}_3\text{OOCCH}_3$, c. $\text{CH}_3\text{CH}_2\text{CH}_2\text{COOH}$, d. $\text{CH}_3\text{CH}_2\text{NH}_2$,
e. $\text{CH}_3\text{CH}_2\text{OOCCH}_2\text{CH}_3$

18. Preparation of compounds

a.

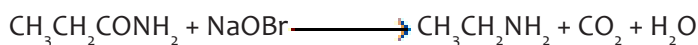
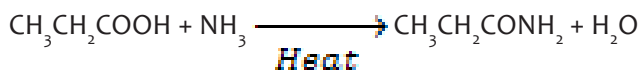

b.

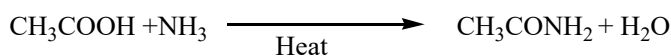
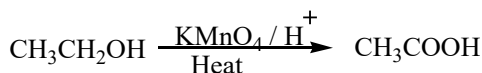
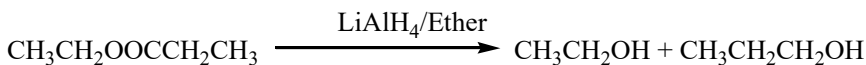

c.

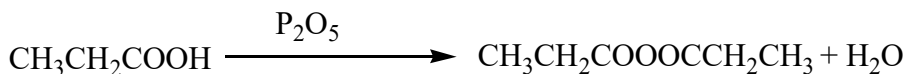

d.

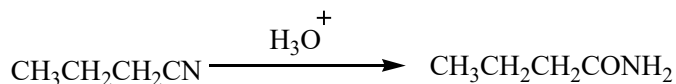

e.

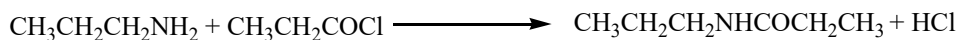
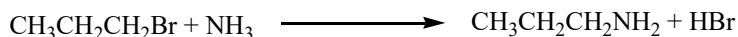
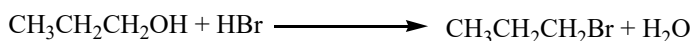
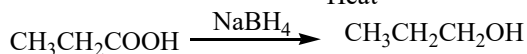
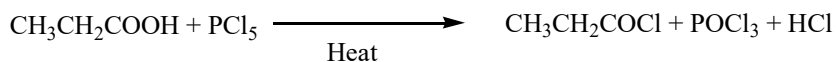

19. A: $\text{CH}_3\text{CH}_2\text{COCl}$, B: $\text{CH}_3\text{CH}_2\text{CONH}_2$, C: $\text{CH}_3\text{CH}_2\text{OH}$, D: $\text{CH}_3\text{CH}_2\text{COOCH}_3$,
E: $\text{CH}_3\text{CH}_2\text{COOCH}_3$, X: NaOH/Br_2 or NaOBr , Y: HNO_2 or NaNO_2/HCl ,
Z: CH_3OH

20. (a) $\text{CH}_3\text{CH}_2\text{OH}$, (b) $\text{CH}_3\text{CH}_2\text{Br}$, (c) $\text{CH}_3\text{CH}_2\text{MgBr}$, (d) $\text{CH}_3\text{CH}_2\text{COOH}$,
(e) $\text{CH}_3\text{CH}_2\text{COONa}$, (f) $\text{CH}_3\text{CH}_2\text{COCl}$, (g) $\text{CH}_3\text{CH}_2\text{COOOCCH}_2\text{CH}_3$

21. a. reagent: P_2O_5 or SOCl_2 , b. reagent: NH_3 , condition: heat, c. reagent: ethanol
conditions: strong acidic medium and heat

22. Ethanamide contains strong intermolecular forces, hydrogen bonding, which are absent in the acid anhydride.

23. Refer to the student's book lesson 8.1.2

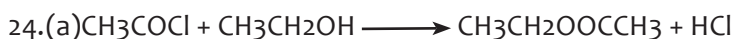

Mechanism

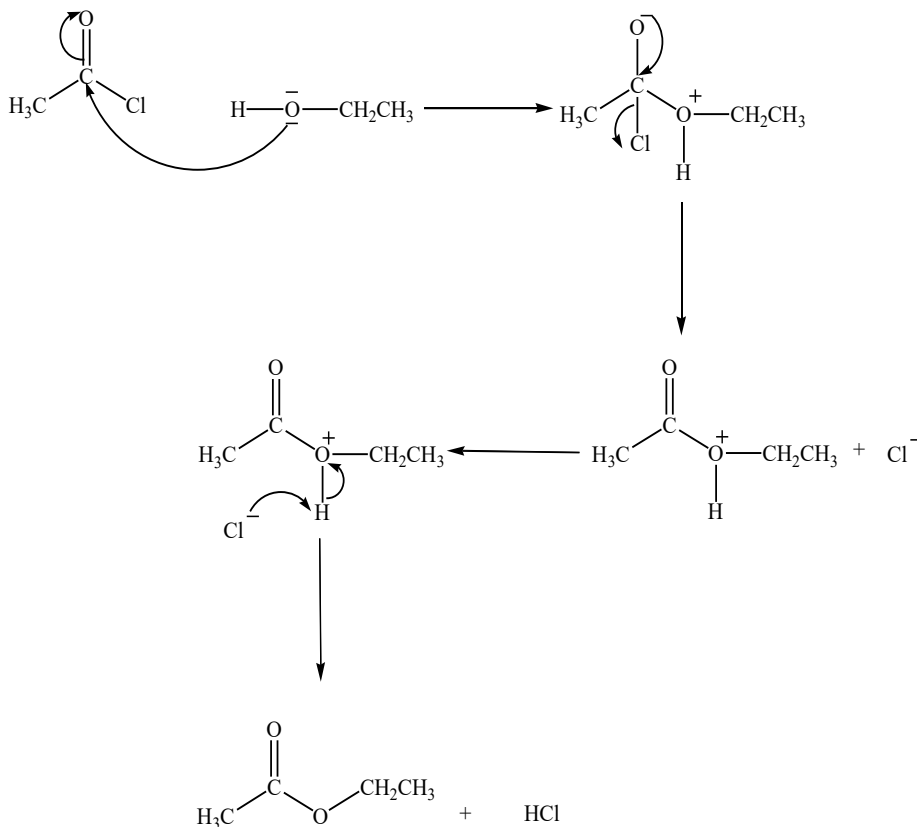

(b) Terylene is a polyester (condensation polymer). The ester groups in this polymer are hydrolyzed aqueous sodium hydroxide (caustic soda) destroying it. Polythene is an addition polymer which does not react with NaOH.

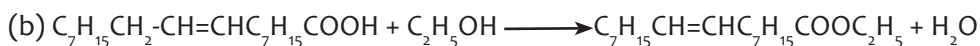
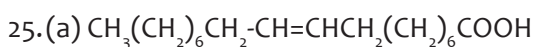

(c) From the triglyceride oleic acid can be prepared by acidic hydrolysis.

26.(a) Carbon: $49.4/12=4.116$

Hydrogen: $9.6/1=9.6$

Nitrogen: $19.1/14=1.3643$

Simplest ratio

$$\text{C} = \frac{4.116}{1.3643} = 3, \quad \text{H} = \frac{9.6}{1.3643} = 7, \quad \text{N} = \frac{1.3643}{1.3643} = 1$$

Empirical formula = $\text{C}_3\text{H}_7\text{NO}$

Simplest ratio

$$C = \frac{4.116}{1.3643} = 3, \quad H = \frac{9.6}{1.3643} = 7, \quad N = \frac{1.3643}{1.3643} = 1$$

Empirical formula = C_3H_7NO

Molecular formula

$$(C_3H_7NO)_n = 73$$

$$((12 \times 3) + 7 + 14 + 16)n = 73$$

$$73n = 73$$

$$n = 1$$

Molecular formula is $(C_3H_7NO) \times 1 = C_3H_7NO$

(ii)

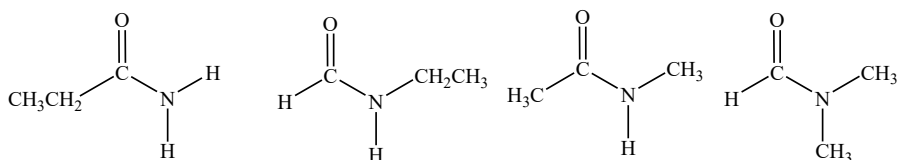

(b) i. Ethanoic acid and HCl

ii. Isopropyl ethanoate and HCl

iii. Ethanamide and HCl or $CH_3CONH_3^+Cl^-$

iv. Ethanoic anhydride and NaCl

8.10. Additional activities

8.10.1 Remedial Activities

1. Consider the following compounds:

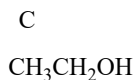
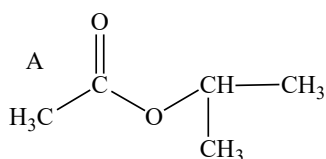

- a. Which is an ester?
- b. Which is a dibasic acid?
- c. Which is an acid anhydride?
- d. Name each compounds.
- e. Which would be almost insoluble in water, but would slowly dissolve when boiled with sodium hydroxide solution?
- f. Which would form a pleasant smelling liquid when warmed with ethanol and concentrated sulphuric acid?

Answers

- a. C
- b. D
- c. E
- d. A: methylpropanoic acid, C: methyl propanoate, D: butanedioic acid, E: Propanoic anhydride
- e. C

2.

Esters are derivatives of carboxylic acids and occur widely in nature.

- a. Draw the structure of the ester formed when ethanol reacts with 2-methyl propanoic acid.
- b. Name an alternative reagent which may be used in place of methylpropanoic acid to produce the ester.

Answers

- a. $\text{CH}_3\text{CH}_2\text{OOCCH}(\text{CH}_3)_2$
- b. Methyl propanoyl chloride

3.

- a. A triglyceride represented by letter A is an ester derived from glycerol and 3 fatty acids: hexadecanoic acid, octadecanoic acid and 2,4-hexadienoic acid. Write the structural formula of the triglyceride.

b. (i) Write the equation of reaction between the triglyceride above and sodium hydroxide.

(ii) What is the importance of this reaction?

Answers:

a.

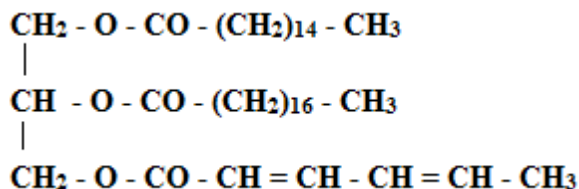

b. (i)

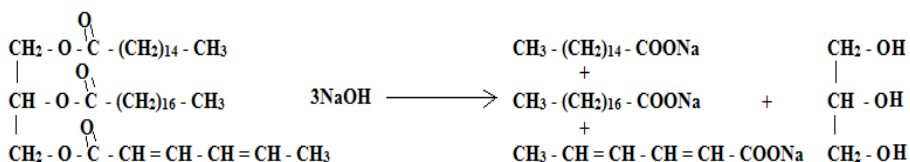

(ii) This reaction is used in making soap.

4. Describe how you can distinguish the compounds below. Include relevant observations in your answer.

- $\text{CH}_3\text{CH}_2\text{COCl}$ and $\text{CH}_3\text{CH}_2\text{CH}_2\text{Cl}$
- CH_3CONH_2 and $\text{CH}_3\text{CH}_2\text{NH}_2$
- $\text{CH}_3\text{CH}_2\text{CN}$ and $\text{CH}_3\text{CH}_2\text{COOCH}_3$

Answers

- Dissolve both compounds separately in some water and test the acidity of resulting solutions. $\text{CH}_3\text{CH}_2\text{COCl}$ solution will be acidic but the other one will be neutral.
- React both compounds with NaOBr separately. CH_3CONH_2 produces a colorless gas which turns milky lime water but for the amine there is no observable change.
- Hydrolyze while heating both compounds and test the evolved vapors with litmus papers. $\text{CH}_3\text{CH}_2\text{CN}$ would produce ammonia which turns red litmus paper blue.

5.

a. Write an equation for the reaction of ethanoyl bromide with CH_3MgCl .

b. Explain why animal urine is used as a fertilizer

Answers



b. Animal urine contains urea, a substance which has high nitrogen content. It is used to provide nitrogen to plants.

6.

Draw the structural formulae of all possible isomers with molecular formula $\text{C}_4\text{H}_9\text{NO}$ and name them.

Answers

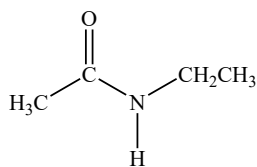
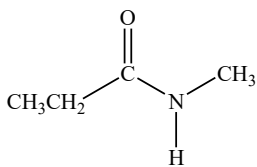
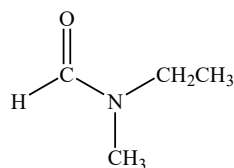
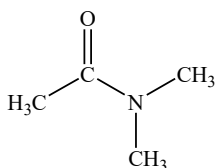
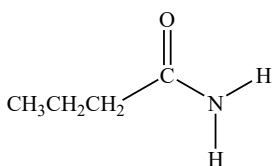

7.

Compare the boiling points of ethanoic acid, ethyl ethanoate and ethanamide. Explain your reasoning.

Answers

Ethanoic acid has highest boiling point because it has more and stronger hydrogen bonding. Ethanol will be next to the acid because hydrogen bonds between oxygen and hydrogen are stronger than those involving nitrogen. This is because of small electronegativity of nitrogen.

8. Complete the equations below

Answers

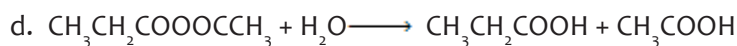
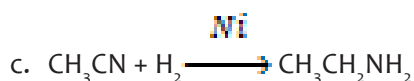
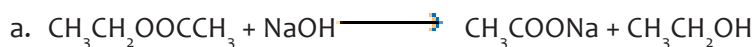

8.10.2 Consolidation activities

1. Two esters, A and B, have molecular formula $\text{C}_6\text{H}_{12}\text{O}_2$. Both show optical isomerism. When heated with aqueous sodium hydroxide, A gives sodium ethanoate and another product, and B gives methanol and another products. Write the structural formulae for A and B and name them.

Answers

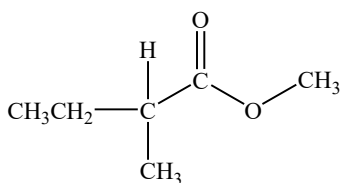

Methyl-2-methylbutanoate

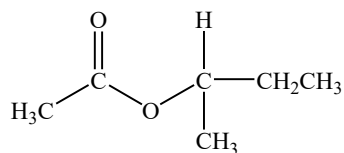

1-methylpropylethanoate

2. A liquid A of molecular formula $\text{C}_5\text{H}_{10}\text{O}_2$ was reduced by LiAlH_4 to a mixture of two alcohols **B** and **C**. Both alcohols reacted with iodine in alkaline solution to give a pale yellow crystalline solid **D**. The liquid A is insoluble in cold, dilute aqueous sodium hydroxide but on boiling the mixture gradually becomes one layer. Give that the boiling point of **B** is higher than that of **C**, identify and draw structural formulae of **A**, **B**, **C** and **D**. Give your reasoning

Answers

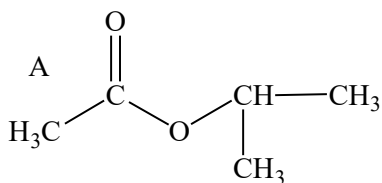

B



C



D



Alcohols which react with iodine in alkaline solution must be ethanol or methyl alcohol. A is an ester because it is insoluble cold aqueous NaOH but dissolves on boiling because of being hydrolyzed. B has higher boiling point because it has bigger molecular mass.

3. State and explain the conditions necessary for converting an aldehyde into a cyanohydrin.

Answers

An aldehyde reacts with HCN in the presence of a strong base or aqueous KCN. The strong base or KCN is used to facilitate the release of CN⁻ ions as HCN is a weak base.

4. The nitrile group can be introduced into a molecule by dehydration of an amide. Outline a reaction scheme, giving names or formulae for the reagents, for the preparation of ethanenitrile from ethanal.

Answer

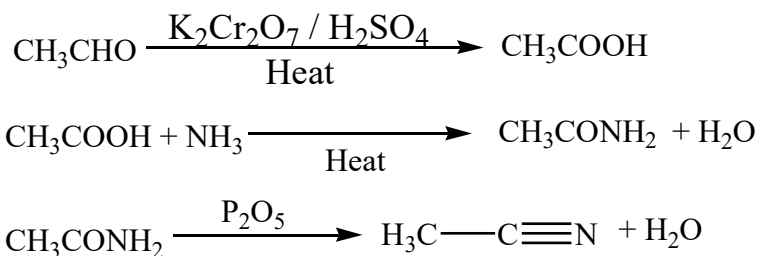

5. (a) What do you think would be formed when soap is heated with soda lime?
- (b) Suggest explanations for the following observations.
- (i) Butane, propan-1-ol, propanal and ethanoic acid all have approximately the same relative molecular mass, but their boiling points are 273K, 371K, 322K and 391K, respectively.
- (ii) When dilute hydrochloric acid is added to an aqueous solution of soap, a white insoluble substance is formed.

Answers

- a. A hydrocarbon with one less carbon to the number of carbon atoms of the soap. A decarboxylation of a sodium salt of a carboxylic acid will take place.
- b. (i) These compounds have different intermolecular forces. Butane has weakest intermolecular forces (Van der Waals forces) and propanal has weak dipole-dipole forces. Propan-1-ol has strong hydrogen bonding as well as ethanoic acid, but their magnitude in the acid is bigger.
- (ii) Salts of carboxylic acids react with mineral acids to regenerate the parent acid. Soap is a carboxylic salt which will react to regenerate the parent fatty acid which is insoluble in water, the white substance.

8.10.3 Extended activities

1. Naturally occurring fats and oils are esters of acids with an even number of carbon atoms. Acids with an odd number of carbon atoms are rare. Suggest a method of producing a fatty acid and increasing its length by one carbon atom from propyl tristearate. Include equations in your answer.

Answers

Method: Hydrolyze propyl tristearate; reduce the produced acid to an alcohol, substitute the OH group by a halogen, convert the produced alkyl halide into a Grignard reagent and carboxylate it.

Equations:

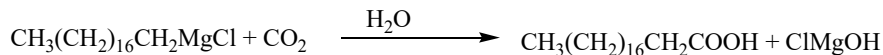
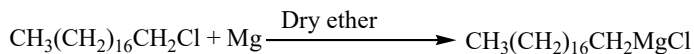
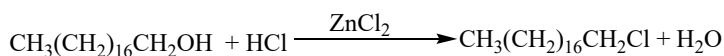
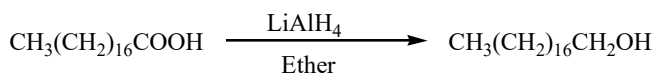
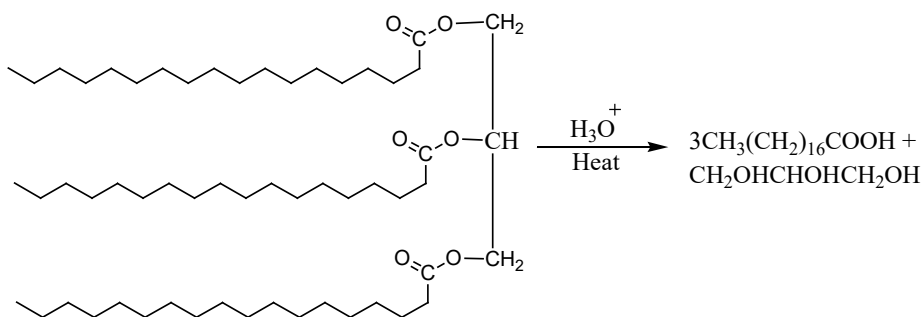

What are the products of the reactions of $\text{CH}_3\text{CH}=\text{CHCH}_2\text{CO}_2\text{C}_2\text{H}_5$ with:

- NaOH, Heat
- H_2 , Ni
- Br_2
- O_3 followed by H_2O



Answers

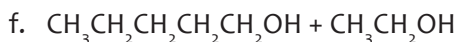
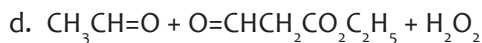
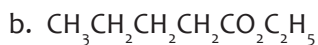
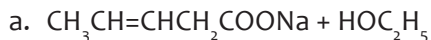

2. The complete hydrolysis of 1.76g of an ester of a monocarboxylic acid and a monohydric alcohol required 2.0×10^{-2} mol of sodium hydroxide. Deduce its molecular formula, and write the names and structural formulae of all the esters with this molecular formula.

Answer

1mol of NaOH reacts with 1mol of the ester (the ester is produced from a monohydric alcohol)

2.0×10^{-2} mol of NaOH will react with 2.0×10^{-2} mol of the ester.

$$n = m/M_m$$

$$M_m = m/n = 1.76/0.02 = 88 \text{ g/mol}$$

$$\text{C}_n\text{H}_{2n}\text{O}_2 = 88$$

$$12n + 2n = 88 - 32$$

$$14n = 56$$

$$n = 56/14 = 4$$

Molecular formula is $\text{C}_4\text{H}_8\text{O}_2$

Structures and names

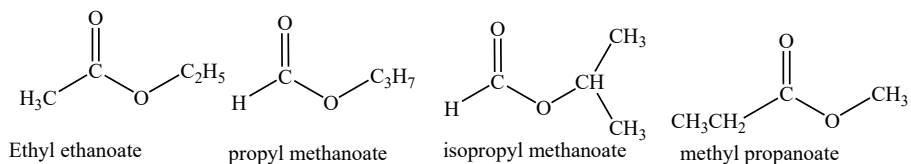

3. A and B are two isomeric amides which can be hydrolyzed in acidic medium.

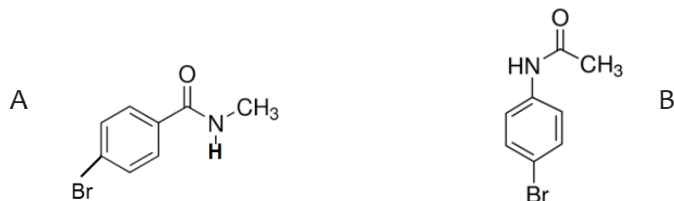

- Draw the structures of the products formed from hydrolyzing A and B.
- What is the structure of the compound produced when A reacts with sodium hypobromite?
- Write an equation for the reaction of B with ethanoyl chloride.

Answers

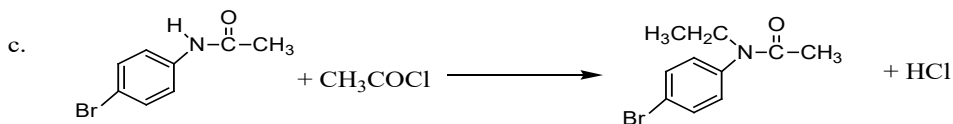
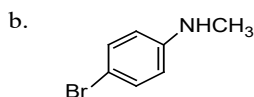

4. Three chlorine-containing compounds can be prepared from acetic acid (A) by the following routes:

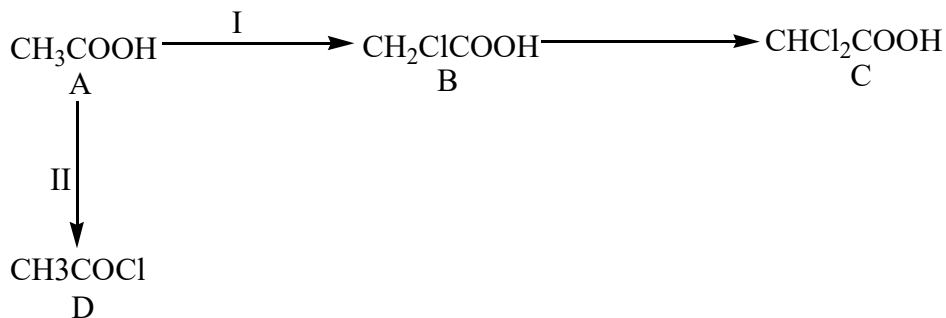

- Suggest reagents and conditions for reactions I and II.
- When D reacts with ethanol, steamy fumes are evolved and a fruity smelling liquid is produced. Write a balanced equation for this reaction.
- When compounds A, B and D (not necessarily in that order) are added to separate portions of water, solutions are found to have pH values of 0.5, 2.5 and 3.0. When aqueous silver nitrate is added to these three solutions, two show no reaction but the third one produces a thick white precipitate. Suggest, with explanations, which pH value is associated with each of A, B and D. Explain the formation of the white precipitate.
- Predict, with a reason, the likely pH value of an aqueous solution of compound C.

Answers

- I: Cl_2 in the presence of UV light, II: PCl_5 at room temperature
- $\text{CH}_3\text{COCl} + \text{CH}_3\text{CH}_2\text{OH} \longrightarrow \text{CH}_3\text{COOCH}_2\text{CH}_3 + \text{HCl}$
- A=3.0, B=2.5, D=0.5

Explanation

Acid A is a weak acid but when the hydrogen atom in alpha position is substituted by chlorine its acidity increases reason why B has a lower pH. The O-H bond in B is weaker so that more H^+ ions are released in aqueous solution. D hydrolyzes in water to produce HCl, a strong acid, giving a pH of 0.5.

- Its pH will be lower than 2.5 because its O-H bond is more weakened due to the presence of 2 chlorine atoms in alpha position. But it will not be lower than 0.5 because still it is an organic acid.

UNIT 9: AMINES AND AMINO ACIDS

9

9.1 Key unit competence

The learner should be able to relate the chemical nature of the amines and amino acids to their properties, uses and reactivity

9.2 Prerequisites

For learning contents of this unit 9 (amines and amino acids), each learner should have enough knowledge in organic chemistry: Introduction to organic chemistry, Alkanes, Alkenes and alkynes, Halogenoalkanes, Alcohols and ethers, Carbonyl compounds, Carboxylic acids and acyl halides as well as Esters, acid anhydrides, amides and nitriles.

For each of those mentioned topics, the students should be confident in their identification, nomenclature, physical properties, natural occurrence, their preparation, chemical properties, and usage.

9.3 Cross-cutting issues to be addressed

For this unit 9 (amines and amino acids), three cross cutting issues should be addressed in some or all lessons. You should note that you can integrate cross cutting issues other than the one proposed in this teacher's guide, depending on your class.

a. Peace and Values Education

This cross cutting issue is **compulsory for the Chemistry subject**: you are advised to address this cross cutting issue frequently. Laboratory activities, group work, discussions in the classroom and many other interactions in the learning process should help to create a peaceful society, and it is your responsibility to make sure that in each lesson of the unit 9, this cross cutting issue is addressed. You must encourage learners to help each other and to respect opinions of colleagues. National values should be also emphasized on politeness, generosity ... (*ikinyabupfura*).

b. Standardisation Culture

This cross cutting issue is compulsory for the Chemistry subject: you are advised to address this cross cutting issue frequently. IUPAC (International Union of Pure and Applied Chemistry) has set a number of rules related to nomenclature of organic and inorganic compounds. Respecting those standards of nomenclature as well as standards in writing formulas, using international recognised units ... are one of the ways to address the standardisation culture as cross cutting issue. You must train students on the respect of those standards and many others.

c. Inclusive Education

This cross cutting issue is **compulsory for the Chemistry subject**: you are advised to address this cross cutting issue frequently. Make sure that all learners are engaged in education regardless their age, sex, physical appearance, physical and/or mental impairment, special gifts/talents ... and make sure that all of those learners are well welcomed by other students so that everyone can achieve their potential. You should make sure that no learner will be left behind, frustrated or ignored. If there is any group work, heterogeneous groups should be formed and activities should be relevant to each category of students depending on their abilities.

In case there is no student who needs special attention (like in a boy's school or girl's school where there is no student with impairment or special talent), you should make sure that you engages discussions on the issue, depending the type of today's lesson.

To be successful, inclusive education as cross cutting issue involves a range of issues including teacher's positive attitudes, adapting the learning resources, variation of teaching and learning methods and working together.

9.4 Guidance on introductory activity

At the beginning of this unit, a reflection question is provided in the learner's book. The following instructions should be followed:

- The activity should be done individually, in less than 10 minutes.
- Each student tries to answer to the questions individually. All the three questions should be answered.
- No answers should be provided for this activity. Learners will discover step by step the answers for this activity.
- The expected answers for this activity are the following:

Answers to introductory activity

1. DNA and proteins have in common the amino acids which are their building blocks.
2. See learners book.
3. If protein molecules are made essentially of Carbon, Hydrogen, Oxygen, Nitrogen and amino acid side chains (figure C):
 - a. Covalent bonds C-C, C-H, C-O, C-N, N-H, H-O, ...
 - b. Acid related reactions (due to the presence of -COOH function) and base related reactions (due to the presence of -NH₂ function) in amino acids.

9.5 List of lessons

The unit 9 (amines and amino acids) should be taught in 11 periods. All activities, contents and assessments should be done in that period of time.

	Lesson Title	Learning Objectives	Number of periods
1	Nomenclature and classification of amines	Apply IUPAC rules to name primary, secondary and tertiary amines them.	1
2	Physical properties, natural occurrences and uses of amines	Describe the physical properties and uses of amines.	1
3	Preparation of amines	Describe the preparation methods of the amines.	1
4	Chemical properties of amines	Recognise and apply chemical properties of amines	2
5	General structure of amino acids and some common examples	Apply the general structure of amino acids and some common examples	1
6	Comparison of physical properties amino acids to those of carboxylic acids and amines	Compare the physical properties of the amino acids to those of the carboxylic acids and amines.	1
7	Chemical properties of amino acids	Describe the reactions of amino acids and amines with other substances.	1
8	Optical isomers of amino acids	Write the optical isomers of the amino acids.	1
9	Peptides and polypeptides	Appreciate the importance of amino acids as the building blocks for proteins in our bodies.	1
10	Summative assessment	To relate the chemical nature of the amines and amino acids to their properties, uses and reactivity	1

9.6. Guidance on the lessons

Lesson 1: Nomenclature and classification of amines (80minutes)



a. Introduction

Students to learn this lesson, they should have learned nomenclature and classification of alcohols. The activity 9.1 in learners book will be used as introductory or revision activity. Since this lesson has only 40 minutes, the revision should take less than 7 minutes of time.

The box below shows answers for the given activity.

Proposed answers to activity 9.1

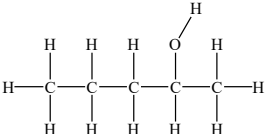
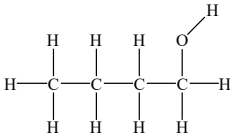
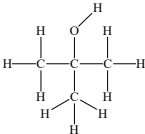
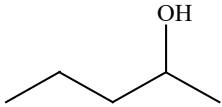
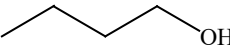
1.

	Pentan-2-ol	butan-1-ol	2-methylpropan-2-ol
molecular formula	$C_5H_{11}OH$ or $C_5H_{12}O$	C_4H_9OH or $C_4H_{10}O$	C_4H_9OH or $C_4H_{10}O$
structural formula	$CH_3CH_2CH_2CHOHCH_3$	$CH_3CH_2CH_2CH_2OH$	$CH_3COH(CH_3)_2$
displayed formula			
skeletal formula			
class	secondary	primary	tertiary alcohol

2. General formula that is used to represent alcohols: $C_nH_{2n+1}OH$

3. Butan-1-ol and 2-methylpropan-2-ol. Structural isomers.

4. $CH_3CH_2COH(CH_3)_2$: 2-methylbutan-2-ol

b. Teaching resources

You should avail the following resources: molecular models, chalkboard and chemistry books (learners books and reference books). A periodic table of elements and access to internet may also be necessary.

c. Learning activities

The learning activities for this lesson will be designed so as to help learners to develop competencies. You are advised to choose which activities suit the best to his class.

- Helps learners to form groups of 4-5 students.

- **In groups**, students revise about alcohols using the activity proposed in the learner's book (activity 9.1).
- The duration for this activity should not exceed **7 minutes**.
- Introduce the new lesson and make relevant explanations, based in the learners' findings in activity 9.1. **This activity will help learners to discover that alcohols and amines have almost same way of classification but different way of nomenclature (primary, secondary & tertiary amines or alcohols)**
- While explaining, ask to learners relevant application questions to involve them in the teaching and learning activities.
- Students should have their textbooks, and access to reference books is necessary.
- Individually, learners do self-evaluation exercises proposed in learner's book on (Checking up 9.1)
- Discuss and present their finding in plenary.

Note: due to limited time allocated to this lesson, homework should be provided to learners. It should be composed by a series of exercises related to nomenclature and classification of amines

d. Application activities

Application activities (checking up activities 9.1) are provided in learners' book. The box below shows their answers.

Proposed answers to checking up 9.1

1.

a

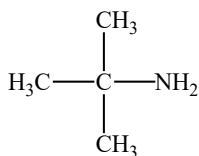

Primary amine

c

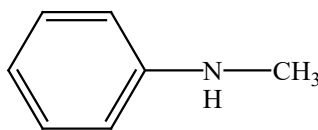

secondary amine

e

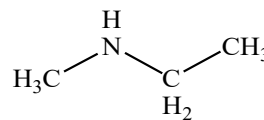

secondary amine

b

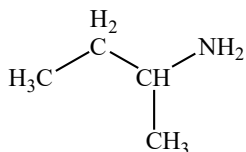

Primary amine

d

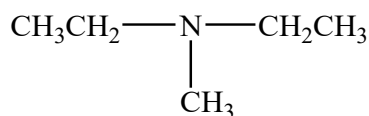

Tertiary amine

2.

	IUPAC name
CH_3NH_2	Methylamine
$\text{CH}_3\text{CH}_2\text{CH}_2\text{NH}_2$	Propylamine
$\text{CH}_3\text{CHNH}_2\text{CH}_3$	Isopropylamine
$\text{CH}_3\text{NHCH}_2\text{CH}_3$	Ethyl-methyl-amine
$\text{CH}_3\text{CH}_2\text{N}(\text{CH}_3)\text{CH}_2\text{CH}_2\text{CH}_3$	Ethyl-methyl-propyl-amine

3.

- i. 1-methylethylamine or propan-2-amine (**primary amine**)
- ii. Propan-1-amine (**primary amine**)
- iii. N-methyl-2-methylethylamine or N-methylpropan-2-amine (**secondary amine**)
- iv. 2-methylpropan-2-amine (**primary amine**)
- v. N-methylbenzenamine or N-methylaniline (**secondary amine**)
- vi. N-Ethyl-N-methylethanamine (**tertiary amine**)

Lesson 2: Physical properties, natural occurrences and uses of amines (80minutes)

a. Introduction

Students to learn this lesson, they should be confident with physical properties of common organic compounds. The activity 9.2 in learner's book is about calculation of the molecular weight of given products and justification of the difference between boiling points of given amines, alkanes and alcohols. It will be used as introductory activity of the lesson. Since this lesson has only 40 minutes, the revision should take less than 10 minutes of time.

The box below shows answers for the given activity.

Proposed answers to activity 9.2

Name	Molecular weight	Boiling point
Methanol (CH ₃ OH)	31.06 g/mol	65°C
Methylamine (CH ₃ NH ₂)	30.07 g/mol	-6°C
Ethane (CH ₃ CH ₃)	32.04 g/mol	-89°C
1-propanol (CH ₃ CH ₂ CH ₂ OH)	60.1 g/mol	97°C
propyl Amine (CH ₃ CH ₂ CH ₂ NH ₂)	59.1 g/mol	48°C
Ethylmethylamine (CH ₃ NHCH ₂ CH ₃)	59.1 g/mol	36°C
Trimethylamine N(CH ₃) ₃	59.1 g/mol	2.9°C
Butane (CH ₃ CH ₂ CH ₂ CH ₃)	58.1 g/mol	-0.5°C
Butylamine (n-C ₄ H ₉ NH ₂)	73 g/mol	77.65°C
Diethyl-amine [(C ₂ H ₅) ₂ NH]	73 g/mol	56.15°C
Ethyl-dimethyl-amine [C ₂ H ₅ N(CH ₃) ₂]	73 g/mol	37.35°C
2-Methyl-butane [C ₂ H ₅ CH(CH ₃) ₂]	72 g/mol	27.65°C
Butan-1-ol (n-C ₄ H ₉ OH)	74 g/mol	117.15°C

Based on the molecular weights and boiling points of given molecules, we can deduce that primary and secondary amines boil at higher temperatures than alkanes and tertiary amines, but at lower temperatures than alcohols of comparable molar mass.

b. Teaching resources

You should avail the following resources: molecular models, chalkboard and chemistry books (learners books and reference books). A periodic table of elements and access to internet may also be necessary.

c. Learning activities

The learning activities for this lesson will be designed so as to help learners to develop competencies. You are advised to choose which activities suit the best to his class.

- Help learners to form groups of 4-5 students.
- **In groups**, students perform the activity proposed in the learner's book (activity 9.2), about comparison of boiling points of amines, alcohols and alkanes of same molecular weights.
- The duration for this activity should not exceed 10 minutes.
- Introduce the new lesson and make relevant explanations, based in the learners' findings in activity 9.2.
- While explaining, ask to learners relevant application questions to involve them in the teaching and learning activities.
- Individually, learners do self-evaluation exercises proposed in learner's book (Checking up 9.2).
- Discuss and present their finding in plenary.

Note: You can alternatively to the activity 9.2 (introduction to physical properties of amines), let learners perform an experiment for identification of physical properties of amines which is proposed in the section "Consolidation activities" of this teacher's guide.

d. Application activities

Application activities (checking up activities 9.2) are provided in learner's book.

Proposed answers to checking up 9.2

1.
 - a. butylamine because the N-H bonds can engage in hydrogen bonding; pentane cannot engage in hydrogen bonding
 - b. $\text{CH}_3\text{CH}_2\text{CH}_2\text{CH}_2\text{CH}_2\text{NH}_2$ because it has a greater molar mass than CH_3NH_2
2. $\text{CH}_3\text{CH}_2\text{NH}_2$ because amines can engage in hydrogen bonding with water; alkanes cannot engage in hydrogen bonding

Lesson 3: Preparation of amines (80minutes)

a. Prerequisites/Revision

To learn this lesson, learners should be confident in explaining physical properties of common organic compounds. The activity 9.3 in learner's book is about reaction of ammonia with water. It will be used as learning activity of the lesson. Since this lesson has only 40 minutes, the revision should take less than 4 minutes of time.

The box below shows answers for the given activity.

Proposed answers to activity 9.3

Ammonia and water molecules are reactants, while the ammonium ion and the hydroxide ion are products: $\text{NH}_3(\text{aq}) + \text{H}_2\text{O}(\ell) \longrightarrow \text{NH}_4^+(\text{aq}) + \text{OH}^-(\text{aq})$

What has happened in this reaction is that the original water molecule has donated a hydrogen ion to the original ammonia molecule, which in turn has accepted the hydrogen ion. We can illustrate this as follows:

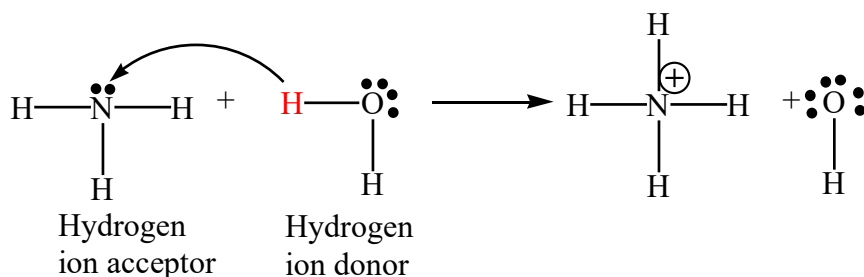

b. Teaching resources

You will avail the following resources: molecular models, chalkboard and chemistry books (learners books and reference books). A periodic table of elements and access to internet may also be necessary.

c. Learning activities

The learning activities for this lesson will be designed so as to help learners to develop competences. You are advised to choose which activities suit the best to his class.

- Invite students to work *individually* on the activity proposed in the learner's book (activity 9.3).
- The duration for this activity should not exceed 4 minutes.
- Introduce the new lesson and make relevant explanations, based in the learners' findings in activity 9.3.
- While explaining, ask to learners relevant application questions to involve

them in the teaching and learning activities.

- Individually, learners do self-evaluation exercises proposed in learner's book on (Checking up 9.3)
- Discuss and present their finding in plenary.

Note: A practical experiment for preparation of amines is proposed in the section "Consolidation activities" of this teacher's guide; it should be done before or during the lesson itself.

d. Application activities

Application activities (checking up activities 9.3) are provided in learner's book. The box below shows their answers.

Proposed answers to checking up 9.3

1. LiAlH_4 and H_2 with a platinum, palladium or nickel catalyst. (NaBH_4 does not work.)
2. For LiAlH_4 the reaction takes place in ethoxyethane solution. With catalyst and H_2 the amine is heated with H_2 in the presence of the metal.

3.

a.

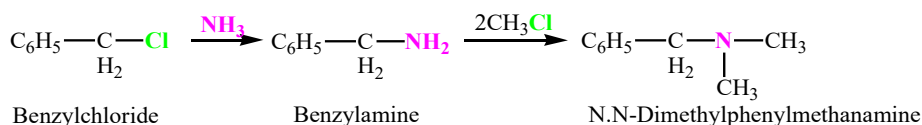

b.

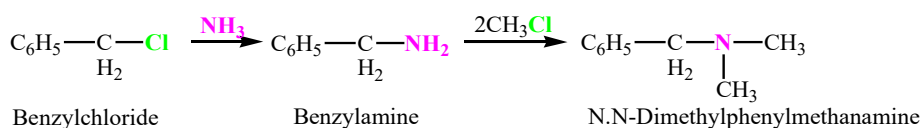

Lesson 4: Chemical properties of amines (80minutes)

a. Introduction

To learn this lesson, students should be confident with physical properties of amines. The activity 9.4 in learner's book is about reaction of ethylamine at room temperature, with hydrochloric acid and excess of sodium hydroxide. It will be used as the learning activity of the lesson. Since this lesson has only 2 periods – 80 minutes, the experiment take less than 20 minutes of time.

The box below shows expected results of the experiment.

Proposed answers to activity 9.4

Observations: The solution of ethylamine has a characteristic smell (A). When dilute hydrochloric acid is added in the solution (B), the temperature raises and the smell disappears (C). When excess of sodium hydroxide is added in the solution (D), the smell of amine returns (E).

Interpretation: like ammonia, the ethylamine carries a lone pair of electrons on its nitrogen atom. This enables it to form a dative bond to hydrogen ion from HCl:

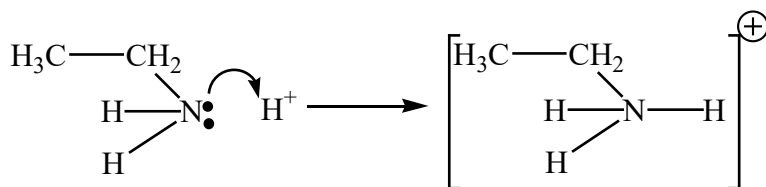

Ethylamine is therefore a base like ammonia: when an acid is added to a solution of ethylamine, a salt is formed, ethylammonium chloride ($\text{CH}_3\text{CH}_2\text{NH}_3^+ \text{Cl}^-$). Like all salts, it is involatile and therefore has no smell.

When NaOH (strong base) is added to this salt, protons are removed from it. This reforms the free amine (ethylamine).



b. Teaching resources

You should avail the following resources: beakers, thermometer, hydrochloric acid, sodium hydroxide, molecular models, chalkboard and chemistry books (learners books and reference books). A periodic table of elements and access to internet may also be necessary.

c. Learning activities

The learning activities for this lesson will be designed so as to help learners to develop competencies. You are advised to choose which activities suit the best to his class.

Helps learners to form groups of 4-5 students.

- **In groups**, students perform the activity proposed in the learner's book (activity 9.4), about the reaction between ethylamine and HCl as well as with NaOH.
- The duration for this activity should not exceed 20 minutes.
- Introduce the new lesson and make relevant explanations, based on the learners' findings in activity 9.3.

- While explaining, ask learners relevant application questions to involve them in the teaching and learning activities.
- Individually, learners do self-evaluation exercises proposed in learner's book (Checking up 9.3)
- Discuss and present their finding in plenary.

Note: due to limited time allocated to this lesson, homework should be provided to learners. It should be composed by a series of exercises related to chemical properties of amines and their reactivity.

d. Application activities

Application activities (checking up activities 9.4) are provided in learner's book. Their answers are given in the box below.

Proposed answers to checking up 9.4

1.

$\begin{array}{c} \text{H}_2 \quad \text{H}_2 \\ \quad \\ \text{H}_2\text{N}-\text{C}-\text{C}-\text{CH}_3 \\ \quad \\ \text{H}_2 \quad \text{H}_2 \\ \text{n-Butylamine} \end{array}$	$\begin{array}{c} \text{H}_2 \quad \text{H}_2 \\ \quad \\ \text{H}_3\text{C}-\text{C}-\text{N}-\text{C}-\text{CH}_3 \\ \quad \\ \text{H} \quad \text{H} \\ \text{Diethylamine} \end{array}$	$\begin{array}{c} \text{NH}_2 \\ \\ \text{H}_3\text{C}-\text{C}-\text{CH}-\text{CH}_3 \\ \quad \\ \text{H}_2 \quad \text{H}_2 \\ \text{sec-Butylamine} \end{array}$
$\begin{array}{c} \text{CH}_3 \\ \\ \text{H}_3\text{C}-\text{C}-\text{CH}_3 \\ \\ \text{NH}_2 \\ \text{tert-Butylamine} \end{array}$	$\begin{array}{c} \text{CH}_3 \\ \\ \text{H}_3\text{C}-\text{C}-\text{N}-\text{CH}_3 \\ \quad \\ \text{H}_2 \quad \text{H}_2 \\ \text{Dimethylethylamine} \end{array}$	$\begin{array}{c} \text{CH}_3 \\ \\ \text{H}_2\text{N}-\text{C}-\text{CH}-\text{CH}_3 \\ \quad \\ \text{H}_2 \quad \text{H}_2 \\ \text{Isobutylamine} \end{array}$

2.

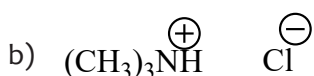
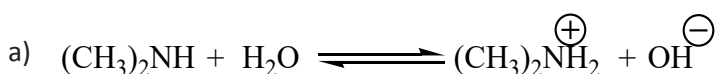

3. Acidify the amine with dilute hydrochloric acid and then add sodium or potassium nitrite solution.

4.

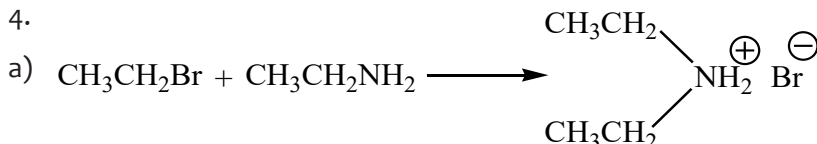

In the first reaction, the bromine is pushed off the ethyl group as a bromide ion, and is replaced by the whole of the amine to form an ammonium-like ion. The product is

diethylammonium bromide.

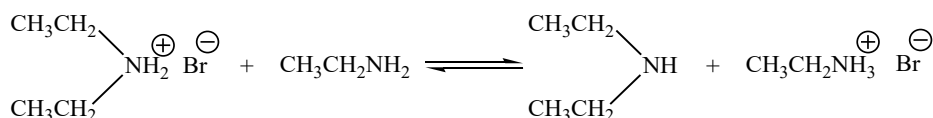

In the second reaction, equilibrium is set up involving a reaction between another ethylamine molecule which removes a hydrogen ion from the diethylammonium ion and forms the free diethylamine. In the process, ethylammonium bromide is formed. A similar reaction can happen between the two compounds on the right-hand side of the equation, reversing the reaction.

b.

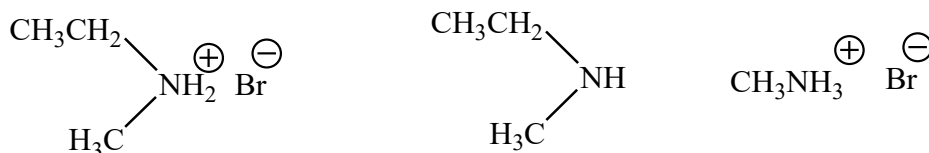

c)

d)

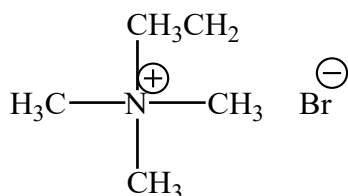

It doesn't matter how you have positioned the hydrocarbon groups around the nitrogen in this or the similar example in part (c).

If you got these last three parts right, very well done! Having two different hydrocarbon groups involved makes the whole process seem much more difficult than it already is.

Lesson 5: General structure of amino acids and some common examples

a. Introduction

To learn this lesson, students should be confident with general structure of amines and carboxylic acids. The activity 9.5 in learner's book is about prediction of a general structure (displayed formula) of a molecule that contains an amino group and a carboxyl group on an aliphatic chain. It will be used as the learning activity of the lesson. The box below contains expected answer for that activity:

Proposed answers to checking up 9.5

1.

a. The side chain of serine:

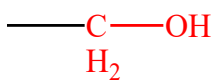

b. The side chain of arginine

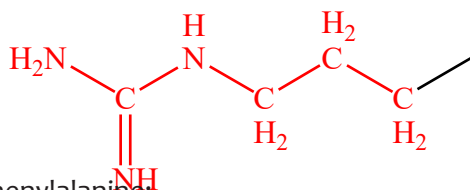

c. The side chain of phenylalanine:

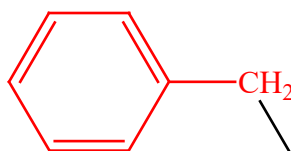

d. The structure for alanine:

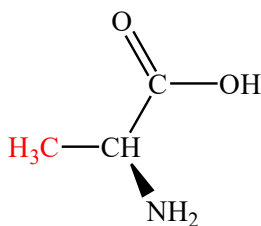

e. The structure for cysteine:

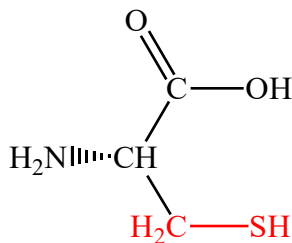

f. The structure for histidine:

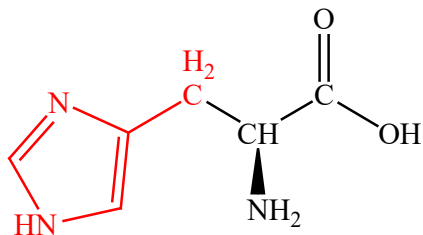

g. The amino acids whose side chain contain an amide functional group are *asparagine or glutamine*

- h. The amino acids whose side chain contain an aromatic ring are *phenylalanine, tyrosine, or tryptophan*
- i. The amino acids whose side chain contain a carboxyl group are *aspartic acid or glutamic acid*

Lesson 6: Comparison of physical properties amino acids to those of carboxylic acids and amines

a. Introduction

To learn this lesson, learners should be confident with general structure of amines and carboxylic acids. The activity 9.6 in learner's book is about characteristic odour of Amines, Carboxylic acids and Amino acids. It will be used as a learning activity of the lesson. Since this lesson has only 40 minutes, the activity should be done in less than 5.

The box below contains expected results of the activity.

Proposed answers to activity 9.6

See table 9.4 in Learners' book.

b. Teaching resources

You should avail the following resources: molecular models, chalkboard and chemistry books (learners books and reference books). A periodic table of elements and access to internet may also be necessary.

c. Learning activities

The learning activities for this lesson will be designed so as to help learners to develop competencies. You are advised to choose which activities suit the best to his class.

- Invite students to work *individually* on the activity proposed in the learner's book (activity 9.6).
- The duration for this activity should not exceed 5 *minutes*.
- Introduce the new lesson and make relevant explanations, based in the learners' findings in activity 9.6.
- While explaining, ask learners relevant application questions to involve them in the teaching and learning activities.
- Individually, learners do self-evaluation exercises proposed in learner's book on (Checking up 9.6)
- Discuss and present their findings in plenary.

Note: Homework should be provided to learners. It should be composed by a series of exercises related to Comparison of physical properties amino acids to those of carboxylic acids and amines.

d. Application activities

Application activities (checking up activities 9.6) are provided in learner's book. It is about comparison of the solubility of amino acids, amines and carboxylic acids. The box below shows their answers.

Proposed answers to checking up 9.6

See table 9.4 in Learners' book.

Lesson 7: Chemical properties of amino acids

a. Introduction

To learn this lesson, students should be confident with acidic and basic characters of amino acids. The activity 9.7 in learner's book is about reactivity of amino acids with acids and with bases. It will be used as introductory activity of the lesson. Since this lesson has only 40 minutes, the activity will be done in less than 4 minutes of time.

The box below shows expected results of the activity.

Proposed answers to activity 9.7



b. Teaching resources

You should avail the following resources: molecular models, chalkboard and chemistry books (learners books and reference books). A periodic table of elements and access to internet may also be necessary.

c. Learning activities

The learning activities for this lesson will be designed so as to help learners to develop competences. You are advised to choose which activities suit the best to his class.

Invite students to work individually on the activity proposed in the learner's book (activity 9.7).

- Invite some students to present their findings.
- The duration for this activity should not exceed 4 minutes.
- Introduce the new lesson and make relevant explanations, based in the learners' findings in activity 9.7.
- While explaining, ask learners relevant application questions to involve them in the teaching and learning activities.
- Individually, learners do self-evaluation exercises proposed in learner's

book (Checking up 9.7)

- Discuss and present their finding in plenary.

Note: Homework should be provided to learners. It should be composed by a series of exercises related chemical properties of amino acids.

d. Application activities

Application activities (checking up activities 9.7) are provided in learner's book. It is about reaction of glycine (and other amino acids) with acids and bases. The box below shows answers to that activity.

Proposed answers to checking up 9.7

1. The base removes H⁺ from the protonated amine group.

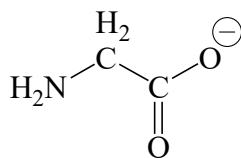

2. The acid adds H⁺ to the carboxylate group.

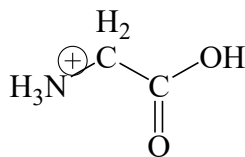

3. Glycine is neutral and optically inactive amino acid. According to isoelectric point concept, the given formula will be applied

$$pI = \frac{1}{2} (pK_{a1} + pK_{a2}) = \frac{1}{2} (2.4 + 9.8) = 6.1$$

The isoelectric point of the Glycine is 6.1

4. Lysine is basic amino acids (diamino monocarboxylic acid). According to isoelectric point concept, the given formula will be applied

$$pI = \frac{1}{2} (pK_{a1} + pK_{a3}) = \frac{1}{2} (2.2 + 10.5) = 9.7$$

The isoelectric point of the Lysine is 9.7

Lesson 8: Optical isomers of amino acids

a. Introduction

Learners should be confident with isomerism in organic compounds to better understand this lesson. The activity 9.8 in learner's book is about revision on optical isomerism. It will be used as learning activity of the lesson. Since this lesson has only 40 minutes, the activity will be done in less than 5 minutes of time.

The box below shows expected results of the activity.

Proposed answers activity 9.8

Optical isomers for CHBrClF

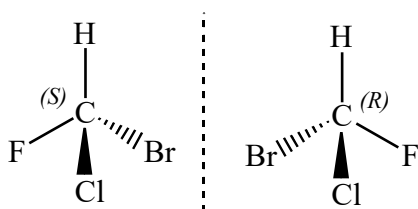

b. Teaching resources

You should avail the following resources: molecular models, chalkboard and chemistry books (learners books and reference books). A periodic table of elements and access to internet may also be necessary.

c. Learning activities

The learning activities for this lesson will be designed so as to help learners to develop competences. You are advised to choose which activities suit the best to his class.

- Invite students to work *individually* on the activity proposed in the learner's book (activity 9.8).
- The duration for this activity should not exceed 5 *minutes*.
- Introduce the new lesson and make relevant explanations, based in the learners' findings in activity 9.8.
- While explaining, ask learners relevant application questions to involve them in the teaching and learning activities.
- Individually, learners do self-evaluation exercises proposed in learner's book on (Checking up 9.8)
- Discuss and present their findings in plenary.

Note: Homework should be provided to learners. It should be composed by a series of exercises related to optical isomers of amino acids.

d. Application activities

Application activities (checking up activities 9.8) are provided in learner's book. It is about optical isomerism and chirality. The box below shows answers to that activity.

Proposed answers to checking up 9.8

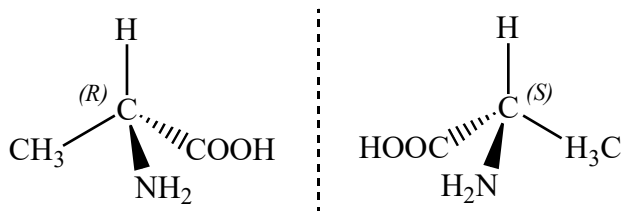

2-Amino-propionic acid 2-Amino-propionic acid

All amino acids, except glycine, are chiral because there are four different groups around the C

Lesson 9: Peptides and polypeptides

a. Introduction

Learners should be confident with polymerisation reactions to better understand this lesson. The activity 9.9 in learner's book is about revision on polymerisation of ethyne. It will be used as introductory activity of the lesson. Since this lesson has only 40 minutes, the activity will be done in less than 5 minutes of time.

The box below shows expected results of the activity.

Proposed answers to activity 9.9

Reaction of polymerisation of ethyne:

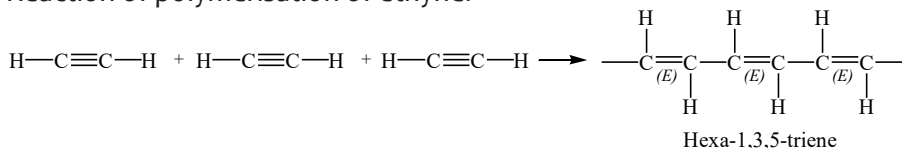

b. Teaching resources

You should avail the following resources: molecular models, chalkboard and chemistry books (learners books and reference books). A periodic table of elements and access to internet may also be necessary.

c. Learning activities

The learning activities for this lesson will be designed so as to help learners to develop competences. You are advised to choose which activities suit the best to his class.

- Invite students to work *individually* on the activity proposed in the learner's book (activity 9.9).
- The duration for this activity should not exceed 5 *minutes*.
- Introduce the new lesson and make relevant explanations, based in the learners' findings in activity 9.9.
- While explaining, ask learners relevant application questions to involve them in the teaching and learning activities.
- Individually, learners do self-evaluation exercises proposed in learner's book on (Checking up 9.9)
- Discuss and present their findings in plenary.

Note: Homework should be provided to learners. It should be composed by a series of exercises related to peptides and polypeptides.

d. Application activities

Application activities (checking up activities 9.9) are provided in learner's book. The box below shows answers to that activity.

Proposed answers to checking up 9.9

1. The N- terminal end is the end of a peptide or protein whose amino group is free (not involved in the formation of a peptide bond), while the C- terminal end has a free carboxyl group.
2. A peptide is composed of two or more amino acids. Amino acids are the building blocks of peptides.
3. Amide bond
4. a.

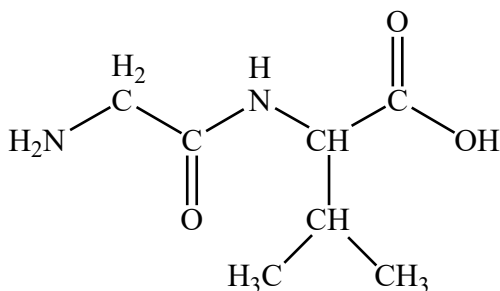

b.

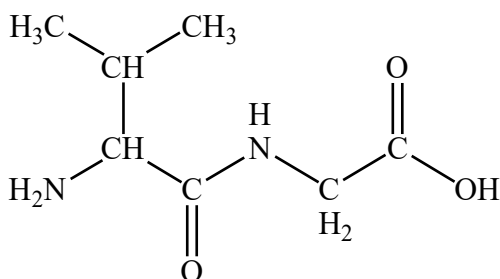

5. C-terminal amino acid: cys; N-terminal amino acid: lys

9.7 Summary of the unit

- An amine is a derivative of ammonia in which one, two, or all three hydrogen atoms are replaced by hydrocarbon groups.

The amine functional group is as follows

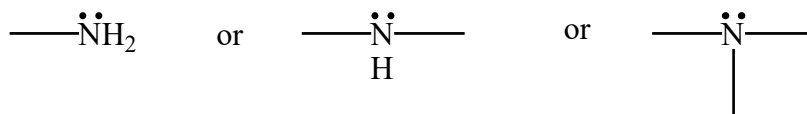

- Amines are classified as primary, secondary, or tertiary based on the number of hydrocarbon groups attached to the nitrogen atom.

- In IUPAC system, amines are named by naming the alkyl groups attached to the nitrogen atom, followed by the suffix -amine.
- Primary and secondary amines have higher boiling points than those of alkanes or ethers of similar molar mass because they can engage in intermolecular hydrogen bonding. Their boiling points are lower than those of alcohols and carboxylic acids because they have hydrogen atoms bonded to an oxygen atom, which is more electronegative.
- The boiling points of tertiary amines, which cannot engage in hydrogen bonding because they have no hydrogen atom on the nitrogen atom, are comparable to those of alkanes and ethers of similar molar mass.
- Because all three classes of amines can engage in hydrogen bonding with water, amines of low molar mass are quite soluble in water.
- The chemistry of amines is mainly related to the basic nature of nitrogen atom. Amines can react with strong acids, nitrous acid, carboxylic acid as well as with Acyl chlorides and acid anhydrides.
- Reaction of alkyl halides with ammonia produces a mixture of primary, secondary or tertiary amines along with quaternary ammonium salts.
- Reduction of nitriles, amides and nitro compounds gives amines having the same number of carbon atoms.
- In Hofmann bromamide reaction, the amine formed has one carbon less than the starting amide.
- Like ammonia, amines behave as bases. Because of the lone pair of electrons on their nitrogen atom, they can readily accept protons (H^+ ions), reacting to form salts.
- Both aliphatic and aromatic amines are basic in nature. But aromatic amines are less basic and aliphatic amines are more basic than ammonia. An aliphatic secondary amine is more basic than primary and tertiary amines.
- Amides can be hydrolysed by aqueous alkali or acid. With aqueous alkali the products are the salt of a carboxylic acid and a primary amine.
- There are about 20 naturally occurring amino acids (2-amino-carboxylic acids) with the general formula $RCH(NH_2)COOH$, where R may be H, CH_3 or another organic group.
- The physical properties of amino acids, amines and carboxylic acids are strongly related and comparable.
- Amino acids react with both acids and bases to form salts.
- The amino group of one amino acid can react with the carboxyl group on another amino acid to form a peptide bond that links the two amino acids together. Additional amino acids can be added on through the formation of addition peptide (amide) bonds.
- A sequence of amino acids in a peptide or protein is written with the -N

terminal amino acid first and the C-terminal amino acid at the end (writing left to right).

- Two amino acids react together in a condensation reaction, bonding together by a peptide (amide) link to form a dipeptide and water. Three amino acids form a tripeptide, and repetition of this condensation reaction many times leads to the formation of polypeptides and proteins

9.8 Additional Information for teachers

9.8.1 Nomenclature of amino acids

1. Names of common α -amino acids

The trivial names of the α -amino acids that are commonly found in proteins and are represented in the genetic code, together with their symbols, systematic names and formulas, are given in the learner's book.

The systematic names and formulas given refer to hypothetical forms in which amino groups are unprotonated and carboxyl groups are undissociated. This convention is useful to avoid various nomenclatural problems but should not be taken to imply that these structures represent an appreciable fraction of the amino-acid molecules.

Table 1. α -Amino acids incorporated into protein under mRNA direction.

Trivial name ^a	Symbols ^b		Systematic name ^c	Formula
Alanine	Ala	A	2-Aminopropanoic acid	CH ₃ -CH(NH ₂)-COOH
Arginine	Arg	R	2-Amino-5-guanidinopentanoic acid	H ₂ N-C(=NH)-NH-[CH ₂] ₃ -CH(NH ₂)-COOH
Asparagine	Asn ^d	N d	2-Amino-3-carbamoylpropanoic acid	H ₂ N-CO-CH ₂ -CH(NH ₂)-COOH
Aspartic acid	Asp ^d	D d	2-Aminobutanedioic acid	HOOC-CH ₂ -CH(NH ₂)-COOH
Cysteine	Cys	C	2-Amino-3-mercaptopropanoic acid	HS-CH ₂ -CH(NH ₂)-COOH
Glutamine	Gln ^d	Qd	2-Amino-4-carbamoylbutanoic acid	H ₂ N-CO-[CH ₂] ₂ -CH(NH ₂)-COOH
Glutamic acid	Glu ^d	E d	2-Aminopentanedioic acid	HOOC-[CH ₂] ₂ -CH(NH ₂)-COOH
Glycine	Gly	G	Aminoethanoic acid	CH ₂ (NH ₂)-COOH

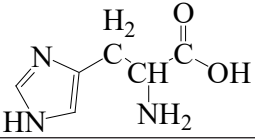
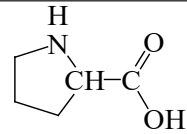
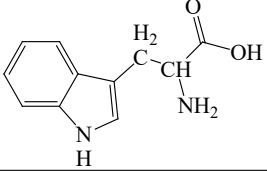
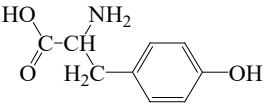
Histidine	His	H	2-Amino-3-(1H-imidazol-4-yl)-propanoic acid	
Isoleucine	Ile	I	2-Amino-3-methylpentanoic acid	$C_2H_5-CH(CH_3)-CH(NH_2)-COOH$
Leucine	Leu	L	2-Amino-4-methylpentanoic acid	$(CH_3)_2CH-CH_2-CH(NH_2)-COOH$
Lysine	Lys	K	2,6-Diaminohexanoic acid	$H_2N-[CH_2]_4-CH(NH_2)-COOH$
Methionine	Met	M	2-Amino-4-(methylthio)butanoic acid	$CH_3-S-[CH_2]_2-CH(NH_2)-COOH$
Phenylalanine	Phe	F	2-Amino-3-phenylpropanoic acid	$C_6H_5-CH_2-CH(NH_2)-COOH$
Proline	Pro	P	Pyrrolidine-2-carboxylic acid	
Serine	Ser	S	2-Amino-3-hydroxypropanoic acid	$HO-CH_2-CH(NH_2)-COOH$
Threonine	Thr	T	2-Amino-3-hydroxybutanoic acid	$CH_3-CH(OH)-CH(NH_2)-COOH$
Tryptophan	Trp	W	2-Amino-3-(1H-indol-3-yl)-propanoic acid	
Tyrosine	Tyr	Y	2-Amino-3-(4-hydroxyphenyl)-propanoic acid	
Valine	Val	V	2-Amino-3-methylbutanoic acid	$(CH_3)_2CH-CH(NH_2)-COOH$

- The trivial name refers to the L or D or DL-amino acid; for those that are chiral only the L-amino acid is used for protein biosynthesis.
- Use of the one-letter symbols should be restricted to the comparison of long sequences.
- The fully systematic forms ethanoic, propanoic, butanoic and pentanoic may alternatively be called acetic, propionic, butyric and valeric, respectively. Similarly, butanedioic = succinic, 3-carbamoylpropanoic = succinamic,

pentanedioic = glutaric, and 4-carbamoylbutanoic = glutaramic.

- d. The symbol Asx denotes Asp or Asn; likewise B denotes N or D. Glx and Z likewise represent glutamic acid or glutamine or a substance, such as 4-carboxyglutamic acid, Gla, or 5-oxoproline, Glp, that yields glutamic acid on acid hydrolysis of peptides.

2. Formation of semisystematic names for amino acids and derivatives

a. Principles of Forming Names

Semisystematic names of substituted α -amino acids are formed according to the general principles of organic nomenclature, by attaching the name of the substituent group to the trivial name of the amino acid. The position of the substitution is indicated by locants. The configuration, if known, should be indicated.

New trivial names should not be coined for newly discovered α -amino acids unless there are compelling reasons. When they are needed (e.g. because the substance is important and its semisystematic name is cumbersome), the name should be constructed according to the general principles for naming natural products, including either some element of its chemical structure or reference to its biological origin. It is important to use no elements in the trivial name that imply an incorrect structure; when a new trivial name is used, it is essential that it be defined by a correctly constructed systematic or semisystematic name. A number of existing trivial names are given in the Appendix, and an extensive list has been published previously.

b. Designation of Locants

Note. The atom numbering given below is the normal chemical system for designating locants. A somewhat different system has been recommended for describing polypeptide conformations, in which Greek letters are used irrespective of the nature of the atom (unless it is hydrogen), so that in lysine N-6 becomes N ζ , and in phenylalanine C-1, C-2 and C-6 become C δ 1 and C δ 2 respectively.

i. Acyclic Amino Acids

In acyclic amino acids, the carbon atom of the carboxyl group next to the carbon atom carrying the amino group is numbered 1. Alternatively, Greek letters may be used, with C-2 being designated α . This practice is not encouraged for locants, although terms like ' α -amino acids' and ' α -carbon atom' are retained. Example:

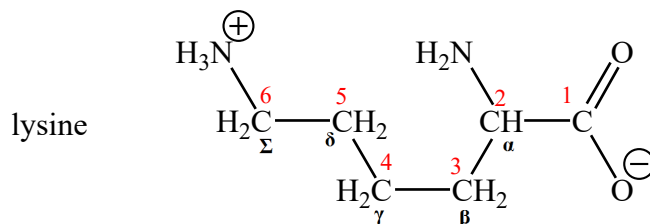

A heteroatom has the same number as the carbon atom to which it is attached, e.g. N-2 is on C-2. When such numerals are used as locants they may be written as N6- or as 6-N,

e.g. N6-acetyllysine.

The carbon atoms of the methyl groups of valine are numbered 4 and 4'; likewise those of leucine are 5 and 5'. Isoleucine is numbered as follows:

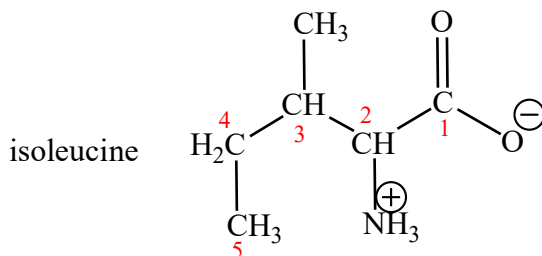

The word 'methyl' can be italicized for use as a locant for substitution on (or isotopic modification of) the methyl group of methionine, e.g. [*methyl*-14C] methionine. The nitrogen atoms of arginine are designated as shown for the arginine (1+) cation:

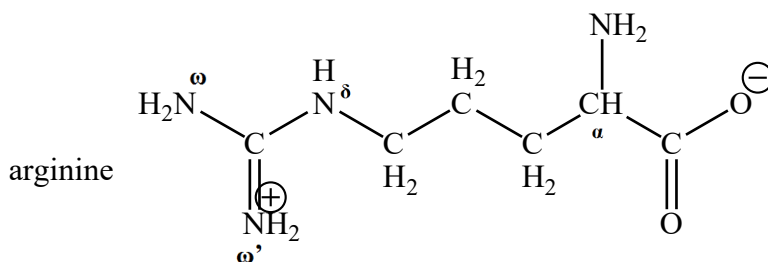

It should be noted that the ω and ω' atoms of this cation are equivalent because of resonance. The carbon atom in the guanidino group may be called guanidino-C (it may be needed as a locant for isotopic replacement although it cannot carry a substituent).

ii. Proline

The carbon atoms in proline are numbered as in pyrrolidine, the nitrogen atom being numbered 1, and proceeding towards the carboxyl group.

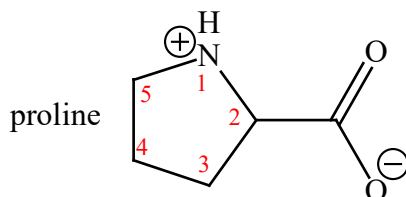

iii. Aromatic Rings

The carbon atoms in the aromatic rings of phenylalanine, tyrosine and tryptophan are numbered as in systematic nomenclature, with 1 (or 3 for tryptophan) designating the carbon atom bearing the aliphatic chain. The carbon atoms of this chain are designated α (for the carbon atom attached to the amino and carboxyl groups) and β (for the atom attached to the ring system).

Note. This numbering should also be used for decarboxylated products (e.g. tryptamine).

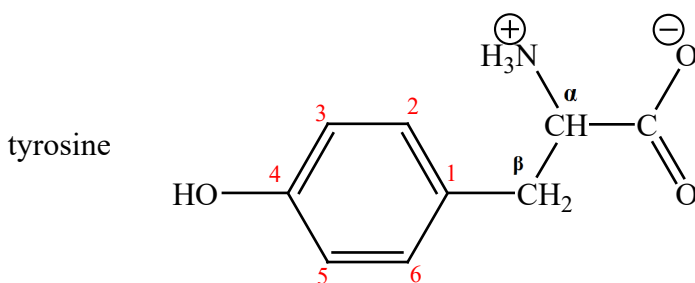
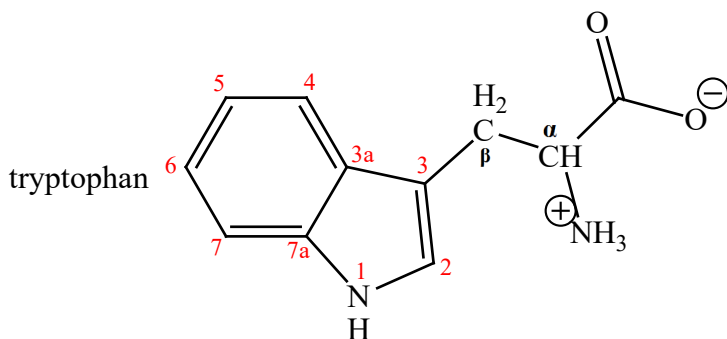
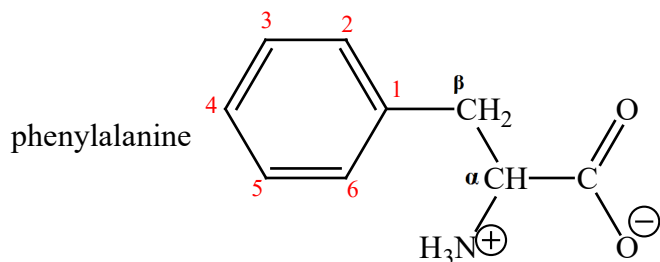

iv. Histidine

The nitrogen atoms of the imidazole ring of histidine are denoted by pros ('near', abbreviated π) and tele ('far', abbreviated τ) to show their position relative to the side chain. This recommendation arose from the fact that two different systems of numbering the atoms in the imidazole ring of histidine had both been used for a considerable time (biochemists generally numbering as 1 the nitrogen atom adjacent to the side chain, and organic chemists designating it as 3). The carbon atom between the two ring nitrogen atoms is numbered 2 (as in imidazole), and the carbon atom next to the τ nitrogen is numbered 5. The carbon atoms of the aliphatic chain are designated α and β as seen above. This numbering should also be used for the decarboxylation product histamine and for substituted histidine.

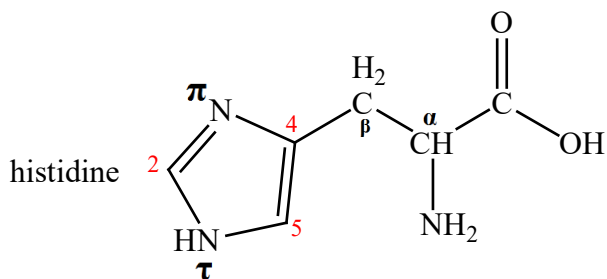

v. Definition of Side Chain

When amino acids are combined in proteins and peptides, C-1, C-2 and N-2 of each residue (the numbering being that of aliphatic amino acids) form the repeating unit of the main chain ('backbone') and the remainder forms a 'side chain'. Hence the words 'side chain' refer to C-3 and higher numbered carbon atoms and their substituents.

9.8.2 Acid–base properties of amino acids

As the name suggests, amino acids are organic compounds that contain both a carboxylic acid group and an amine group. Amino acids are crystalline, high melting point ($>200^{\circ}\text{C}$) solids. Such high melting points are unusual for a substance with molecules of this size — they are a result of internal ionisation. Even in the solid state, amino acids exist as zwitterions in which a proton has been lost from the carboxyl group and accepted by the nitrogen of the amine group:

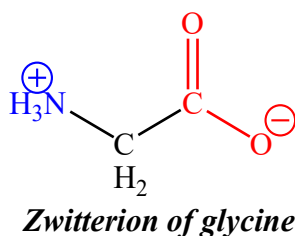
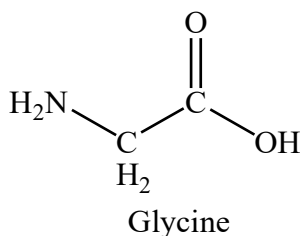

So instead of hydrogen bonds between the amino acid molecules there are stronger ionic (electrovalent) bonds. This is reflected in the relative lack of solubility of amino acids in non-aqueous solvents compared with their solubility in water.

Zwitterions exhibit acid–base behaviour because they can accept and donate protons. In acidic medium a proton is accepted by the carboxylic acid anion, forming a unit with an overall positive charge:

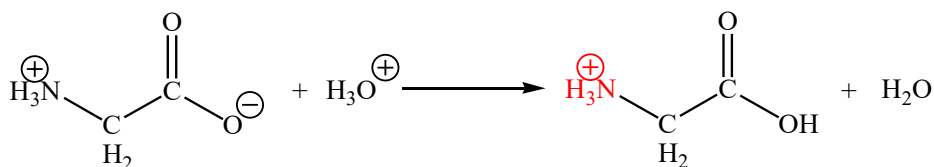

In alkaline medium the reverse occurs with the loss of a proton from the nitrogen atom:

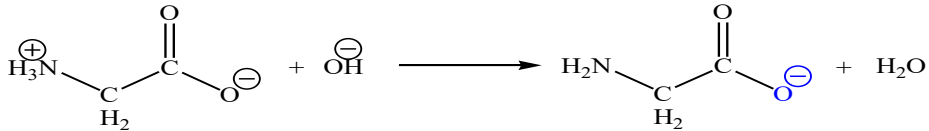

The species present in a given solution depends on the pH of the solution.

Carboxylic acids have acidic properties and react with bases. Amines have basic properties and react with acids. It therefore follows that amino acids have both acidic and basic properties.

9.8.3 Polarity of amino acids

Amino acids can be divided into four different groups depending on their R group and overall structure: non-polar, polar, acidic, and basic, as described below:

Nonpolar amino acids have R groups which have either attached aliphatic or aromatic side chains. As a result, these amino acids tend to be hydrophobic (water-fearing) in nature. Examples of this group are glycine, alanine, valine, leucine, isoleucine, methionine, tryptophan, phenylalanine, and proline.

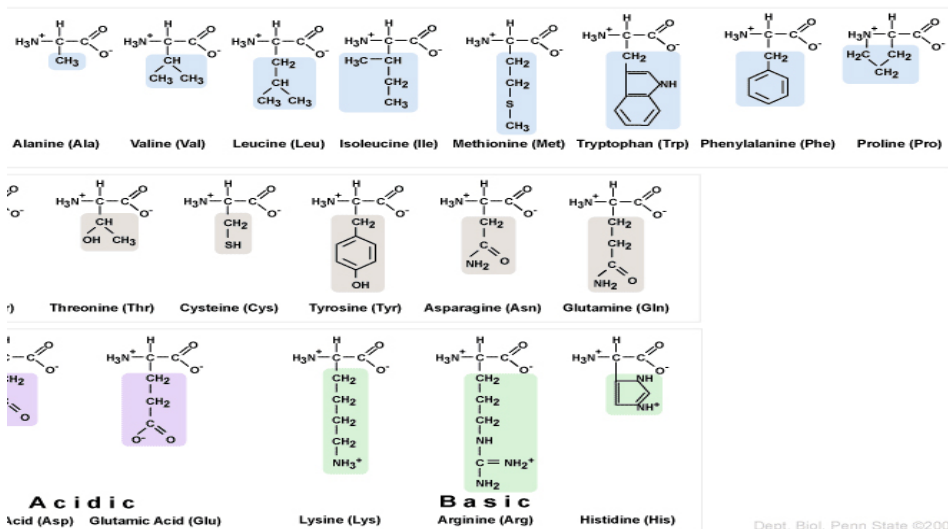

Dept. Biol. Penn State ©2002

Polar amino acids. The distinguishing characteristic of this next group of amino acid is having at least one atom of nitrogen, oxygen, or sulfur, which is readily available to pair with water, hence making them polar. Examples of this group are serine, threonine, cysteine, tyrosine, asparagine, and glutamine.

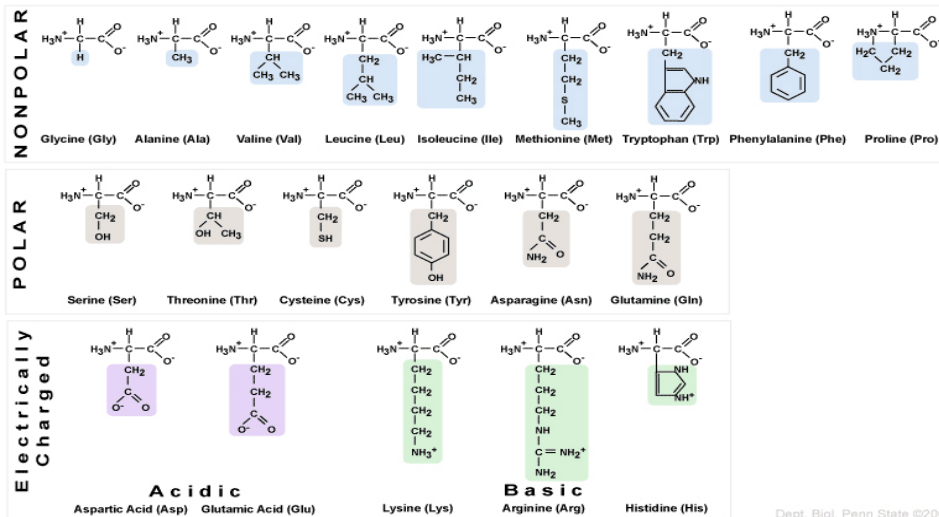

Dept. Biol. Penn State ©2002

Acidic amino acids. As their names suggests, aspartic acid and glutamic acids are the two examples of an acidic amino acid. The presence of a carboxylic acid on one side of the amino acid gives them the acidic property.

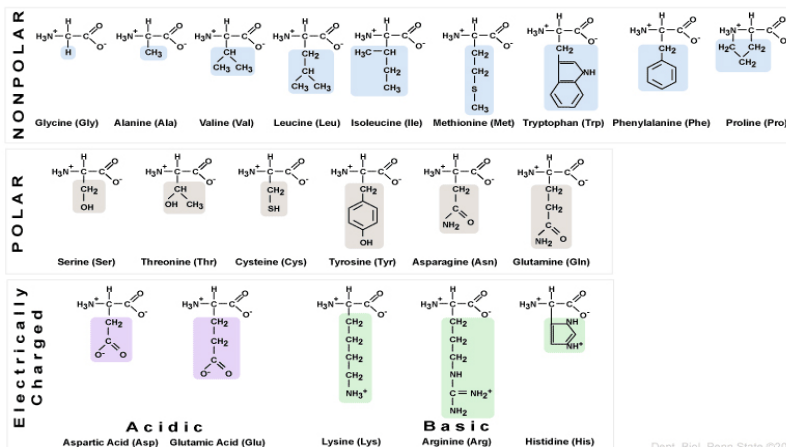

Dept. Biol. Penn State ©2002

Basic amino acids. Last but not the least are lysine, arginine, and histidine which all fall under basic amino acids. These amino acids have a basic R group, hence the name. We can observe that most amino acids are hydrophilic (includes polar, acidic, and basic) in nature. Hence, they make an ideal component of globular proteins in solutions.

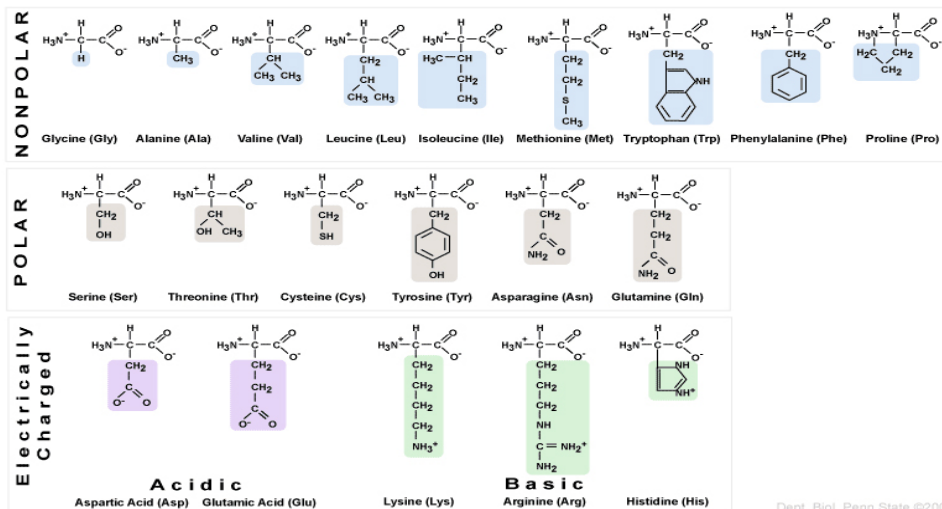

9.9 Answers to the end unit assessment

The end unit assessment (summative assessment) for unit 9 is provided in the learner's book. This 40 minute assessment is composed of 3 questions which have some sub questions, and cover the content for the whole unit. Answers to those questions are provided below:

Answers to end unit assessment 9.10

1.

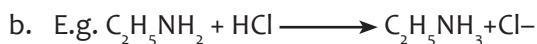
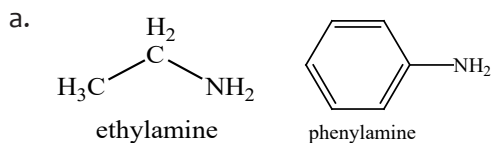

c. Lone pair on nitrogen

2.

a.

- i. *glycine*: aminoethanoic acid (2-aminoethanoic acid);
alanine: 2-aminopropanoic acid

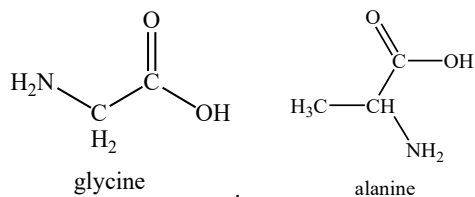

b. Alanine can exist as two stereoisomers.

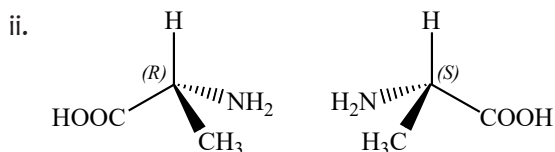

It does not have a chiral carbon (a carbon with four different groups/atoms attached), so no optical isomers; and it does not have a C=C double bond, so no geometrical (*cis/trans*) isomers.

3.

a.

i.

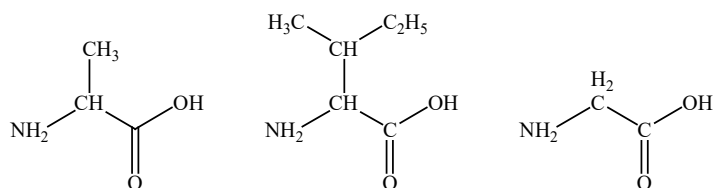

ii. The second one in the diagram above

b.

i. $-\text{CO}-\text{NH}-$ / amide/peptide bond/link

ii. Hydrolysis means splitting of a bond / breaking down a compound using water.

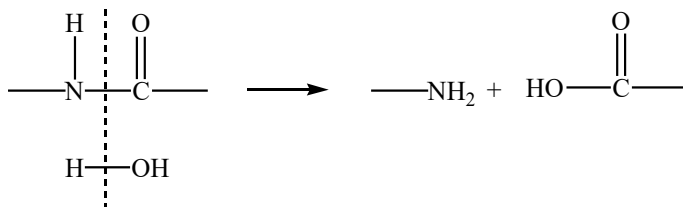

9.10 Additional activities

9.10.1 Remedial activities

1. The table below shows the boiling points of a number of amines.

Type	Formula	Boiling point (°C)
Primary	CH ₃ NH ₂	-6.3
Primary	CH ₃ CH ₂ NH ₂	16.6
Primary	CH ₃ CH ₂ CH ₂ NH ₂	48.6
Secondary	(CH ₃) ₂ NH	7.4
Tertiary	(CH ₃) ₃ N	3.5

- What intermolecular forces are present in the primary amines?
- Considering only the primary amines shown, explain why the boiling points increase as they do.
- The secondary amine shown is an isomer of the primary amine, ethylamine (aminoethane). Why is its boiling point slightly less?
- The tertiary amine shown is an isomer of the primary amine 1-aminopropane. Why is the boiling point much less?
- Why are all the amines in this table soluble in water?
- Why does the solubility become less with longer chain lengths?

2.

- To make a primary amine like ethylamine you can react a halogenoalkane like bromoethane with ammonia. State the conditions for this reaction.

- The equations for the reaction are:

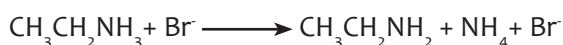

Describe in words what is happening in these two equations.

- Unfortunately the reaction doesn't stop there, and you end up with a mixture of several organic products rather than the two (the amine salt and the free amine) shown above. By writing equations like the ones in part (b), show what happens to make the next lot of products from those in the reactions above.

- d. The reaction wouldn't stop there either. There are three further organic products that you could get. Draw their structures.
 - e. What would your major product be if you had a large excess of bromoethane in the original reaction mixture?
 - f. What would your major product be if you had a large excess of ammonia in the original reaction mixture?
3. Primary amines can be made from nitriles avoiding the complicated mixtures formed above. The reaction can be done with either lithium tetrahydridoaluminate (lithium aluminium hydride), or hydrogen in the presence of a metal catalyst.
- a. Give the conditions for the reaction involving LiAlH_4 .
 - b. This reaction is a reduction, and the equation is commonly given using the symbol $[\text{H}]$ for the reducing agent. Write the equation for the reduction of $\text{CH}_3\text{CH}_2\text{CN}$ using LiAlH_4 .
 - c. Suggest a suitable catalyst for the reduction of $\text{CH}_3\text{CH}_2\text{CN}$ with hydrogen gas.
 - d. Write the equation for that reduction.

Answers

1.
 - a. Van der Waals dispersion forces, dipole-dipole attractions and hydrogen bonds.
 - b. As the molecules get bigger, the potential for van der Waals dispersion forces increases, and so more energy is needed to boil the amine.
 - c. The dispersion forces and hydrogen bonding will be much the same, but with the nitrogen in the middle of the molecule rather than at the end, the permanent dipole is rather smaller, and so the dipole-dipole attractions will be a bit weaker.
 - d. A molecule of a tertiary amine can't form hydrogen bonds with other tertiary amine molecules. Hydrogen bonding needs a hydrogen atom attached to an electronegative element, and in a tertiary amine, there aren't any hydrogens attached to the nitrogen.
 - e. They can all form hydrogen bonds with water (including the tertiary amines). When the amine dissolves, hydrogen bonds between amine molecules and between water molecules have to be broken, but are replaced by similar strength hydrogen bonds between amine molecules and water molecules. In the case of a tertiary amine, you can get a hydrogen bond between the lone pair on the nitrogen and a slightly positive hydrogen atom from the water.
 - f. You have to break increasing numbers of hydrogen bonds in the water as the bigger amines fit between the water molecules, but these are only replaced by hydrogen bonds involving the single nitrogen atom. It becomes

energetically unprofitable.

2.

a. Heat a mixture of bromoethane and a concentrated solution of ammonia in ethanol in a sealed tube.



In the first equation the ammonia reacts with the bromoethane, breaking the bond between the ethyl group and the bromine atom. The product is the ionic salt, ethylammonium bromide.



In the second reaction another ammonia molecule removes a hydrogen ion from the nitrogen in the salt to leave the free amine and produce the ammonium ions which form ammonium bromide. This reaction is reversible, and so you end up with a mixture of everything in the equation.

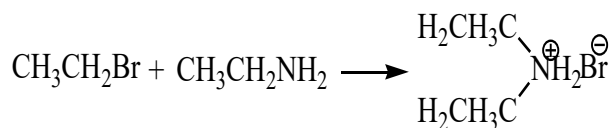

c.

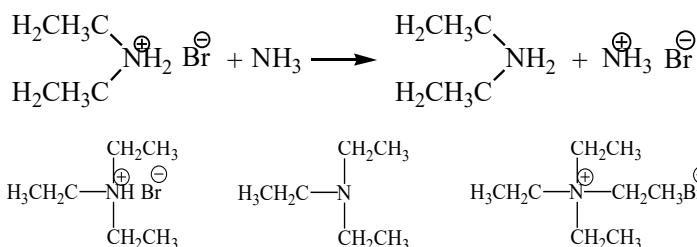

d.

These are probably easier to see if you write them in a more condensed form:

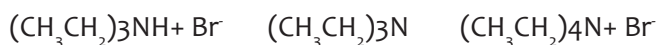

It is certainly easier to see their relationship with ammonia and ammonium salts if you write them like this.



9.10.2 Consolidation activities

This section embraces a series of experiments which should be performed to consolidate what has been learned in this unit. You are asked to prepare them and let learners perform them before or after the concerned lessons.

Pre-laboratory questions

1. Draw the structure of the following organic molecules. For ionic compounds simply give the chemical formula.
2. For each of the amines and amides in the preceding question label them as primary, secondary or tertiary.

Experiment 9.1 Solubility of Amines in Water and Acid

1. Perform the following in the hood.
2. Add 5 drops of each amine (*1-hexanamine, diethylamine, triethylamine and N-methylaniline*) to a separate test tube.
3. Carefully detect the odor of all the compounds by carefully wafting. Record your observations.
4. Add 2 mL of water to each test tube. Stir vigorously. Record your observations.
5. Wait 2-3 minutes and record your results.
6. Determine the pH of each solution using a stirring rod and pH paper.
7. Add 10% HCl drop-wise to each solution until the solution is acidic to blue litmus paper. Record your results. Note any color changes or odors.
8. Write a balanced chemical reaction for each neutralization that occurred in the previous step.
9. Dispose of the contents of the test tubes in the waste bottle labelled "Experiment 9.1 Waste".

Results – Solubility of Amines in Water and Acids

The following table will be used in recording data, for the first experiment:

	1-hexanamine	Diethylamine	Triethylamine	N-methylamine
Odor				
Initial Solubility in Water				
Solubility in Water after 2-3 minutes				
pH				

Reaction Products for Amine + H ₂ O				
Observations after addition of HCl (Odor, Color, Solubility)				
Reaction product after addition of HCl				

Experiment 9.2 Distinguishing Primary, Secondary and Tertiary Amines

1. Perform the following in the hood. Dissolve 0.5 mL of the amine (1-hexanamine, diethylamine, triethylamine and N-methylaniline) in 2.5 mL of water. Carefully (drop-wise) add 1.5 mL of concentrated HCl.
2. Cool the resulting solution in an ice-water bath for 5 minutes.
3. In a separate test tube dissolve 2.0 g of sodium nitrite in 10.0 mL of water.
4. Add 2.5 mL of the sodium nitrite solution (made in the previous step) 5 drops at a time to the test tube containing the amine to be tested. Keep the test tube immersed in the ice water bath at all times except to briefly mix the solution between adding drops. Test for the formation of nitrous acid after each addition of sodium nitrite by placing a drop of the solution on starch-iodide paper, a blue color indicates the formation of nitrous acid. Continue the addition until the mixture gives a positive test for nitrous acid.
5. Remove 2.0 mL of the resulting solution and slowly warm it to room temperature in a water bath. Record your observations.
6. Dispose of the contents of the test tubes in the waste bottle labelled "Experiment 9.2 Waste".

Results – Primary, Secondary and Tertiary Amines

	1- hexanamine	Diethylamine	Triethylamine	N- methylamine
Initial Observations				
Observations on addition of sodium nitrite (in ice water)				
Observations on warming to room temperature				
Conclusion: Primary, Secondary or Tertiary Amines				

After-laboratory questions

1. Which amines were soluble in water?
2. Which amines were insoluble in water?
3. What conclusion(s) can you make relating amine structure and solubility in water?
4. Amines are responsible for the nasty odor of many substances including the odor of fish. Explain why lemon juice might remove the odor of fish.

9.10.3 Extended activities

After the deep understanding of the content on amines and amino acids, students should be able to relate what they have learnt in previous units with the content of this unit. For that, you are asked to prepare and give those kinds of questions. Sample activities are provided below:

Questions

1. You have 3 unknown solutions: a carboxylic acid, an ester, and an amine. Describe how you might distinguish between them.
2. Primary amines can be made from nitriles avoiding the complicated mixtures formed above. The reaction can be done with either lithium

tetrahydridoaluminate (lithium aluminium hydride), or hydrogen in the presence of a metal catalyst.

- a. Give the conditions for the reaction involving LiAlH_4 .
- b. This reaction is a reduction, and the equation is commonly given using the symbol $[\text{H}]$ for the reducing agent. Write the equation for the reduction of $\text{CH}_3\text{CH}_2\text{CN}$ using LiAlH_4 .
- c. Suggest a suitable catalyst for the reduction of $\text{CH}_3\text{CH}_2\text{CN}$ with hydrogen gas.
- d. Write the equation for that reduction.

Answers

1. See learner's book.
2.
 - a. The nitrile reacts with the lithium tetrahydridoaluminate in solution in ethoxyethane (diethyl ether, or just "ether") followed by treatment of the product of that reaction with a dilute acid.
 - b. $\text{CH}_3\text{CH}_2\text{CN} + 4[\text{H}] \longrightarrow \text{CH}_3\text{CH}_2\text{CH}_2\text{NH}_2$
 - c. Palladium, platinum or nickel. There are undoubtedly other similar catalysts, but stick with one of the commonly quoted ones.

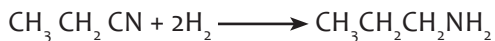

10.1. Key unit competency

The learner should be able to interpret the phase diagrams for different compounds.

10.2. Prerequisite

The study of phase diagrams requires the prior knowledge of chemical equilibrium and the factors that affect chemical equilibrium (unit 15, senior 4), states of matter and change of states of matter (senior 1) and Curve sketching learnt in mathematics. The teacher must check if students remember those concepts before starting this unit.

10.3. Cross-cutting issues to be addressed

The cross-cutting issues that can be addressed in this unit are specifically:

» Gender

The teacher has always to mind about the gender balance in assignment of roles during learning activities. He/she must make sure that both genders are represented and avoid using examples that minimize/praise any of them (boys or girls).

» Standardization culture

At the end of lesson 10.5, the teacher should address the cross-cutting issue of standardization culture that engineers should use materials that fulfill the standards in order to make durable things.

10.4. Guidance on introductory activity

This activity has the objective of making students think critically about the phenomenon and the observations they always encounter in their daily life. Then they try to interpret those observations by using scientific concepts. To help the students in this regard:

Challenge the students with the questions given in activity 10.1 to awaken their curiosity and interest of understanding those phenomena.

Allow students to give their opinions as they think about the scientific interpretations of what they see in their everyday life.

Guide students towards a collective understanding of those phenomena.

Answers to introductory activity

1. Two conditions required for keeping some states of the matter stable are mainly temperature and pressure.
2. Ice floats on water because it has lower density than that of water.

10.5. List of lessons

Lesson No	Lesson title	Learning objectives	Number of periods
1	Phase equilibrium	<ul style="list-style-type: none"> • Define a phase. • Explain the term phase equilibrium. 	2
2	Homogeneous and heterogeneous equilibria	<ul style="list-style-type: none"> • Define heterogeneous and homogeneous equilibria. 	1
3	Phase diagrams	<ul style="list-style-type: none"> • Explain the effect of change of state on changing pressure and temperature. • Define triple point, critical point, normal boiling and melting points of substances. • Locate triple point, critical point, normal boiling and melting points on the phase diagrams. 	2
4	Comparison of phase diagrams of substances that expand and those that contract on freezing	<ul style="list-style-type: none"> • Compare the phase diagrams of water with the carbon dioxide. 	2
5	Applied aspect of phase diagrams	<ul style="list-style-type: none"> • Relate the physical properties of compounds to their phase diagrams. 	2
6	Summative assessment		2

10.6. Guidance on the lessons

Lesson 1: Phase equilibrium

a) Introduction

Phase equilibrium deals with the dynamic equilibrium between two or more than two distinct phases. The study of phase equilibrium requires a prior knowledge of:

- States of matter and changes of states of matter (Senior 1).
- Chemical equilibrium and the factors that affect chemical equilibrium (Senior 5, unit 15).

b) Teaching resources

The teaching and learning resources that are needed for this lesson are:

- Student's textbooks
- Chalk board and pieces of chalk
- Manila papers
- Oil
- Water
- Ice salt

c)) Learning activities

» Guidance

This lesson aims at helping learners to explain the concepts of phase, component of a given phase and phase equilibrium. To achieve these objectives the activity 10.1 will be conducted as follows:

- Put the learners in the groups of five and assign them the roles.
- Give the students the examples of the materials suggested in this activity. Use the real substances where possible or use the diagrams if not possible to find the real materials.
- Ask the learners to observe the materials given, analyze them, discuss among themselves and answer the questions that are in activity 10.1
- The group will suggest the results of their discussions, which the teacher will use to explain the concepts as required.
- Put an emphasis on the difference between a phase and states of matter; that every state of matter can be considered as a phase, but the phase is not always the state of matter. Also distinguish chemical equilibrium from phase equilibrium.

Proposed answers to activity 10.1.

1. The components and the number of phases in each system:

- Ice and water: One component (H_2O) and two phases (solid and liquid phases)
- Salty water: two components (NaCl and H_2O) and one phase (liquid phase)
- Ethanol and its vapors: One component ($\text{CH}_3\text{CH}_2\text{OH}$) and two phases (liquid and gaseous phases)
- Oil and water: Two components and two phases

2. Every state of matter is a phase, but all phases are not necessarily states of matter. For example, a mixture oil and water consist of two phases which are in the same state of matter (liquid).

d) Checking up activity

The teacher will give the evaluation questions in checking up activity 10.1 to individual students and finally ask them to exchange their exercise books for peer marking.

Proposed answers to checking up 10.1.

3.

- $\text{N}_2\text{O}_4(\text{g}) \rightleftharpoons 2\text{NO}_2(\text{g})$ is a chemical equilibrium, not a phase equilibrium because all components are in the same phase
- $\text{CO}_2(\text{aq}) \rightleftharpoons \text{CO}_2(\text{g})$ is phase equilibrium because the components are in different phases, liquid phase and gaseous phase.
- $\text{H}_2\text{O}(\text{l}) \rightleftharpoons \text{H}_2\text{O}(\text{g})$ is a phase equilibrium between liquid phase and gaseous phase

4.

- The system has three phases (solid, liquid and gas)
- The system has one component (water)

Lesson 2: Homogeneous and heterogeneous equilibria

a) Introduction

The objective of this lesson is to differentiate homogeneous equilibrium from heterogeneous equilibrium and to attain this objective, students should have the following prior knowledge:

- Phase equilibrium (lesson 10.1 of this unit)
- Homogeneous and heterogeneous mixtures (senior 1)

b) Teaching resources

The teaching and learning resources that are needed for this lesson are:

- Student's textbooks
- Chalk board and pieces of chalk

c) Learning activities

» Guidance

Since the concepts of homogeneous and heterogeneous mixtures are not quite new to learners, the teacher will give examples of mixtures:

- Students are asked to classify them as homogeneous and heterogeneous mixtures. The teacher can bring real materials, use the diagrams or clearly describe the situation verbally.
- The outcome of the discussion must help the teacher to extend the knowledge that students have about heterogeneous and homogeneous mixtures to the context of heterogeneous and homogeneous equilibria. Note that one phase is always homogeneous, and the phase equilibrium is always heterogeneous, unlike the chemical equilibrium which can be either homogeneous or heterogeneous.

Proposed answers to activity 10.2.

- Homogeneous mixture has all the components in the same phase throughout.
- Heterogeneous mixture has the components in different phases. It does not look the same throughout.

Checking up activities

The teacher will ask students to discuss the questions in checking up 10.2. The activity will be conducted in a way that two students work together to ensure that there are active discussions among students. Then the teacher will collect different answers from diverse groups and after the groups will exchange the worksheets for peer marking with reference to answers the whole class has agreed on. This will help the teacher to

evaluate the achievement of his/her objectives by seeing how conversant the students are with doing these questions.

Proposed answers to checking up 10.2.

a), b) and c) are homogeneous equilibria, while d) and e) are heterogeneous equilibria.

Lesson 3: Phase diagrams: Carbon dioxide and water

a) Introduction

The main objective of this lesson is to interpret the phase diagram of one component-three phases system and to relate the properties of water and carbon dioxide to their respective phase diagrams. For the smooth unfolding of this lesson, learners are supposed to have this prior knowledge:

- Curve sketching skills (Mathematics)
- States of matter and change of states of matter (Senior 1)
- Factors that affect chemical equilibrium position (senior 4, unit 15)

b) Teaching resources

The teaching and learning resources that are needed for this lesson are:

- Student's textbooks
- Chalk board and pieces of chalk
- Manila papers
- Ice
- Water

c) Learning activities

Guidance

- To effectively conduct this activity, put the students in groups of five or six students for them to have chance of discussing and exchanging experiences.
- After group discussion, ask the students to present their findings to the whole class and help the class to come to a collective understanding.
- Since in the minds of students will remains with the “questions marks” of why those substance (water and carbon dioxide) behave the way described in the questions of activity 10.3, it should be a good opportunity for the teacher to introduce the phase diagram.
- Emphasize on the understanding of critical point, triple point and the melting point curve's slope. Help the students to realize that water expands on freezing and the melting point curve on its phase diagram has

a negative slope, while for carbon dioxide is the opposite. Another key point to be noted is that the triple point of carbon dioxide is above the normal atmospheric pressure.

Proposed answers to activity 10.3.

1. Ice taken from a freezer will melt at room temperature to a liquid and eventually becomes a gas when heated. In contrast, dry ice keeps the ice cream cold, and instead of melting, it sublimates (converts directly from solid to vapor), which also prevents the ice cream containers from getting soggy.
2. Water expands on freezing which makes ice less dense than liquid water.
3. At the top of high mountain there is less atmospheric pressure, and the slope of the melting point curve for water is negative which implies that ice is stable at lower pressure. It is also correct that the melting point of ice increases as the pressure is lowered.

4. Checking up activities

Asks students to do questions in checking up 10.3. The activity will be conducted in a way that two or three students work together to ensure that there are active discussions among students. Collect different answers from diverse groups, then the groups will exchange the worksheets for peer marking with reference to answers that the whole class has agreed on.

Proposed answers to checking up 10.3

1. A piece of dry ice sublimates at room pressure and temperature because its triple point is above normal pressure (1atm).
2. Carbon dioxide will exist as a liquid at a temperature between -57° and 37°C and the pressures between 5.2atm and 73atm.
3. The critical temperature is the highest temperature that a substance can exist as a liquid at critical pressure. Beyond the critical temperature it is not possible to liquefy the gas no matter the amount of pressure applied. The critical temperature of carbon dioxide is 31°C .
4. CO_2 makes an excellent fire extinguisher because CO_2 is denser than air, so it sinks and displaces the air surrounding the fire, depriving the fire of oxygen.
5.
 - a. Water expands on freezing which means that ices occupy greater volume than liquid water of equal mass.
 - b. Due to expansion the volume becomes greater with a constant mass which reduces the density. Ice has lower density than liquid water of the same mass.

Lesson 4: Comparison of phase diagrams of substances that expand and those that contract on freezing

a) Introduction

The objective of this lesson is to compare the phase diagrams of the substances that expand on freezing and those that contract on freezing. The objective will be well achieved when the students have the prior knowledge about Phase diagram of carbon dioxide and that of water.

b) Teaching resources

The teaching and learning resources that are needed for this lesson are:

- Student's textbooks
- Chalk board and pieces of chalk
- Charts of phase diagrams of water and carbon dioxide
- Ice
- water

c) Learning activities

Guidance

- Put the students in groups of five and ask them to discuss the questions in activity 10.4 and then after, allow the students to present what they have done in their respective groups.
- Emphasize on the fact that water is a typical example of the substances which expand on freezing while carbon dioxide is the example of the substances that contract on freezing.

Proposed answers to activity 10.4.

1.

- The similarities between phase diagrams of water and that of carbon dioxide:
- The diagrams have three solid lines intersecting at one point (triple point).
- The three solid lines delimit three regions which are solid, liquid and gas phases.

Differences are:

- The triple point for water is below the normal atmospheric pressure (1atm) where it follows that ice normally melts to liquid at room temperature and pressure, whereas dry ice sublimates under these conditions.
 - The melting point curve of water slopes to the left, while that of carbon dioxide slopes to the right (carbon dioxide contracts on freezing and water expands on freezing).
 - The critical point of carbon dioxide is much lower than that of carbon dioxide.
2. Since water expands on freezing, it melts at a lower temperature when the pressure is raised. For that reason, when the glacier stands on ice, much pressure is applied to ice and then causes it to melt which helps the glacier to slide easily.

d) Checking up activity

The questions in the checking up 10.4 which are found in student's book are given to students and they are asked to do those questions individually in their exercises books. Assist those students who prove the difficulties to understand the questions and how they can be answered.

Proposed answers to checking up 10.4.

1. Three ways dry ice is different from normal ice:
 - Dry ice sublimates without melting while normal ice melts to liquid before evaporation to gas.
 - Normal ice is melted by using heat, while dry ice melted by lowering pressure.
 - Normal ice can readily be ingested whereas dry ice is detrimental to humans' life when it is ingested.
2. Under these normal conditions of temperature and pressure, it is not possible to have liquid carbon dioxide because its triple point is above normal atmospheric pressure. But on the other hand, the triple point of water is below the normal atmospheric pressure reason why under these conditions ice melts to liquid which is more stable state at 250C and 1atm.
3. They are not in the same phase: dry ice will be in gaseous phase, while normal ice is in liquid phase. For explanations refer to student's book.
4. Refer to student's book for the answers.

Lesson 5: Applied aspects of phase diagrams

a) Introduction

Phase diagrams are useful for material engineering and material applications. With their aid, scientists and engineers understand the behavior of a system which may contain more than one component (compounds). Multicomponent phases diagrams show the conditions for the formation of solutions and new compounds. The prior knowledge about phase diagrams is require in this lesson.

b) Teaching resources

The teaching and learning resources that are needed for this lesson are:

- Student's textbooks
- Chalk board and pieces of chalk
- Internet connection

c) Learning activities

» Guidance

This lesson aims at guiding students to appreciate the applied aspects of phase diagrams in different domain of daily life.

- Call the students to brainstorm answers about the question asked in activity 10.5. The question is given to the whole class and individual student

is given time to express her/his idea, one after the other.

- Exploit the information given by students, to come up with the crucial point that phase diagrams are useful in engineering where they need to predict the properties of different materials they use to construct various things.

Proposed answers to activity 10.5.

Refer to the student's book

d) Checking up activity

The question in the checking up 10.5 which are found in student's book is given to groups of students and they are asked to make a research and submit their research reports to the teacher for marking.

Proposed answers to checking up 10.5.

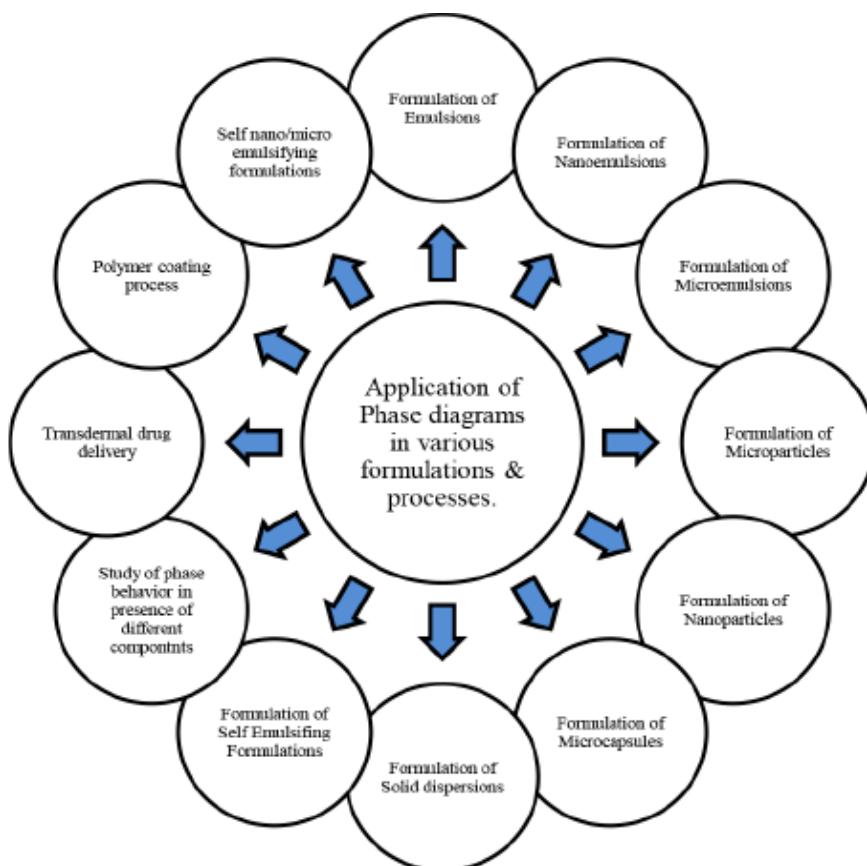

Source: Dhoot, A.S; Naha, A; Priya, J.; Xalxo, N.2018. Phase diagrams for three component mixtures in pharmaceuticals and its applications. *J Young Pharm*, 2018; 10(2): 132-137

10.7 Summary of the unit

- A phase is a homogeneous portion of a system which has uniform physical characteristics separated from other parts of the system by a clear boundary (limit).
- A component is a chemical species which may be used to specify the composition of a system.
- An equilibrium is the state of a reaction or physical change in which the rates of the forward and reverse processes are the same and there is no net change on the amount of the equilibrium components.
- A phase equilibrium is a balance between phases, that is, the coexistence of two or more phases in a state of dynamic equilibrium.
- A homogeneous equilibrium is one in which all components are present in a single phase.
- A heterogeneous equilibrium is a system in which the constituents are found in two or more distinct phases.
- A phase diagram is a graph illustrating the conditions of temperature and pressure under which equilibrium exists between the distinct phases (states of matter) of a substance.
- The temperature on this curve where the vapor pressure is equal to 1atm is **the normal boiling point** of the substance.
- Critical point consists of the temperature and pressure beyond which the liquid and gas phases cannot be **distinguished**.
- Every substance has a critical temperature above which the gas cannot be liquefied, regardless of the applied pressure called “**Critical temperature**”.
- At the critical temperature is associated a “**critical pressure**” which is the pressure required to bring about liquefaction at critical temperature.
- The temperature at which the solid melts at a pressure of 1atm is the “**normal melting point**”.
- The point, where the three curves intersect is known as the “**triple point**”. All the three phases coexist at equilibrium.
- The phase diagram of water is not a typical example of a one component system because the melting point curve slopes upward from right to left. That is, it has a negative slope and its melting point decreases as the pressure increases. Water expands on freezing which makes liquid water more dense than solid water (ice). The reason why ice floats on water.
- The normal boiling point of water is 100 °C and its normal melting point is at 0°C. The critical point of water is at 218 atm and the temperature is about 374 °C. The triple point is at 0.00603atm and 0.001°C, which is below the normal atmospheric pressure. Water exists as a liquid under normal

conditions of temperature and pressure.

- The melting point curve exhibits a positive slope, indicating that the melting point for CO_2 increases with pressure as it does for most substances. It is an indicator that carbon dioxide contracts on freezing.
- The triple point, located at a pressure of 5.2atm and a temperature of -78°C , is well above the normal atmospheric pressure (1atm), indicating that carbon dioxide cannot exist as a liquid under normal pressure conditions.
- The critical temperature of carbon dioxide is 37°C and its critical pressure is 73atm. This critical point is very much lower than that of water (figure 10.2).
- Thus, the knowledge and understanding of the phase diagram is very important to engineers. Proper knowledge and understanding of phase diagrams will lead to design and control of heating procedures for developing the required microstructure and properties.

10.8. End unit assessment

Answers of the unit assessment

1. a) True
2. b) False
3. c) False
4. From a) and b), refer to the student's book.
 - c. In Karisimbi water will freeze at a higher temperature than that at sea level because the freezing/melting point of water increases as the pressure decreases. The melting point curve for the phase diagram of water has a negative slope which means that water expands on freezing.
 - d. In Karisimbi water will boil at a lower temperature than 100°C (the normal boiling point of water) because the boiling point of water decreases as the pressure is increased. The boiling point curve in the phase diagram of water slopes to right.
5. The critical temperature of carbon dioxide is 31°C . On cool days at 18°C , it is below the critical temperature the high pressure in fire extinguisher's cylinder brings about liquefaction of gaseous carbon dioxide. On the hot days at 35°C , it is above critical temperature of carbon dioxide, above 31°C it is not possible to bring about liquefaction of carbon dioxide gas

regardless of the amount of pressure applied.

6.

- a. X: Liquid, Y: solid, Z: Gas, T: Triple point and C: Critical point
- b. The substance would contract when it was frozen because its phase diagram shows that the melting point curve has positive slope which means that the melting point increases as the pressure is raised.
- c. Above the triple point: The substance at Y would melt to liquid if the temperature was raised at constant pressure

Below the triple point: The substance Y would sublime to gas if the temperature was raised at that constant pressure.

- d. The substance at X would evaporate if the pressure was lowered at constant temperature.

7.

- d. A: Solid B: Gas and C: Liquid
- b. The triple point is represented by letter d. The triple point is the temperature and pressure at which all the three phases exist in equilibrium.
- c. The substance's normal boiling point is 100°C .
The substance's normal melting point is 0°C
- d. This is above the critical temperature which is 110°C
- e. At constant temperature this substance can be changed from liquid to solid by increasing pressure.

10.9 Additional activities

10.9.1 Remedial activities

These remedial activities are given to students that are struggling with the understanding of the concepts learnt in the lesson. They are to help those learners to catch up with what they did not well understand.

Questions

1. With reference to the phase diagrams given complete the passage by appropriate words.

Temperature and _____ control the phase of a substance. A phase diagram is a graph of pressure versus temperature that shows in which phase a substance exists under different conditions of temperature and pressure. A phase diagram typically has _____ regions, each representing a different phase and three

- b. Relative amount of different phases can be found under given equilibrium conditions.
 - c. It indicates the temperature at which different phases start to melt.
 - d. Solid solubility limits are depicted by it.
2. Chose the correct statement about phase diagrams
- a. The substance will always exist as a liquid below the critical temperature
 - b. The substance will always exist as a gas below the critical temperature
 - c. The substance can exist as a liquid or a gas below the critical temperature
 - d. None of the above is correct
3. If I have a bottle of CO_2 at a pressure of 1atm and temperature of 100°C what will happen to CO_2 if I drop the temperature to -120°C ?
4. Some industrial processes require carbon dioxide. The carbon dioxide is stored on-site in large tanks as liquid carbon dioxide. Assuming we lived at sea level (1atm), how could carbon dioxide be liquefied?
5. Explain the conditions of pressure required to melt ice at low temperatures.
- 6.
- a. How does the melting point of CO_2 change with pressure?
 - b. What does this indicate about the relative density of solid CO_2 versus liquid CO_2 ?

Answers

1. a
2. c
3. Carbon dioxide gas will deposit as dry ice (solid carbon dioxide)
4. Carbon dioxide can be liquefied by lowering the temperature to less than 31°C (critical temperature) and then increase the pressure to more than 5.2atm (pressure at triple).
5. To melt ice at low temperatures, requires high pressures because liquid water occupies lower volume than solid water. According to the Le Chatelier's principle, increase in pressure causes the equilibrium to shift in the direction that reduces the volume.
6.
 - a. The melting point of carbon dioxide increases with increasing pressure.
 - b. This indicates that carbon dioxide contracts on freezing and the density of solid carbon dioxide is greater than that of liquid carbon

dioxide.

10.9.3 Extended activities

Questions

1. Two scientists were discussing the factors that affect the boiling points of water and other substances as well. During their research they carried out experiments. One went on the top of the mountain, another in the valley of that mountain they used electric heater to boil 50ml of pure water in open beakers and started boiling that water at the same time. Predict the results of their experiments and explain the differences in their findings if there are.
2. How many phases exist at a triple point? Describe what would happen if a small amount of heat were added under constant-volume conditions to a sample of water at the triple point. Assume a negligible volume change during fusion

Answers

1. The scientist who is at the top of the mountain will note that water boils at lower temperature because the atmospheric pressure is lower. On the other hand, in the valley water will boil at a little bit higher temperature due to higher atmospheric pressure exerted on the on the surface of liquid water.
2. At triple point exists three phases. At constant-volume conditions the pressure is constant. The increase of temperature would change the substance to gaseous phase.

11.1 Key unit competency:

Prepare standard solutions and use them to determine concentration of other solutions by titration.

11.2 Prerequisite (knowledge, skills, attitudes and values)

Students will learn better solutions and titration if they have understanding on: The symbols of elements and their valences, concepts of mole and molecular mass. The teacher will help learners to recap the concepts above.

11.3 Cross-cutting issues to be addressed

a) Inclusive education:

This unit involves a number of formulae of substances, the writing of formulae and chemical reactions. This may be challenging to students with special educational needs especially students with visual impairment or visual difficulties. However, the teacher can make some arrangements like:

- **Grouping students.** Students with special educational needs are grouped with others and assigned roles basing on individual student's abilities.

If a teacher has students with visual difficulties, when writing on the blackboard, write in large, clear writing, especially when it comes to formulae and chemical reactions. Read out what you are writing, for the benefit of those who are not able to see the blackboard clearly.

If learners are sharing textbooks, try to arrange for those with visual difficulties to have their own copies, as far as this is possible.

Give extra time for them to write summary notes or write down observations after experiments.

- Every important point is written and spoken.
- Remember to repeat the main points of the lessons.
- For students with visual impairment teacher can write of them a summary using the braille alphabet if possible.
- For learners with **hearing difficulties**, the teacher has to encourage them to sit closer to the front of the classroom. Stop every so often while teaching to ask learners whether they have understood, or if they need you to repeat a point. Encourage learners not to be afraid to ask questions.

When teaching, speak clearly and ensure that all the learners can hear your voice. Avoid speaking hurriedly as this will make it difficult for learners with hearing difficulties to make sense of what you are saying.

- **Learners with mobility difficulties:**
- These include learners in crutches, wheelchairs, or with walking difficulties. Encourage other learners to look out for and help their classmates. Ask their fellow learners to help them with their notes, if their conditions hinder them from writing well.
- **Learners with reading difficulties:**
- Learners with this kind of difficulties struggle to make sense of words or understand written work and take longer to read than other learners. Encourage them to pay careful attention during class time and participate for example by asking questions, answering questions, so that they can make the most of what they hear and observe. Instead of repeating word for word what is in the textbook, simplify the concepts to ease their understanding, so that when they have already understood.

b) Gender:

During group activities try to form heterogeneous groups (with boys and girls) or when students start to present their findings encourage both (boys and girls) to present.

c) Financial education:

As the unit deals with the importance of preparing solutions in modern life, the teacher will draw the learners' attention on the economic impact of preparing some solutions especially standard solutions.

d) Peace and values education:

During group activities, the teacher will encourage learners to help each others and to respect opinions of colleagues.

11.4 Guidance on the introductory activity

- For this activity, the teacher forms groups of five students that are as heterogeneous as possible.
- The teacher makes sure that each student from each group performs an activity.
- The teacher provides a clear sheet for reporting. On this, there is among others the title of experiment, the observations and deductions.
- The teacher asks randomly representative of two or three groups to present their findings.
- After presentation, the teacher decides to engage the class into exploitation of the students' findings.
- After presentation the teacher asks the students to judge findings from different groups and harmonise their work.
- The teacher summarises their findings and introduce the new unit

Answers to introductory activity

- a) - 5% is the amount of ethanol that is in PRIMUS, meaning that in 100cl of PRIMUS, there 5cl of ethanol.
- 5.5% is the amount of ethaol in MUTZIG, meaning that in 100cl of MUTZIG , there is 5.5cl of ethanol
- b) The total volume of alcohol(ethanol) in a bottle of 72cl of PRIMUS is $5 \cdot 72 / 100 = 3.6$ cl
- c) The total volume of alcohol in a bottle of 65 of MUTZIG is $5.5 \cdot 65 / 100 = 3.57$ cl
2. Dilution 1: 5 is a dilution factor. This means that from one bottle of agashya, you can make 5 bottles by diluting it with drinking water.

11.5 List of lessons (including assessment).

No	Lesson title	Learning objective	periods
1	Definition of standard and primary standard solutions	Define the terms standard solution and primary standard solution.	2
2	Properties of primary standard solution	Explain the properties of a primary standard solution.	2
3	Preparation of standard solutions by dissolution of solids	Prepare solutions with different concentrations.	2
4	Preparation of standard solutions by dilution	Prepare solutions with different concentrations.	2
5	Acid- base titrations	<ul style="list-style-type: none"> - Explain the titration process, emphasising the need for precise measurements. - Properly use the burette, pipettes during titration. - Interpret the experimental data obtained by titration and report. Respect of procedure in practical experiment. 	2
6	Redox titrations: Titration of Fe ²⁺ against KMnO ₄	<ul style="list-style-type: none"> - Carry out redox titration and do calculations involved. - Respect of procedure in practical experiment. - Properly use the burettes, pipettes during titration. - Appreciate the use of appropriate measurements in daily life. 	2
7	Redox titrations: Titration of oxalate, C ₂ O ₄ ²⁻ against KMnO ₄	Carry out redox titrations and do calculations involved.	2

8	Redox titrations: Titration of hydrogen peroxide against KMnO_4	<ul style="list-style-type: none"> - Develop a culture of orderliness in performing practical experiments. - Carry out redox titrations and do calculations involved. 	2
9	Redox titrations: chromatometric titration	<ul style="list-style-type: none"> - Carry out redox titrations and do calculations involved. - Interpret the experimental data obtained by titration and report. 	2
10	Redox titrations: Iodimetric titration and Iodometric titration	<ul style="list-style-type: none"> - Explain the titration process, emphasising the need for precise measurements - Develop a team approach and a sense of responsibility in performing the experiments of titration. 	2
11	Back titration	<ul style="list-style-type: none"> - Interpret the experimental data obtained by titration and report. - Carry out redox titrations and do calculations involved. 	2
12	Applications of titrations: Determination of the number of moles of water of crystallization	<ul style="list-style-type: none"> - Appreciate the use of appropriate measurements in daily life. - Respect of procedure in practical experiment. 	2
13	Determination of atomic masses	<ul style="list-style-type: none"> - Interpret the experimental data obtained by titration and report. - Carry out redox titrations and do calculations involved. 	2
14	Summative assessment	Prepare standard solutions and use them to determine concentration of other solutions by titration.	2

11.6 Guidance on different lessons

Lesson 1: Definition of standard solutions and primary standard solutions (80minutes).

This is the first lesson of unit 11 and is a double lesson. That is to say it has two periods (80 minutes). The first lesson also covers the introduction of the whole unit.

a) Prerequisites:(10minutes)

Students will learn better the definition of standard solutions and primary standard solutions if they have understanding on: The mole concept, valencies of elements.

b) Teaching resources

- Chalks, manila paper and flip charts

c) Learning activities:

Before introducing the lesson, you will have to introduce the whole unit. Let learners therefore attempt activity 11.1 which leads students to the first lesson of the unit.

d) Methodological steps:

As a facilitator, the teacher is expected to guide learners through the following steps:

Activity 11.1: (20minutes)

- Ask students carefully to attempt the questions.
- Each student records his or her answers.
- Select some learners (2-4) to share their findings to the whole class, the class discusses on the presentation as you record the main points on the chalkboard or flipchart.
- Check students' responses to review the students' plans and ideas to continue the discussion with a brief brainstorming of concepts using students' work.

Expected answers to activity 11.1: See student book

- Make a summary of the lesson (short notes: 10minutes) and assess your lesson, let students do checking up 11.1.

Expected answers to checking up 11. 1 (end lesson assessment) (30minutes)

See student book

Lesson 2: Properties of primary standard solutions (80minutes)

a) Prerequisites (10minutes)

Students will learn better the properties of primary of standard solutions if they have understanding on: Mole concept (chemistry S2unit 7).

b) Teaching resources

Use a manila paper or flip charts.

c) Learning activities

Before introducing the lesson. Let learners therefore attempt activity 11.2 which leads students to the second lesson of the unit

d) Methodological steps

As facilitator you are expected to guide learners through the following steps:

Activity 11.2: (25minutes)

- Divide your class into groups of five students and let students follow the working procedures to obtain the results.
- Let the learners perform the activity using their prior knowledge about definition of standard solutions.
- Have sample group present their work to the class.
- Check learners' responses to review the learners' plans and ideas to continue the discussion with a brief brainstorming of the concepts using learners' work and book.
- Comment on students' responses written in their note books, and give them the summary of expected feedback based on their findings.

Expected answers to activity 11.2:

See student book

Assess the lesson by letting learners to do checking up 11.2 (15minutes)

Expected answers to checking up 11. 2 (25minutes): See student book

Lesson 3: Preparation of standard solutions by dissolution of solids (80minutes).

a) Prerequisites (10 minutes)

Students will learn better the preparation of standard solutions by dissolution of solids if they understanding on: Mole concept especially expressions of concentration.

b) Teaching resources

Volumetric flask, beaker, spatula, electronic balance, funnel, stopper, sodium peroxide, glass rod and distilled water.

c) Learning activities

This is the time for introducing the lesson three, before introducing it, let learners therefore attempt activity 11.3 and 11.31 which leads to the third lesson of the unit.

Activity 11.3: (20 minutes)

- Divide your class into groups, and let students follow the working procedures to obtain the results.
- Let the learner(s) perform the activity using their prior knowledge about mole concept and expressions of concentration by using calculations involved.

- Have sample group to present their work to the class. During the presentation, remember to take notes on some key points (correct ones and wrong ones), that are going to guide you in the next step.
- Ask members of other groups to give their comments (inputs) if any.
- Based on learners' production, through questioning, guide them to draw important conclusion. Here, you need to emphasize on the preparation of standard solutions.

Expected answers to the activity 11.3

First we calculate the mass of solute(NaCl) to be dissolved:

Mass of NaCl = $M \times M_w \times V = 1M \times 58.5g/mol \times 1L = 58.5g$.

Procedure:

- Weigh 58.5g of NaCl accurate using glass watch, spatula and analytical balance.
- Dissolve it in a flatted flask of 1000ml (1L) containing already little water and mix using a baguette and shake till you get homogeneous mixture(you should take care since it is an exothermic reaction).
- Top up using distilled water and shake again and cover your solution.
- Label your solution: NaCl 1M; 1L; the date of the time being and your name as preparator.

Activity 11.3.1 (15minutes)

Before the practical

- Try to copy this activity on a sheet and make copies equal to the number of groups (of 4 to 5) that you will form according to your class.
- Make sure you understand well the content (theory) about the practical to be performed so as to help students link it with their observation.
- Try to make the required materials available before your students in the laboratory.

In the practicals

- Start by telling your students to join laboratory tables, forming groups of 4 to 5,
- Give them work sheet and ask them to read instructions first.
- Give them time for manipulation (10-15min). Here, they have to follow the instructions provided on worksheet. They have to record their findings making a report to be presented.
- Call two or 3 (or more depending on your time) groups to present their findings. During the presentation, remember to take notes on some key points that are going to guide you in the next step.

- Ask members of other group to give their comments/inputs if any.
- Based on learners' production, through questioning, guide them to draw important conclusion.

Expected answers to the activity 11.3.1

First we calculate the mass of NaOH only by calculations, but you have as teacher follow procedure given in order to perform experiment in the laboratory.

$$\text{Mass of NaOH} = M \times M_w \times V = 250 \times 10^{-3} \times 1 \times 40 = 10\text{g}$$

- Assess the lesson by letting learners to do checking up 11.3.1

Expected answers for checking up 11.3.1

1. a) Let us calculate the mass from molarity and volume:

$$M_w \text{ of } \text{KMnO}_4 = 158\text{g/mol}$$

$$M_{\text{KMnO}_4} = M \times M_w \times V = 0.1\text{mol/l} \times 158\text{g/mol} \times 1\text{L} = 15.8\text{g}$$

Procedure:

- Weight 15.8g of KMnO_4 accurate using glass watch, spatula and analytical balance.
- Dissolve it in a flatted flask of 1L containing already little water and mix using a baguette and shake till you get a homogeneous mixture.
- Top up using distilled water and shake again and cover your solution.
- Label your solution: KMnO_4 0.1M; 1L; the date of the time being and your name.

b) The mass can be derived from normality, as follow:

$$M_{\text{K}_2\text{Cr}_2\text{O}_7} = \frac{N \times M_w \times V}{nf} = \frac{1 \times 294 \times 0.25}{6} = 12.5\text{g}$$

Procedure:

- Weight 12.25 g of $\text{K}_2\text{Cr}_2\text{O}_7$ accurate using glass watch, spatula and analytical balance.
- Dissolve it in a flatted flask of 250ml containing already little water and mix using a baguette and shake till you get homogeneous mixture.
- Top up using distilled water and shake again and cover your solution.
- Label your solution: $\text{K}_2\text{Cr}_2\text{O}_7$ 1N; 250ml; the date of the time being and your name.

$$\text{c) Mass} = M \times V = 5\text{g/l} \times 0.1\text{L} = 0.5\text{g}$$

$$\text{The mass of } \text{H}_2\text{C}_2\text{O}_4 = 0.5\text{g}$$

Follow the above procedure to describe in details the preparation of oxalic acid 5g/l

Lesson 4: Preparation of standard solutions by dilution (80minutes)

a) Prerequisites (10 minutes)

Students will learn better the preparation of standard solutions by dilution if they have understanding on: mole concept especially expressions of concentration.

b) Teaching resources

- Measuring cylinder
- Volumetric flask
- Stopper
- Concentrated H_2SO_4 98%
- Distilled water
- Pipette

c) Learning activities

Before introducing the lesson, let learners attempt activity 11.3.2 which leads learners to the lesson four.

As a facilitator, you are expected to guide learners through the following steps:

Activity 11.3.2: (20 minutes)

Before the practical

- Try to copy this activity on a sheet and make copies equal to the number of groups (of 4 to 5) that you will form according to your class.
- Make sure you understand well the content (theory) about the practical to be performed so as to help students link it with their observation.
- Try to make the required materials available before your students enter (go) in the laboratory.

In the practical

- Start by telling your students to join laboratory tables, forming groups of 4 to 5,
- Give them work sheet and ask them to read instructions first.
- Give them time for manipulation (10-15min). Here, they have to follow the instructions provided on worksheet. They have to record their findings making a report to be presented.
- Call two or 3 (or more depending on your time) groups to present their findings. During the presentation, remember to take notes on some key points that are going to guide you in the next step.
- Ask members of other group to give their comments/inputs if any.
- Based on learners' production, through questioning, guide them to draw

important conclusion.

Expected answers to activity 11.3.2

Molarity of stock solution (M_1 of H_2SO_4) = $\frac{1.84 \times 10 \times 98}{98} = 18.4M$ (M_1)

$V_1 = ?$ $M_2 = 0.5$, $V_2 = 250cm^3$

By using the relation $M_1V_1 = M_2V_2$, we can calculate V_1

Thus, $V_1 = \frac{M_2V_2}{M_1} = \frac{0.5 \times 250}{18.4 \times 1000} = 0.0068dm^3 = 6.8cm^3$

Procedure:

- Pipette only 6.8ml of sulphuric acid accurately using a pipette from a stock solution.
 - Pour them gentle in the volumetric flask of 250mL containing already little water and shake. Note that you should take much care since the reaction is exothermic and sulphuric acid is harmful to skin remember that we pour acid to water not water to acid that is A-W not W-A.
 - Top up to 250mL using distilled water and shake again in order to homogenize the solution.
 - Cover the solution, then label it: H_2SO_4 0.5M; 250mL; Date and name of the manufacturer.
- Assess the lesson by letting learners to do checking up 1.5

Answers to checking up 11.3.2 (30minutes)

$N_1 = 0.2eq/l$ and $N_2 = 0.05eq/l$

Determine: n_d and V_1

Dilution factor is given by: $n_d = \frac{N_1}{N_2} = \frac{0.2N}{0.05N} = 4$

But $N_1V_1 = N_2V_2$, Since $V_2 = V_1 + 200ml$

Therefore $V_1 = 200 \times \frac{C_2}{C_1 - C_2} = 200ml \times \frac{0.05N}{0.2 - 0.05N} = 66.67ml$

Hence, the initial volume before dilution was 66.67ml.

The final volume (V_2) = $V_1 + 200ml = 66.67ml + 200ml = 266.67ml$

Lesson 5: Acid-base titration (80 minutes)

a) Prerequisites (10 minutes)

Students will learn better the acid- base titration if they have understanding on: mole concept especially expressions of concentration.

b) Teaching resources

- Acids like $HCl(aq)$, $H_2SO_4(aq)$
- Bases like $NaOH(aq)$, $KOH(aq)$

- Pipette
- Burette
- Beaker and/or Conical flask
- Indicator like Phenolphthalein, Methyl orange...
- Retort stand and its accessories

c) Learning activities

Activity 11.4: (20 minutes)

Before the practical

- Try to copy this activity on a worksheet and make copies equal to the number of groups (4 to 5) that you will form according to your class size.
- Try to make the required materials available before your students enter (go) in the laboratory.
- Fill burettes with titrant solution for each group.
- Prepare all chemicals needed to perform this practical activity.
- Make sure you understand well the content (theory) about the practical to be performed so as to help students link it with their observations

During practicals

- Start by telling your students to join laboratory tables, forming groups of 4 /5.
- Give them worksheet and ask them to read instructions.
- Ask them to read the procedure written on the worksheet and verify if all chemicals and apparatus are available and well prepared.
- Give them time for manipulation (10-15min). Here, they have to follow the instructions provided on worksheet. They have to record their observations making a report to be presented.
- Call two or three (or more depending on your time) groups to present their findings. During the presentation, remember to take notes on some key points that are going to guide you in the next step.
- Ask members of other groups to give their comments/inputs if any.
- Based on learners' production, through questioning, guide them to draw important conclusion.
- Comment on students' responses written in their notebooks, and give them the summary of expected feedback based on their findings.

Expected answers to the activity 11.4:

As the practical results are not given in this activity, try to perform this practical activity in the laboratory. Using the results obtained attempt the questions related to the activity.

Answers of checking up 11.4 (35minutes)

1. Balanced equation for the reaction between Ba(OH)₂ and HCl:

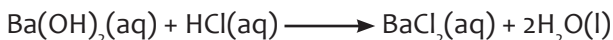

$$\text{Number of moles of HCl that reacted} = M \times V = \frac{0.4 \times 200.4 \times 20}{1000 \times 1000} = 0.008 \text{ mol}$$

From the equation, the mole ratio for Ba(OH)₂: HCl = 1:2

$$\text{Hence } 0.008 \text{ mole of HCl reacts with} = \frac{0.008 \times 1}{2} = 0.004 \text{ mol of Ba(OH)}_2$$

Remember, Molarity = $n \times v$

$$\text{So, Molarity of Ba(OH)}_2 = \frac{0.004 \text{ mol}}{0.04 \text{ l}} = 0.1 \text{ M.}$$

2. Equation of the reaction:



$$\text{Moles of HCl that reacted} = M \times V = 0.25 \text{ mol dm}^{-3} \times 0.015 \text{ dm}^3 = 3.75 \times 10^{-3} \text{ mol}$$

Moles of NaOH neutralized = moles of HCl, since the mole ratio of

NaOH:HCl is 1:1 = $3.75 \times 10^{-3} \text{ mol}$.

$$\text{Molarity of NaOH solution} = \frac{0.00375 \text{ mol}}{0.025 \text{ l}} = 0.15 \text{ M.}$$

3. For this question, teachers are supposed to perform this practical and laboratory, then use results to answer the questions asked

Lesson 6: Titration of Fe²⁺ by potassium manganite (VII) (80minutes)

a) Prerequisites (10minutes)

Students will learn better the titration of iron (II) by potassium manganate (VII) if they have understanding on: mole concept especially expressions of concentration, oxidation number and balancing redox reactions.

b) Teaching resources

- Chalkboard
- Manila paper
- Books
- Computer for Internet purpose

c) Learning activities

Activity 11.5 and Activity 11.5.1 (30minutes)

- After organizing the learners in their respective groups, let them work together in their groups without intervene directly.

- Monitor how the learners are progressing towards the knowledge to be learned and assist those who are still struggling (but without communicating to them the knowledge).
- Invite group leader to present the students' findings, but manage your time well.
- Record the key points for each presentation in order to harmonize later.
- Evaluate the learners' findings and emphasize on which are correct, incomplete or false information by eliminating all mistakes.
- Summarize the contents by giving more examples. Let students do checking up 11.5.1

Learners should do the checking up activity in any method you wish to use.

Expected answer for activity 11.5: see student book (S4) unit: Oxidation and reduction

Expected answers to activity 11.5.1

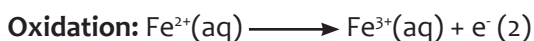
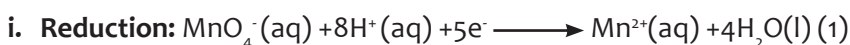

Multiply equation (1) by 1 and equation (2) by 5, add them to get overall ionic equation:



Then, balanced molecular equation is:



ii. The oxidizing agent in the above equation is KMnO_4 and reducing agent is FeSO_4 .

iii. The colour of MnO_4^- is pink, that of Mn^{2+} is colourless and that of Fe^{2+} is green.

Expected answers to checking up 11.5.1:(40minutes)

a) Fe^{2+} ions from the mixture react with MnO_4^- by the reaction:



1000cm^3 of MnO_4^- contain 0.02mol

20cm^3 of MnO_4^- solution will contain = $\frac{0.02\text{mol} \times 20}{1000} = 0.0004\text{mol}$

Number of moles of MnO_4^- used = 0.0004mol

From the above equation, 1mole of MnO_4^- titrates 5moles of Fe^{2+}

$$= 0.0004\text{mol} \times 5 = 0.002\text{mol}$$

But 25cm^3 of the mixture contain 0.002moles of Fe^{2+} ions

1000cm^3 of the mixture will contain = $\frac{0.02\text{mol} \times 1000}{25} = 0.08\text{mol}$

Hence, the concentration of Fe^{2+} in the mixture = 0.08M

b) Zinc powder reduces Fe^{3+} in the mixture to Fe^{2+} by the equation:



Thus, Fe^{2+} formed from reduction and the original Fe^{2+} from the mixture react with MnO_4^- as shown below:



1000cm^3 of MnO_4^- solution contain 0.02mol

24cm^3 of MnO_4^- solution will contain = $\frac{0.02\text{mol} \times 24}{1000} = 0.00048\text{mol}$

Number of moles of MnO_4^- used = 0.00048mol

But mole ratio for $\text{MnO}_4^- : \text{Fe}^{2+} = 1:5$

Moles of Fe^{2+} that reacted = $0.00048 \times 5 = 0.0024\text{mol}$

25cm^3 of the mixture contain 0.0024mol

1000cm^3 of the mixture contain = $\frac{0.0024\text{mol} \times 1000}{25} = 0.096\text{mol}$

Total concentration of Fe^{2+} in the mixture = 0.096mol dm^{-3}

Concentration of Fe^{3+} in the mixture = $0.096 - 0.08 = 0.16\text{mol dm}^{-3}$

Lesson 7: Titration of oxalate, $\text{C}_2\text{O}_4^{2-}$ by potassium manganite (VII)

a) Prerequisites (10minutes)

Students will learn better the titration of oxalate and oxalic acid by potassium manganate (VII) if they have understanding on: mole concept especially expressions of concentration, oxidation number, balancing redox reactions.

b) Teaching resources

- Chalkboard
- Manila paper
- Books
- Computer for Internet purpose.

c) Learning activities

Activity 11.5.2 (40minutes)

- After organizing the learners in their respective groups, let them work together in their groups without intervene directly.
- Monitor how the learners are progressing towards the knowledge to be learned and assist those who are still struggling (but without communicating to them the knowledge).
- Invite group leader to present the students' findings, but manage your time well.
- Record the key points for each presentation in order to harmonize later.

- Evaluate the learners' findings and emphasize on which are correct, incomplete or false information by eliminating all mistakes.
- Summarize the contents by giving more examples. Let students do checking up 11.7.

Learners should do the checking up activity in any method you wish to use.

Expected answers to activity 11.5.2

a) The reaction which occurs is as follows:



One mole of MnO_4^- weighs = 55 + 64 = 119g

Thus, 119g of MnO_4^- contain 1mol

Then, 2.38g of MnO_4^- will contain = $\frac{1 \times 2.38}{119} = 0.02\text{mol}$

Molarity of $\text{MnO}_4^- = 0.02\text{mol dm}^{-3}$

Since 1000cm³ of FA₁ contain 0.02moles of MnO_4^-

Then, 25cm³ of FA₁ contain = $\frac{0.02 \times 25}{1000} = 0.0005\text{mol MnO}_4^-$

Number of moles of MnO_4^- that reacted = 0.0005mol

From the reaction above mole ratio for $\text{MnO}_4^- : \text{Fe}^{2+} = 1:5$

Then, number of moles of $\text{Fe}^{2+} = 5 \times 0.0005\text{mol} = 0.0025\text{mol}$

Then, 25cm³ of FA₂ contain 0.0025moles of Fe^{2+}

1000cm³ of FA₂ contain = $\frac{0.0025 \times 1000}{25} = 0.1\text{mol}$

Molar concentration of Fe^{2+} in FA₂ = 0.1mol.dm⁻³

b) Since 1mole of iron(II) sulphate weighs 278g i.e. Mw = 278g/mol

Then, 0.1mol of iron (II) sulphate will weigh = 278g x 0.1 = 27.8g

Mass of pure iron (II) sulphate in 1dm³ of solution = 27.8g

c) Percentage purity of solution FA₂ = $\frac{27.8 \times 100}{30.6} = 90.8\%$

Expected answers to checking up 11.5.2: (30minutes)

a) Only ethanedioic acid, $\text{H}_2\text{C}_2\text{O}_4$ from the mixture reacts with sodium hydroxide as follows:



1000cm³ of FA₂ contain 0.1mole of NaOH

24.0cm³ of FA₂ contain = $\frac{0.1 \times 24.0}{1000} = 2.4 \times 10^{-3}\text{moles of NaOH}$

From the reaction above mole ratio for $\text{H}_2\text{C}_2\text{O}_4 : \text{NaOH} = 1:2$

Moles of $\text{H}_2\text{C}_2\text{O}_4 = \frac{1 \times 0.0024}{2} = 1.2 \times 10^{-3}\text{mol}$

Then 25cm³ of H₂C₂O₄ contain 1.2x10⁻³mol

$$1000\text{cm}^3 \text{ of H}_2\text{C}_2\text{O}_4 \text{ contain} = \frac{0.0012\text{mol} \times 1000}{25} = 0.048\text{mol dm}^{-3}$$

Molar concentration of H₂C₂O₄ = 0.048M

b) MnO₄⁻(aq) reacts with C₂O₄²⁻(aq) by reaction:

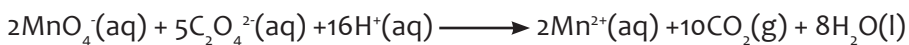

1000cm³ of FA₃ contain 0.02moles of MnO₄⁻

$$35.6\text{cm}^3 \text{ of FA}_3 \text{ will contain} = \frac{0.02\text{mol} \times 35.6}{1000} = 7.21 \times 10^{-4} \text{ moles of MnO}_4^-$$

From the reaction, the mole ratio for C₂O₄²⁻: MnO₄⁻ = 5:2

$$\text{Number of moles of C}_2\text{O}_4^{2-} = \frac{5 \times 0.000721}{2} = 0.0018\text{mol}$$

Thus, 25cm³ of FA₁ contain 0.0018moles of C₂O₄²⁻

$$1000\text{cm}^3 \text{ of FA}_1 \text{ contain} = \frac{0.0018 \times 1000}{25} = 0.0721\text{mol}$$

Concentration of C₂O₄²⁻ in FA₁ = 0.0721mol dm⁻³

Since both H₂C₂O₄ and Na₂C₂O₄ react with MnO₄⁻; then the total concentration of C₂O₄²⁻ = 0.0721mol dm⁻³

Also in aqueous state one mole of H₂C₂O₄ ionizes to produce one mole of C₂O₄²⁻ as:



Thus, 0.048mol in the mixture come from H₂C₂O₄

Since the total moles of C₂O₄²⁻ in FA₁ = 0.0721mol

Then moles of C₂O₄²⁻ from Na₂C₂O₄ alone = 0.0721mol – 0.048mol = 0.0241mol

But one mole of Na₂C₂O₄ weighs = 46+24+64 = 134g/mol

Then 0.0241mol weighs = 134x0.0241= 3.2g

Mass of Na₂C₂O₄ in 1dm³ of FA₁ = 3.2g

$$\text{Percentage of Na}_2\text{C}_2\text{O}_4 \text{ in FA}_1 = \frac{3.2 \times 100}{9.4} = 34\%$$

Lesson 8: Titration of hydrogen peroxide by potassium manganate (VII), KMnO₄

a) Prerequisites (10minutes)

Students will learn better the titration of hydrogen peroxide by potassium manganate (VII) if they have understanding on: mole concept especially expressions of concentration, oxidation number and balancing redox reactions.

b) Teaching resources

- Chalkboard
- Manila paper
- Books
- Computer for Internet purpose.

c) Learning activities

Activity 11.5.3: (30minutes)

After organizing the learners in their respective groups, let them work together in their groups without intervene directly.

- Monitor how the learners are progressing towards the knowledge to be learned and assist those who are still struggling (but without communicating to them the knowledge).
- Invite group leader to present the students' findings, but manage your time well.
- Record the key points for each presentation in order to harmonize later.
- Evaluate the learners' findings and emphasize on which are correct, incomplete or false information by eliminating all mistakes.
- Summarize the contents by giving more examples. Let students do checking up 11.5.3

Learners should do the checking up activity in any method you wish to use.

Expected answers to activity 11.5.3:

Write a balanced equation:

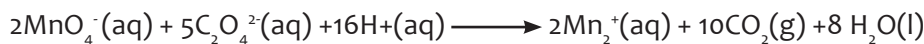

Number of moles of $\text{MnO}_4^- = 0.02 \times 27.5 \times 10^{-3} \text{ mol} = 0.55 \times 10^{-3} \text{ mol}$

Molar ratio, $\text{MnO}_4^- : \text{C}_2\text{O}_4^{2-} = 2:5$

2 moles of $\text{MnO}_4^- \longrightarrow 5$ moles of $\text{C}_2\text{O}_4^{2-} / \text{Ca}_2^+$

$0.55 \times 10^{-3} \text{ mol of MnO}_4^- \longrightarrow \frac{0.00055 \times 5}{2} = 1.375 \times 10^{-3} \text{ moles of C}_2\text{O}_4^{2-} \text{ contained in } 20\text{cm}^3$

Number of moles of $\text{C}_2\text{O}_4^{2-}$ in $1000\text{cm}^3 = \frac{0.001375 \times 1000}{20} = 0.06875 \text{ mole of Ca}_2^+$

Mass of Ca_2^+ present = $40\text{g} \times 0.06875 = 2.75\text{g}$ of Ca_2^+

% mass of Ca_2^+ (purity) = $\frac{2.75 \times 100}{6} = 45.8\%$

Expected answers to checking up 11.5.3: (40minutes)

a) H_2O_2 is oxidized by acidified KMnO_4 according to the equation

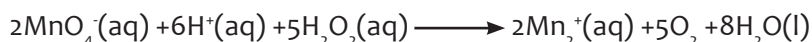

Number of moles of MnO_4^- that reacted = $\frac{0.02 \times 24.6}{1000} = 0.000492 \text{ mol}$

Since 2 moles of MnO_4^- react with 5 moles of H_2O_2 (mole ratio)

Number of moles of H_2O_2 that reacted = $\frac{5 \times 0.000492}{2} = 0.00123 \text{ mol}$

25.0 cm³ of diluted solution contain 0.00123 mole of H_2O_2

250 cm³ of diluted solution contain = $\frac{0.00123 \times 250}{25} = 0.0123 \text{ mol}$

5.0 cm³ of original contain 0.0123 mole of H_2O_2

1000 cm³ of original contain = $\frac{0.0123 \times 1000}{5} = 2.46 \text{ mol dm}^{-3}$

b) From the equation of decomposition



2 moles of H_2O_2 produce 1 mole of oxygen gas

2 moles of H_2O_2 produce 22.4 dm³ of oxygen gas

2.46 mole would produce = $\frac{22.4 \times 2.46}{2} = 27.6 \text{ cm}^3$

Volume strength = 27.6 cm³

Lesson 9: Titration with potassium dichromate, $\text{K}_2\text{Cr}_2\text{O}_7$ (80 minutes)

a) Prerequisites (10 minutes)

Students will learn better the titration with potassium dichromate if they have understanding on: mole concept especially expressions of concentration, oxidation number and balancing redox reactions.

b) Teaching resources

- Chalk board
- Manila paper
- Books
- Computers for internet purpose

c) Learning activities

Activity 11.5.4 (20 minutes)

Guidance on this activity is the same as that of activity 11.10

Expected answers to activity 11.5.4

See student book.

Answers of checking up 11.5.4 (50 minutes)

- Alloy is defined as a homogeneous mixture of metals.
- $\text{Fe}^{2+}(\text{aq}) \longrightarrow \text{Fe}^{3+}(\text{aq}) + \text{e}^-$

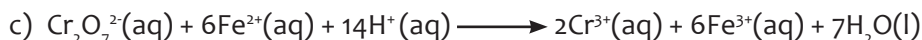

d) Number of moles of $\text{Cr}_2\text{O}_7^{2-} = \text{M} \times \text{V} = 24.4 \times 10^{-3} \text{dm}^3 \times 0.0167 \text{M} = 4.0748 \times 10^{-4} \text{mol}$

e) Mole ratio for $\text{Cr}_2\text{O}_7^{2-} : \text{Fe}^{2+} = 1:6$

Number of moles of $\text{Fe}^{2+} = 6 \times 4.0748 \times 10^{-4} \text{mol} = 2.44488 \times 10^{-3} \text{mol}$ contained in 10cm^3

In 1000cm^3 there will = $\frac{0.00244488 \times 100}{10} = 0.0244488 \text{mol}$

f) Mass of $\text{Fe}^{2+} = 0.0244488 \times 56 \text{g} = 1.369 \text{g}$

$\% \text{Fe}^{2+} = \frac{1.369 \times 100}{1.4} = 97.78\%$

Lesson 10: Iodimetric and iodometric titration (Thiosulphate titration).

a) Prerequisites (10 minutes)

Students will learn better the thiosulphate titration if they have understanding on: mole concept especially expressions of concentration, oxidation number and balancing redox reactions.

b) Teaching resources

- Books
- Manila paper
- Chalks
- Chalkboard
- Flip chart

c) Learning activities

Activity 11.5.5 (20 minutes)

- Divide your class into groups of five students and let students follow the working procedures to obtain the results.
- Let the learners perform the activity using their prior knowledge about definition of standard solutions.
- Have sample group present their work to the class.
- Check learners' responses to review the learners' plans and ideas to continue the discussion with a brief brainstorming of the concepts using learners' work and book.
- Comment on students' responses written in their note books, and give them the summary of expected feedback based on their findings.

Expected answers to the activity 11.5.5

- a) The change in oxidation state of chromium in the reaction is from +6 to +3.

- b) Mass concentration of $\text{FeSO}_4 = 12.15\text{g/l}$
Molarity of $\text{FeSO}_4 = \frac{Cm}{Mw} = \frac{12.15\text{g/l}}{152\text{g/mol}} = 0.08\text{M}$
Number of moles of $\text{Fe}^{2+} = M \times V = 0.08 \times 0.025 = 0.002\text{mol}$
- c) Mw of $\text{K}_2\text{Cr}_2\text{O}_7 = (39 \times 2) + (52 \times 2) + (16 \times 7) = 294\text{g/mol}$
Using the above equation mole ratio $\text{Cr}_2\text{O}_7^{2-} : \text{Fe}^{2+} = 1:6$
Number of moles of $\text{K}_2\text{Cr}_2\text{O}_7 = \frac{1 \times 0.002\text{mol}}{6} = 0.00033\text{mol}$
Mass of $\text{K}_2\text{Cr}_2\text{O}_7 = 0.00033\text{mol} \times 294\text{g/mol} = 0.097\text{g}$
Volume of $\text{K}_2\text{Cr}_2\text{O}_7 = \frac{m}{M \times Mw} = \frac{0.097}{0.02 \times 294} = 0.016\text{dm}^3 = 16\text{ml}$

Expected answers to checking up 11.5.5 (50minutes)

1. a) Iodine reacts with $\text{S}_2\text{O}_3^{2-}$ according to the equation:

$$\text{I}_2(\text{aq}) + 2\text{S}_2\text{O}_3^{2-}(\text{aq}) \longrightarrow 2\text{I}^-(\text{aq}) + \text{S}_4\text{O}_6^{2-}(\text{aq})$$
Thus, 1000cm^3 of $\text{S}_2\text{O}_3^{2-}$ contain 0.1mol
 25.5cm^3 of $\text{S}_2\text{O}_3^{2-}$ contain $= \frac{0.1 \times 25.5\text{mol}}{1000} = 2.55 \times 10^{-3}\text{mol}$
. Moles of $\text{S}_2\text{O}_3^{2-}$ used $= 2.55 \times 10^{-3}\text{mol}$
Since mole ratio for $\text{S}_2\text{O}_3^{2-} : \text{I}_2 = 2:1$
Then moles of I_2 used $= \frac{1 \times 0.00255}{2} = 1.275 \times 10^{-3}\text{mol}$
 25.0cm^3 of I_2 contain $1.275 \times 10^{-3}\text{mol}$
 1000cm^3 of I_2 contain $= \frac{0.001275 \times 1000}{25.0} = 0.051\text{mol/l}$
- b) 1mole of iodine weighs 254g
 $0.051\text{mol/l} \times 254\text{g/mol} = 254\text{g} \times 0.051 = 12.95\text{g/l}$
The concentration of iodine $= 12.95\text{g l}^{-1}$
2. a) XO_3^- reacts with I^- as :

$$\text{XO}_3^-(\text{aq}) + 6\text{I}^-(\text{aq}) + 6\text{H}^+(\text{aq}) \longrightarrow \text{X}(\text{aq}) + 3\text{I}_2(\text{aq}) + 3\text{H}_2\text{O}(\text{l}) \dots \dots \dots (1)$$
Iodine liberated reacts with $\text{S}_2\text{O}_3^{2-}$ as:

$$\text{I}_2(\text{aq}) + 2\text{S}_2\text{O}_3^{2-}(\text{aq}) \longrightarrow 2\text{I}^-(\text{aq}) + \text{S}_4\text{O}_6^{2-}(\text{aq}) \dots \dots \dots (2)$$
 1000cm^3 of $\text{S}_2\text{O}_3^{2-}$ contain 0.05mol
 24.6cm^3 of $\text{S}_2\text{O}_3^{2-}$ contain $= \frac{0.05 \times 24.6\text{mol}}{1000} = 0.00123\text{mol}$
Moles of $\text{S}_2\text{O}_3^{2-}$ used $= 0.00123\text{mol}$.
From equation (2):
Mole ratio $\text{I}_2 : \text{S}_2\text{O}_3^{2-} = 1:2$
Then moles of I_2 used $= \frac{1 \times 0.00123\text{mol}}{2} = 0.000615\text{mol}$

From equation (1):

Mole ratio $\text{XO}_3^- : \text{I}_2 = 1:3$

Then the number of moles of $\text{XO}_3^- = \frac{1 \times 0.000615}{3} = 0.000205 \text{ mol}$

Moles of XO_3^- used = 0.000205 mol

But 25.0 cm³ of XO_3^- contain 0.000205 mol

1000 cm³ of XO_3^- contain = $\frac{0.000205 \times 1000 \text{ mol}}{25} = 0.0082 \text{ mol}$

Molar concentration of $\text{XO}_3^- = 0.0082 \text{ mol dm}^{-3}$

b) 0.0082 M of XO_3^- weighs 1.6236 g dm⁻³

Molar mass of $\text{NaXO}_3 = \frac{1.6236 \text{ g}}{0.0082} = 198.0 \text{ g}$

Thus, 23 + X + 48 = 198

$$X = 198 - 71 = 127$$

X is Iodine and the formula of the salt is NaIO_3

3. a) H_2O_2 reacts with I^- by equation:

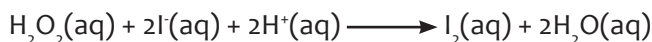

Iodine liberated above reacts with $\text{S}_2\text{O}_3^{2-}$ by the equation:

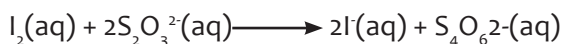

Thus, 1000 cm³ of $\text{S}_2\text{O}_3^{2-}$ contain 0.1 mol

$$28 \text{ cm}^3 \text{ of } \text{S}_2\text{O}_3^{2-} \text{ contain } \frac{0.1 \times 28}{1000} = 0.0028 \text{ mol}$$

Moles of $\text{S}_2\text{O}_3^{2-}$ used = 0.0028 mol

Since 1 mole of H_2O_2 reacts with 2 mol $\text{S}_2\text{O}_3^{2-}$

Then, moles of H_2O_2 that reacted = $\frac{1 \times 0.0028}{2} = 0.0014 \text{ mol}$

25 cm³ of the diluted H_2O_2 solution contain = 0.0014 mol

250 cm³ of the diluted H_2O_2 solution contain = $\frac{0.0014 \times 250 \text{ mol}}{25} = 0.014 \text{ mol}$

Also, 10 cm³ of the stock solution contains 0.014 mol

Then, 1000 cm³ of the stock solution will contain = $\frac{0.014 \times 1000 \text{ mol}}{10} = 1.4 \text{ mol dm}^{-3}$

The concentration of the stock solution = 1.4 M.

b) H_2O_2 decomposes as:



Thus, 2 moles of H_2O_2 1 mole of O_2

Then, 1000 cm³ of 2 moles of H_2O_2 produces 24000 cm³ of O_2

$$1\text{cm}^3 \text{ of } 1.4 \text{ mole of } \text{H}_2\text{O}_2 \text{ produces } = \frac{24 \times 1.4 \text{ cm}^3}{2} = 16.8\text{cm}^3 \text{ of } \text{O}_2$$

The volume strength of the hydrogen peroxide is 16.8

a) Indicator which could be used in the titration is starch.

b) Number of moles of $\text{S}_2\text{O}_3^{2-} = 0.100\text{M} \times 3 \times 10^{-2}\text{dm}^3 = 3 \times 10^{-3} \text{ mol}$

c) In equation (2) mole ratio for $\text{I}_2: \text{S}_2\text{O}_3^{2-} = 1:2$

$$\text{Number of moles of } \text{I}_2 = \frac{1 \times 0.003\text{mol}}{2} = 1.5 \times 10^{-3}\text{mol}$$

d) In equation (1) 1mole of iodine is produced by 2 moles of Cu^{2+}

$$\text{Mole ratio } \text{Cu}^{2+}: \text{I}_2 = 2:1$$

$$\text{Number of moles of } \text{Cu}^{2+} \text{ contained in } 25\text{cm}^3 = 2 \times 1.5 \times 10^{-3}\text{mol} = 3 \times 10^{-3}\text{mol}$$

$$\text{Number of moles of } \text{Cu}^{2+} \text{ in } 250\text{cm}^3 = \frac{0.003 \times 250}{25} = 0.03\text{mol}$$

$$\text{Mass of } \text{Cu}^{2+} = 0.03\text{mol} \times 63.5\text{g/mol} = 1.905\text{g}$$

$$\% \text{ Cu}^{2+} = \frac{1.905 \times 100}{2} = 95.25\%$$

Lesson 11: Back titration (80minutes)

a) Prerequisites (10minutes)

Students will learn better the back titration if they have understanding on: mole concept especially expressions of concentration, acid-base titration, oxidation number and balancing redox reactions.

b) Teaching resources

- Internet connection
- Books
- Manila paper
- Flip charts
- Chalk board

c) Learning activities

Activity 11.6:(20minutes)

Divide your class into groups of five students and let students follow the working procedures to obtain the results.

- Let the learners perform the activity using their prior knowledge about definition of standard solutions.
- Have sample group present their work to the class.
- Check learners' responses to review the learners' plans and ideas to

continue the discussion with a brief brainstorming of the concepts using learners' work and book.

- Comment on students' responses written in their note books, and give them the summary of expected feedback based on their findings.

Expected answers to activity 11.6: See students' book.

Expected answers to checking up 11.6 (50minutes)

1. a) Equation:

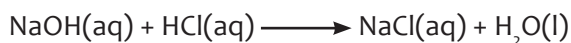

1000cm³ of NaOH solution contain 0.1mol

22.1cm³ of NaOH solution will contain = $\frac{0.1 \times 22.1 \text{ mol}}{1000} = 0.00221\text{mol}$

Number of moles of NaOH used = 0.00221mol

From the reaction above, 1mole of NaOH reacts with 1mole of HCl

i.e. Number of moles of HCl that reacted with NaOH = 0.00221mol.

- b) But 25cm³ of the resultant solution contain 0.00221moles of HCl

250cm³ of the resultant solution will contain = $\frac{0.00221 \times 250 \text{ mol}}{25} = 0.0221\text{mol HCl}$

Total number of moles of HCl provided=?

1000cm³ of original HCl solution contain 1mol

50cm³ of original HCl solution will contain = $\frac{1 \times 50\text{mol}}{1000} = 0.05\text{mol}$

Total number of moles of HCl = 0.05mol

Hence, moles of HCl that reacted with the oxide = 0.05mol – 0.0221mol = 0.0279mol

- c) Since the metal is divalent, the metal oxide(MO) reacts with HCl as:

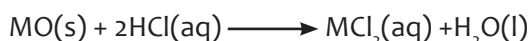

Since ratio MO: HCl =1:2

Then, number of moles of MO that react with HCl = $\frac{1 \times 0.0279}{2} = 0.01395\text{mol}$

Thus, 0.01395moles of MO weighs 0.78g.

Molar mass of MO = $\frac{0.78\text{g}}{0.01395} = 55.9\text{g}$

M + 16 = 55.9

M = 55.9 – 16 =39.9 ≈40

Relative atomic mass of M = 40, M is Ca. The formula of oxide is CaO.

2. Step 1: Determine the amount of HCl in excess from the titration result

1. Write the equation for the titration:



acid + base \longrightarrow salt + water

2. Calculate the moles, n , of NaOH(aq) that reacted in the titration:

moles = concentration (mol L^{-1}) \times Volume (L)

$$n(\text{NaOH(aq)}) = c(\text{NaOH(aq)}) \times V(\text{NaOH(aq)})$$

$$c(\text{NaOH(aq)}) = 0.250 \text{ mol L}^{-1}$$

$$V(\text{NaOH(aq)}) = 32.12 \text{ mL} = 32.12 \times 10^{-3} \text{ L}$$

$$n(\text{NaOH(aq)}) = 0.250 \times 32.12 \times 10^{-3} = 8.03 \times 10^{-3} \text{ mol}$$

3. Use the balanced chemical reaction for the titration to determine the moles of HCl that reacted in the titration (mole ratio (stoichiometric ratio)).

From the balanced chemical equation, 1 mole NaOH reacts with 1 mole of HCl

So, 8.03×10^{-3} mole NaOH reacted with 8.03×10^{-3} moles HCl

4. The amount of HCl that was added to the chalk in excess was 8.03×10^{-3} mol

Step 2: Determine the amount of calcium carbonate in chalk

1. Calculate the total moles of HCl originally added to the chalk:

moles = concentration (mol L^{-1}) \times Volume (L)

$$n(\text{HCl total added}) = c(\text{HCl total added}) \times V(\text{HCl total added})$$

$$c(\text{HCl total added}) = 0.200 \text{ mol L}^{-1}$$

$$V(\text{HCl total added}) = 50.00 \text{ mL} = 50.00 \times 10^{-3} \text{ L}$$

$$n(\text{HCl total added}) = 0.200 \times 50.00 \times 10^{-3} = 0.010 \text{ mol}$$

2. Calculate the moles of HCl that reacted with the calcium carbonate in the chalk

$$n(\text{HCl titrated}) + n(\text{HCl reacted with calcium carbonate}) = n(\text{HCl total added})$$

$$n(\text{HCl total added}) = 0.010 \text{ mol}$$

$$n(\text{HCl titrated}) = 8.03 \times 10^{-3} \text{ mol (calculated in Step 1 above)}$$

$$8.03 \times 10^{-3} + n(\text{HCl reacted with calcium carbonate}) = 0.010 \text{ mol}$$

$$n(\text{HCl reacted with calcium carbonate}) = 0.010 - 8.03 \times 10^{-3} = 1.97 \times 10^{-3} \text{ mol}$$

3. Write the balanced chemical equation for the reaction between calcium carbonate in the chalk and the HCl(aq).

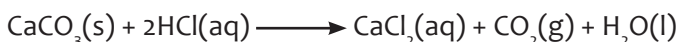

4. From the balanced chemical equation, calculate the moles of CaCO_3 that reacted with HCl.

From the equation, 1 mol CaCO_3 reacts with 2 mol HCl so, 1 mol HCl reacts with $\frac{1}{2}$ mol CaCO_3

So, 1.97×10^{-3} mol HCl had reacted with $\frac{1}{2} \times 1.97 \times 10^{-3} = 9.85 \times 10^{-4}$ mol CaCO_3 in the chalk.

5. Calculate the mass of calcium carbonate in the chalk.

moles = mass (g) \div molar mass (g mol^{-1})

$$n(\text{CaCO}_3) = \text{mass}(\text{CaCO}_3) \div M(\text{CaCO}_3)$$

$$n(\text{CaCO}_3) = 9.85 \times 10^{-4} \text{ mol (moles of CaCO}_3 \text{ that reacted with HCl)}$$

$M(\text{CaCO}_3) = 40.08 + 12.01 + (3 \times 16.00) = 100.09 \text{ g mol}^{-1}$ (using the Periodic Table to find molar mass of each element)

$\text{mass}(\text{CaCO}_3) = n(\text{CaCO}_3) \times M(\text{CaCO}_3) = 9.85 \times 10^{-4} \times 100.09 = 0.099 \text{ g}$

6. The mass of calcium carbonate in the chalk was 0.099 g

Lesson 12: Determination of the number of moles of water of crystallization (80minutes)

a) Prerequisites (10minutes)

Students will learn better the determination of the number of moles of water of crystallization as application of titration if they have understanding on: mole concept especially expressions of concentration, acid-base titration, chemical reactions.

b) Teaching resources

- Internet
- Books
- Manila paper

c) Learning activities

Activity 11.7.1 (20minutes)

See the guidance of the activity 11.13

Expected answer for the activity 11.7.1: See students'book

d) Expected answers to checking up 11.7.1 (50minutes)



b) (i)

- Moles of silver ions added during titration:
 $0.1\text{mol} \times 20 \times 10^{-3} = 2 \times 10^{-3}\text{mol}$
- Moles of chlorine ions that were there in 20cm^3 of the barium chloride solution
= moles of silver ions = $2 \times 10^{-3}\text{mol}$
- Moles of anhydrous barium chloride dissolved in 250cm^3 of the solution:
 $= \frac{1 \times 0.002 \times 250}{2 \times 20} = 12.5 \times 10^{-3}\text{mol}$
- Relative formula mass of hydrated barium chloride
 $= \frac{3.05\text{g}}{0.0125} = 244\text{g}$
- Relative formula mass of anhydrous barium chloride:
 $= 137 + 71 = 208$

$$- \text{ The value of X in } \text{BaCl}_2 \cdot x\text{H}_2\text{O} = \frac{244 - 208}{18} = 2$$

The formula of hydrated barium chloride is $\text{BaCl}_2 \cdot 2\text{H}_2\text{O}$

(ii) Equation for the action of heat on the hydrated barium chloride is:



Lesson 13: Determination of atomic masses

a) Prerequisites (10minutes)

Students will learn better the determination of the number of moles of water of crystallization as application of titration if they have understanding on: mole concept especially expressions of concentration, acid-base titration, chemical reactions.

b) Teaching resources

- Internet
- Books
- Manila paper
- Chalkboard

c) Learning activities

Activity 11.7.2 (20minutes)

After organizing the learners in their respective groups, let them work together in their groups without intervene directly.

- Monitor how the learners are progressing towards the knowledge to be learned and assist those who are still struggling (but without communicating to them the knowledge).
- Invite group leader to present the students' findings, but manage your time well.
- Record the key points for each presentation in order to harmonize later.
- Evaluate the learners' findings and emphasize on which are correct, incomplete or false information by eliminating all mistakes.

Expected answers to activity 11.7.2

$$\text{Mass of water} = 4.99\text{g} - 3.19\text{g} = 1.8\text{g}$$

$$\text{Number of moles of anhydrous } \text{CuSO}_4 = \frac{3.19}{159.5} = 0.02\text{mol}$$

$$\text{Number of moles of water} = \frac{1.8}{18} = 0.1\text{mol}$$

$$\text{Number of moles of water of crystallization} = \frac{0.1}{0.02} = 5$$

So, we may write: $\text{CuSO}_4 \cdot 5\text{H}_2\text{O}$

d) Proposed answers for checking up 11.7.2 (50minutes)

1. Equation of reaction:



- Number of moles of HCl = $0.1\text{M} \times 0.0488\text{dm}^3 = 0.00488\text{mol}$

- Number of moles of Na_2CO_3 in 25cm^3

Mole ratio for Na_2CO_3 : HCl = 1:2

$$= \frac{0.00488 \text{ mol} \times 1}{2} = 0.00244\text{mol}$$

- Molarity of $\text{Na}_2\text{CO}_3 \cdot x\text{H}_2\text{O} = \frac{0.00244 \times 1000}{25} = 0.0976\text{M}$.

- Mass concentration of $\text{Na}_2\text{CO}_3 \cdot x\text{H}_2\text{O} = 27.823\text{g/l}$

- Molar mass of $\text{Na}_2\text{CO}_3 \cdot x\text{H}_2\text{O} = \frac{\text{Mass concentration}}{\text{Molarity}}$
 $= \frac{27.823 \text{ g/l}}{0.0976 \text{ mol/l}} = 284\text{g}$

$$(23 \times 2) + 12 + (16 \times 3) + 18x = 284$$

$$18x = 284 - 46 - 12 - 48 = 178$$

$$x = \frac{178}{18} = 9.9 \approx 10 \text{ i.e. } x=10$$

The formula is $\text{Na}_2\text{CO}_3 \cdot 10\text{H}_2\text{O}$

2. Equation: $\text{XOH}(\text{aq}) + \text{HCl}(\text{aq}) \longrightarrow \text{XCl}(\text{aq}) + \text{H}_2\text{O}(\text{l})$

- Number of moles of HCl = $\frac{100 \times 2}{1000} = 0.2\text{mol}$

Mole ratio for XOH: HCl = 1:1

So, number of moles of XOH = 0.2mol

- Relative molecular mass of XOH = $\frac{8\text{g}}{0.2} = 40\text{g}$

$$40 = X + 17, X = 40 - 17 = 23$$

For the periodic table, the element X is sodium (Na) and the formula group I hydroxide is NaOH

11.7 Summary of the unit

In this unit we have discussed about preparation of standard solutions, properties of primary standard, acid-base titration and redox titration.

In analytical chemistry, a standard solution is a solution containing a precisely known concentration of an element or a substance and used to determine the unknown concentration of other solution. Standard solutions can be prepared by two methods such as dissolution and dilution methods.

The titration is the controlled addition and measurement of the amount of a solution of known concentration required to react completely with a measured amount of a

solution of unknown concentration. The point at which the two solutions used in a titration are present in chemically equivalent amount is the equivalence point.

The unit also focused on acid-base titrations, redox titrations and back titrations. Titration has two main applications such as: Determination of the number of moles of water of crystallisation and determination of relative atomic mass.

11.8 Additional information

The following substances cannot be used as primary standards:

1. Sodium hydroxide (NaOH) because:

- (i) It is deliquescent i.e. during weighing it absorbs water vapour from air, eventually forming a concentrated solution of the solid.



- (ii) It absorbs carbon dioxide from the air forming a solution of Na_2CO_3 .



When excess carbon dioxide gas comes into contact with NaOH a white powder of sodium hydrogen carbonate is precipitated. This occurs when NaOH is either in solid pellet form or in a concentrated solution i.e.

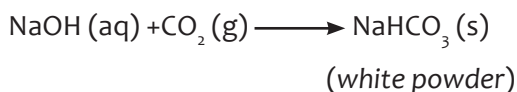
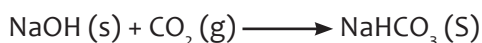

2. Potassium permanganate (KMnO₄) because:

It is contaminated by MnO_2 thus its solution should be filtered first before use.

In the presence of strongly alkaline solution, permanganate ion (MnO_4^-) are reduced to dark brown or gray-black MnO_2 i.e.



(Deep purple)

(Dark-brown)

It is slowly reduced by ordinary distilled water to manganese (IV) oxide, MnO_2 especially in the presence of acid or strong light i.e.

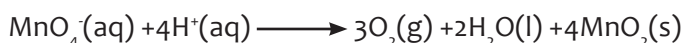

MnO_4^- a very powerful oxidising agent cannot be acidified using hydrochloric acid. Only sulphuric acid can be used. MnO_4^- ions oxidizes the Cl^- ions to chlorine thus affecting the end-point i.e.

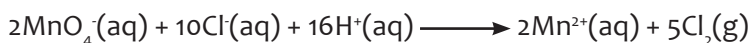

Note: KMnO_4 can be standardized using arsenic (III) oxide or sodium oxalate as primary standard.

3. Sodium thiosulphate ($\text{Na}_2\text{S}_2\text{O}_3$) because:

It has variable water content. When left exposed to air, its solution readily absorbs carbon dioxide from air, which forms carbonic acid. $S_2O_3^{2-}$ ions being very sensitive to acidic media (weak or strong) gets decomposed to $SO_2(g)$ and sulphur which initially appears as a cloudy white precipitate suspended in solution which later settles down as a yellow solid as shown in the disproportionation reaction below:



Other compounds which cannot be used as primary standards include:

4. **Ammonium iron (II) sulphate** because has variable composition.
5. **Slaked lime, $Ca(OH)_2$** because is not readily soluble in water and it also reacts with carbon dioxide in air.
6. **Conc. H_2SO_4 and CaO** are hygroscopic.
7. **Conc. HNO_3** is highly oxidizing.
8. **Absolute ethanol** has variable concentration and is volatile.

11.9 End unit assessment (answers) (80 minutes)

Standard of performance: Correctly prepare standard solutions and use them to determine the concentration of other solutions by titration.

1. a) A standard solution is one whose concentration is known.
b) A primary standard is a compound of known concentration, which is used for preparing a standard solution.
2. Characteristics of a good primary standard are the following:
 - (i) Must always be available pure form
 - (ii) Must be stable in air
 - (iii) Must be readily soluble in a given solvent
 - (iv) Must have a high molecular weight and
 - (v) Must give consistent titre values.
3. Equation for the reaction: $NaOH(aq) + HCl(aq) \longrightarrow NaCl(aq) + H_2O(l)$
 Number of moles of $HCl = 0.102 \text{ mol dm}^{-3} \times 0.030 \text{ dm}^3 = 0.00306 \text{ mol}$
 Moles of $NaOH$ in $25 \text{ cm}^3 = 0.00306 \text{ mol}$ (since the mole ratio is 1:1)
 Moles of $NaOH$ in $1.00 \text{ dm}^3 = \frac{0.00306 \text{ mol} \times 1}{0.025} = 0.1224 \text{ mol}$
 Mass of $NaOH$ in the impure sample = $0.1224 \text{ mol} \times 40 \text{ g/mol} = 4.896 \text{ g}$
 % purity of $NaOH = \frac{\text{Mass of } NaOH \times 100}{\text{Mass of impure } NaOH} = \frac{4.896 \times 100}{5} = 97.92\%$
4. Equation of the reaction:



Number of moles of $\text{HNO}_3 = 1 \times 0.05 = 0.05 \text{ mol}$

Molar ratio $\text{HNO}_3 : \text{Na}_2\text{CO}_3 = 2 : 1$

So, 2 moles of HNO_3 reacts with 1 mole of Na_2CO_3

0.05 moles of $\text{HNO}_3 = \frac{0.05 \times 1}{2} = 0.025$ moles of Na_2CO_3

Mass of $\text{Na}_2\text{CO}_3 = 0.025 \text{ mol} \times 106 \text{ g/mol} = 2.65 \text{ g}$

Percentage of $\text{Na}_2\text{CO}_3 = \frac{2.65 \times 100}{10} = 26.5\%$

Therefore, percentage of $\text{Mg}(\text{NO}_3)_2$ in the mixture = $100 - 26.5 = 73.5\%$

5. a) It is used in the digestion of the wire in order to get analyte, and in the second it is involved in order to acidify since manganometric titration require acid medium for avoiding precipitation of MnO_2 as a brown solid.

b)(i) The advantages of potassium manganate(VII) as oxidizing agent are:

- It acts as its own indicator
- The crystals are obtained at high state of purity
- The crystals are anhydrous and not deliquescent
- It has a fairly high relative molecular mass
- A wide range of substance can be oxidized by it.

(ii) Potassium manganate (VII) has also disadvantages:

- The crystals are not very soluble in water
- The compound is decomposed by the light
- The compound is reduced by water and organic matter from atmosphere
- The meniscus of the solution may be difficult to see.

c) We do not need an indicator in manganometric titration since KMnO_4 solution acts itself the role indicator because at end- point, solution turns purple (persistent).



e) Equation of reaction:



Number of moles of $\text{MnO}_4^- = 0.02 \text{ M} \times 45 \times 10^{-3} \text{ dm}^3 = 0.9 \times 10^{-3} \text{ mol}$

Mole ration between MnO_4^- and $\text{Fe}^{2+} = 1:5$

Number of moles of $\text{Fe}^{2+} = 5 \times 0.9 \times 10^{-3} \text{ mol} = 4.5 \times 10^{-3} \text{ mol} / 20 \text{ cm}^3$

Number of moles of Fe^{2+} in 1000 cm^3 or $1 \text{ dm}^3 = \frac{0.0045 \times 1000}{20} = 0.225 \text{ mol}$

Mass of iron in the sample = $0.225 \text{ mol} \times 56 \text{ g/mol} = 12.6 \text{ g}$

$$\%Fe^{2+} = \frac{12.6 \times 100}{13} = 96.9\%$$

6. Number of OH^- reacted = $0.1 \times 23.8 \times 10^{-3} \text{ mol} = 23.8 \times 10^{-4} \text{ mol}$. Since 1mole of H^+ reacts with 1mole of OH^- , the moles of H^+ reacted are: $23.8 \times 10^{-4} \text{ mol}$

Then 25 cm^3 of FA1 solution contain 0.00238 moles of H^+

$$1000 \text{ cm}^3 \text{ contain} = \frac{0.00238 \times 1000}{25} = 0.0952 \text{ moles of } H^+ = Y$$

$$\text{Number of moles of } MnO_4^- \text{ reacted} = 0.02 \times 31.7 \times 10^{-3} = 0.000635 \text{ mol}$$

Since 2moles of MnO_4^- react with 5 moles of $C_2O_4^{2-}$ (from equation),

$$\text{Number of moles of } C_2O_4^{2-} \text{ reacted} = \frac{5 \times 0.000635}{2} = 0.0015875 \text{ mol in}$$

$$25 \text{ cm}^3 \text{ In } 1000 \text{ cm}^3 \text{ there are} = \frac{0.0015875 \times 1000}{25} = 0.0635 \text{ mol} = Z$$

But $X + Y = 2Z$, $X = 2Z - Y$ since the salt is neutral.

$$X = 2(0.0635) - 0.0952 \text{ mol} = 0.0318 \text{ mol} = \text{number of moles of } K^+$$

	X	Y	Z
Number of moles	0.0318	0.0952	0.0635
Dividing by the smallest to get atomic ratio	$\frac{0.0318}{0.0318} = 1$	$\frac{0.0952}{0.0318} = 3$	$\frac{0.0635}{0.0318} = 2$

- $X=1$
- $Y=3$
- $Z=2$
- The molarity of the salt $K_1H_3(C_2O_4)_2 \cdot nH_2O = \text{concentration of } C_2O_4^{2-} / 2$
 $= 0.0635 \text{ M} / 2 = 0.0318 \text{ M}$.

$$0.0318 \text{ moles of the salt weighs } 8.0 \text{ g. So, 1mole of the salt weighs} = \frac{8.0 \text{ g}}{0.0318} = 251.5 \text{ g}$$

- Calculate the value of n

$$39 + 3 + 176 + 18n = 251.5; \text{ Solving with respect to } n \text{ we get } n=2$$

The number of moles of water of crystallization is 2.

The formula of the compound becomes $KH_3(C_2O_4)_2 \cdot 2H_2O$

- The titration equation is:

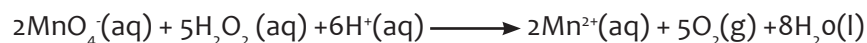

$$\text{a) Molarity of FA}_1 = \frac{2.41 \text{ g/l}}{158 \text{ g/mol}} = 0.015 \text{ M}$$

$$\text{b) Number of moles of } MnO_4^- \text{ reacted} = 0.015 \text{ M} \times 17.5 \times 10^{-3} \text{ dm}^3 = 2.625 \times 10^{-4} \text{ mol}$$

Since, mole ratio for H_2O_2 and MnO_4^- is 2:5, therefore number of moles of H_2O_2 is given by = $\frac{5 \times 0.0002625}{2} = 6.5625 \times 10^{-4}$ mol in 10cm^3

In 250cm^3 , there will be = $\frac{0.00065625\text{mol} \times 250\text{cm}^3}{10\text{cm}^3} = 0.01641\text{mol}$

Since, FA_2 was made by diluting 10.0cm^3 of the original H_2O_2 to 250cm^3 , therefore 10cm^3 of the original H_2O_2 will contain 0.01641 mol i.e.

Concentration of original $\text{H}_2\text{O}_2 = \frac{0.01641\text{mol}}{0.01\text{L}} = 1.64\text{M}$

c) Concentration in grams per litre = $M \times M_w = 1.64\text{M} \times 34\text{g/L} = 55.76\text{g/L}$

d) By, definition, volume strength is the volume occupied by the oxygen on decomposition of a given 1mole of H_2O_2 solution at standard temperature and pressure (STP).

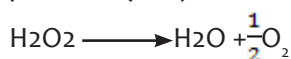

Thus, number of moles of $\text{O}_2 = \frac{1.64 \times 1}{2} = 0.82\text{mol}$ of O_2 from 1L of H_2O_2

But, one mole of any gas in STP occupies 22.4L , therefore

Volume of oxygen = $0.82\text{mol} \times 22.4\text{L/mol} = 18.368\text{L}$

Hence, the volume strength of H_2O_2 of 18.368 volumes.

8. a) Potassium dichromate (VI) is preferred to potassium permanganate (KMnO_4) as an oxidizing agent because potassium permanganate has a tendency of being reduced to form a solid manganese(IV) oxide.



(ii) Number of moles of potassium dichromate used = $0.01\text{M} \times 23.5 \times 10^{-3}\text{dm}^3 = 2.35 \times 10^{-4}\text{mol}$

(iii) Calculate the number the number of moles of tin (Sn) in 250cm^3 of solution



Mole ratio is 1:3

Moles of tin that reacted = $2.35 \times 10^{-4}\text{mol} \times 3 = 7.05 \times 10^{-4}$ moles in 25cm^3

Moles of tin contain in $250\text{cm}^3 = \frac{0.000705 \times 250}{25} = 0.00705$ moles of tin

(iv) Determine the percentage by mass of tin in the solder

Atomic mass of tin = 119

Mass of tin in 250cm^3 of ore = $0.00705\text{mol} \times 119\text{mol/g} = 0.83875\text{g}$

Percentage of tin = $\frac{0.83875 \times 100}{3.8} = 22.08\%$

9. Theory:

Liquid household bleach contains sodium chlorate NaOCl . The chlorate ion reacts with potassium iodide solution to give iodide according to the reaction.



The iodine produced then reacts with $\text{S}_2\text{O}_3^{2-}$ according to the equation.



a) Number of moles of $\text{S}_2\text{O}_3^{2-}$ that reacted = $\frac{14.8 \times 0.2}{1000} = 0.00296 \text{ mol}$

Number of moles of I_2 that reacted = $\frac{1 \times 0.00296}{2} = 0.00148 \text{ mol}$

25.0 cm³ of diluted solution contain 0.00148 mole of I_2

250 cm³ contain = $\frac{0.00148 \times 250}{25} = 0.0148 \text{ mol}$

20 cm³ of original solution contain 0.0148 mole of I_2

1000 cm³ of original solution contain = $\frac{0.0148 \times 1000}{20} = 0.74 \text{ mol}$

Since 1 mole of ClO^- produced 1 mole of I_2

Concentration in mol dm⁻³ of bleach (ClO^-) = 0.74 mol

b) Concentration in g/dm³ of NaOCl = 0.74 x RFM = 0.74 x 74.5 = 55.13 g/dm³

c) 250 cm³ of dilute solution (20 cm³ of original solution) contain 0.0148 mole of I_2

But 1 mole I_2 is produced by 1 mole of Cl_2

Number moles of Cl_2 produced in 20 cm³ of original solution = 0.0148 mol

Mass of chlorine = 0.0148 x 71 = 1.05083 g

% available chlorine = $\frac{\text{mass of Cl}_2 \times 100}{\text{Volume of original}} = \frac{1.0508 \times 100}{20} = 5.25\%$

10. Volume of the pipette used = 25.0 cm³

Final burette reading (cm ³)	15.30	30.40	45.50
Initial burette reading (cm ³)	0.00	15.30	30.40
Volume of 1M NaOH used (cm ³)	15.30	15.10	15.10

The average volume of 1M NaOH used = $\frac{15.10 + 15.10}{2} = 15.10 \text{ cm}^3$

a) The total number of moles of HCl used to prepare BA solution:

In 1000 cm³ of HCl contain 1 mole of HCl

In 25 cm³ of HCl = $\frac{1 \times 25}{1000} = 0.025 \text{ mol}$ of HCl

b) The equation of the reaction between MCO_3 and HCl:



c) The number of moles of 1M NaOH that reacted with excess HCl

$$= \frac{1 \text{ mol} \times 15.10}{1000} = 15.10 \times 10^{-3} \text{ mol}$$

d) The equation of reaction between NaOH and HCl:



e) The mole ratio of NaOH:HCl = 1:1

f) Therefore, the moles of the excess of HCl =

$$\text{Moles of excess HCl} = n \text{ NaOH reacted with excess} = 15.10 \times 10^{-3} \text{ mol}$$

g) The moles of HCl that reacted with MCO_3 = Total moles of HCl – moles of excess

$$= 25 \times 10^{-3} \text{ mol} - 15.10 \times 10^{-3} \text{ mol} = 9.90 \times 10^{-3} \text{ moles of HCl}$$

h) The mole ratio of MCO_3 : HCl = 1:2

i) The moles of MCO_3 that reacted with hydrogen chloride acid = $\frac{1 \times 9.90 \times 10^{-3}}{2}$
 $= 4.95 \times 10^{-3} \text{ mol}$

j) The molar mass of $\text{MCO}_3 = \frac{\text{mass (g)}}{\text{Number of moles}} = \frac{0.5\text{g}}{0.00495\text{mol}} = 100\text{g/mol}$

k) The atomic mass (Ar) of M:

$$100 = M + 12 + 48$$

$$M = 100 - 60 = 40 \text{ so M is Calcium}$$

Formula of carbonate is CaCO_3

11. Volume of the pipette used = 25.0cm^3

Final burette reading(cm^3)	24.18	24.10	24.00
Initial burette reading(cm^3)	0.00	0.00	0.00
Volume of 0.1M NaOH(cm^3)	24.18	24.10	24.00

Average volume of NaOH used = $\frac{24.10 + 24.00}{2} = 24.05\text{cm}^3$

a) Equation: $2\text{NaOH(aq)} + \text{H}_2\text{C}_2\text{O}_4(\text{aq}) \longrightarrow \text{Na}_2\text{C}_2\text{O}_4(\text{aq}) + 2\text{H}_2\text{O(l)}$

b) Moles of NaOH that reacted = $0.1\text{M} \times 24.05 \times 10^{-3} \text{ dm}^3 = 24.05 \times 10^{-4} \text{ mol}$

c) Mole ration of $\text{H}_2\text{C}_2\text{O}_4$: NaOH = 1:2

d) Moles of $\text{H}_2\text{C}_2\text{O}_4$ that reacted = $\frac{1 \times 0.002405}{2} = 12.025 \times 10^{-4} \text{ mol}$

e) Molarity of $\text{H}_2\text{C}_2\text{O}_4 = \frac{0.0012025 \text{ mol}}{0.025\text{l}} = 0.05\text{M}$

f) Relative molecular mass = $\frac{\text{concentration}(\frac{\text{g}}{\text{l}})}{\text{Molarity}} = \frac{6.3\text{g/l}}{0.05} = 126\text{g/mol}$

g) $126 = 18x + 90$

$$18x = 126 - 90 = 36$$

$$x = \frac{36}{18} = 2$$

The formula is $\text{H}_2\text{C}_2\text{O}_4 \cdot 2\text{H}_2\text{O}$

12. a) Number of moles of HCl that reacted with excess NaOH

$$= \frac{0.1 \times 25}{1000} = 0.0025 \text{ mol}$$

From the equation of reaction: $\text{HCl}(\text{aq}) + \text{NaOH}(\text{aq}) \longrightarrow \text{NaCl}(\text{aq}) + \text{H}_2\text{O}(\text{l})$

Since mole ratio = 1:1

$$\text{Number of moles of excess NaOH} = 0.0025 \text{ mol}$$

$$\text{Original number of moles of NaOH added} = \frac{50 \times 0.150 \times 0.1}{1000 \times 1000} = 0.005 \text{ mol}$$

$$\text{Number of moles of NaOH that reacted with } \text{NH}_4\text{X} = 0.005 - 0.0025 \text{ mol} = 0.0025 \text{ mol}$$

b) From the equation of reaction: $\text{NH}_4\text{X}(\text{aq}) + \text{OH}^-(\text{aq}) \longrightarrow \text{NH}_3(\text{g}) + \text{X}^-(\text{aq}) + \text{H}_2\text{O}(\text{l})$

Since mole ratio = 1:1

$$\text{Number of moles of } \text{NH}_3 \text{ that was produced} = 0.0025 \text{ mol.}$$

13. Number of moles of NaOH that reacted with excess acid = $\frac{0.2 \times 10.90}{1000} = 0.00218 \text{ mol}$

From the equation of reaction



Since mole ratio = 1:1

$$\text{Number of moles of excess acid} = 0.00218 \text{ mol}$$

$$\text{Original number of moles of HCl added} = \frac{0.4 \times 100}{1000} = 0.04 \text{ mol}$$

$$\text{Number of moles of HCl that reacted with } \text{Ba}(\text{OH})_2 = 0.04 \text{ mol} - 0.00218 \text{ mol} = 0.03872 \text{ mol}$$

From the equation:



Since mole ratio for $\text{Ba}(\text{OH})_2$: HCl = 1:2

$$\text{Number of moles of } \text{Ba}(\text{OH})_2 = \frac{1 \times 0.03872 \text{ mol}}{2} = 0.01936 \text{ mol}$$

$$\text{Relative formula mass of } \text{Ba}(\text{OH})_2 = 137 + (16 \times 2) + (1 \times 2) = 191 \text{ g/mol}$$

$$\text{Mass of pure } \text{Ba}(\text{OH})_2 = 0.01936 \text{ mol} \times 191 \text{ g/mol} = 3.31 \text{ g}$$

$$\text{Percentage purity of } \text{Ba}(\text{OH})_2 = \frac{3.31 \times 100}{3.40} = 97.35\%$$

11.10 Additional activities

a) Remedial Activities

- Describe how you would prepare 1000cm³ of a 1.0N solution of magnesium hydroxide. The gram formula weight of magnesium hydroxide is 58g/mol.

Answers:

Magnesium hydroxide contains two hydroxyl groups. One-half mole of magnesium hydroxide, therefore, accepts one mole of protons. To prepare a 1.0 N solution of magnesium hydroxide, slowly add 29g magnesium hydroxide to a 500ml volumetric flask half-filled with distilled water and swirl the flask to mix. When all the solid is dissolved and the solution is at room temperature, dilute to the mark and invert the flask several times to mix.

- 5.125g of washing soda crystals are dissolved and made up to 250cm³ of solution. A 25.0cm³ portion of the solution requires 35.8cm³ of 0.0500M sulphuric acid for neutralisation. Calculate the percentage of sodium carbonate in the crystals.

Answers:

- Write equation:



1mole of Na₂CO₃ neutralises 1 mole of H₂SO₄.

- Calculate the amount, in moles, of the standard reagent.

$$\text{Amount (mol) of H}_2\text{SO}_4 = 35.8 \times 10^{-3} \text{dm}^3 \times 0.05 \text{mol dm}^{-3} = 1.79 \times 10^{-3} \text{mol}$$

$$\text{Amount (mol) of Na}_2\text{CO}_3 = 1.79 \times 10^{-3} \text{mol}$$

$$\text{But: Amount of Na}_2\text{CO}_3 = 25.0 \times 10^{-3} \text{dm}^3 \times c$$

$$\text{Equate these two values: } 1.79 \times 10^{-3} \text{mol} = 25.0 \times 10^{-3} \text{dm}^3 \times c$$

$$c = \frac{0.00179 \text{mol}}{0.00025 \text{dm}^3} = 0.0716 \text{mol dm}^{-3}$$

$$\text{Amount (mol) of Na}_2\text{CO}_3 \text{ in whole solution} = \text{volume} \times \text{concentration}$$

$$= 250 \times 10^{-3} \text{dm}^3 \times 0.0716 \text{M} = 0.0179 \text{mol}$$

$$\text{Mass of Na}_2\text{CO}_3 = 0.0179 \text{mol} \times 106 \text{g mol}^{-1} = 1.90 \text{g}$$

$$\% \text{ of Na}_2\text{CO}_3 = \frac{1.90 \text{g} \times 100}{5.125 \text{g}} = 37.1\%$$

Washing soda crystals are 37.1% sodium carbonate.

b) Consolidation activities

- Ammonium iron (II) sulphate crystals have the following formula:

(NH₄)₂SO₄·FeSO₄·nH₂O. In an experiment to determine n, 8.492g of the salt were dissolved and made up to 250cm³ of solution with distilled water and dilute sulphuric acid. A 25.0cm³ portion of the solution was further acidified and titrated against potassium manganate (VII) solution of concentration 0.0150M. A volume of 22.5cm³ was required. (Fe=56, S=32, O=16, H=1).

Answers:

The equation for the half-reactions are:



Multiply (2) by 5 and then adding to (1) gives

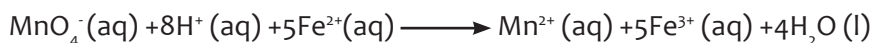

Number of moles of $\text{MnO}_4^- = 22.5 \times 10^{-3} \text{dm}^3 \times 0.0150 \text{M} = 0.338 \times 10^{-3} \text{mol}$

Mole ratio between $\text{MnO}_4^- : \text{Fe}^{2+} = 1:5$

Number of moles of $\text{Fe}^{2+} = 5 \times 0.338 \times 10^{-3} \text{mol} = 1.69 \times 10^{-3} \text{mol}$

Concentration of $\text{Fe}^{2+} = \frac{0.00169 \text{mol}}{0.025 \text{dm}^3} = 0.0674 \text{mol dm}^{-3}$

Concentration of $(\text{NH}_4)_2\text{SO}_4 \cdot \text{FeSO}_4 \cdot n\text{H}_2\text{O} = \frac{\text{Mass in 1dm}^3 \text{ of solution}}{\text{Molar mass}}$

$$0.0674 \text{M} = \frac{4 \times 8.492 \text{g dm}^{-3}}{\text{Molar mass}}$$

$$\text{Molar mass} = \frac{4 \times 8.492 \text{g dm}^{-3}}{0.0674 \text{mol dm}^{-3}} = 503.9 \text{g/mol}$$

$$28 + 8 + 32 + 64 + 56 + 64 + 32 + 18n = 503.9$$

$$18n = 503.9 - 284$$

$$18n = 219.9 \text{ Thus, } n = \frac{219.9}{18} = 12$$

Hence, the formula of the crystal is $(\text{NH}_4)_2\text{SO}_4 \cdot \text{FeSO}_4 \cdot 12\text{H}_2\text{O}$.

2. A solution of hydrogen peroxide was diluted 20.0 times. A 25.0cm^3 portion of the diluted solution was acidified and titrated against 0.0150M potassium manganate (VII) solution. 45.7cm^3 of the oxidant were required.

a) Calculate the concentration of the hydrogen peroxide solution in mol dm^{-3}

b) Calculate the volume concentration. (This means the number of volumes of oxygen obtained from one volume of the solution).

Answer:

a) The equations for the half-reactions are:

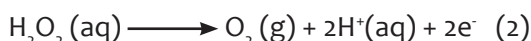

Multiplying (1) by 2 and (2) by 5, and adding the two equations gives

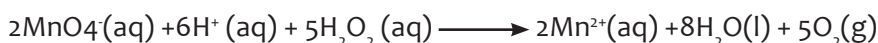

Number of moles of $\text{MnO}_4^- = 45.7 \times 10^{-3} \text{dm}^3 \times 0.0150 \text{mol dm}^{-3} = 0.685 \times 10^{-3} \text{mol}$

Mole ratio between MnO_4^- and $\text{H}_2\text{O}_2 = 2:5$

$$\text{Number of moles of } \text{H}_2\text{O}_2 = \frac{5 \times 0.685 \times 10^{-3} \text{mol}}{2} = 1.71 \times 10^{-3} \text{mol}$$

Concentration of $\text{H}_2\text{O}_2 = \frac{0.00171 \text{ mol} \times 1000}{25 \text{ l}} = 0.0684 \text{ mol/l}$

Concentration of original solution = $20.0 \times 0.0684 \text{ mol dm}^{-3} = 1.37 \text{ mol dm}^{-3}$

b) When hydrogen peroxide decomposes,

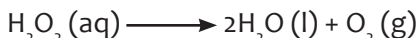

2 moles of hydrogen peroxide forms 1 mole of oxygen. Therefore a solution of hydrogen peroxide of concentration 2M is a 22.4 volume solution (the volume of 1 mole of oxygen at s.t.p.).

A solution of H_2O_2 of concentration 1.37M is a $\frac{22.4 \times 1.37}{2} = 15.4$ volume solution.

c) Extended activities

1. A student was asked to determine the concentration of ammonia, a volatile substance, in a commercially available cloudy ammonia solution used for cleaning. First the student pipetted 25.0ml of the cloudy ammonia solution into a 250.0ml conical flask.

50.00ml of $\text{HCl}(\text{aq})$ was immediately added to the conical flask which reacted with the ammonia in solution.

The excess (unreacted) HCl was then titrated with 0.050M $\text{Na}_2\text{CO}_3(\text{aq})$ was required. Calculate the concentration of the ammonia solution.

Answer:

Step 1: Determine the amount of HCl in excess from the titration results.

1) Write the equation for the titration:

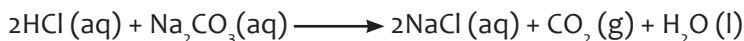

2) Calculate the moles of Na_2CO_3 that reacted in the titration

$$= 0.050 \times 21.50 \times 10^{-3} = 1.075 \times 10^{-3} \text{ mol}$$

3) Use the balanced chemical reaction for the titration to determine the moles of HCl that reacted in the titration (mole ratio). From the balanced chemical equation; 1 mole of Na_2CO_3 reacts with 2 moles of HCl

So, $1.075 \times 10^{-3} \text{ mol} \times 2 = 2.150 \times 10^{-3}$ moles of HCl titrated.

4) The amount of HCl that was added to the cloudy ammonia solution in excess was:

$$n\text{HCl}(\text{excess}) = 2.150 \times 10^{-3} \text{ mol}$$

Step 2: Determine the amount of ammonia in the cloudy ammonia solution.

1) Calculate the total moles of HCl originally added to the diluted cloudy ammonia solution.

$$\text{Total number of moles of HCl added} = 0.100 \times 50 \times 10^{-3} = 5 \times 10^{-3} \text{ mol}$$

2) Calculate the moles of HCl that reacted with the ammonia in the diluted

cloudy ammonia solution

$n\text{HCl (titrated)} + n\text{HCl (reacted with NH}_3) = n\text{HCl (total added)}$

$n\text{HCl(reacted with NH}_3) = 5 \times 10^{-3}\text{mol} - 2.150 \times 10^{-3}\text{mol} = 2.85 \times 10^{-3}\text{mol}$

- 3) Write the balanced chemical equation for the reaction between ammonia in the cloudy ammonia solution and the HCl (aq).

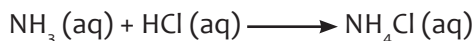

- 4) From the balanced chemical equation, calculate the moles of NH_3 that reacted with HCl. As the mole ratio between $\text{NH}_3 : \text{HCl} = 1:1$

So, 2.85×10^{-3} mol HCl had reacted with 2.85×10^{-3} mol NH_3 in the cloudy ammonia solution.

- 5) Calculate the ammonia concentration in the cloudy ammonia solution.

$$C(\text{NH}_3) = \frac{0.00285\text{mol}}{0.025\text{dm}^3} = 0.114\text{mol dm}^{-3}$$

- 6) The concentration of ammonia in the cloudy ammonia solution was 0.114M.

- 5) Aim: To determine the atomic mass of the element X in the acid XCH_2COOH

Procedure: The following solutions are provided. Solution FA₁ made by dissolving 2.3625g of the acid to make 250cm³ of solution. Solution FA₂ was made by dissolving 1g of sodium hydroxide pellets to make 250cm³ of solution.

Results: 25cm³ portion of FA₁ was titrated with 25.10cm³ FA₂ using methyl orange indicator.

Calculations:

- Calculate the molecular mass of the acid XCH_2COOH
- Hence calculate the atomic weight of the element whose symbol is X.

Theory: The acid XCH_2COOH reacts with sodium hydroxide in a neutralization reaction by the equation.



Answer:

- a) Molarity of FA₁ (Sodium hydroxide) = $\frac{4}{40} = 0.1\text{M}$

Therefore, 1000cm³ of sodium hydroxide solution has 0.1mol

Therefore, 25.1cm³ of sodium hydroxide solution has $= \frac{0.1 \times 25.1}{1000} = 0.00251\text{mol}$

The number of moles of FA₂ which reacted = 0.00251mol, and since the mole ratio of reaction is 1:1 therefore the number of moles of the acid reacted = 0.00251 mol.

25cm³ of FA₁ pipetted contain 0.00251moles

1000cm³ of FA₁ would contain $\frac{0.00251 \times 1000}{25} = 0.1004\text{mol}$

Therefore Molarity of the acid solution = 0.1004mol

Since Molarity = $\frac{\text{concentration in grams per litre of the acid}}{\text{Relative molecular mass of the acid}}$

Relative molecular mass = $\frac{\text{Concentration in grams per litre}}{\text{Molarity}}$

The concentration in g/l of acid = $2.3625 \times 4 = 9.45$

Therefore Relative molecular mass = $\frac{9.45}{0.1004} = 94$

b) Calculate the mass of X

$$X + 24 + 32 + 3 = 94$$

$$X = 94 - 59 = 35$$

X is chlorine

Therefore, the acid is chloroethanoic acid ClCH_2COOH

6. a) Potassium permanganate is widely used reagent in quantitative (Volumetric) analysis.

(i) Explain what is meant by a primary standard.

(ii) State five properties of a primary standard.

(iii) Give two reasons why potassium manganate (VII) is not a primary standard.

(iv) State two advantages of using potassium manganate (VII) as a reagent in volumetric analysis.

(v) Explain why sodium hydroxide and sulphuric acid are not suitable as primary standards.

(vi) Give three examples of primary standards.

b) (i) Write half equation for the reduction of manganate (VII) in acidic solution.

(ii) Explain why hydrochloric acid and nitric acid are not used in titrations involving Manganate (VII) ions.

(iii) Name two substances that can be used to standardize potassium manganate (VII) ions.

c) Write half equations for the oxidation of each of the following by manganate (VII) ion.

(i) Hydrogen peroxide

(ii) Oxalate ion

(iii) Iodide ion

(iv) Sulphite ion

(v) Nitrite ion

(vi) Tin (II) ion.

Answers:

a) (i) This is a solution of a compound whose concentration is known and is used for preparing standard solutions.

(ii) Must be stable in air.

- Readily soluble in a given solvent.
- Should have high molecular mass.
- Should be available in pure form.
- Should give consistent titre values.

(iii)

- Has low solubility in water
- Slowly reduced by water or sunlight to leave brown solid of manganese (IV) Oxide.

(iv)

- It acts as its own indicator.
- A wide range of substances can be oxidized by it.

(v) Sodium hydroxide absorbs moisture from the atmosphere and also reacts with atmospheric carbon dioxide gas. But sulphuric acid is hygroscopic.

(vi)

- Sodium tetraborate (borax)
- Sodium hydrogen carbonate
- Ethanedioic acid (oxalic acid).

b) (i) $\text{MnO}_4^- (\text{aq}) + 8\text{H}^+ (\text{aq}) + 5\text{e}^- \longrightarrow \text{Mn}^{2+} (\text{aq}) + 4\text{H}_2\text{O} (\text{l})$

(ii) Hydrochloric acid is oxidized by the manganate (VII) ions to chlorine gas. Nitric acid is itself a powerful oxidising agent which would compete with the manganate (VII) ion for the reducing agent.

(iii)

- Ammonium iron (II) sulphate
- Ethanedioic acid (oxalic acid)

c) (i) $\text{H}_2\text{O}_2 (\text{aq}) \longrightarrow 2\text{H}^+ (\text{aq}) + \text{O}_2 (\text{g}) + 2\text{e}^-$

(ii) $\text{C}_2\text{O}_4^{2-} (\text{aq}) \longrightarrow 2\text{CO}_2 (\text{g}) + 2\text{e}^-$

(iii) $2\text{I}^- (\text{aq}) \longrightarrow \text{I}_2 (\text{aq}) + 2\text{e}^-$

(iv) $\text{SO}_3^{2-} (\text{aq}) + \text{H}_2\text{O} (\text{l}) \longrightarrow \text{SO}_4^{2-} (\text{aq}) + 2\text{H}^+ (\text{aq}) + 2\text{e}^-$

(v) $\text{NO}_2^- (\text{aq}) + \text{H}_2\text{O} (\text{l}) \longrightarrow \text{NO}_3^- (\text{aq}) + 2\text{H}^+ (\text{aq}) + 2\text{e}^-$

(vi) $\text{Sn}^{2+} (\text{aq}) \longrightarrow \text{Sn}^{4+} (\text{aq}) + 2\text{e}^-$

Note: To obtain overall reaction equation each of the oxidation half equations above is separately combined with the reduction half equation is (b) (i) above.

12.1 Key unit competency:

Explain the effect of different factors to molar conductivity of different electrolytes and the applications of conductivity measurements.

12.2. Prerequisite (knowledge, skills, attitudes and values)

Students will learn better conductivity of solutions if they have understanding on:

- Electricity of senior three.
- Solution and concentration of senior two
- Properties of matter senior one
- Metallic character and mobility of electrons

12. 3. Cross-cutting issues to be addressed

a) Inclusive education:

- This unit involves a number of experiment to be carried out and the which will challenge the students with visual difficulties
- Grouping students. Students with special educational needs are grouped with others and assigned roles basing on individual student's abilities.
- If a teacher has students with visual difficulties, when writing on the blackboard, write in large, clear writing, especially when it comes to formulae. Read out what you are writing, for the benefit of those who are not able to see the blackboard clearly.
- If learners are sharing textbooks, try to arrange for those with visual difficulties to have their own copies, as far as this is possible.
- Give extra time for them to write summary notes or write down observations after experiments.

- Every important point is written and spoken.
- Remember to repeat the main points of the lessons.
- For students with visual impairment teacher can write of them a summary using the braille alphabet if possible.
- For learners with hearing difficulties, the teacher has to encourage them to sit closer to the front of the classroom. Stop every so often while teaching to ask learners whether they have understood, or if they need you to repeat a point. Encourage learners not to be afraid to ask questions. When teaching, speak clearly and ensure that all the learners can hear your voice. Avoid speaking hurriedly as this will make it difficult for learners with hearing difficulties to make sense of what you are saying.

Learners with mobility difficulties:

- These include learners in crutches, wheelchairs, or with walking difficulties. Encourage other learners to look out for and help their classmates. Ask their fellow learners to help them with their notes, if their conditions hinder them from writing well.
- Learners with reading difficulties:
- Learners with this kind of difficulties struggle to make sense of words or understand written work and take longer to read than other learners. Encourage them to pay careful attention during class time and participate for example by asking questions, answering questions, so that they can make the most of what they hear and observe. Instead of repeating word for word what is in the textbook, simplify the concepts to ease their understanding, so that when they have already understood.

b) Gender:

During group activities try to form heterogeneous groups (with boys and girls) or when students start to present their findings encourage both (boys and girls) to present the findings without any segregation of sex

d) Peace and values education:

During group activities, the teacher will encourage learners to help each other and to respect opinions of colleagues.

12.4. Guidance on the introductory activity

- Group the students into groups and select the leader to write the observation;
- Distribute among the students the materials
- Each group will be given the material which are: four (4) beakers, two oranges, 3 lighting bulbs, and two oranges, solutions which are sugar, sodium hydroxide and knives even connecting wires, batteries or dry cells.
- Give them the instruction on how they are going to connect by respecting the demonstration which are on the introductory activity.
- Write down the explanation on different observations they see by carrying out the tasks.
- Give them time to present their findings group by group by answering to the questions related with the introductory activity.
- The teacher summarizes the findings of the students and introduce the unit.

Answers to introductory activity

1. Intensity of lights set up₁ > Intensity of lights set up₂ > Intensity of lights set up₃
2. There is no light in set up₃ because the sugar solution is not electrically conducting solution
3. The main cause of bulbs light in set up₂ is the presence of citric acid which dissociate into negative and positive ions in solution
4. The light in set up₁ is much because NaOH is a strong electrolyte while the citric acid is a weak electrolyte producing less light.

12.5. List of lessons (including assessment).

#	Lesson title	Learning objectives (from the syllabus including knowledge, skills and attitudes):	Number of periods
1	Conductance of electrolytic solutions	Explain the conductivity of solutions.	1
2	Measurement of conductivity of solutions	Use Kohlrausch's law to calculate the molar conductivity of an electrolyte.	1
3	Specific conductivity of solutions	Interpret a graph of molar conductivity against concentration for both weak and strong electrolytes.	1
4	Molar conductivity of solutions	Appreciate the contributions of other scientists like Kohlrausch's law in calculation of molar conductivity of solutions.	1
5	Factors that affect molar conductivity	Explain the factors that affect molar conductivity of solutions.	2
6	Kohlrausch's law of individual molar conductivity	Appreciate the contributions of other Scientists like Kohlrausch's law in calculation of molar conductivity of solutions.	1
7	Relationship between molar conductivity, degree of ionization and ionization constant	Interpret a graph of molar conductivity against concentration for both weak and strong electrolytes.	1

8	Uses of conductivity measurements in titration and solubility product	Interpret a graph of molar conductivity against concentration for both weak and strong electrolytes.	1
9	Difference between metallic and electrolytic conductivity	Compare and contrast metallic conductivity and electrolytic conductivity.	1
10	Summative assessment	Explain the effect of concentration, temperature, viscosity of the solvent, ionic charge and size on the molar conductivity of different electrolytes and the applications of conductivity measurements.	1

12.6. Guidance on different lessons

Lesson 1: Conductance of electrolytic solutions (40 minutes)

This is the first lesson of unit 12 and is a single lesson. That is to say it has only one period (40 minutes). The first lesson also covers the introduction of the whole unit.

a) Prerequisites (10minutes)

Students will learn better conductance and conductivity if they have understanding on: The concept preparation of solution, ionization, dissolution, properties of aqueous solution, movement of electrons.

b) Teaching resources

The materials needed are, appropriate chemicals (ionic compounds like sodium chloride, water, and some non-electrolyte like sugar) and apparatus like beakers conical flask, stillers glace rods electric wires), computers, projectors, internet access

c) Learning activities

Before introducing the lesson, you will have to introduce the whole unit. Let learners therefore attempt activity 12.1 which leads students to the first lesson of the unit.

d) Methodological steps

As a facilitator, the teacher will give the student the materials, books (student books).

Make the groups and in those groups, try to ask the students to select a leader and the secretary to take a summary of their discussion. (While discussing, you will be moving around by observing how the discussion is going on silently you are not allowed to help them but to moderate against the conflicts).

Give them the limited time to discuss on the activity 12.1 located in the student book.

After the time given has finished, tell the groups to present by avoiding repetition of the other group findings.

After presentation the student will evaluate the answers of their colleagues by modifying the answers of other

As teacher, you will add what student didn't discover and hence add summary on the black or white board and the student will take the summary.

Expected answers to the activity 12.1

The people being accidentally electrocuted while taking a bath at home, is due to the electric current which is in the wires, when accidentary the wires are in contact with the water in bathroom and because water contains minerals, that water will conduct electricity because if the presence of mineral salt that are dissolved in, and once someone is taking a bath that water will electrocute him/her due to electrons movement.

Expected answers to checking up 12. 1

1. a) See student book
- b) See student book
- c) See student book

Lesson 2: Measurement of conductivity of solutions (40 minutes)

a) Prerequisites

The students will learn better, Measurement of conductivity of solutions, when they have understanding on measurement of voltage in physics s3, mobility of ions, redox reaction, resistance and resistivity in physics s3

b) Teaching resources

The teacher will need the materials like manila for demonstration, chawks and book, the internet and different books from library, voltmeter, bulb wires, etc..

c) Learning activities:(minutes)

Before introducing the lesson, let learners therefore attempt activity 12.2 which leads students to the second lesson of the unit

d) Methodological step

Make a group of five students for each group, then tell the student to select the leader as well as secretary to present at the end of the activity.

Tell the students discuss seriously the activity 12.2 and present

The group representative will represent and write the findings on the chalkboard or white board,

The teacher will be moving around and control the discipline of the rest of the students.

When all groups are done presenting, the teacher will harmonize the answers and the student will discuss on the answers of their colleagues while harmonizing.

The teacher will enrich the content of the students by adding the content while students will be taking summaries

Expected answers to activity 12.2

1. See student book
2. In order to see that the solution is conducting, the use of bulbs can be used and see the intensity of light, we can use also the voltmeter in order to see the voltage which indicate the quantity of electricity passing through wires or through solution.

Assess the lesson by letting learners to do checking up 1.2

Expected answers to checking up 12. 2

1. See student book
2. See student book

Lesson 3: Specific conductivity of solutions (40 minutes)

a) Prerequisites (10 minutes)

Students will learn better the concept Specific conductivity of solutions when they have knowledge on concept of conductivity, resistance and resistivity.

b) Teaching resources

The same as above.

c) Learning activities

This is the time for introducing the lesson three, before introducing it, let learners therefore attempt activity 12.3 which leads to the third lesson of the unit.

d) Methodological step 1.4:

- Divide your class into groups, and let students follow the working procedures to obtain the results.
- Let the learner(s) perform the activity using their prior knowledge to carry out the activity 12.3
- Have sample group present their work to the class.
- Check student's responses to review the students' plans and ideas to continue the discussion with a brief brainstorming of the concepts using student's work and book
- Comment on students' responses written in their notebooks, and give them the summary of expected feedback based on their findings.

Expected answers to the activity 12.3

See student book

Expected answers to checking up12.3

see student book

Lesson 4: Molar conductivity of solutions (40Minutes)

a) Prerequisites (10 minutes)

Students will learn better the concept Molar conductivity of solutions when they have knowledge on concept of solution and concentration, mobility of ions, weak and strong electrolyte and effect of adding water to weak electrolyte

b) Teaching resources

The same as above.

c) Learning activities

This is the time for introducing the lesson three, before introducing it, let learners therefore attempt activity 12.4 which leads to the third lesson of the unit.

d) Methodological guidance

- Divide your class into groups, and let students follow the working procedures to obtain the results.
- Let the learner(s) perform the activity using their prior knowledge to carry out the activity 12.4
- Have sample group present their work to the class.
- Check student's responses to review the students' plans and ideas to continue the discussion with a brief brainstorming of the concepts using student's work and book.
- Comment on students' responses written in their notebooks, and give them the summary of expected feedback based on their findings.

Test the students by giving them to the checking up 12.4

Expected answers to activity 12.4

As the concentration increases, the intensity of light decreases, and as the dilution increases, the ions become more free and hence they are more conductor of electricity and the intensity of bulb increases by dilution and decrease by concentration

Expected answers to checking up 12.4.

1. Solution

$$\Lambda_m = \frac{\kappa}{C} \Rightarrow \kappa = \Lambda_m C = (0.1 \times 10^3 \text{ mol.m}^{-3})(106.7 \times 10^{-4} \text{ Sm}^2 \text{ mol}^{-1}) = 1.067 \text{ Sm}^{-1} = 106.7 \text{ SCm}^{-1}$$

$$R = \frac{1}{\kappa} \frac{l}{A} = \frac{(0.1 \text{ m})}{(1.067 \text{ Sm}^{-1})(2 \times 10^{-4} \text{ m}^2)} = 468.6 \Omega$$

$$\text{Hence, } I = \frac{E}{R} = \frac{50}{468.6} \text{ A} = 0.1067 \text{ A}$$

2. Solution

i)

$$\Lambda_m = \frac{\kappa}{C} \Rightarrow \kappa = \Lambda_m C = (0.1 \times 10^3 \text{ mol.m}^{-3})(106.7 \times 10^{-4} \text{ Sm}^2 \text{ mol}^{-1}) = 1.067 \text{ Sm}^{-1} = 106.7 \text{ SCm}^{-1}$$

$$R = \frac{l}{\kappa A} = \frac{(0.1 \text{ m})}{(1.067 \text{ Sm}^{-1})(2 \times 10^{-4} \text{ m}^2)} = 468.6 \Omega$$

$$\text{Hence, } I = \frac{E}{R} = \frac{50}{468.6} \text{ A} = 0.1067 \text{ A}$$

Since, $\kappa = 0.1413 \text{ Sm}^{-1}$; $R = 94.3 \Omega$

$$\kappa = \frac{1}{R} \left(\frac{l}{A} \right) \Rightarrow \left(\frac{l}{A} \right) = \kappa R = (0.1413 \text{ Sm}^{-1})(94.3 \Omega) = 13.32 \text{ m}^{-1}$$

$$(ii) \kappa = \frac{1}{R} \left(\frac{l}{A} \right) = \frac{(13.32 \text{ m}^{-1})}{(59.3 \Omega)} = 0.2648 \text{ Sm}^{-1}$$

$$\text{The molar conductance, } \Lambda_m = \frac{\kappa}{C} = \frac{0.2648 \text{ Sm}^{-1}}{0.02 \text{ mol} \times 1000 \text{ m}^{-3}} = 0.01324 \text{ Sm}^2 \text{ mol}^{-1}$$

Lesson 5: Factors that affect molar conductivity (80Min)

a) Prerequisites (20 minutes)

Students will learn better the factors that affect molar conductivity when they have knowledge on concept of solution and concentration, mobility of ions, weak and strong electrolyte and effect of adding water to weak electrolyte, factors influencing the

b) Teaching resources

The same as above.

c) Learning activities

This is the time for introducing the lesson three, before introducing it, let learners therefore attempt activity 12.5 which leads to the 5th lesson of the unit.

d) Methodological guidance

- Divide your class into groups, and let students follow the working procedures to obtain the results.
- Let the learner(s) perform the activity using their prior knowledge to carry out the activity 12.5

- Have sample group present their work to the class.
- Give time to harmonize the answers from different groups by modifying some of them
- The teacher will be moving around while the students are helping each other in discussion and the teacher still will be helping the students
- The teacher will write the summary after addition of additional content.

Expected answers to activity 12.5.

The solution is affected by some factors like: temperature, pressure nature of solvent, type of solute,...and those help in migration of ions and the degree of making them free increase as the those factors increases.

Those factors are linked with conductivity in the degree of freedom of ions, when the ions are free the conductivity increase. Especially for weak electrolyte as the dilution increase the ions become freer to move by increasing the conductivity of solutions.

Answers to checking up 12.5: See student book

Lesson 6: Kohlrausch's law of individual molar conductivity. (40minutes)

a) Prerequisites (20 minutes)

Students will learn better the Kohlrausch's law of individual molar conductivity, when they have knowledge on concept of solution and concentration, mobility of ions, weak and strong electrolyte and effect of adding water to weak electrolyte, factors influencing the

b) Teaching resources

The same as above.

c) Learning activities

This is the time for introducing the lesson three, before introducing it, let learners therefore attempt activity 12.6 which leads to the 6th lesson of the unit.

d) Methodological guidance

- Divide your class into groups, and let students follow the working procedures to obtain the results.
- Let the learner(s) perform the activity using their prior knowledge to carry out the activity 12.6
- Have sample group present their work to the class.

- Give time to harmonize the answers from different groups by modifying some of them
- The teacher will be moving around while the students are helping each other in discussion and the teacher still will be helping the students
- The teacher will write the summary after addition of additional content.

Expected answers to activity 12.6

All substances don't conduct electricity at the same level because the degree or mobility of the ions are not the same.

Examples sodium chloride which is a strong electrolyte cannot conduct electricity in the same way as ethanoic acid which is weak electrolyte and partially ionized.

Expected answers to checking up 12.6

See student book

e) Expected answers to activity 12.6.1

see student book

Lesson7: Relationship between molar conductivity, degree of ionization and ionization constant (40 Minutes)

a) Prerequisites (20 minutes)

Students will learn better the Relationship between molar conductivity, degree of ionization and ionization constant, when they have knowledge on concept of solution and concentration, mobility of ions, weak and strong electrolyte and effect of adding water to weak electrolyte,

b) Teaching resources

The same as above.

c) Learning activities

This is the time for introducing the lesson three, before introducing it, let learners therefore attempt activity 12.7 which leads to the 7th lesson of the unit.

d) Methodological guidance

The lesson will be conducted as said above

Activity 12.7

1. The degree of dissociation α (sometimes also degree of ionization), is a way of representing the strength a substance. It is defined as the ratio of the number of ionized molecules and the number of molecules dissolved in water. Is the degree at how a given substance make free its ions
2. Dissociation occurs when two or more ionic species separate from one another (such as occurs during dissolution of an ionic solid) but that the formation of one or more ions is properly an ionization process. Thus, sodium chloride solid dissociates in water whereas hydrogen chloride gas ionizes in water as the former already has an ionic structure whereas the latter is a molecular substance with a covalent bond between the hydrogen and chlorine atoms and the gas does not consist of ions:

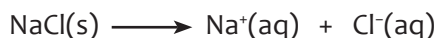

From this perspective, K_a is actually an acid ionization constant and not an acid dissociation constant, but for most practical purposes, the terms are used interchangeably.

3. The Ionization constant is calculated as:



$$K_a = \frac{[\text{A}^{\text{+}}][\text{B}^{\text{-}}]}{[\text{AB}]}$$

4. As the ions are free to move, the conductivity also increases, this means that there is a relation between the conductivity and the ionization constant.

Expected answers to checking up 12.7

$$\kappa = \frac{1}{R}(\text{Cell constant}) = \frac{0.2063\text{Cm}^{-1}}{888\Omega} = 2.324 \times 10^{-2} \text{Sm}^{-1}$$

$$\Lambda_m = \frac{\kappa}{C} = \frac{2.324 \times 10^{-2} \text{Sm}^{-1}}{0.02 \times 1000 \text{mol.m}^{-3}} = 1.162 \times 10^{-3} \text{Sm}^2 \text{mol}^{-1}$$

$$pK_a = -\log K_a = -\log(1.86 \times 10^{-5}) = 4.73$$

Thus, organic acid is weak $pH = \frac{1}{2} pKa - \frac{1}{2} \log C_{acid} = \frac{1}{2} 4.73 - \frac{1}{2} \log 0.02 = 3.2$

Lesson 8: Uses of conductivity measurements in titration and solubility product (40minutes)

a) Prerequisites (20 minutes)

Students will learn better the Uses of conductivity measurements in titration and solubility product, when they have knowledge on concept of solution and concentration, mobility of ions, weak and strong electrolyte and effect of adding water to weak electrolyte,

b) Teaching resources

The same as above.

c) Learning activities

This is the time for introducing the lesson three, before introducing it, let learners therefore attempt activity 12.8 which leads to the lesson8 of the unit.

d) Methodological guidance

The lesson will be conducted as said above

Activity 12.8

See student book

Expected answers to checking up 12.8

In the beaker A, the intensity of light was high because HCl is a strong electrolyte and it ionizes completely in solution producing H^+ and Cl^-

In a beaker B, there was no light because; ethanol in pure form is non-electrolyte

Using a plastic bag, there was no light because it cannot conduct electricity instead it is an insulator.

Using the copper wire, there was light because copper itself is a conductor.

Lesson 9: Difference between metallic conductivity and electrolytic

conductivity (40minutes)

a) Prerequisites (20 minutes)

Students will learn better Difference between metallic conductivity and electrolytic conductivity when they have knowledge on concept of solution and concentration, mobility of ions, weak and strong electrolyte

b) Teaching resources

The same as above.

c) Learning activities

This is the time for introducing the lesson three, before introducing it, let learners therefore attempt activity 12.8 which leads to the lesson8 of the unit.

End unit summary

Measurement of conductance of electrolytic solutions were among the first to be used for determining solubility products, dissociation constants and other properties of electrolyte solutions.

Conductance is an important additional property of solution depending on the total number of ions present in it. Many physical and chemical phenomena result in conductivity variations. Conductivity measurements are therefore used widely in research and laboratory analysis and in industrial environments.

(ii) To determine the end points in the conductometric titrations. High frequency conductometric titration, a recent technique to determine the conductance and dielectric constant of solution without the introduction of electrodes in direct contact with solution is also developed.

Electric charges are displaced from one position to another, this movement of electric charges is due to the displacement of ions in solution or in molten state.

Conductivity is the inverse of resistivity, which is the ability to conduct electric charges

Conductance is inverse of resistance it is defines as the property of the materials to allow the movement of electric charges to pass through it.

Molar conductivity depends on concentration of ions present in that solution, the charges in conductivity depends on the mobility of ions that are present in solution, and khaurash's relation explains how the ions are able to conduct electricity.

Dilution increase the conductivity in weak electrolyte because it makes the increase in ions of non-dissociated electrolyte.

The conductivity is influenced by many factors such as temperature, concentration, nature of electrolyte ionic charge and size.

Electric charges are conducted by ions in a solution where as it is conducted by free electrons in metals.

12.7. End unity assessment answers

1.

(a) see student book

(b) see student book

c) see student book

2.

Λ_0 of HCl = 426,

Λ_0 of CH_3COOH = 91

Λ_0 of NaCl = 126

Known that Λ_0 of HCl = $\Lambda_0 \text{H}^+ + \Lambda_0 \text{Cl}^-$ (i)

Λ_0 of CH_3COONa = $\Lambda_0 \text{CH}_3\text{COO}^- + \Lambda_0 \text{Na}^+$ (ii)

Λ_0 of NaCl = $\Lambda_0 \text{Na}^+ + \Lambda_0 \text{Cl}^-$ (iii)

Λ_0 of CH_3COOH = $\Lambda_0 \text{CH}_3\text{COO}^- + \Lambda_0 \text{H}^+$ (iv)

In order to get Λ_0 of CH_3COONa it is to (i) + (ii) - (iii)

$(\Lambda_0 \text{H}^+ + \Lambda_0 \text{Cl}^- + \Lambda_0 \text{CH}_3\text{COO}^- + \Lambda_0 \text{Na}^+) - (\Lambda_0 \text{Na}^+ + \Lambda_0 \text{Cl}^-)$

$\Lambda_0 \text{H}^+ + \Lambda_0 \text{Cl}^- + \Lambda_0 \text{CH}_3\text{COO}^- + \Lambda_0 \text{Na}^+ - \Lambda_0 \text{Na}^+ - \Lambda_0 \text{Cl}^-$

$\Lambda_0 \text{CH}_3\text{COO}^- + \Lambda_0 \text{H}^+ = 426 + 91 - 126 = 390 \Omega^{-1}\text{cm}^2\text{mol}^{-1}$

3. The electrolyte which dissociate either completely or partially they conduct electricity.

4.

(i) Electrolytic conductivity is the conductance of a solution placed between electrode 1 Cm² in area and which are 1 Cm a part

Electrolytic conductivity $K = 1/L/A$

(ii) Molar conductivity is the conductance of a volume of a solution containing one mole of a solute when the solution is placed between two electrodes separated by distance of 1cm

$$b) L = \frac{1}{R} = Kx \frac{A}{l}$$

$$\text{i.e } \frac{1}{R} = Kx \frac{A}{l}$$

Therefore, $K = \frac{1}{R} \times \frac{l}{A} \quad \frac{1}{A}$; cell constant, 1.5m⁻¹

$$K = \frac{1}{0.357} \times 1.5 = 4.202 \Omega^{-1} \text{m}^{-1}$$

$$\text{From } \Lambda = \frac{K}{C}, \quad K = 4.202 \Omega^{-1} \text{m}^{-1}$$

$$C = 0.02 \text{mol dm}^{-3} = 20 \text{m}^3$$

$$\text{Therefore } \Lambda = \frac{K}{C} = \frac{4.202}{20} = 0.21 \Omega^{-1} \text{m}^{-1} \text{mol}^{-1}$$

C) (i) Sodium chloride is strong electrolyte

The factors are

- Concentration: electrolytic conductivity decreases with increase in concentration. This is because at high concentration ionic interference is high.
- Temperature: electrolytic conductivity increases with increase in temperature. This is because as temperature increases, the viscosity of water decreases and hence ions are able to move more freely

(ii) Weak electrolyte are only slightly ionized in solution. The effect of temperature on the electrolytic conductivity of a weak electrolyte depends on the heat change accompanying the ionization process. For weak electrolytes, which ionize with evolution of heat energy.

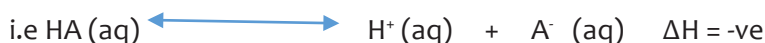

Increase in temperature favors the backward reaction so that because of few ions present conductivity decrease. Lowering temperature would favours the

backward reaction which result in more ions formed and thus conductivity increases. For weak electrolytes which ionize with absorption of heat energy

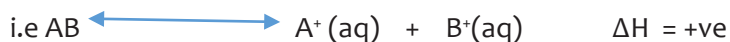

Increasing temperature favour the forward reaction in accordance with Lechatelier's principal. Because the increase number of conducting ions, conductivity increases. Lowering of temperature would favour the backward reaction and consequently conductivity would decrease.

5. The molar conductivity of hydrochloric acid increases with dilution. This is because of the decrease in ionic interference as the ions become far apart from one another Λ_0

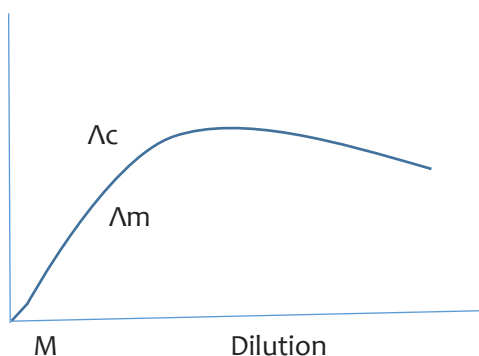

The molar conductivity of HCl at infinite dilution Λ_0 can be obtained by extrapolating the graphs to cut the Y axis as shown above

The molar conductivity ration (apparent degree of ionization) α at any particular concentration eg can be obtained by expressing the molar conductivity at that concentration Λ_m as fraction of the molar conductivity at infinite dilution

(iii)

$$\text{i.e } \alpha = \frac{\Lambda_m}{\Lambda_0}$$

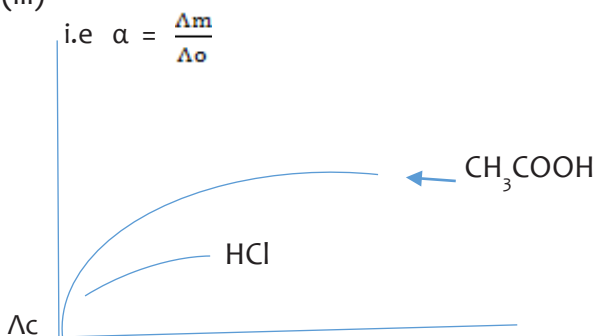

The molar conductivity of ethanoic acid (weak electrolyte) increase with dilution this is because increased the degree of dissociation and this results in increase in the number of conducting ions



By increasing dilution, the above equilibrium reaction, in effect of concentration water, will be increasing so that in order the equilibrium is maintained the excess of water being added reacts with the CH_3COOH to produce more ions hence the increase in conductivity. The conductivity of a weak electrolyte depend on the number of ions present in the solution, the greater number of ions are present, the greater the conductivity.

b) To obtain the square root of concentration given

Molar conductivity	238	230	224	217	210	202
Square root of concentration	0.1	0.2	0.3	0.4	0.5	0.5

The graph is given as follow

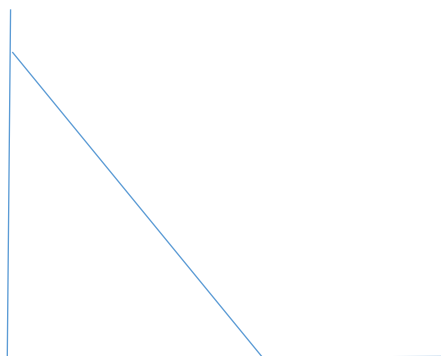

The molar conductivity of sodium hydroxide (strong electrolyte) decrease with increase in concentration. This is because at higher concentration, the ions become very near one another and as results an attraction by one ion for another ion of opposite charge which result in the formation of an ion atmosphere. This atmosphere act as drag upon the ion and thus reduces its velocity and conductivity.

(ii) The value of molar conductivity at infinite dilution (tends to zero) dilution is obtained by extrapolating the graph to cut the y- axis. The value of Λ_0 on the Y axis is taken as the molar conductivity at infinite dilution. That value is 245

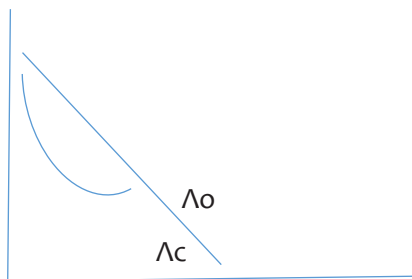

The molar conductivity of ethanoic acid decrease with the increase in concentration because as the concentration increase, the degree of ionization of the acid decrease and therefore, resulting in decrease in the number of ions conducting

(d) The two factors that affect molar conductivity of sodium hydroxide are:

- The speed at which the ions move toward electrodes, the greater the speed, the higher will be the molar conductivity
- The concentration of ions, the more the concentration of ions, the more closely are the ions to one another. This result in attraction by one ion for the other ions of opposite charge resulting in the formation of an ion atmosphere which decreases the velocity of movement of the ions hence decrease in conductivity.

e) both Li^+ and Cs^+ have similar charge but Li^+ is smaller than Cs^+ because of its small size, Li^+ has a greater charge density than Cs^+ and therefore, in water attracts a large shell of water molecule around Li^+ makes it heavier and thus decreases its speed of movement towards the electrodes resulting in the decrease in its conductivity. Because Cs^+ has smaller charge density it is less fat in water and thus is faster and hence more conducting than Li^+

6.

The law states that: the molar conductivity at infinite dilution of a given electrolyte is equal to the sum of molar conductivities of the ions of the electrolyte at infinite dilution of the ions produced by the electrolyte

In determining the conductivity of the molar conductivity of any weak electrolyte, the molar conductivity at infinite dilution of the ions produced by the electrodes strong electrolyte must be known

In determining the molar conductivity of ethanoic acid the molar conductivities at infinite dilution of HNO_3 , NaNO_3 and CH_3COONa must be known

The calculation of CH_3COOH is then calculated by using the relation

$$\Lambda_0 \text{CH}_3\text{COOH} = \Lambda_0 \text{CH}_3\text{COONa} + \Lambda_0 \text{HNO}_3 - \Lambda_0 \text{NaNO}_3$$

The molar conductivity of $\text{CH}_3\text{CH}_2\text{COOH}$ at infinite dilution is obtained from the relationship

$$\begin{aligned}\Lambda_{\alpha} \text{CH}_3\text{CH}_2\text{COOH} &= \Lambda_{\alpha} \text{CH}_3\text{CH}_2\text{COONa} + \Lambda_{\alpha} \text{HNO}_3 - \Lambda_{\alpha} \text{NaNO}_3 \\ &= 87 + 413 - 108 \\ &= 392 \Omega^{-1}\text{cm}^2\text{mol}^{-1}\end{aligned}$$

7. (a) dissociation is the separation completely into ions by electrolyte



(b) The molar conductivity of methyl amine (weak electrolyte) is calculated from the relationship

$$\begin{aligned}\Lambda_{\alpha} \text{CH}_3\text{NH}_3\text{OH} &= \Lambda_{\alpha} \text{CH}_3\text{NH}_3\text{Cl} + \Lambda_{\alpha} \text{Sr}(\text{OH})_2 - \Lambda_{\alpha} \text{SrCl}_2 \\ &117.3 + 228.6 - 189.2 \\ &= 156.7 \Omega^{-1}\text{cm}^2\text{mol}^{-1}\end{aligned}$$

Therefore degree of ionization, α of methylamine

$$\alpha = \frac{\text{molar conductivity at 0.001}}{\text{molar conductivity at infinite dilution}}$$

$$\alpha = \frac{\Delta c}{\Delta \alpha} = \frac{94.8}{156.7} = 0.605$$

8. Conductimetric titration is the titration performed by measuring the change in the conductivity of the solution whereby at the end point there is a sharp change in the conductivity.

(i)

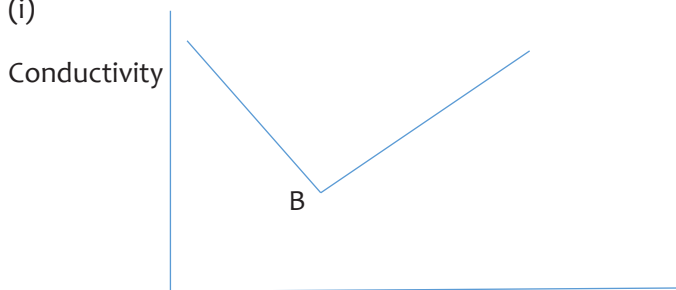

Volume of NaOH

TREND: conductivity initially decreases along AB and then increases along BC

Explanation:

The decrease in conductivity along AB is due to the removal of the fast mobile H^+ of HCl which is being replaced by the less mobile Na^+ in the reaction

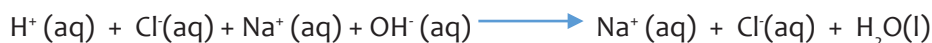

The increase in conductivity along BC is due to the mobile ion OH^- of the excess sodium hydroxide added after the end point B

ii)

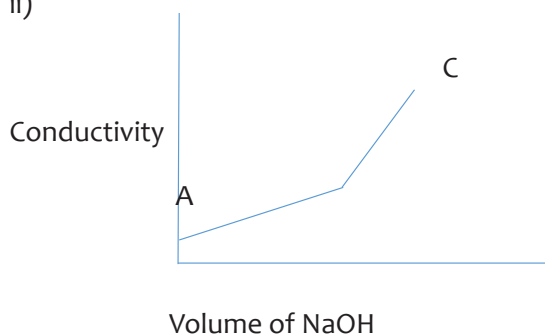

Trends: conductivity gently increases along AB and then sharp increase along BC

Explanation: conductivity gently increases along AB owing to the formation of sodium ethanoate salt by the reaction

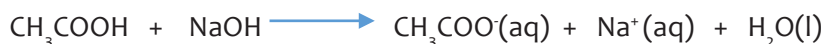

The sharp rise in conductivity along BC is due to OH^- from the excess NaOH added after the end point B

iii) A

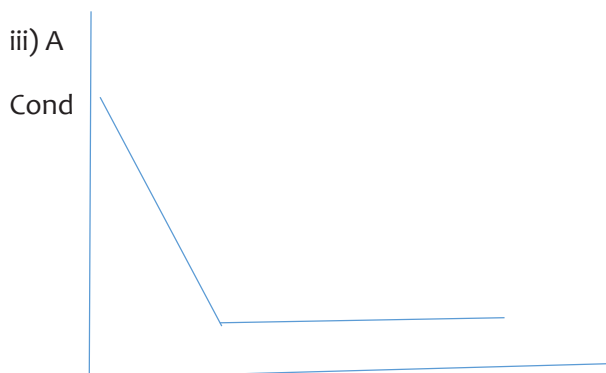

B

C

Conductivity initially decrease along AB and then almost remain s constant along BC

Explanation: the decrease in conductivity along AB due to the removal of the fast mobile H^+ of the HCl and which are replaced by less mobile NH_4^+ of a weak base in the reaction

The most constant conductivity along BC is due to the suppression of the ionization of the excess the excess weak NH_4OH by NH_4^+ from NH_4Cl formed in the reaction above.

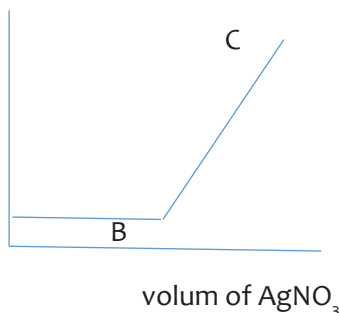

Trend: conductivity moreless remains constant along AB and then rises sharply along BC

Explanation The moreless constant conductivity along AB is because as many more ions are formed a similar number is removed as a precipitate in reaction.



$AgCl$ are removed as precipitate while $NaNO_3$ is formed as a solution. The increase in conductivity after the end point B along the BC is due to the excess of silver nitrate added.

c) Electrolytic conductivity of silver chloride solution alone

$$= K_{\text{solution}} - K_{\text{water}}$$

$$6.43 \times 10^{-5} - 3.82 = 2.61 \times 10^{-5}$$

$$\Lambda_0 = \frac{K}{C} = \frac{K'}{C'}$$

Where C = S Concentration of $AgCl$ in the saturated solution.

$$S = K = \frac{2.61 \times 10^{-5}}{5.33 \times 10^{-1}} \Omega^{-1} \text{cm}^{-1}$$

$$= 4.897 \times 10^{-5}$$

Therefore 1cm³ of the saturated solution contains 4.897x10⁻⁵mol of AgCl

$$\text{But } 1\text{dm}^3 = 1000\text{cm}^3$$

Therefore, cm³ of the saturated solution contains 4.897x10⁻⁵x1000

$$= 4.897 \times 10^{-2}$$

The concentration of AgCl in the saturated solution in gram per liter is

$$4.897 \times 10^{-2} \times 143.5\text{g/mol}$$

$$7.03\text{g dm}^{-3}$$

12.8. Additional content

Conductivity is an important measurement for many applications. When done properly it is a quick and easy way to measure the purity of water. However, there are some key ideas that must be understood before starting to make conductivity measurements.

To start there are three important definitions:

- **Electrical current** is the movement of charged particles (measured in Amps, A).
- **Conductance** is a measure of how easily those charge particles move through a solution/material (measured in Siemens, S).
- **Conductivity** is the conductance (S) measured across a specified distance through a material/solution (measured in Siemens per centimetre, S/cm)

In a metal wire it is electrons that are the charged particles moving through the material, in a solution it is ions. Examples of these ions are shown down.

- **Nature of the ions:** charge, size and mobility
- **Nature of the solvent:** dielectric constant and viscosity
- **Concentration of ions:** the more ions the greater the conductivity and so conductivity can be used as a measure of concentration.
- **Temperature**

In general the more ions present in a solution the greater the conductivity; however, not all additions to aqueous solutions reliably form ions (e.g. sugar and alcohol). Further,

conductivity only increases with concentration up to a maximum value, after which, the conductivity may actually decrease with increasing concentration.

The stability and purity of the sample, and how it is handled, can affect the accuracy of the sample reading. Low-level samples can be easily effected by contamination, CO₂ absorption, and degassing.

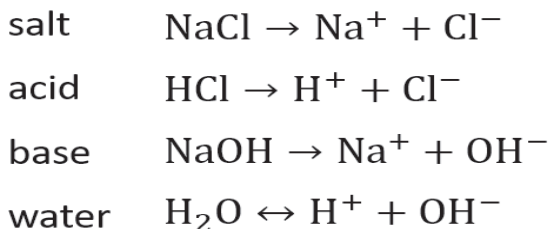

Figure 1: Formation of ions in solution

Resistivity

For some solutions, such as pure water, the conductivity is so low that it is sometimes easier to use resistivity and resistance as the measure.

- Resistance is a measurement of a material or solutions opposition to the flow of a current (measured in Ohms (Ω)). This is the reciprocal of conductance.
- Resistivity is the resistance measured across a specified distance (measured in Siemens per centimetre (Ωcm)). This is the reciprocal of conductivity.

See Figure 2 for comparison of conductivity and resistivity. These values range from ultra clean water with a conductivity of 0.055 $\mu\text{S}/\text{cm}$ nitric acid with a conductivity of 861,000

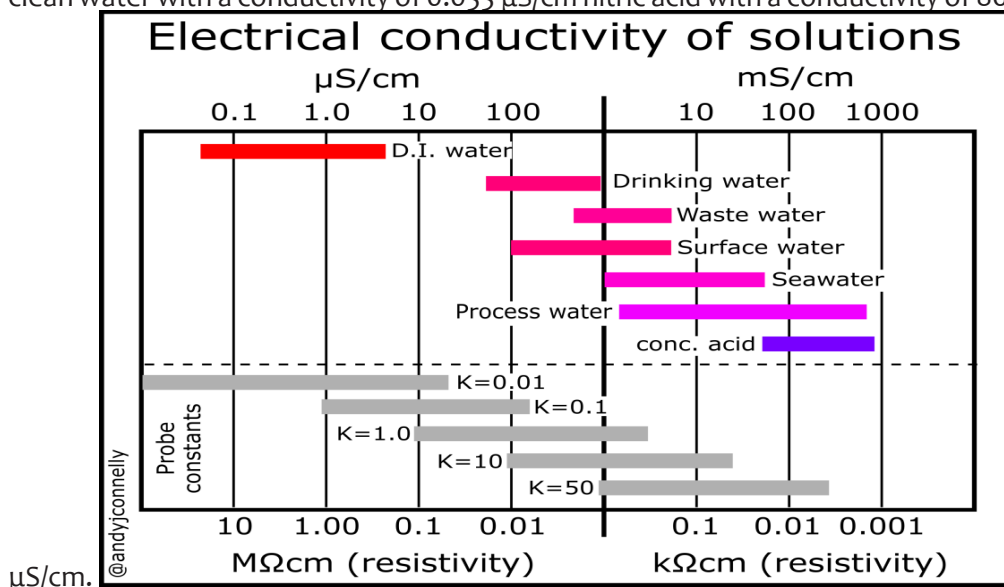

Conductivity ranges of probe constants will vary between manufactures and probe types.

Concentration and Total dissolved Solids

The relationship between conductivity and the number of ions in solution means that it can be used to measure solution concentration and give a value for Total Dissolved Solids. However, conductivity is non-specific; all ions contribute to the electrolytic conductivity of the solution and one set of ions cannot be distinguished from another. This means that measurements are of the total concentration of ions in solution not the concentration of any one ion.

- **Concentration:** Some species ionize more completely in water (e.g. NaCl & HCl) than others do. This means that their solutions are more conductive as a result. Each acid, base, or salt has its own characteristic curve for concentration vs. conductivity. A calibration is required with solutions of known composition and concentration.
- **TDS:** There are lots of assumptions when calculating a TDS value from a conductivity value. In general, a conversion factor is used which will vary depending on the nature of the solution. These conversion factors can be calibrated, usually using NaCl solutions. If a NaCl solution is used that makes the assumption that the main ions present are Na⁺ and Cl⁻ for more information.

Conductivity and temperature

Conductivity increases with temperature. This increase is significant, between 1.5 and 5.0% per °C. So, if you measure the same solution at different temperatures you will get a different conductivity unless a temperature correction is used. For this reason, conductivity readings must be temperature compensated.

Temperature compensation is generally carried out by adjusting the readings to a reference temperature, typically 25°C. Conductivity probes should have an integrated temperature sensor to aid this compensation.

There are two main temperature correction algorithms in common use:

- **Linear temperature coefficient: used in most applications**
- **Non-linear temperature coefficient: used when measuring low conductivity water**

Neither of these are perfect, and so ideally all your solutions would be measured at the same, reference temperature. However, that is clearly not always possible. Errors in temperature measurement will also contribute to issues in compensation and so it is

vital to let your conductivity probe and solution come into thermal equilibrium.

Temperature coefficient

The change in conductivity with temperature is expressed as the change in conductivity (as a percentage) per degree Celsius. This is generally referred to as the temperature coefficient (α). The value of α varies depending on solution, solution concentration, and temperature.

1. Check the conductivity of a representative sample at a reference temperature (generally 25°C). This temperature is generally the temperature your calibration standard is quoted at.
2. Using the same sample, find the conductivity at another temperature. Generally this is the temperature you will be measuring other samples at.
3. Calculate the percent change per °C
4. Enter this value into the settings of the meter.

Measuring conductivity

Measuring conductivity can be achieved in a variety of ways. The most common method is using a conductivity probe as seen in Figure 1. These use two or more platinum electrodes and measure the conductivity directly.

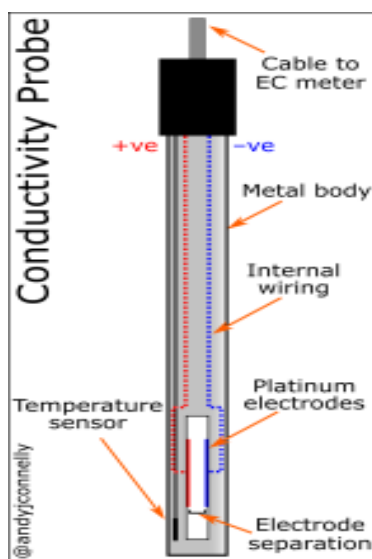

Figure 2: Conductivity probe diagram.

The other main method used for measuring conductivity is the toroidal “inductive” method. More information can be found on this in references.

In the simplest arrangement of a platinum electrode type probe (a 2-electrode cell), a

voltage is applied to two flat plates immersed in the solution, and the resulting current is measured and then conductivity, G , can then be calculated using inverted Ohm's law. Where R is the resistance,

V = voltage and I = current:

$$R = \frac{V}{I} \quad \text{and} \quad G = \frac{1}{R}$$

In principle a DC voltage could be used. However, a DC voltage would soon deplete the ions near the plates, causing polarization, and a higher than actual resistance to be measured. As such, an AC voltage is generally used to avoid this problem for more details).

A more advanced conductivity cell uses four electrodes). These probes use an alternating current through the outer electrodes and measures the voltage across the inner electrode. The four electrode system gives a lower current and so has less charge transfer at the metal-liquid interface. This allows a much wider dynamic range to be measured than a two-electrode sensor. Such measurements are volume dependent and the outer sheath of the probe ensures that the volume of sample solution remains constant for all analysis.

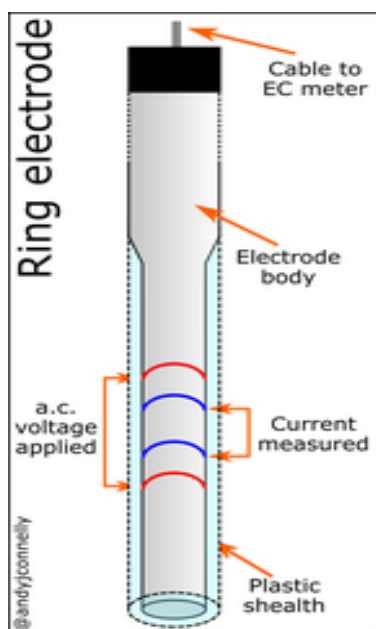

Figure 2: Diagram of conductivity probe with 4 electrodes.

The above shows the setup of a basic conductivity probe with two square platinum electrodes. The specific design of the probe will vary depending on the range of conductivities to be measured. The area of the electrodes and the distance between them defines this range. These values are encapsulated in the Cell Constant, K .

The conductivity, C , between electrodes is given by the expression:

$$C = G \frac{d}{A}$$

C = conductivity (S/cm), G = conductance (S), d = distance between electrodes (cm), and A = plate area of electrodes (cm²)

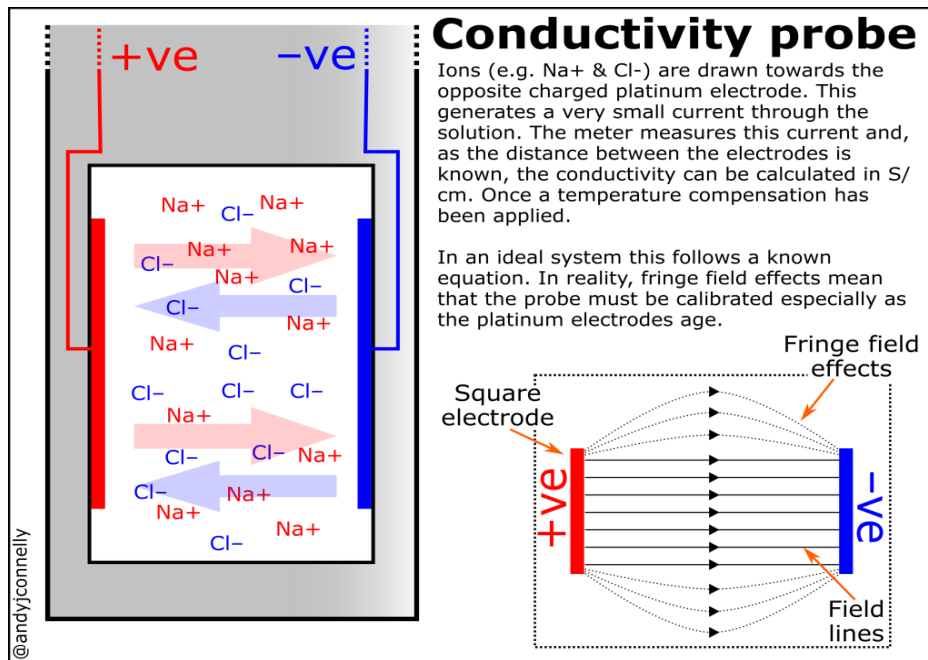

12.8. Additional activities

a) Remedial activities

Question 1

- What are conductors and non-conductors?
- Define the terms conductance, electrolytes and non-electrolytes.

Answers

- Substances which allow the passage of electricity through them are called *conductors*. On the other hand, the substances which do not allow the passage of electricity through them are called *insulators* or *non-conductors*.
- Conductance is a measure of the ease with which current flows through the conductor. It can be defined as the inverse of resistance, R . It is denoted by G . $G = 1/R$

- Electrolytes are substances that are decomposed by electricity when passed through them and conduct electricity afterwards.
- Non-electrolytes are non-conductors of electricity and are not decomposed by electricity.

Question 2

- Define electrolytic conductance
- What are the factors affecting electrolytic conduction?
- Define molar conductivity of an electrolyte.

Answers

- The conductance of electricity by ions present in the solutions is called electrolytic or ionic conductance.
- The ionic interaction.
 - The solvation of ions.
 - Nature of electrolyte and the solvent.
 - Viscosity of the solvent.
 - Temperature.
- Molar conductivity is defined as the conductance of a solution containing 1 molar equivalent of the electrolyte such that the entire solution is placed between two electrodes one centimetre apart. OR Molar conductivity of a solution at a given concentration is the conductance of the volume V of solution containing one mole of electrolyte kept between two electrodes with area of cross section A and distance of unit length.

Question 3

- Write an equation to relate Molar and electrolytic conductivities of a solution.
- Draw sketch-graphs to show how molar conductivities of the following vary with concentration (i) a strong electrolyte (ii) a weak electrolyte.

Answers

- $\Lambda_m = \kappa/C = \kappa V$ where Λ_m is molar conductivity, κ is the electrolytic conductivity, C is concentration of a solution and V is dilution.

b) Consolidation activities

Question 1

Resistance of a conductivity cell filled with 0.1 mol L^{-1} KCl solution is 100Ω . If the resistance of the same cell when filled with 0.02 mol L^{-1} KCl solution is 520Ω , calculate the conductivity and molar conductivity of 0.02 mol L^{-1} KCl solution. The conductivity of 0.1 mol L^{-1} KCl solution is 1.29 S/m .

Answers

The cell constant is given by the equation:

Cell constant = G^* = conductivity X resistance

$$= 1.29 \text{ S/m} \times 100\Omega = 129 \text{ m}^{-1} = 1.29 \text{ cm}^{-1}$$

Conductivity of 0.02 mol L^{-1} KCl solution = cell constant / resistance

$$= G^*/R = 129 \text{ m}^{-1} / 520\Omega = 0.248 \text{ S m}^{-1}$$

Concentration = 0.02 mol L^{-1}

$$= 1000 \times 0.02 \text{ mol m}^{-3}$$

$$= 20 \text{ mol m}^{-3}$$

Molar conductivity = $\Lambda m = \kappa/c$

$$= 248 \times 10^{-3} \text{ S m}^{-1} / 20 \text{ mol m}^{-3}$$

$$= 124 \times 10^{-4} \text{ S m}^2 \text{ mol}^{-1}$$

Alternatively, $\kappa = 1.29 \text{ cm}^{-1} / 520 \Omega$

$$= 0.248 \times 10^{-2} \text{ S cm}^{-1}$$

and $\Lambda m = \kappa \times 1000 \text{ cm}^3 \text{ L}^{-1} \text{ molarity}^{-1}$

$$= 0.248 \times 10^{-2} \text{ S cm}^{-1} \times 1000 \text{ cm}^3 \text{ L}^{-1} / 0.02 \text{ mol L}^{-1}$$

$$= 124 \text{ S cm}^2 \text{ mol}^{-1}$$

Question 2

The electrical resistance of a column of 0.05 mol L^{-1} NaOH solution of diameter 1 cm and length

50 cm is $5.55 \times 10^3 \text{ ohm}$. Calculate its resistivity, conductivity and molar conductivity.

Answers

$$A = \pi r^2 = 3.14 \times 0.52 \text{ cm}^2 = 0.785 \text{ cm}^2 = 0.785 \times 10^{-4} \text{ m}^2$$

$$l = 50 \text{ cm} = 0.5 \text{ m}$$

$$R = \rho l / A \text{ or } \rho = RA / l = 5.55 \times 10^3 \rho \times 0.785 \text{ cm}^2 / 50 \text{ cm} = 87.135 \rho \text{ cm}$$

$$\text{Conductivity} = \kappa = 1/\rho = (1/87.135) \text{ S cm}^{-1}$$

$$= 0.01148 \text{ S cm}^{-1}$$

$$\text{Molar conductivity, } \Lambda_m = (\kappa \times 1000) / c \text{ cm}^3 \text{ L}^{-1}$$

$$= 0.01148 \text{ S cm}^{-1} \times 1000 \text{ cm}^3 \text{ L}^{-1} / 0.05 \text{ mol L}^{-1}$$

$$= 229.6 \text{ S cm}^2 \text{ mol}^{-1}$$

If we want to calculate the values of different quantities in terms of 'm' instead of 'cm',

$$\rho = RA / l$$

$$= 5.55 \times 10^3 \Omega \times 0.785 \times 10^{-4} \text{ m}^2 / 0.5 \text{ m}$$

$$= 87.135 \times 10^{-2} \Omega \text{ m}$$

$$\kappa = 1/\rho = 100 / 87.137 \Omega \text{ m} = 1.148 \text{ S m}^{-1}$$

$$\text{and } \Lambda_m = \kappa / c = 1.148 \text{ S m}^{-1}$$

$$= 229.6 \times 10^{-4} \text{ S mol}^{-1}.$$

NOTE: $\text{Ohm}^{-1} \text{cm}^2 \text{mol}^{-2} = \text{Scm}^2 \text{mol}^{-1}$ in SI unit

$$1 \text{Sm}^2 \text{mol}^{-1} = 10^4 \text{Scm}^2 \text{mol}^{-1}$$

$$1 \text{Scm}^2 \text{mol}^{-1} = 10^4 \text{Sm}^2 \text{mol}^{-1}$$

Question 3

- Explain the variation of molar conductivity with dilution for strong and weak electrolytes.
- State Kohlrausch's law of independent ionic migration.

- c. Outline the applications of Kohlrausch's law.

Answers

- a. **For weak electrolytes**, the variation in the value of molar conductivity with dilution can be explained on the basis of number of ions furnished by it in the solution. The number of ions furnished by the electrolytes in solution depends upon the degree of ionisation of the electrolyte. On dilution, the degree of ionisation of the weak electrolyte increases, thereby increasing the value of Λ_m

For strong electrolytes, the number of ions in the solution do not increase because, these are almost completely ionised in solution at all concentrations. However, in concentrated solutions of strong electrolytes the density of the ions is relatively high which results in the significant inter-ionic interactions. Such inter-ionic attractions effectively reduce the speed of the ions and are responsible for the lower value of Λ_m . On increasing dilution the ions move apart and inter-ionic attractions are decreased. As a result the value of Λ_m increases.

- b. It states that at infinite dilution, when the dissociation of the electrolyte is complete, each ion makes a definite contribution towards the molar conductivity of electrolyte, irrespective of the nature of the other ion with which it is associated.

c.

- Used in calculation of Molar conductivities of weak electrolytes at infinite dilution.
- Used in calculation of degree of dissociation of weak electrolytes

c) Extended activities

Question 1

Calculate Λ_m for CaCl_2 and MgSO_4 given that molar conductivity at infinity dilution for calcium ions and chloride ions are $\lambda^\circ_{\text{Ca}^{2+}} = 119.0 \text{ S cm}^2 \text{ mol}^{-1}$ and $\lambda^\circ_{\text{Cl}^-} = 76.3 \text{ S cm}^2 \text{ mol}^{-1}$

Answers

We know from Kohlrausch law that

$$\Lambda_m (\text{CaCl}) = \lambda^\circ_{\text{Ca}^{2+}} + 2\lambda^\circ_{\text{Cl}^-} = 119.0 \text{ S cm}^2 \text{ mol}^{-1} + 2(76.3) \text{ S cm}^2 \text{ mol}^{-1}$$

$$= (119.0 + 152.6) \text{ S cm}^2 \text{ mol}^{-1}$$

$$= 271.6 \text{ S cm}^2 \text{ mol}^{-1}$$

$$\Lambda_m(\text{MgSO}_4) = \lambda^\circ \text{Mg}^{2+} + 2\lambda^\circ \text{SO}_4^{2-} = 106.0 \text{ S cm}^2 \text{ mol}^{-1} + 160.0 \text{ S cm}^2 \text{ mol}^{-1}$$

$$= 266 \text{ S cm}^2 \text{ mol}^{-1}.$$

Question 2

The molar conductivities at infinite dilution for NaCl, HCl and NaAc are 126.4, 425.9 and 91.0 S cm² mol⁻¹ respectively. Calculate the molar conductivity at infinity dilution, Λ_0 for HAc.

Answer

Using Kohlrausch law;

$$\Lambda^\circ(\text{HAc}) = \lambda^\circ \text{H}^+ + \lambda^\circ \text{Ac}^- = \lambda^\circ \text{H}^+ + \lambda^\circ \text{Cl}^- + \lambda^\circ \text{Na}^+ - \lambda^\circ \text{Cl}^- - \lambda^\circ \text{Na}^+$$

$$= \Lambda^\circ(\text{HCl}) + \Lambda^\circ(\text{NaAc}) - \Lambda^\circ(\text{NaCl})$$

$$= (425.9 + 91.0 - 126.4) \text{ S cm}^2 \text{ mol}^{-1}$$

$$\Lambda_0 \text{ for HAc.} = 390.5 \text{ S cm}^2 \text{ mol}^{-1}.$$

Question 3

The conductivity of 0.001028 mol L⁻¹ acetic acid is 4.95 × 10⁻⁵ S cm⁻¹. Calculate its dissociation constant if Molar conductivity at infinite dilution for ethanoic acid is 390.5 S cm² mol⁻¹.

Answers

$$\Lambda_m = \kappa/c = 4.95 \times 10^{-5} \text{ S cm}^{-1} / 0.001028 \text{ mol L}^{-1} \times 1000 \text{ cm}^3 / \text{L} = 48.15 \text{ S cm}^2 \text{ mol}^{-1}$$

$$\alpha = \Lambda_m / \Lambda^\circ_m = 48.15 \text{ S cm}^2 \text{ mol}^{-1} / 390.5 \text{ S cm}^2 \text{ mol}^{-1} = 0.1233$$

$$K = c\alpha^2 / (1 - \alpha) = 0.001028 \text{ mol L}^{-1} \times (0.1233)^2 / (1 - 0.1233) = 1.78 \times 10^{-5} \text{ mol L}^{-1}$$

13.1 Key unit competence

The learner should be able to predict the products of given electrolytes during electrolysis and work out quantitatively to determine how much is liberated at a given electrode using Faraday's law.

13.2 Prerequisite knowledge and skills

Students will learn better the electrolysis if they have understanding on: electricity, and conductivity of solutions..

13.3 Cross-cutting issues to be addressed

- Inclusive education

This unit involves a number of experiments. The experiments require assembling of apparatus and observation of the results. This may be challenging to students with special educational needs especially children with visual impairment. However, the teacher can make some arrangements like:

- Grouping students. Students with special educational needs are group with others and assigned roles basing on individual student's abilities.
- Providing procedure earlier before the experiment so that students get familiar with them. They can be written on the chalkboard or printed depending on available resources. If you have children with low vision remember to print in appropriate fonts.
- Every important point is written and spoken. The written points helps students with hearing impairment and speaking aloud helps students with visual impairment
- Remember to repeat the main points of the lessons.

13.4 Guidance on introductory activity

Before introducing the first lesson of this unit (Definition of electrolysis and Description of electrolytic cells), let learners attempt activity 13.1. This activity intends to:

- Relate the unit with learners' daily life to capture their attention.
- Assess learners understanding of the concept of electricity and conductivity of solutions.

Methodological steps

- As a facilitator, the teacher is expected to guide learners to:
- Carefully observe the figures.
- Then individually answer the questions.
- Each student records his or her answers.
- Appoint some learners to share their answers as you record the main points on the chalkboard.

13.5 List of lessons (including assessment).

Heading	Lesson title	objectives	No of periods
Unit 13. Electrolysis	Definition of electrolysis and Description of electrolytic cells.	Define electrolysis, cathode and anode Carry out a practical activity to explain the phenomenon of electrolysis.	2
	Electrolysis of concentrated and dilute sodium chloride solution	Explain the electrolysis of different substances	2
	Electrolysis of water	Develop practical experimental skills related to electrolysis, interpret results, and draw valid conclusions.	1
	Electrolysis of concentrated copper (II) sulphate solution using inert electrode	Develop practical experimental skills related to electrolysis, interpret results, and draw valid conclusions.	2
	Electrolysis of concentrated copper (II) sulphate solution using copper electrode	Compare the electrolysis of dilute solutions and concentrated solutions	2
	Faraday's law	State Faraday's laws and define the Faraday's constant. Calculate the masses and volumes of substances liberated during electrolysis.	2

	Factors affecting electrolysis	Relate the nature of electrode, reactivity of metal ion in solution to the products of electrolysis	2
	Application of electrolysis	Describe industrial applications of electrolysis. Perform electroplating of graphite by copper metal	1
End unit assessment			2

2.6 Guidance on different lessons.

Lesson 1: Definition of electrolysis and Description of electrolytic cells. (40 minutes)

This is the first lesson of unit 13 and is a double lesson. That is to say it has only two periods (80 Minutes). The first lesson also covers the introduction of the whole unit.

a. prerequisites:(10 minutes)

Students will learn better the definition electrolysis and description of electrolytic cells if they have understanding on: electricity and conductivity of solutions.

b. Teaching resources:

- Chalkboard or manila paper
- Use the illustrations in the students' book.

c. Learning activities : (60 minutes)

- Before introducing the lesson, you will have to introduce the whole unit. Let learners therefore attempt general activity first then activity 13.1 which leads students to the first lesson of the unit. As a facilitator, the teacher is expected to guide learners through the following steps:
- Ask students to observe carefully the picture and then individually answer the questions.
- Each student records his or her answers.
- Select some learners (4) to share their answers to the whole class, the class

discusses on the presentation as you record the main points on the chalkboard.

- Remember to even say whatever you write so that learners with visual and hearing impairment benefits.

Activity 13.1

- Let learners in pairs answer questions of activity 13.1.
- Move around the class, listening to students as they discuss and looking at their answers. Mark their work as they complete each sub question and make general corrections to the whole class.
- This is diagnostic activity; the next step will greatly depend on your judgment. If your class cannot correctly answer the questions, extra explanations and exercises are necessary. But if they are correctly answered then the teacher can proceed to the actual content of the lesson.

Make a summary of the lesson (short notes) and assess your lesson

A. (1) In case the source is at the top of the hill, you just connect pipes to supply water to the community in the valley

(2) In case, the source is in the valley, you must use a machine to accelerate water from the valley to the top of the hill in order to supply the community.

B. We cook food by heating because heat is a form of energy

C. A spontaneous reaction is capable of proceeding in a given direction without needing to be driven by an outside source of energy while a non-spontaneous chemical reaction is a process in which the standard change in free energy is positive and energy is absorbed.

D. Yes, electrolysis is a chemical decomposition produced by passing electric current through a liquid or a solution containing ions

d. Proposed answers to checking up:13.1 (10 minutes)

Choose the correct answer from the options given below each of the following questions:

1. Which of the following substances is an electrolyte?

- a) Mercury b) Copper c) Sodium sulphate d) Aluminium

Answer is (a) and (c)

- Materials: Carbon or graphite rods, connecting wire, U-tube, dry cell, glass syringes, concentrated sodium chloride, cork and switch.
- Procedure:
- Add 10g of sodium chloride to 100cm³ of distilled water.
- Warm the mixture and continue adding sodium chloride until a saturated solution is formed.
- Put the saturated solution in U-tube and fit it with carbon rods and glass syringes.
- Level the brine solution in the two arms and switch on the circuit. Record any observations made after some time. Identify any gases collected in the syringe.
- Questions:
- Identify the gases formed by testing them using litmus papers.
- Using ionic equations, explain how the products are formed.
- Form groups of 4-6 students. The number of groups and members will depend on your class size.
- In the groups students attempt activity 13.2. Discuss and record their answers.
- Each group representative presents their answers to the whole class.
- During the presentation ask some questions that lead to lesson conclusion.
- Guide students to make the summary of the lesson themselves.
- Make the final conclusion of the lesson.
- Assess the lesson. Students can do this exercise either in the course of this lesson if there is still time or as home work. Make sure you mark the students' work.

c. Proposed answers to checking up 13.2: (10 minutes)

When dilute sodium chloride solution is electrolysed using inert electrodes, the Na⁺ and H⁺ ions are attracted to the cathode. The Cl⁻ and OH⁻ ions are attracted to the anode.

At the cathode: The H⁺ and Na⁺ ions are attracted to the platinum cathode. H⁺ ions gains electrons from the cathode to form hydrogen gas. (The hydrogen ions accept electrons more readily than the sodium ions. As a result, H⁺ ions are discharged as hydrogen gas, which bubbles off. I will explain why H⁺ ions are preferentially discharged later.)

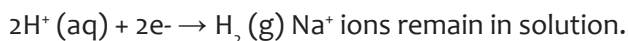

At the anode:

OH^- and Cl^- are attracted to the platinum anode. OH^- ions give up electrons to the anode to form water and oxygen gas.

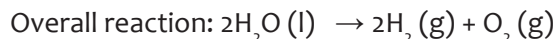
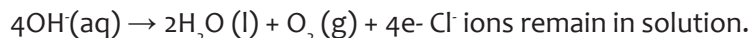

The pH of mixed electrolyte with inert electrodes did not change significantly since the H^+ produced at the anode neutralizes the OH^- produced at the cathode.

Lesson 3: Electrolysis of water (40minutes)

a. Prerequisites: (10 minutes)

Before beginning this lesson, learners should be able to recall some of the properties of water studied in senior one. The teacher may ask oral questions to explain some components of electrolysis. If the learners are able to mention some, then he can proceed. If not he can ask some probing questions.

b. Teaching resources:

- Distilled water
- Tap water
- 2 silver-colored thumb tacks
- 9V battery
- Small, clear plastic container
- 2 test tubes
- Stopwatch
- Baking soda
- Table salt
- Lemon
- Dishwashing detergent

c. Learning activities

Learners should carry out the experiments in activity 13.3. They should also do the study questions from each of the experiments performed in activity 13.3.

Proposed answers to checking up 13.3.

1. Think of the two electrodes with a voltage difference between them. That means that there's an electric field in the water between them. So any H^+ ions get pulled one way, OH^- ions get pulled the other. Look at the electrode where the H^+ ions gather. It has a negative voltage- too many electrons. Electrons can leave the electrode and join up with a pair of H^+ ions to make the H_2 molecule. The reaction over where the OH^- 's gather is a little more complicated, but by donating electrons to the positive electrode they can form water molecules and O_2 molecules.

This process doesn't use up the ions, because more H_2O water molecules keep falling apart to make up more $H^+ + OH^-$ ions. When there's no voltage on, that's also happening but it's balance by ions recombining to make H_2O .

2. Electrolysis is always carried out using direct current because here the electrodes have definite polarity. Towards A.C the behavior of the solution depends mainly on the electrodes. For most metallic electrodes namely Cu, Zn the solution behaves much like resistance and the energy is wasted in heating of the solution.

Lesson 4: Electrolysis of concentrated copper (II) sulphate solution using inert electrode (80 minutes)

a. Prerequisites

The previous lessons therefore, make sure it was well understood. can give learners some quick revision questions.

b. Teaching resources

- Textbooks ,
- chalkboard
- internet resources

c. Learning activities

Students are asked to do research and answer questions in activity 13.4

The teacher may help learners by giving them a list of important reference books available in the school library.

- Research work (activity 13.4) is done prior to the lesson time.
- Prepare it before and give to learners clear instructions keeping in mind

that In addition to subject matter skills and knowledge.

- On each question you will have to first give learners time to share their answers then agree on what is right.
- Guide their experiment.
- Summarise the lesson and verify learners' notes.
- Assess the lesson using checking up 13.4

Proposed answers to checking up 13.4

1. a. Cathode: lead metal

Anode: Bromine vapours

b. Cathode : sodium metal

Anode : Chlorine gas

c. Cathode: hydrogen gas

Anode : Oxygen gas

d. Cathode: Hydrogen gas

Anode : Oxygen gas

e. Cathode: Hydrogen gas

Anode: Chlorine gas

2. a) Ions presents in electrolyte: Pb^{2+} and Br^- ions.

At the cathode, lead metal is formed.

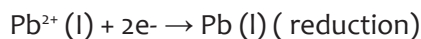

At the anode, the non-metal, bromine gas, is formed.

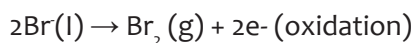

Overall reaction:

Lead (II) bromide is decomposed by electricity to form lead and bromine.

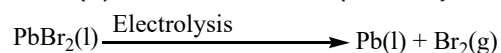

When a molten ionic compound is electrolysed using inert electrodes then

- The metal is always produced at the negative electrode (cathode), where

reduction of metal ion (cation) occurs.

- The non-metal is always produced at the positive electrode (anode), where oxidation of a non-metal ion (anion) occurs.

b) Ions present in electrolyte: Mg^{2+} and O_2^- ions.

At the cathode, magnesium metal is formed.



At the anode, the non-metal, oxygen gas, is formed.

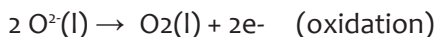

Overall reaction:

Magnesium oxide is decomposed by electricity to form magnesium and oxygen.

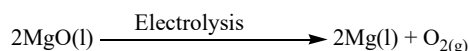

Lesson 5 : Electrolysis of copper (II) sulphate solution using copper electrode (80 minutes)

a. Prerequisites: (10 minutes)

The teacher will introduce the lesson by allowing learners to do the introductory activity 13.4 in groups. This activity is diagnostic i.e. intended to check on the previous information about electrolysis of copper (II) sulphate solution using inert electrodes.

b. Teaching resources:

- Text books
- Chalkboard
- Apparatus
- chemicals

Learning activities: (70 minutes)

- Let learners do the activity (experiment To Investigate what happens when a solution of copper (II) sulphate is electrolysed using carbon and copper electrodes)
- The lesson also targets practical/experimental skills (manipulation, observation, recording and interpretation, making inferences, generalisation and conclusion) in addition to basic and generic competences. If possible the experiments can be done individually to develop manipulation skills but if they are few form manageable groups and make sure every learner

participates. However, when learners perform a task together in groups it is also an opportunity to develop interpersonal skills, therefore, it should be considered during group formation.

- After experiments learners will have to do study questions that will help them to make conclusions.

Proposed answers to checking up 13.5

1. At the anode: Bubbles of gas (oxygen) are formed at the anode.

anode reaction: $4\text{OH}^-(\text{aq}) \rightarrow \text{O}_2(\text{g}) + 2\text{H}_2\text{O}(\text{l}) + 4\text{e}^-$

At the cathode: A deposit of copper forms on the cathode; this will often be powdery and uneven.

Cathode reaction: $\text{Cu}^{2+}(\text{aq}) + 2\text{e}^- \rightarrow \text{Cu}(\text{s})$

2. a. At cathode – size of cathode increases

b. At anode – size of anode decreases

c. Electrolyte - The colour of electrolyte remains same i.e. blue

3. Write equations for the reaction taking place at cathode and at anode during the electrolysis of: Acidified copper sulphate solution with copper electrode.

Answer:

At Cathode: $\text{Cu}^{2+}(\text{aq}) + 2\text{e}^- \rightarrow \text{Cu}(\text{s})$

At Anode: $\text{Cu} \rightarrow \text{Cu}^{2+} + 2\text{e}^-$

Acidified water with inert electrode.

Answer:

At Cathode: $\text{H}^+ + \text{e}^- \rightarrow (\text{H})$

$2(\text{H}) \rightarrow \text{H}_2 \text{ gas}$

$4\text{OH}^- \rightarrow 2\text{H}_2\text{O} + \text{O}_2$

Molten lead bromide with inert electrode.

Answer:

At Cathode: $\text{Pb}^{2+} + 2\text{e}^- \rightarrow \text{Pb}$

At Anode: $2(\text{Br}) \rightarrow \text{Br}_2$ gas

4. Using a table, highlight the similarities and differences between using graphite electrodes and copper electrode for the electrolysis of copper sulphate.

Answer:

Electrolyte		Negative electrode	Positive anode product	
aqueous copper(II) sulfate $\text{CuSO}_4(\text{aq})$ with carbon electrodes	copper deposit	any conducting electrode e.g. carbon rod, any metal including copper itself $\text{Cu}^{2+}(\text{aq}) + 2\text{e}^- \rightarrow \text{Cu}(\text{s})$	oxygen gas	inert electrode like carbon (graphite rod) or platinum (i) $4\text{OH}^-(\text{aq}) \rightarrow 2\text{H}_2\text{O}(\text{l}) + \text{O}_2(\text{g}) + 4\text{e}^-$ (ii) $2\text{H}_2\text{O}(\text{l}) \rightarrow 4\text{H}^+(\text{aq}) + \text{O}_2(\text{g}) + 4\text{e}^-$

aqueous copper (II) sulphate $\text{CuSO}_4(\text{aq})$ with copper electrodes	copper deposit	any conducting electrode e.g. carbon rod, any metal including copper itself $\text{Cu}^{2+}(\text{aq}) + 2\text{e}^- \rightarrow \text{Cu}(\text{s})$ this is the copper plating equation	copper(II) ions – the copper anode dissolves	copper anode electrode $\text{Cu}(\text{s}) - 2\text{e}^- \rightarrow \text{Cu}^{2+}(\text{aq})$ or $\text{Cu}(\text{s}) \rightarrow \text{Cu}(\text{s}) + 2\text{e}^-$
--	----------------	---	--	---

Lesson 4: Faraday's day (80minutes)

a. Prerequisites: (10 minutes)

The lesson 6: Electrolysis of copper (II) sulphate solution using inert electrode and Electrolysis of copper (II) sulphate solution using copper electrodes therefore, make sure it was well understood. You can give learners some quick revision questions.

b. Teaching resources

- Textbooks and internet resource

c. Learning activities: (60 minutes)

- Form groups of 2-4 students. The number of groups and members will depend on your class size.
- In the groups students discuss and record their answers.
- Each group representative presents their answers to the whole class.
- During the presentation ask some questions that lead to lesson conclusion. Guide students to make the summary of the lesson themselves.

d. Proposed answers to checking up 13.6

1. Charge Q, passed= $i.t$

$$= 0.65 \times 35 \times 60$$

$$= 1365 \text{ C} \qquad 0.449$$

Mass of the element liberated by 1 coulomb = 0.449

Number of coulombs liberating a mole of the element = $3.29 \times 10^4 \text{ g}$

$$\frac{193009 \times 1185}{96500} = 193009 \times 1185 \text{ C}$$

Number of Faradays liberating a mole of the element =

$$\frac{193009 \times 1185}{96500} = 2F, \text{ the charge of } M \text{ is } +2$$

2. When constant current was passed through an aqueous solution of copper (II) nitrate for one hour the mass of the copper cathode increased by 15.24g.

Calculate the current in amperes which was used ($F=96500$ $\text{Cu}=63.5$)

Answer:

Calculate the time in seconds = $60 \times 60 = 3600$ seconds

Equation for the discharge: $\text{Cu}^{2+} + 2\text{e}^- \rightarrow \text{Cu(s)}$ so, $n=2$

Calculate the current $M = \frac{I \times t \times m}{n \times F}$

$$15.24 = \frac{I \times 3600 \times 63.5}{2 \times 96500}$$

$$I = \frac{15.24 \times 2 \times 96500}{3600 \times 63.5} = 12.$$

Lesson 7: Factors affecting electrolysis (80 minutes)

a. prerequisites:

Students will learn better the factors affecting electrolysis if they have understanding on: The three previous lesson i.e Electrolysis of water, electrolysis of sodium chloride and Electrolysis of Copper (II) sulphate solution.

b. Teaching resources:

Use the illustrations in the students' book or draw them on a manila paper.

c. Learning activities :

Students are asked to do experiment on electrolysis of copper (II) sulphate solution using carbon electrodes and using copper electrodes to investigate the nature of electrodes affects the discharge of ions during electrolysis and answer questions in activity 13.7.

- As a facilitator, the teacher is expected to guide learners through the following steps:
- Carefully observe the set up then in group of two answer the questions.
- Each group records his answers.
- Select some learners (2-4) to share their answers to the whole class, the class discusses on the presentation as you record the main points on the chalkboard. Remember to even say whatever you write so that learners with visual and hearing impairment benefits.

Proposed answers to checking up 13.7 QUESTION 1 A student set up the following experiment. How would the rate of electrolysis in beaker 2 compare to that in beaker 1?

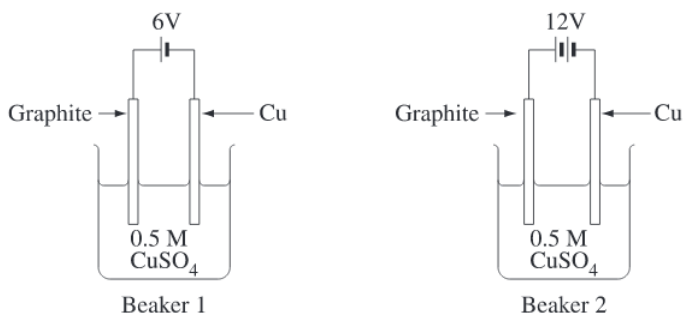

- It would be faster
- It would be slower
- There would be no difference
- There is not enough information to answer this question
- Answer: a) it would be faster

QUESTION 2

Which of the following factors affect which reactions dominate in an electrolytic cell.

1. Temperature
2. The concentration of reactants
3. The voltage used
4. The nature of the cathode

- A) 1 & 2
B) 2 & 3
C) 1, 2 & 3
D) 1, 2, 3 & 4

Answer is C

Question 3

- A university student set up three different electrolytic cells. The substances that were electrolyzed were NaCl(l), 0.05 M NaCl(aq) and 5.0 M NaCl(aq). Which of the following statements correctly describes the results of the experiment?
- The reactions occurring for the aqueous solutions will produce the same products at the anode and cathode.
- Chlorine gas is the major product when molten NaCl(aq) and 0.05 M NaCl(aq) are electrolysed.
- The pH at the cathode increases when solutions of NaCl are electrolysed.
- The only means by which different products can be produced for varying concentrations of NaCl is to alter the voltage.
- Answer is (c)

Lesson 8: Application of Electrolysis

a. Prerequisites:

Students will learn better the application of electrolysis if they have understanding in all previous lesson on electrolysis.

b. Teaching resources:

- Chalkboard.
- Where possible use manila papers.

c. Learning activities

Learning activity 13.8 is suggested in students' book.

Let learners in pairs answer questions of activity 13.8.

- Move around the class, listening to students as they discuss and looking at their answers. Mark their work as they complete each question and make general corrections to the whole class.
- This is diagnostic activity; the next step will greatly depend on your judgment. If your class cannot correctly answer the questions, extra explanations and exercises are necessary. But if they are correctly answered then the teacher can proceed to the actual content of the lesson.
- Make a summary of the lesson (short notes) and assess your lesson.
- Proposed answers to checking up 13.8

Electroplating

Example: Silver electroplating

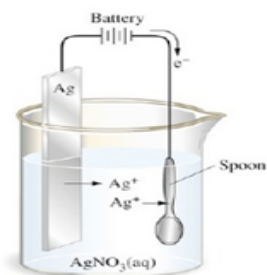

Anode: Silver



Cathode : Spoon

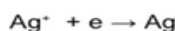

a) What is the difference between electrolytic extraction of a metal and electroplating?

Answer: Electroplating is a process that uses electric current to reduce dissolved metal cations so that they form a thin coherent metal coating on an electrode.

b) Draw a set up used to electroplate a spoon by silver.

What is the material for cathode and anode during electro refining of impure copper?

The anode, positive electrode, is the impure metal to be purified. [Oxidation](#), loss of electrons, occurs at the anode: For a metal copper:

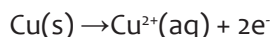

- The cathode, negative electrode, is the electrode at which the pure metal will be deposited. [Reduction](#), gain of electrons, occurs at the cathode.
- For a metal copper: $\text{Cu}^{2+}(\text{aq}) + 2\text{e}^{-} \rightarrow \text{Cu}(\text{s})$
- The electrolyte is either a molten salt or an aqueous solution of the metal ions.
- Electrometallurgy is the process of reduction of metals from metallic compounds to obtain the pure form of metal. Given elements: Aluminium, lithium, sodium, potassium, magnesium, calcium, Zinc, Iron and copper which ones can be reduced by chemical agents such as C and which ones are produced by Electrolysis only?
- Answer:
 - Extraction using carbon. Metals such as zinc, iron and copper are present in ores as their oxides. Each of these oxides is heated with carbon to obtain the metal. The metal oxide loses oxygen, and is therefore reduced.
 - Aluminium, lithium, sodium, potassium, magnesium, calcium, and in some cases copper, are produced in this way.

13.6 Unit Summary

- Electrolysis is decomposition of a substance by passing an electric current through it.
- An electrolyte is a substance, either in molten form or aqueous solution, which conduct electric current and is decomposed by it.
- A non electrolyte is a solution or molten compound which cannot be decomposed by an electric current.
- An electrode is pole made of carbon (Graphite) or metal through which current (as a flow of electrons) enters or leaves an electrolyte.
- An anode is the positive electrode through which electrons leave the electrolyte and a cathode is the negative electrode through which electrons enter the electrolyte or leave the external circuit.
- Water is a polar solvent and have the property of possessing some electrical imbalance gives it the ability to dissolve ionic compounds.
- Preferential selection and discharge of an ion depends on the following factors:
 - a. Position of the ion in the electrochemical series.
 - b. Concentration of the ions
 - c. Position of the ion in the electrochemical series.
 - d. Concentration of the ions

e. Nature of the electrons.

- Faraday's first law of electrolysis states that:

The mass of a substance deposited on electrode during electrolysis is directly proportional to the quantity of electricity passing through an electrolyte.

A Faraday is a charge of one mole of electrons.

1F=96500Coulombs.

13.7.Additional information:

d. Applications of Electrolysis

Electrolysis has wide applications in industries. Some of the important applications are, as follows:

- Production of hydrogen by electrolysis of water.
- Manufacture of heavy water (H_2O).
- The metals like K, Na, Mg, Al, etc., are obtained by electrolysis of fused electrolytes.
- Non-metals like hydrogen, fluorine, chlorine are obtained by electrolysis.
- In this method pure metal is deposited at cathode from a solution containing the metal ions Ag ,Cu etc.
- Compounds like NaOH, KOH, Na_2CO_3 , $KClO_3$, white lead, $KMnO_4$ etc. are synthesised by electrosynthesis method.

Electroplating: The process of coating an inferior metal with a superior metal by electrolysis is known as electroplating.

The aim of electroplating is, to prevent the inferior metal from corrosion and to make it more attractive in appearance. The object to be plated is made the cathode of an electrolytic cell that contains a solution of ions of the metal to be deposited.

With copper	Cu	Object	$CuSO_4 + \text{dilute } H_2SO_4$
With silver	Ag	Object	$K[Ag(CN)_2]$
With nickel	Ni	Object	Nickel ammonium sulphate

With gold	Au	Object	$K[Au(CN)_2]$
With zinc	Zn	Iron objects	$ZnSO_4$
With tin	Sn	Iron objects	$SnSO_4$

Electroplating

Example: Silver electroplating

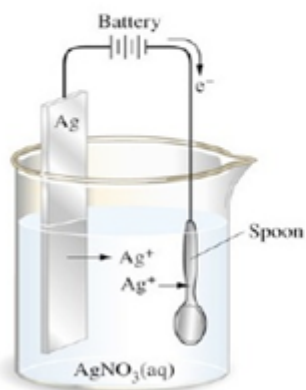

Anode: Silver

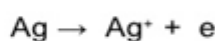

Cathode : Spoon

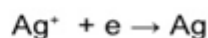

13.8.End unit assessment:

Standard of performance: Accurately predict the products of given electrolytes during electrolysis and work and quantitatively to determine how much is liberated at a given electrode using Faraday's law.

-
- 13.9.Additional activities
- Remedial activities:
- State Faraday's laws of electrolysis
- Answer:
- First law: The amount of a given product liberated at an electrode during electrolysis is directly proportional to the quantity of electricity which passes through the electrolyte solution.
- Second law:
- When the same quantity of electricity passes through solutions of different electrolytes, the amounts of the substances liberated at the electrodes are directly

proportional to their chemical equivalent.

- An electric is passed through two cells in series containing copper (II) sulphate and silver nitrate solutions, respectively. What mass of silver will be deposited when 1g of copper has been deposited (Cu=63.5; Ag=108)

- Answer:

- Equivalent mass of Cu=

$$\frac{63.5}{2} = 31.75g$$

$$\frac{\text{Mass of Ag}}{\text{Mass of Cu}} = \frac{E \text{ for Ag}}{E \text{ for Cu}}$$

$$\frac{\text{mass of Ag}}{1} = \frac{108}{31.75}$$

- Hence:

- Mass of Ag = 3.398g

- Consolidation activities:

- What current strength in amperes will be required to liberate 10g of iodine from potassium iodide solution in one hour?

- Answer:

- 127g of iodine is liberated by = 96500 Coulomb

$$\frac{96500}{127} \times 10 \text{ coulomb}$$

- 10g of iodine is liberated by =

- Let the current strength be = I

- Time in seconds = 1x 60 x60 = 3600s

- We know that the quantity of electricity, Q, used is given by the expression

- Q= Ix time in seconds

Current strength, I=

$$\frac{Q}{t} = \frac{96500 \times 10}{127 \times 60 \times 60} = 2.11 \text{ Ampere}$$

- 0.1978g of copper is deposited by a current of 0.2 ampere in 50 minutes. What is the electrochemical equivalent of copper?

- Answer:

- Here, $t = 50 \text{ minutes} = 50 \times 60 \text{ seconds}$; $I = 0.2 \text{ ampere}$.
- Quantity of electricity used is $Q = I \times t = 0.2 \times 50 \times 60 = 600 \text{ coulombs}$
- Amount of copper deposited by 600 coulombs = 0.1978g
- Amount of copper deposited by 1 coulomb = $\frac{0.1978}{600} \text{ g} = 0.0003296 \text{ g}$
- Electrochemical equivalent of copper = 0.0003296
- Extended activities:
 - An electric current is passed through three cells in series containing respectively solutions of copper sulphate, silver nitrate and potassium iodide. What weights of silver and iodine will be liberated while 1.25g of copper is being deposited?

$$\frac{\text{Weights of copper}}{\text{weight of iodine}} = \frac{\text{Equivalent weight of copper}}{\text{Equivalent weight of iodine}}$$

Answer:

$$\text{Or } \frac{1.25}{x} = \frac{31.7 \cdot 1.25}{127 \cdot x} = \frac{31.7}{127}$$

X = 5.0g of iodine

Also,

$$\frac{\text{Weight of copper}}{\text{Weight of silver}} = \frac{1.25}{y} = \frac{\text{Equivalent weight of copper} (=31.7)}{\text{Equivalent weight of silver} (=108)}$$

$$\text{Weight of silver}(y) = \frac{108 \times 1.25}{31.7} = 4.26 \text{ g}$$

• During the electrolysis of dilute sulphuric acid using unreactive platinum electrodes, hydrogen is released at the cathode and oxygen at the anode. Calculate the volume of hydrogen and oxygen produced (measured at room temperature and pressure) if 1.0 amp flows for 20 minutes.

- Answer:
- The electrode equations are:
 - $2\text{H}^+(\text{aq}) + 2\text{e}^- \rightarrow \text{H}_2(\text{g})$
 - $4\text{OH}^-(\text{aq}) \rightarrow 2\text{H}_2\text{O}(\text{l}) + \text{O}_2(\text{g}) + 4\text{e}^-$
- (The molar volume of gas = 24000cm³ at rtp. 1Faraday = 96500 Coulombs)
- Number of coulombs = amps x time in seconds
- $= 1.0 \times 20 \times 60$

- = 1200
- Calculating the volume of hydrogen
- $2\text{H}^+(\text{aq}) + 2\text{e}^- \rightarrow \text{H}_2(\text{g})$
- 2 moles of electrons give 1 mole of hydrogen, H_2
- 2×96500 coulombs give 24000cm^3 of hydrogen at rtp
- 193000 coulombs give 24000cm^3 of hydrogen at rtp
- 1200 coulombs give

$$\frac{1200}{193000} \times 24000\text{cm}^3 = 150\text{ cm}^3$$

- Calculating the volume of oxygen
- $4\text{OH}^-(\text{aq}) \rightarrow 2\text{H}_2\text{O}(\text{l}) + \text{O}_2(\text{g}) + 4\text{e}^-$
- A flow of 4 moles of electrons produces 1 mole of oxygen, O_2
- 4×96500 coulombs produces 24000 cm^3 of oxygen
- 386000 coulombs produces 24000 cm^3 of oxygen

$$\frac{1200}{386000} \times 24000\text{cm}^3 = 75.0\text{ cm}^3$$

- 1200 coulombs produces
- Therefore, 150 cm^3 of hydrogen and 75.0 cm^3 of oxygen are produced.

UNIT 14: ENTHALPY CHANGE OF REACTIONS

14

14.1 Key unit competence:

Design an experimental procedure to verify the enthalpy changes in a chemical reaction

14.2 Prerequisite knowledge and skills

The teacher will help learners to recap the concepts below. Learners have the skills to use effectively the common laboratory apparatus and are aware of the safety precautions to take when doing practical work. Students will learn better learn the content related to enthalpy change of reactions if they possess an understanding on: Conservation of mechanical energy in isolated systems (unit 9 senior 2), Heat transfer and quantity (Unit 5 senior 3), Laws of thermodynamics (Unit 6 senior 3), Concentration of solutions (Unit 7, senior 3), ionic and metallic bonding (unit 3 senior 4), covalent bonding (unit 4 senior 4), Energy changes and energy profile diagrams for chemical reactions (Unit 18, senior 4), Solutions and titrations (unit 12, senior 5).

14.3 Cross-cutting issues to be addressed

a) Inclusive education:

This unit involves a number of formulae and diagrams. This may be challenging to students with special educational needs especially students with visual impairment or visual difficulties. However, the teacher can make some arrangements like:

(i) Grouping students:

Students with special educational needs are grouped with others who can help them.

- If a teacher has students with visual difficulties, when writing on the blackboard, write in large, clear writing, especially when it comes to formulae or diagrams. Read out what you are writing, for the benefit of those who are not able to see the blackboard clearly.
- If the learners are sharing textbooks, try to arrange for those with visual difficulties to have their own copies.
- Give extra time for them to write the summary notes or write down observations after experiments.

- Remember to repeat the main points of the lessons.
- For students with visual impairment, teacher can provide for them a summary using the braille alphabet if possible.
- For learners with hearing difficulties, the teacher has to encourage them to sit closer to the front of the classroom. Encourage learners not to be afraid to ask questions. When teaching, speak clearly and ensure that all the learners can hear you. Avoid speaking hurriedly as this will make it difficult for learners with hearing difficulties to make sense of what you are saying.

(ii) Learners with mobility difficulties:

These include learners on crutches, in wheelchairs, or with walking difficulties. Encourage other learners to look out for and help their classmates. Ask their fellow learners to help them with their notes, if their conditions hinder them from writing well.

(iii) Learners with reading difficulties:

Learners with this kind of difficulties struggle to make sense of words or understand written work and take longer to read than other learners. Encourage them to be careful and attentive during class time and participate for example by asking questions, answering questions, so that they can make the most of what they hear and observe. Instead of repeating word for word what is in the textbook, simplify the concepts to ease their understanding, so that when they have already understood.

b) Gender

During group activities try to form heterogeneous groups (with boys and girls) or when students start to present their findings encourage both (boys and girls) to present.

c) Financial education

As the unit deals with the enthalpy change of reactions, the teacher will attract the learners' attention on the economic impact of the use of energy in all the activities of modern society.

When performing experiments, they have to avoid waste of chemicals: they have to use the amounts that are just required.

d) Peace and values education

During group activities, the teacher will encourage learners to help each others and to respect opinions of colleagues.

e) Standardisation culture

Some lessons involve carrying out experiments. Learners have to always check if they are not using expired chemicals or defective apparatus. In addition, when performing experiments, learners have to record data accurately and for tasks involving calculations, they have to always present accurate results.

f) Environment and sustainability

In order to avoid the environment pollution, the teacher has to draw the learner's attention the negative impact of the uncontrolled use of energy sources.

Learners also have to not throw away chemicals anywhere before, during or after experiments.

14.4. Guidance on the introductory activity

Ask learners to analyse the picture found at the opening of the unit and motivate them to discuss in group of four and answer the questions related to it.

Expected answers:

The energy changes that accompany chemical reactions are vital to us. To survive, we depend on the energy content of the food we eat. Our bodies can convert the energy of the chemical bonds in food into other kinds of energy. The quality of lifestyle we lead depends largely on the energy from different chemical sources including chemical changes. In general, all chemical reactions involve energy changes. The chemical energy stored in a substance has the potential to be converted to heat or electricity.

The energy used in the process mentioned in the introductory activity and others is supplied by fuels during combustion reactions. In many cases, their heat output comes from fuels such as petrol, kerosene, ethanol, natural gas and liquefied petroleum gas (LPG). In designing engines, heaters,... it is important to know the energy output of the chosen fuel so that combustion can produce the required amount of energy. It is also important to control the fuel to oxygen ratio so that unwanted and dangerous combustion products, such as carbon monoxide, are avoided.

A large amount of energy is also provided by hydroelectric power stations, solar panels, nuclear power stations and by fuel cells some of which use hydrogen as fuel.

The amount of heat exchanged during chemical reactions may be determined by using calorimetry, enthalpy values of formation or combustion and Hess Law, Born-Haber cycles and average bond enthalpy values.

14.5. List of lessons (including assessment).

#	Lesson title	Learning objectives (from the syllabus including knowledge, skills and attitudes):	Number of periods
1	Definition of standard enthalpy of different reactions	Define heat of reaction, different types of enthalpies	2
2	Relationship between temperature and heat	Explain the relationship between quantity of heat produced and mass of substance in combustion reaction	1
3	Experimental methods for finding the standard enthalpy of combustion reactions	Carry out practical activities to determine enthalpy change of combustion	2
4	Experimental methods for finding the standard enthalpy of neutralisation reactions	Carry out practical activities to determine enthalpy change of neutralization	2
5	Hess's law	State Hess' law of constant heat Summation	2
6	Application of Hess's law	Calculate the enthalpy changes of reactions using Hess' law	2
7	Lattice enthalpy	State and explain the factors that affect the magnitude of lattice energy	2

8	Born Haber cycle: Interpretation	Deduce how Hess's law is applied to Born-Haber Cycle	2
9	Born Haber cycle: Calculations	Construct Hess's energy cycles and Born-Haber cycles from data obtained experimentally or provided	2
10	Hydration energy	Calculate the enthalpy change of combustion, neutralization and dissolution from experimental data	2
11	Average standard bond enthalpy	Describe bond breaking as endothermic and bond making as exothermic	2
12	Calculating enthalpy change of reaction using average bond enthalpies	Use the standard bond energy to determine the standard enthalpy of reactions	2
13	Summative assessment	Design an experimental procedure to verify the enthalpy changes in a chemical reaction	2

Guidance on different lessons/subheading outlined above (see the structure of a Lesson /sub-heading)

Lesson 1: Definition of standard enthalpy of different reactions (80 minutes)

a) Prerequisites (10 minutes)

Learners will get a better understanding of the content of this lesson if they refer to covalent bonding (unit 4, senior 4), Variation in trends of the physical properties (unit 5, senior) and Energy changes and energy profile diagrams for chemical reactions (Unit 18, senior 4). Form groups and let learners to discuss about the concept of bond energy, ionisation energy, ionic and covalent bonding.

b) Teaching resources

Textbooks, flip charts or chalk board

c) Learning activities

- This lesson 1 enthalpy change of reactions recalls learners the different types of enthalpy changes.
- Let students attempt activity 14.1
- Activity 14.1 (50 minutes)
- Form groups and let learner discuss the concept of enthalpy change and thermochemical equations and rules related and different types of enthalpy changes.
- Move around to make sure every learner participates.
- Ask each group to record in a note book the findings.
- Ask randomly three groups to present their findings to the whole class
- Ask learners to analyse the key ideas presented by colleagues and clarify the different types of enthalpy changes.
- From answers suggested by learners, write a short summary about the definition of different types of enthalpy changes

Expected answers to the activity 14.1

1. An Enthalpy change, ΔH , heat exchanged during a chemical reaction that happens at constant pressure. It may be positive (endothermic process) or negative (exothermic process).

A **thermochemical equation** is a balanced equation that includes the amount of heat exchanged (produced or absorbed).

Examples



2. Enthalpy changes of reaction follow some simple rules:

The enthalpy change of a reaction is proportional to the amount of reactants which are involved.

Reversing a reaction changes the sign of ΔH .

The enthalpy change of a reaction depends on the physical states of the reactants and the products.

3. There are many types of enthalpy change. Among them are the following.

Enthalpy of formation, Enthalpy of combustion, Enthalpy of neutralization, Enthalpy of displacement, Enthalpy of solution, Enthalpy of atomisation, Lattice enthalpy, Hydration enthalpy, Bond dissociation enthalpy

For more details, see student book.

Assess the lesson by letting learners to do checking up 14.1

• **Checking up 14.1 (20 minutes)**

Expected answers to checking up 14.1:

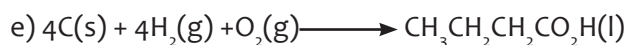
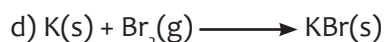
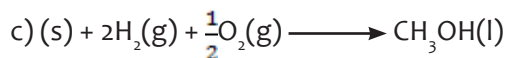
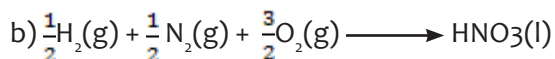
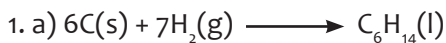

2) b), c)

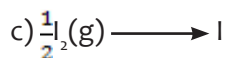
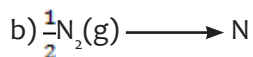
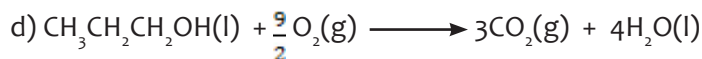
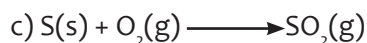
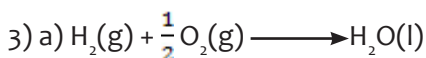

Lesson 2: Relationship between temperature and heat (40 minutes)

a) Prerequisites (5 minutes)

Learners will get a better understanding of the content of this lesson if they refer to the heat transfer and quantity (Unit 5 senior 3).

Let students discuss in pairs, how amount of heat exchanged may be calculated using data from calorimeter measurements.

b) Teaching resources

- Weighing balance

- Thermometer
- Insulated plastic beaker (calorimeter)
- Measuring cylinder
- Sodium hydroxide pellets
- Distilled water

c) Learning activities (30 minutes)

- The lesson 2 relates temperature and heat.
- Form groups and let students attempt the activity 14.2.
- Provide each group with all the requirements for this experiment. These must be available before the lesson.
- Provide learners with the procedure (this could be provided in advance) and explain it.
- Provide each group with a reporting sheet.
- Let learners perform the experiment as described in the procedure.
- Move around to make sure that all learners participate.
- Every group records their observations and make an interpretation.
- Call upon randomly three groups to share their results.

Let the class harmonise the ideas. The latter will summarize the relationship between temperature and heat.

Expected answers to activity 14.2

Refer to the student book

Assess the lesson by allowing them to do the checking up 14.2.

Expected answers to checking up 14.2 (5 minutes)

Expected answers

1. Temperature rise, $\Delta T = 56^{\circ}\text{C} - 20^{\circ}\text{C} = 36^{\circ}\text{C}$

$$q = m \times C \times \Delta T$$

$$q = 250\text{g} \times 4.18\text{Jg}^{-1}\text{C}^{-1} \times 36^{\circ}\text{C}$$

$$q = 37,620\text{J} = 37.62\text{kJmol}^{-1}$$

2. Temperature rise, $\Delta T = 60^{\circ}\text{C} - 25^{\circ}\text{C} = 35^{\circ}\text{C}$

$$q = m \times C \times \Delta T$$

$$C = \frac{q}{m \times \Delta T} = \frac{204.75\text{J}}{15\text{g} \times 35^{\circ}\text{C}} = 0.39\text{Jg}^{-1}\text{C}^{-1}$$

Lesson 3: Experimental methods for finding the standard enthalpy of combustion reactions (80 minutes)

a) Prerequisites (10 minutes)

For a better understanding of this lesson, learners will refer to: Categories of chemical reactions (unit 5, senior 2), Energy changes and energy profile diagrams for chemical reactions (unit 18, senior 4)

Form groups and ask learners to brainstorm about the different types of chemical reactions and them to make a recall.

b) Teaching resources

- Spirit burner (containing ethanol)
- Thermometer
- Vopper can
- Measuring cylinder
- Retort stand and accessories
- Balance
- Breeze shield

C) Learning activities (55 minutes)

- The lesson 3 intends to make learners familiar with the experimental methods for finding the standard enthalpy of combustion reactions.
- Form groups and let students attempt the activity 14.3.
- Provide to each group all the requirements for this experiment. These must be available before the lesson.
- Provide learners with the procedure (this could be provided in advance) and well explained it.
- Provide each group with a reporting sheet.
- Let learners perform the experiment as described in the procedure.
- Move around to make sure that the safety precautions are respected.
- Every group records their observations and make an interpretation.
- Call upon randomly four groups to share their findings.
- Let the class analyse the ideas of their colleagues and point out the key ideas about Experimental methods for finding the standard enthalpy of combustion reactions.

Expected answers to the activity 14.3

Refer to the student book

Assess the learners' understanding by allowing them do the checking up 14.3.

Expected answers to checking up 14.3 (15 minutes)

Expected answers:

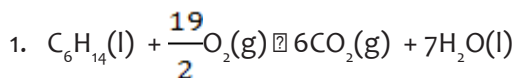

$$\Delta T = 25^\circ\text{C}$$

$$q = 100\text{g} \times 4.18\text{g/mol}\cdot^\circ\text{C} \times 25^\circ\text{C} = 10450\text{J}$$

$$\text{Number of moles} = 0.18\text{g}/86\text{g mol}^{-1} = 0.0021\text{mol}$$

$$\text{Molar enthalpy} = 10450/0.0021\text{mol} = 497,619.05\text{J} = 497.62\text{kJ}$$

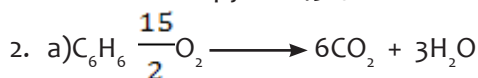

$$\text{Moles of C}_6\text{H}_6 = \frac{30\text{g}}{78\text{g mol}^{-1}} = 0.85\text{mol}$$

$$0.85\text{mol produces } 0.85\text{mol} \times 3270\text{kJ mol}^{-1} = 12,589.5\text{kJ}$$

b) When 3270kJ are produced, 6 moles of CO₂ are produced.

$$8800\text{kJ are produced } \frac{6\text{ moles} \times 8800\text{kJ}}{3270} = 16.147\text{mol}$$

$$\text{Mass of CO}_2 = 16.147\text{mol} \times 44\text{g/mol} = 710.5\text{g}$$

Lesson 4: Experimental methods for finding the standard enthalpy of neutralization reactions (80 minutes)

a) Prerequisites (10 minutes)

For a better understanding of this lesson, learners will refer to solutions and titrations (unit 12, senior 5)

The lesson 4 is about the experimental methods for finding the standard enthalpy of neutralisation reactions.

- Form groups and ask learners to discuss about the titration of a strong acid with a strong base
- Let students attempt the activity 14.4

b) Teaching resources

Each group will be provided with the following.

2 plastic beakers

50 mL of 1 M HCl

50 mL of 1 M NaOH

Thermometer

Electronic balance

Weigh boats

d) Learning activities (55 minutes)

The lesson 4 dealt with the experimental methods for finding the standard enthalpy of neutralisation reactions

- Form groups and let students attempt activity 14.4
- Provide each group with all the requirements for this experiment. These must be available before the lesson.
- Provide to the learners the procedure (this could be provided in advance) and explained.
- Provide for each group a reporting sheet.
- Let learners perform the experiment as described in the procedure.
- Move around to ensure that all learners are involved.
- Every group records their observations and make an interpretation.
- Call upon randomly four groups to share their results.
- Let the class evaluate the findings of their colleagues and point out the key ideas about the experimental methods for finding the standard enthalpy of neutralisation reactions. From learner's ideas, write a short summary.

Expected answers to the activity 14.4:

Refer to the student's book.

Assess the lesson by letting learners to do checking up 14.4

Expected answers to checking up 14.4 (15 minutes)

Expected answers

- Equation of the reaction: $\text{HX(aq)} + \text{NaOH(aq)} \rightarrow \text{NaX(aq)} + \text{H}_2\text{O(l)}$
Heat energy released, $q = m \times C \times \Delta T = 70\text{g} \times 4.18\text{J/g}\cdot\text{C} \times 50\text{C} = 1463\text{J}$
Number of moles reacted = $1\text{mol dm}^{-3} \times 30 \times 10^{-3}\text{dm}^3 = 0.03\text{mol}$
Molar enthalpy of neutralisation = $1463\text{J}/0.03\text{mol} = 48,766.67\text{J} = 48.767\text{kJ}$
- $M_r(\text{NaHCO}_3) = 23+1+12+3 \times 16 = 84\text{g/mol}$
Moles of reacted = $3.713/84 = 3.417 \times 10^{-2}\text{mol}$
Heat energy exchanged, $q = m \times C \times \Delta T = 3.71 \times 4.18 \times (-8.5) = -131.82\text{J}$
Heat energy exchanged per mol = $-131.82/3.47 \times 10^{-2} = 3798.85\text{J} = -3.79885\text{kJ}$
The enthalpy change of the reaction, $\Delta H_r = +3.79885\text{kJ mol}^{-1}$

Lesson 5: Hess's law (80 minutes)

a) Prerequisites (10 minutes)

Students will better learn the Hess's law if they have a good understanding on the concepts of enthalpy change of formation, enthalpy change of combustion and enthalpy change of reaction (unit 14, lesson 1, senior 5)

Form groups and ask learners to discuss about the enthalpy change of formation, combustion, and enthalpy change of neutralization.

b) Teaching resources

Flip charts or chalk board, chalks, textbooks (Chemistry for Rwanda secondary schools, senior 5 and others)

c) Learning activities (50 minutes)

Let students attempt the activity 14.5

- Provide to each group a reporting sheet.
- Let learners discuss in their groups.
- Move around to make sure that each student participates.
- Every group records their findings.
- Call upon randomly three groups to share their results.
- Let the class analyse presenters' ideas.
- From ideas write a short summary about the Hess's law.

Expected answers to the activity 14.5

1. a) The person who travelled the greatest distance is the one who follows the route B.
b) The person who gets more difficulties to reach point B is the one who follows the route A.
2. The gain in gravitational energy is the same.
3. A person moving from the first to the fourth floor using either stairs or a lift.
4. The gain in gravitation energy is independent on the pathway followed.
5. This is similar to the first law of thermodynamics which states that "the energy of the universe is constant".
6. For chemical reaction, as enthalpy is a state function, it will depend only on the initial and the final states.

Assess the lesson by allowing learners to do checking up 14.5.

d) Expected answers to checking up 14.5

1. Hess's cycle for the formation of propan-1-ol

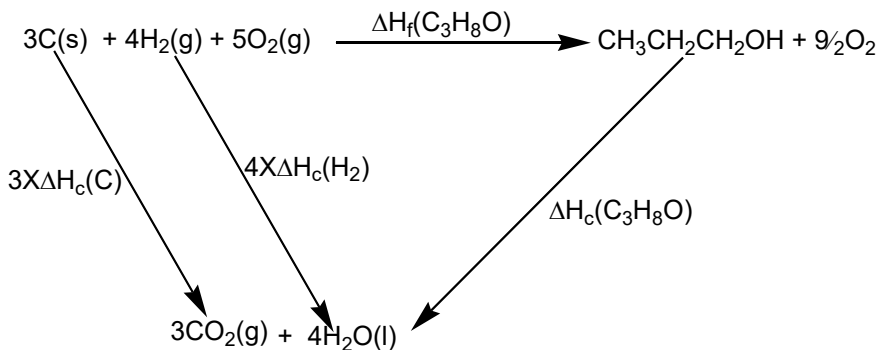

Applying the Hess's law,

$$\Delta\text{H}_f(\text{C}_3\text{H}_8\text{O}) + \Delta\text{H}_c(\text{C}_3\text{H}_8\text{O}) = 3 \times \Delta\text{H}_c(\text{C}) + 4 \times \Delta\text{H}_c(\text{H}_2)$$

$$\Delta\text{H}_f(\text{C}_3\text{H}_8\text{O}) = 3 \times \Delta\text{H}_c(\text{C}) + 4 \times \Delta\text{H}_c(\text{H}_2) - \Delta\text{H}_c(\text{C}_3\text{H}_8\text{O})$$

2. Hess's cycle for the formation of 2moles of sulphur trioxide

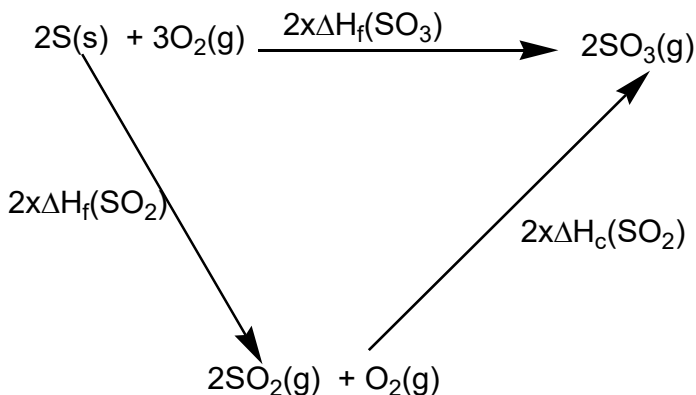

Applying the Hess's law,

$$\Delta\text{H}_r = 2 \times \Delta\text{H}_f(\text{SO}_3) = 2 \times \Delta\text{H}_f(\text{SO}_2) + 2 \times \Delta\text{H}_c(\text{SO}_2)$$

3. Hess's cycle for the formation of methane

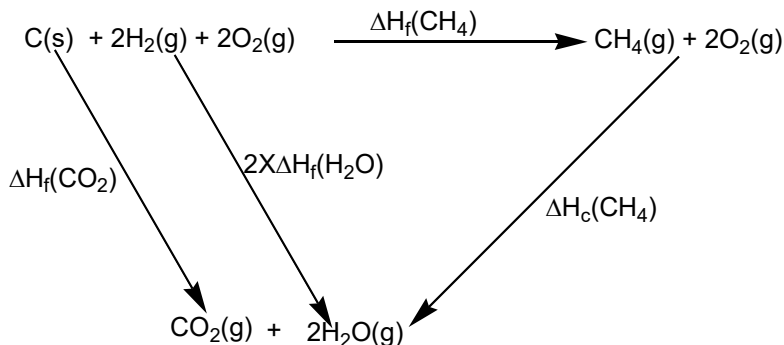

Applying the Hess's law,

$$\Delta H_f(\text{CH}_4) + \Delta H_c(\text{CH}_4) = \Delta H_f(\text{CO}_2) + 2 \times \Delta H_f(\text{H}_2\text{O})$$

$$\Delta H_f(\text{CH}_4) = \Delta H_f(\text{CO}_2) + 2 \times \Delta H_f(\text{H}_2\text{O}) - \Delta H_c(\text{CH}_4)$$

Lesson 6: Application of Hess's law (80 minutes)

a) Prerequisites (5 minutes)

For a better understanding of the applications of Hess's law, learners have to review the concepts of the Hess's law (Unit 14, Lesson 5).

Let learners discuss in pairs and remember the Hess's principle.

b) Teaching resources

Textbooks, internet connection, flip charts/chalkboard

c) Learning activities (50 minutes)

- The lesson 6 is dealing with the application of Hess's law.
- Let learners do activity 14.6
- Call upon five groups to share their findings with the emphasis on the applications of Hess's law.
- Let the class analyse the explanations brought out by their colleagues.
- From the learners' ideas, write a summary of the key points on the

applications of the Hess's law.

Expected answers to the activity 14.6:

1. Hess law : see student book
2. Enthalpies of formation of propan-1-ol, propane, propane and sulphuric acid cannot be determined directly. They can be determined using the enthalpy of combustion of their constituent elements.

Assess the lesson by letting learners to do checking up 14.6

d) Checking up 14.6 (25 minutes)

Expected answers:

1.

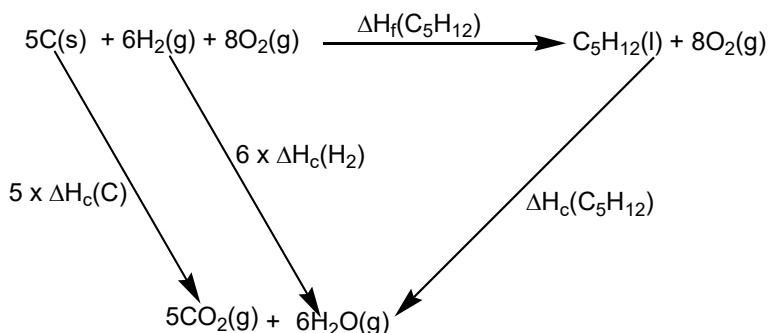

Applying Hess's law:

$$5 \times \Delta H_c(\text{C}) + 6 \times \Delta H_c(\text{H}_2) = \Delta H_f(\text{C}_5\text{H}_{12}) + \Delta H_c(\text{C}_5\text{H}_{12})$$

2. Rearrange the equations so that they add up to the reaction of interest.

Methanol is a reactant so write the reaction,



But only 1 methanol molecule is needed, so divide the coefficient of the equation by 2.

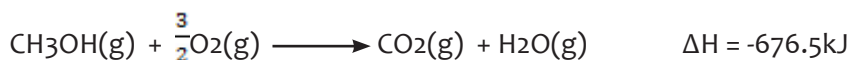

We need H₂ as a product so the equation of the reaction must be reversed.

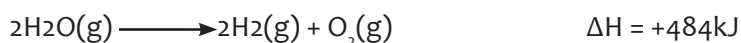

Once again we only need one H₂; so, divide by 2.

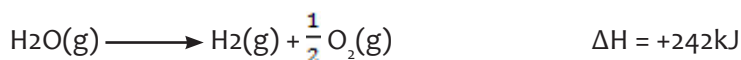

Formaldehyde is also a product; so, its combustion reaction must be reversed. Since the reaction is being reversed, the sign of ΔH must be changed.



Add it up to get the reaction required.

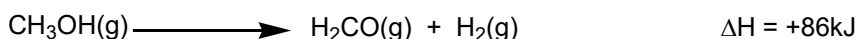
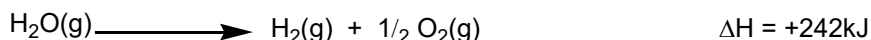
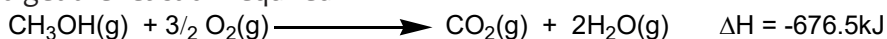

Notice that by converting methanol to formaldehyde and hydrogen, the enthalpy of the fuel has been increased. When formaldehyde and hydrogen are burnt 86 kJ more energy will be released than when methanol is burned.

3. The equation of the reaction involved are the following

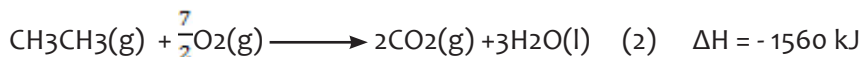

Ethene is the reactant. So, write equation (1)

Ethane is the product, so equation (2) must be reversed

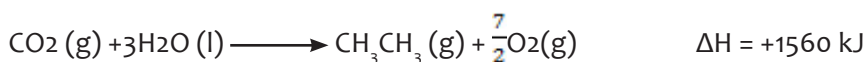

Hydrogen is the reactant. So, write equation (3)

Add up to get the require equation

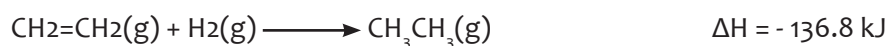
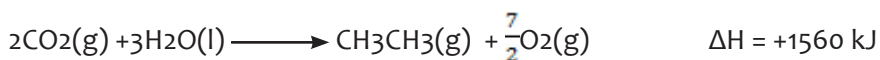

4. moles of NO are found in the products, so we multiply all coefficient of equation (1) by two.

We obtain 4 moles of NH₃. So, we reverse the equation (2) and multiply all the coefficients by two

6 moles of H₂O are found in the products, thus, multiply all coefficients by 3.

Add up to find the required equation.

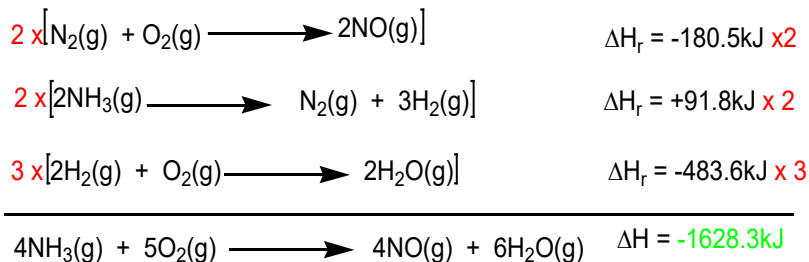

5. Hess's cycle for the formation of ethanol

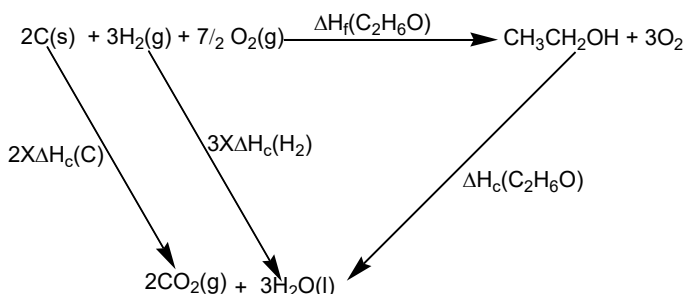

Applying Hess's law:

$$\text{Hf}(\text{C}_2\text{H}_6\text{O}) + \text{Hc}(\text{C}_2\text{H}_6\text{O}) = 2 \times \text{Hc}(\text{C}) + 3 \times \text{H}(\text{H}_2)$$

$$\text{Hf}(\text{C}_2\text{H}_6\text{O}) = 2 \times \text{Hc}(\text{C}) + 3 \times \text{Hc}(\text{H}_2) - \text{Hc}(\text{C}_2\text{H}_6\text{O})$$

$$\text{Hf}(\text{C}_2\text{H}_6\text{O}) = 2 \times (-394.51 \text{ kJ}) + 3 \times (-285.8\text{kJ}) - (-875. \text{ kJ})$$

$$\text{Hf}(\text{C}_2\text{H}_6\text{O}) = -771.42\text{kJ/mol}$$

6.

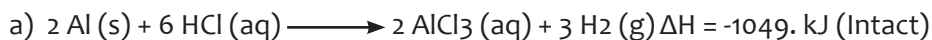

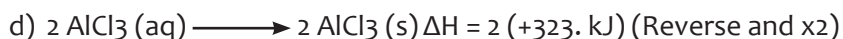

Lesson 7: Lattice enthalpy (80 minutes)

a) Prerequisites (10 minutes)

For a better understanding of the lattice enthalpy learners have to review the concepts of ionic bonding (Unit 3, senior 4):

Allow learners discuss the ionic bonding and the concept of lattice

b) Teaching resources

Textbooks, flip charts, chalk board, chalks

c) Learning activities (60 minutes)

The lesson is dealing with the lattice enthalpy

- Form groups and allow student to do activity 14.7
- Let learners discuss in their respective groups.
- Move around to make sure that each student is participating.
- Every group records their findings.
- Call upon randomly five groups to share their results.
- Let the class analyse presenters' ideas.
- From ideas write a short summary about the lattice enthalpy.

Expected findings

See student book

1. An ionic bond is a bond formed by electrostatic attraction between oppositely charged ions.
2. Steps involved in the formation of an ionic bond
 - (i) The metal is transformed into gaseous atoms
 - (ii) The metal gaseous atoms are ionised (transformed into cations)

- (iii) The non metal is transformed into gaseous atoms
- (iv) Gaseous non metal ions are transformed into anions
- (v) Electrostatic attractions between cations and anions to form the solid crystal.

Assess the lesson by allowing learners do checking up 14.7

Expected answers to checking up 14.7 (10 minutes)

Expected answers:

1. a) The lattice enthalpy is the enthalpy change that accompanies the formation of one mole of an ionic compound from its gaseous ions under standard conditions.

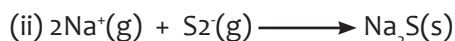
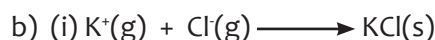

2. a) NaCl
- b) MgCl_2
- c) NaF
- d) MgO

Lesson 8: Born Haber cycle: Interpretation (80 minutes)

a) Prerequisites (5 minutes)

For a better understanding of the Haber cycle, learners must master the formation of ionic bond and the different steps that are involved (Unit 3, senior 4), the applications of the Hess's law.

Let student discuss in groups the different types of energies involved in the formation of an ionic bond.

b) Teaching resources

Textbooks, flip charts, chalkboard, chalks

c) Learning activities (55 minutes)

The lesson 8 is about the Born-Haber cycle

Allow learners to form groups and ask them to activity 14.8

Allow learners to form groups and ask them to do activity 14.8

- Allow them to research using the textbooks or internet
- Each group records their findings
- Choose randomly four groups to share their findings with other
- Let learners evaluate ideas presented
- Let learners evaluate ideas presented
- From their ideas write a short summary on the Born-Haber cycle.

Expected answers to activity 14.8

See student book

Assess the lesson by letting learners to do Checking up 14.8

d) Expected answers to checking 14.8 (20 minutes)

1. Born-Haber cycle for the formation of calcium fluoride

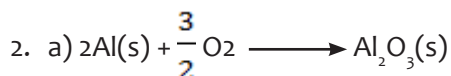
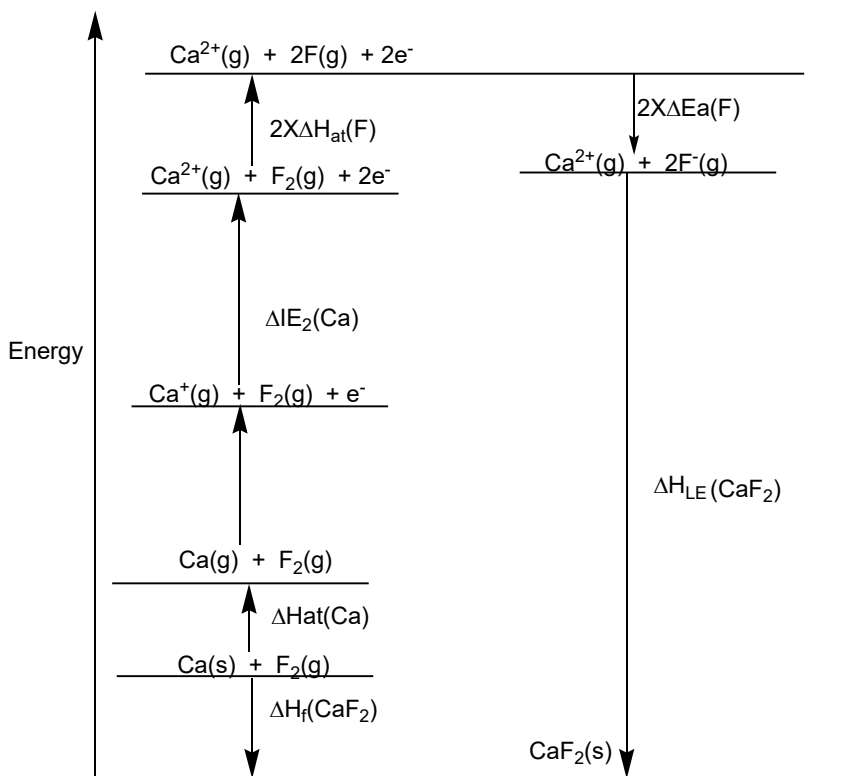

Born-Haber cycle for the formation of aluminium oxide

Lesson 9: Born Haber cycle: Calculations (10 minutes)

a) Prerequisites (10 minutes)

- Students will learn better this lesson if they have a good understanding on Hess's law
- Ask learners to brainstorm and recall the Hess's law and its applications.

b) Teaching resources

Textbooks, hands out about experimental data on applications of the Born-Haber cycle

c) Learning activities (50 minutes)

- The lesson 9 is about the applications of the Born-Haber cycle in the

determination the heat energies involved in the formation of ionic compounds.

- Form groups and provide each group with hands out with problems related to the applications of Born-Haber cycles. Ask them to solve the suggested problems.
- Move around to make sure that all learners actively engaged.
- Call upon three groups to present their findings.

Expected answers to activity 14.9

1. Born-Haber cycle for compound MX

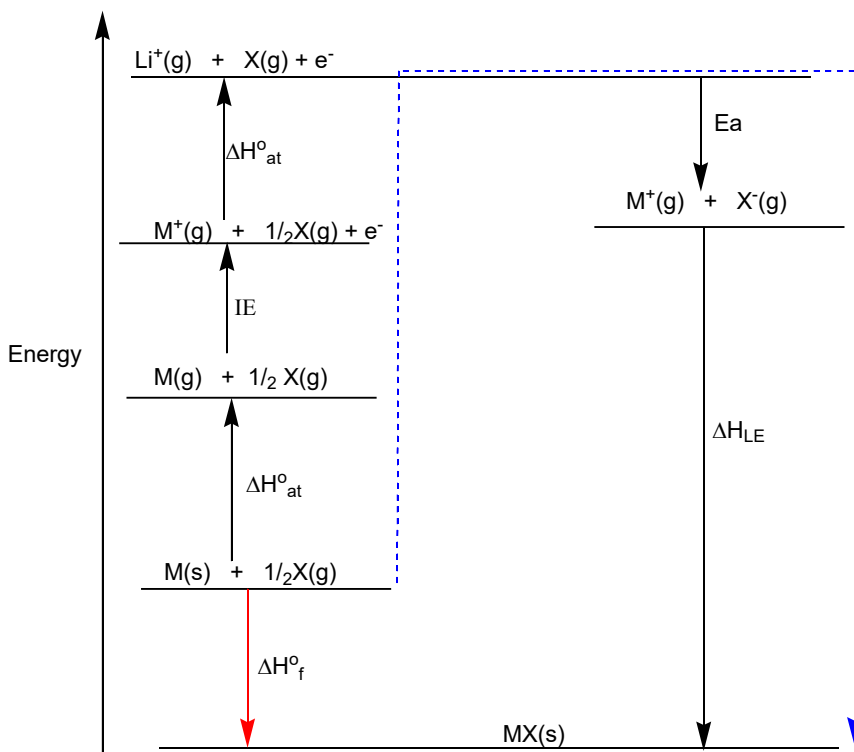

2. The lattice enthalpy of compound MX may be calculated applying the Hess's law and considering the fact that the enthalpy change of the process depicted by the red arrow is equal the sum of enthalpies of the processes depicted by the blue arrow.

Assess the lesson by letting learners to do checking up 14.9

d) Expected answers to checking up 14.9 (20 minutes)

1. Determination of the lattice enthalpy of silver chloride

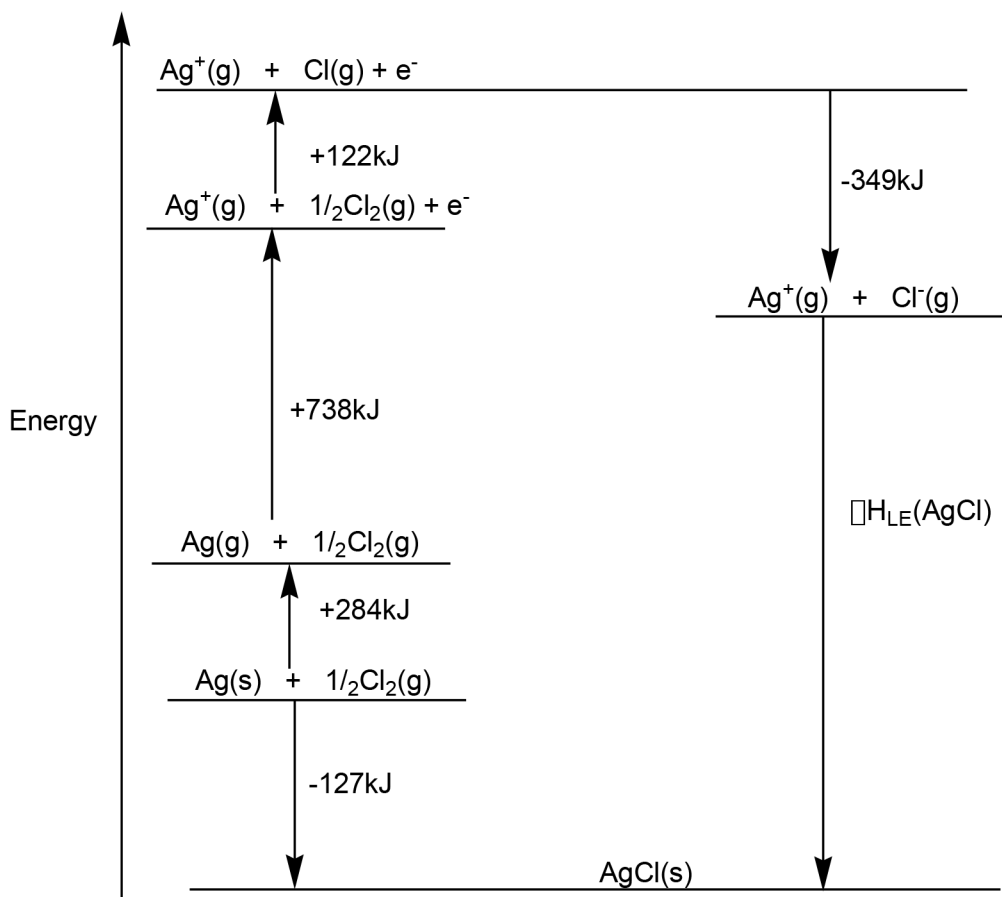

Applying Hess's law

$$\Delta H_f^\circ(\text{AgCl}) = \Delta H^\circ_{\text{at}}(\text{Ag}) + \text{IE}(\text{Ag}) + \Delta H^\circ_{\text{at}}(\text{Cl}_2) + \text{EA}(\text{Cl}) + \Delta H_{\text{LE}}(\text{AgCl})$$

$$-127\text{kJ} = (+284 + 738 + 122 - 349 + \Delta H_{\text{LE}}(\text{AgCl}))\text{kJ}$$

$$\Delta H_{\text{LE}}(\text{AgCl}) = (-127\text{kJ} - 284 - 738 - 122 + 349)\text{kJ} = -922\text{kJ}$$

2. Determination of the second electron affinity of oxygen using the Born-Haber

cycle for magnesium oxide

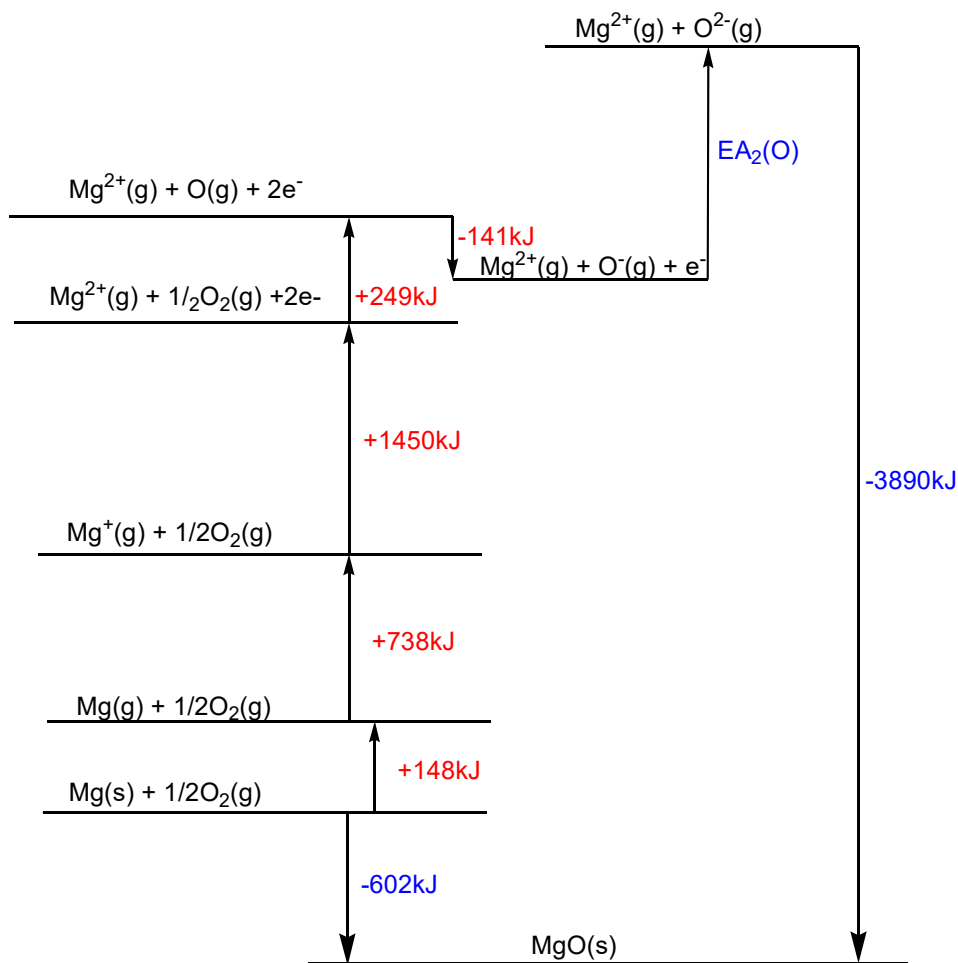

Applying Hess's law:

$$-602\text{kJ} = 148 + 738 + 1450 + 249 - 141 + \text{EA}_2(\text{O}) - 3890\text{kJ}$$

$$\text{EA}_2(\text{O}) = -602\text{kJ} - 148 - 738 - 1450 - 249 + 141 + 3890\text{kJ}$$

$$\text{EA}_2(\text{O}) = +844\text{kJ}$$

Lesson 10: Hydration energy (80 minutes)

a) Prerequisites (5 minutes)

Students will learn better this lesson if they have a good understanding on lattice enthalpy and Hess's cycles (Unit 14, lessons 5 and 7)

Ask learners to brainstorm about the lattice enthalpy and Hess's cycles

b) Teaching resources

Test tubes

Spatula

Distilled water

Sodium chloride

Sodium hydroxide

Potassium bromide

Silver chloride

Sodium carbonate

Potassium hydroxide

Magnesium hydroxide

Magnesium sulphate

Barium hydroxide

Barium sulphate

c) Learning activities (55 minutes)

- The lesson 10 is about the hydration enthalpy.
- Forms groups and let students do activity 14.10
- Provide each group with all requirements for this experiment. These must be available before the lesson.
- Provide learners with the procedure (this could be provided in advance) and explain it.
- Provide each group with a reporting sheet.

- Let learners perform the experiment as described in the procedure.
- Move around to ensure that all learners are actively engaged.
- Every group records their observations and make an interpretation.
- Call upon randomly four groups to share their results
- Let the class evaluate the findings of their colleagues and point out the key ideas about the hydration enthalpy.
- Write a short summary about the hydration enthalpy.

Expected answers to 14.10

See student book

Assess the lesson by allowing learners to do checking up 14.10

d) Answers to checking up ` 14.10 (20 minutes)

Expected answers:

1. Cycle showing enthalpy changes involved in dissolving CaF₂ in water

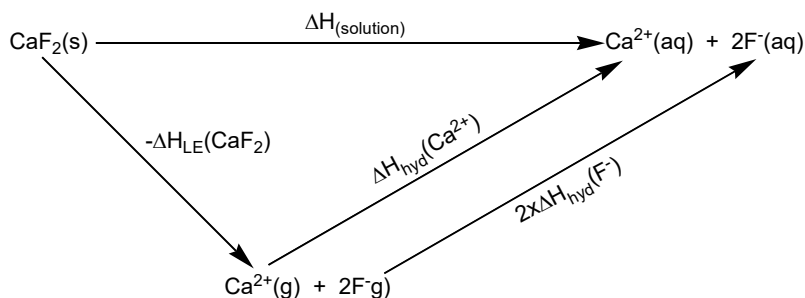

Using Hess's law, $\Delta H_{\text{sol}}(\text{CaF}_2) = \Delta H_{\text{hyd}}(\text{Ca}^{2+}) + 2 \times \Delta H_{\text{hyd}}(\text{F}^-) - \Delta H_{\text{LE}}(\text{CaF}_2)$

The enthalpy of solution is endothermic. Endothermic processes are favoured by an increase in temperature. Thus, the solubility of calcium fluoride will increase with increasing temperature

2. Ion-dipole forces are formed when ions are hydrated. The strength of the ion-dipole forces increases as the size of the ion decreases and as the charge on the ion increases. The three ions have the same charge. The size increases from lithium to potassium and hence the hydration enthalpy decrease from lithium to potassium ion.
3. $\Delta H(\text{sol}) = +905 + (-446) + (-364) = +95 \text{ kJ/mol}$

Lesson 11: Average standard bond enthalpy (80 minutes)

a) Prerequisites (15 minutes)

Students will better learn the concept of average standard bond enthalpy if they have a good understanding on the covalent bonding (Unit 4, senior 4)

Form groups and ask learners to discuss about the strength of the covalent bond.

b) Teaching resources

Textbooks, internet connection, flip charts, chalkboard, and chalks.

c) Learning activities (50 minutes)

- The lesson 11 deals with the average standard bond enthalpy.
- Let students attempt the activity 14.11.
- Allow learners to do their own research using books and discuss freely about the average standard bond enthalpy.
- Ask the representatives of three groups to share their findings and let colleagues assess the relevance of their ideas.
- Conclude by summarising the learners' ideas on the average standard bond enthalpy.

Expected answers to activity 14.11

See student book

Evaluate the understanding of the learners by letting them do checking up 14.11.

d) Checking up 14.11 (5 minutes)

Expected answers

1. a) The mean bond enthalpy is the average bond energy for the same type of bond in a range of different compounds.
b) The Br-Br bond because it has a lower bond dissociation enthalpy.
2. a) C=C because a double bond is globally stronger than a single bond.
b) C=N because a triple bond is globally stronger than a single bond.
c) C=O because a triple bond is globally stronger than a double bond.
d) H-F because fluorine is smaller than chlorine

e) O–H because oxygen is smaller than carbon

f) C–O because oxygen is smaller than nitrogen

Lesson 12: Calculating enthalpy change of reaction using average bond enthalpies (80 minutes)

a) Prerequisites (10 minutes)

Good understanding on the covalent bonding (unit 4, senior 4), enthalpy of reaction (Unit 14, lesson 1, Senior 5)

Form groups and ask learners to discuss about determination of the enthalpy of the reaction using average bond enthalpy values.

b) Teaching resources

Textbooks, hands out about experimental data on applications of the average bond energies

c) Learning activities (50 minutes)

- Form groups and let learners do the activity 14.12
- Monitor the progress of the learners' activity
- Allow four groups to share their ideas.
- Let the learners appreciate the presenter's ideas.
- Summarise their ideas.

Expected answers to activity 14.2

See student book

d) Expected answers to checking up 14.12 (20 minutes)

Expected answers

1. $\Delta H_{rxn} = \sum (\text{mean bond enthalpies of bonds broken}) - \sum (\text{mean bond enthalpies of bonds formed})$

$$\Delta H_{\text{rxn}} = (1454 - 684) \text{ kJ} = + 770 \text{ kJ}$$

Bonds broken	$\Delta H(\text{kJmol}^{-1})$	Bonds formed	$\Delta H(\text{kJmol}^{-1})$
6 x N-H	6 x 391 = 2346	1 x N=N	942
3 x O-Cl	3 x 200 = 600	3 x O-H	3 x 463 = 1389
			3 x 431 = 1293
	2946		3624

$$\Delta H = 2946 \text{ kJ} - 3624 \text{ kJ} = -678 \text{ kJ}$$

14.7. End unit assessment (80 minutes)

Set an assessment questionnaire to be given to the learners. Set integrative questions respecting the blooms taxonomy so that the key unit competency can be fully assessed.

For the detailed questionnaire, see point below.

14.8. Unit summary

The transfer of heat energy from to or chemical reactions plays a vital role in modern society and in living beings. The heat energy change at constant pressure is called **enthalpy change** noted ΔH . The standard enthalpy change for a chemical reaction is the amount of heat exchanged under standard conditions.

The conditions for standard enthalpy changes are: temperature $T = 298\text{K}$, a pressure P equals to one atmosphere, substances in their most stable state under these conditions, concentrations of 1 mol dm^{-3} .

Among the most important enthalpy changes, we distinguish the enthalpy of formation, the enthalpy of combustion, and the lattice enthalpy.

Enthalpy changes values can be determined experimentally by measuring the temperature rise of a known volume of water that is heated by the reaction of a known amount of the reactants.

It takes 4.18 joules of heat energy to increase the temperature of one gram of water by one degree. This value is called "specific heat capacity of water".

Hess's law or law of constant heat summation states that the enthalpy change in a given reaction is independent of the pathway.

Applying Hess' law and energy cycles, the enthalpy change of a reaction can be calculated using the enthalpies of formation, enthalpies of combustion and the mean

bond enthalpies. A definite quantity of energy is associated with each type of bond. That energy is given off when the bond is formed and it is absorbed when the bond is broken.

Bond enthalpies for molecular substances can be compared with lattice enthalpies for ionic compounds.

Born-Haber cycles are based on the Hess's law and are used to calculate the enthalpy values.

The two largest enthalpy changes associated with the formation of an ionic solid is the ionisation enthalpy and the lattice enthalpy.

The enthalpy of solution of an ionic compound can be calculated from the lattice and hydration enthalpies.

14.9. Additional Information

This section provides additional content for the teacher to have a deeper understanding of the topic.

The born-Mayer Equation

The Born-Mayer equation states that the lattice enthalpy is proportional to the product of the charges on each ion, and is inversely proportional to the distance between the centres of the ions. It also includes a factor related to the geometry of the crystal lattice. The equation is:

$$\text{Lattice enthalpy} = \frac{N_A M z^+ z^- e^2}{4\pi\epsilon_0 r} \left(1 - \frac{p}{r}\right)$$

Where

NA is the Avogadro constant, 6.02214×10^{23}

M is the Madelung constant which depend on the geometry of the crystalline lattice.

z^+ is the number of charges on each positive ion

z^- is the number of charges on each positive ion

e is the charge on the electron, 1.602177×10^{-19} C

r is the cation-anion internuclear distance

p is a constant that takes into account of the repulsion between the electron shells of adjacent ions.

ϵ_0 is a constant which called the permittivity of space which governs the strength of electrostatic forces; in the vacuum permittivity (electric constant) is equal to

$8.85419 \times 10^{-12} \text{Fm}^{-1}$ (farads per metre)

The estimation of the lattice enthalpy in this way is based on the coulombic forces and assumes the bonding in the lattice is 100% ionic.

For many ionic compounds, the lattice enthalpy determined from experimental data values via a Born-Haber cycle agrees extremely well with that calculated by the Born-Mayer expression, giving further confirmation of the correctness of the ionic model.

14.10. End unit assessment

Standard of performance:

Correctly construct energy cycles, calculate enthalpies of reaction and design an experimental procedure to verify the enthalpy changes in a chemical reaction

Answers to end unit questions:

1) a) Enthalpy change, heat energy exchange at constant pressure.

b) **Standard enthalpy change of reaction**, heat energy exchanged (absorbed or released) during a chemical reaction under standard conditions. For example if we consider the reaction:

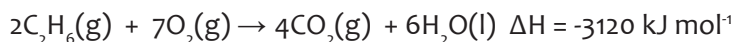

$-3120 \text{ kJ mol}^{-1}$ represents the enthalpy of the reaction.

b) The standard enthalpy of combustion is the heat released when one mole of a substance undergoes a complete combustion in excess oxygen under standard conditions. Therefore $-3120 \text{ kJ mol}^{-1}$ does not represent the standard enthalpy of combustion of ethane because two moles are involved in the reaction

2) a) $\Delta T = 3.2$

$$\text{Moles} = 50 \times 10^{-3} \text{ dm}^3 \times 0.5 \text{ mol dm}^{-3} = 2.5 \times 10^{-2} \text{ mol}$$

$$q = m \times C_s \times \Delta T = 100 \text{ g} \times 4.15 \text{ J g}^{-1} \text{ C}^{-1} = 1337.04 \text{ J} = 1.3376 \text{ kJ}$$

$$\text{b) } \Delta H = \frac{1.3376 \text{ kJ}}{2.5 \times 10^{-2} \text{ mol}} = 53.504 \text{ kJ mol}^{-1}$$

3) Amount of heat used = $-2202 \text{ kJ} \times 0.015 \text{ mol} = -33.03 \text{ kJ}$ or $33,030 \text{ J}$

$$q = m \times C_s \times \Delta T$$

$$33,030\text{J} = 200\text{g} \times 4.18\text{Jg}^{-1} \times \Delta T$$

$$\Delta T = \frac{33,030\text{J}}{200\text{g} \times 4.18\text{Jg}^{-1}\text{K}^{-1}} = 39.51\text{K}$$

$$4) \Delta T = 28.2^\circ\text{C} - 21.5^\circ\text{C} = 6.7^\circ\text{C}$$

$$q = m \times C_s \times \Delta T = 50\text{g} \times 4.18\text{Jg}^{-1}\text{C}^{-1} \times 6.7^\circ\text{C} = 1400.3\text{J}$$

$$\text{Moles} = 25 \times 10^{-3}\text{dm}^3 \times 1\text{mol dm}^{-3} = 25 \times 10^{-3}\text{mol}$$

$$\Delta H = \frac{1400,3\text{J}}{25 \times 10^{-3}\text{mol}} = 56,012\text{J} \text{ or } 56.012\text{kJ}$$

5) a) Excess zinc was used to make sure that all the copper sulphate reacted

$$b) q = m \times C_s \times \Delta T = 25 \times 4.18 \times 21 = 2195.5\text{J}$$

$$c) \text{Moles of CuSO}_4 \text{ used} = 25 \times 10^{-3}\text{dm}^3 \times 0.5\text{mol dm}^{-3} = 0.0125\text{mol}$$

$$d) \text{Molar enthalpy} = \frac{2195.5\text{J}}{0.0125\text{mol}} = -175560\text{J} = -175.56\text{kJ}$$

e) Source of error: heat loss

Proposals for reducing that error:

Use of a lid on the calorimeter

wrap the calorimeter

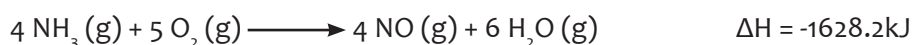
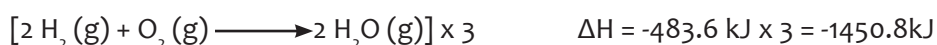
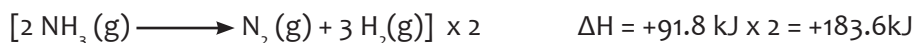
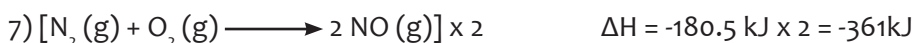
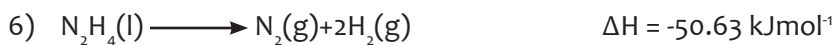

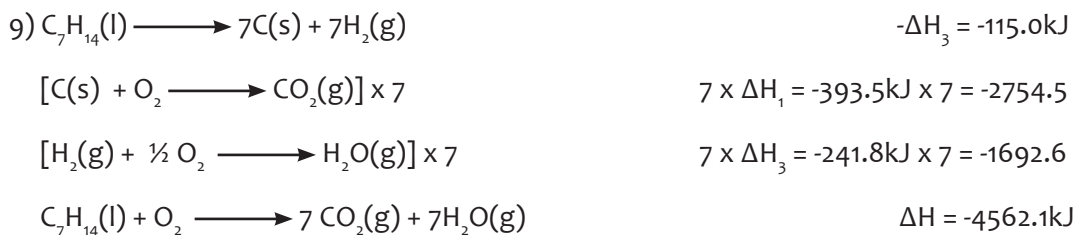
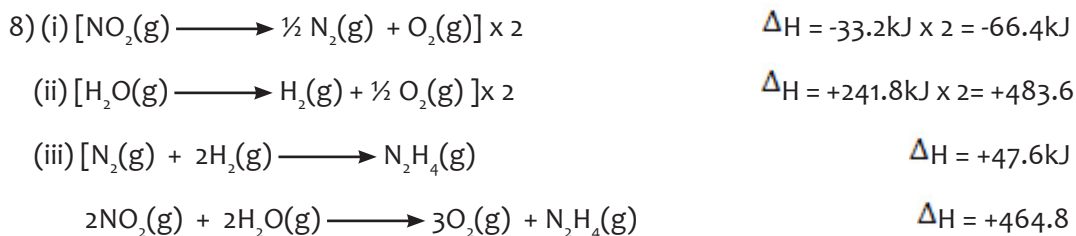

10) a) Born Haber cycles for Mg^+O^- and $\text{Mg}^{2+}\text{O}^{2-}$

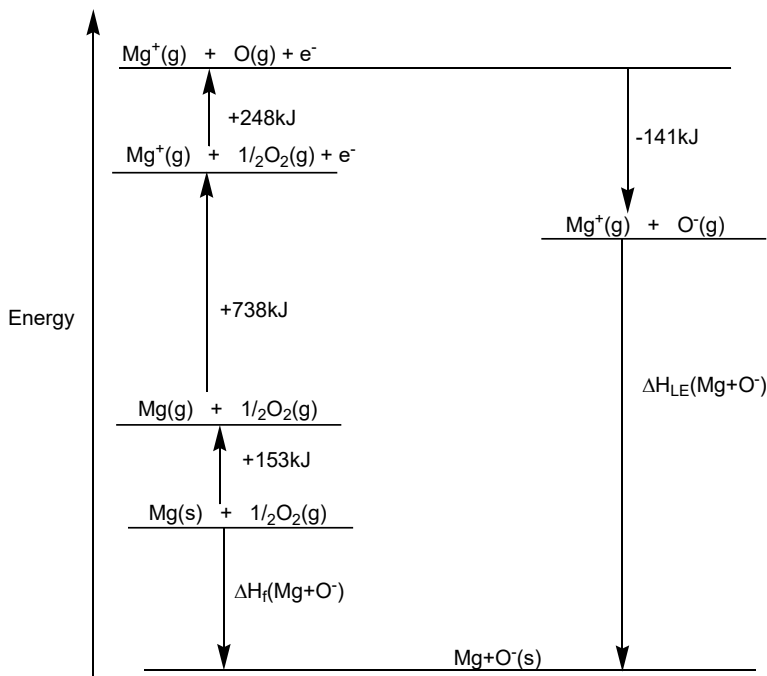

$$\Delta H_f(\text{Mg}^+\text{O}^-) = 153 + 738 + 248 + (-141) + (-1246) = -248\text{kJ}$$

b) $\text{Mg}^{2+}\text{O}^{2-}$ is more stable than Mg^+O^- because it has a higher lattice enthalpy.

11) a) Part of the carbon monoxide is transformed into carbon dioxide which is more stable.

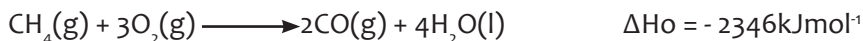
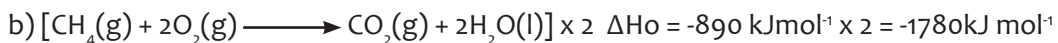

12) a) $\Delta H_{\text{r}} = 2 \times \Delta H_{\text{f}}(\text{CO}_2) + 3 \times \Delta H_{\text{f}}(\text{H}_2\text{O}) - \Delta H_{\text{f}}(\text{C}_2\text{H}_6)$

$$\Delta H_{\text{r}} = 2 \times (-394) + 3 \times (-286) - (-85) = -1731 \text{ kJmol}^{-1}$$

b) $\Delta H_{\text{r}} = 2 \times \Delta H_{\text{f}}(\text{CO}_2) + 3 \times \Delta H_{\text{f}}(\text{H}_2\text{O}) - \Delta H_{\text{f}}(\text{C}_2\text{H}_6\text{O})$

$$\Delta H_{\text{r}} = 2 \times (-394) + 3 \times (-286) - (-278) = -1922 \text{ kJmol}^{-1}$$

c) $\Delta H_{\text{r}} = 8 \times \Delta H_{\text{f}}(\text{CO}_2) + 9 \times \Delta H_{\text{f}}(\text{H}_2\text{O}) - \Delta H_{\text{f}}(\text{C}_8\text{H}_{18})$

$$\Delta H_{\text{r}} = 8 \times (-394) + 9 \times (-242) - (-210) = -5540 \text{ kJmol}^{-1}$$

13)

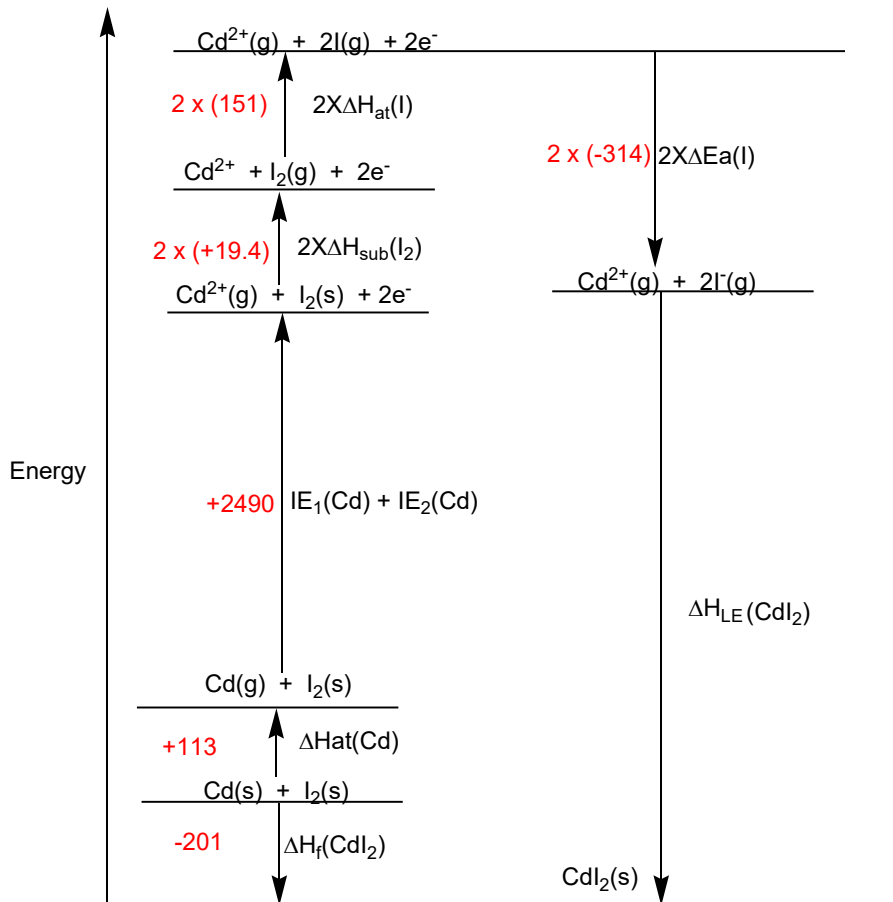

$$\Delta H_{LE} = \Delta H_f(\text{CdI}_2) - (\Delta H_{at}(\text{Cd}) + \text{IE}_1(\text{Cd}) + \text{IE}_2(\text{Cd}) + 2x\Delta H_{\text{sub}}(\text{I}_2) + 2x\Delta H_{at}(\text{I}_2) + 2x\text{EA}_1(\text{I}_2))$$

$$\Delta H_{LE} = -201 - (+113 + 2490 + 38.8 + 302 + (-628)) = -2516.8 \text{ kJ mol}^{-1}$$

14) a) See student book

b) Refer to the Born-Haber cycle for lithium fluoride

c) (i) Ions are maintained together by strong electrostatic forces.

(ii) The strength of the lattices increases as the size of ions decreases.

(iii) It has some covalent character.

(iv) Hydration enthalpy decreases as the size increases. From $\text{Be}(\text{OH})_2$ to $\text{Ba}(\text{OH})_2$, the lattice enthalpy decreases more rapidly than the hydration enthalpy.

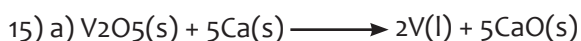

$$\Delta H_f^\circ = 5 \times (-635) + 2 \times (+23) - (-1551) = -1578 \text{ kJ mol}^{-1}$$

b) Solid calcium is in its most stable state under standard conditions, but liquid vanadium is not.



Bonds broken	ΔH	Bonds formed	ΔH
4 x C-C	4 x 348 = 1,392	10 x C=O	10 x 743 = 7,430
12 x C-H	12 x 412 = 4,944	12 x H-O	10 x 463 = 4,630
8 x O=O	8 x 496 = 3,968		
Total	10,304	Total	12,060

$$\Delta H_r = 10,340\text{kJ} - 12,060 = -1720\text{kJmol}^{-1}$$

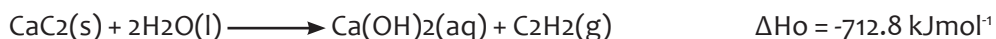
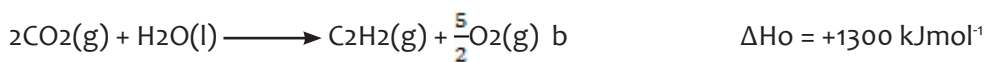
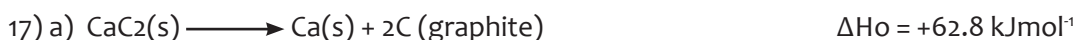

b) (i) -1

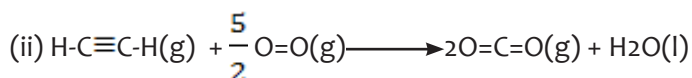

Bonds broken	$\Delta H(\text{kJmol}^{-1})$	Bonds formed	$\Delta H(\text{kJmol}^{-1})$
$C \equiv C$	835	4 x C=O	4 x 799 = 3196
2 x C-H	2 x 413 = 826	2 x O-H	2 x 463 = 926
$\frac{5}{2} \times O=O$	$\frac{5}{2} \times 498 = 1245$		
Total	2906		4122

$$\Delta H = -1216\text{kJmol}^{-1}$$

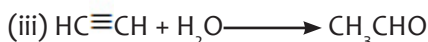
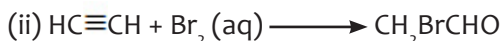
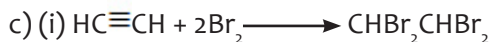

(iv) Aldehydes

(v) Hess's cycle illustrating the reaction in (i) above

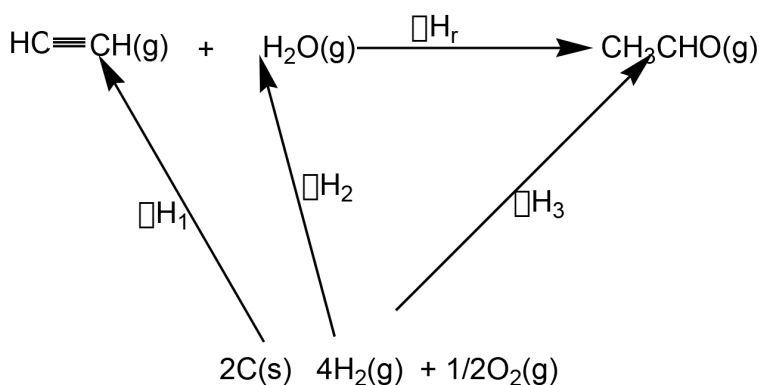

$$\Delta H_1 + \Delta H_2 + \Delta H_r = \Delta H_3$$

$$\Delta H_r = \Delta H_3 - \Delta H_1 - \Delta H_2 = -187 - (+227) - (-286) = -128 \text{ kJ}$$

14.11. Additional activities

a) Remedial Activities:

- When 50cm^3 of 0.10M sodium hydroxide is added to 50cm^3 of 0.10M hydrochloric acid, the temperature of the mixture increases by 11.6K . Calculate the heat change of the reaction that occurs.

Data: Specific heat capacity of the Solution $4.18\text{Jg}^{-1}\text{K}^{-1}$.

Density of the solution $= 1.18\text{gcm}^{-3}$.

Answer

$$Q = m \times C \times T = 118 \times 4.18 \times 11.6 = 5721.584\text{J} = 5.722\text{kJ}$$

- Given the definition of the standard enthalpy of formation for a substance, write an equation for the reaction for the formation of KBr , $\text{C}_6\text{H}_{12}\text{O}_6$, HNO_3 .
 - Calculate the enthalpy of each of the following reactions using the data provided

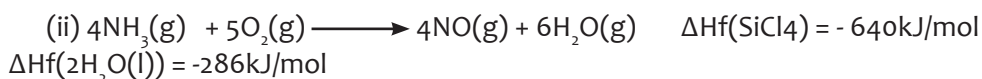

$$\Delta H_f(\text{SiO}_2) = -911\text{kJ} \quad \Delta H_f(\text{HCl}) = -167\text{kJ/mol}$$

$$\Delta H_f(\text{NH}_3) = -96\text{kJ/mol} \quad \Delta H_f(\text{NO}) = -90.4\text{kJ} \quad \Delta H_f(2\text{H}_2\text{O}(g)) = -242\text{kJ}$$

Answer

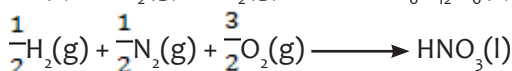
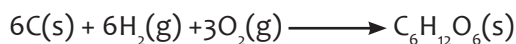
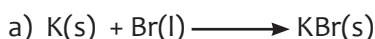

$$\Delta H_r = -911 + 4 \times (-167) - 2 \times (-286) - (-640) = -367\text{kJmol}^{-1}$$

$$(ii) \Delta H_r = 4 \times \Delta H_f(\text{NO}) + 6 \times \Delta H_f(2\text{H}_2\text{O}(g)) - 4 \times \Delta H_f(\text{NH}_3)$$

$$\Delta H_r = 4 \times (-90.4) + 6 \times (-284) - 4 \times (-96) = -1636.6 \text{ kJmol}^{-1}$$

3. Ethanoic acid (CH_3COOH) cannot be prepared directly from its elements and so the standard enthalpy change of formation of ethanoic acid must be obtained indirectly.

a) Define the terms: enthalpy change of formation, enthalpy change of combustion

b) Write an equation for the formation of ethanoic acid from its elements in their standard states.

c) Draw an energy cycle linking the enthalpy change of formation of ethanoic acid with its enthalpy change of combustion and the enthalpy changes of combustion of its constituent elements.

d) Calculate the enthalpy of formation of ethanoic acid using the following data.

$$\text{Combustion enthalpy of carbon graphite} = -393\text{kJ/mol}$$

$$\text{Combustion enthalpy of hydrogen} = -286\text{kJ/mol}$$

$$\text{Combustion enthalpy of ethanoic acid} = -876\text{kJ/mol}$$

Answer

a) See student book

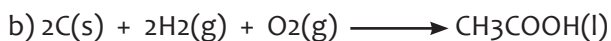

c) Hess's Cycle for the formation of ethanoic acid

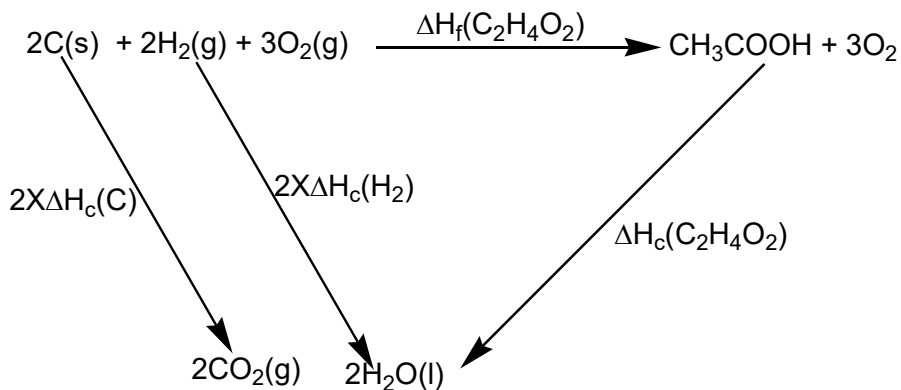

$$d) \Delta H_f(\text{C}_2\text{H}_4\text{O}_2) + \Delta H_c(\text{C}_2\text{H}_4\text{O}_2) = 2 \times \Delta H_c(\text{C}) + 2 \times \Delta H_c(\text{H}_2)$$

$$\Delta H_f(\text{C}_2\text{H}_4\text{O}_2) = 2 \times \Delta H_c(\text{C}) + 2 \times \Delta H_c(\text{H}_2) - \Delta H_c(\text{C}_2\text{H}_4\text{O}_2)$$

$$\Delta H_f(\text{C}_2\text{H}_4\text{O}_2) = 2 \times (-393) + 2 \times (-286) - (-876) = -482 \text{ kJ mol}^{-1}$$

4. Calculate the enthalpy change for the reaction:

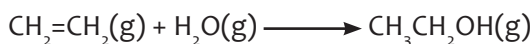

Given the following average bond enthalpies in kJ mol^{-1} :

C-C : 348; C=C: 612; C-H: 412; O-H: 463; C-O :360

Answer

Bonds broken	ΔH	Bonds formed	ΔH
1 x C=C	1 x 612	1 x C-C	1 x 348
1 x H-O	1 x 463	1 x C-H	1 x 412
		1 x C-O	1 x 360
Total	1075		1120

$$\Delta H_r = 1075 - 1120 = -45 \text{ kJ mol}^{-1}$$

5. Construct a Born-Haber cycle for rubidium chloride and use the following data to calculate the lattice enthalpy of rubidium chloride.

Answer

a) Born-Haber cycle for rubidium chloride

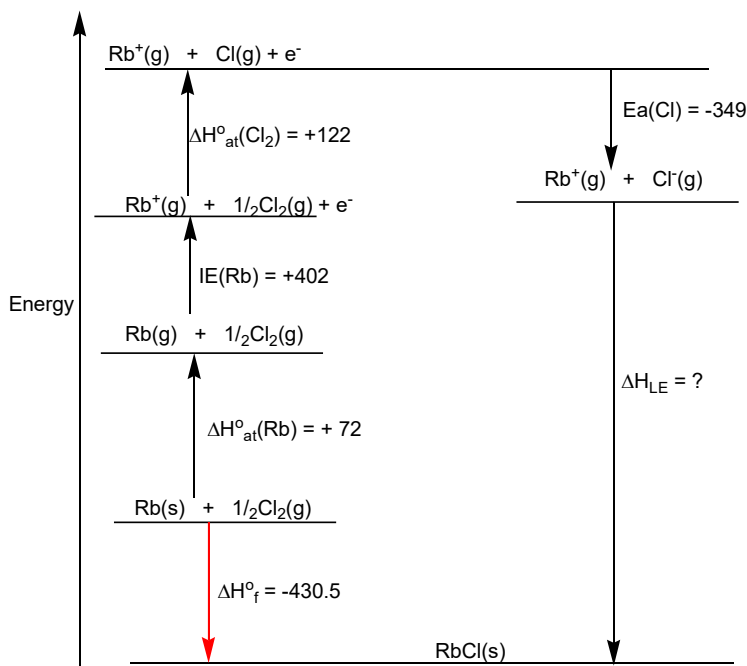

b) Lattice enthalpy of rubidium chloride

According to Hess's law,

$$\Delta H^{\circ} = \Delta H^{\circ}_{\text{at}}(\text{Rb}) + \text{IE}(\text{Rb}) + \Delta H^{\circ}_{\text{at}}(\text{Cl}_2) + \text{EA}(\text{Cl}) + \Delta H_{\text{LE}}$$

$$-430.5 \text{ kJ} = 72 \text{ kJ} + 402 \text{ kJ} + 122 \text{ kJ} - 349 \text{ kJ} + \Delta H_{\text{LE}}$$

$$\Delta H_{\text{LE}} = -430.5 \text{ kJ} - 72 \text{ kJ} - 402 \text{ kJ} - 122 \text{ kJ} + 349 \text{ kJ}$$

$$\Delta H_{\text{lattice}} = -677.5 \text{ kJ}$$

c) Consolidation activities:

- 100 cm³ of 1M sodium hydroxide solution and 100 cm³ of 1M ethanoic acid were mixed in a calorimeter. All three were at the same temperature. The rise in temperature was 5.9K. Calculate the standard enthalpy of neutralisation. Assume that no heat passes to the calorimeter.

Answer

$$q = m \times C \times T\Delta$$

$$q = 100\text{g} \times 4.18\text{J/g}\cdot\text{K} \times 5.9\text{K} = 4,932.4\text{J}$$

$$\text{Moles of NaOH} = 100 \times 10^{-3}\text{dm}^3 \times 1\text{mol dm}^{-3} = 0.1\text{mol}$$

$$\text{Molar enthalpy of neutralisation} = \frac{4,932.4\text{J}}{0.1\text{mol}} = 49,324\text{J} = 49.324\text{kJ mol}^{-1}$$

2. a) Construct a Born-Haber cycle for sodium sulphide.

b) Use the following data and calculate the lattice enthalpy of sodium sulphide

Atomisation enthalpy of sodium = 107.3kJ mol^{-1}

Atomisation enthalpy of sulphur: $+278.5$

First ionisation energy of sodium: $+496.0$

First electron affinity of sulphur: -200.4

Second electron affinity of sulphur: $+610.0$

Formation enthalpy of sodium sulphide: -364.8

Answer

a) Born-Haber cycle for sodium sulphide

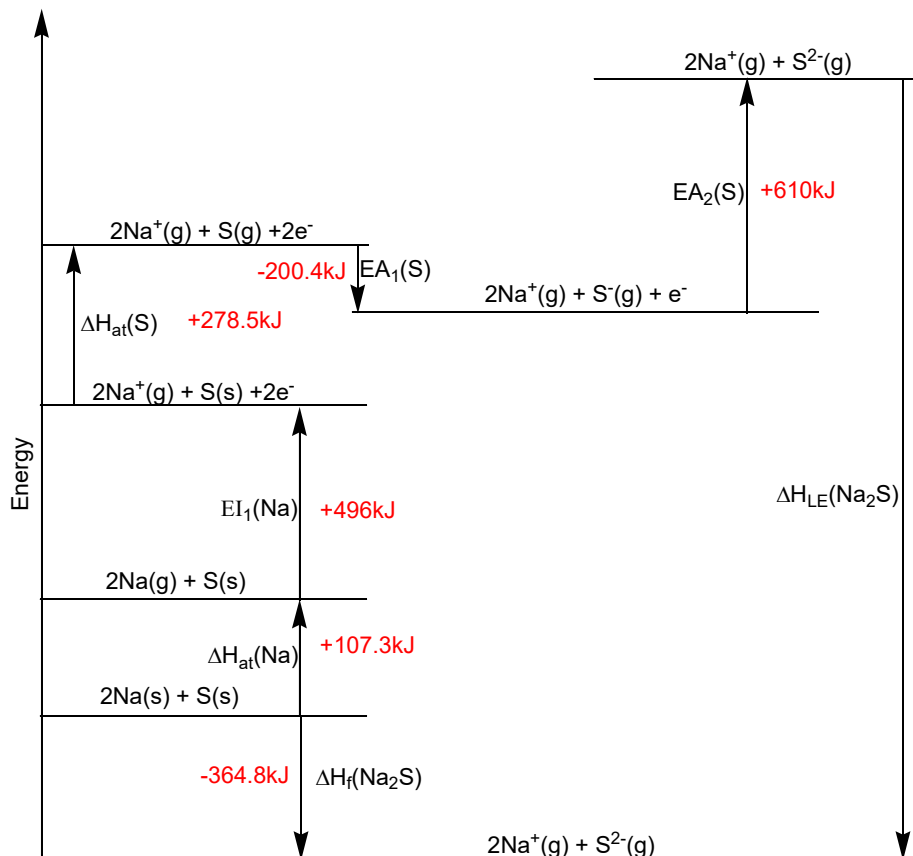

b) $\text{HLE}(\text{Na}_2\text{S}) = -1656.2\text{kJmol}^{-1}$

3. The standard enthalpies of combustion for phosphorus, hydrogen and phosphine (PH_3) are -753 , -286 , -1290kJmol^{-1} respectively. Calculate the enthalpy of formation of phosphine.

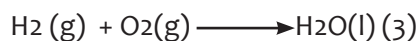
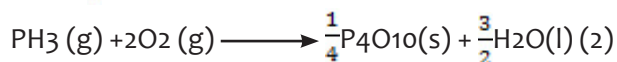
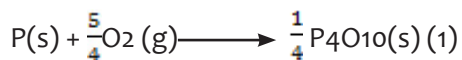

Answer

Phosphorus is a reactant, write equation (1)

Phosphine is a product; so, reverse equation (2)

Hydrogen is a reactant. So, write equation (3). However, moles of water are formed, thus, multiply by 3 all coefficients in equation (3)

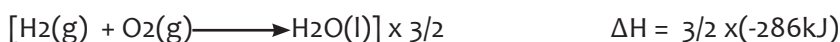
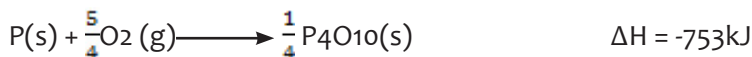

4. a) Write an equation for the reaction between propanone and hydrogen cyanide and give the systematic name of the organic product.
- b) What type of reaction is this and what is the catalyst that is used?
- c) Use the following data about the bond energies (in kJ/mol) and estimate the enthalpy of the reaction above.

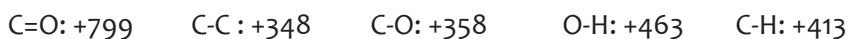

- d) Is the process endothermic or exothermic?

Answer

- a) Equation of the reaction

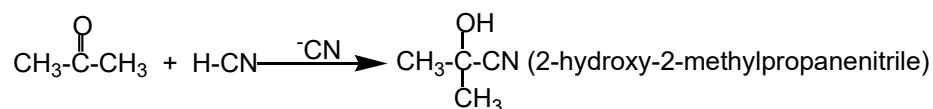

- b) It is a nucleophilic addition. The catalyst is cyanide ion.
- c) Enthalpy of the reaction

Bonds broken	$\Delta\text{H}/\text{kJmol}^{-1}$	Bonds formed	$\Delta\text{H}/\Delta\text{H}/\text{kJmol}^{-1}$
1 x C=O	799	1 x C-C	348
1 x C-H	413	1 x C-O	358
		1 x O-H	463
Total	1212		1169

$$\Delta H = 1212\text{kJ} - 1169\text{kJ} = + 43\text{kJmol}^{-1}$$

d) Endothermic because it require 43kJ per mol to proceed.

d) Extended activities:

1. In an experiment to determine the enthalpy of neutralization of an acid, HX, a student placed 50cm³ of 1M NaOH in a polystyrene cup and recorded the temperature every minute for three minutes. At the fourth minute the student added 50cm³ of a 1M HX. The student stirred the mixture and recorded the temperature at the fifth minute and every minute for the next five minutes. The results are shown in the table below:

Time	1	2	3	4	5	6	7	8	9	10
Temperature/oC	19.0	19.0	19.0	-	25.1	24.5	23.7	23.5	23.1	22.7

The equation of the reaction is: $\text{HX (aq)} + \text{NaOH (aq)} \longrightarrow \text{NaX (aq)} + \text{H}_2\text{O(l)}$

- a) Explain why the mixture was stirred at regular intervals.
- b) Plot a cooling curve from the data in the table.
- c) From your cooling curve, calculate the theoretical temperature rise at the fourth minute.
- d) Calculate the heat energy released in the reaction.
- e) Calculate the moles of acid, HX, neutralized in the reaction.
- f) Hence calculate the enthalpy of neutralization per mole of acid

Solution

- a) The mixture was stirred at regular intervals to make uniform the temperature throughout the solution

b) Cooling curve

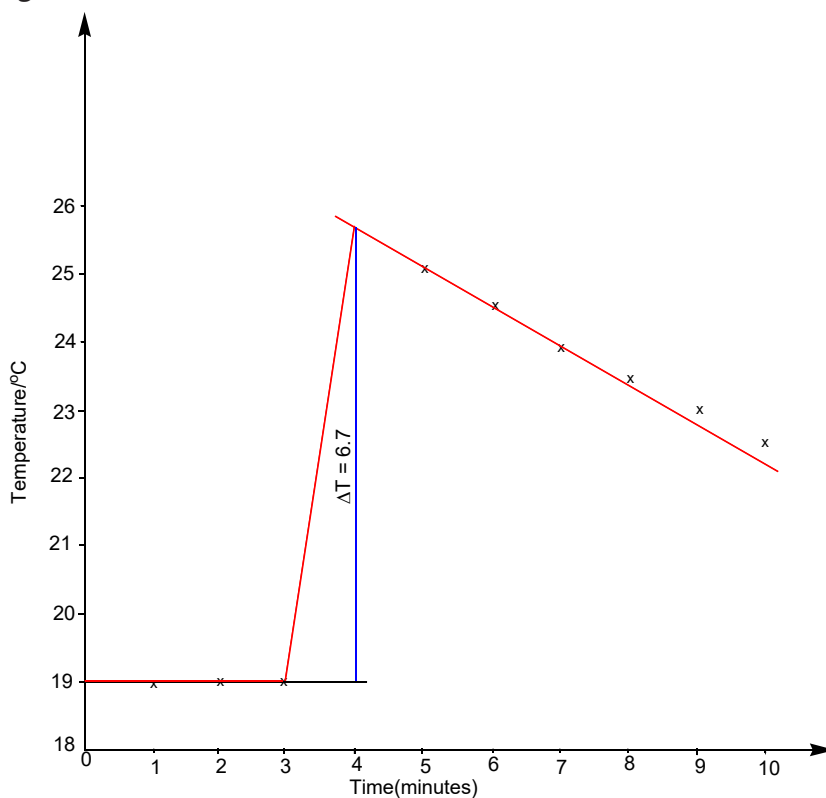

c) From the cooling curve, $T = 6.7^{\circ}\text{C}$.

d) Heat energy is released, $q = m \times C_s \times \Delta T = 100 \times 4.18 \times 6.7 = 2800.6\text{J}$

e) Moles of the acid reacted = $50 \times 10^{-3}\text{dm}^3 \times 1\text{mol dm}^{-3} = 0.05\text{mol}$

f) Molar enthalpy = $\frac{2800.6\text{J}}{0.05\text{mol}} = -56012\text{J} = -56.012\text{kJ}$

2. Values of average standard bond enthalpies/ kJ mol^{-1} are: C-C = 348, C=C = 612, C-H = 413, H-H = 436. Standard enthalpy of atomization of carbon = 715.

Use these values to calculate the standard enthalpy changes of the following reactions:

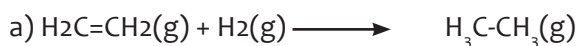

d) Comment on whether you would choose b) or c) as a method of making cyclobutane.

- e) The average standard C-C bond enthalpy in cyclobutane is in fact 320kJmol⁻¹. Suggest why it is smaller than the usual value for C-C of 348 kJmol⁻¹.

Answer

- a) Enthalpy of hydrogenation of ethene

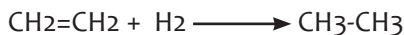

Bonds broken	ΔH	Bonds formed	ΔH
C=C	612	C-C	348
H-H	436	2xC-H	2x413
	1048		1174

$\Delta H_{\text{rxn}} = \sum (\text{mean bond enthalpies of bonds broken}) - \sum (\text{mean bond enthalpies of bonds formed})$

$$\Delta H_{\text{rxn}} = 1048 - 1174 = -126 \text{ kJ/mol}$$

- b) Formation of cyclobutane from ethene

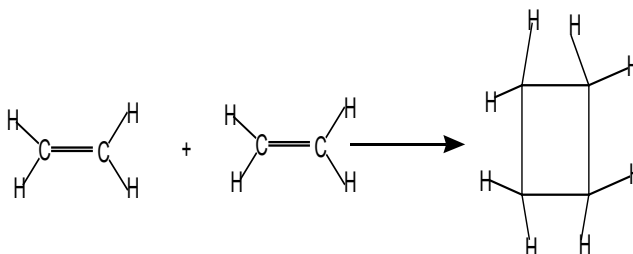
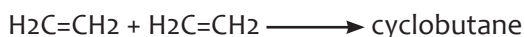

Bonds broken	ΔH	Bonds formed	ΔH
C=C	2x612	4xC-C	4x348
	1224		1392

$\Delta H_{\text{rxn}} = \sum (\text{mean bond enthalpies of bonds broken}) - \sum (\text{mean bond enthalpies of bonds formed})$

$$\Delta H_{\text{rxn}} = 1224 - 1392 = -168 \text{ kJ/mol}$$

c) Formation of cyclobutane from carbon and hydrogen

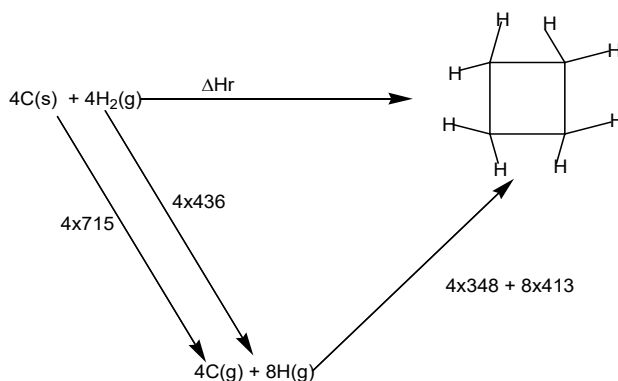

Bonds broken	ΔH	Bonds formed	ΔH
4xAtomisation of C	4x715	4xC-C	4x348
4xH-H	4x436	8xC-H	8x413
	4604		4696

$\Delta H_{\text{rxn}} = \sum (\text{mean bond enthalpies of bonds broken}) - \sum (\text{mean bond enthalpies of bonds formed})$

$$\Delta H_{\text{rxn}} = 4604 - 4696 = -92 \text{ kJ/mol}$$

c) The best method to be chosen is b) because it is more thermodynamically stable as it releases more energy.

d) The cyclobutane is a stretched cycle, thus, the C-C is less stable the one in open structures or less stretched cycle. Therefore it requires less energy to break that C-C bond.

3. Burning magnesium in air forms magnesium oxide, but some magnesium nitride is also produced from the nitrogen in the air. Use the Born-Haber cycle and the information below to calculate the enthalpy of formation, ΔH_f° of magnesium oxide.

Sublimation enthalpy of magnesium; $+148 \text{ kJ mol}^{-1}$

First ionisation energy of magnesium: $+738 \text{ kJ mol}^{-1}$

Second ionisation energy of magnesium: $+1452 \text{ kJ mol}^{-1}$

Atomisation enthalpy of nitrogen: $+473 \text{ kJ mol}^{-1}$

First electron affinity of nitrogen: -7 kJ mol^{-1}

Second electron affinity of nitrogen: + 801kJ mol⁻¹

Third electron affinity of nitrogen: + 1293kJ mol⁻¹

Lattice enthalpy of magnesium nitride: -12,682kJmol⁻¹

Answer

a) Born-Haber cycle for magnesium nitride

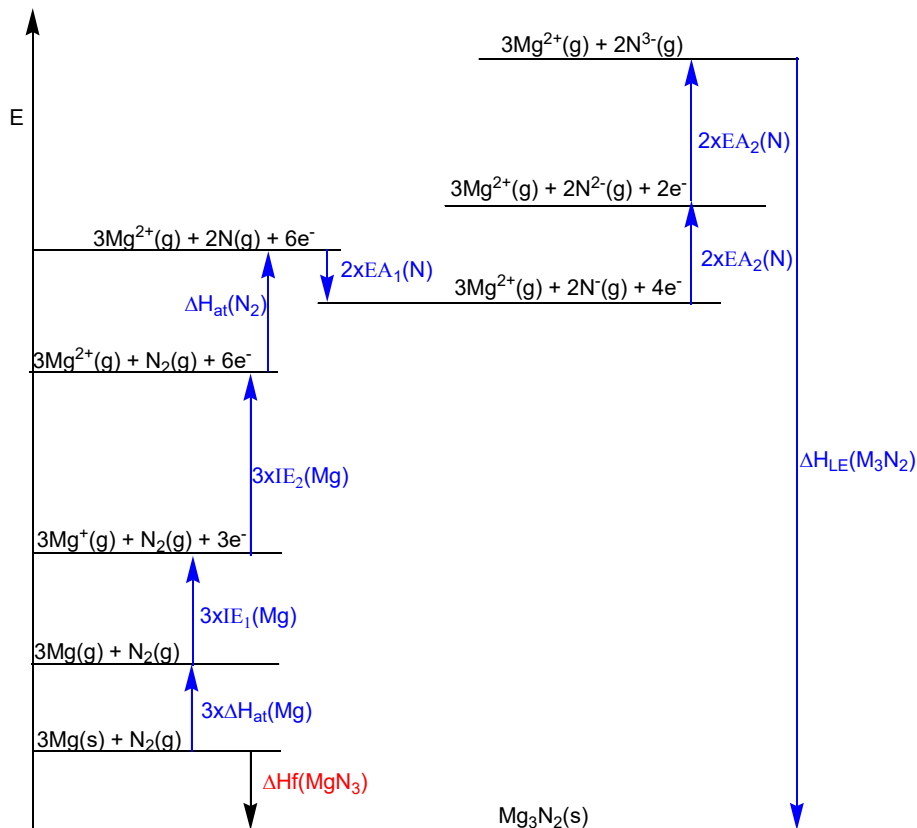

b) Applying Hess's law

$$\Delta H_f^\circ = 3 \times 148 + 3 \times 738 + 3 \times 1451 + 2 \times 473 + 2 \times 473 + 2 \times (-7) + 2 \times 801 + 2 \times 1293 - 12682$$

$$\Delta H_f^\circ = -551 \text{ kJ mol}^{-1}$$

UNIT 15: ENTROPY AND FREE ENERGY

15

15.1. Key unit competency:

Predict the feasibility of chemical reactions.

15. 2. Prerequisite (knowledge, skills, attitudes and values)

Students will learn better the introduction to organic chemistry if they have understanding on:

Thermodynamics and thermochemistry, heat and temperature of the reaction.

15. 3. Cross-cutting issues to be addressed

a) Inclusive education:

- This unit involves a number of experiment to be carried out and the which will challenge the students with visual difficulties
- **Grouping students.** Students with special educational needs are grouped with others and assigned roles basing on individual student's abilities.
- If a teacher has students with visual difficulties, when writing on the blackboard, write in large, clear writing, especially when it comes to formulae. Read out what you are writing, for the benefit of those who are not able to see the blackboard clearly.
- If learners are sharing textbooks, try to arrange for those with visual difficulties to have their own copies, as far as this is possible.
- Give extra time for them to write summary notes or write down observations after experiments.
- Every important point is written and spoken.
- Remember to repeat the main points of the lessons.
- For students with visual impairment teacher can write of them a summary using the braille alphabet if possible.
- For learners with **hearing difficulties**, the teacher has to encourage them to sit closer to the front of the classroom. Stop every so often while teaching to ask learners whether they have understood, or if they need

you to repeat a point. Encourage learners not to be afraid to ask questions. When teaching, speak clearly and ensure that all the learners can hear your voice. Avoid speaking hurriedly as this will make it difficult for learners with hearing difficulties to make sense of what you are saying.

Learners with mobility difficulties:

- These include learners in crutches, wheelchairs, or with walking difficulties. Encourage other learners to look out for and help their classmates. Ask their fellow learners to help them with their notes, if their conditions hinder them from writing well.

Learners with reading difficulties:

- Learners with this kind of difficulties struggle to make sense of words or understand written work and take longer to read than other learners. Encourage them to pay careful attention during class time and participate for example by asking questions, answering questions, so that they can make the most of what they hear and observe. Instead of repeating word for word what is in the textbook, simplify the concepts to ease their understanding, so that when they have already understood.

b) Gender:

During group activities try to form heterogeneous groups (with boys and girls) or when students start to present their findings encourage both (boys and girls) to present the findings.

d) Peace and values education:

During group activities, the teacher will encourage learners to help each other and to respect opinions of colleagues.

15. 4. Guidance on the introductory activity

- For this activity, the teacher forms groups of six students that are as heterogeneous as possible.
- He/she give them playing cards and each group will be given the 36 playing cards
- The teacher will tell them to open the box and start playing
- The teacher will moderate the activity and hence to be sure that they tose the cards before playing.

- The teacher asks for each group to answer to the questions of the introductory activities in their groups.
- The groups will present their answers. (group by group)
- After presentation, the teacher decides to engage the class into exploitation of the students' answers.
- After presentation the teacher asks the students to judge findings from different groups and harmonise their work.
- The teacher summarises their findings and introduce the new unit

Answers to the introductory activity

See student book

15.5. List of lessons (including assessment).

#	Lesson title	Learning objectives	Number of periods
1	Definition of entropy and change in entropy	Explain the term Entropy and Relate the entropy changes to the changes in degree of disorder	2
2	Second law of thermodynamics	State the second law of thermodynamics.	2
3	Free energy	State if the value of free energy for a reaction will be positive or negative.	2
4	Relationship between free energy, enthalpy and entropy	State if the value of free energy for a reaction will be positive or negative.	2
5	Summative assessment		2

15. 6. Guidance on different lessons

Lesson 1: Definition of entropy and change in entropy (80 minutes)

This is the first lesson of unit 15 and is a single lesson. That is to say it has only one period (80 minutes). The first lesson also covers the introduction of the whole unit.

a) Prerequisites (10minutes)

Students will learn better the entropy and entropy change if they have understanding on: The concept thermodynamics and thermochemistry, and the understanding on the concept of heat and temperature.

b) Teaching resources

Use playing cards and the heat source and some chemical in laboratory, use charts in order to show the drawings, calculators and other materials.

c) Learning activities

Before introducing to start the lesson, you will have to introduce the whole unit. Let learners therefore attempt activity 15.1 which leads students to the first lesson of the unit.

d) Methodological steps

As a facilitator, the teacher will give the student the materials (beakers and the water molecule in different states means in solid, and liquid into their different groups and tell them to carry out the experiment 15.1 and answer to the questions related with that activity.

After the presentation, the teacher will add the additional information and calculation by showing the student how to calculate the entropy of reaction. And the degree of randomness of a substance.

Activity 15.1.

Expected answers:

- a) the beaker C is where the molecules move faster because it is gas
- b) In beaker A the molecules move slowly.
- c) C, B, A
- d) The mobility of molecules in beaker A is too slow because the container is ice, and the mobility of molecules is too less because they are more closer
- The mobility of molecules in beaker B is mediate because the container is liquid water, and the mobility of molecules is mediated because they are freely to move but are connected by covalent bond
- The mobility of molecules in beaker C is too high because the container is vapours, and the mobility of molecules is too less because they are highly separated and disorganised in the container, each molecule move a part.
- e) The factor which make the water molecule to move differently in different state is the disorder of reaction or the closeness of molecules.

Make a summary of your lesson and the student take the summary.

Let the student carry out the activity 15.1

Expected answers to checking up 15. 1

1. A thermodynamic quantity representing the unavailability of a system's thermal energy for conversion into mechanical work, often interpreted as the degree of disorder or randomness in the system.

2. Gas > liquid > solid

3. $DS = SS (\text{products}) - SS (\text{reactants})$

So $DS = S (\text{CO}_2 \text{ and H}_2\text{O}) - S (\text{C}_2\text{H}_2 \text{ and O}_2)$

$(213.6 + 69.9) - (205.0 + 200.8)$

$= -123 \text{ Jmol}^{-1}\text{K}^{-1}$

Lesson 2: Second law of thermodynamics (80 minutes)

a) Prerequisites

The students will learn better, the second law of thermodynamics when they have knowledge on the first law of thermodynamic and relation with thermochemistry, heat and temperature, energy of senior three.

b) Teaching resources

The teacher will need the materials like manila for demonstration, chinks and book, the internet and different books from library, beakers, and conical flask.

c) Learning activities:(50minutes)

Before introducing the lesson, let learners therefore attempt activity 15.2 which leads students to the second lesson of the unit

d) Methodological step

Make a group of five students for each group, then tell the student to select the leader as well as secretary to present at the end of the activity.

Tell the students discuss seriously the activity 15.2 and present

The group representative will represent and write the findings on the chalkboard or white board,

The teacher will be moving around and control the discipline of the rest of the students.

When all groups are done presenting, the teacher will harmonize the answers and the student will discuss on the answers of their colleagues while harmonizing.

The teacher will enrich the content of the students by adding the content while students will be taking summaries

Expected answers to activity 15.2

The first law of thermodynamics states that: “

1. The change in the internal energy ΔU of a closed system is equal to the amount of heat Q supplied to the system, minus the amount of work W done by the system on its surroundings. An equivalent statement is that perpetual motion machines of the first.
2. The relation between the first laws of thermodynamics is that the energy of the universe is always constant. In thermochemistry the variation of enthalpy change depend on the initial state and the final state and doesn't depend on the pathway of the reaction in the system

Assess the lesson by letting learners to do checking up 1.2 (15minutes)

Expected answers to checking up 15. 2

1. See student book

2. See student book



Steam water

$$S^\ominus = 188.7 \text{ JK}^{-1} \text{ mol}^{-1}$$

$$S^\ominus = 70.0 \text{ JK}^{-1} \text{ mol}^{-1}$$

The variation of entropy for the reaction is the decrease because as the condensation of water molecule (vapours) to water molecule will make the molecules of water to be closer each other and decreases the degree of randomness

Lesson 3: Free energy, the deciding factor (80 minutes)

a) Prerequisites (20 minutes)

Students will learn better the concept of free energy when they have knowledge on concept of entropy, free energy, temperature, and enthalpy.

b) Teaching resources

The same as above.

c) Learning activities

This is the time for introducing the lesson three, before introducing it, let learners therefore attempt activity 15.3 which leads to the third lesson of the unit.

Activity 1.4: (50 minutes)

Divide your class into groups, and let students follow the working procedures to obtain the results.

Let the learner(s) perform the activity using their prior knowledge to carry out the activity 15.3

Have sample group present their work to the class.

Check student's responses to review the students' plans and ideas to continue the discussion with a brief brainstorming of the concepts using student's work and book.

Comment on students' responses written in their notebooks, and give them the summary of expected feedback based on their findings.

Expected answers to the activity 15.3

See student book

Expected answers to checking up 15.3

$$\begin{aligned} 1. \text{ a) } \Delta H^\circ \text{ for the reaction} &= \sum \Delta H^\circ_f (\text{products}) - \sum \Delta H^\circ_f (\text{reactants}) = \\ &= (2 \times -242 + 0) - (4 \times -92 + 0) = -116 \text{ kJ mol}^{-1} \\ \Delta S^\circ \text{ for the reaction} &= \sum \Delta S^\circ (\text{products}) - \sum \Delta S^\circ (\text{reactants}) = (2 \times 189 + 2 \times 223) - (4 \times 187 + \\ &205) = -129 \text{ J K}^{-1} \text{ mol}^{-1} \end{aligned}$$

$$\text{b) Feasible when } \Delta G < 0 \quad \text{Assume, } \Delta G = \Delta H - T\Delta S = 0$$

$$T = \Delta H / \Delta S = -116 \times 1000 / -129 = 899.2 \text{ K, Thus, provided } T < 899.2 \text{ K, then } \Delta G < 0$$

c) Forward reaction is exothermic, so position of equilibrium shifted to the left in order oppose the increase in temperature.

1. Answer

a) ΔS^θ for the reaction = $\Sigma\Delta S(\text{products}) - \Sigma\Delta S(\text{reactants}) = (63 + 223) - (124) = +162 \text{ J K}^{-1} \text{ mol}^{-1}$

b) Feasible when $\Delta G < 0$, Assume, $\Delta G = \Delta H - T\Delta S = 0$

c) $T = \Delta H/\Delta S = 859 \times 1000/162 = 5302.5 \text{ K}$, Thus, provided $T > 5302.5 \text{ K}$, then $\Delta G < 0$

2. $\Delta S_v = \Delta H/T$,

$$\Delta H = 39.84 \text{ kJ mol}^{-1}$$

$$39840 \text{ J mol}^{-1}$$

$$T = 351$$

$$\Delta S_v = 39840/351 = 113.5 \text{ K}^{-1} \text{ mol}^{-1}$$

LESSON 4: Feasibility of chemical reactions: Relationship between free energy, enthalpy and entropy feasibility (80 Minutes)

a) Prerequisites (10 minutes)

Students will learn better the concept of free energy when they have knowledge on concept of entropy, free energy, temperature, and enthalpy.

b) Teaching resources

The same as above.

c) Learning activities

This is the time for introducing the lesson three, before introducing it, let learners therefore attempt activity 15.4 which leads to the third lesson of the unit.

d) Methodological guidance

- Divide your class into groups, and let students follow the working procedures to obtain the results.
- Let the learner(s) perform the activity using their prior knowledge to carry out the activity 15.4
- Have sample group present their work to the class.
- Check student's responses to review the students' plans and ideas to continue the discussion with a brief brainstorming of the concepts using student's work and book.

- Comment on students' responses written in their notebooks, and give them the summary of expected feedback based on their findings.

Test the students by giving them to the checking up 15.4

Expected answers to activity 15.4

See student book

Expected answers to checking up 15.4.

- a. Particles are in maximum state of order
(or perfect order or completely ordered or perfect crystal or minimum disorder or no disorder)(entropy is zero at 0 k by definition)
- (b)(Ice) melts
(Or freezes or changes from solid to liquid or from liquid to solid)
- (c) Increase in disorder
Bigger (at T₂)
second mark only given if first mark has been awarded
- b. (i) Moles of water = 1.53/18 (= 0.085)
Heat change per mole = 3.49/0.085 = 41.1 (kJ mol⁻¹)
(ii) $\Delta G = \Delta H - T\Delta S$
- (iii) $\Delta H = T\Delta S$ or $\Delta S = \Delta H/T$

$$\Delta S = 41.1/373 = 0.110 \text{ kJ K}^{-1}(\text{mol}^{-1}) \text{ (or } 110 \text{ (J K}^{-1}(\text{mol}^{-1}))$$

15.7. UNIT SUMMARY

Entropy is defined by the degree of randomness of the reaction and indicate the spontaneity of the reaction, spontaneous change occurs if they result in a more probable arrangement of molecules and energy which is an increase in number of ways in which molecule and energy can be distributed

Entropy, S increase always in spontaneous way, in general, the entropy values for gases and aqueous solution are greater than that of solid states.

When considering the entropy changes, it is important to consider the entropy change of the surroundings as well as that of the chemical system

$$\Delta S (\text{Surroundings}) = -\Delta H/T$$

Free energy change, ΔG , provide a way of accounting for the surrounding as well as the system

$$\Delta G = \Delta H - T\Delta S \text{ system}$$

For all spontaneous change, ΔG must be negative.

Reactions for which ΔG IS POSITIVE, can sometimes be made to go by alerting

conditions, particularly temperature.

ΔG indicates the energetic feasibility of reaction, it says nothing about its kinetic feasibility

15.8. Answers to end unit questions

1. A thermodynamic quantity representing the unavailability of a system's thermal energy for conversion into mechanical work, often interpreted as the degree of disorder or randomness in the system.
2. Unit: $\text{J K}^{-1} \text{mol}^{-1}$

entropy, have dimensions of energy divided by temperature, which has a unit of joules per kelvin (J K^{-1}) in the International System of Units (or $\text{kg m}^2 \text{s}^{-2} \text{K}^{-1}$ in terms of base units). The entropy of a substance is usually given as an intensive property either entropy per unit mass (SI unit: $\text{J K}^{-1} \text{kg}^{-1}$) or entropy per unit amount of substance (SI unit: $\text{J K}^{-1} \text{mol}^{-1}$).

(a) Particles are in maximum state of order (or perfect order or completely ordered or perfect crystal or minimum disorder or no disorder) (Entropy is zero at 0 K by definition)

b) (Ice) melts (or freezes or changes from solid to liquid or from liquid to solid)

(c) Increase in disorder Bigger (at T_2)

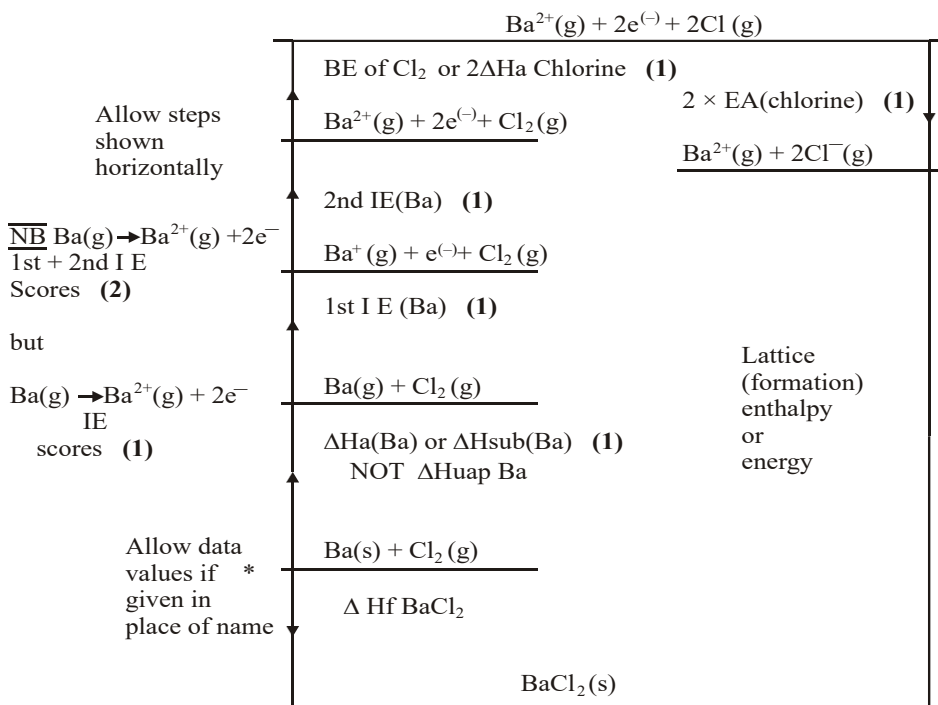

3. a)

. (ii) Cycling clockwise about (*)

$$\text{HaBa} + 1\text{st IE Ba} + 2\text{nd IE Ba} + 2\Delta\text{H}_{\text{aCl}} + 2\text{EaCl} + \text{LE} - \Delta\text{H}_{\text{fBaCl}_2} = 0$$
$$+180 + 503 + 965 + 2 \times 122 + 2\text{EA} - 2056 + 859 = 0 \quad \text{EA} = -695/2 = -(347 \text{ to } 348)$$

(b) $\Delta S = \Delta S \text{ products} - \Delta S \text{ reactants} = (63 + 223) - 124 = 162$

$$\Delta G = \Delta H - T\Delta S \quad \text{or} \quad \Delta H = T\Delta S \quad \text{or} \quad T = \Delta H/\Delta S$$

$$\Delta H = 859 \times 103 = T \times 162 \quad T = (5300 \text{ to } 5304) \text{ K}$$

4. (a) (i) Standard enthalpy change: $\Delta H_{\text{R}} = \sum \Delta H_{\text{f}} \text{ products} - \sum \Delta H_{\text{f}} \text{ (reactants)}$
 $\Delta H_{\text{R}} = (-804 - 394) - (-940) = -258 \text{ (kJ mol}^{-1}\text{)}$

Standard entropy change: $\Delta S = \sum \Delta S \text{ products} - \sum \Delta S \text{ reactants}$
 $\Delta S = (252 + 214) - (49.9 + 5.7 + [2 \times 223])$
 $= -35.6 \text{ (kJ mol}^{-1}\text{; ignore units completely)}$

(ii) $T = \frac{\Delta H}{\Delta S}$ or $T = \frac{\Delta H}{\Delta S} \frac{\text{value from above}}{\text{value from above}}$

$$T = \frac{-258 \times 1000}{-35.6} = 7245 \text{ to } 7250$$

5. (a) (i) Standard enthalpy change: $\Delta H_{\text{R}} = \sum \Delta H_{\text{f}} \text{ (products)} - \sum \Delta H_{\text{f}} \text{ (reactants)}$ or cycle

$$\Delta H_{\text{R}} = ([2 \times 0] + [3 \times -393.5]) - (-824.2 + [3 \times -110.5])$$
$$= -24.8 \text{ (kJ mol}^{-1}\text{)}$$

Standard entropy change: $\Delta S = \Delta S \text{ (products)} - \Delta S \text{ (reactants)}$

$$\Delta S = ([2 \times 27.3] + [3 \times 213.6]) - (87.4 + [3 \times 197.6])$$

$$= (54.6 + 640.8) - (87.4 + 592.8)$$

$$= 15.2 \text{ (JK}^{-1}\text{mol}^{-1}\text{)}$$

(ii) $\Delta G = \Delta H - T\Delta S$ (1)

ΔH negative and $-T\Delta S$ is negative

Hence ΔG is always negative (or feasible when $\Delta G = 0$)

(b) $\Delta G = 0 = \Delta H - T\Delta S$ Hence $\Delta H = T\Delta S$

$$T = \Delta H / \Delta S = 492.7 \times 1000 / 542.6$$

$$= 908 \text{ K}$$

(c) $\Delta G(b) = \Delta G(a)$

$$(492.7 \times 103 - T \times 542.6) = (-24.8 \times 103 - T \times 15.2)$$

$$517.5 \times 103 = 527.4 T$$

(6) (a) $\Delta H_a = \Delta H_f \text{ products} - \Delta H_f \text{ reactants}$ or

$$= \Delta H_f \text{ CO}_2 - (\Delta H_f \text{ CH}_4 + 2 \Delta H_f \text{ H}_2\text{O})$$

$$= -393.5 + (74.8 + [2 \times 241.8])$$

$$= +164.9 \text{ kJ mol}^{-1}$$

(b) (i) The number of moles of gas increases from 3 to 5

More moles gas gives more disorder

(ii) $\Delta S = \Delta S \text{ products} - \Delta S \text{ reactants}$

$$= (213.6 + [4 \times 130.6]) - (186.2 + [2 \times 188.7])$$

$$= +172.4 \text{ JK}^{-1} \text{ mol}^{-1}$$

(c) (i) $\Delta G = \Delta H - T\Delta S$ or $\Delta H = T\Delta S$

$$T = 164.9 \times 1000 / 172.4$$

$$= 956.5 \text{ K}$$

(ii) Above this temperature, this reaction is feasible or spontaneous

(7) $\Delta S = \Delta S \text{ products} - \Delta S \text{ reactants}$

$$\Delta S = (259 + 187) - (201 + 161)$$

$$\Delta S = 84 \text{ (JK}^{-1} \text{ mol}^{-1}\text{)}$$

$$\Delta G = \Delta H - T\Delta S$$

$$= -21.6 - 298 \times 84 / 1000$$

$$= -46.6 \text{ kJ mol}^{-1} \text{ or } -46\,600 \text{ J mol}^{-1}$$

(8) (a) Reaction 1

$$\Delta H = \sum \Delta H_f \text{ products} - \sum \Delta H_f \text{ reactants}$$

$$= (\Delta H_f \text{CO}) - (\Delta H_f \text{CH}_4 + \Delta H_f \text{H}_2\text{O})$$

$$= (-110.5) - (-74.8 - 241.8) = +206.1 \text{ (kJ mol}^{-1}\text{)}$$

$$\Delta S = \Delta S \text{ products} - \Delta S \text{ reactants}$$

$$= (197.6 + [3 \times 130.6]) - (186.2 + 188.7) = 214.5 \text{ (J K}^{-1}\text{mol}^{-1}\text{)}$$

$$\Delta G = \Delta H - T\Delta S$$

$$0 = +206.1 - T \times 214.5/1000$$

$$T = 206.1 \times 1000/214.5 = 960.8 \text{ (K)}$$

Reaction 2

$$\Delta H = 2\Delta H_f \text{NH}_3 = -92.2 \text{ (kJ mol}^{-1}\text{)}$$

$$\Delta S = (2 \times 192.3) - (191.6 + [3 \times 130.6]) = -198.8 \text{ (J K}^{-1}\text{mol}^{-1}\text{)}$$

$$\Delta G = 0 = -92.2 + T \times 198.8/1000$$

$$T = 92.2 \times 1000/198.8 = 463.8 \text{ (K)}$$

(b) Reaction 1 at higher temperatures

Equilibrium yield increased/forward reaction favoured as reaction endothermic

Rate of reaction increased

A compromise temperature used based on high cost of high temperature

Reaction 2 at higher temperatures

Equilibrium yield reduced/backward reaction favoured as reaction exothermic

Rate of reaction increased

A compromise temperature used based on overall yield

9. See student book

15.9. ADDITIONAL CONTENT

Qualitatively, **the entropy (S)** of a system is a measure of how spread out or how dispersed the system's energy is. The simplest interpretation of this is how spread out a system's energy is in space. In other words, for a given system, the greater the volume it occupies, the greater its entropy. This interpretation explains how the process occurs spontaneously despite there being no enthalpy change. Because they are moving, the gas molecules that were originally confined to one side of the container possess motional energy. In the absence of a barrier preventing it, the motional energy of molecules will spread out to occupy a larger volume.

The dispersal of a system's motional energy to occupy a larger volume when the barrier is removed constitutes an increase in the system's entropy. Just as spontaneity is favoured by a process being exothermic, spontaneity is also favoured by an increase in the system's entropy.

Whether it is the enthalpy change, the entropy change, or both, for a process to be spontaneous, something must favour spontaneity.

Entropy Changes in a System

Calculating ΔS_{sys}

The change in entropy of a system is the difference between the entropy of the final state and the entropy of the initial state.

$$\Delta S_{\text{sys}} = S_{\text{final}} - S_{\text{initial}}$$

The change in entropy of the system tends on the physical state of the substance in the system

Qualitatively Predicting the Sign of $\Delta S^{\circ}_{\text{sys}}$

To calculate $\Delta S^{\circ}_{\text{rxn}}$ for a process when the standard entropies of the products and reactants are known. However, sometimes it's useful just to know the sign of $\Delta S^{\circ}_{\text{rxn}}$.

Although multiple factors can influence the sign of $\Delta S^{\circ}_{\text{rxn}}$, the outcome is often dominated by a single factor, which can be used to make a qualitative prediction. Several processes that lead to an increase in entropy are

- **Melting**
- **Vaporization or sublimation**
- **Temperature increase**
- **Reaction resulting in a greater number of gas molecules**

When a solid is melted, the molecules have greater energy and are more mobile. They go from being in fixed positions in the solid, to being free to move about in the liquid. As we saw in the discussion of standard entropy, this leads to many more possible arrangements of the molecules and, therefore, greater entropy. The same rationale holds for the vaporization or sublimation of a substance. There is a dramatic increase in energy/mobility, and in the number of possible arrangements of a system's molecules when the molecules go from a condensed phase to the gas phase.

Therefore, there is a much larger increase in the system's entropy, relative to the solid-to-liquid transition.

When the temperature of a system is increased, the energy of the system's molecules increases. To visualize this, recall from the discussion of kinetic molecular theory that increasing the temperature of a gas increases its average kinetic energy. This corresponds to an increase in the average speed of the gas molecules and a spreading out of the range of molecular speeds.

If we think of each of the possible molecular speeds within the range as a discrete energy level, we can see that at higher temperatures, there is a greater number of possible molecular speeds and, therefore, a greater number of energy states available to the molecules in the system. With a greater number of available energy states, there is a greater number of possible arrangements of molecules within those states and, therefore, a greater entropy.

Entropy Changes in the Universe

Recall that the system typically is the part of the universe we are investigating (e.g., the reactants and products in a chemical reaction). The surroundings are everything else. Together, the system and surroundings make up the universe. We have seen that the dispersal or spreading out of a system's energy corresponds to an increase in the system's entropy. Moreover, an increase in the system's entropy is one of the factors that determines whether or not a process is spontaneous. However, correctly predicting the spontaneity of a process requires us to consider entropy changes in both the system and the surroundings.

Consider the following processes:

- An ice cube spontaneously melts in a room where the temperature is 25°C. In this case, the motional energy of the air molecules at 25°C is transferred to the ice cube (at 0°C), causing the ice to melt. There is no temperature change during a phase change. However, because the molecules are more mobile and there are many more different possible arrangements in liquid water than there are in ice, there is an increase in the entropy of the system.

In this case, because the process of melting is endothermic, heat is transferred from the surroundings to the system and the temperature of the surroundings decreases. The slight decrease in temperature causes a small decrease in molecular motion and a decrease in the entropy of the surroundings.

$\Delta S(\text{sys})$ is positive.

$\Delta S(\text{surr})$ is negative.

- A cup of hot water spontaneously cools to room temperature as the motional energy of the water molecules spreads out to the cooler surrounding air.

Entropy Changes in a System

The system and corresponding temperature decrease cause a decrease in the entropy of the system, the increased temperature of the surrounding air causes an increase in the entropy of the surroundings.

ΔS_{sys} is negative.

ΔS_{surr} is positive.

Thus, it is not just the entropy of the system that determines if a process is spontaneous, the entropy of the surroundings is also important. There are also examples of spontaneous processes in which ΔS_{sys} and ΔS_{surr} are both positive. The decomposition of hydrogen peroxide produces water and oxygen gas, $2\text{H}_2\text{O}_2(\text{l}) \longrightarrow 2\text{H}_2\text{O}(\text{l}) + \text{O}_2(\text{g})$. Because the reaction results in an increase in the number of gas molecules, we know that there is an increase in the entropy of the system. However, this is an exothermic reaction, meaning that it also gives off heat to the surroundings. An increase in temperature of the surroundings causes an increase in the entropy of the surroundings as well.

(Note that there are no spontaneous processes in which $\Delta S(\text{sys})$ and $\Delta S(\text{surr})$ are both negative, which will become clear shortly)

Gibbs Free-Energy Change, ΔG

According to the second law of thermodynamics, $\Delta S_{\text{univ}} > 0$ for a spontaneous process. What we are usually concerned with and usually measure, however, are the properties of the system rather than those of the surroundings or those of the universe overall. Therefore, it is convenient to have a thermodynamic function that enables us to determine whether or not a process is spontaneous by considering the system alone.

FOR SPONTANEOUS PROCESS

$$\Delta S_{\text{univ}} = \Delta S_{\text{sys}} + \Delta S_{\text{surr}} > 0$$

Substituting $-\Delta H_{\text{sys}}/T$ for ΔS_{surr} , we write

$$\Delta S_{\text{univ}} = \Delta S_{\text{sys}} + \left(\frac{\Delta H}{T}\right) > 0$$

Multiplying both sides of the equation by T gives

$$T\Delta S_{\text{univ}} = T\Delta S_{\text{sys}} - \Delta H_{\text{sys}} > 0$$

Now we have an equation that expresses the second law of thermodynamics (and predicts whether or not a process is spontaneous) in terms of only the system. We no longer need to consider the surroundings. For convenience, we can rearrange the preceding equation, multiply through by -1 , and replace the $>$ sign with a $<$ sign:

$$-T\Delta S_{\text{univ}} = \Delta H_{\text{sys}} - T\Delta S_{\text{sys}} < 0$$

According to this equation, a process carried out at constant pressure and temperature is spontaneous if the changes in enthalpy and entropy of the system are such that $\Delta H_{\text{sys}} - T\Delta S_{\text{sys}}$ is less than zero.

To express the spontaneity of a process more directly, we introduce another thermodynamic function called the Gibbs free energy (G), or simply free energy.

$$G = H - TS$$

Each of the terms in Equation above pertains to the system. G has units of energy just as H and

TS do. Furthermore, like enthalpy and entropy, free energy is a state function. The change in free energy, ΔG , of a system for a process that occurs at constant temperature is

$$\Delta G = \Delta H - T\Delta S$$

This equation enables us to predict the spontaneity of a process using the change in enthalpy, the change in entropy, and the absolute temperature. At constant temperature and pressure, for processes that are spontaneous as written (in the forward direction), ΔG is negative. For processes that are not spontaneous as written but that are spontaneous in the reverse direction, ΔG is positive. For systems at equilibrium, ΔG is zero.

- **$\Delta G < 0$ The reaction is spontaneous in the forward direction (and nonspontaneous in the reverse direction).**
- **$\Delta G > 0$ The reaction is nonspontaneous in the forward direction (and spontaneous in the reverse direction).**
- **$\Delta G = 0$ The system is at equilibrium.**

Often we can predict the sign of ΔG for a process if we know the signs of ΔH and ΔS . The following table shows how we can use Equation to make such predictions.

Based on the information in Table you may wonder what constitutes a “low” or a “high” temperature. For the freezing of water, 0°C is the temperature that divides high from low.

When ΔH is	And ΔS is	ΔG will be	And the process is	Example
Negative	Positive	Negative	Always spontaneous	$2\text{H}_2\text{O}_2(\text{aq}) \longrightarrow 2\text{H}_2\text{O}(\text{l}) + \text{O}_2(\text{g})$
Positive	Negative	Positive	Always nonspontaneous	$3\text{O}_2(\text{g}) \longrightarrow 2\text{O}_3(\text{g})$
Negative	Negative	Negative when $T\Delta S < \Delta H$	Spontaneous at low T	$\text{H}_2\text{O}(\text{l}) \longrightarrow \text{H}_2\text{O}(\text{s})$
		Positive when $T\Delta S > \Delta H$	Nonspontaneous at high T	(freezing of water)
Positive	Positive	Negative when $T\Delta S > \Delta H$	spontaneous at high T	$2\text{HgO}(\text{s}) \longrightarrow 2\text{Hg}(\text{l}) + \text{O}_2(\text{g})$
		Positive when $T\Delta S < \Delta H$	Nonspontaneous at low T	

Additional activities

a) Remedial activities

1. From the standard entropy values in student book, calculate the standard entropy changes for the following reactions at 25°C:

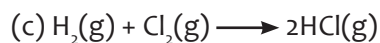
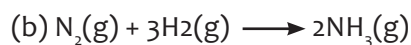

Answers

$$\begin{aligned} \text{(a)} \Delta S^\circ_{\text{rxn}} &= [S^\circ(\text{CaO}) + S^\circ(\text{CO}_2)] - [S^\circ(\text{CaCO}_3)] \\ &= [(39.8 \text{ J/K} \cdot \text{mol}) + (213.6 \text{ J/K} \cdot \text{mol})] - (92.9 \text{ J/K} \cdot \text{mol}) \\ &= 160.5 \text{ J/K} \cdot \text{mol} \end{aligned}$$

$$\begin{aligned} \text{(b)} \Delta S^\circ_{\text{rxn}} &= [2S^\circ(\text{NH}_3)] - [S^\circ(\text{N}_2) + 3S^\circ(\text{H}_2)] \\ &= (2)(193.0 \text{ J/K} \cdot \text{mol}) - [(191.5 \text{ J/K} \cdot \text{mol}) + (3)(131.0 \text{ J/K} \cdot \text{mol})] \end{aligned}$$

$$= -198.5 \text{ J/K} \cdot \text{mol}$$

$$(c) \Delta S^{\circ} \text{rxn} = [2S^{\circ}(\text{HCl})] - [S^{\circ}(\text{H}_2) + S^{\circ}(\text{Cl}_2)]$$

$$= (2)(187.0 \text{ J/K} \cdot \text{mol}) - [(131.0 \text{ J/K} \cdot \text{mol}) + (223.0 \text{ J/K} \cdot \text{mol})]$$

$$= 20.0 \text{ J/K} \cdot \text{mol}$$

2. For each process, determine the sign of ΔS for the system:

(a) Decomposition of $\text{CaCO}_3(\text{s})$ to give $\text{CaO}(\text{s})$ and $\text{CO}_2(\text{g})$,

(b) Heating bromine vapor from 45°C to 80°C ,

(c) Condensation of water vapor on a cold surface,

(d) Reaction of $\text{NH}_3(\text{g})$ and $\text{HCl}(\text{g})$ to give $\text{NH}_4\text{Cl}(\text{s})$, and

(e) Dissolution of sugar in water.

Answers:

ΔS is (a) positive, (b) positive, (c) negative, (d) negative, and (e) positive.

3. Determine if each of the following is a spontaneous process, a nonspontaneous process, or an equilibrium process at the specified temperature:

(a) $\text{H}_2(\text{g}) + \text{I}_2(\text{g}) \longrightarrow 2\text{HI}(\text{g})$ at 0°C ,

(b) $\text{CaCO}_3(\text{s}) \longrightarrow \text{CaO}(\text{s}) + \text{CO}_2(\text{g})$ at 200°C ,

(c) $\text{CaCO}_3(\text{s}) \longrightarrow \text{CaO}(\text{s}) + \text{CO}_2(\text{g})$ at 1000°C ,

(d) $\text{Na}(\text{s}) \longrightarrow \text{Na}(\text{l})$ at 98°C .

Answers

$$(a) \Delta S^{\circ} \text{rxn} = [2S^{\circ}(\text{HI})] - [S^{\circ}(\text{H}_2) + S^{\circ}(\text{I}_2)]$$

$$= (2)(206.3 \text{ J/K} \cdot \text{mol}) - [131.0 \text{ J/K} \cdot \text{mol} + 260.57 \text{ J/K} \cdot \text{mol}] = 21.03 \text{ J/K} \cdot \text{mol}$$

$$\Delta H^{\circ} \text{rxn} = [2\Delta H_f^{\circ}(\text{HI})] - [\Delta H_f^{\circ}(\text{H}_2) + \Delta H_f^{\circ}(\text{I}_2)]$$

$$= (2)(25.9 \text{ kJ/mol}) - [0 \text{ kJ/mol} + 62.25 \text{ kJ/mol}] = -10.5 \text{ kJ/mol}$$

$$\Delta S_{\text{surr}} = \frac{-\Delta H_{\text{rxn}}}{T} = \frac{-(-10.5)}{273}$$

$$= 0.0385 \text{ kJ/K} \cdot \text{mol} = 38.5 \text{ J/K} \cdot \text{mol}$$

$$\Delta S_{\text{univ}} = \Delta S_{\text{sys}} + \Delta S_{\text{surr}} = 21.03 \text{ J/K} \cdot \text{mol} + 38.5 \text{ J/K} \cdot \text{mol} = 59.5 \text{ J/K} \cdot \text{mol}$$

ΔS_{univ} is positive; therefore the reaction is spontaneous at 0°C .

(b), (c) $\Delta S^\circ_{\text{rxn}} = 160.5 \text{ J/K} \cdot \text{mol}$

$$\Delta H^\circ_{\text{rxn}} = [\Delta H_f^\circ(\text{CaO}) + \Delta H_f^\circ(\text{CO}_2)] - [\Delta H_f^\circ(\text{CaCO}_3)]$$

$$= [-635.6 \text{ kJ/mol} + (-393.5 \text{ kJ/mol})] - (-1206.9 \text{ kJ/mol}) = 177.8 \text{ kJ/mol}$$

(b) $T = 200^\circ\text{C}$ and

$$\Delta S_{\text{surr}} = \frac{-\Delta H_{\text{rxn}}}{T} = \frac{-(177.8)}{473}$$

$$T = -0.376 \text{ kJ/K} \cdot \text{mol} = -376 \text{ J/K} \cdot \text{mol}$$

$$\Delta S_{\text{univ}} = \Delta S_{\text{sys}} + \Delta S_{\text{surr}} = 160.5 \text{ J/K} \cdot \text{mol} + (-376 \text{ J/K} \cdot \text{mol}) = -216 \text{ J/K} \cdot \text{mol}$$

ΔS_{univ} is negative, therefore the reaction is nonspontaneous at 200°C .

(c) $T = 1000^\circ\text{C}$ and

$$\Delta S_{\text{surr}} = \frac{-\Delta H_{\text{rxn}}}{T} = \frac{-177.8}{1273}$$

$$= -0.1397 \text{ kJ/K} \cdot \text{mol} = -139.7 \text{ J/K} \cdot \text{mol}$$

$\Delta S_{\text{univ}} = \Delta S_{\text{sys}} + \Delta S_{\text{surr}} = 160.5 \text{ J/K} \cdot \text{mol} + (-139.7 \text{ J/K} \cdot \text{mol}) = 20.8 \text{ J/K} \cdot \text{mol}$ In this case, ΔS_{univ} is positive; therefore, the reaction is spontaneous at 1000°C .

(d) $\Delta S^\circ_{\text{rxn}} = S^\circ[\text{Na(l)}] - S^\circ[\text{Na(s)}] = 57.56 \text{ J/K} \cdot \text{mol} - 51.05 \text{ J/K} \cdot \text{mol} = 6.51 \text{ J/K} \cdot \text{mol}$

$$\Delta H^\circ_{\text{rxn}} = \Delta H_f^\circ[\text{Na(l)}] - \Delta H_f^\circ[\text{Na(s)}] = 2.41 \text{ kJ/mol} - 0 \text{ kJ/mol} = 2.41 \text{ kJ/mol}$$

$$\Delta S_{\text{surr}} = \frac{-\Delta H_{\text{rxn}}}{T} = \frac{2.41 \text{ kJ}}{371} = -0.0650 \text{ kJ/K} \cdot \text{mol} = -6.50 \text{ J/K} \cdot \text{mol}$$

$$\Delta S_{\text{univ}} = \Delta S_{\text{sys}} + \Delta S_{\text{surr}} = 6.51 \text{ J/K} \cdot \text{mol} + (-6.50 \text{ J/K} \cdot \text{mol}) = 0.01 \text{ J/K} \cdot \text{mol} \approx 0$$

b) Consolidation activities

1. Ethyl ethanoate can be prepared by the reactions shown below.

Reaction 1



Reaction 2



Use the information given above and the data below to calculate values for the standard

entropy change, ΔS° for the standard free-energy change, ΔG° for Reaction 2 at 298 K.

	$\text{CH}_3\text{COCl(l)}$	$\text{C}_2\text{H}_5\text{OH(l)}$	$\text{CH}_3\text{COOC}_2\text{H}_5\text{(l)}$	HCl(g)
$S^\circ/\text{JK}^{-1}\text{mol}^{-1}$	201	161	259	187

Answer: $\Delta S = \Delta S \text{ products} - \Delta S \text{ reactants}$

$$\Delta S = (259 + 187) - (201 + 161)$$

$$\Delta S = 84 \text{ (JK}^{-1}\text{ mol}^{-1}\text{)}$$

Allow – 84 to score

$$\Delta G = \Delta H - T\Delta S$$

$$= -21.6 - 298 \times 84/1000$$

$$= -46.6 \text{ kJ mol}^{-1} \text{ or } -46\,600 \text{ J mol}^{-1}$$

1. The equations for two industrial equilibrium reactions are given below.

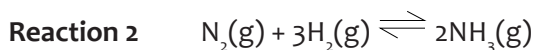
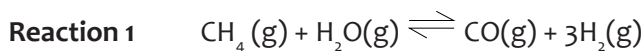

(a) Use the information in the table below to calculate the temperatures at which the free-energy change for each reaction is equal to zero.

	$\text{CH}_4(\text{g})$	$\text{H}_2\text{O}(\text{g})$	$\text{CO}(\text{g})$	$\text{H}_2(\text{g})$	$\text{N}_2(\text{g})$	$\text{NH}_3(\text{g})$
$\Delta H_f^\circ/\text{kJ mol}^{-1}$	-74.8	-241.8	-110.5	0	0	-46.1
$S^\circ/\text{J K}^{-1}\text{ mol}^{-1}$	186.2	188.7	197.6	130.6	191.6	192.3

(b) In industry, Reaction 1 and Reaction 2 are carried out at high temperatures. State how, using temperatures higher than those calculated in part (a), the yields of products are altered in Reaction 1 and in Reaction 2. In each case, explain why a high temperature is used in practice.

Answer: (a) Reaction 1

$$\Delta H = \sum \Delta H_f^\circ \text{ products} - \sum \Delta H_f^\circ \text{ reactants}$$

$$= (\Delta H_f^\circ \text{CO}) - (\Delta H_f^\circ \text{CH}_4 + \Delta H_f^\circ \text{H}_2\text{O})$$

$$= (-110.5) - (-74.8 - 241.8) = +206.1 \text{ (kJ mol}^{-1}\text{)}$$

$$\Delta S = \Delta S \text{ products} - \Delta S \text{ reactants}$$

$$= (197.6 + [3 \times 130.6]) - (186.2 + 188.7) = 214.5 \text{ (J K}^{-1}\text{mol}^{-1}\text{)}$$

$$\Delta G = \Delta H - T\Delta S$$

$$0 = +206.1 - T \times 214.5/1000$$

$$T = 206.1 \times 1000/214.5 = 960.8 \text{ (K)}$$

Reaction 2

$$\Delta H = 2\Delta H_f \text{NH}_3 = -92.2 \text{ (kJ mol}^{-1}\text{)}$$

$$\Delta S = (2 \times 192.3) - (191.6 + [3 \times 130.6]) = -198.8 \text{ (J K}^{-1}\text{mol}^{-1}\text{)}$$

$$\Delta G = 0 = -92.2 + T \times 198.8/1000$$

$$T = 92.2 \times 1000/198.8 = 463.8 \text{ (k)}$$

Note:– Allow first calculation max 7 and second calculation max 3

(b) Reaction 1 at higher temperatures

Equilibrium yield increased/forward reaction favoured as reaction endothermic, rate of reaction increased.

A compromise temperature used based on high cost of high temperature

Reaction 2 at higher temperatures

Equilibrium yield reduced/backward reaction favoured as reaction exothermic, rate of reaction increased a compromise temperature used based on overall yield

b) Extended activities

(a) The reaction given below does not occur at room temperature.

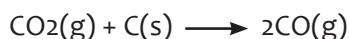

Use the data given below to calculate the lowest temperature at which this reaction becomes feasible.

	C(s)	CO(g)	CO ₂ (g)
$\Delta H^\circ_f/\text{kJ mol}^{-1}$	0	-110.5	-393.5

$S^\circ/\text{J K}^{-1} \text{mol}^{-1}$	5.7	197.6	213.6
---	-----	-------	-------

(b) When an electrical heating coil was used to supply 3675 J of energy to a sample of water which was boiling at 373 K, 1.50 g water were vaporised. Use this information to calculate the entropy change for the process



Answer: (a) Spontaneous when $\Delta G < 0$ or $\Delta G = 0$

$$\Delta G = \Delta H - T\Delta S \quad (1)$$

Calculation of ΔH ; $\Delta H_{\text{reaction}} = \sum \Delta H_{\text{Products}} - \sum \Delta H_{\text{Reactants}}$

$$= (2 \times -110.5) - (-3935) = +172.5 \text{ kJ mol}^{-1}$$

Calculation of ΔS ; $\Delta S_{\text{reaction}} = \sum \Delta H_{\text{Products}} - \sum \Delta H_{\text{Reactants}}$

$$= (2 \times 197.6) - (5.7 + 213.6) = 175.9 \text{ J mol}^{-1} \text{ K}^{-1}$$

Calculation of T $\Delta G = 172.5 - T \times 175.9/1000 = 0$

$$T \times 175.9/1000 = 172.5$$

$$T = 172.5 \times 1000/175.9 = 980.7 \text{ K}$$

(b) Calculation of $\Delta H_{\text{Vaporisation}}$;

3675 J vaporise 1.50 g water

$3675 \times 18/1.50$ vaporise 1.00 mole water

$$= 44.1 \text{ kJ mol}^{-1}$$

Calculation of ΔS ; $G = 0 = 44.1 - 373 \times \Delta S/1000$ or $\Delta S = \Delta H/T$

$$\Delta S = 44.1 \times 1000/373 = 118.2 \text{ J mol}^{-1} \text{ K}^{-1}$$

Iron (II) oxide can be reduced to iron both by carbon, which is oxidised to carbon monoxide, and by carbon monoxide, which is oxidised to carbon dioxide, as shown in the equations below.



(a) Use the data given below to deduce the free energy change, ΔG_0 , measured at 450 K, for each of these reduction processes.

(Assume that the enthalpy change and the entropy change in each of these reactions remain the same if the temperature is raised from 298 K to 450 K.)

	FeO(s)	Fe(s)	C(s)	CO(g)	CO ₂ (g)
$\Delta H_{\text{of}}/\text{kJ mol}^{-1}$	-271.9	0	0	-110.5	393.5
$S_{\text{o}}/\text{J K}^{-1} \text{ mol}^{-1}$	58.5	27.3	5.7	197.6	213.6

(b) Deduce how an increase in temperature will affect the feasibility of each of the processes in which iron (II) oxide is reduced to iron.

Answer:

$$\begin{aligned} \text{(a) } \Delta H_{\text{f}}^{\ominus} &= \sum \Delta H_{\text{Products}} - \sum \Delta H_{\text{Reactants}} \\ &= (-110.5) - (-271.9) = +161.4 \text{ [Allow } 161 - 161.5] \text{ kJ mol}^{-1} \end{aligned}$$

$$\begin{aligned} \Delta S_{\text{o}} &= \Delta S_{\text{o}}(\text{products}) - \Delta S_{\text{o}}(\text{reactants}) \\ &= (27.3 + 197.6) - (58.5 + 5.7) = +160.7 \end{aligned}$$

[Allow 160.6 – 161] J mol⁻¹ K⁻¹

$$\Delta G = \Delta H - T\Delta S \text{ [Stated or correctly used]}$$

$$\Delta G = +161.4 - 450 \times 160.7/1000$$

$$= +89.1 \text{ [Allow } 88.5 - 89.1] \text{ kJ mol}^{-1}.$$

$$\Delta H_{\text{f}}^{\ominus} = (-393.5) - (-271.9 - 110.5) = -11.1 \text{ kJ mol}^{-1}.$$

$$\Delta S_{\text{o}} = (213.6 + 27.3) - (58.5 + 197.6) = -15.2 \text{ J mol}^{-1} \text{ K}^{-1}.$$

$$\Delta G = -11.1 + 450 \times 15.2/1000 = -4.26 \text{ [Allow } -4.3] \text{ kJ mol}^{-1}.$$

(b) Feasible when $\Delta G < 0$ or ΔG is negative

Process 1 is more feasible as temperature is increased

Because ΔS is positive or $-T\Delta S$ is negative or $T\Delta S$ is positive

Process 2 is less feasible as temperature is increased

Because ΔS is negative or $-\Delta S$ is positive or $T\Delta S$ is negative

REFERENCES

Arnaud, P. (1991). Chimie Organique, Exercices résolus, 3e édition. Paris: DUNOD.

BAHL, G.D. Tuli et Arun Bahl (2000), Essential of Physical chemistry: S.Chand Company Ltd, New Delhi. 8.

Chang, R. (2005). Chemistry, Eighth Edition. New York: McGraw-Hill.

Clark, J. (2018, March 20). ALIPHATIC AMINES MENU. Retrieved from chemguide Helping you to understand Chemistry: <http://chemguide.co.uk/organicprops/aminemenu.html#top>

Dakin, H., & West, R. (1928). A GENERAL REACTION OF AMINO ACIDS. II. Journal of Biological Chemistry, 745-756. Retrieved Mars 25, 2018, from <http://www.jbc.org/content/78/3/745.citation>

Daniel R. Bloch (2012), ORGANIC CHEMISTRY DeMYSTiFieD, SECOND EDITION, McGrawHill.

De Levie, , (1999) R. Aqueous Acid-base Equilibria and Titrations. Oxford University Press.

Dhoot, A.S; Naha, A; Priya, J.; Xalxo, N. 2018. Phase diagrams for three component mixtures in pharmaceuticals and its applications. J Young Pharm, 2018; 10(2): 132-137

E.N. Ramsden (2000), A-Level CHEMISTRY, FOURTH EDITION, Nelson Thornes

GRAHAM HILL, J. H. (2000). Chemistry in context, fifth edition. Nelson Thornes.

Hanson, B. (2018, March 18). Acid-Base Properties of Amino Acids I, II & III. Retrieved from Organic Chemistry Practice Problems at Michigan State University: <https://www2.chemistry.msu.edu/faculty/reusch/VirtTxtJml/Questions/problems.htm>

Harris, D.C (2010). Quantitative chemical Analysis. 8th edn, W.H. Freeman.

Hill, G., & Holman, J. (1995). Chemistry in Context, Fourth Edition. Thomas Nelson and Sons Ltd.

Holman, G. H. (1995). Chemistry in context. UK: Thomas Nelson and sons Ltd.

<https://www.chemguid.co.uk>

Kasangandjo, Lwish; (2013) Advanced level Chemistry Students' Book for S5. Pearson.

Kazemi, F., Kiasat, A.R. and Mombaini, B. (2007). Simple preparation of symmetrical carboxylic acid anhydrides by means of $\text{Na}_2\text{CO}_3/\text{SOCl}_2$. An International Journal for

Rapid Communication of Synthetic Organic Chemistry, 37(18): 3219-3223

Lim You Sie, Yip Kim Hong; (2008) Physical Chemistry. Pearson.

Llc, B. Titration:Ph , (2010)Indicator, Thermometric Titration, Non aqueous Titration, Equivalent Point, Acid-Base Titration, Amperometric Titration. General Books LLC.

Obot, Keith; (2003) Advanced Level Practical Chemistry.

Obot, Keith; (2008).A complete Revision Notes in Advanced Level Physical Chemistry, Fifth impression.

Olinga, Simon Peter; (2004) Simplified Approach for A-level Chemistry Practicals.

Peter Cann, P. H. (2002). Chemistry for advanced level. JOHN MURRAY.

Peter.W. Atkins, (2007) Physical chemistry, ninth edition; oxford.

Petr Cann, P. H. (2002). Chemistry for advanced level. London: John Murray Ltd.

Rwanda Basic Education Board. (2015). Advanced level chemistry syllabus. Kigali: PRINTEX.

Schmitz, A. (2018, March 25). Introduction to Chemistry: General, Organic, and Biological (v. 1.0). Retrieved from 18.1 Properties of Amino Acids: <https://2012books.lardbucket.org/books/introduction-to-chemistry-general-organic-and-biological/s21-01-properties-of-amino-acids.html>

Woser, J. (1967) Acid-base Titration and Distribution curves. J.Chem. Educ.44, 274, doi: 10.1021/ed044P274.

