

# Biology

For

**Associate Nursing Program**

# S4

# Teacher Guide

*Second Edition*

**Kigali, 2024**

Copyright

© 2024 Rwanda Education Board

All rights reserved.

This Teacher's Guide is the property of Rwanda Education Board  
Credit should be given to REB when the source of this book is quoted.

## FOREWORD

Dear Teacher,

The Rwanda Basic Education Board is pleased to present this Teacher’s Guide for the Associate Nursing Program. This guide is designed to support competence-based teaching and ensure consistency in delivering the Biology subject. The Rwandan educational philosophy aims to help student-associate nurses achieve their full potential, preparing them to address community health needs and pursue career opportunities.

To enhance education quality, the government of Rwanda emphasizes the alignment of teaching materials with the syllabus. Effective teaching relies on the relevance of content, pedagogical approaches, assessment strategies, and instructional materials. The guide focuses on activities that promote learning, allowing students to develop ideas and make discoveries.

In a competence-based curriculum, learning involves actively building knowledge and skills through activities, scenarios, and real-life applications. Your role as a teacher includes:

- Planning lessons and preparing teaching materials.
- Organizing group discussions and collaborative learning.
- Engaging students through active learning methods such as inquiry, research, and group work.
- Supporting and facilitating the learning process by valuing student contributions and guiding them towards integrating their findings.

This guide is divided into three parts:

1. Explains the book’s structure and provides methodological guidance.
2. Offers sample lesson plans for reference.
3. Provides detailed teaching guidance for each concept in the student book.

Although the guide includes answers to student book activities, please review each question and activity before assessing student responses.

I extend my gratitude to everyone involved in developing this guide, including the Ministry of Health, University of Rwanda, and other institutions. Special thanks go to faculty members, nurses, midwives, teachers, illustrators, designers, Health Workforce development staff/MoH, and REB staff for their dedicated work.

**Dr. MBARUSHIMANA Nelson**

**Director General, REB**



## **ACKNOWLEDGEMENT**

I would like to express my deep gratitude to everyone who contributed to the development of this student book. The project would not have succeeded without the support of numerous stakeholders. I extend special thanks to the Ministry of Health for leading the development process. My appreciation also goes to the Health Workforce development staff/MoH, REB staff, University of Rwanda, College of Medicine and Health Sciences, Staff from Health Private training institutions, Teaching hospitals, Level Two Teaching hospitals, district hospitals, National Council of Nurses and Midwives (NCNM),) and Secondary schools having Associate Nursing program. Additional thanks are due to the Ministry of Health, the Ministry of Education, and the Clinton Health Access Initiative (CHAI) for their financial support.

**Joan MURUNGI,**

**Head of Curriculum, Teaching and Learning Resources Department**

# TABLE OF CONTENTS

FOREWORD .....	i
ACKNOWLEDGEMENT .....	iii
I. GENERAL INTRODUCTION.....	x i
1.1 Structure of the guide .....	xi
1.2 Methodological guidance.....	xiv
II. SAMPLE LESSON PLAN .....	xxvii
III. UNIT DEVELOPMENT.....	xxx
<b>UNIT 1: INTRODUCTION TO BIODIVERSITY.....</b>	<b>1</b>
1.1 Key unit competence .....	1
1.2 Prerequisite (knowledge, skills, attitudes and values) .....	1
1.3 Cross-cutting issues to be addressed .....	1
1.4 Guidance on the introductory activity .....	2
1.5 List of lessons/sub-heading.....	3
1.6 Summary of the unit.....	15
1.7 Additional information .....	16
1.9 Additional activities .....	17
<b>UNIT 2: INTRODUCTION TO CLASSIFICATION .....</b>	<b>2 3</b>
2.1 Key unit competence .....	23
2.2 Prerequisites.....	23
2.3 Cross-cutting issues to be addressed .....	23
2.4 Guidance on the introductory activity .....	24
2.5 List of lessons. ....	25
2.6 Summary of the unit.....	38
2.7 Additional Information .....	39
2.8 Answers for end unit assessment 2 .....	40
2.9 Additional activities .....	43

<b>UNIT 3: MICROSCOPY .....</b>	<b>4 9</b>
3.1 Key unit competence .....	49
3.2 Prerequisite (knowledge, skills, attitudes and values) .....	49
3.3 Cross-cutting issues to be addressed .....	49
3.4 Guidance on the introductory activity .....	50
3.5 List of lessons/sub-heading (including assessment).....	50
3.6 Summary of the unit .....	61
3.7 Additional Information .....	61
3.8 End of unit assessment 3 .....	62
<b>UNIT 4: CELL STRUCTURE AND SPECIALIZATION .....</b>	<b>6 9</b>
4.1 Key unit competence .....	69
4.2 Prerequisites.....	69
4.3 Cross-cutting issues .....	69
4.4 Guidance on the introductory activity .....	70
4.5 List of lessons/ sub-heading.....	71
4.6 Summary of the unit .....	82
4.7 Additional Information .....	82
4.8 Answers for the End unit assessment .....	82
4.9 Additional activities .....	85
<b>UNIT 5: DIVERSITY OF SPECIALIZED TISSUES.....</b>	<b>8 9</b>
5.1 Key unit competence .....	89
5.2 Prerequisite (knowledge, skills, attitudes and values) .....	89
5.3 Cross-cutting issues to be addressed .....	89
5.4 Guidance on the introductory activity .....	90
5.5 Teaching/learning resources; text books, flip charts, scotch. ....	91
5.6 Summary of the unit .....	102
5.7 Additional Information .....	103
5.8 End unit assessment .....	103
5.9: Additional activities .....	104

**UNIT 6: CIRCULATORY SYSTEM AND LYMPHATIC SYSTEM. .... 1 0 9**

6.1 Key Unit Competence..... 109  
6.2 Prerequisite (knowledge, skills, attitudes and values) ..... 109  
6.3 Cross-cutting issues to be addressed: ..... 109  
6.4 Guidance on the introductory activity. .... 110  
6.5 List of lessons/sub-heading (including assessment)..... 111  
6.6 Summary of the unit ..... 132  
6.7 Additional Information ..... 133  
6.8 End unit assessment 6..... 133  
6.9 Additional activities ..... 137

**UNIT 7: SKELETONS, MUSCLES AND MOVEMENT ..... 1 4 3**

7.1 Key Unit Competence..... 143  
7.2 Prerequisite (knowledge, skills, attitudes and values) ..... 143  
7.3 Cross-cutting issues to be addressed ..... 143  
7.4 Guidance to the introductory activity ..... 144  
7.5 List of lessons/sub-heading..... 144  
7.6 Summary of the unit ..... 156  
7.7 Additional Information ..... 157  
7.8 Answers for end unit assessment ..... 158  
7.9 Additional activities ..... 160

**UNIT 8: HUMAN REPRODUCTION ..... 1 6 5**

8.1 Key Unit Competence..... 165  
8.2 Prerequisites /Introduction/Revision ..... 165  
8.3 Cross-cutting issues ..... 165  
8.4 Guidance on introductory activity..... 165  
8.5 List of lessons ..... 166  
8.6 Summary of unit. .... 181  
8.7 Additional information for teachers..... 182  
8.8 Answers to the end of unit assessment..... 183  
8.9 Additional activities ..... 185



**UNIT 9: TESTING FOR BIOLOGICAL MOLECULES ..... 1 8 9**

9.1 Key unit competence ..... 189

9.2 Prerequisite (knowledge, skills, attitudes and values) ..... 189

9.3 Cross-cutting issues to be addressed ..... 189

9.4 Guidance on the introductory activity ..... 190

9.5 List of lessons/sub-heading..... 190

9.6 Summary of the unit ..... 196

9.7 Additional information ..... 196

9.8 Answers for end unit assessment ..... 197

9.9 Additional activity..... 200

**UNIT 10: CARBOHYDRATES AND LIPIDS ..... 2 0 5**

10.1 Key unit competence ..... 205

10.2 Prerequisite (knowledge, skills, attitudes and values) ..... 205

10.2 Cross-cutting issues to be addressed ..... 205

10.3 Guidance on the introductory activity ..... 205

10.4 Teaching/learning resources ..... 206

10.5 List of Lessons/sub-heading ..... 206

10.6 Summary of the unit..... 214

10.7 Additional information ..... 214

10.8 Answers for end unit assessment 7 ..... 214

10.9 Additional activities ..... 215

**UNIT 11: PROTEINS AND WATER ..... 2 1 9**

11.1 Key unit competence ..... 219

11.2 Prerequisites (knowledge, skills, attitudes and values) ..... 219

11.3 Cross-cutting issues to be addressed ..... 219

11.4 Guidance on the introductory activity ..... 219

11.5 List of Lessons/sub-heading. .... 220

11.6 Summary of the unit..... 223

11.7 Answers for end unit assessment. .... 224

11.8 Additional activities ..... 224

**UNIT 12: VITAMINS AND MINERALS..... 2 2 7**

12.1 Key Unit Competence ..... 227  
12.2 Prerequisites (Knowledge, skills, attitudes and values)..... 227  
12.3 Cross-cutting issues to be addressed ..... 227  
12.4 Guidance on the introductory activity ..... 229  
12.5 List of lessons/sub-heading ..... 229  
12.6 Summary of unit ..... 235  
12.7 Additional information ..... 236  
12.8 Answers for End unit assessment 9 ..... 236  
12.9 Additional activities ..... 236

**UNIT 13: ENZYMES ..... 2 3 9**

13.1 Key unit competence ..... 239  
13.2 Prerequisites (knowledge, skills, attitudes and values) ..... 239  
13.3 Cross-cutting issues to be addressed ..... 239  
10.4 Guidance on the introductory activity ..... 239  
13.5 List of lessons/sub-heading ..... 239  
13.6 Summary of the unit 13..... 247  
13.7 Additional information ..... 247  
13.8 Answers for End unit assessment 10 ..... 251  
13.9 Additional activities ..... 254

**UNIT 14: PRINCIPLES OF GAS EXCHANGE SYSTEMS ..... 2 6 1**

14.1 Key Unit Competence ..... 261  
14.2 Prerequisites (knowledge, skills, attitudes and values) ..... 261  
14.3 Cross-cutting issues to be addressed ..... 261  
14.4 Guidance on the introductory activity ..... 261  
14.5 List of lessons/sub-heading ..... 262  
14.6 Summary of unit ..... 268  
14.7 Additional information ..... 268  
14.8 Answers for End unit assessment ..... 270  
14.9 Additional activities ..... 272

<b>UNIT 15: GAS EXCHANGE IN PLANTS .....</b>	<b>277</b>
15.1 Key unit competence .....	277
15.2 Prerequisite (knowledge, skills, attitudes and values) .....	277
15.3 Cross-cutting issues to be addressed .....	277
15.4 Guidance on the introductory activity .....	277
15.5 List of lessons .....	278
15.6 Summary of the unit .....	282
15.7 Additional information .....	283
15.8 Answers of end unit assessment .....	285
15.9 Additional activities .....	286
<b>UNIT 16 : SUPPORT AND LOCOMOTION .....</b>	<b>289</b>
16.1 Key unit competence .....	289
16.2 Prerequisite (knowledge, skills, attitudes and values) .....	289
16.3 Cross-cutting issues to be addressed .....	289
16.4 Guidance on the introductory activity .....	290
16.5 List of Lessons .....	291
16.6 Summary of the unit .....	300
16.7 Additional information .....	301
16.8 Answers for End unit assessment .....	301
16.9 Additional activities .....	303
<b>UNIT 17: CLASSIFICATION AND PATTERNS OF DISEASE .....</b>	<b>307</b>
17.1 Key unit competence .....	307
17.2 Prerequisite (knowledge, skills and attitudes) .....	307
17.3 Cross-cutting issues to be addressed .....	307
17.4 Guidance on the introductory activity .....	308
17.5 List of lessons/sub-heading .....	309
17.6 Summary of the unit .....	319
17.7 Additional Information for teacher .....	319
17.8 Answers for end unit assessment .....	320
17.9 Additional activities .....	321

<b>UNIT 18: MICROBIOLOGY .....</b>	<b>3 2 7</b>
18.1 Key Unit Competence .....	327
18.2 Prerequisite (knowledge, skills and attitudes) .....	327
18.3 Cross-cutting issues to be addressed .....	327
18.4 Guidance on the introductory activity .....	328
18.5 List of lessons/sub-heading .....	329
18.6 Summary of the unit .....	341
18.7 Additional Information for teachers .....	342
18.8 Answers for end unit assessment 18 .....	342
18.9 Additional activities .....	344
<b>UNIT 19: CULTURING MICROORGANISMS .....</b>	<b>3 5 1</b>
19.1 Key unit competence: .....	351
19.2 Prerequisites .....	351
19.3 Cross-cutting issues to be addressed: .....	351
19.4 Guidance on the introductory activity .....	352
19.5 List of lessons .....	353
19.6 Unit summary .....	362
19.7 Additional Information .....	363
19.8 Answers for end unit assessment 19 .....	363
19.9 Additional activities 19 .....	366
<b>UNIT 20: BIOTECHNOLOGY AND ITS APPLICATION .....</b>	<b>3 7 1</b>
20.1 Key Unit Competence .....	371
20.2 Prerequisite .....	371
20.3 Cross-cutting issues to be addressed .....	371
20.4 Guidance on the introductory activity .....	372
20.5 List of lessons .....	372
20. 6 Summary of the unit .....	382
20.7 Additional information for the teacher .....	383
20.8 Answers of end unit assessment .....	383
20.9 Additional activity .....	385

# I. GENERAL INTRODUCTION

Rwanda is striving to build a knowledge-based economy, with particular emphasis on science and technology as engine for socio-economic development. One of the national priorities in the education system is to ensure that the quality of education continues to improve through closer integration of curriculum development, quality assurance and assessment, improved supply of learning materials, particularly text books, and improved teaching and learning strategies.

The Nation has reviewed its curricula and teaching methods in order to equip the critical mass of young people and population as whole with knowledge, skills and attitudes to be highly competitive in the region and global market. Therefore, since 2015 a competence-based curriculum has been put in place to drive the nation to the economic development it desires as it is stipulated in vision 2020.

This Biology Teaching Guide was collaboratively developed and reviewed by educators from public and private schools, colleges, and universities. Teaching Guide was studied and reviewed by education curriculum developers and pedagogy experts, and was improved with appropriate methodologies and strategies. Rwanda Education Board believes that teachers are the most important partners in improving education quality and key factor in determining learners' success. Incorporated in this Teaching Guide is a framework that will guide them in creating lessons and assessment tools, support them in facilitating activities and questions, and assist them towards deeper content areas and competencies to be achieved by the learners.

Through this Teaching Guide, teachers will be able to facilitate an understanding of the value of the lessons, for each learner to fully engage in the content on both the cognitive, psychomotor and affective levels of learning.

Teachers should also aim for deep understanding of the subject matter where they lead learners to analyze and synthesize knowledge. When teachers empower learners to take ownership of their learning, they develop independence and self- direction, learning about both the subject matter and themselves.

This Teaching Guide is mapped and aligned to the National Curriculum, designed to be highly usable for teachers. It contains classroom activities and pedagogical notes, and is integrated with innovative pedagogies. All of these features are presented in the different parts of this guide which provides also a hands-on/laboratory activity, connecting to a real-life problem and show step-by-step solutions to sample problems in each unit.

## 1.1 Structure of the guide

This section presents the overall structure, the unit and sub-heading structure to help teachers to understand the different sections of this guide and what they will find in each section.

## Overall structure

The whole guide has three main sections as follow:

### Section 1: Methodology

This section provides general guidance, on methodology how to develop the generic competences, how to integrate cross cutting issues, how to cater for learners with special educational needs, active methods and techniques of teaching biology and guidance on assessment.

### Section 2: Sample lesson plan

This part provides a sample lesson plan, developed and designed to help the teacher develop their own lesson plans.

### Section 3: Unit development

This is the core part of the guide. Each unit is developed following the structure below. The guide ends with references.

#### 1) Structure of a unit

Each unit is made up of the following sections:

- **Unit title:** from the syllabus
- **Key unit competence:** from the syllabus
- Prerequisites (knowledge, skills, attitudes and values)
- This section indicates knowledge, skills and attitudes required for the success of the unit. The competence-based approach calls for connections between units/topics within a subject and interconnections between different subjects. The teacher will find an indication of those prerequisites and guidance on how to establish connections.
- Cross-cutting issues to be addressed
- This section suggests cross cutting issues that can be integrated depending on the unit content. It provides guidance on how to come up with the integration of the issue. Note that the issue indicated is a suggestion; teachers are free to take another cross-cutting issue taking into consideration the learning environment.
- Guidance on the introductory activity
- Each unit starts with an introductory activity in the learner's book. This section of the teacher's guide provides guidance on how to conduct this activity and related answers. Note that learners may not be able to find the right solution but they are invited to predict possible solutions or answers. Solutions are

provided by learners gradually through discovery activities organized at the beginning of lessons or during the lesson.

- List of lessons/sub-heading
- This section presents in a table a list of lessons that are in a unit, lesson objectives copied or adapted from the syllabus and duration for each lesson. Each lesson /subheading is then developed.
- End of each unit
- At the end of each unit the teacher's guide provides the following sections:
- **Summary** of the unit which provides the key points of content developed in the student's book.
- **Additional information** which provides additional content compared to the student's book for the teacher to have a deeper understanding of the topic.
- **End of unit assessment** which provides the answers to questions of end unit assessment in the textbook and suggests additional questions and related answers to assess the key unit competence.
- **Additional activities:** remedial, consolidation and extended activities). The purpose of these activities is to accommodate each learner (slow, average and gifted) based on end unit assessment results.
- Structure of each sub heading
- Each lesson/sub-heading is made of the following sections:
- Lesson /Sub heading title 1...
- Prerequisites/Revision/Introduction:
- This section gives a clear instruction to teacher on how to start the lesson
- Teaching resources
- This section suggests the teaching aids or other resources needed in line with the activities to achieve the learning objectives. Teachers are encouraged to replace the suggested teaching aids by the available ones in their respective schools and based on learning environment.
- Learning activities
- This section provides a short description of the methodology and any important aspect to consider. It provides also answers to learning activities with cross reference to text book:
- Exercises/application activities/self -assessment
- This provides questions and answers for exercises/ application activities/**self-assessment**

## 1.2 Methodological guidance

### 1.2.1 Developing competences

The competence-based curriculum employs an approach of teaching and learning based on discrete skills rather than dwelling on only knowledge or the cognitive domain of learning. It focuses on what learner can do rather than what learners know. Learners develop basic competences through specific subject unit competences with specific learning objectives broken down into knowledge, skills and attitudes. These competences are developed through learning activities disseminated in learner-centered rather than the traditional didactic approach. The student is evaluated against set standards to achieve a specific unit competence before moving onto the next unit.

In addition to specific subject competences, learners also develop generic competences which are transferable throughout a range of learning areas and situations in life. Below is example of how generic competences can be developed in **biology**:

Generic competence	Examples of activities that develop generic competences
Critical thinking	Classifying living organisms Observe, record, interpret data recorded during experiments Choose the best reagent to test for a substance or to distinguish substances Collect, observe and identify specimens. Compare and contrast between biological concepts
Research and Problem solving	Research using internet or books from the library Design a project for health and disease Design a questionnaire for data collection during field visit



Innovation and creativity	<p>Develop a graph to illustrate information</p> <p>Design a data collection survey/questionnaire</p> <p>Conduct experiments with objectives, methodology, observations, results, conclusions</p> <p>Identify local problems related with biology such as malnutrition and ways to resolve them</p>
Cooperation, Personal and Interpersonal management and life skills	<p>Work in Pairs</p> <p>Small group work</p> <p>Large group work</p>
Communication	<p>Organize and present in writing and verbally a complete and clear report of an experiment</p> <p>Observe, record, interpret the results of a measurement accurately.</p> <p>Select and use appropriate formats and presentations, such as tables, graphs and diagrams.</p>
Lifelong learning	<p>Exploit all opportunities available to improve on knowledge and skills. Reading scientific journals to keep updated.</p>

### a) Critical Thinking

- These are activities that require students to think critically about subject content. Groups can be organized to work in different ways e.g. taking turns, listening, taking decisions, allocating tasks, disagreeing constructively etc.
- Collect data locally through designing surveys, questionnaires, interview formats then analyse data, draw conclusions and present findings
- Observe, record, interpret – e.g. Mark out areas in the school and get different groups to record insect, animal, bird life and then to try to explain why different habitats have different species Experiment
- Research and discuss
- Compare and contrast exercises
- Debate (see communication)
- Identify a problem and design a methodology to collect the information needed to solve the problem
- Make basic science equipment out of locally available materials

- Reasoning games and tests for students

## **b) Research and problem solving**

- Use the internet and a library
- Create a school library
- Collect data through observation and recording
- Collect data through surveys, questionnaires and different kinds of interviews
- Develop sampling rules for data collection

## **c) Creativity and Innovation**

- Write a story or poem
- Design a poster
- Write and design a booklet
- Make a model
- Create an experiment to prove a point
- Invent new ways of doing traditional things
- Design your ideal house
- Develop a graph to illustrate information
- Create a flow chart to show the main stages in a process
- Design a data collection survey/questionnaire
- Identify a problem which requires data collection to solve
- Conduct experiments with objectives, methodology, observations, results, conclusions
- Make hypotheses and identify ways to test them
- Identify local problems and devise ways to resolve them

## **d) Communication Skills**

- Tell/write a story, poem or drama
- Describe an event or situation
- Present ideas - verbally, in writing, graphically, digitally
- Set out pros and cons
- Argue a case – verbally, in writing, graphically (compare and contrast), digitally
- Observe, record, interpret
- Write letters for different purposes

**e) Teamwork, cooperation, personal and interpersonal management and life skills, work in pairs** – particularly useful for shared reading and comprehension in lower grades but can also be useful in higher grades for planning research, problem solving, planning experiments etc.

- Small group work
- Large group work
- Data collection from the community
- Collect community photographs and interview residents to make a class/school history of the local community

Note: The teacher’s guide should improve support in the organisation and management of groups

### **f) Lifelong Learning**

- Take initiative to update knowledge and skills with minimum external support.
- Cope with the evolution of knowledge and technology advances for personal fulfilment
- Seek out acquaintances more knowledgeable in areas that need personal improvement and development
- Exploit all opportunities available to improve on knowledge and skills.

#### **1.2.2 Addressing cross cutting issues**

Among the changes in the competence based curriculum is the integration of cross cutting issues as an integral part of the teaching learning process-as they relate to and must be considered within all subjects to be appropriately addressed. The eight cross cutting issues identified in the national curriculum framework are:

##### **a) Genocide Studies**

Genocide Studies provides young people with an understanding of the circumstances leading to the genocide and the remarkable story of recovery and re-establishing national unity. Genocide Studies helps learners to comprehend the role of every individual in ensuring nothing of the sort ever happens again.

##### **b) Environment and sustainability**

The growing awareness of the impact of the human race on the environment has led to recognition of the need to ensure our young people understand the importance of sustainability as they grow up and become responsible for the world around them. Hence Environment and Sustainability is a very important cross-cutting issue. Learners need basic knowledge from the natural sciences, social sciences and humanities to

understand and interpret principles of sustainability. They also need skills and attitudes that will enable them in their everyday life to address the environment and climate change issues and to have a sustainable livelihood.

### **c) Gender**

There is a strong moral imperative to afford every individual their basic human rights and gender inequality results in women and girls being treated less favourably than men. A strongly negative impact of unequal treatment which affects the nation as a whole is the fact that it results in women being held back and their talents and abilities not being fully realised. With a good understanding of the principles of Gender Equality, it is intended that future generations will ensure that the potential of the whole population is realised.

### **d) Comprehensive sexuality education (HIV/AIDS, STI, Family planning, Gender equality and reproductive health)**

Comprehensive sexuality education which is age appropriate, gender sensitive and life skills based can provide young people with the knowledge and skills to make informed decisions about their sexuality and life style. Preparing children and young people for the transition to adulthood has been one of humanity's great challenges with human sexuality and relationships at its core. Few young people receive adequate preparations for their sexual lives. This leaves them potentially vulnerable to coercion, abuse and exploitation. Unintended pregnancy and sexually transmitted infection (STI) including HIV/AIDS. Many young people approach adulthood faced with conflicting and confusing messages about sexuality and gender. This is often exacerbated by embarrassment, silence, disapproval and open discussion of sexual matters by adults (parents, teachers) at very time when it is most needed. Comprehensive sexuality education supports a rights-based approach in which values such as respect, acceptance tolerance, equality, empathy and reciprocity are inextricably linked to universally agreed human right. A clear message concerning these dangers and how they can be avoided, from right across the curriculum, is the best way to ensure that young people understand the risks and know how to stay healthy.

### **e) Peace and Values Education**

The need for peace and values education in the curriculum is obvious. Peace is clearly critical for society to flourish and for every individual to focus on personal achievement and their contribution to the success of the nation. Values education forms a key element of the strategy for ensuring young people recognize the importance of contributing to society, working for peace and harmony and being committed to avoiding conflict.

### **f) Financial Education**

Financial education makes a strong contribution to the wider aims of education. It

makes learning relevant to real life situations. It aims at a comprehensive financial education program as a precondition for achieving financial inclusion target and improves the financial capability of Rwandans. Financial education has a key role of not only improving knowledge of personal but also transforming this knowledge into action.

It provides the tools for sound money management practices on earnings, spending, saving, borrowing and investing. Financial education enables people to take appropriate financial services both formal and informal that are available to them and encourages financial behaviors that enhance their overall economic wellbeing.

### **g) Standardization Culture**

Standardization Culture develops learners' understanding of the importance of standards as a pillar of economic development and in the practices, activities and lifestyle of the citizens. It is intended that the adoption of standardization culture should have an impact upon health improvement, economic growth, industrialization, trade and general welfare of the people. While education is the foundation and strength of our nation, standards are one of the key pillars of sustainable economic development.

### **h) Inclusive Education**

Inclusive education involves ensuring all learners are engaged in education and that they are welcomed by other students so that everyone can achieve their potential. Inclusive practice embraces every individual regardless of gender or ability including those with learning difficulties and disabilities. The almost focus of inclusive curriculum is on ensuring participation in education of learners with different learning styles and other difficulties. To be successful, it entails a range of issues including teacher's positive attitudes, adapting the learning resources, differentiation of teaching and learning methods and working together. Overall the benefits of an inclusive curriculum extend to all learners.

Some cross cutting issues may seem specific to particular learning areas/subjects but the teacher need to address all of them whenever an opportunity arises. In addition, learners should always be given an opportunity during the learning process to address these cross cutting issues both within and out of the classroom.

Below are examples on how crosscutting issues can be addressed in your subject:

Cross-cutting issue	Examples on how to integrate the cross-cutting issue
Inclusive education	<p>Involve all learners in all activities without any bias.</p> <p>E.g. allow a learner with physical disability (using wheelchair) to take notes or lead the team during an experiment.</p>
Gender	<p>Involve both girls and boys in all activities: No activity is reserved only to girls or boys.</p> <p>Teachers should ensure equal participation of both girls and boys during experiments as well as during cleaning and tidying up related activities after experiments.</p>
Peace and Values Education	<p>During group activities, debates and presentations, the teacher will encourage learners to help each other and to respect opinions of colleagues.</p>
Standardization culture	<p>Some lessons involve carrying out experiments. Instruction should be clear for learners to always check if they are not using expired chemicals or defective apparatus.</p> <p>In addition, when performing experiments learners have to record data accurately.</p> <p>For tasks involving calculations, they have to always present accurate results.</p>
Environment and sustainability	<p>In order to avoid the environment pollution, before, during or after experiments learners avoid throwing away chemicals anywhere; special places or appropriate containers should be used.</p> <p>Learners have to avoid uprooting /cutting down of plants and killing of animals</p>

### 1.2.3 Attention to special educational needs specific and inclusive education

In the classroom, learners learn in different way depending to their learning pace, needs or any other special problem they might have. However, the teacher has the responsibility to know how to adopt his/her methodologies and approaches in order to meet the learning needs of each student in the classroom. Also teachers need to understand that learners with special needs, need to be taught differently or need some accommodations to enhance the learning environment. This will be done depending to the subject and the nature of the lesson.

In order to create a well-rounded learning atmosphere, teachers need to:

- Remember that learners learn in different ways so they have to offer a variety of activities (e.g. role-play, music and singing, word games and quizzes, and outdoor activities);
- Maintain an organized classroom and limits distraction. This will help learners with special needs to stay on track during lesson and follow instruction easily;
- Vary the pace of teaching to meet the needs of each learner. Some learners process information and learn more slowly than others;
- Break down instructions into smaller, manageable tasks. Learners with special needs often have difficulty understanding long-winded or several instructions at once. It is better to use simple, concrete sentences in order to facilitate them understand what you are asking.
- Use clear consistent language to explain the meaning (and demonstrate or show pictures) if you introduce new words or concepts;
- Make full use of facial expressions, gestures and body language;
- Pair a learner who has a disability with a friend. Let them do things together and learn from each other. Make sure the friend is not over protective and does not do everything. Both learners will benefit from this strategy;
- Use multi-sensory strategies. As all learners learn in different ways, it is important to make every lesson as multi-sensory as possible. Learners with learning disabilities might have difficulty in one area, while they might excel in another. For example, use both visual and auditory cues.

Below are general strategies related to each main category of disabilities and how to deal with every situation that may arise in the classroom. However, the list is not exhaustive because each learner is unique with different needs and that should be handled differently.

### **Strategy to help a learner with developmental impairment:**

- Use simple words and sentences when giving instructions;
- Use real objects that the learner can feel and handle. Rather than just working abstractly with pen and paper;
- Break a task down into small steps or learning objectives. The learner should start with an activity that s/he can do already before moving on to something that is more difficult;
- Gradually give the learner less help;
- Let the learner work in the same group with those without disability.

## **Strategy to help a learner with visual impairment:**

- Help learners to use their other senses (hearing, touch, smell and taste) to play and carry out activities that will promote their learning and development;
- Use simple, clear and consistent language;
- Use tactile objects to help explain a concept;
- If the learner has some sight, ask them what they can see;
- Make sure the learner has a group of friends who are helpful and who allow him/her to be as independent as possible;
- Plan activities so that learners work in pairs or groups whenever possible.
- Strategy to help a learner with hearing impairment:
  - Strategies to help learners with hearing disabilities or communication difficulties;
  - Always get the learner 's attention before you begin to speak;
  - Encourage the learner to look at your face;
  - Use gestures, body language and facial expressions;
  - Use pictures and objects as much as possible;
  - Ask the parents/caregivers to show you the signs they use at home for communication use the same signs yourself and encourage other learners to also use them;
- Keep background noise to a minimum.

## **Strategies to help a learner with physical disabilities or mobility difficulties:**

- Adapt activities so that learners who use wheelchairs or other mobility aids, or other learners who have difficulty moving, can participate;
- Ask parents/caregivers to assist with adapting furniture e.g. The height of a table may need to be changed to make it easier for a learner to reach it or fit their legs or wheelchair under;
- Get advice from parents or a health professional about assistive devices.

## **Adaptation of assessment strategies**

Each unit in the teacher's guide provides additional activities to help learners achieve the key unit competence. Results from assessment inform the teacher which learner needs remedial, consolidation or extension activities. These activities are designed to cater for the needs of all categories of learners; slow, average and gifted learners respectively.



#### 1.2.4 Guidance on assessment

Assessment is an integral part of teaching and learning process. The main purpose of assessment is for improvement. Assessment for **learning/ Continuous/ formative assessment** intends to improve learners' learning and teacher's teaching whereas assessment of learning/summative assessment intends to improve the entire school's performance and education system in general.

#### Continuous/ formative assessment

It is an ongoing process that arises out of interaction during teaching and learning between. It includes lesson evaluation and end of sub unit assessment. This formative assessment should play a big role in teaching and learning process. The teacher should encourage individual, peer and group evaluation of the work done in the classroom and uses appropriate competence-based assessment approaches and methods.

#### Summative assessment

The assessment can serve as summative and formative depending to its purpose. The end unit assessment will be considered summative when it done at end of unit and want to start a new one. It will be formative assessment, when it is done in order to give information on the progress of students and from there decide what adjustments need to be done. The assessment done at the end of the term, end of year, is considered as summative assessment so that the teacher, school and parents are informed of the achievement of educational objective and think of improvement strategies. There is also end of level/ cycle assessment in form of national examinations.

#### 1.2.5 Students' learning styles and strategies to conduct teaching and learning process

There are different teaching styles and techniques that should be catered for. The selection of teaching method should be done with the greatest care and some of the factors to be considered are: the uniqueness of subjects; the type of lessons; the particular learning objectives to be achieved; the allocated time to achieve the objective; instructional materials available; the physical/sitting arrangement of the classroom, individual students' needs, abilities and learning styles. There are mainly **four different learning styles** as explained below:

##### a) Active and reflective learners

**Active learners** tend to retain and understand information best by doing something active with it—discussing or applying it or explaining it to others. **Reflective learners** prefer to think about it quietly first.

## b) Sensing and intuitive learners

**Sensing learners** tend to like learning facts; **intuitive learners** often prefer discovering possibilities and relationships. Sensors often like solving problems by well-established methods and dislike complications and surprises; intuitive learners like innovation and dislike repetition.

## c) Visual and verbal learners

Visual learners remember best what they see—pictures, diagrams, flow charts, time lines, films, demonstrations, etc.; verbal learners get more out of words—written and spoken explanations.

## d) Sequential and global learners

**Sequential learners** tend to gain understanding in linear steps, with each step following logically from the previous one. **Global learners** tend to learn in large jumps, absorbing material almost randomly without seeing connections, and then suddenly “getting it.”

### 1.2.6 Teaching methods and techniques that promote the active learning

The different student learning styles mentioned above can be catered for, if the teacher uses active learning whereby learners are really engaged in the learning process.

#### What is Active learning?

Active learning is a pedagogical approach that engages students in doing things and thinking about the things they are doing. In active learning, learners are encouraged to bring their own experience and knowledge into the learning process.

#### The role of the teacher in active learning

- The teacher engages learners through active learning methods such as inquiry methods, group discussions, research, investigative activities and group and individual work activities.
- He/she encourages individual, peer and group evaluation of the work done in the classroom and uses appropriate competence-based assessment approaches and methods.
- He provides supervised opportunities for learners to develop different competences by giving tasks which enhance critical thinking, problem solving, research, creativity and innovation, communication and cooperation.
- Teacher supports and facilitates the learning process by valuing learners' contributions in the class activities.

## **The role of learners in active learning**

Learners are key in the active learning process. They are not empty vessels to fill but people with ideas, capacity and skills to build on for effective learning. A learner engaged in active learning:

- Communicates and shares relevant information with other learners through presentations, discussions, group work and other learner-centred activities (role play, case studies, project work, research and investigation)
- Actively participates and takes responsibility for their own learning
- Develops knowledge and skills in active ways
- Carries out research/investigation by consulting print/online documents and resourceful people, and presents their findings
- Ensures the effective contribution of each group member in assigned tasks through clear explanation and arguments, critical thinking, responsibility and confidence in public speaking
- Draws conclusions based on the findings from the learning activities.

### **Main steps for a lesson in active learning approach**

All the principles and characteristics of the active learning process highlighted above are reflected in steps of a lesson as displayed below. Generally, the lesson is divided into three main parts whereby each one is divided into smaller steps to make sure that learners are involved in the learning process. Below are those main part and their small steps:

#### **1) Introduction**

Introduction is a part where the teacher makes connection between the current and previous lesson through appropriate technique. The teacher opens short discussions to encourage learners to think about the previous learning experience and connect it with the current instructional objective. The teacher reviews the prior knowledge, skills and attitudes which have a link with the new concepts to create good foundation and logical sequencings.

#### **2) Development of the new lesson**

The development of a lesson that introduces a new concept will go through the following small steps: discovery activities, presentation of learners' findings, exploitation, synthesis/summary and exercises/application activities, explained below:

## **a) Discovery activity**

### **Step 1**

- The teacher discusses convincingly with students to take responsibility of their learning
- He/she distributes the task/activity and gives instructions related to the tasks (working in groups, pairs, or individual to instigate collaborative learning, to discover knowledge to be learned)

### **Step 2**

- The teacher let the students work collaboratively on the task.
- During this period the teacher refrains to intervene directly on the knowledge
- He/she then monitors how the students are progressing towards the knowledge to be learned and boost those who are still behind (but without communicating to them the knowledge).

## **b) Presentation of learners' productions**

- In this episode, the teacher invites representatives of groups to presents the students' productions/findings.
- After three/four or an acceptable number of presentations, the teacher decides to engage the class into exploitation of the students' productions.

## **c) Exploitation of learner's productions**

- The teacher asks the students to evaluate the productions: which ones are correct, incomplete or false
- Then the teacher judges the logic of the students' products, corrects those which are false, completes those which are incomplete, and confirms those which correct.

## **d) Institutionalization (summary/conclusion/ and examples)**

- The teacher summarises the learned knowledge and gives examples which illustrate the learned content.

## **e) Exercises/Application activities**

- Exercises of applying processes and products/objects related to learned unit/sub-unit
- Exercises in real life contexts
- Teacher guides learners to make the connection of what they learnt to real life situations. At this level, the role of teacher is to monitor the fixation of process and product/object being learned.

### 3) Assessment

In this step the teacher asks some questions to assess achievement of instructional objective. During assessment activity, learners work individually on the task/activity. The teacher avoids intervening directly. In fact, results from this assessment inform the teacher on next steps for the whole class and individuals. In some cases, the teacher can end with a homework assignment.

## II. SAMPLE LESSON PLAN

### Sample lesson

Teacher’s Name:..... School Name: .....

Term	Date	Subject	Class	Unit N°	Lesson N°	Duration	Class size
I	23 <sup>rd</sup> Feb 2018	Biology	S <sub>4</sub> PCB	4	1 of 5	80 minutes	25 students
Type of Special Educational Needs and number of learners				No one			
Topic area:		ORGANISATION AND MAINTENANCE OF LIFE  Cell structure  Cell structure and specialization.  To able to describe the structure and function of cells in an organism.  Ultrastructure of animal cell and plant cell.  In laboratory  Using microscopes and prepared micrographs or diagrams containing the structures of animal cell and plant cell, students will be able to differentiate accurately between animal cell and a plant cell.  Microscopes, micrographs, pens and papers					
Sub-topic area:							
Unit title							
Key Unit Competence:							
Title of the lesson							
Plan for this Class (location: in / outside)							
Instructional Objectives							
Learning Materials							

References	<p>1. Rwanda Education Board (2015). Advanced Level Biology Syllabus (S4-S6). Kigali</p> <p>2. Kent M. (2000). Advanced Biology. Oxford University Press, Oxford, UK.</p> <p>3. Campbell, N.A, et al. (2008). Biology, Pearson international Edition, San Francisco, USA, 8<sup>th</sup> edition</p> <p>4. Pete K. Frank S. (2008). OCR Biology. Pearson Education Limited. British.</p> <p>5. Miller, Levine (2008). Prentice Hall Biology. Pearson Education. USA.</p>
------------	--

Timing for each step	Description of teaching and learning activity: The activities of this lesson will be conducted in groups in laboratory.		Competences and cross cutting issues to be addressed
	Teacher's activities	Learner's activities	
1. Introduction: In 5 minutes.	<p>Asking some questions:</p> <ul style="list-style-type: none"> <li>- What are the parts of a light microscope?</li> <li>- Explain the function of each part?</li> <li>- What is the function of a microscope?</li> <li>- Relate the function of microscope with the lesson.</li> </ul>	<ul style="list-style-type: none"> <li>- Give answers.</li> <li>- Listening how teacher relate the function of microscope with the study of structure of cells</li> </ul>	<p>Competences:</p> <ul style="list-style-type: none"> <li>- Critical thinking</li> <li>- Communication</li> </ul>
<b>2. Development of the lesson: in 45 minutes</b>			
2.1. Discovery activity	<ul style="list-style-type: none"> <li>- Ask students to form three groups.</li> <li>- Provide materials and instructions to students.</li> <li>- Monitor how the students are progressing towards the knowledge, skills and attitudes to be learned and boost those who are still behind (but without communicating to them the knowledge).</li> </ul>	<ul style="list-style-type: none"> <li>- Form three groups and share responsibility.</li> <li>- Taking materials needed for this activity.</li> <li>- Students work collaboratively on the task.</li> <li>- Both boys and girls participate actively.</li> </ul>	<p>Competences:</p> <ul style="list-style-type: none"> <li>- Problem solving</li> <li>- communication,</li> <li>- manipulation,</li> <li>- cooperation,</li> <li>- Critical thinking</li> </ul> <p>Cross cutting issue:</p> <ul style="list-style-type: none"> <li>- Peace and value.</li> <li>- Financial education</li> </ul>

2.2. presentation of findings	Invite representatives of groups to presents their findings.	<ul style="list-style-type: none"> <li>- Representatives of groups to presents their findings.</li> <li>- Others follow to the presentation</li> </ul>	Communication
2.3. Exploitation of students findings	<ul style="list-style-type: none"> <li>- Ask students to evaluate the productions: which ones are correct, incomplete or false</li> <li>- Judge the logic of the students' products, corrects those which are false, completes those which are incomplete, and confirms those which correct.</li> </ul>	<ul style="list-style-type: none"> <li>- Give comments on productions.</li> <li>- Follow to the correction of teacher.</li> </ul>	Communication
2.4. Conclusion: In 20 minutes	- Summarise the learned knowledge, and give more clarification on the learned content.	<ul style="list-style-type: none"> <li>- Participate actively in summarizing the content.</li> <li>- Making short notes.</li> </ul>	<ul style="list-style-type: none"> <li>- Listening skills</li> <li>- Writing skills</li> </ul>
3. Assessment: in 10 minutes.	- Engage students to work individually on questions of the self-assessment 4.1 in students' text books	- Do exercises as indicated in students' text books.	Competences: Creativity
Comments on the lesson delivery			

### **III. UNIT DEVELOPMENT**



## 1.1 Key unit competence

To be able to explain how diversity is threatened by climate change and human activities

## 1.2 Prerequisite (knowledge, skills, attitudes and values)

The learners learnt biodiversity in senior two in introduction to environmental Biology. Remind learner's biodiversity they have learnt in senior two but were not detailed. Review biodiversity and provide to the learners more detailed information. During the lessons, create awareness in learners the fact that the content in this unit will help the learner to gain knowledge, skills attitudes and values which can lead the learners to be environmental specialists.

## 1.3 Cross-cutting issues to be addressed

### a) Inclusive education

This unit involves a collection of specimens and activities require observations on figures on the proper use of introduction to biodiversity. These activities require assembling specimens, apparatus and observation of the results. This may be challenging to students with special educational needs especially children with visual impairment. However, the teacher can make some arrangements like:

Grouping students. Students with special educational needs are group with others and assigned roles basing on individual student's abilities.

Providing procedure earlier before the experiment so that students get familiar with them. They can be written on the chalkboard or printed depending on available resources. If you have children with low vision remember to print in appropriate fonts.

Every important point is written and spoken. The written points help students with visual impairment and speaking aloud helps students with hearing impairment

Remember to repeat the main points of the lessons.

## b) Gender education

Emphasize to learners that anybody irrespective of their gender can present and report during group activities. Give a role model who are successful in real life without considering their gender, make sure that during experiments both boys and girls shares and participates equally in all activities

## c)Environment and sustainability

Learners get basic knowledge from the natural sciences, so introductory to biodiversity through collections of specimens, learners understand and interpret principles of sustainability. They also get skills and attitudes that will enable them in their everyday life to address the environment and climate change issues and to have a sustainable livelihood. Help the learners to know maximum skills and attitudes on the environmental sustainability and to be responsible in caring for students environment.

### 1.4 Guidance on the introductory activity

This introductory activity helps you to engage learners in the introduction of biodiversity and invite the learners to follow the next lessons.

#### Teacher's activity:

- Ask students to read the text and discuss the given questions.
- Engage students in working collectively the activity.
- Help students with different problems.
- Ask any four students to present their findings while others are following.

#### The expected answers

1) The expected answer is:

a) *Nymphaea thermarum*, Found in Mashyuza a small locality in western province in Rusizi district

2) The expected answer is:

Nyamanyumba hot spring in Rubavu District

3) The expected answers are:

**a) Species** is a group of closely related organisms which are capable of interbreeding to produce fertile offspring

**b) Population** is a group of Individuals of the same species

**c) Community** is a group of populations of different species which live in the same place at the same time, and interact with each other

**d) Habitat** is a specific area or place in which an individual organism lives

4) Introduction of invasive alien species and genetically modified organisms, Pollution, Climate change, Overexploitation of natural resources, Habitat loss and the degradation of the environment...

5) They are various consequences of species loss such as: -change in ecosystem goods and services that lead to different natural disasters including droughts and floods associated to the decrease in food production, and high spread of diseases.

### 1.5 List of lessons/sub-heading

	Lesson title	Learning objectives (from the syllabus including knowledge, skills and attitudes):	Number of periods
1	The meaning of key ecological term and biodiversity	Define the terms: species, ecosystem, Biodiversity, and niche.	1
2	Identification of biodiversity	<p>Explain that biodiversity is considered at three different levels:</p> <p>Variation in ecosystems or habitats.</p> <p>The number of species and their relative abundance.</p> <p>Genetic variation within each species</p> <p>Evaluate the effects of human population size, resource use, and technology on environmental quality.</p> <p>Evaluate the consequences of loss of biodiversity.</p> <p>Characterize the biotic and abiotic components that define Rwanda's ecosystems (e.g., freshwater, marine, and terrestrial).</p> <p>Acknowledge that Biodiversity is much more than a list of all the species in a particular area.</p> <p>Recognize that the biodiversity of the Earth is threatened by human activities and climate change.</p>	1

3	Calculation of Simpson index	Apply Simpson's Index of Diversity.	1
4	Importance of random sampling and Use of suitable methods to assess the distribution and abundance of organisms	<p>Explain the importance of random sampling in determining the biodiversity of an area.</p> <p>Use suitable survey methods to assess the distribution and abundance of organisms in a local area.</p> <p>Appreciate that fieldwork is an important part of a biological education.</p> <p>To appreciate diversity and find out how to analyse it.</p>	1
5	Spearman 'rank correlation and Pearson's linear correlation	Use Spearman's rank correlation and Pearson's linear correlation to analyse the relationships between the distribution and abundance of species and abiotic or biotic factors.	1
	Assessment	Proper explanation of how biodiversity is threatened by climate change and human activities	2

## Lesson 1: Meaning of key ecological terms and biodiversity

### a) Prerequisites/Revision/Introduction:

This is the first lesson of the first unit Introduction to Biodiversity. In this lesson you will be dealing with **the meaning of key ecological terms and biodiversity**. The first thing to do before starting teaching is to remind students that they have learnt about Species, Population, Community, Habitat, Ecosystem, Variation, Niche (unit 2, S2), and let them discuss the meaning of some ecological terms so that they can prepare themselves for this lesson

### b) Teaching resources

Student's book, graph charts, simulations and computer animations, projector, Manila paper papers and diagrams.

## c) Learning activities 1.1

### Teacher' activities

- Ask learners to do individually **activity 1.1** in their student books
- Provide the necessary materials.
- Move around in silence to monitor if they are having some problems
- Remember to assist those who are weak but without giving them the knowledge.
- Invites any three students to present their findings to the rest of students.
- Ask other students to follow carefully the presentations
- Note on chalk board / Manila paper the student's ideas.
- Tick the correct findings and correct those ones which are incorrect and try again to complete those which are incomplete.
- Harmonize and conclude on the learned knowledge and still engage students in making that conclusion

### Answers for activity 1.1

1) Definitions of biodiversity, species, niche, population and community.

- **Biodiversity** means variety of life on earth it includes all organisms, species and populations, the genetic variation among them; and their complex assemblages of communities and ecosystems.
- **Species** is a group of closely related organisms which are capable of interbreeding to produce fertile offspring.
- **Niche** is the status or role of an organism in its habitat or the mode of life of an organism within its habitats
- **Population** is a group of Individuals of the same species
- **Community** is a group of populations of different species which live in the same place at the same time, and interact with each other

2) Difference between ecological niche and habitat

Ecological niche	Habitat
Is the status or role of an organism in its habitat or the mode of life of an organism within its habitats	is a specific area or place in which an individual organism lives

## Answers for self-assessment 1.1

### Expected answers are:

The two main component of ecosystem are biotic factors and abiotic factors. Biotic factors, these include all of the living organisms in an ecosystem and the interactions among themselves. Their interactions involve; producers, consumers and decomposers. Abiotic components, also called abiotic factors which are the non-living physical aspects of the environment such as the sunlight, soil, temperature, wind, water, and air.

### Expected answer:

Ecological niche; this describes how an organism or population have access to distributed resources and interaction with competitors

## Lesson 2: Identification of biodiversity

### a) Prerequisites/Revision/Introduction:

This is the second lesson of the first unit Introduction to Biodiversity. In this lesson you will be dealing with identification of biodiversity. The first thing to do before starting teaching is to remind students that they have learnt about biotic and abiotic factors, ecosystem. and ask them to discuss their meaning so that they can prepare themselves for this lesson.

### b) Teaching resources

Students' books, graph charts, simulations and computer animations, projector, Manila papers diagrams.

### c) Learning activities

#### Teacher' activities

- Ask students to work in pair and do activity 1.2 in student's book.
- Provide the necessary materials to the learners.
- Move around in silence to monitor if they are having some problems, sharing ideas in pairs.
- Assist those who are weak but without giving them the knowledge.
- Invite any of the three pairs to present their findings to the rest of students.
- Ask other students to follow carefully the presentations
- Note on chalk board / manila paper the student's ideas.
- Tick the correct findings and correct those ones which are incorrect and try again to complete those which are incomplete.

- Harmonize and conclude on the learned knowledge and still engage students in making their own conclusion

### Answers of activity 1.2

#### 1) Hospital and School building

- Provision of health insurance to people from local communities.
- Continuous mobilization about the necessity of biodiversity conservation
- Develop television shows and other public media (Radio, Social media, Newspapers, etc.) to communicate biodiversity conservation messages
- Promote Environmental Education activities in schools to reach more people with biodiversity conservation messages.

#### 2) Different ways of biodiversity identification.

Biodiversity can be categorized into three groups including **genetic, species and ecological diversity**. Genetic diversity is the combination of different genes found within a population of a single species, and the pattern of variation found within different populations of the same species.

**Species diversity** is the variety and abundance of different types of organisms which inhabit an area. The variety of habitats that occur within a region, or within the mosaic of patches found within a landscape constitute an **ecosystem diversity**.

#### 3) Contribution of biodiversity to human well-being.

- Good health and productive livelihoods depend on ecosystem products and services, such as availability of fresh air, food, fuel sources, esthetic services, financial/economical gains, etc...

4) Ecosystem services and goods contribute positively in human health promotion, diseases prevention and public health. But, biodiversity loss and ecosystem change may limit discovery of new components of biodiversity used in traditional medicine and put at risk community health development.

### Answers for self-assessment 1.2

#### 1) Expected answers are:

Extinction: Extinction is when a species disappears, or is extinguished, from earth. Loss of habitat is the largest cause of extinction today.

#### 2) Causes of extinction of species are :

- Introduction of invasive alien species
- Pollution
- Overexploitation

- Climate change
- Etc.

Cause of extinction of species: Overharvesting, Pollution, habitat destruction, Inadvertent introduction of new predator and competitors to natural flora and fauna.

3) Expected answers are:

a) Benefits biodiversity: Biodiversity is important because it affects the air we breathe, the food we eat, how clean our drinking water is, and is the source of products that come from the earth. Biodiversity helps control disease, provides us with things we need, and can make us happy just by providing us with natural beauty.

4) Major factors leading to the degradation of ecosystems in Rwanda.

- Habitat loss and the degradation of the environment
- Introduction of invasive alien species and genetically modified organisms
- Pollution
- Climate change
- Overexploitation of natural resources

5) All living organisms' dependent on other species. For example: a rabbit needs grass to live. Humans need rabbit and grass to live. If humans do not eat rabbits, the grass dies. Well so do the rabbit, because there is no grass. And last left, are the humans. They die because rabbits die. Now as you can see, this is an ongoing cycle. If one thing goes, another does, and so on.

Forests on earth filter the usable water again and again, constantly recycling the water we use for drinking.

Ecosystems can affect what type of instruments people play, the kinds of decorations they use, and mythology.



## 6) Ten medicinal plants and specific the diseases they treat.

Medicinal plants	Treated diseases
Amla ( <i>Embllica officinalis</i> )	Diabetes, hyper acidity
Bilba ( <i>Aegle marmelous</i> )	Diarrhea, Dysentery, Constipation
Guggul ( <i>Commiphora wightii</i> )	Paralysis
Long peeper ( <i>Peeper longum</i> )	Enlarged spleen, Bronchitis
Sandal wood ( <i>Santalum album</i> )	Skin disorders, caught...
Satavari ( <i>Asparagus racemosus</i> )	General weakness, caught...
Sarpa gandha	Hyper tension, insomnia
Pashan Bheda ( <i>Coleus barbatus</i> )	Kidney stone...
Gudmar ( <i>Gymnema sylvestre</i> )	Diabetes, asthma...
Ashok ( <i>Saraca asoca</i> )	Menstrual pain, uterine disorder...

Apart from the examples given above (Source: [www. Odishafdc.com/products-medicinal-plants](http://www.Odishafdc.com/products-medicinal-plants)) student may give other ones. Ask them to describe only one.

Note: the description depends on the example given by the students.

7) (**Answers** to this question depend on the student view)

Expected answers are:

- Water pollution is the contamination of water bodies
- Sedimentation, pollution, climate change, deforestation, landscape changes, and urban growth industrialization...
- It would be a death of aquatic animals. It means that the main problem caused by water pollution is that it kills organisms that depend on these water bodies. Dead fish, crabs, birds and sea gulls, dolphins, and many other animals often wind up on beaches, killed by pollutants in their habitat.

## Lesson 3: Calculation of Simpson's index

### a) Prerequisites/Revision/Introduction

The learners already know what biodiversity mean in the previous lessons, you are recommended to help them to work this activity to calculate the Simpson's Index of Diversity as it is in the student book you will use the learner's ideas through collection of species outside the class and learner's presentations.

### b) Teaching resources

This lesson requires some materials as cited below: frame quadrats, long 50 m tape measures and rope or string, graph charts for populations.

### c) Learning activities

#### Activity 1.3

##### Teacher's activity:

- Tell the learners to move outside the class.
- Ask learners to collect trees species.
- Ask learners to brainstorm ways of calculating the Simpson's Index of Diversity.
- Supervise the work how it is conducted and give the learners' opportunity to work in their respective groups.
- Ask learners to present what they have done
- Help learners to summarize what they have learnt.
- Guide the learners to calculate the Simpson's Index of Diversity by giving the formula to be used.

#### Answers of activity 1.3

Collected specimens	Number (n)	n/N	(n/N) <sup>2</sup>
A	56	0.448	0.200704
B	48	0.384	0.147456
C	12	0.096	0.009216
D	6	0.048	0.002304
E	3	0.024	0.000576
			( $\sum (n/N)^2$ ) = 0.360256

$$D = 1 - 0.360256 = 0.639744$$

Diversity is medium because the value 0.639744 is within between 0 and 1

### Answers for self-assessment 1.3

1) Difference between species richness and species evenness is: the species richness is the number of species in an area, but species evenness is a measure of how many individuals of each species are present.

2) Precautions you may need to take when measuring populations of aquatic animals or plants.

- Ensure you sample at different depths in the water.
- Ensure you sample the mud.
- Ensure you sample at different distances from the bank.
- Ensure you have adequate footwear and don't fall in.

3) In a habitat with a high diversity, there is a complex feeding structure and any one species relies on many others. If one food species disappears, predators can feed on others. In a simple, low-diversity habitat, one species may rely entirely upon another. If the food species disappears, the predators will have no food and will also disappear.

4) First of all, count the number of all species ( $n$ ) and the total number of all trees ( $N=125$ ) then use the following formula  $D = 1 - (\sum (n/N)^2)$  When the index equals or is nearby 0 represents infinite diversity and while when it equals or is nearby 1, this means that there is no diversity. The bigger the value of  $D$ , the lower the diversity and small is  $D$ , bigger is the diversity. 5) Intense predation, interspecific competition and soil nature

5) Intense predation, interspecific competition and Soil nature

### Lesson 4: Sampling techniques to assess the distribution and abundance of organisms

#### a) Prerequisites/Revision/Introduction

You make revision on calculations of Simpson's Index of Diversity, the activity in student book create clear connection between calculations of Simpson's Index of Diversity with sampling techniques to assess the distribution and abundance of organisms, collection of different specimens of plant species in school garden you will ask the learners the different questions on the techniques used to collect different specimens of plant species and why are they chosen that techniques and their advantages.

## b) Teaching resources

This lesson requires some materials as cited below: frame quadrats, long 50 m tape measures and rope or string, sweep nets, graph charts for populations, simulations and computer animations.

## c) Learning activities

- Ask learners to collect specimens of plant species
- Ask learners to brainstorm techniques used to assess the distribution and abundance of organisms.
- Supervise the work how it is conducted and give the learners' opportunity to work in their respective groups.
- Ask learners to present what they have done
- Help learners to summarize what they have learnt.
- Guide the learner's techniques used to assess the distribution and abundance of organisms

## Answers for activity 1.4

1) Random sampling

2) This ensures that every unit point within the study area stand a chance of being sample depends on the answer given by students in (1). For example, students said that they used

- Random sampling is easy to use and ensures accuracy of representation.
- Help in conducting research on a larger population.

3) Expected answers are:

- If yes, because it is simple and quick. It helps in conducting research on a larger flower
- If no, you let them give their own ideas and come up with common conclusions

To calculate the Simpson' index students would use the formula like  $D = 1 - \sum (n/N)^2$  where (n) is the number of individuals in each species collected and (N) is the total number of all species individuals collected. Quadrat normally consists of a square frame, the most frequently used size being 1m<sup>2</sup>. The purpose of using a quadrat is to enable comparable samples to be obtained from areas of consistent size and shape.

The formula is  $D = 1 - \sum (n/N)^2$  where (n) is the number of individuals in each species collected and (N) is the total number of all species individuals collected.

The formula is  $D = \frac{1}{\sum (n/N)^2}$  where (n) is the number of individuals in each species collected and (N) is the total number of all species individuals collected.

### Answers for self-assessment 1.4

1) Expected answers are:

It eases the use and accuracy of representation.

Simple random sampling is as simple and accurate. This gives it a strong advantage when conducting research on a larger population.

2) You provide the square quadrats 1m<sup>2</sup>, long wire to each group of students and conduct them in school garden. Remember to tell them to avoid dangerous insects. Allow students to work themselves and present their products. The formula used is  $D = \frac{1}{\sum (n/N)^2}$

3) Expected answers are:

The benefits of using the following sampling techniques:

(a) Quadrats:

- These techniques are simple.
- These techniques can be easily applied many different times
- These are good for the ground that is flat

(b) Transect:

- This is simple technique.
- It may be applied to sample different areas of ecosystem
- This technique indicates change in land as well as organism abundance.

(c) Mark and recapture

- This technique can be applied for first mobile animals

4) Expected answers.

- Quadrats are used when the organisms to be sampled are immobile.
- Transect technique is used when change over time of topography from the air under the sea is measured.
- Mark and recapture technique is used when to count first moving animals difficult to see

## Lesson 5: Spearman rank correlation and Pearson's linear correlation

### a) Prerequisites/Revision/Introduction

You introduce the Spearman 'rank correlation and Pearson's linear correlation by showing learners graph charts for populations and asking different questions such as how you can Separate the figures in student's book based on positive, negative or absence of correlation, what do you understand by the term correlation? And in which conditions results can indicate a positive correlation? From the answers provided by the learners, give you the progress of the lesson.

### b) Teaching resources

The following materials can be used in this lesson, graph charts for populations, simulations and computer animations.

### Learning activities 1.5

#### Teacher's activity:

- Give the learners the materials to be used and guide them.
- Ask learners to separate figures located in student book based on positive, negative or absence of correlation.
- Ask learners to brainstorm how separate the figures.
- Supervise the work how it is conducted and give the learners' opportunity to work in their respective groups.
- Ask learners to present what they have done
- Help learners to summarize what they have learnt.

#### Answer for activity 1.5

1) Correlation is a statistical measure that shows the extent to which two or more variables fluctuate together

2) The first figure represents the strongest correlation that is present for studied items when all the points lie on a straight line. In this case, there is a linear correlation, and the correlation coefficient equals 1. If a given variable X increases so does another variable Y, the relationship is a positive correlation

- If a variable X increases while the variable Y decreases, then the relationship is a negative correlation.
- There is no correlation at all, when the correlation coefficient is 0

Correlation is most generally defined as the degree to which one phenomenon or random variable is associated with or can be predicted for another.

3) Conditions results that can indicate a positive correlation are: The points lie close to a straight line, which has a positive gradient. This indicates that as one variable increases the other increases.



4) Conclusion about the results when there is no correlation: There is no pattern to the points. This means correlation coefficient of 0.



## Answers for self-assessment 1.5

Pearson's linear correlation deals with linear relationship between two continuous variables. The relationship can only be linear when the rate of change of one of the variables is proportionally related to the rate of change in the other variable.

### 1.6 Summary of the unit

A species is a group of organisms that have many features in common and are able to interbreed and produce fertile offspring.

An ecosystem is a relatively self-contained, interacting community of organisms, and the environment in which they live and with which they interact. A niche is the role of an organism in an ecosystem; it is how it 'fits into' the ecosystem.

Biodiversity is considered at three different levels: variation in ecosystems or habitats, the number of species and their relative abundance, and genetic variation within each species.

Random sampling in fieldwork is important to collect data that is representative of the area being studied and to avoid bias in choice of samples. Random sampling is appropriate for habitats where species are distributed uniformly across the whole area and all are exposed to the same environmental conditions.

Frame quadrats are used to assess the abundance of organisms. Abundance can be recorded as species frequency, species density and percentage cover.

Line and belt transects are used to investigate the distribution of organisms in a habitat where conditions are not uniform (e.g. from low to high altitude). Line transects show qualitative changes in species distribution; belt transects show changes in abundance as well as distribution.

Mark–release–recapture is a method used to estimate the numbers of mobile animals in a particular place.

Simpson’s Index of Diversity (D) is used to calculate the biodiversity of a habitat. The range of values is 0 (low biodiversity) to 1 (high biodiversity).

Pearson’s linear correlation are used to see whether there is a relationship between two features

### 1.7 Additional information

The activity requires you to take students out of class and help them to do it. As teacher, you have to divide the students into groups, provide necessary materials to be used and guide them accordingly. Remember to call student for presentation of their results.

### 1.8 End unit assessment I

#### Section A: Answer by true or false

- 1) True
- 2) True
- 3) True
- 4) True
- 5) False

#### Section B: Long and short answer based questions

- 1) Biodiversity is defined as the full range of variety and variability within and among living organisms and the ecological complexes in which they occur
- 2) Insect pollinated plants would not reproduce due to lack of pollination, and extinction
- 3) Cutting of forest should be regulated by adopting methods like Clear cutting, Selective cutting, and Shelter wood cutting.
  - Avoid forest burning
  - Reforestation and afforestation
  - Forest clearance for agricultural purposes checking over.
  - Proper usage of forest products and forests.
- 4) Formula:  $D = 1 - \sum (n/N)^2$



Species	Number (n)	n/N	(n/N) <sup>2</sup>
A	2	0.117	0.013689
B	6	0.353	0.1246
C	3	0.176	0.03
D	4	0.235	0.055
E	2	0.117	0.013689
TOTAL	17	0.998	$\sum(n/N)^2 = 0.236978$

$$D = 1 - 0.236978 = 0.76$$

So, Diversity is lower because the value is nearby 1

5) Answer:

a) The following is the graph

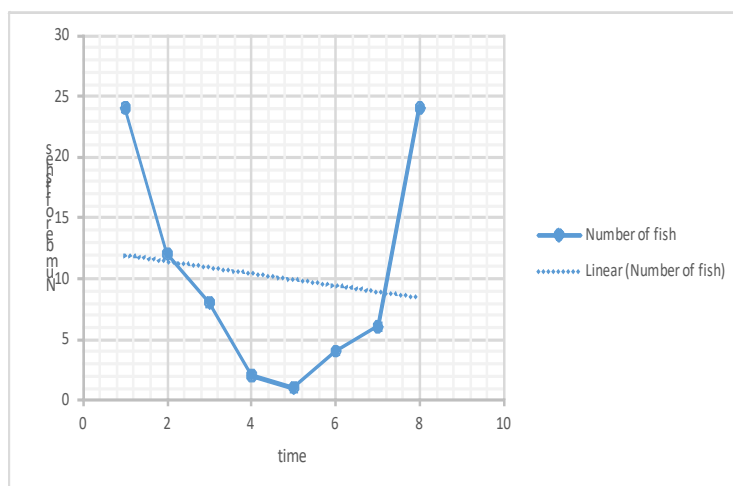

b) The best time of capturing fish is from 00:00 up 09:00, because the curve shows the rapid increase of fish that time.

## 1.9 Additional activities

### 1.9.1 Remedial Activities:

1) What do you understand with a Biome?

**Answer:** Biome is a large ecosystem where plants, animals, insects, and people live in a certain type of climate

2) What do you think is importance of biodiversity?

**Answer:** Biodiversity contributes to ecosystem goods and services. The ecosystem goods and services include:

- **Provisioning** services (provision of food, air, fire wood, medicines, energy, fresh water...),
- **Regulating** services (climate regulation, water purification, waste treatment, natural hazard...),
- **Supporting** services (nutrient cycling, primary production... ) and
- **Cultural** or **aesthetic** services (recreation, ecotourism... ).

3) The value of Simpson' index D ranges between ..... and.....

**Answer:** The value of this index also ranges between 0 and 1

4) During field activity, name the possible sampling methods you can use?

**Answer:** Random sampling method, Quadrat sampling method, Frame quadrats, transect sampling, Belt transects method, Netting, The mark-release-recapture technique.

5) When Spearman's rank correlation coefficient is used?

**Answer:** When the graph of results shows that the data are correlated, but not in a linear fashion.

### 1.9.2 Consolidation activities

1) Why population is different from community

**Answer:** Because population is a group of individuals of the same species and community is a group of different population

2) Observe the following figure and try to give its name, its contribution in diseases, treatment

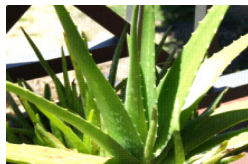

**Answer:** Its name is Aloe vera. It treats different diseases like different infectious diseases and it boosts immunity.

3) Analyze this formula  $D = 1 - (\sum (n/N)^2)$

**Answer:** The formula is used when calculating the Simpson index of biodiversity, where (n) is a number of individuals in each species and (N) is the total number of

individuals in all species. The value of D ranges between 0 and 1

4) What do you think is an advantage of using line transect sampling technique?

**Answer:**

- It can be used to sample different areas of the ecosystem.
- Shows change in land and organism abundance

5) Observe the figure below and try to write the one which positive, negative and no correlation

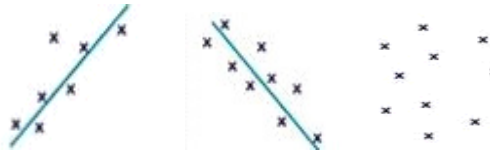

**Answer:**

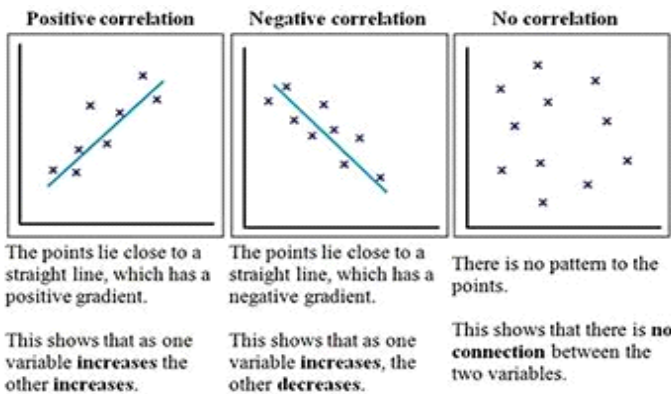

### 1.9.3 Extended activities

1) What will happen to living organisms if they have the same ecological niche?

**Answer:** There will be competition and it will end by the extinction of some species.

2) Describe the effect of climate change on biodiversity loss

**Answer:** Increased heat of the Earth's surface affects biodiversity. It leads to the death of various microorganisms, animal and plant species which failed to adapt to the new conditions. The following are some of the likely impacts of climate change on biodiversity:

- The climate change will have differential effects on species. Some species will migrate through fragmented landscapes whilst others may not be able to do so.

- Many species that are already vulnerable are likely to become extinct.
- Changes in the frequency, intensity, extent, and locations of climatically and non-climatically induced disturbances will affect how and at what rate the existing ecosystems will be replaced by new plant and animal assemblages.
- Loss or fragmentation of forest habitat due to climate change is a major threat to biodiversity.
- Climate change negatively affects crop production and causes vulnerable people to depend mostly on ecosystem services.
- Climate change negatively impacts water bodies by increasing or dropping water levels.

3) In a survey of trees in a dry tropical forest, some students identified five tree species (A to E). They counted the numbers of trees in an area 100 m × 100 m with these results

Tree species	Number
A	56
B	48
C	12
D	6
E	3

- Calculate the Simpson's Index diversity for identified species
- Explain the advantage of using data on species diversity and abundance when calculating an index of diversity.
- The Simpson's Index of diversity for vegetation in an open area inhabited by grasslands was 0.8. For a similar sized area of vegetation beneath some conifer trees it was 0.2. What do you conclude from these results?

## Answers

a) The answer is given in the following table:

SPECIES	n	n/N	(n/N) <sup>2</sup>
A	56	0.448	0.201
B	48	0.384	0.148
C	12	0.096	0.01
D	6	0.048	0.002

E	3	0.024	0.001
Total number of individuals, N	125		$\Sigma(n/N)^2 = 0.362$

$$\text{Simpson's Index of Diversity (D)} = 1 - 0.362 = 0.638$$

b) The ecosystem having one dominant species that is very abundant may have a big number of species but there would be very few individuals of other species. If abundance is measured, then there may be many individuals of this dominant species, but there may not be many other species so it is species poor. An area with one dominant species which is very abundant has a lower biodiversity than an area with no dominant species and many species of all roughly the same abundance.

c) The area of grassland has a high biodiversity, the area beneath the conifer trees has a much lower biodiversity.

4) A quadrat measuring 25 cm x 25 cm was used to measure population abundance of barnacles on a rocky shore. Data was collected from 10 randomly – placed quadrats.

Quadrat (1 m <sup>2</sup> )	1	2	3	4	5	6	7	8	9	10
Number of barnacles	0	4	5	2	9	0	10	8	2	10

Calculate the density per m<sup>2</sup> of the barnacles in the studied area.

**Answer:**

Surface area of one quadrat is 25 cm.25cm=625cm<sup>2</sup> =6.25 m<sup>2</sup>

The surface area of all 10 quadrats is6.25 m<sup>2</sup>. 10=62.5m<sup>2</sup>

Total number of all barnacles is 50

The density of barnacles in the studied area = 50/62.5=0.8

5) Describe the Spearman's rank correlation.

**Answer:** When collected data are not quantitative, but used an abundance scale or when the researcher is not sure if quantitative data are normally distributed. It might also be possible that a graph of results shows that the data are correlated, but not in a linear fashion. In this case, the Spearman's rank correlation coefficient is used. It involves ranking the data recorded for each variable and assessing the difference between the ranks.



### 2.1 Key unit competence

To be able to apply the basic knowledge of classification to group living organisms into the three domains.

### 2.2 Prerequisites

Introduce the unit by asking learners identify biodiversity studied previous unit and use it in classification. It is also necessary for the teacher, to ask learners about what they recall about classification studied in ordinary level. Ask learners the reasons for classification, what do we consider while classifying organisms, how do we classify organisms and other related questions to help learners remember previous concepts studied in the previous level.

Remember, learners have knowledge and skills of drawing a dichotomous key studied in senior 1, you can base on this to enable them to identify observable characteristics of collected specimens for identification.

Learners have knowledge of classification of living organisms, basically the five kingdoms of living organisms in senior 1, this will enable learners to discover the three domains of organisms.

### 2.3 Cross-cutting issues to be addressed

#### a) Environment and sustainability

Guide learners while collecting specimens and caution them against uprooting, cutting down plants and unnecessary killing of animals. As a teacher, you are required to be creative and innovative enough, in integrating this cross cutting issue since it is applicable in all lessons of this unit for example in the lessons of: five kingdoms of living organisms, dichotomous key to mention but a few. Learners must recognise the significance of plants and animals in environmental protection. Learners also need to understand their positive roles in environment and sustainability.

## **b) Gender**

In all lessons of this unit, this cross cutting issue can be integrated. As a teacher, your role is to ensure gender equality in activities you conduct inside and outside the classroom. Gender can be integrated, for example by putting together boys and girls in group work, while setting tasks and when presenting.

## **c) Comprehensive sexuality education (HIV/AIDS, STI, Family planning, Gender equality and reproductive health)**

When facilitating a lesson of common bacterial diseases, learners need to be aware that syphilis and gonorrhoea are STIs and at the same time caused by bacteria.

Lesson of the structure and classification of viruses, integrate in this cross cutting issue. Link the cause of AIDS which is HIV to this issue and emphasize on preventative measures. Learners are required to put into practice the preventative measures of HIV/AIDS and STIs.

## **d) Peace and Values Education**

The role of a teacher is to create and promote peace in a learning environment. In lesson 2.2, guide learners to ensure that all living organisms co – exist in harmony. This cross cutting issue can be integrated at any time in classroom, outside classroom, in school environment and anywhere in life. Teacher should not be a source of conflicts. Learners need to appreciate peace and values and advocate for positive behavior among them.

### **2.4 Guidance on the introductory activity**

This activity is very essential since it captures the attention of learners: As a teacher, you are required to give such activity because it has the following benefits:

- It creates curiosity among learners and enhances active learning through doing.
- It promotes critical thinking and allows learners to predict the next lesson / unit.
- The teacher is encouraged to set clear introductory activity which can give a general picture of the whole unit if possible.



## 2.5 List of lessons.

	Lesson title	Learning objectives	Number of periods
1	Taxonomic hierarchy	Describe the classification of species into the taxonomic hierarchy of domain, - kingdom, phylum, class, order, family, genus and species	3
2	The three domains: Bacteria, Archaea, Eukarya	Outline the characteristic features of the three domains Archaea, Bacteria and Eukarya.	2
3	The five kingdoms of living organisms	Outline the characteristic features of the kingdoms Protocista, Fungi, Plantae and Animalia. Draw and label the structure of bacteria.	3
4	Economic importance of bacteria	Describe the economic importance of bacteria to humans.	3
5	Common bacterial diseases in animals and plants	Identify common bacterial diseases in plants and animals. Demonstrate methods of preventing common bacterial diseases.	3
6	The structure and classification of viruses	Explain why viruses are not included in the three domain classification.  Outline how they are classified: limited to type of nucleic acid and whether these are single stranded or double stranded.	3
7	The dichotomous key	Design and apply a dichotomous key for a group of organisms	2
8	Assessment	classify the species into the taxonomic hierarchy of domain, kingdom, phylum, class, order, family, genus and species, the characteristic features of the three domains and of the kingdoms Protocista, Fungi, Plantae and Animalia.(2 periods)	2

## Lesson 1: Taxonomic hierarchy

### a) Prerequisite:

Start the lesson by asking learners questions such as: what is meant by biological classification? How do we classify living organisms? Why are living organisms classified? Remember students have studied the five kingdoms of living organisms in senior 1 & 2, so they are expected to answer correctly the asked questions. Proceed with the lesson by introducing to them activity 2.1 in learners' book as follows:

### b) Teaching Resources: Manilas, markers, cards, text books or computer aided materials.

### c) Learning activities

Guide learners to develop competencies of this lesson by doing the following:

- Ask learners to make groups of not more than five students (depends on number of students in class).
- Provide each group with cards written on the following words: country, province, continent, sector, family, a cell, village and district.
- Ask learners to arrange them in their descending order of size (from the largest to the smallest) in form of a chart as fig. 2.1 in student's book.
- Ask learners to answer questions in activity 2.1, in student's book following the arrangement made.
- Display the figure in student book, ask learners to relate it with the one they made in their findings.
- Proceed with the lesson by connecting it to 8 major recognized groups of taxonomic hierarchy and emphasize that a domain is so far recognized as the largest group and below it there is a kingdom.

### Answers for the introductory activity

- a) The colour of fruits, size of fruits, shape, presence or absence of seeds inside, ripeness
- b) Oranges are closely related to lemons, and green paper is closely related to red paper.

### Answers for learning activity 2.1

- 1) Continent, country, province, district, sector, cell, village and family
- 2) The arrangement of words in a flow chart above is the same as that of taxonomic hierarchy in student's book fig.2.1.

3) Organisms of the same species resemble one another and more to that are far fewer in number than those in a domain.

As there are many countries in a continent, as it is the case with a domain, which can be made up of many kingdoms e.g. domain Eukarya.

As one moves from continent to family the number of people reduces. Also from domain to species, the number of organisms reduces as their features in common increase.

### Answers for self-assessment 2.1

Answers for a)

1) The following are the answers:

a) Classification of African bush elephant

Domain	Eukarya
Kingdom	Animalia
Phylum	Chordata
Class	Mammalia
Order	Proboscidae
Family	Elephantae
Genus	Loxodonta
Species	Africana

b) Taxon refers to a unit or a group of classification in a taxonomic hierarchy. In plural form, it is referred to as taxa. From the table above, the taxa include: domain, kingdom, phylum, class, order, family, genus and species.

2) Classification of the organisms below

Organism	Kingdom	Phylum/ Division	Class
Honeybee	Animalia	Arthropoda	Insecta
Cockroach	Animalia	Arthropoda	Insecta
Maize	Plantae	Angiosperm	Monocotyledon
Spider	Animalia	Arthropoda	Arachnida.

3) Biologists use a classification system to name organisms with a universally accepted name. They also group organisms in a logical manner. Here, organisms placed into particular groups are more similar to one another than they are to organisms in other groups. For each species is assigned a two-part scientific name in what is termed as binomial nomenclature.

## **Lesson 2 : Three domains of Bacteria, Archaea and Eukarya**

### **a) Pre-requisite/ revision/ introduction.**

Start the lesson by asking learners to mention the domains of organisms they know. Ask students to brainstorm characteristics of each domain and distinguish the three domains. Clearly highlight why Archaea and bacteria are classified into two different domains.

**b) Teaching Resources:** text books, flip charts, markers, question papers, computers and projectors.

### **c) Learning activity 2.2**

- Provide learners with text books and guide them to brainstorm the characteristics of each of the three domains and distinguish them.
- Ask each group to display and present their findings.
- The teacher evaluates learners' presentations by asking them to explain each.
- Extend the lesson by clearly highlighting why Archaea and bacteria are classified into two different domains.

### **Answers for learning activity 2.2:**

#### **Characteristic features of domain;**

##### **Bacteria**

- Cells with no true nucleus
- DNA exists in circular chromosome and does not have histone proteins associated with it
- Smaller circular molecules of DNA called plasmids are often present
- No membrane-bound organelles (such as mitochondria, endoplasmic reticulum, Golgi body, chloroplasts) are present
- Ribosome are smaller than in eukaryotic cells

##### **Domain Archaea**

- Cells with no membrane-bound organelles

- DNA exists in circular chromosome and does not have histone proteins associated with it
- Smaller circular molecules of DNA called plasmids are often present
- Ribosome are smaller than in eukaryotic cells, but they have features that are similar to those in eukaryotic ribosome, not to bacterial ribosome
- Cell wall always presents, but does not contain peptidoglycans.

## **Domain Eukarya**

Their characteristic features are:

- Cells with a nucleus and membrane-bound organelles
- DNA in the nucleus arranged as linear chromosomes with histone proteins
- Ribosome's in the cytosol are larger than in prokaryotes, while chloroplasts and mitochondria have ribosome, like those in prokaryotes.
- Chloroplast and mitochondrial DNA is circular as in prokaryotes
- A great diversity of forms: unicellular, colonial and multicellular organisms
- Cell division is by mitosis

### **d) Answers for Self-assessment 2.2**

1) The three domains of organisms are; Bacteria, Archaea, and Eukarya

2) Domain in the current classification is so far recognized as the largest group in the taxonomic hierarchy while a kingdom is the second largest group of classification. i.e. organisms in a domain are further classified into kingdoms.

3) This is true mainly about archaeobacteria that live in hot and acidic springs where temperatures exceed 100°C and the pH may be as low as 2. These are termed as thermo acidophilic bacteria. e.g *Nymphaea thermarum*

- However, some can inhabit in anaerobic habitats and give off methane as a product of their metabolism. They live in guts of cattle and are responsible for intestinal gases. These are referred to as methanogenic Archaeobacteria.
- Some are halophilic archaeobacteria and they live in very salty conditions such salt flats. They can grow in salt concentrations approaching saturation.
- Because they tolerate extreme conditions similar to those that are thought to have existed at the dawn of life, Archaea are believed to have been the first forms of life on earth.

4) Organisms are placed in various taxonomic groups basing on evolutionary descent. Scientists compare the DNA of different organisms to establish similarities between them and reconstruct possible evolutionary relationship.

## Lesson 3 : Five kingdoms of living organisms

### a) Prerequisite

This is a practical based lesson and as a teacher, you need to guide learners throughout in order to develop and acquire knowledge and skills as well as attitudes and values.

**Caution** learners not to destroy or kill organisms in the environment during collection of specimens since this can result into loss of biodiversity and destruction of environment. Guide learners to do activity 2.3 in student's book.

Ask learners to identify five kingdoms of living organisms.

b) **Teaching Resources:** collected: housefly, spider, frog, gecko, bean, /maize plants, moulds/mushrooms, spirogyra (algae) and a hen or their pictures, books, flip charts and markers

### c) Learning activity 2.3

- Ask learners to collect organisms around or near the school such as: housefly, spider, frog, gecko, bean, /maize plant, moulds/mushrooms, spirogyra (algae) and a hen. You can provide a picture of each if it is difficult to collect them.
- Ask learners to follow the steps in student's book activity 2.3 and if pictures are used, guide them as required.
- Ask learners to observe the above mentioned organisms and classify them into their respective kingdoms basing on their characteristics.
- Ask learners to analyse their findings and identify the kingdom which is not represented in their findings.
- Proceed with the lesson and among others ask them to identify group of organisms that is not classified in any of the five kingdoms and why.

## Answers for learning activity 2.3

Organism	Kingdom
Housefly	Animalia
Spider	Animalia
Frog	Animalia
Gecko	Animalia
Bean	Plantae
Maize	Plantae
Mould	Fungi
Mushroom	Fungi
Spirogyra	Protocista
Hen	Animalia

### Characteristics of animals

- Multicellular eukaryotes with many different types of specialized cells
- Cells that are differentiated to form tissues and organs
- Cells do not have chloroplasts and cannot photosynthesize (although some, such as coral polyps have photosynthetic protocists living within their tissues)
- Cell vacuoles are small and temporary (for example lysosomes and food vacuoles)
- Heterotrophic nutrition

### Characteristics of plants

- Multicellular eukaryotes with cells that are differentiated to form tissues and organs.
- Few types of specialized cells
- Some cells have chloroplasts and photosynthesize
- Cells have large, often permanent vacuoles for support Autotrophic nutrition
- Cell walls are always present and are made of cellulose.

### Characteristics of fungi are

- Eukaryotic organisms.
- Do not have chlorophyll and do not photosynthesize
- Heterotrophic nutrition – they use organic compounds made by other organisms as their source of energy and source of molecules for metabolism
- Reproduce by means of spores

## Characteristics of protists are

- Eukaryotic organisms
- Mostly single-celled, or exist as groups of similar cells
- Some have animal-like cells (no cell wall) and are sometimes known as protozoa
- Others have plant-like cells (with cellulose cell walls and chloroplasts) and are sometimes known as algae.

### d) Answers for activity 2.3.2

Phylum	Characteristics	Examples
Chordata	They have a notochord; they have a post anal tail at some stage in their life cycle.	Human being, cow, mountain gorilla
Arthropoda	They have jointed appendages/ legs, they have exoskeleton,	Housefly, spider, millipede
Annelida	They do not have a distinctive head, they have segmented body.	Earthworm, rag worms, leeches.
Mollusca	Most of them have shells containing calcium carbonate, they have soft unsegmented body	Snails, octopus, squids and slugs.
Echinodermata	They have five rays forming a radial symmetry.	Star fish, bristle star, sea urchin
Coelenterata	They have tentacles, are radially symmetrical, have nematoblasts.	Hydra, sea anemones, jelly fish
Platyhelminthes	They have a flat body They also lack a respiratory system.	Tape worms, liver fluke and planarians
Nematoda	Have unsegmented body, have both mouth and anus.	Round worms, hook worms
Porifera	Have no nervous system, they are sessile.	Sycon, euplectella

### Answers for self-assessment 2.3

1) The five kingdom classification aims to be natural because it attempts to group organisms according to natural relationships ie the grouping is based on many features, internal as well as external, uses information from many branches of biology.



2) Protists have a wide range of feeding methods. They obtain food in the following ways:

- Autotrophic nutrition in a process of photosynthesis for example in algae
- Phagocytosis by engulfing food particles such as amoeba
- Endocytosis; in ciliates such as paramecium that use oral groove
- Others are parasitic like plasmodia that cause malaria.

3) Characteristics of protists are;

Eukaryotic organisms.

Mostly single-celled, or exist as groups of similar cells

Some have animal-like cells (no cell wall) and are sometimes known as protozoa

They feed by both autotrophic nutrition like algae and heterotrophic nutrition such as protozoa.

4) The following are the answers:

a) Classification of organisms into respective Kingdoms

Name of organism	Kingdom
Housefly	Animalia
Maize	Plantae
Frog	Animalia
Bat	Animalia
Eagle	Animalia

b)Maize and frog because maize has chlorophyll and cell wall while in a frog they are absent.

5)Plants have cells with chloroplasts that contain chlorophyll thus are autotrophs while members of fungi do not have chloroplasts and they feed heterotrophically ie are saprophytes.

## Lesson 4 : Economic importance of bacteria

### a) Prerequisite

Start the lesson by asking learners questions like: Are bacteria important to human beings? How? Ask students to brainstorm how bacteria are both useful and harmful to humans. Clearly, introduce activity 2.4 in the students' books.

**b) Teaching resources:** Textbooks, flip charts and markers, simulations and computers.

### **c) Learning Activities 2.4**

Guide learners to form groups of four each (you can consider the size of the class and available resources).

Provide learners with text books, guide them to read and justify the usefulness and harmfulness of bacteria to humans.

Ask learners to present and guide them to summarize their presentations and evaluate them

After summarizing their presentations proceed with the lesson by explaining deeply each point in students' summary

### **Answers for learning activity 2.4**

Bacteria are useful in the following ways: in biotechnology, genetic engineering, decomposition, fiber retting, nitrogen fixation, digestion, biological control. However, some bacteria are harmful to humans in the following ways:

- Saprotrophic bacteria attack and food spoilage.
- Some bacteria are causal agents of different diseases to animals and to human beings.
- Such bacteria include; *Vibrio cholerae*, *Shigella* bacterium, *Salmonella typhus*, *Bacillus* etc. They cause diseases such as cholera, dysentery, tuberculosis, typhoid etc.

## **Lesson 5: Common bacterial diseases in animals and plants**

### **a) Prerequisite**

Ask learners the diseases caused by bacteria in both plants and animals more especially in humans. Learners have prior knowledge about bacterial diseases since they studied this at ordinary level. Use prepared resources to do activity 2.5 in student's book.

**b) Teaching resources:** Text books, newspapers, journals, magazines, flip charts and markers, photographs, videos

### **c) Learning Activities 2.5**

Guide learners in their respective groups to use text books and prepare a presentation on cause, transmission and control of cholera.

Ask learners to present in their respective groups.

Proceed the lesson by describing other bacterial diseases in humans apart from cholera and emphasize on prevention and control.

### **Answers for learning activity 2.5**

Cholera is caused by bacteria called *Vibrio cholerae* (comma shaped bacterium). Transmission is mainly by eating food and drinking water contaminated by cholera germs in faeces by houseflies

- Prevention and control the following measures can be ensured in order to prevent cholera outbreak;
- Sensitization of the public and sanitation and personal hygiene.
- Proper food preparation for example washing hands and fruits before eating them.
- Food and drinks should be covered properly to reduce contamination.
- Unclean water should be treated with chlorine to make it safe for drinking.
- Proper boiling of water for drinking.
- Vaccination to give active artificial immunity for at least one year.
- Killing vectors like house flies with insecticides to break their life cycle.
- Isolate the cholera patients to reduce the transmission of the disease.
- Avoid urinating and defecating in water bodies.
- Treatment of sewage anaerobically using anaerobic bacteria and fungi.

### **Answers for Self-assessment 2.5**

1) Cholera: It is caused by a bacterium called *Vibrio cholera*.

2) Cholera is transmitted through the following way:By drinking water contaminated by cholera germs

By vectors such as houseflies

Contact with patients, without protective gadgets.

3) Wash hands with clean water and soap after visiting the toilet and before eating.

4) I can advise people of the affected area and the neighborhood to ensure the following measures:

- Educate the public to ensure personal hygiene for example washing hands after visiting the toilet.
- Wash hands and fruits before eating.

- Food and drinks should be covered properly to reduce contamination.
- Unclean water should be treated with chlorine to make it safe for drinking.
- Drink boiled or treated water
- Killing vectors like house flies with insecticides to break their life cycle.
- Isolate the cholera patients to reduce the transmission of the disease.
- Avoid urinating and defecating in water bodies.
- Treatment of sewage anaerobically using anaerobic bacteria.
- Proper food preparation

5) Houseflies visit contaminated/ dirty places such as toilets or faeces, pick bacteria (germs) and deposit them into food. When we eat such contaminated food, we can suffer from diseases.

## Lesson 6 : Structure and classification of viruses

### a) Prerequisite

Remember in the previous lesson of five kingdoms of living organism's learners discovered that viruses are not classified in any of the kingdoms.

Ask to suggest/brainstorm reasons why viruses are not classified in any of the five kingdoms.

**b) Teaching Resources:** Text books, flip charts and markers.

### c) Learning Activity 2.6

Help learners to form groups of six considering gender balance.

Provide learners with text books and ask them to brainstorm reasons why viruses are not classified in any of the five kingdoms.

Guide learners and give attention to learners with special education needs.

Guide learners while summarizing their presentations.

### Answers for learning activity 2.6

They are not classified in any of the five kingdoms because:

- Viruses are acellular – they do not have a cellular structure like bacteria and protists.
- They crystallize in isolation

- They do not reproduce, respire and feed outside the living cells. (Do not show the characteristics of a living cell).
- Viruses have none of the features that we traditionally use for classification.

### **d)Answers for Self-assessment 2.6**

1)The following are the answers:

a) Virus is a particle of nucleic acid, proteins and in some cases lipids.

b) A typical virus is composed of core of DNA or RNA surrounded by a protein coat, which is called a capsid.

2)The virus enters a cell, makes copies of itself, and causes cell to burst. In another way, the virus embeds its DNA into the DNA of the host cell and replicates.

3) Bacteriophage is a virus that infects bacteria while retrovirus is a virus that contains RNA.

4) Most biologists and students argue that viruses should not be considered as a form of life because they don't show all characteristics of living organisms hence exist between the border line of living things and non-living things.

## **Lesson 7 : Dichotomous key**

### **a)Prerequisite**

This is a practical based lesson and as a teacher, you need to guide learners throughout in order to develop and acquire knowledge and skills as well as attitudes and values.

**Caution** learners not to destroy or kill organisms in the environment during collection of specimens since this can result into loss of biodiversity and destruction of environment. Ask learners to recall the meaning of dichotomous key and what do we consider while constructing a dichotomous key. Facilitate learners to develop their skill of observation, drawing and as well as recording.

**b) Teaching resources:** leaves of; cassava, avocado, jacaranda, cassia; hibiscus, bean, maize/Paspalum

### **c) Leaning activity 2.7**

- Guide learners to collect the following leaves of cassava, avocado, jacaranda, cassia; hibiscus, bean, maize or Paspalum
- Ask learners to label the leaves: A, B, C, D, E, F and G as shown in fig 2.11 in students' book.
- Ask learners to observe the specimens collected and record their characteristics in a table form

- Ask learners to display their findings and facilitate them through evaluation to make a summary of correct observations.

### Answers for learning activity 2.7

Leaf	Description of features/characteristics
A	Simple digitate, long petiole, network veined.
B	Simple, network venation, smooth margin.
C	compound bipinnate, network veined
D	Compound pinnate, network veined.
E	Simple, short petiole, network venation, smooth margin.
F	Compound trifoliolate, network venation.
G	Simple, leaf sheath present, parallel venation.

### Answers for self-assessment 2.7

- 1) Phylum arthropoda: because all organisms shown, have jointed appendages or legs and all possess exoskeleton.
- 2) The presence or absence of wings
- 3) A spider has 4pairs of jointed legs while a mosquito has 3pairs of jointed legs. A millipede has a cylindrical body while a centipede has a flattened body shape.
- 4) Is presented in the table

Organism	Class
Millipede	Diplopoda
Centipede	Chilopoda

## 2.6 Summary of the unit

- Classification of organisms may be natural or artificial.
- Natural classifications aim to group organisms according to their evolutionary relationships whereas, artificial classifications place organisms into groups for purposes of conveniences. For example, organisms can be classified according to where they live, how they move or their size.
- Taxonomy deals with sorting or grouping living organisms into various groups.
- Phylogeny is the study of how closely different species are related. It reflects the evolutionary relationships of species.
- In modern classification, organisms are classified into eight recognised groups (taxa) of classification. The eight recognised taxa are: Domain, kingdom,

phylum, class, order, family, genus and species.

- A species is defined as the smallest group of classification where organisms resemble one another and are capable of interbreeding together to two word names should be written in italics when typed and when hand written should be underlined.
- There are three domains of living organisms: Bacteria (Eubacteria), Archaea and Eukarya.
- Prokaryotes includes; bacteria and Archaea while eukaryotes involve: animals, plants, fungi and protists)
- There are five recognised kingdoms of living organisms; monera (prokaryote), protocista (protista), fungi, Animalia and plantae.
- Viruses are not classified into any of the above five kingdoms since they are considered as both living and non-living things. They exist at border line of living organisms and non-living things.
- A dichotomous key is a way of identifying and naming a specimen you have found.
- A dichotomous key is constructed basing on structural observable features.
- Bacteria cause diseases humans like cholera, tuberculosis (TB), typhoid fever, pneumonia, tetanus, diphtheria, bacterial meningitis, tooth decay in humans and anthrax in cattle.

## 2.7 Additional Information

The content in this unit is not enough to address all the necessary information especially the details of every kingdom. You need to continue giving assignments on concepts of classification which are very essential but the syllabus doesn't tackle them. An example is summary of division of kingdom plantae as follows:

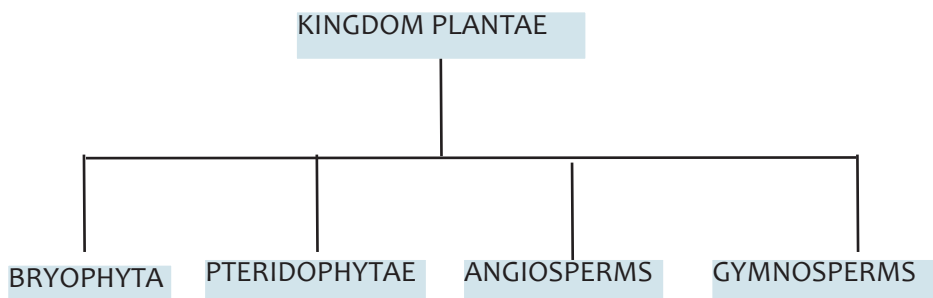

**Division bryophyte: examples are Mosses, Liverworts and Hornworts.**

- They are non-vascular land plants, which do not contain any conducting tissues and are often referred to as bryophytes.
- These plants are small, grow close to the ground and include mosses and liverworts.

- They are very small in structure and are considered as important members of our ecosystem.
- The reproduction process is carried in their spores. They are non-flowering plant and are found mainly growing on the ground, on other plants and on rocks.
- They play a vital role in preventing soil erosion

**Division pteridophytae:** examples are horsetails, ferns and club mosses.

- They are seedless vascular plants, which contain vascular tissues but do not produce seeds.
- They are involved in transportation of fluids.
- The reproduction process is carried by spores.

**Division angiosperm:** examples are trees, shrubs vines and all flowering plants

- Angiosperms are flowering plants, which develops the seeds within a protective structure.
- The reproduction process is carried by Angiosperm.
- They develop their seeds within an ovary, which itself is embedded in a flower. After the stage of fertilization, the flower falls and the ovary become a fruit.
- Angiosperms in the class Dicotyledoneae grows into two seed-leaves (cotyledons).
- An angiosperms leaf consists of a single, branched, main vein, which originates from the base of the leaf blade. In few plants, it may also consist of four or more main veins diverging from the same base

**Division Gymnosperm:** examples are palms

- Gymnosperms are non-flowering plants with undeveloped seeds, which are present in an enclosed structure.
- Monocot begins with a single seed-leaf. The main veins of their leaves are usually parallel and unbranched.
- Monocot plays an important role in providing us with our primary sources of nutrition, which includes grains and fruits

## 2.8 Answers for end unit assessment 2

- 1) b
- 2) a
- 3) c
- 4) a
- 5) a
- 6) c
- 7) d



8) c

9) c

10) c

11) The answers are given in the following table:

Structures	Organisms
Antennae	Fungus
Flagella	Snail
Spores	Housefly
Coiled shell	Euglena
Pseudopodia	Amoeba
Cilia	Paramecium

12) The following are the answers:

a) X Protocista and Y Monera

b) The following are the answers:

(i) The answers are:

- Both protocista and monera exhibit autotrophic and heterotrophic nutrition.
- Both x and y are unicellular organisms except few members of x such as algae.
- Both have members with flagella.

(ii) Both x and fungi undergo parasitic mode of feeding.

(iii) Some members of protocista such as algae and plantae both carry out photosynthesis.

(iv) Most members of x locomote like animals

13) Answers are summarized in the following table:

Characteristic	Insecta	Arachnida	Crustacea	Chilopoda	Diplopoda
Number of body parts	3 body parts	2body parts	2body parts	2 body parts	2body parts
Number of limbs or legs	3 pairs	4pairs	Ranges between 5-20pairs	1 pair per segment	Very many (2 pairs per segment)

Gaseous exchange structure	Spiracles, tracheal system	Lung books or trachea	Gills or body membrane	Tracheal system	Spiracles
Number of antennae	1 pair	None	2 pairs	1 pair	1 pair
Number of wings	1 or 2 pairs and sometimes none.	None	None	None	None
Number and nature of eyes	1 pair of compound eyes and many simple eyes	8 Simple	1 pair of compound eyes	1 pair of compound eyes	Group of simple eyes

14) Significance of classification;

- To identify living organisms and place them into their correct groups basing on their observable characteristics.
- To understand the evolutionary relationship between different organisms.
- To arrange information about living organisms in order, for easy study purposes.
- To enable biologists to identify characteristics of organisms.
- To put organisms into small manageable groups basing on their similarities for easy study purpose.

15) Classification of a blue monkey.

Kingdom	Animalia
Phylum	Chordata
Class	Mammalia
Order	Primate
Family	Cercopithidae
Genus	Cercopithecus
Species	mitis

Scientific name is *Cercopithecus mitis*.

## 2.9 Additional activities

### 2.9.1 Remedial activities

- 1) Arrange the following taxonomic groups in their ascending order of size (from smallest to the largest); domain, class, genus, kingdom, species, family, phylum and order.
- 2) A scientist finds a new organism but is unsure to which kingdom it belongs. The organism is unicellular, has cell wall, contains peptidoglycans, has a circular DNA molecule and ribosome but lacks a nucleus. Basing on these characteristics, to which domain and kingdom does it belong?
- 3) State the five kingdoms and give two examples of organisms in each kingdom.
- 4) Bacteria that live on teeth produce an acid that cause tooth decay. Why do people who do not brush their teeth regularly tend to have more cavities than those who do?
- 5) In which type of virus does human immunodeficiency virus belong?
- 6) What precautions would be taken while collecting specimens for classification?

### Answers for Remedial Activities

- 1) Species, genus, family, order, class, phylum, kingdom, domain.
- 2) Domain is bacteria and kingdom is monera (prokaryote)
- 3) Answers are summarized in the following table:

Kingdom	Examples
Animalia	Cow, human , hen
Plantae	Maize, mango, comelina (wondering jew)
Fungi	Mushrooms, moulds, puffballs, toadstools
Protoctita	Paramecium, amoeba, plasmodium,euglena
Monera	Vibrio cholera, salmonella, bacillus, diplococci,

- 4) Because their rapid growth of bacteria that accumulate in food remains between teeth and its outer surface, leading to production of more acid. The

accumulation of the acid eats up the enamel of the teeth thus tooth decay.

5) Retrovirus.

Before starting to collect specimens for practical purposes, the following precautions must be put in considerations:

- Care must be taken while collecting and handling some organisms because some are poisonous, have thorns and others are able to sting.
- Be aware that some animals are dangerous (harmful) to humans. Some can bite such as snakes, sting such as bees, others have poisonous glands such as toad and other animals like fish have fins for piercing.
- Avoid and try to minimize where possible, uprooting, cutting down or plucking and pruning of plants as this may threaten the biodiversity as well as result into environmental degradation.

### Consolidation activities

1) Copy and complete the table for classification of a housefly and its scientific name.

Group of taxonomy	Name
Kingdom	
Phylum	
	Diptera
Family	Muscidae
	Musca
Species	Domestica

2) Answer the following questions:

- a) How do fungi obtain their food nutrients?
- b) How do cell walls of fungi and plants differ?

3) Answer the following questions:

- a) What is a notochord?
- b) How do the fins of cartilaginous fish differ from those of the bony fish?

4) Suppose bacteria lost the ability to nitrogen. How would this affect other living organisms?

5) Identify two immunisable viral diseases in humans and one non immunisable viral disease.

6) What characteristic features would you consider while constructing a dichotomous key of leaves?

### Answers for consolidation activities

1) Classification of a housefly:

Group of taxonomy	Name
Kingdom	Animalia
Phylum	Arthropoda
Class	Insecta
Order	Diptera
Family	Muscidae
Genus	Musca
Species	Domestica

The Scientific name is *Musca domestica*

2) Answers:

a) Saprophytically, by digesting their food extracellularly and absorbing digested products.

b) Cell walls in fungi contain chitin while in plants contain cellulose.

3) It is defined as a flexible rod running along the back.

4) Fins of cartilaginous fish are fleshy whereas fins of bony fish are supported by fin rays

5) Immunisable viral diseases include; measles and poliomyelitis while non immunisable disease is HIV/ AIDS.

6) If you are classifying leaves, you must consider the following observable features; In case of simple leaves, you can classify them basing on;

- Nature of apex: is the apex pointed or curved.
- Nature of margin: observe whether the margin is serrated, toothed, curved, smooth or entire.
- Nature of lamina: is the lamina smooth, rough, hairy or thorny.
- Nature of venation; either parallel or network venation and for network

venation, consider their types.

- Nature of petiole; it may either be short or long, hollow or not hollow, hairy.
- In case of compound leaves, you can consider the type basing on the number and form of leaflets present for example trifoliate with three leaflets, compound palmate, pinnate, bipinnate or the arrangement of leaflets on a leaf.

## Extension activities

1) The table provided below represents different phyla and characteristics of each phylum of kingdom protocista. Copy and complete by giving one example of each.

	Characteristic features	Example
Rhizopoda (rhizopods)	Organisms have pseudopodia for locomotion	
Zoomastigina (flagillates)	Heterotrophic organisms which have at least one flagellum for locomotion	
Sporozoa	Mainly parasitic organisms which reproduce by multiple fission.	
Ciliophora (Ciliates)	Organisms that possess cilia	
Euglenophyta (euglenoid flagillates)	Organisms with flagella but with biochemistry quite distinct from that of flagillates.	

2) Assuming you are a taxonomist, would you classify bacteria and archaeans into separate domains? If yes, give a reason to support your answer.

3) Distinguish between bryophytes and Angiosperms (use a table).

4) Suggest various methods you can use at home to prevent food spoilage by bacteria. How can you use each of the methods suggested?

5) How are skills of constructing a dichotomous key important to you as a biology student?

## Answers for extension activities

1) The answers are summarized in the following table:

Phylum	Characteristic features	Example
Rhizopoda (rhizopods)	Organisms have pseudopodia for locomotion	Amoeba
Zoomastigina (flagillates)	Heterotrophic organisms which have at least one flagellum for locomotion	Trypanosome
Sporozoa	Mainly parasitic organisms which reproduce by multiple fission.	Plasmodium
Ciliophora (Ciliates)	Organisms that possess cilia	Paramecium
Euglenophyta (euglenoid flagillates)	Organisms with flagella but with biochemistry quite distinct from that of flagillates.	Euglena

5) Yes, because the biochemistry of bacteria and archaea is different. Their biochemistry reveals that the metabolism of archaeans is similar to that of bacteria, but the way in which transcription occurs has much in common with eukaryotes. More to that, archaeans have cell wall, but does not contain peptidoglycans. In conclusion, many exist in extreme environments such as volcanic hot springs and too much salty water bodies.

6) Differences between bryophytes and Angiosperms are:

Bryophytes	Angiosperms
They do not have true stem and leaves instead have rhizoids	They have true stems, leaves, roots and bear true flowers.
They have no vascular system i.e. lack xylem and phloem vessels.	They have the vascular system i.e. have xylem and phloem vessels.
They are the most primitive or lowest plants (the smallest plants) e.g. liverworts, hornworts and mosses.	They are mainly higher plants with complex structure and few are small e.g. duckweed which live on surface of ponds

7) In order to prevent food spoilage by bacteria at home, treat food in the following ways;

- Cooking- the heat denatures enzymes and other proteins. This kills bacteria.
- Pasteurising- this involves heating to 72 degrees celcius for 15seconds and then cooling.
- Drying, salting and coating in sugar – these methods dehydrate any bacteria as water leaves them by osmosis.
- Smoking- the food develops a hardened, dry outer surface and smoke contains antibacterial chemicals.
- Pickling – this uses an acid pH to kill bacteria by denaturing their enzymes other proteins.
- Cooling and freezing- these do not kill bacteria but retard enzyme activity so their metabolism, growth and reproduction is very slow.

8)The skills can help me to observe and record characteristic features of a new discovered organism and use them to clearly classify it, following the taxonomic hierarchy.



## 3.1 Key unit competence

To be able to distinguish between the types of microscopy and their principal uses.

## 3.2 Prerequisite (knowledge, skills, attitudes and values)

The learners learnt about Microscope in senior one. Remind learner's microscope they have learnt in senior one but were studied in detailed. Review microscope and provide to the learners more detailed information. During the lessons, create awareness of learners the fact that the content in this unit will help the learner to gain knowledge which can lead them to medical career mainly in laboratory as laboratory technicians and more detailed on microscope will be studied at high levels.

## 3.3 Cross-cutting issues to be addressed

### Standardization culture

Health centers must use standard microscopes and accurate equipment and techniques to identify the cause of sickness. Always ask yourself if the health center you visit meets the standards. Therefore, you are all advised to adhere to medical insurance so that you can have access to health services.

### Inclusive education

This unit involves a collection of specimens and the number of experiments on the proper use of microscope. The experiments require assembling specimens, apparatus and observation of the results. This may be challenging to students with special educational needs especially children with visual impairment. However, the teacher can make some arrangements like:

- Grouping students. Students with special educational needs are grouped with others and assigned roles basing on individual student's abilities.
- Providing procedure earlier before the experiment so that students get familiar with them. They can be written on the chalkboard or printed depending on available resources. If you have children with low vision remember to print in appropriate fonts. Also you are supposed to pay attantion to all categories of learners.
- Every important point is written and spoken. The written points help students

with hearing impairment and speaking aloud helps students with visual impairment

- Remember to repeat the main points of the lessons.

## Gender education

Emphasize to learners that anybody irrespective of their gender can have medical career mainly laboratory technicians. Give role models who are successful laboratory in the area where the learners come from. Make sure that during experiments both boys and girls shares and participate equally in practices, arranging and proper hygiene after experiments.

### 3.4 Guidance on the introductory activity

During this introductory activity, remember that microscope learnt in senior one in the unit of magnifying instruments, guides the learners on this activity.

#### Teacher's activity

- In groups or pairs, help learners to choose group representatives.
- Help learners to use books and search further information on the internet to distinguish between the types of microscopes and their principal uses.
- Supervise the work on how it is conducted and give the learners' opportunity to work in their respective groups.
- Ask learners to present what they have done.
- Help learners to summarize what they have learnt.

### 3.5 List of lessons/sub-heading (including assessment).

	Lesson title	Learning objectives (from the syllabus including knowledge, skills and attitudes):	Number of periods
1	Compound light microscope.	Describe the main features and functions of the components of a compound light microscope. Show perseverance when using light microscopes. Manipulate a compound light microscope to observe prepared slides. Pay attention when using a compound light microscope to avoid damage to the lenses, mirrors and slides.	3

2	Magnification and resolution of a Compound light microscope.	<p>State that magnification is the increase in the apparent size of the object.</p> <p>State that resolution is the ability of the microscope to show two objects as separate.</p> <p>Appreciate the importance of magnifying instruments in Biology.</p> <p>Use of a microscope to determine the relationship between actual size of the specimen and the image.</p> <p>Calculate the approximate size of different biological structures using an appropriate unit of measurement</p>	3
3	Electron microscopes	<p>State the advantages and disadvantages of using an electron microscope.</p> <p>Acknowledge the use of electron microscopes in modern science with reference to electron micrographs.</p>	2
4	Transmitted Electron Microscopy (TEM) and Scattered Electron Microscopy (SEM)	<p>State the principles and limitations of TEM (Transmitted Electron Microscopy).</p> <p>State the advantages and disadvantages of using SEM (Scattered Electron Microscopy).</p> <p>Compare light and electron microscopes</p>	2
5	Microscopic observations	<p>Observe and draw biological specimens under a light microscope.</p> <p>Prepare temporary slides for observation under light microscopes using different objective lenses</p>	2
6	Assessment	Properly distinguish between types of microscopes and their principle uses.	2

## **Lesson 1: Compound light microscope.**

### **Prerequisites/Revision/Introduction:**

It was shown that in senior one they have learnt magnifying instruments where microscope is included and the research that were conducted in school library and through internet, from that information, learners provide the answer on how you can observe and identify different parts of microorganisms using microscope, you start asking questions on microscope. What is microscope? What is its parts and their function? The answers of the learners are the one which help you in the progress of the lesson.

### **Teaching resources**

The microscope, or you can use the diagram, pictures and photos of well labeled microscope if your school does not have a microscope, through the school administrator you can visit your nearest school having microscope.

### **Learning activities 3.1**

Discuss the ways used by biologists to observe and identify different parts of microorganisms such as paramecia, amoeba and euglena.

### **Teacher's activity:**

- Ask learners to brainstorm ways used by biologists to observe and identify different parts of these living organisms.
- Supervise the work how it is conducted and give the learners' opportunity to work in their respective groups.
- Ask learners to present what they have done
- Help learners to summarize what they have learnt.

### **Teacher's activity:**

- Give the learners instructions on how to use light microscope
- Give the learners microscopes and make sure that both boys and girls manipulate equally.
- Supervise the work how it is conducted and give the learners' opportunity to work in their respective groups and make sure that both boys and girls participate and share equally the tasks before, during and after activity.

### **Answer for introductory activity**

Answers to this activity would fall in a range of responses that include; medical, academic, industrial, etc

### Answer for activity 3.1

Biologists use microscope to observe and identify different parts of microorganisms.

### Answer for activity 3.2

Using the light microscope, learners demonstrate how to use correctly the light microscope.

### Answers for Self-assessment 3.1

1) Complete the table below:

Parts of microscope	Functions
Base	supports and stabilizes the microscope
Revolving nosepiece	rotates to allow use of different power objectives
Coarse focus adjustment	moves stage up and down a large amount for coarse focus
Objective lenses	focuses and magnifies light coming through the slide
Eye piece / ocular lens:	magnifies image produced by objective lens

2) The light microscope is important because they allow scientists to study microorganisms, cells, (and their contents), genes, crystalline structures and molecular structures. Microscopes are one of the most important diagnostic tools when doctors examine tissue samples.

3) Help and follow how the learners apply microscope technique rules.

- Carry the microscope with both hands, one hand under the base, and the other on the arm. When getting ready to put the microscope away, always return it to the low power or scanning power setting.
- When setting the microscope on a table, always keep it away from the edge.
- It is generally best to clear your lab table of items that are not being used.
- The lenses of the microscope cost almost as much as all of the other parts together. Never clean them with anything other than lens paper. Paper towels and other paper tissues will scratch the lens.
- Please inform the instructor or the biology lab technician of any microscope damage or irregularity in its operation as soon as possible. Do not return a faulty microscope without first informing the instructor or lab technician.

- You are responsible for the microscope while using it— treat it with care!

## Lesson 2 : Magnification and resolution of a compound light microscope

### Prerequisites/Revision/Introduction:

You must remind the learners the unit of measurement and how to convert one to another and also ask the learner to define microscope, whereby within definition there is magnifying images of small samples and you start the lesson from the answers provided by the learners.

### Teaching resources

The microscope, or you can use the diagram, pictures and photos of well labeled microscope if your school does not have a microscope, through the school administrator you can visit your nearest school having a microscope.

### Learning activities 3.2

#### Teacher's activity:

- Give questions to the learners to measure and in doing that, the learners will develop numeracy, precisions in measuring e.t.c
- Give the learners the guidance on the activity.
- Supervise the work on how it is conducted and give the learners' opportunity to work on their own.

#### Answer for activity 3.2

1) Work out the following measurements:

2) 1 millimetre (mm) =  $10^{-3}$  metre (m) = 1/1000

3) 1 micrometre ( $\mu\text{m}$ ) =  $10^{-6}$  metre (m) = 1/1 000 000

4) 1 nanometre (nm) =  $10^{-9}$  metre (m) = 1/1 000 000 000

5) 1 metre (m) = 103 mm = 106  $\mu\text{m}$  = 109 nm, 1 kilometre (km) = 103m

#### Answers for self-assessment. 3.2.

1) Magnification= size of the image / size of object

The size of the image should be converted to  $\mu\text{m}$ : Size of image =50mm=50000 $\mu\text{m}$

Therefore, magnification =50000 /5=10000

Conversely, if the magnification is 50000 times, and the size of the image is 5mm (5000

$\mu\text{m}$ ), the actual size of the object is:  $\text{size of image/magnification} = 5000/50000 = 0.1 \mu\text{m}$

2)  $100/10000 = 0.01 \text{ mm}$  (observed size divided by magnification)

This can be converted to  $\mu\text{m}$  by multiplying by 1000

$0.01 \text{ mm} = 10 \mu\text{m}$ , or it can be calculated as  $100 \text{ mm} \times 1000 \mu\text{m}$

Actual size =  $100 \ 000/10 \ 000 \mu\text{m} = 10 \mu\text{m}$

## **b) Microscopic observations**

### **Prerequisites/Revision/Introduction:**

Reminding the learners, the way used to observe microorganisms such as a bacterium, amoeba, and paramecium and motivate them to come up to observe them on their own. The learners may pay attention because after preparing activity and Observing, they draw and label the parts visible under a light microscope.

### **Teaching resources**

Petri-dishes, plate covers, pencil, transparent tape, microscope, agar powder, permanent slide of bacteria, amoeba, and paramecium, Bunsen burner or any other source of heat.

### **Learning activities 3.3**

Using prepared slides of microorganisms such as a bacterium, amoeba, and paramecium. Observe, draw and label the parts visible under a light microscope.

### **Teacher's activity:**

- Give the learners materials to be used in activity and make sure that both boys and girls participate and share equally the tasks before, during and after activity.
- Supervise the work on how it is conducted and give the learners' opportunity to work in their respective groups and by respecting gender and learners with special need if they are any.
- Ask learners to present what they have done
- Help learners to summarize what they have learnt.

### **Activity 3.4**

**Teaching resources:** A thin onion membrane, microscopic glass slides, microscopic cover slips, a needle, blotting paper, dropper, Iodine solution and water again, through the school administrator you can visit your nearest school having microscope.

## Teacher's activity:

- Guide learners to form group or pairs by respecting gender and learners with special need if they are any.
- Give the learners materials to be used in activity and make sure that both boys and girls participate and share equally the tasks before, during and after activity.
- Supervise the work how it is conducted and give the learners' opportunity to work in their respective groups.
- Ask learners to present what they have done

Help learners to summarize what they have learnt.

## Answer for activity 3.3

Interpretation of the results and conclusion

*Figure 3.1: Structure of paramecium, euglena and amoeba*

### Note that:

- a) Paramecium is likely to be dominant, the others are rarely observed. High population of amoeba can be obtained by collecting different samples of pond water or stagnant water by the road sides which is getting dry. However, culturing may not give the best results for obtaining amoeba rather than other protists.
- b) You should make sure that the water collected contains the amoeba before the students start the practical to avoid frustration.

## Answer for activity 3.4

### Observations:

- Large, rectangular interlocking cells,
- Clearly visible distinct cell walls surrounding the cells,
- Dark stained nucleus,
- Large vacuoles at the center,
- Small granules may be observed inside the cells (within the cytoplasm)
- The layers of an onion contain simple sugars (carbohydrates) some of which are stored as starch (starch granules). Given that iodine tends to bind to starch, it stains the starch granules when the two come in to contact making them visible.
- Although onions may not have as much starch as potato and other plants, the stain (iodine) allows for the little starch molecules to be visible under the microscope. Although onions are plants, students will not see any chloroplasts



in their slides.

- This is because of the fact that the chloroplast necessary for photosynthesis is largely present in the leafy part of the onion, which is exposed to the sun and absent in the bulb which is below ground and away from sunlight.
- Unlike animal cells, students will also notice that the plant cells have a more regular shape. This is because they have a cell wall made up of cellulose which maintains its shape.

## Conclusion

This is an easy and fun activity that will allow the student to learn about the cell structure. Students have the opportunity to experiment and observe the onion membrane with different stains (methylene blue and iodine) and without the stain and observe the differences.

Having observed the **onion cell** under the microscope, students will be able to repeat the experiments for **young stems and roots**.

## Lesson 3 : Electron microscopes.

### Prerequisites/Revision/Introduction:

The learners know well microscope from senior one in magnification instruments and even in the previous lessons, help them to make research and give time to present what they found during the activity, ask questions which help learners about electron microscope, what is it and respectively advantages and disadvantages.

### Teaching resources

The microscope, or you can use the diagram, pictures and photos of well labeled microscope if your school does not have a microscope, through the school administrator you can visit your nearest school having microscope.

### Learning activities 3.3

Discuss the difference between light microscope and electron microscope

### Teacher's activity

- Ask learners to brainstorm the difference between light microscope and electron microscope, in doing activity helps the learners to develop Cooperation, interpersonal management, life skills.
- Supervise the work how it is conducted and give the learners' opportunity to work in their respective groups.
- Ask learners to present what they have done

- Help learners to summarize what they have learnt.

### Answer for activity.3.3

- Learners may provide different answers like **light microscope** uses **light** to illuminate specimens and glass lenses to magnify images, an **electron microscope** uses a beam of electrons to illuminate specimens and magnetic lenses to magnify images. The resolution (the level of image detailing) is the main **difference between** these two **microscopes**.

### Answers for Self-assessment 3.3.

1) **An electron microscope** uses a beam of **electrons** to magnify an object. The lensing system employs electric and magnetic fields and is specialized for applications requiring much higher magnification while **light microscopes** employ **light** and an array of glass lenses to magnify an object.

2) Advantages of the electron microscope over light microscope:

Electron microscope has a higher resolution and is therefore able of a higher magnification estimated at up to 2 million times compared to the light microscope which can show a useful magnification only up to 1000-2000 times. These differences are due to a physical limit imposed by the wavelengths of the light. Electron microscopes therefore allow for the visualization of structures that would normally be not visible by optical microscope.

Depending on the type of electron microscope different observation can be processed. For example, for a transmission electron microscopy (TEM) a beam of electrons is transmitted through a specimen to form an image of the specimen which is most often an ultrathin section less than 100nm thick or a suspension on a grid, while the scanning electron microscope (SEM) produces images of a sample by scanning the surface with a focused beam of electrons. The SEM has a resolution power of about 5 nm higher than that of a light microscope but lower than that of a TEM.

### Disadvantages of electron microscope

Despite the advantages, electron microscope presents a number of disadvantages and limitations.

- These type of microscope are extremely expensive and the maintenance costs are high.
- Sample preparation is often much more elaborate.
- Samples must be completely dry so that it is impossible to observe living specimens and moving specimens (they are dead).
- It is not possible to observe colors because electrons do not possess a color.

The image is only black-white, even if sometimes the image is colored artificially to give a better visual impression.

- They require more training and experience in identifying artifacts that may have been introduced during the sample preparation process.
- The energy of the electron beam is very high, the sample is therefore exposed to high radiation, and therefore not able to live.
- The space requirements are high, so that they may need a whole room.

## **b) Transmitted Electron Microscopy (TEM) and Scattered Electron Microscopy (SEM)**

### **Prerequisites/Revision/Introduction:**

Starting from the previous lesson of electron microscope, make revision on it through asking questions to the learners, relate them to the types of electron microscope to make learners understand this lesson, the learners answer the questions, the main ideas/ answers provided by the learners are discovered by them through activity 4.5. In teacher's book, give time to express their views.

### **Teaching resources**

Transmitted Electron Microscopy and Scattered Electron Microscopy or you can use the diagrams, pictures and photos of well labeled microscopes if your school does not have a microscope, through the school administrator you can visit your nearest school having microscope.

### **Learning activities 3.4**

Through the activity done by the learners, on differentiate SEM and TEM, ask them questions on the work done like what is SEM and TEM? Differentiate the two types of electron microscopes? What they do? Then they give the answers which help you to cover the content.

### **Teacher's activity 3.4**

- Ask learners to brainstorm the difference between differentiate SEM and TEM.
- Supervise how the work is conducted and give the learners' opportunity to work in their respective groups.
- Ask learners to present what they have done
- Help learners to summarize what they have learnt.

### Answer for activity 3.4.

SEM	TEM
SEM is based on scattered electrons	TEM is based on transmitted electrons.
SEM focuses on the sample's surface and its composition	TEM provides the details about internal composition. Therefore, TEM can show many
The sample in TEM has to be cut thinner	there is no such need with SEM sample
TEM has much higher resolution than SEM.	SEM has lower resolution than TEM
SEM allows for large amount of sample to be analyzed at a time	TEM only small amount of sample can be analyzed at a time.
In TEM, pictures are shown on fluorescent screens	In SEM, picture is shown on monitor.

### Answers for Self-assessment 3.4

1) Electron microscopes are very important in medicine and biology research because they are used to investigate the ultra-structures of a wide range of biological and inorganic specimens including viruses, microorganisms, cells, large molecules, biopsy (examination of tissue removed from a living body to discover the presence, cause, or extent disease) samples, metals, and crystals.

It is not possible to view any living material by using electron microscope due to vacuum inside electron microscope and living specimens cannot be viewed because electron microscopes require a vacuum in the tube - otherwise the electrons would be absorbed by air molecules

2) The energy of the electron beam is very high, the sample is therefore exposed to high radiation, and therefore not able to live. It is large and heavy, so are not easier to move and set-up and it is very expensive.

3) Comparative study between light and electron microscope focussing on the advantages of each type of microscope.

- Both light and electron microscopes form larger (magnified) and more detailed (highly resolved) images of small objects or small areas of larger objects
- Both light and electron microscopes are used in study and research in biology and medical sciences particularly histology, material sciences such as metallurgy and other aspects of science.

- Specimens must be carefully prepared using techniques appropriate for both the equipment and the sample including slicing, staining, and mounting.

### 3.6 Summary of the unit

- **A microscope** is an instrument used to see objects that are too small for the naked eye.
- The science of investigating small objects using such an instrument is called microscopy.
- There are two types of microscope: **The light microscope** and electron microscope whereby the light microscope is a type of microscope which uses visible light and a system of lenses to magnify images of small samples.
- Magnification refers to the enlargement of the object being studied, while resolution power of a microscope is the ability to distinguish between two points as separate.
- **Microscope's resolution** measures how much detail user can see. A microscope may have powerful magnifying lenses, but if the resolution is poor, the magnified image is just blur.
- **Resolution** is the shortest distance between two points that user can still see as separate images under the microscope and an **electron microscope** is a microscope that uses a beam of accelerated electrons as a source of illumination. Its magnification is about **x 10,000,000** and resolution power is up to **1 nm**.
- Electron microscope comprises also two types as follows: Transmission electron microscope (TEM) and scanning electron microscope (SEM).
- The TEM has a resolution power of about 1 nm and it is used to study the ultra-structure of a cell while the SEM is used to produce a three-dimensional (3-D) view of objects such as cells, tissues and small organisms.
- Light microscope allows to observe organisms of small size including bacteria, amoeba and paramecium.
- Some other parts of macroscopic organisms such as cells and tissues of plants and animals or some parts of these living organisms such as stems and roots can also be observed under light microscope.
- This unit help learners to use well prepared slides as whereas prepare a temporary slide on their own.

### 3.7 Additional Information

You are recommended to do all experiments provided in student's book before you go in class for the learners in order to get deeper understanding of the unit.

### 3.8 End of unit assessment 3

1) b   2) a   3) d   4) b   5) d

6) A microscope is an instrument used to see objects that are too small for the naked eye.

7) The following are the answers:

- **Stage:** is a platform used to hold the specimen in position during observation.
- **Stage clips:** are pliers used to fix and hold tightly the slide on stage.
- **Arm:** supports the body tube of microscope
- **Body tube:** maintains the proper distance between the objective and ocular lenses
- **Arm:** used for holding when carrying the microscope and it holds the body tube which bears the lenses.
- **Coarse focus adjustment:** moves stage up and down a large amount for coarse focus

8) A light microscope uses light to illuminate specimens and glass lenses to magnify images. Light microscope allows to observe organisms of small size including bacteria, amoeba and paramecium and some other parts of macroscopic organisms such as cells and tissues of plants and animals or some parts of these living organisms such as stems and roots can also be observed under light microscope while an electron microscope uses a beam of electrons to illuminate specimens and magnetic lenses to magnify images. Electron microscopes are used to investigate the ultra-structures of a wide range of biological and inorganic specimens including viruses, microorganisms, cells, large molecules, biopsy (examination of tissue removed from a living body to discover the presence, cause, or extent disease) samples, metals, and crystals. The resolution (the level of image detailing) is the main difference between these two microscopes.

9) The following are the answers:

a) To set up a light microscope to view a slide under high magnification follow the Procedures below as for lower magnification only different is where you rotate the nosepiece so that the large objective lens (with higher magnifying power) is immediately above the specimen

- Make sure you understand the manipulation and parts of a microscope before you use it.
- Objects (specimens) to be observed under the microscope are first placed on a glass slide and covered with a cover slip.
- Place the stage on the stage of your microscope, in other words, arrange it so

that the specimen is exactly at the centre of the hole at the stage.

- Fix the slide in place with two clips.
- Rotate the nosepiece so that small objective lens is immediately above the specimen.
- Clearly set the angle of the reflector mirror so that light is directed up through the microscope.
- Look down the microscope through the eye piece. Adjust the iris diaphragm so that the field of vision is bright and not dazzling.
- Carefully turn the course adjustment knob until the tip of the objective lens is close to the slide.
- Now look down the microscope again. Slowly turn the course adjustment knob in the other direction, so the tube gradually moves upwards. The specimen on the slide should eventually come into view.
- Use the course and fine adjustment knobs to focus the object as sharply as possible.
- If necessary readjust, the iris diaphragm so the specimen is correctly illuminated. You will get a much better image if you don't have too much light coming through the microscope.

To observe under high power at a greater magnification, proceed as follows:

- Rotate the nosepiece so that the large objective lens (with higher magnifying power) is immediately above the specimen. The nosepiece should click into position, as before.
- If the specimen is not in focus, focus it with fine adjustment knob. Be careful that the tip of the objective lens does not touch the slide.
- Readjust the illumination if necessary.

b) Electron microscopes have certain advantages over optical microscopes:

- The biggest advantage is that they have a higher resolution and are therefore also have a higher magnification (up to 2 million times). Light microscopes can show a useful magnification only up to 1000-2000 times. This is a physical limit imposed by the wavelength of the light. Electron microscopes therefore allow for the visualization of structures that would normally be not visible by optical microscopy
- Depending on the type of electron microscope, it is possible to view the three dimensional external shape of an object (Scanning Electron Microscope, SEM)

c) Magnification refers to the enlargement of the object being studied, while resolution power of a microscope is the ability to distinguish between two points as separate.

## The following are the answers:

A) Light microscope works because light goes through your specimen. So if the specimen is too thick, then light won't shine through, and you won't see anything so cutting specimen must be done to make it thinner.

b) Using biological stains such as methylene blue, it is possible to clearly observe and differentiate the different parts of a cell. This is because the stain will color some parts of the cell and not others, allowing them to be clearly observed.

## Materials

Onion root tips, Needles, Brush, Razor blades, Microscope slides, Coverslips, Microscope, Safety glasses, Gloves, Paper towel, Fixative, 0.5% toluidine blue, Glycerin

## Procedure

- Obtain an onion bulb that is just beginning to show the emergence of roots. Cut off a root and lay it on a microscope slide. Cut off the first approx 0.5cm of the root tip. Discard the rest of the root. Mitotic cells are in the tip, so extra root tissue will only interfere with finding mitotic cells.
- Wear safety glasses and gloves and lab coat.
- Cover the root tip with fixative solution; Let the slide stand for 30 minutes to one hour. After some time of placing the tip in fixative solution you will see some part of root become transparent or translucent. Remove that cleared (transparent) part of the root by cutting it off as that part is the region where cells are elongated (Do not show mitotic cell division). Now you would have a very small piece of root tip which may look pale white or dirty white in color (a dot-sized piece of root tip is all you need).
- Carefully blot around the root to remove excess fixative. Add one drop of fresh toluidine blue stain to the slide let the root tip be stained for 2-3 minutes; after that remove or drain the excess stain (you can even use blotting paper for removing the stain).
- Put one drop of glycerin on the stained root tip and then place cover slip over that. Place the slide between two layers of paper towel on your laboratory bench. Using your finger apply gentle pressure to the cover slip in order to squash and spread the root tip tissue.

**Caution:** The applied pressure should be such that it does not break the cover slip.

**Observation:** Using your microscope (10x), locate the meristematic region of the root tip. Examine the slide at 40x magnification and identify chromosomes at the various stages of mitosis.



### 3.9 Additional activities

#### Remedial Activities

- 1) What is microscopy?
- 2) What does microscope do?
- 3) Distinguish between two different types of electron microscope.
- 4) In Electron Microscope light source is replaced by a beam of very fast moving:
  - a) Electron,
  - b) Neutron,
  - c) Proton,
  - d) Photon
- 5) Electron microscope is much more powerful than:
  - a) Light microscope,
  - b) Compound microscope,
  - c) Simple microscope,
  - d) Stereo microscope

#### Answers

- 1) Microscopy is the technical field of using microscopes to view objects and areas of objects that cannot be seen with the naked eye.
- 2) Microscope makes things bigger.
- 3) The TEM is a types of electron microscope which has a resolution power of about 1 nm and it is used to study the ultra-structure of a cell while the SEM is used to produce a three-dimensional (3-D) view of objects such as cells, tissues and small organisms.
- 4) a)
- 5) a)

#### Consolidation activities

- 1) How is the magnification varied in?

- a) A light microscope?
  - b) An electron microscope?
- 2) Why is the resolving power of an electron microscope so much better than that of a light microscope?
  - 3) Write in your own words on staining.
  - 4) What is the approximate size of the smallest structure that can be observed with a light microscope?
  - 5) One of disadvantages of electron microscope is not to observe colors. Explain

## Answers

- 1) Expected answers
  - a) Magnification in a light microscope is varied by changing the power of the glass lenses.
  - b) Magnification in electron microscope is varied by changing the strength of the electromagnets.
- 2) Electron microscopes use beams of electrons which have a shorter wavelength than light, giving electron microscopes a higher resolution power than light microscope.
- 3) Staining is a technique used in microscopy to enhance contrast in the microscopic image. Stains and dyes are frequently used in biology and medicine to highlight structures in biological tissues for viewing, often with the aid of different microscopes.
- 4) 0.2 micrometers.
- 5) Electron microscope is not possible to observe colors because electrons do not possess a color. The image is only black-white, even if sometimes the image is colored artificially to give a better visual impression.

## Extended activities

- 1) Why do sections of tissue need to be cut into thin slices for examination under a microscope?
- 2) Explain why ribosomes are not visible using a light microscope.
- 3) Write in your own words on electron microscope.
- 4) Write in your own words on the two types of electron microscope.

5) What happened on preparation of temporary slides and observation under light microscope?

## Answers

1) Light cannot penetrate thick slices of tissue, so no detail would be seen.

2) It is because they're way too small. Biologists, faced with the problem that they would never see anything smaller than 200 nm using a light microscope, realized that the only solution would be to use radiation of a shorter wavelength than light. You can see them on SEM or TEM.

3) In this learners can explain by giving different ideas on electron microscope.

4) For this learners can explain by giving different ideas on two types of electron microscope.

5) The answer of this question based on how procedures of preparation is followed step by step:

- Add a drop of water at the center of the microscopic slide to flatten the membrane
- Pull off a thin membrane from the onion layer and lay it at the center of the microscopic slide
- Add a drop of iodine solution or methylene blue on the onion membrane
- Gently lay a microscopic cover slip on the membrane and press it down gently using a needle to remove air bubbles.
- Touch a blotting paper on one side of the slide to drain excess iodine/water solution,
- Place the slide on the microscope stage under low power to observe.
- Adjust focus for clarity to observe.



## 4.1 Key unit competence

Describe the structure and function of cells in an organism

## 4.2 Prerequisites

For the successive teaching learning process of this unity, students should have enough knowledge of the parts of microscope and their functions. They have also to be well skilled on manipulating the microscope so that they can observe specimens under the microscope.

- a students to recall the parts of the light microscope and their functions.
- be sure that student can manipulate the computer and observe micrographs under the microscope.
- the knowledge and skills about how to use the light microscope will help you to guide students to observe prepared slides of cell structure under the microscope.

## 4.3 Cross-cutting issues

### a) Peace and value

It should be integrated in sub-heading called: cell organelles. When teaching that a cell has many organelles with different functions but that all are important and work together for the survival of the cell. Tell students that, in the same way: in human society, we are many but we can work together in peace and harmony despite of the difference of our abilities, disabilities or physical appearance.

### b) Financial education

This cross-cutting issue should be integrated in the sub-heading called: “ultrastructure of the cell”. When guiding students on how to manipulate the microscope, you should give a caution of handling them carefully as they are very expensive.

### **c) Gender education**

This cross-cutting issue should be integrated in all sub-headings which will involve formation and working in groups like, when forming groups for learning activities, when carrying out practical activities, and when cleaning materials used during practical activities. Both boys and girls should participate equally in all activities.

### **d) Inclusive education.**

This cross-cutting issue should be integrated in all sub-headings. When forming groups for learning activities, when carrying out practical activities, and when cleaning materials that have been used during practical activities. Students with disability should be considered and helped regarding their specific cases: hearing impairment, vision impairment, students without arms and legs; teacher and other students should help them to achieve the competences as required in all teaching-learning activities.

## **4.4 Guidance on the introductory activity**

- This activities teacher's guide should provide guidance on how to conduct it, answers as well as a cross reference to the student's book.
- Provide the chart to students which show the structures of eukaryote and prokaryote.
- Engage students to observe the figures on the chart, and investigate them individually.
- Ask students to identify different components of eukaryotic and prokaryotic cells and to suggest the functions of those components.
- Give students the time to think in order to develop their critical thinking competences.
- Receive answers and ideas from students and summarize them by valuing students' contributions.
- Inform students about the general knowledge, skills and values that they will get from this unit.

#### 4.5 List of lessons/ sub-heading

	Lesson title	Learning objectives:	Number of periods
1	Ultrastructure of a cell	<p>Identify plant and animal cell structures visible under a light microscope</p> <p>Prepare temporary slides for: Wandering Jew, in plants and cheek cells in animals.</p> <p>Appreciate the importance of a cell in an organism</p> <p>Show resilience and be aware of artefacts when preparing temporary slides</p>	2
2	Organelles	<p>State functions of cell structures as seen under an electron microscope</p> <p>Observe and draw plant and animal cells under a light</p> <p>Distinguish between ultra-structures of plant cells and animal cells.</p>	3
3	Ultrastructure of the cell membrane	<p>Acknowledge the use of an electron microscope in modern science with reference to electron micrographs.</p> <p>Explain how cell organelles can be isolated by cell fractionation</p> <p>Explain the role of the different components of a cell membrane.</p>	4
4	Prokaryotic and eukaryotic cells	<p>Compare prokaryotic and eukaryotic cells.</p>	2

5	Specialised cells	<p>Explain cell specialisation as the differentiation of a cell or process to do a particular function</p> <p>Appreciate the importance of cell specialisation in multicellular organisms.</p> <p>Interpret charts and micrographs to relate the structure of specialised cells to their functions.</p>	2
	Assessment	Relate the cell structures to their functions and identify the general functions.	2

## Lesson 1: Ultrastructure of a cell

### a) Prerequisites/Revision/Introduction:

For successful teaching-learning process of this unit, students should have enough knowledge of the parts of microscope and their functions. They should be well skilled on manipulating the microscope so that they can observe specimens under the microscope.

### b) Teaching resources

The teaching aids or other resources needed include: microscope, prepared slides and cell micrographs. You may use also charts, computer, projector and other specific materials for students with disabilities. You can also use the student text books.

### Suggested answers on the introductory activity:

1) By observing the diagrams on the chart, we see that the two cell are different basing on their structures:

Eukaryotic cell	Prokaryotic cell
have a true nucleus	Do not have a true nucleus
No cell wall	Have the cell wall
Have many organelles	Have few organelles
Have no capsule	Have the capsule



2) Identify different parts of a prokaryotic cell that may perform functions similar to organelles of a eukaryotic cell.

Prokaryotic cell parts	function
Nucleoid	Control cell metabolism
Mesosome	Attachment of respiratory enzymes
Ribosome	Protein synthesis
Cell membrane	Control of entry and exit of chemicals

### c) Learning activities 4.1

**Teacher's activities:** before starting this **practical activity**, inform your students to take care of the materials that are going to be used, like microscopes, as their functionality depend a lot on proper handling.

Ask students in their groups provided with microscopes and slides to work on the **Activity 4.1** from the students' text books,

- Monitor how the students are progressing towards the knowledge to be learned. Facilitate those who are still behind (but without communicating to them the knowledge).
- Move around the class, listening to students as they discuss and looking at their answers.
- Correct those which are false, completes those which are incomplete, and confirms those which are correct. Help learners to summarize the lesson (short notes) and assess the lesson.

### Answers for the activity 4.1:

#### 1. Visible organelles and parts of a cell from a light microscope (photomicrograph)

- Nucleus, this is a jelly-like nucleoplasm, nucleolus and chromatin
  - Mitochondria, rod-shaped structures tasked to carry out aerobic respiration
  - Starch grains, globular shaped bodies made of carbohydrates
  - Tonoplast, a thin bi-layered enveloping the vacuole
  - Cytoplasm, a jelly-like layer beneath the cell surface membrane
  - Surface membrane, a thin protein and phospholipid bilayer controlling the exit and entry of material to and from the cell
  - Cell wall, a tough and elastic wall of cellulose surrounding the cell
2. Role of mitochondria and ribosomes
- Mitochondria; these are responsible for aerobic respiration
  - Ribosomes; these serve as site for protein synthesis

## Difference between animal cell and plant cell

Criterion	Animal Cell	Plant Cell
Shape	Ovoid or spherical	Polygon
Plastids	Absent	Present
Centrioles	Present	Absent
Vacuole	Small or absent	Big with a tonoplast
Cell wall	Absent	Present
Microvilli	Present	Absent
Plasmodesmata	Absent	Present

### Answers to Self-assessment: 4.1

- 1) The Structures that animal cells and plant cells have in common are:
  - Nucleus with nucleolus and chromatin.
  - Cytoplasm containing mitochondria, Golgibody and other small structures
  - Cell surface membrane.
- 2) The three principles of the cell theory are:
  - All known living organisms are made up of one or more cells
  - All cells come from pre-existing cells by division
  - Cells contain the hereditary information that is passed from cell to cell during cell division.
- 3) The following are the answers:
  - Form of nutrition;
  - Presence of chloroplast in the plant cell bringing about autotrophic nutrition and its absence in animal cell that brings about heterotrophic nutrition
- 4) The answer should show well labeled diagrams of both animal and plant cells with all organelles and interpretation of the diagrams (structure and function of each part).

## Lesson 2 : Organelles of the cell.

### a) Prerequisites/Revision/Introduction:

For successful teaching-learning process of this lesson, students should have enough knowledge of the parts of animal cell and plant cell they already studied in the previous lessons of ultrastructure of cells. They should be well skilled in drawing the structure of the cell showing and all of its parts.

### b) Teaching resources

In this lesson, the teaching aids or other resources needed include: charts that show the structure of both animal and plant cells. You may use also charts, students' text books, computer, projector and other specific materials for students with disabilities.

### c) Learning activities

#### The teacher:

- Present the charts that show the structure of animal cell and plant cell in front of students.
- Ask students to suggest the characteristics and to discuss the function of each part (organelle) seen on the chart individually.
- Let students work individually to find answers of the activity 4.2 found in the students' text books. Be sure that each student is working effectively on the activity.
- Judge the logic of the students' products, correct those which are false, complete those which are incomplete, and confirm those which correct.

#### Answers of the self-assessment 4.2:

1) As mitochondria are the site for energy production, muscle cells which are more active should contain a lot of mitochondria and fat storage cells which are relatively less active contain few mitochondria.

2) Chromosomes contain genetic information that is passed from one generation to the next.

3) Rough ER makes membranes and secretory proteins. Smooth ER makes lipids and detoxification. The Golgi apparatus modifies, sorts and packages proteins and other materials from ER for storage or secretion. Chloroplasts capture the energy from sunlight and convert into chemical energy. Lysosomes break down lipids, carbohydrates, and proteins. They also break down organelles that have outlived their usefulness in the cell. Mitochondria convert stored chemical energy into compounds that the cell can use. The nucleus is the control center of the cell.

4) The following are the answers:

a) A: mitochondrion, B: Golgi apparatus, C: nuclear envelope, D: nucleus, E: nucleolus, F: ribosome, G: rough ER, H: plasma membrane, J: cell wall, K: chloroplast, L: cytoplasm, M: vacuole, N: Golgi vesicles.

b) B: Golgi apparatus modifies, sorts and packages proteins and other materials from ER for storage or secretion.

C: Nuclear envelope: it contains nuclear pores which allow materials to move into and out of the nucleus.

G: Rough ER makes membranes and secretory proteins.

K: Chloroplasts capture the energy from sunlight and convert into chemical energy.

N: Golgi vesicles: they deliver proteins and lipids (that have been modified, sorted and packaged in them by the Golgi apparatus) to their target destination such as lysosomes or the cell membrane.

c) Most of cell walls are made from fibers of carbohydrate and protein. Plant cell walls are composed mostly of cellulose.

d) The cytoskeleton helps the cell to maintain its shape, and also is involved in cell movement.

5) The rough endoplasmic reticulum transport proteins made on attached ribosomes, while the smooth ER does not have ribosomes, and it involves in making lipids that the cell needs.

6) The role of cytoskeleton is to help the cell to maintain its shape, and it is also involved in cell movement.

7) The expected answers are:

a) This organelle is mitochondrion

b) The function of this organelle is that a mitochondrion is the site where Adenosine triphosphate (ATP: a universal energy carrier) is produced during cell respiration.

## Lesson 3 : Ultrastructure of the cell membrane

### a) Prerequisites/Revision/Introduction:

For successful teaching-learning process of this lesson, students should have enough knowledge on the food molecules such as: proteins, carbohydrates and lipids that they studied in ordinary level. They should know the cell membrane as a part of the cell and its functions as learned in the previous lesson of this unit.

### b) Teaching resources

In this lesson, the teaching aids or other resources needed include: charts and micrographs that show the structure of the cell membrane. Microscope, computer, projector, students' text books and other specific materials for students with disabilities.

### c) Learning activities

#### Teacher's activities:

- present the projection of animations showing the ultrastructure of the cell membrane in front of students.
- ask students to relate each part of cell membrane with its functions as required in the activity 4.3 found in the students' text books.
- be sure that every student is working effectively on the activity by moving around them.
- judge the logic of the students' products, correct those which are false, complete those which are incomplete, and confirm those which correct.

#### Answers to the activity 4.3:

The main features of the fluid mosaic model are:

- A bilayer of phospholipid molecules forming the basic structure.
- Many protein molecules floating in the phospholipid bilayer. Some are free, others are bound to other components or to structures within the cell.
- Some extrinsic proteins are partially embedded in the bilayer on the inside or the outside face while other intrinsic proteins are completely spanning the bilayer.

## Roles of different components of cell membrane

### a) Cholesterol

- Gives the membranes of some eukaryotic cells the mechanical stability.
- It fits between fatty acid tails and helps make the barrier more complete, so substances like water molecules and ions cannot pass easily and directly through the membrane.

### b) Channel proteins

- Allow the movement of some substances across the membrane.
- Large molecules like glucose enter and leave the cell using these protein channels.

### c) Carrier proteins

- Actively move some substances across the cell membrane. For example, magnesium and other mineral ions are actively pumped into the roots hair cells from the surrounding soil.
- Nitrate ions are actively transported into xylem vessels of plants

### d) Receptor sites

- Allow hormones to bind with the cell so that a cell response can be carried out.
- Glycoproteins and glycolipids may be involved in cells signaling that they are self to allow recognition by the immune system.
- Some hormone receptors are glycoprotein and some are glycolipid.

## Answers of the Self-assessment 4.3

1) The expected answers are:

The fluid mosaic model of the cell membrane is the model of the cell membrane structure, where lipid molecules give fluidity and proteins in the membrane give it mosaic (patchwork) appearance.

2) **Properties of the cell membrane are:**

- It is mainly made of lipids, proteins and carbohydrates
- It is semi-permeable or partially permeable i.e. it allows some substances to pass through but prevents other to cross depending on their size, the charges and their polarity
- It is positively charged outside and negatively charged inside,
- It has a hydrophilic pole and a hydrophobic pole

- It is a bilayer
- It is sensitive
- It is flexible
- Its proteins and lipids may be mobile
- It contains enzymes
- It is perforated of pores
- It recognizes chemicals messengers (hormone, neurotransmitters)

### 3 The types of proteins in cell membrane are:

- Carrier proteins which fix or attach molecules and facilitate them to cross through the cell membrane by active transport
- Channel proteins which pump substances and allow facilitated diffusion. They act as pores.
- Receptors of enzymes and neurotransmitters
- Glycoproteins act as receptor proteins which recognise the substance to pass through the membrane
- Integrated proteins define the shape of the cell
- Immune proteins (antigens) found in the membrane on the red blood cell, recognise the antibodies.

4) Partially permeable membrane mean that cell membranes are permeable to water and some solutes.

5) The word hydrophilic means “water loving” and hydrophobic means “water hating”.

6) The expected answers are:

a) Cell signaling and recognition is done by some hormone receptors which are glycoproteins glycolipids.

b) Carrier proteins

c) Enzymes and coenzymes.

a. A: glycolipid, B: Channel protein, C: glycoprotein, D: phospholipid bilayer.

The function of the part B (channel protein) is to help to move materials across the cell membrane.

7) The expected answers are

- The rough ER is surrounded with ribosomes and transports proteins made on the attached ribosomes while smooth ER is made of tubular cavities and have no ribosomes
- The rough ER is involved in protein synthesis while smooth ER is involved in lipid synthesis

8) a. The expected answers are

- support
- protection
- movement
- sharp e.t.c

b The expected answers are

- Mitochondria
- Earobic respiration
- They both have a double membrane, circular DNA, 70S ribosomes, etc

## Lesson 5: Cell specialisation

### a) Prerequisites/Revision/Introduction:

For successful teaching-learning process of this lesson, students should have enough knowledge skills and attitudes on the structure of animal cell, plant cell, and the functions of their parts as learned in the previous lessons of this unity.

### b) Teaching resources

In this lesson, the teaching aids or other resources needed include: microscope, computer, and projector, students' text books, charts, micrographs, animations showing the structures of different types of animal and plant cells, and other specific materials for students with disabilities.

### c) Learning activities:

#### Teacher's activity:

- Present the chart showing the different specialised cells.
- Ask students to relate the structure of each cell with its function as required in the activity 4.5 from the students' text books.
- Be sure that every student is working effectively on the activity by moving around in their groups.



- Invite some of the groups to present their productions/findings.
- Judge the logic of the students' products, correct those which are false, complete those which are incomplete, and confirm those which are correct.
- Summarise the learned knowledge and give examples which illustrate the learned content and give short notes. Students participate actively in making the summary.

### Students' activities:

- Students relate specialised cells with their functions as required in the activity 4.5 from the students' text books.
- Students evaluate the productions from others: which ones are correct, incomplete or false.
- Summarise the learned knowledge.

Answers for the activity 4.5:

Specialised cell	Function
Red blood cell	To carry oxygen within blood from lungs to different parts.
Neurone cell	Transport nervous information
Sperm cell	Fertilise the egg
Muscular cell	Involve in movement

### Answers of the Self-assessment 4.4:

- 1) Because their nucleus is lost, Erythrocytes are specialized by having a biconcave shape which enable them to carry out their function (to transport Oxygen) sufficiently.
- 2) Cell division, protein synthesis, aerobic respiration.
- 3) Expected answers:
  - a) Neutrophils contain many lysosomes that have digestive enzymes to digest pathogens.
  - b) Sperm cells have the tail which helps them to move, they have many mitochondria which produce APT that provides energy for movement, and they have also enzymes in their acrosome which digest the walls of the egg during fertilization.
  - c) Root hair cells have thin wall, are numerous to provide large surface area for absorption of water and minerals.

4) Photosynthesis is carried out in palisade mesophyll more than in spongy mesophyll because palisade mesophyll contains many chloroplasts compared to spongy mesophyll.

5) It is multicellular organisms where cell specialization is a characteristic

They help organisms to adapt better to their environment by different responses

## 4.6 Summary of the unit

This unit “**cell structure and specialisation**” is divided into five sub-units such as: ultrastructure of animal and plant cells, cell organelles, ultrastructure of the cell membrane, prokaryotic and eukaryotic cells, and cell specialisation.

- The unit deals with investigating the **ultrastructure** of animal and plant cells which allows to know similarities and differences between animal cell and plant cell. This ultrastructure of the cells, reveals different parts that are found in it.
- The cell has **many organelles** with different structures and different functions, but all work together for the good health of the cell.
- This unit shows **the structure of cell membranes**, the cell membranes and how they are adapted to perform their functions.
- The unit shows that there are two types of organisms: **prokaryotes** with cell lacking some organelles including the nucleus, and **eukaryotes** which are more complex with cells having nuclear envelopes which surround the genetic material.
- This unit talks about **the specialisation of cells**, where cells are differentiated by acquiring special structures which allow them to perform different functions in the body.

## 4.7 Additional Information

Our body is made up by many cells. A group of many cells having similar function is called a tissue. A group of many tissues having similar function make an organ. A group of many organs makes a system/organ system. Many systems working together make an organism. Below is a list of lifespan of some cells:

### Life spans of various human cells

## 4.8 Answers for the End unit assessment

### I. Multiple choice questions

- 1) d
- 2) c
- 3) a

4) b

5) b

## II. Match questions

**Match each part of the cell to its correct statement:**

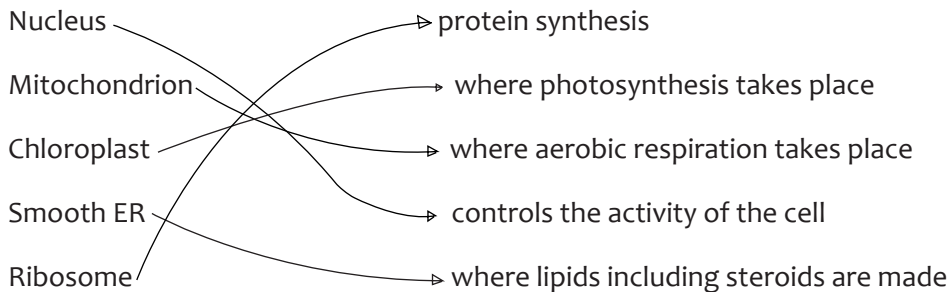

## III. Brief questions

1) A cell membrane is directly in contact with the plasma (cytoplasm) and is found in all cell, with a cell wall surrounds the cell membrane and is not found in animal cells.

2) The structures that animal and plant cells have in common are: nucleus, cytoplasm, cell membrane, mitochondria and ribosomes. Those found only in plant cells are: cell wall, permanent vacuole and chloroplasts, and those found only in animal cells are: lysosomes and centromere.

3) List:

a) Centrosomes, centrioles, nucleolus, ribosomes, cytoskeleton, and flagella.

b) Lysosomes, ER, Golgi bodies.

c) Chloroplast, mitochondrion and nucleus.

4) Identify an organelle from its description below.

a) Golgi apparatus manufactures lysosomes.

b) Nucleolus within nucleus manufactures ribosomes.

c) Ribosome

d) Endoplasmic reticulum.

e) Rough ER can transport newly synthesized protein round the cell.

f) Mitochondria

g) Nucleus

- h) Chloroplast
- i) Centriole
- J) Nucleus.
- k) Plasma membrane.
- l) Ribosome.

### 5) Chloroplast and mitochondrion.

## IV. Essay questions

6) The structure and function of the cell membrane consists of a phospholipid bilayer containing proteins. Its functions include: controlling what enters and leaves the cell, protection of internal structures. The cell wall is made of cellulose and proteins. It is porous (has pores) enough to allow water, oxygen, carbon dioxide and other substances to pass through easily. Its functions are: protection and support of the cell.

7) The basic structure of the cell membrane is made by a phospholipid bilayer, containing intrinsic and extrinsic proteins. The basic structure of phospholipids has two parts: hydrophilic part (water loving), which consists of the phosphate head, and hydrophobic part (water hating), which consist of fatty acids. If phospholipid molecules are completely surrounded by water, a bilayer can form. Phosphate heads on each side of the bilayer stick into water, while the hydrophobic fatty acids tails point towards each other.

8) Chloroplasts use energy from sunlight to make energy-rich food molecule. The mitochondria transfer the energy in food molecules to high-energy compounds that the cell can use. Both chloroplast and mitochondria are bounded by double membranes separated by a fluid-filled space. The inner membrane of chloroplast is continuous with thylakoids having the chlorophyll pigment. The inner membrane of mitochondrion is highly folded to form cristae. The central part of the mitochondrion is called the matrix.

9) The following are the answers:

a) A: cell membrane, B: centriole, C: cytoplasm, and D: Rough ER.

b) To calculate the actual length of the mitochondrion, use the formula:

$A = \frac{I}{M} = \frac{I}{M}$ , where: M is magnification, I is image size of mitochondrion (measured on the diagram by using a ruler) and A is actual size.

10) The advantage to have a division of labour between different cells in the body will allow the organism to perform all biological processes to keep it healthy.

11) In Biology, cell fractionation is the process used to separate cellular components while preserving individual functions of each component. In This process: you take some cells, throw them in a blender, and then centrifuge them to separate the organelles.

12) The freeze-fracture technique consists of physically breaking apart (fracturing) a frozen biological sample; structural detail exposed by the fracture plane is then visualized by vacuum-deposition of platinum-carbon to make a replica for examination in the transmission electron microscope. This technique used to look at membranes that reveal the pattern of integral membrane proteins.

## 4.9 Additional activities

### 4.9.1 Remedial Activities:

- 1) On your choice, list and give the functions of two organelles from animal cell and plant cell.
- 2) What is the adaptations of chloroplast for its function?
- 3) State the general function of the glycoproteins and glycolipids.
- 4) Which among prokaryote and eukaryote is more complex?
- 5) Explain how a sperm cell is adapted to fertilise the egg.

### Answers to Remedial activities:

- 1) From animal cell: mitochondria: site for energy production; nucleus: it controls all cell activities. From plant cell: chloroplasts: site for photosynthesis, Ribosomes: site for proteins synthesis.
- 2) Chloroplasts are adapted by: having thylakoids with chlorophyll where light-dependent reactions occur, stroma where light-independent reactions occur.
- 3) Both glycoproteins and glycolipids are involved in the cell protection, the process by which cell adhesions are brought about and also in the uptake and entry of selected substances.
- 4) Eukaryote is more complex than prokaryote. Eukaryote may be a multicellular organism with many structures that are not found in prokaryote. Also, eukaryotic cells have most of all organelles, but prokaryotic cells lack some organelles like a real nucleus.

5) A sperm cell is adapted by having: tail for movement, many mitochondria to produce energy for movement, acrosome with enzymes for digesting the wall of the egg during fertilisation, half number of chromosomes which, when fused with chromosomes from the egg form a diploid zygote.

#### 4.9.2 Consolidation activities

- 1) Discuss two largest organelles of an animal cell and their functions.
- 2) A student was telling his colleagues that the lysosome is not important to the cell. Discuss to his idea.
- 3) Why must cell membrane be partially permeable?
- 4) Compare a prokaryotic cell to a eukaryotic plant cells considering the presence of the cell wall.
- 5) What are the adaptations of red blood cell for its function?

#### Answers to consolidation activities:

- 1) The nucleus: controls all activities of the cell, and ER: rough ER transports proteins made on attached ribosomes, while smooth ER does not have ribosomes, and it involves in making lipids that the cell needs.
- 2) His idea is wrong. Lysosomes are very important as they contain powerful digestive enzymes which can break down materials, and destroy invalid microorganisms. In acrosome, lysosomes help the sperm to penetrate the egg by breaking down the material surrounding the egg.
- 3) A cell membrane should be permeable in order to allow some materials to move through it.
- 4) Both prokaryotic and eukaryotic plant cell have the cell wall surrounding their plasma membranes.
- 5) Adaptations of red blood cell for its function are: having Haemoglobin to fix oxygen, lacking some organelles including the nucleus for providing big space for haemoglobin, having biconcave shape to facilitate diffusion of gases, they are numerous.

### 4.9.3 Extended activities

- 1) Talk about Robert Hooke contribution on cell discovery.
- 2) How is a cell like a factory?
- 3) How the structure of the nuclear membrane enables it to carry out its function controlling what enters and leaves the nucleus?
- 4) Observe the figure below and answer to questions:
  - a) Does this figure represent eukaryotic or prokaryotic cell?
  - b) State two reasons to support your answer.
  - c) Compare the specialization and functions of cells in your body with the specialization and functions of people in your school.

### Answers to extended activities

- 1) From his experiment on observing slides of cork taken from the bark of an Oak tree under the compound microscope, Robert Hooke decided that the slides were made up of a lot of many small chambers that he called cells. He used the word “cell” in his book *Micrographia*, published in 1665.
- 2) Students may give various answers. One response may involve the comparison of ribosomes to machines in the factory. They may also compare other organelles to different parts of the factory.
- 3) The nuclear membrane contains many pores which enable it to carry out its function controlling what enters and leaves the nucleus?
- 4) The answers are:
  - a) The figure represents a prokaryotic cell.
  - b) The figure has a genetic material (circular DNA) that is not bounded in a nuclear membrane, it has an external cell wall, and it lacks some organelles.
  - c) In our school are many people with different specialization and functions, but all work together for the prosperity of the school. In such way, our body also has many cells with different structures and functions. Despite their differences, all cells in their types work together for the survival of the body.





## 5.1 Key unit competence

Describe different specialized plant and animal cells and adaptation of tissues

## 5.2 Prerequisite (knowledge, skills, attitudes and values)

In senior one students have learnt about animal and plant cells (unit 5), and Levels of organization in multicellular organisms (Unit 6). Remind students some of none detailed concepts like specialized plant and animal cells and tissues that were seen in senior one. This unit deals with the specialized tissues. During the lessons in this unit, try to bring the awareness of students the fact that what you teach them will support to have knowledge on different types of animal and plant tissues as well as their adaptations and importance

## 5.3 Cross-cutting issues to be addressed

### a) Gender education

Engage girls and boys in all activities taking place in classroom and laboratory. Emphasize to students that everybody regardless to gender can do great things. You can also give some examples of exemplary girls and women who are successful teachers, Doctors, Local leaders in the society where students come from.

### b) Inclusive education

Encourage students to participate during lessons, and group activities. Arrange your classroom in special way to take care for those students with special needs.

- For blind students, help them to learn by providing braille.
- For those ones who have sight problems you can print papers with large letters.
- Recognize and allocate the students with disabilities to others so that they can assist them during practical activities.

## 5.4 Guidance on the introductory activity

- This activity should provide guidance on how to conduct it, answers as well as a cross reference to the student's book.
- Learners may not be able to find the right solution but they are invited to predict possible solutions or answers. Solutions provided by learners gradually through discovery activities organized at the beginning of lessons or during the lesson.

### Introductory activity [brainstorming activity]

**Prerequisite:** Learners have knowledge of specialized cell and skills of manipulating a microscope studied in previous unit. This gives learners a good base to study this unit.

### Teacher's activities

- Provide learners with student books and guide them to brainstorm the text in introductory activity on of unit 5.
- Ask learners in their respective groups to do the task below the text.
- Guide learners, to harmonize their presentation and evaluate their understanding.

### Expected answers to the introductory activity:

- Termites are specialized for particular task.
- Soldiers that protect the colony have mouth parts shaped like a pair of scissors building and a slightly larger abdomen for storing water. The queen is the largest of all and has a task of laying eggs
- Workers have mouth parts for cutting and chewing food or soil particles.
- In an anthill, different termites are specialized to perform a particular task as tissues in the body are specialized to perform a particular function.
- Plants and animals have specialized tissues to increase the efficiency which the advantage of division of labor labour in multicellular organisms.

## 5.5 Teaching/learning resources; text books, flip charts, scotch.

	Lesson title	Learning objectives	Number of periods
1	Plant tissues	<p>Observe and draw plant tissues under a light microscope.</p> <p>Analyze and categorize plant tissues</p> <p>Develop research spirit using internet to find out categories of tissues</p>	4
2	Animal tissues	<p>Name the main types of animal and plant tissues.</p> <p>Explain how epithelial tissues have adapted to perform a diversity of functions in the body.</p> <p>Observe and draw animal tissues under a light microscope</p> <p>Analyze and categorize plant tissues</p>	4
3	Levels of organization	<p>Define an organ as a structure made up of a group of tissues with related functions working together to perform bodily functions.</p> <p>Acknowledge the relationship between levels of organization</p>	2
4	Advantages and disadvantages of being unicellular and multicellular	<p>State the advantages and disadvantages of being unicellular or multicellular</p>	2
	Assessment	<p>Can describe different specialized plant and animal cells and adaptation of tissues</p>	2

## Lesson 1: Specialized plant tissues

### a) Prerequisites/Revision/Introduction:

This is the first lesson of the fifth unit Diversity of specialized tissues. In this lesson you will be dealing with specialized plant tissues. The first thing to do before starting teaching is to remind students that they have learnt about plant cells and tissues in senior one (unit 5).

During this lesson, make sure that you bring the awareness of the students the fact that what you teach them will support to have knowledge on different types of specialized plant tissues as well as their adaptations and importance. For good exploitation of students' knowledge about specialized tissues, try to remind the students about plant cells so that they can prepare themselves for this lesson.

### b) Teaching resources

Lesson 5.1 has different activities and laboratory experiments related to specialized plant tissues that require different materials as below,

- Staining reagents such as iodine solution
- Plant tissues
- Microscopes
- Slides
- Plastic ruler graduated in millimeters
- Prepared slides of cells and tissues
- Other resources like charts, printed papers, computer and projector
- Remember! If you find the materials are absent, do not think that it is the end. Do your best by improvisation or consult other schools that may have those materials.

### c) Learning activities

Before starting the new **lesson 5.1**, ask your students to recall the unit 5 in senior one in which they have learnt plant and animal cells and tissues by asking them some questions on cells and tissues like what is a cell? What are two types of cells? What do you understand with term tissue? Opens short discussions to encourage learners to think about the previous learning experience and connect it with the current instructional objectives. Discuss first with your students how they will be working through the new lesson in the unit 5 and that they have a full responsibility in their learning.

The teacher:

- Guide the students to form the groups of six members each. **Remember** to balance the groups basing on the capacity of students, gender and those with special needs to enhance the effective collaborative learning.
- Ask learners to do **activity 5.1** in their student book
- Provide the necessary materials.
- Provide the experiment activity protocol to guide the students
- Engage students in their respective groups to work collectively on activity.
- Relax a moment and move around in silence to monitor if they are having some problems, they are having enough materials, they are properly sharing ideas in English.
- Remember to assist those who are still behind but without giving them the knowledge.
- Invites representatives of groups to presents the group findings.
- ask other students to follow carefully the representations
- Note on chalk board / manila paper the students' ideas.
- Tick the correct findings and correct those ones which are incorrect and try again to complete those which are incomplete.
- Harmonize and conclude on the learned knowledge and still engage students in, then give the summary with tangible examples related to a lesson.

### Answers for activity 5.1.1



- a) A tissue is defined as a group of cells with similar structure working together for a function
- b) Protection against water loss and diseases from viruses and fungi
- c) Storage role

d) Regulates gaseous exchange

- The structure observed is looking as a house wall made by small similar units having nucleus and cytoplasm.
- Those units together form the structure above known as a tissue.
- Provide learners with this flow chart drawn on manila papers in their respective groups.

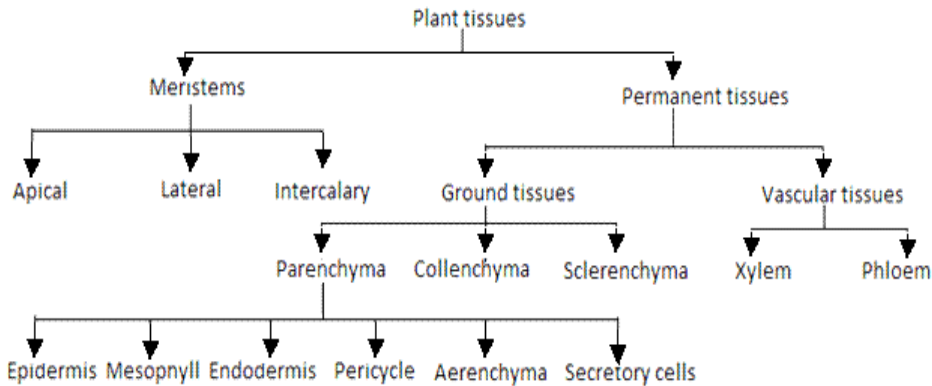

- Ask learners to interpret the chart and answer the questions asked in students' book in activity 5.1.2.
- Guide learners with special education needs depending on the type.

### Answers for activity 5.1.2

a) Meristems are continuously dividing by mitosis and located at growing regions of stem and root while permanent tissues are not.

b) The vascular tissue is a bundle of two kinds of conducting tissues of phloem vessel and xylem tissue

c) How xylem tissue is related to its function.

- The cells are long and arranged end to end to form a continuous column.
- The cell contents die when mature, which means that there is no cytoplasm or nucleus to prevent water flow
- The end walls can break down, so that there is no barrier to water flow between adjacent cells
- How the phloem vessel is related to its function?
- Sieve tube elements are elongated and arranged end to end to form a continuous column
- The nucleus and many of the organelles are located in the companion cells, leaving the lumen of the sieve tube elements more open so reducing resistance to the flow of flow of liquid

- Sieve plates are perforated with sieve pores, reducing resistance to liquid flow
- The sieve plates hold the walls of sieve tube elements together and prevent them from bursting.

d) Ground tissues are of three forms i.e.: parenchyma, sclerenchyma and collenchyma.

Teaching resources: Text books, markers, manila, flip charts.

### Answers for self-assessment 5.1

1) Expected answers are:

- The cambium gives rise to secondary vascular tissues in dicotyledonous plants.
- Found in permanent tissues at nodes of a plants
- They are located in the root and shoot apex, they are responsible for primary growth, leading to the increase of primary plant body.

2)

- Characteristics of meristematic cell no specialized features.
- Thin cell walls, small or no vacuole
- Large prominent nucleus
- Undifferentiated cells
- Undergo rapid cell division
- Cells are mostly isodiametric in shape and sometimes circular
- Absent intercellular space
- Do not undergo secondary thickening
- Cells contain a large number of ribosomes. e.t.c
- The cells are small,

**Differentiation** is the process by which unspecialized structures (cell, tissue, organ, and system) become modified and specialized for performance of specific functions.

- **Cambium** is a plant tissue consisting of actively dividing cells that is responsible for increasing the girth of the plant.
- **Wood** is the hard structural and water-conducting tissue that is found in perennial plants and forms the bulk of the trees and shrubs

### 3) Difference between Collenchyma and sclerenchyma

Collenchyma	Sclerenchyma
Made of living cells	Made of dead cells
Tapering ends do not overlap	Tapering ends overlap and interlock
Ensure mechanical support and flexibility	Ensure mechanical support only
Cell wall is not lignified.	Cell wall is lignified.

4) The main structures (components) that make up:

- **A xylem** consists of two types of conducting cells: tracheid and vessel elements and the wall has pits
- **A phloem** consists of Sieve-tube and companion cells

5) How the structure of Parenchyma Xylem tissues is suitable to their functions?

- Their cells lack cytoplasm
- Absence of nucleus

6) The expected answers are:

**a) Meristem tissue** is a group of cells which retain the ability to divide by mitosis, and specialized to carry out specific functions

b) Answers are:

(i) Lateral meristem: Is found in lateral parts of the plant.

(ii) Intercalary meristem: Is found in the region of permanent tissues like at nodes of monocotyledonous plants

(iii) Apical meristem: Is found in the root and shoot apex (at the growing points of roots and stems).

7) Expected answers are:

- A is sieve tube and B is companion cells
- Phloem tube carries food substances like sugar and amino acids produced in leaves during photosynthesis to every part of the plant.



## Lesson 2: Specialized animal tissues

### a) Prerequisites/Revision/Introduction

This is the second lesson of the fifth unit Diversity of specialized tissues. Lesson 5.2 deals with specialized animal tissues. Before you start teaching, remind students that they have learnt about animal cells and tissues in senior one (unit 5). During this lesson, make sure that you bring the awareness of the students the fact that what you teach them will support to have knowledge on different types of specialized animal and plant tissues as well as their adaptations and importance. For good exploitation of students' knowledge about cells and tissues, try to help them to remember the definition of animal tissue and to prepare themselves for this.

### b) Teaching resources

- Microscopes
- Slides
- Plastic ruler graduated in millimeters
- Prepared slides of cells and tissues
- Acidified phloroglucinol, methylene blue
- Cheek cells
- Other resources like charts, printed papers, computer and projector

**Remember! This lesson needs** more experimental activities in laboratory and other activities in classroom. That is why you have to make sure that the teaching aids listed above are available and utilized to achieve the learning objectives

### c) Learning activities

The teacher:

- Ask students to go in groups formed in previous lesson
- Ask learners to do activity 5.2 in their student book
- Provide the necessary materials.
- Provide the experiment activity protocol to guide the students
- Engage students in their respective groups to work collectively on activity.
- Move around in silence to see if students are having some problems, they are having enough materials, they are properly sharing ideas in English.
- Assist those students who are still behind but without giving them the knowledge.
- Invites representatives of groups to presents the group findings.

- Tell other students to follow carefully the representations
- Write on chalk board / Manila paper the student's ideas.
- Confirm the correct findings and correct those ones which are incorrect and try again to complete those which are incomplete.
- Harmonize and conclude on the learned knowledge and still engage students in making conclusion, then give the summary with tangible examples related to a lesson.

### **Answers for the activity 5.2**

- You are required to orient students in library with clear references. The opportunity they get must be exploited in your silence and monitoring to ensure the students competences.
- Invite randomly four representative students to presents their results, and try to promise them to get clear result as the lesson will carry on.

### **Answers for Self-assessment 5.2**

#### **Lesson 3: Levels of organization**

##### **a) Prerequisites/Revision/Introduction:**

This is the third lesson of the fifth unit Diversity of specialized tissues. Lesson 5.3 deals with the Levels of organization. Before you start teaching, remind students that they have learnt about cells, tissue, organ, system and organization in senior one (unit 5).

During this lesson, make sure that your guidance and assistance will support students to have knowledge on different levels of organization. For good exploitation of students' knowledge about levels of organization, try to help them to remember the definition of cell, tissue, organ and system.

##### **b) Teaching resources**

- **Teaching aids like charts, printed papers, computer and projector.**
- Manila paper with diagrams for improvisation

##### **c) Learning activities**

The teacher:

- Ask learners to do individually activity 5.3 in their student books
- Provide the necessary materials.
- Move around in silence to monitor if they are having some problems
- Remember to assist those who are weak but without giving them the knowledge.

- Invites any three students to present their findings to the rest of students.
- Ask other students to follow carefully the representations
- Note on chalk board / Manila paper the students' ideas.
- Tick the correct findings and correct those ones which are incorrect and try again to complete those which are incomplete.
- Harmonize and conclude on the learned knowledge and still engage students in making that conclusion

### Answers of activity 5.3

Visit a classroom block, administration block or any building in school which is constructed with bricks and use it to answer the following questions. **Precaution: Consider a building of which bricks are exposed (not plastered).**

- 1) A brick.
  - 2) One brick is joined with another one, and another to another to form a line of bricks, many lines of bricks form a wall.
  - 3) Yes, it is made up of smallest particles of soil (sand or clay) or stones.
  - 4) Very many, not easy to count.
  - 5) They are formed by joining smallest components of a building block called bricks.
  - 6) Brick, course, wall, room, block (use arrows to represent a sequence)
- Relate the above arrangement of a building to levels of organization in multicellular organisms, beginning with a cell and ending with an organism.
  - Just as we seen that a building is made up smallest units called bricks, also our bodies also made up smallest units called cells. Cells in multicellular organisms are arranged in a sequence in levels of organization as follows: Cell, tissue, organ, system, and organism. This sequential arrangement is similar as the one of a building above. A cell matches with a brick, course of bricks matches with a tissue; a wall matches with an organ and so on.

### Answers for self-assessment 5.3

- 1) Answer by true or false
  - a) **False**
  - b) **True**
  - c) **True**
  - d) **True**

2) The following are the answers:

a) Basic unit of human body because the whole human body originates from cell

b) Structural unit of human body because the cell makes up the structure of human body

c) Functional unit of human body because all human body's physiological activities take place within the cells

## **Lesson 4: Advantages and disadvantages of unicellular and multicellular organisms**

### **a) Prerequisites/Revision/Introduction:**

This is the last lesson of the fifth unit Diversity of specialized tissues. Lesson 5.4 deals with Advantages and disadvantages of unicellular and multicellular organisms. Before you start teaching, remind students that they have learnt about unicellular and multicellular organisms in senior one (unit 1)

During this lesson, make sure that your guidance and assistance will support students to have knowledge on Advantages and disadvantages of unicellular and multicellular organisms. For good exploitation of students' knowledge about unicellular and multicellular organisms, try to help them to remember the definition of unicellular and multicellular.

### **b) Teaching resources**

- Some resources like charts, printed papers, computer and projector
- Do your best by improvisation or consult other schools that may have other materials you may not have.

### **c) Learning activities**

#### **The Teacher:**

- Ask learners to do in pair **activity 5.4** in their student books
- Provide the necessary materials.
- Move around in silence to monitor if they are having some problems
- Remember to assist those who are weak but without giving them the knowledge.
- Invites any three students to present their findings to the rest of students.
- Ask other students to follow carefully the presentations
- Note on chalk board / Manila paper the students' ideas.

- Tick the correct findings and correct those ones which are incorrect and try again to complete those which are incomplete.
- Harmonize and conclude on the learned knowledge and still engage students in making that conclusion

### **Answers for activity 5.4**

1) Advantages and disadvantages of unicellular organism:

(i) Advantages:

- Unicellular organisms need fewer nutrients and can survive in bad conditions.
- Some of the organisms can generate energy through photosynthesis.
- Sometimes different bacteria work together to work to their advantages.
- Unicellular organisms can multiply quicker and have less energy/resource demands.

(ii) Disadvantages:

- Unicellular organisms only have one cell that is used to function their entire being. This is a disadvantage compared to multicellular organisms, which have many cells and function more easily and properly.

2) Organism being Multicellular

i) Advantages:

- Multicellular organism usually has a wider range of functions because of the aggregation of different types of cells.
- Multicellular organisms have many more necessities and can only survive in certain conditions.
- Multicellular organisms such as animals are unable to make their own food so they survive by eating living things such as vegetables, fruits, and meat. They can also eat things that are produced by other living things such as eggs, milk, and honey.
- Nutrients must be broken down for most multicellular organisms to be able to extract energy from them.

(ii) Disadvantage:

Multicellular organisms such as animals are unable to make their own food and to get food is a tire some work. Their survival in critical condition is rare.

## Answers of self-assessment 5.4

- 1) (Consider answer of question (1) activity 5.4.)
- 2) How unicellular organisms perform their functions.
  - Unicellular organisms get food substances by diffusion through their cell membrane
  - Unicellular organisms live in colonies.
  - Some of unicellular organisms have cilia, flagella that help them to move
  - Some of unicellular organisms have green color(chlorophyll) and are able to perform photosynthesis

## 5.6 Summary of the unit

- This unit is based on the study of Diversity of specialized tissues
- The study of animal and plant tissues is known as Histology.
- A tissue is a group of associated, similarly structured cells that perform specialized functions for the survival of the organism.
- In histology, differentiation is the process by which structures (cell, tissue, organ, and system) become modified and specialized to perform specific functions.
- Plant tissues is divided into two main groups: Meristematic tissues (apical, lateral, and intercalary meristems) and Permanent tissues (ground tissues and vascular tissues).
- **Meristem tissue** is a group of cells which retain the ability to divide by mitosis. It is specialized to carry out specific functions such as reproduction, growth, photosynthesis and replacement of old or damage tissues.
- Permanent tissues consist of two groups of tissues such as: ground and vascular tissues.
- The vascular tissue system consists of two kinds of conducting tissues: **the xylem** responsible for conduction of water and dissolved mineral nutrients, and **the phloem** responsible for conduction of elaborated food.
- There are four basic types of tissue in the body of all animals, including the human body such as **epithelial tissue, muscle tissue, nervous tissue, and connective tissue.**
- The human body is organized into structural and functional levels. The simplest is the cells, organized into tissues, organs, and organ systems.

## 5.7 Additional Information

For better guiding students to perform the experimental activity 5.1 need a detailed procedure as follow:

You divide students into groups of 4 or 6 members and provide the necessary materials such as light microscope, lazar blade, droppers, forceps, glass slides, needles, cover slips

Remember to tell students to clean their materials before starting activity and make sure that all students are recognizing lab rules and regulations.

Do not forget to write the protocol on a chalkboard or to provide the protocol papers if possible. The activity protocol should have the procedures to follow during activity as indicated here under:

- Hold the glass slide on the edges.
- Place a drop of iodine solution on the centre of the glass slide.
- Peel off the thin inner layer of fleshy white storage leaves of the onion made up of a single layer of cells by using forceps.
- Gently, use a razor blade to cut off a small piece of the epidermis, about 1Cm<sup>2</sup>
- Place a small piece of the epidermis of onion in the drop of iodine, flatten it against the slide, by using the needle.
- Hold one side of the cover slip and slowly lower it on top of the iodine. Do this slowly and carefully to avoid air bubbles in specimen to be viewed.
- Using a tissue, clean away the iodine around the cover slip.
- Place the slide on the stage of the microscope.
- Adjust the microscope to view the specimen
- Make good drawing of what you see.
- Remember to move around to make sure weather all students are participating in activities
- Ask students to present their results them you help them to come up with good conclusion.
- Tell the students to leave the working place well-lit and clean.

## 5.8 End unit assessment

**Answer for end unit assessment (Question 1 and 2 are multiple choice based questions, question 3, 4, 5, 6 are long answer based questions)**

1) Epithelial

2) Connective, Muscular, Epithelial, Nervous

3) The answer includes:

- Epithelium lining the respiratory air passages secretes mucus. This helps them to trap inhaled dust particles and microbes.
- Some epithelial tissues are made up of epithelium cells that have cilia. This helps them to propel the mucus and trapped particles to the throat.
- Some epithelial tissues are folded and form glandular tissues. This helps them to secrete the digestive enzymes, hormones, mucus, sweat and sebum.
- Some epithelial cells divide mitotically producing new cells. This helps them to replace damaged or dead cells.
- Some epithelial cells such as taste buds and retina cells are specialized to form sensory receptors.

4) The blood is made up of different kinds of cells that are not similar, even perform different functions. This disqualifies blood to be a true tissue but connective one

### 5) Complete the following table:

Categories of plant tissues according to their functions	Examples of tissues
Growth tissues	Meristem, Cambium
Protective tissues	Cuticle, cork
Storage tissues	Parenchyma,
Support tissues	Sclerenchyma, collenchyma
Conducting tissues	Xylem, Phloem
Secretory tissues	Nectary gland, Fragrance glands

## 5.9: Additional activities

### 5.9.1 Remedial Activities:

1) Write any three functions of parenchyma tissues



**Answer:**

- In the leaves, they form the **mesophyll** and are sites for photosynthesis, gaseous exchange and transpiration.
- They store food substances such as starch, proteins and lipids
- They can be modified to form specialized cells to carry out other function in epidermis, endodermis, pericycle, aerenchyma, and secretory cells.

2) What do you think are types of neurons?

**Answer :**

Sensory neurons (afferent neurons), Interneurons, Motor neurons (efferent neurons)

3) **What do you understand by the term organ?**

**Answer:**

An **organ** is a group of tissues precisely arranged so as to accomplish specific functions.

4) Multicellular organisms are bigger than unicellular organisms. What does multicellular mean?

**Answer:**

Multicellular means many cells

**5.9.2 Consolidation activities:**

1) What are differences between apical meristematic tissue and intercalary meristematic tissue?

**Answer**

a) Apical meristematic tissue

- It is located in the root and shoot apex.
- It is responsible for primary growth.
- While,

b) Lateral meristematic tissue

- It is located in lateral parts of the plant,
- It is responsible for secondary growth.

2) Use the diagrams to differentiate Simple cuboidal epithelium and Simple squamous epithelium

**Answer:**

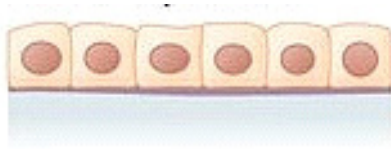

### Simple cuboidal epithelium

- This is a tissue with cells that are cubical in shape
- Cuboidal cells are specialized for secretion and they make up the epithelia of kidney tubules and many glands including salivary glands, and thyroid gland.

While,



### Simple squamous epithelium

- It is thin and leaky
- It functions in the exchange of material by diffusion.
- It lines blood vessels and the air sacs of lungs.

3) What do you think is relationship between organ systems in human body?

**Answer:**

The food is digested in alimentary canal and nutrients enter the blood then assimilated by the body and the waste products like carbon dioxide, urea...after metabolic activities, are released during urination, sweating and breathing, all under the control of nervous system.

4) Multicellular organisms such as animals are unable to make their own food but plants are able to make their own food. This helps us to think about two modes of nutrition in multicellular organisms. Write down the names and define those modes of nutrition.

**Answer:**

- **Autotrophic nutrition:** mode of nutrition where green organisms like plants make their own food using carbon dioxide, water in the presence of sun light.
- **Heterotrophic nutrition:** Mode of nutrition where living organisms like animals,

fungi, get energy from the food made by plants or other organisms. The organisms using this mode of nutrition are not able to make their own food due to lack of chlorophyll

### 5.9.3 Extended activities

1) Imagine what will happen to the flowering plants if the meristem tissue is removed.

**Answer:**

- Inhibition of primary growth
- increased lateral growth
- No growth in length

2) Heat production is one of the functions of human muscle tissue. How these tissues perform it?

**Answer:**

Most of the sugar molecules are stored in muscle tissue, these molecules are used during cell respiration where oxygen combine with them to produce energy which can be in heat form (thermal energy and in force form (mechanical energy)

**Sugar+ oxygen to give Carbon dioxide+ water+ Energy**

3) What do think is the origin of your entire body?

**Answer:**

The body originates from the cell, many similar cells form tissue, tissues make organ, organs make system and finally systems make entire body organism

4) Bacteria are unicellular organisms which do not have sexual organs for reproduction, but their rate of reproduction is extremely high. In you on word, explain if this statement is true.

**Answer:**

Answer of this question should base first on their advantages of being unicellular. These organisms do not need much nutrients for further body activities. They simply divide excessively and regenerate into new uncountable offspring. The mode of reproduction in known as Binary fission or Bipartition.



# UNIT 6 :CIRCULATORY SYSTEM AND LYMPHATIC SYSTEM.

## 6

### 6.1 Key Unit Competence

Relate the structures of the circulatory and lymphatic systems to their functions

### 6.2 Prerequisite (knowledge, skills, attitudes and values)

- Levels of biological organization (cell, tissue, organ, system and organism)
- Organs that are involved in circulatory system.
- Main composition of blood and its functions.
- Lymphatic system
- Blood vessels

The above knowledge, skill, attitudes and value had been acquired in senior three biology (unit 8: circulatory system in humans)

### 6.3 Cross-cutting issues to be addressed:

The cross-cutting that will be addressed include:

#### a) Financial Education.

As a teacher, tell the students how the treatment of cardiovascular diseases is very costly. Explain to them how some of them are treated in abroad developed countries which requires high amount of money yet some of cardiovascular diseases can be prevented through physical exercises that favour normal working of heart and blood vessels.

#### b) Gender

Different activities in this unit requires experiments like dissection, discussion and presentation. If they are done in groups or individually, both boys and girls in class have to participate equally. For example, activities involving dissection must not be dominated by boys or after experiment cleaning of materials and the place used must not involve only girls.

#### c)Inclusive Education

All learners must be involved in all activities in this unit by catering for their special needs. For students who have physical impairment that prevent them hand on activities have

to be provided with assimilations or chart. Those with partial visual impairment can be provided with printed activities in large front size and those with total impairment can be provided with braille or tactile materials.

#### **6.4 Guidance on the introductory activity.**

Put students in groups and provide to them text books.

Students in their groups observe the figure 4.1 from student book and discuss the importance of mass sport for the health of humans as it is encouraged by Rwandan government. The teacher gives the students the following hints to be used in their discussion:

- Effects physical activities to the normal functioning of different organs in the body.
- Contribution of physical activities to blood and other body fluid movement.
- Consequences for those who do not practice physical activities
- Allow students to present their findings then the teacher help them to harmonize their views focusing on circulatory and lymphatic system.

#### **Expected answers for introductory activity**

Regular exercise can lower risk of heart disease, stroke and some types of cancer, and it can improve mental health. It has positive effects on major organs, including heart and brain, in addition to other body systems such as your muscular and skeletal systems. Physical activities help blood and other fluids to move efficiently in the body so that they distribute needed materials in the body and eliminate effectively waste products. When physical activities are not done, this can lead to cardiovascular diseases and muscle diseases. Remember to talk about how government of Rwanda encourage their citizens to do physical activities e.g. Car free day and mass sport in schools

## 6.5 List of lessons/sub-heading (including assessment)

	Lesson title	Learning objectives	Number of periods
1	Lesson1:Blood circulatory system in animals	<ul style="list-style-type: none"> <li>• Explain the need for a transport system in animals.</li> <li>• Explain the advantages and disadvantages of different types of circulatory systems.</li> <li>• Distinguish between open and closed, single and</li> <li>• double circulation with reference to insects, earthworm,</li> <li>• Fish and mammals.</li> <li>• Appreciate the importance of the need for</li> <li>• transport systems when animals become larger, more</li> <li>• complex and more active, to supply nutrients to,</li> <li>• And remove waste from, individual cells.</li> </ul>	2
2	Lesson 2:Structure of the human heart	<ul style="list-style-type: none"> <li>• Describe the external and internal structure of a mammalian heart</li> </ul>	1
3	Lesson3:The heart beat and mammalian cardiac cycle	<ul style="list-style-type: none"> <li>• Explain how a heartbeat is initiated.</li> <li>• Describe the main events of the cardiac cycle</li> </ul>	2
4	Lesson4.Control of the heart rate	<ul style="list-style-type: none"> <li>• Explain how blood circulation is controlled</li> <li>• Describe the effects of exercise on respiration and on circulation</li> <li>• Carry out an investigation on the effects of exercise on the pulse rate and blood pressure.</li> </ul>	1

5	Lesson5:Blood vessels	<ul style="list-style-type: none"> <li>• Explain the relationship between the structure and function of blood vessels</li> <li>• Recognize blood vessels from their structures using a light microscope</li> <li>• Relate the structure of blood vessels to their functions.</li> </ul>	1
6	Lesson 6:Main types of body fluids, their compositions and functions of blood	<ul style="list-style-type: none"> <li>• Differentiate between blood, tissue fluid, and lymph.</li> <li>• Relate blood as a tissue to its functions</li> </ul>	1
7	Lesson7:Transport of respiratory gases	<ul style="list-style-type: none"> <li>• Recall the structure of haemoglobin and explain how haemoglobin transports oxygen</li> <li>• Interpret oxygen dissociation curves for haemoglobin and other respiratory pigments</li> </ul>	1
8	Lesson8:Blood clotting and common cardiovascular diseases	<ul style="list-style-type: none"> <li>• Describe the process of blood clotting.</li> <li>• Describe the risk factors associated with cardiovascular diseases.</li> <li>• Recognize possible risk factors as diet, stress, smoking, genetic predisposition, age and gender in relation to cardiovascular diseases</li> </ul>	2
9	Lesson9:Lymphatic system	<ul style="list-style-type: none"> <li>• Explain how tissue fluid and lymph are formed</li> </ul>	1
10	Assessment Standard	<ul style="list-style-type: none"> <li>• Relate the structures of the circulatory and lymphatic systems to their functions</li> </ul>	2

## Lesson 1: Blood circulatory system in animals

### a) Prerequisites/Revision/Introduction:

Students will learn effectively blood circulatory system in animals if they have understanding on human circulatory system. Here the teacher asks question about human circulatory system which was covered in senior three. From there the teacher asks if annelids, insect and fish have the same circulatory system as the one of human



## **b) Teaching resources**

Use of the illustrations animals found in the student book in activity 4.1 or use live specimen that are easy to get: earthworm, fish, frog and small mammals (rabbit)

## **c) Learning activities**

The teacher provides student books and students attempt activity 4.1 that help them to discuss about the need for transport and circulatory system in annelids, fish and mammals.

## **Methodological steps**

- As a facilitator, form groups of 4-6 students depending on their results and class size.
- Request students to do the activity 6.1.
- Move around groups guiding and facilitating them.
- In mixed class, remember to form groups that contain both boys and girls as well as in presentation.
- Choose three groups to present their answers.
- Starts from answers given by learners then harmonizes need for circulatory system and type of circulatory system of animals from the activity 6.1.
- Write the summary on the blackboard and ask learners to note it.
- Asses the lesson by using questions found in self-assessment 6.1 or formulate your questions

## **Expected answer for activity 6.1**

- 1) The arrangement starts with lion, fish, earthworm
- 2) These animals do not have the same circulatory system. Their circulatory system vary as follows:
  - Lion has closed double circulatory system
  - Fish has closed single circulatory system
  - Grasshopper has open circulatory system
  - Earthworm has closed circulatory system

## **Answers of self-assessment 6.1**

- 1) The transport system is primarily to deliver; nutrients and oxygen to every cell and to remove waste products including carbon dioxide.
- 2) These are differences between open and closed circulation

Closed circulation	Open circulation
Present in annelids and vertebrates	In invertebrates (arthropods)
Blood does not bath the cells	Blood directly bathes the cells
Blood flows in vessels	Blood flows in haemocoel
There is a muscular heart	There is not heart but nodes as simple heart
Higher blood pressure	Lower blood pressure
Blood contains haemoglobin	There is no haemoglobin
e.g. Earthworms, fish, frog, human	e.g. insect, arachnids

3) The following are differences between single and double circulation.

Single circulation	Double circulation
Blood passes through the heart once during one complete circuit of the body	Blood passes through the heart twice during one complete circuit of the body
Lower blood pressure	Higher blood pressure
Present in fish.	Present in amphibians, reptiles, birds and mammals

4) The right side of the heart, delivers oxygen poor blood to the capillary beds of the gas exchange tissue in lungs through pulmonary artery, where there is a net movement of  $O_2$  into the blood and of  $CO_2$  out of the blood. This part of the circulation is called a pulmonary circuit (circulation).

After the oxygen enriched blood leaves the gas exchange tissues (lungs) it enters the left side of the heart through pulmonary vein. Contraction of the left part of the heart propels this blood to the capillary beds in organs and tissues throughout of the body. Following the exchange of  $O_2$  and  $CO_2$  as well as nutrient and waste products, then the oxygen poor blood returns to the right part of heart, completing the systemic circuit (circulation). This circulation is called double circulation because blood must pass twice in the heart for one complete circuit.

## **Lesson 2: Structure of the human heart**

### **a) Prerequisites/Revision/Introduction:**

The teacher asks the learners to draw individually the structure of the human heart and name its different parts in their exercise not book. Allow three learners to draw the structure of the heart on blackboard in order to harmonise what they learnt in senior three (Unit 8)

### **b) Teaching resources**

- The activity in this lesson requires dissection of the heart of the sheep or the goat.
- Dissecting kit and dissecting dishes.
- The chart showing the structure of the heart
- Models of human heart

### **c) Learning activities**

In this activity teacher provides to the students the heart of the goat or the sheep, dissecting kit and dissecting dish and follow procedures from activity 6.2

### **Methodological steps.**

- The teacher brings the hearts of the sheep or goat from slaughter house and provide it to the students.
- Tell to students follow the protocols of activity 6.2 from student's book to dissect the provided heart.
- Inquire students to observe and answer to the questions asked.
- In case of learner with total visual impairment, he can be provided with the model of human heart as a tactile material in order to respond to the asked questions.

### **Expected answers for activity 6.2**

- Students have to identify the following: Left and right atrium, aorta, venacava, septum.
- Left ventricle is thicker compared to right ventricle.

### **Answers self-assessment 6.2**

1)The reasons are:

- a) The left part of the heart is larger than right part of the heart because it has large muscle size which is needed to generate the force necessary to pump the blood to the whole body.

- b) The left ventricle has a thicker muscular wall than the right ventricle because it has to pump blood in the whole body.
- 2) The pericardium pericardial fluid protects the heart from overexpansion caused by elastic recoil when it is beating very fast. Both protect the heart from mechanical shocks

### **Lesson 3: Heart beat and mammalian cardiac cycle**

#### **a) Prerequisites/Revision/Introduction:**

Before beginning this lesson, learners should be able to recall different parts of heart. The teacher provides to the students the chart of human heart and ask them to locate each part of the heart stating also their functions.

#### **b) Teaching resources**

The needed teaching resources are:

- Computer assimilation and computer machine.
- A projector
- The chart showing initiation of heartbeat and cardiac cycle
- Student books

#### **c) Learning activities**

The teacher forms group of 5 students and watch audio visual assimilation of heart beat and cardiac cycle as whole class (activity 6.3). When projection is not possible teacher has to use charts or diagram drawn on a manila paper.

#### **Methodological steps.**

- Teacher has to facilitate the students in the activity 6.3 as follow:
- Whole class watch the assimilation or observe the chart but sitting in their respective groups.
- Within their groups students summarize the process of heart beat and cardiac cycle.
- The teacher will move to different group to guide them.
- Allow groups to present their findings
- The teacher harmonize the process of heart beat and cardiac cycle based on students' presentations.

## Answers for Self-assessment 6.3

- 1) Cardiac cycle is characterized by the following events: atrial systole which is the contraction of atrium and its relaxation is called atrial diastole. When ventricles contract the process is called ventricular systole and it is followed by ventricular diastole. Then the cycle restart with atrial systole.
- 2) The answers are:
  - a) The participant C has cardiovascular problem he is below normal standard of heartbeat, systolic pressure and diastolic pressure.
  - b) Systolic pressure this is the pressure generated when ventricles contract. Whereas diastolic pressure is the pressure generated when ventricles relax.
- 3) The answers are:
  - a) The electrocardiogram trace consists of a series of waves that are labelled P, Q, R, S and T. Wave P shows the excitation of the atria, QRS indicates the excitation of the ventricles and T shows diastole.
  - b) The P wave represents atrial depolarization, which is when the impulse spreads through the atria. The QRS complex corresponds with ventricular depolarization. The P wave is smaller than the QRS complex because the atria have a smaller muscle mass than the ventricles.

## Lesson 4: Control of the heart rate

### a) Prerequisites/Revision/Introduction:

The teacher asks questions about heartbeat and cardiac cycle to test if students understood the previous lesson.

### b) Teaching resources

- The teacher will need the following resources:
- Stop watch, text books, and charts

### c) Learning activities

As a facilitator, teacher has to guide students in the activity 6.4 by providing stop watches, textbooks and instructing students to do the activity in pair.

### Methodological steps

- In pair, students calculate their heart beat per minute following steps from the activity 6.4.

- Record their findings and answer the questions asked in activity 6.4 by comparing their results.
- The teacher moves in each pair guiding students to discuss about their findings, relate them with nervous, hormonal and other factors that controlling in their activity.
- Three or four pairs present their findings as whole class.
- Based on the presentation of the students, the teacher summarizes how nervous, hormonal and other factors (physical exercise, body temperature, caffeine) affect the heartbeat.

### Expected answers for activity 6.4

- a) The heart beat increases after physical exercise compared to the heart beat during resting time.
- b) During physical exercise heart beat quickly in order to distribute O<sub>2</sub> in different tissues which is needed during aerobic respiration and also to eliminate metabolic waste products produced.

### Answers for Self-assessment 6.4

- 1) Sympathetic nerve and vagus nerve connect the heart and autonomic system. The cardiovascular centre that sends impulses to the SAN is located in the medulla oblongata of the hindbrain. The medulla oblongata receives various signals itself, so that it can communicate with the SAN how to respond appropriately to external changes i.e. increase in heartbeat. When the situation goes back to normal, the vagus nerve sends messages to SAN thus slowing down heartbeat in conditions of excitement, activity or stress, adrenaline is released into the blood circulation from the adrenal glands. On reaching the heart it causes an increase in the rate and strength of the heartbeat. If the vagus nerve is stimulated, it causes a release of acetylcholine, which slows down the rate of heartbeat but does not affect the force of ventricular contraction.
- 2) Regular exercise can help in lowering of resting blood pressure and heart rate, not only that but also the heart develops a greater stroke volume.
- 3) **Caffeine, cocaine behaves like adrenaline as a result the cause the increase of heart rate but also there are other specific drugs used in lowering heart rate such as beta- and calcium channel blockers.**

## Lesson 5: Blood vessels

### a) Prerequisites/Revision/Introduction:

As the introduction the teacher will ask student about how blood pumped by the heart reaches to the different parts of the body.

**b) Expected answer:** Blood pumped by the heart reaches to the different parts of the body passing through blood vessels.

### c) Teaching resources

Permanent prepared slides of blood vessels, Light microscopes

### d) Learning activities

The teacher will provide prepared slides and microscopes to the students their respective groups of 4 or 5 students as it is in activity 6.5. Or students can be provided with charts indicating structures of blood vessels then they will observe and characterize them.

## Methodological steps

- Students guided by the teacher they have to carry out activity 6.5 in the following ways:
- Each student in their respective groups observes structures of blood vessels under light microscope. The teacher will be moving to each group helping students to manipulate properly microscope.
- Draw and label structure of blood vessels as observed under microscope.
- Relate the different structures of blood vessel to their functions
- Some students present their findings to the whole class.
- The teacher points out main highlight based on student's presentations and assess the lesson using

## Expected answers for activity 6.5

1) Students do a careful observation under microscope, draw and able to compare the blood vessels.

2)The answer is given in the following table:

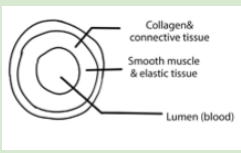
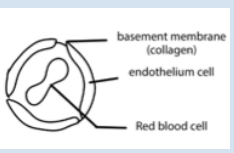
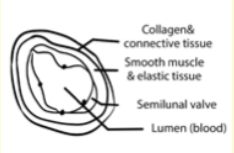
Drawing N.B: The total magnification (X) will depend on the Objective lens and ocular lens used.			
	X....	X....	X....
	Figure: Drawing showing the structure of an artery under a light microscope.	Figure : Drawing showing the structure of a capillary under a light microscope	Figure: Drawing showing the structure of a vein under a light microscope.

3)The answer is given in the following table:

Structure of wall	Thick, strong Contain muscles, elastic fibres and fibrous tissue.	Very thin, only one cell thick.	Thin Mainly fibrous tissue contains far less muscle and elastic tissue than arteries
Lumen	Narrow varies with heartbeat(increases as a pulse of blood passes through)	very narrow Just wide enough for a red blood cell to pass through.	Wide
Valves	Absent (-) Except in the aorta and pulmonary artery.	Absent (-)	Present (+) Prevent backflow of blood.
Branching	Branched into arterioles	No branch	Branched into venules
Function	Carry blood away from the heart at high pressure. Transport oxygenated blood (except pulmonary artery)	Supply all cells with their requirements. So, they provide large area for exchange of materials between blood and body cells. take away waste products	Return blood to the heart at low pressure Transport deoxygenated blood (except pulmonary vein)

4)The answer is given in the following table:



How a structure fits its function	Strength and elasticity needed to withstand the pulsing of the blood, prevent bursting and maintain pressure wave.  Helps to maintain high blood pressure, preventing blood flowing backwards.	No need for strong walls, as most of the blood pressure has been lost.  Thin walls and narrow lumen bring blood into close contact with body tissue, allowing diffusion of materials between capillary and surrounding tissues.  White blood cells can squeeze between cells of the wall.	No need for strong walls, as most of the blood pressure has been lost.  wide lumen offers less resistance to blood flow  Valves prevent backflow of blood.
-----------------------------------	--	---	--

### Answers for self-assessment 6.5.

1)The answer is given in the following table:

Vessels	Functions
Blood artery	Carries oxygenated blood from heart to organs.
Blood capillary	Is the site of exchange of materials between blood and tissue cells
Blood veins	Carry carbonated blood from organs to heart.

2)The answer is given in the following table:

	Artery	Capillary	Vein
Adaptation of each blood vessel to its function	Strength and elasticity needed to withstand the pulsing of the blood, prevent bursting and maintain pressure wave.  Helps to maintain high blood pressure, preventing blood flowing backwards.  These adaptations enable an artery to carry the blood from the heart to organs.	No need for strong walls, as most of the blood pressure has been lost.  Thin walls and narrow lumen bring blood into close contact with body tissue, allowing diffusion of materials between capillary and surrounding tissues.  White blood cells can squeeze between cells of the wall.	No need for strong walls, as most of the blood pressure has been lost.  wide lumen offers less resistance to blood flow  Valves prevent backflow of blood.  These adaptations facilitate a vein to carry the blood from the organs to the heart.

## Lesson 6: Main types of body fluids, their compositions and functions of blood

### a) Prerequisites/Revision/Introduction.

The teacher asks students if it is possible to find fluids in the body. If they exist specify their names and their main functions in the body.

**b) Expected answer:** Blood and lymph

**c) Teaching resources:** Textbooks, charts

### d) Learning activities

The teacher will help students to form groups and provide to them textbooks.

### Methodological steps

Teacher will guide in the following way:

In their respective groups students observe the figure in the activity 6.6 and name different components of blood.

Using text book, they will discuss about functions of different component of the blood.

Allow different groups to present their ideas.

As students presenting teacher will intervene supporting correct ideas then summarize them.

The teacher assesses the lesson using self-assessment 6.6

### Expected answers for the activity 6.6

Blood fluids are: The main body fluids are blood, plasma, serum, tissue fluid and lymph.

The answers are summarized in the following table:

Blood component. Answer 2.a.	Function (Answer 2.b)	Origin (Answer 2.c)
I. Formed elements	Different functions	Bone marrow
1.1.Red blood cells (D and G)	Transport of oxygen. Transport of some carbon dioxide.	bone marrow
1.2. white blood cells (leukocytes)	Fight infection	Bone marrow

1.2.1. granulocytes (granular leukocytes)	Different functions related to fighting infection	Bone marrow
a)Neutrophils (A)	Phagocytize pathogens	Bone marrow
b) Eosinophils (B)	Phagocytize antigen- antibody complexes and allergens	Bone marrow
c)Basophils (H)	<ul style="list-style-type: none"> <li>• Release histamine which promotes blood flow to injured tissues.</li> <li>• Produce heparin(anticoagulant)</li> </ul>	Red bone marrow
1.2.2. Granulocytes ( a granular leukocytes	Different functions related to fighting infection	bone marrow
a) Lymphocytes(C)	<p>1. B-lymphocytes are responsible for humoral immunity, i.e. antibody secretion (substances that recognize and bind to bacteria and allow their phagocytosis and destruction). Granulocytes and monocytes can better recognize and destroy bacteria when antibodies are attached to them (opsonisation). Cells are also responsible for the production of some components of blood serum, called immunoglobulin.</p> <p>2. T-lymphocytes recognize the infected cells and destroy virus using macrophages. These cells amplify or suppress the overall immune response by regulating the other components of the immune system, and secrete many cytokines.</p>	bone marrow, lymphoid tissue and spleen
b)Monocytes (F)	Become macrophages that phagocytize pathogens and cellular debris.	Bone marrow
1.3.Platelets (I)	Blood clotting (coagulation)	Bone marrow

II. Plasma (E)	Different functions	Different sources such as transport of molecules, maintaining the blood volume, pressure and pH as well as fighting infection.
2.1.water	Maintains blood volume. Transports molecules.	Absorbed from small intestine
2.2. Plasma proteins	Maintain blood osmotic pressure and pH.	Liver
a)Albumin	Maintain blood volume and pressure	Liver
b)Globulins	Transport. Fight infection.	Liver
c)Fibrinogen	Blood clotting	Liver
2.3.Salts	Maintain blood osmotic pressure and pH. Aid metabolism	Absorbed from small intestine
Gases	Different functions	Different sources
a)Oxygen	Cellular respiration	Lungs
b)Carbon dioxide	End product of metabolism	Tissues

### Answers for self –assessment 6.6

1)The answer is summarized in the following table:

Cell	Function
Macrophage	Phagocytize the antigens and pathogens
T-lymphocytes.	<ul style="list-style-type: none"> <li>Recognize the infected cells, destroy virus using macrophages.</li> <li>These cells amplify or suppress the overall immune response by regulating the other components of the immune system, and secrete many cytokines.</li> </ul>

## Erythrocytes

- Transport of oxygen.
- Transport of some carbon dioxide.

2) The relationship between blood and tissue fluid is that, when formed elements and most proteins are removed from blood, the tissue fluid is obtained. So, tissue fluid = blood – formed elements- most proteins.

## Lesson 7: Transport of respiratory gases

### a) Prerequisites/Revision/Introduction

To introduce this lesson, the teacher will ask the main functions of red blood cell as it was covered in previous lesson. Proposed answers include:

- Transport of oxygen from the lung to the body cells.
- Transport of carbon dioxide from the body cells the lungs

**b) Teaching resources:** Textbooks, graph paper

**c) Learning activities:** The teacher provides textbooks and graph paper in different formed groups.

### Methodological steps

- As a facilitator, the teacher guides students as follow:
- Students in their respective groups, using textbook and graph paper, will describe, discuss and plot graph as it is stated in activity 6.7.
- The teacher moves within groups helping them during their discussions
- Groups present their work
- The teacher based on their work, highlight clearly the structure of haemoglobin, oxygen dissociation curve and how oxygen and carbon dioxide are transported.
- Afterwards the teacher will assess the lesson.

### Expected answers for activity 6.7

1) Haemoglobin is a red protein responsible for transporting oxygen in the blood of vertebrates. It is also involved in the transport of carbon dioxide. Its molecule comprises four subunits, each containing an iron atom bound to a haem group. It has also globin (polypeptide chain) linked to haem.

2) The answers are:

a) Haemoglobin transports carbon dioxide in the way summarized below:

At the level of systemic capillaries located near the tissue cells, CO<sub>2</sub> molecules diffuse through the cell membrane to tissue fluid to capillary wall (via which they diffuse) to blood. In blood, some molecules of CO<sub>2</sub> combine with haemoglobin to form the carbamino-haemoglobin. When carbonated blood reaches the pulmonary capillaries, the carbamino-haemoglobin dissociates and the CO<sub>2</sub> molecules diffuse through those capillaries toward the lung alveoli from which they pass via the respiratory system to the external environment during exhalation. In blood, these CO<sub>2</sub> molecules are linked to globin of haemoglobin.

b) Haemoglobin transports oxygen in the way summarized below:

Environmental oxygen is produced by autotrophs such as green plants. During inhalation, it enters the nostrils or mouth and moves through the respiratory system until it reaches the lung alveoli. From alveoli, it diffuses through the pulmonary capillary wall to blood. In blood, oxygen is linked to iron (Fe) of haem of haemoglobin of erythrocytes for being transported. This is shown by the equation below:

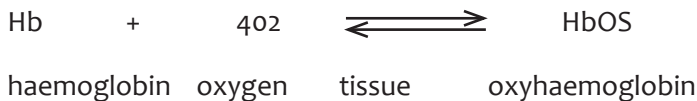

After oxy-haemoglobin dissociation at the level of systemic capillaries, oxygen diffuses through those capillaries walls to tissue fluid to tissue cells in which it is involved in aerobic cell respiration.

3) The answers are:

a) The figure looks like the following:

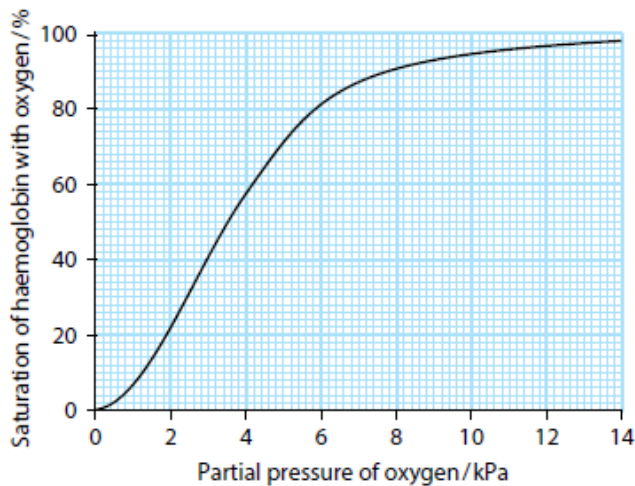

This graph shows the relationship between the oxygen partial pressure and saturation of haemoglobin with oxygen. Based on this curve, it is visible that, as oxygen partial pressure increases, also the saturation of haemoglobin with oxygen increases until

all iron atoms are linked to oxygen. When all iron atoms of haemoglobin are linked to oxygen, no other oxygen is linked to haemoglobin. Hence this curve plateaus.

b) This is oxygen dissociation curve for haemoglobin.

### Answers self –assessment 6.7.

1) Haemoglobin transports oxygen and some molecules of carbon dioxide at different times.

2) The answer is:

2.150 g of Hb → 1 dm<sup>3</sup> of blood.

1 g of Hb → 1.3 cm<sup>3</sup> of O<sub>2</sub>.

150 g of Hb → 1.3 × 150 cm<sup>3</sup> of O<sub>2</sub>

= 195 cm<sup>3</sup> of O<sub>2</sub>

## Lesson 8: Blood clotting and common cardiovascular diseases

### a) Prerequisites/Revision/Introduction:

The teacher will ask students what happens to someone who is wounded blood stops after a short time: Which component of the blood intervene in that process? Expected answer include blood clots and platelets

**b) Teaching resources:** Textbooks and flowchart

**c) Learning activities:** Teacher will provide text books and general flowchart of blood clotting.

### Methodological steps

- Teacher will help students to form groups and guide them during the activity as follow:
- Students discuss about the activity 6.8 in their respective groups.
- The teacher will be moving guiding in their respective groups.
- Different groups present their ideas.
- The teacher harmonize the process of blood clotting process and cardiovascular disease based on students' presentations.
- The teacher will remember tell students how the treatment of cardiovascular disease is expensive yet they can be prevented by doing physical exercises.
- Teacher assesses the lesson.

## Expected answer for activity 6.8

1) The blood component that is involved in blood clotting are: Thrombocytes, Calcium, Fibrinogen and Vitamin K

2) Summary of blood clotting:

- Platelets and damaged tissue cells secrete the thromboplastin (prothrombin activator).
- Thromboplastin (prothrombin activator),  $Ca^{2+}$ , vitamin K and some plasma enzymes catalyse the conversion of prothrombin (inactive enzyme made in liver) into thrombin (active enzyme).
- Thrombin catalyses the conversion of fibrinogen into fibrin threads which trap blood components preventing them from going outside of the body. So, the blood clot is formed.

3) Common cardiovascular diseases:

- **Stroke:** Stroke is a cardiovascular disease due to the lack of oxygen to the brain which may lead to reversible or irreversible paralysis. The damage to a group of nerve cells in the brain is often due to interrupted blood flow, caused by a blood clot or blood vessel bursting. Since atherosclerosis is a body wide process, similar events can also occur in the arteries to other parts of the body, including the brain. A stroke is a loss of brain function due to a stoppage of the blood supply to the brain. It can be caused by a stationary blood clot (thrombus), a free-floating clot (moving blood clot or embolus) that gets caught in a blood vessel, or by bleeding (haemorrhage). Hypertension or high blood pressure promotes atherosclerosis and increases the risk of heart attack and stroke.
- **Atherosclerosis:** Atherosclerosis is a cardiovascular disease characterized by the progressive narrowing and hardening of the arteries over time. Atherosclerosis normally begins in later childhood, and is usually found in most major arteries. It does not usually have any early symptoms. Causes of atherosclerosis include a high-fat diet, high cholesterol, smoking, obesity, and diabetes. Atherosclerosis becomes a threat to health when the plaque build-up interferes with the blood circulation in the heart (coronary circulation) or the brain (cerebral circulation). A blockage in the coronary circulation, can lead to a heart attack, and blockage of the cerebral circulation can lead to a stroke.
- **Coronary heart disease:** Coronary heart disease (CHD) is a disease in which a waxy substance called plaque builds up inside the coronary arteries. Cardiac muscle cells are fed by the coronary arteries. Blocked flow in a coronary artery can result in oxygen starvation and death of heart muscle. Most individuals

4) Risk Factors associated with cardiovascular diseases disease:

- Uncontrollable factors include:



- Gender (males are at greater risk)
- Age (the older you get, the higher your risk)
- A family history of heart disease
- Being post-menopausal
- Controllable risk factors include:
  - Smoking
  - Uncontrolled hypertension (high blood pressure)
  - Physical inactivity
  - Obesity
  - Uncontrolled diabetes
  - Uncontrolled stress and anger.

### **Answer self –assessment 6.8**

**1) Fibrinogen is converted into fibrin threads which trap blood components preventing the continuous bleeding. Ca<sup>2+</sup> (calcium ion) is involved in the conversion of prothrombin (inactive enzyme made in liver) into thrombin (active enzyme), while thrombin catalyses the conversion of fibrinogen into fibrin threads**

**2) Stroke is caused by intravascular blood clot and blood vessel bursting. The Effects of stroke include: Prevention of oxygen from reaching to the brain. Paralysis and death.**

**3) The impact of smoking on the cardiovascular system include:**

- Atherosclerosis.
- Production of CO (carbon monoxide) which compete with oxygen to be fixed on iron of haemoglobin. This causes the death by asphyxiation.
- Nicotine, carbon monoxide and free radicals cause the creation of atherosclerotic plaque and its destabilization.
- Nicotine, carbon monoxide and free radicals are risk factors in coronary artery disease, sudden cardiac death, ischemic stroke, aortic aneurysm (an excessive localized swelling of the wall of an artery) formation, and peripheral vascular disease and Buerger disease. Buerger's disease (thromboangitisobliterans) is a rare disease of the arteries and veins in the arms and legs. In Buerger's disease, your blood vessels become inflamed, swell and can become blocked with blood clots (thrombi).
- Causes an instant and long-term rise in blood pressure.
- Causes an instant and long-term increase in heart rate.
- Reduces blood flow from the heart.
- Reduces the amount of oxygen that reaches the body's tissues.

- Increases risk for blood clots.
- Damages blood vessels.
- Doubles the risk of stroke (reduced blood flow to the brain).

4) Lipids such as fats can:

- Increase the risk of heart disease.
- Increase the risk of cancer.
- Cause obesity
- Can cause hypertension

## Lesson 9: Lymphatic system.

### a) Prerequisites/Revision/Introduction:

The teacher will introduce the lesson by asking the following questions: Blood is a body fluid that circulate in the circulatory system. It Apart from blood is there any other fluid that can be found in the body? If yes specify the name of that fluid and where it does circulate.

**Expected answers:** Yes, it is called lymph which circulate in lymphatic system.

**b) Teaching resources:** Textbooks, chart

**c) Learning activities:** The teacher will help students to form groups, provide to them books and chart.

### Methodological steps

- The teacher will guide students in the activity 4.9 in the following ways
- In their respective groups students attempt the activity 4.9 using textbooks.
- Teacher move in different guiding them to discuss about the activity.
- Allow the students to present their findings.
- During presentation teacher intervene harmonizing to what students present.
- The teacher will summarize the lesson and giving lesson assessment 4.9.

### Expected answers for activity 6.9

1) The definitions are:

a) A lymph is a tissue fluid which circulates inside the lymphatic vessel.

b) Lymph nodes is a lymphoid organ that filters lymph and fight infection.

c) The lymphatic vessels (or lymph vessels or lymphatics) are thin-walled vessels

that carry lymph.

2) The function of lymphatic system:

- Drainage of fluid from blood stream into the tissues: The circulating blood through narrow vessels leads to leakage of fluid or plasma into the tissues carrying oxygen and nutrients to the tissues and carrying waste materials from the tissues into the lymph channels. The leaked fluid drains into the lymph vessels. This forms a circulatory system of fluids within the body.
- Filtration of the lymph at the lymph nodes: The nodes contain white blood cells that can attack any bacteria or viruses they find in the lymph as it flows through the lymph nodes. The cancer cells may also get trapped similarly at the lymph nodes and thus lymph nodes act as indicators of how far the cancer has already spread.
- Filtering blood: This is done by the spleen. The spleen filters out bacteria, viruses and other foreign particles.
- Raise an immune reaction and fight infections The lymphatic system especially the lymph nodes are over active in case of an infection the lymph nodes or glands often swell up in case of a local infection.

3) Answers are:

**a) Formation of tissue (interstitial) fluid:** The tissue fluid formation occurs in this way: a fluid and proteins leak from the blood capillaries into the interstitial fluid that bathes the cells of tissues. This occurs because, at the arterial end of capillary, the blood pressure is greater than osmotic pressure and a fluid flows out of capillary into the interstitial fluid. This process is called **pressure filtration**.

**b) Formation of lymph:** The lymph formation occurs in this way: the lymphatic vessels recover some leaked fluid and proteins, carrying them to large veins at the base of the neck.

4) Answers are:

**a) Similarities between lymphatic and circulatory systems:** Both the cardiovascular and lymphatic systems are vascular networks carrying body fluids, both systems have vessels.

**b) Differences between lymphatic and circulatory system are given in the following table:**

Criteria	circulatory system	Lymphatic system
Main function	Blood collection and distribution of O <sub>2</sub> , nutrients and hormones to tissues of the body.	Lymph collection and removal of waste products left behind by tissues of the body.

Fluid flow	Blood flows in a continuous loop throughout the body by arteries ,capillaries and veins	Flow lymph flows in an open circuit from tissues to lymphatic vessels. It is unidirectional, has valves to stop from flowing backwards.
Type of fluid	Blood	Lymph
Type of blood vessels involved	Blood vessels	Lymphatic vessels

## Answers of self-assessment 6.9

1)The answers are given in the following table:

Organ	Name / identity (Answer a)	Function (Answer b)
W	Thymus gland	Secretes thyroxin, a hormone that contributes to the maturation of T- lymphocytes from bone marrow. Generates T- lymphocytes
X	Lymph nodes	Filters lymph Fight infection
Y	Spleen	Filters blood and removes cellular debris
Z	Bone marrow	Generates blood formed elements such as B-lymphocytes which mature in it.

## 6.6 Summary of the unit

The circulatory systems are needed as they play various roles such as transport of nutrients to all organs of the body. Different circulatory systems exist in animals. They include open circulatory system of organisms like insects and closed circulatory system of animals such as cows. Single circulation occurs in some animals such as fish while double circulation occurs in organisms such as human. In single circulation, the blood passes once via the heart but, during double circulation, the blood passes twice through the heart.

The heart, blood vessels and blood constitute the human circulatory system. The heart is a striated muscle situated between the two lungs and behind the sternum in the thorax and contracts in order to propel blood throughout the body. The heart of both mammals and birds is composed of 4 chambers: 2 upper atria and 2 lower ventricles. Heart beat is a rhythmic sequence of contractions of the heart. It is controlled by the nervous system and hormonal system; the factors such as carbon dioxide, temperature,

sport or physical exercises, drugs and pH also affect the heartbeat.

They are three types of blood vessels are veins, capillaries and arteries. The blood has two main components which are formed elements and plasma. Generally, the blood and the circulatory system have three main functions including transport of substances in the body, regulation such as thermoregulation and protection against infections that ensured by leukocytes.

There are different cardiovascular diseases among them include stroke, atherosclerosis and coronary heart disease. A lymphatic system is system composed of tissues and organs, including the bone marrow, spleen, thymus and lymph nodes that produce and store cells which fight infections and diseases. The channels that carry lymph are also part of this lymphatic system.

## 6.7 Additional Information

**These are factors involved in blood clotting:**

Factor I - fibrinogen

Factor II - prothrombin

Factor III - tissue thromboplastin (tissue factor)

Factor IV - ionized calcium (Ca<sup>++</sup>)

Factor V - labile factor or proaccelerin

Factor VI – activated factor V

Factor VII - stable factor or proconvertin

Factor VIII – anti haemophilic factor

Factor IX - plasma thromboplastin component, Christmas factor

Factor X - Stuart-Prower factor

Factor XI - plasma thromboplastin antecedent

Factor XII - Hageman factor

Factor XIII - fibrin-stabilizing factor

## 6.8 End unit assessment 6

1) d

2) d

3) Complete the following paragraph by filling in the blank spaces: Blood is oxygenated in the lungs. The red pigment haemoglobin has a high affinity for oxygen. The pumping action of the heart creates pressure which pushes the blood around the body. In the tissues the partial pressure of oxygen is low. This causes the dissociation of the oxy-haemoglobin. In the tissues, the oxygen is used in the process of respiration. Most of the carbon dioxide produced in this process enters the cells. Here it is converted to carbonic acid by the action of the enzyme carbonic anhydrase the carbon dioxide is transported as carbonic acid back to the lungs

4) Each haemoglobin molecule can transport 4 molecules of oxygen.

5) Fibrinogen is involved in blood clotting as it is converted into fibrin threads that prevent continuous bleeding.

6) The plasma is the yellowish portion of blood including proteins whereas serum is the plasma from which proteins (especially fibrinogen) have been removed

7) Answers are

(i) Haemoglobin is called conjugated protein because it has a non-protein part (haem) and polypeptide chains (globin).

(ii) High carbon dioxide concentrations shift the oxygen dissociation curve to the right (Bohr effect)

8) The answers are:

a) Ultrafiltration (pressure filtration)

b) Erythrocytes, platelets and proteins.

9) The answers are:

a) A=Aorta, B=Pulmonary semilunar valve, C= Atrio-ventricular valve, D= right ventricle E=Inferior vena cava

b) A transports blood from left ventricle leading to the different part of the body while B-prevent backflow of the blood when the right ventricle is relaxed.

10) Because the delay allows the atria to empty completely, filling ventricles fully before they contract.

11) The following is the drawing:

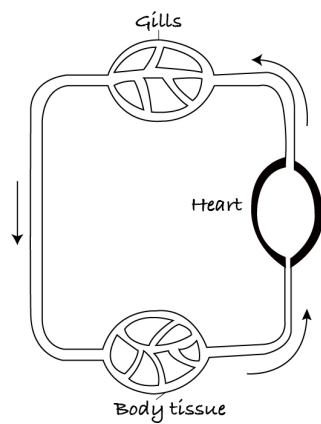

Single circulation

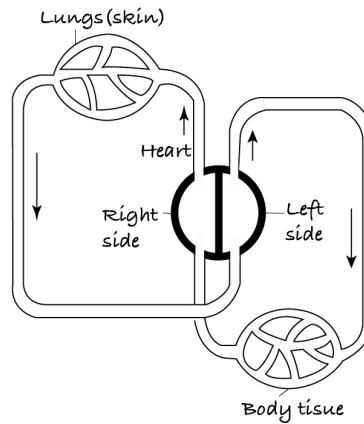

Double circulation

12) The following are the answers:

a) A - Atrio-ventricular valve closes when pressure in ventricle rises above pressure in the atrium.

B- Semi-lunar/aortic valve opens when pressure in the ventricle exceeds pressure in the aorta/artery.

C- Semi-lunar/aortic valve closes when pressure in aorta exceeds pressure in the ventricle.

D- Atrio-ventricular valves open when ventricular pressure falls below that of the atrium.

b) The cardiac circle in one minute =  $\frac{60}{0.8} = 75$  beats per minute

13) The advantages of closed double circulatory systems include:

- Relatively high blood pressures, which enable the effective delivery of O<sub>2</sub> and nutrients to the cells of larger and more active.
- Closed double systems are also particularly well suited to regulating the distribution of blood to different organs.
- Disadvantages of open circulatory system are little fine control over distribution of the haemolymph to body regions and mechanism for reducing flow to a specific part of an organ.

14) The following are the answers:

a) The radial pulse is taken from radial artery found on the arm near the wrist

b) The vagus is responsible for the parasympathetic stimulation on the heart

resulting in a decrease in heart rate. If it was cut, the parasympathetic tone on the heart will decrease and the heart rate will go up.

15) The following are the answers:

a) A- sinoatrial node/pacemaker

b) The answers are:

i. Ventricles contract after atria allowing time for ventricles to fill before contracting. In other words the delay allows the atria to empty completely, filling ventricles fully before they contract.

ii. Blood is squeezed out of the ventricles more efficiently in other words more blood is expelled at each contraction because contraction starts at the base of ventricles.

c) When excitatory part of cardiovascular centre is stimulated the sympathetic nerves, from medulla stimulate pacemaker which result in an increase in heart rate.

16) The answer includes:

a) The human heart is a double pump adapted to forcing blood, at the same rate but at different pressures, along the two systems of double circulation. High pressure in the systemic (body) circulation has evolved with lower pressure in the pulmonary (lung) circulation and low pressure lymphatic circulation. Each heart beat is controlled by a wave of electrical excitation. In turn, the cardiac output of the heart adapts to meet the bodies needs and is influenced by nervous and hormonal control. The human heart is a double pump adapted to forcing blood, at the same rate but at different pressures, along the two systems of double circulation. Explain how the mechanism that controls each heartbeat, and the structure of the heart, enable it to do this.

Pacemaker initiates heartbeat. Wave of excitation spreads across both atria causing simultaneous contraction, it reaches to atrioventricular node where bundle of his and Purkynje fibres spread down to both ventricles at the same time up to the base, from where it radiates upwards. Ventricles contract simultaneously from the base upwards by contracting at the same rate. Nerves act on SA node to alter the rate. Pressure produced by contraction of cardiac muscle where left ventricle has thicker muscle and the blood ejected from left ventricle has higher pressure compared to one of right ventricle.

b) Adrenaline from adrenal gland and noradrenaline increase heart rate. Sympathetic nerve from medulla increase heart rate and it takes nerve



impulses from excitatory centre. Parasympathetic or vagus nerves decrease heart rate, it carries inhibitory impulses from the centre to SA node.

## 6.9 Additional activities

### 6.9.1 Remedial Activities

1) Identify 3 main functions of the circulatory system of human.

**Answer: The 3 main functions of the circulatory system are:**

- Transport of chemicals in the body. E.g. Haemoglobin of red blood cells transports oxygen and carbon dioxide.
- Regulation such as thermoregulation
- Protection against infections achieved by leukocytes.

2) Explain the function of each type of blood vessel

**Answer**

- The arteries carry blood away from the heart at high pressure. They transport oxygenated blood (except pulmonary artery).
- The capillaries supply all cells with their requirements. So, they provide large area for exchange of materials between blood and body cells. They take away waste products.
- Veins return blood to the heart at low pressure. They transport deoxygenated blood (except pulmonary vein).

3) Describe what can happen to the body if:

- a) It has low concentration of fibrinogen.
- b) Low concentration of haemoglobin.

**Answer**

- a) If the body has low concentration of fibrinogen, it would be difficult for blood to clot when a person is injured.
- b) If there is low concentration of haemoglobin, few oxygen molecules will be carried and most cells do not realize aerobic cell respiration; it is also difficult to excrete CO<sub>2</sub> because haemoglobin transports oxygen and few CO<sub>2</sub> at different time.

4) Distinguish between thrombus and embolus.

Answer: Thrombus is a stationary blood clot whereas embolus is a moving blood clot.

5) Complete the following statement

a) The cardiovascular disease associated with the fact that oxygen does not reach brain is..... answer: stroke.

b) .....is the process whereby tissue fluid is formed. Answer: Ultrafiltration (pressure filtration)

c) The lymph passes via vessels called..... answer: lymphatic vessels

6) The concentration of oxygenated haemoglobin of UWINEZA is 13 g/dl. Her concentration of deoxygenated haemoglobin 12 g/dl. Calculate her oxygen saturation.

Answer:

Data:  $(\text{HbO}_2) = 13\text{g/dl}$

$c(\text{Hb}) = 12\text{g/dl}$

$$\text{Oxygen saturation} = \frac{c(\text{HbO}_2)}{c(\text{HbO}_2) + c(\text{Hb})} \times 100 = \frac{13}{13 + 12} \times 100 = 52\%$$

7) Describe briefly one difference between a single circulation and double circulation.

Answer: In single circulation, the blood passes once via the heart during one complete circuit of the body while, in double circulation, the blood passes twice through the heart during one complete circuit of the body.

8) Explain the role of valves in the circulatory system.

Answer: The valves prevent the backflow of blood.

9) Discuss the effect of caffeine on the cardiovascular system of a human.

Answer: Caffeine found in coffee, tea and sodas is a stimulant drug that influences the nervous system to increase heart rate. It mimics the effect of adrenaline, a natural hormone in the body responsible for elevating heart rate.

### 6.8.2 Consolidation activities

1) Explain why blood in the pulmonary veins has a higher O<sub>2</sub> concentration than blood in the venae cava, which are also veins.

Answer: In general, all veins bring blood to the heart. Pulmonary vein carries blood from the lungs which is oxygenated whereas venae cava carries blood from different

part of the body which is deoxygenated

2) After exercising regularly for several months, you find that your resting heart rate has decreased. Given that your body now requires fewer cardiac cycles in a given time, what other change in the function of your heart at rest would you expect to find? Explain

Answer: The heart, like any other muscle, becomes stronger through regular exercise. You would expect a stronger heart to have a greater stroke volume, which would allow for the decrease in heart rate.

3) If you had additional hearts distributed throughout your body, what would be one likely advantage and one likely disadvantage?

Answers: Additional hearts could be used to improve blood return from the legs. However, it might be difficult to coordinate the activity of multiple hearts and to maintain adequate blood flow to hearts far from the gas exchange organs.

4) How does the Bohr shift help deliver O<sub>2</sub> to very active tissues?

Answer: The Bohr shift causes haemoglobin to release more O<sub>2</sub> at a lower pH, such as found in the vicinity of tissues with high rates of cellular respiration and CO<sub>2</sub> release.

5) The table below shows the cell composition of three samples of blood.

	Sample from		
Cells number per mm <sup>3</sup>	Peter	John	Joseph
Red blood cells	6.000.000	5.000.000	2.000.000
White blood cells	500	6.000	5.000
Platelets	200.000	220.000	500

a) Identify a person who is most likely to have lived at high altitude recently. Explain your answer.

Answer: Peter. That is because he has a large number of red blood cells (RBCs)/ erythrocytes to attach a lot of oxygen used in aerobic cell respiration which produces energy, a part of which becomes heat that increases temperature as high altitude is cold.

b) Which person would be the most likely to become ill if exposed to a virus? Justify your answer.

Answer:

a) Peter. That is because he has little /few white blood cells which could fight against virus infections or diseases.

c) Which person's blood is least likely to clot efficiently if injured? Justify your answer.

Answer:

d) Joseph. That is because he has little /few platelets (thrombocytes) that enable blood clotting (coagulation).

6) Mount Everest is nearly 9000 m high. The partial pressure of oxygen in the alveoli at this height is only about 2.5 kPa. Explain what effect this would have on the supply of oxygen to body cells if a person climbed to the top of Mount Everest without a supplementary oxygen supply.

Answer2: Less oxygen would enter the blood by diffusion, and therefore less oxygen would be carried to the body cells. The percentage saturation of haemoglobin will be only about 30% (as shown on the oxygen dissociation curve in student's book

7) Explain how an increase in the number of red blood cells can help to compensate for the lack of oxygen in the air at high altitude.

Answer3: At high altitude, the percentage saturation of the haemoglobin is relatively low. If the number of red blood cells is increased, then the number of haemoglobin molecules is also increased. Even though the percentage saturation of the haemoglobin is low, the fact that there is more of it can increase the actual quantity of oxygen carried in the blood.

### 6.8.3. Extended activities:

1) Why does pumping blood to the whole body require more force than pumping blood to the lungs?

Answer: The vessels of the whole body (systemic circulation) provide a much higher resistance to flow than the vessels in the lungs (pulmonary circulation). Therefore, the left ventricle requires more force to overcome this resistance.

2) Answer the following questions:

a) What happen to the ventricular walls of someone who has hypertrophic cardiomyopathy?

b) How would the ability of the heart to efficiently pump blood be affected?

Answer:

a) In this case ventricular walls of someone who has hypertrophic cardiomyopathy are thicker than normal leaving little room in the chamber for blood to accumulate.

b) Because of little rooms that accumulate blood cause the heart to pump less blood.

3) Think of an analogy for capillaries. Remember they are small blood vessels with very thin walls and facilitates their ability to perform exchanges with body cells. What are the similarities between capillaries and the object you have chosen to compare them to?

Answer: For example, capillaries can be considered as small side streets. Side Street do not carry a lot of traffic, which is similar to the small volume of blood that travels through the capillary.

4) Explain how the functions of cardiovascular system contribute to homeostasis.

Answer: Cardiovascular system contribute in regulation of internal environment by delivering oxygen from the lungs, nutrient from digestive system and removes metabolic wastes.

5) Why do pregnant women (especially those who are in their third trimester of pregnancy) experience and complain about their swollen and ankles.

Answer: In this case, these pregnant women that experience this condition have a greater volume of blood and more blood results in more interstitial or tissue fluid

6) Athletes who abuse erythropoietin have many more red blood cell than usual.

a) Explain why an athlete might die from having too many blood cells.

b) Why is death more likely at night when an athlete is sleeping than during the day when they are active? Base your explanation on the heart beat rate.

Answer:

a) Too much red blood cells may clog capillaries and decrease the rate of gas exchange.

b) At night the heart beat decreases and the red blood cells move more slowly through capillaries and gas exchange rate is even lower.

7) Clots in arteries can cause heart attacks and strokes. Why, then, does it make sense to treat haemophiliacs by introducing clotting factors into their blood?

Answer: Clotting factors do not initiate clotting but are essential in the clotting process. Also, the clots that form a thrombus typically result from an inflammatory response to

an atherosclerotic plaque, not from clotting at a wound site.

8) A doctor might use bicarbonate ( $\text{HCO}_3^-$ ) to treat a patient who is breathing very rapidly. What assumption is the doctor making about the blood chemistry of the patient?

Answer: The doctor is assuming that the rapid breathing is the body's response to low blood pH. Metabolic acidosis, the lowering of blood pH, can have many causes, including complications of certain types of diabetes, shock (extremely low blood pressure) and poisoning.

## 7.1 Key Unit Competence

Explain the structure of muscles in relation to movement.

## 7.2 Prerequisite (knowledge, skills, attitudes and values)

The learners learnt about skeleton, muscles and movements in senior one in unit ten named skeleton system of organisms. It has also learnt in senior six in the unit fourteen support and locomotion

## 7.3 Cross-cutting issues to be addressed

Issues to be mostly addressed in this unit are inclusive and gender education.

### Inclusive education

This unit involves a collection of specimens (animals) and the number of experiments on dissecting frog heart for observing myogenic contraction. The experiments require assembling specimens, apparatus and observation of the results. This may be challenging to students with special educational needs especially children with visual impairment. However, the teacher can make some arrangements like:

- Grouping students with special educational needs are group with others and assigned roles basing on individual student's abilities.
- Providing procedure earlier before the experiment so that students get familiar with them. They can be written on the chalkboard or printed depending on availability of resources. If you have children with low vision remember to print in appropriate fonts.
- Every important point is written and spoken. The written points help students with hearing impairment and speaking aloud helps students with visual impairment
- Remember to repeat the main points of the lessons.

### Gender education

This unit contains some practical activities such as dissecting frog/toad heart and observe myogenic contraction.

- As a teacher, involves girls asking them to work like the boys.

- Inspire active participation of boys and girls in activities, not only boys. Make sure that all learners both boys and girls participate actively in practices, arranging and hygiene after experiments.

## 7.4 Guidance to the introductory activity

Knowing that a body of a living organism is made up by muscles and skeletons among others. Ask students whether they have ever take their time to think about why muscles in a living body is different. What about skeletons? Since then, can you now think about the aforementioned questions? Give room to students so that they may share their thoughts. Use their shared ideas and introduce the lesson.

## 7.5 List of lessons/sub-heading

	Lesson title	Learning objectives	Number of periods
1	Types of animal skeletons: hydrostatic, exoskeleton and endoskeleton.	Describe the three main types of animal skeletons. Discuss the functions of skeletons. State and discuss the advantages and disadvantages of exoskeletons.	3 periods
2	Types of joints	Describe the features of a synovial joint. Appreciate the role of joints and muscles in bringing about movement.	2 periods
3	Types of muscles (cardiac, smooth and skeletal muscle).	Describe the main types of mammalian muscles. Compare the structure of cardiac, smooth and skeletal muscle. Distinguish between slow twitch and fast twitch fibers. Demonstrate the structure and function of the sarcomere. Distinguish between temporal summation and muscle fibre recruitment. Explain the role of antagonistic muscles in a joint. Demonstrate the laws of muscle contraction. Adopt the practice of playing sport to develop healthy muscles and bones. Appreciate the role of joints and muscles in bringing about movement.	5 periods



4	Ultrastructure and functioning of striated muscle	Describe the ultrastructure of striated muscles with particular reference to the sarcomere structure.  Interpret the ultrastructure of striated muscle with particular reference to the sarcomere structure	2 periods
5	The sliding filament theory of muscle contraction.	Explain the sliding filament model of muscle contraction, including the roles of troponin, tropomyosin, calcium ions and ATP.  Explain the function of a motor unit/ neuromuscular junction/motor end plate.  Illustrate the sliding filament model of muscular contraction.	2 periods
6	Assessment standard	Explain how the structure of muscles is related to movement by applying knowledge and experience to support and develop ideas and arguments.	2 periods

### **Lesson 1: Types of animal skeletons hydrostatic, exoskeleton and endoskeleton.**

#### **a) Prerequisites/Revision/Introduction:**

Ask learners to provide the ideas on comparison of hydrostatic skeleton and exoskeleton of earthworms and insects.

#### **b) Teaching resources**

Illustrations, earthworms and insects.

#### **c) Learning activity 7.1**

- Facilitate learners to do activity 7.1 by doing the following:
- Ask learners to observe quietly and compare a hydrostatic skeleton and exoskeleton of earthworms and insects.
- Supervise the work how it is conducted and give the learners' opportunity to work in their respective groups.
- Use students' products and further questions if need for summarizing and concluding the lesson.
- Write the summary and ask them to write it progressively on the chalkboard and in students' notebook progressively.

- Help learners with visual impairment to touch on the earthworms and insects for more understand and participate in activity.
- Finally, assess the lesson through questions and then invite students to attempt self- assessment 7.1.

### **Answer for activity 7.1**

The hydrostatic skeleton is well-suited to invertebrate organisms such as earthworms and some aquatic organisms; it is not an efficient skeleton for terrestrial animals while an exoskeleton is an external, hard, encasement on the surface of an organism. For example, the shells of crabs and insects are exoskeletons. This skeleton type provides defence against predators and supports the body.

### **Answers for self-assessment 7.1**

Expected answers are under the unit 11 (lesson one) in student book.

## **Lesson 2:Types of joints**

### **a)Prerequisites/Revision/Introduction:**

Start by asking learners to describe how bones are connected to one another. Consider their answers and move to activity 11.2

### **b)Teaching resources**

The diagrams, photos and illustrations

### **c)Learning activity 7.2**

Facilitate learners to do activity 7.2 by doing the following:

- Give diagram of different types of joints or direct them where they can find them.
- Ask learners to observe the diagrams/ pictures and discuss on what?
- Supervise the work on how it is conducted and give the learners' opportunity to work on their own.
- Ask one or two groups to present the work to the rest of the classmates
- Use students' products and further questions if need for summarizing and concluding the lesson.
- Finally, assess the lesson through questions and then invite students to attempt self- assessment 7.2.

## Answer for activity 7.2

Expected answers are under the unit 11 (lesson two) in student book.

## Answers for self-assessment 7.2

- **A joint** is the junction between two or more bones
- **Fused Joints:** These joints include the skull, sacrum, pelvis, and coccyx. As the name suggests, these joints are points where joints fuse or grow together. The place where they grow together is called the suture. These joints provide strength, support, and protection While **Slightly Moveable Joints** is joint that located between the vertebrae of the upper spine. There is cartilage within the joints. They help pad and protect the bones. The bones are held together by ligaments. The ligaments are tightly bound and limit the movement of the bones. This protects the spinal cord.

Category	Type and description	Examples
Synovial Joints	Ball and socket: movement in all planes	the shoulder and hip joints.
	Hinge: movement in one plane	Bending the elbow or knee.
	Pivot: rotation	Atlas and axis; radius and ulna
	Gliding: side to side movement	Between carpal of the wrist and tarsals of the ankle.

## Lesson 3: Types of muscles (cardiac, smooth and skeletal muscle).

### a) Prerequisites/Revision/Introduction:

Introduce the practical activity through interactive learning in which you can ask some questions like: Have you ever dissect an animal? Which one did you dissect? How can we dissect a frog for observing its myogenic?

### b) Teaching resources for activity 7.3.1

The dissection pan with 4 needles, 20 ml of physiological liquid (Ringer's solution), plastic eye-droppers, suture needle with thread attached, razor blade, magnifying hand lens, pins, chloroform, cotton wool, frog or toad, bell jar, forceps, glass beaker and water.

### **c) Learning activity 7.3.1**

Facilitate students to do the dissection of a frog/toad heart and observe myogenic contraction in the following way:

- Give the learners materials to be used in activity and make sure that both boys and girls participate and share equally the tasks during activity.
- Ask learners to brainstorm on the procedures they are going to follow in dissecting frog heart and observe myogenic contraction,
- Help learners with visual impairment to touch on the heart of the frog for experiencing it and participate in activity.
- Supervise the work how it is conducted and give the learners' opportunity to work in their respective groups.
- Ask learners to report what they have done
- Help learners to summarize what they have done and conclude the lesson through questions.

### **Hints in the observations**

- The animal faints and does not reactive actively during the dissection due to the effect of chloroform (anesthesia)
- The blood flows as blood capillaries are cut
- The heart keeps on beating even when it has been removed from the body.

### **d) Teaching resources for activity 7.3.2**

The diagrams, photos and illustrations.

### **Learning activity 7.3.2**

- Facilitate learners to do activity 7.3.2 by doing the following:
- Ask learners to brainstorm on the structures of cardiac, smooth and skeletal muscles.
- Help learners make discussion in group.
- Supervise the work how it is conducted and give the learners' opportunity to work in their respective groups.
- Ask learners to present what they have done to the rest of the classmates.
- Ask learners to summarize what they have learnt in group discussions.

### **Answer for activity 7.3.2**

#### **Skeletal Muscles:**

- Are directly attached to the skeleton by tendons?

- Aid in movement and locomotion.
- Are voluntarily activated.
- Appear striped under a microscope.
- Also called “striated” muscle.
- Fatigue more quickly than smooth or cardiac muscles.
- Are able to stretch and resume original shape.
- Striated appearance comes from formation of actin and myosin muscle fibres.
- Are capable of powerful contractions and, just as adequately, small contractions for delicate movement requiring precision.
- Stimulated by the nervous system’s motor neurons.
- Well-supplied with nerves and blood vessels.

### **Smooth Muscles:**

- Get their name from their smooth appearance under a microscope.
- Arranged in bundles of muscle fibre sheets.
- Contract involuntarily. Regulated by autonomic part of nervous system.
- Found in walls of hollow structures, including veins, arteries, and intestines.
- Maintain flow of fluid and food along hollow structures.
- Found in hair erectors, pupils, gland ducts, esophagus, bronchi, intestines, stomach, and blood vessels.
- Contract slowly and rhythmically
- Fatigue slowly

### **Cardiac Muscles:**

- Found only in heart and at cardiac ends of main blood vessels.
- Contract involuntarily.
- Striated when viewed under a microscope
- Do not fatigue.
- Contract rhythmically.
- Controlled by central nervous system.
- Contain high count of mitochondria and myoglobin.
- Have good blood supply.

### **Teaching resources 7.3. 3**

The charts, Illustrations and computer aided study materials.

### **Learning activity 7.3. 3**

Facilitate learners to do activity 7.3.3 by doing the following:

- Ask learners to brainstorm on the characteristics of the three types of muscles: cardiac, smooth and skeletal muscles.
- Supervise the work how it is conducted and give the learners' opportunity to work in their respective groups.
- Ask learners to present what they have done to the rest of the classmates.
- Ask learners to summarize what they have learnt by asking the learners the questions.

### **Answer for activity 7.3.3**

Characteristics of the three types of muscles.

- The skeletal muscle cells are long, cylindrical, and striated. They are multi-nucleated meaning that they have more than one nucleus.
- The smooth muscle cells are non striated, uni-nucleated, and involuntary or reflexive.
- The cardiac muscle cells are striped muscles fibres, form thick middle layer and share both characteristic of skeleton and smooth muscles.

### **Teaching resources 7.3. 4.**

The diagrams, charts, Illustrations and computer aided study materials.

### **Learning activity 7.3. 4.**

- Facilitate learners to do activity 7.3.4 by doing the following:
- Ask learners to brainstorm on the structure and functioning of the sarcomere during muscle contraction with reference to sliding filament theory.
- Supervise the work how it is conducted and give the learners' opportunity to work in their respective groups.
- Ask learners to present what they have done.
- Through asking questions, help learners to summarize what they have learnt.

### **Answer for activity 7.3.4**

A sarcomere is the basic unit of striated muscle tissue, during muscle contraction, sarcomeres shorten, and the distance between Z-lines decreases and the width of the

H and I-bands also decrease. Thick filaments are composed of the protein myosin. Thin filaments are composed of the protein actin, during contraction the amount of overlap between actin and myosin increases. Contraction is produced by an interaction between actin and myosin through the formation of cross bridges, the actin is pulled into the space between the myosin filaments. Cross-bridges extend from thick to thin filaments.

### **c) Teaching resources**

The diagrams, charts, illustrations and computer aided study materials.

### **Learning activity 7.3.5**

- Facilitate learners to do activity 7.3.5 by doing the following:
- Ask learners to brainstorm on how they can demonstrate the laws of muscle contraction.
- Supervise the work how it is conducted and give the learners' opportunity to work in their respective groups.
- Ask learners to present what they have done to the rest of the classmates.
- Help learners to summarize what they have learnt in group discussions.

### **Answer for activity 7.3.5**

- The temporal Summation (Wave Summation): Occurs when a second stimulus of the same intensity is applied to a muscle before the completion of the relaxation period of the first stimulus. In presence of adequate stimulus, the fibre contracts maximally. No further increase in strength of stimulus will produce a stronger contraction this is called 'all-or nothing' response. A latent period of 0.05 seconds elapses prior to muscle contraction. This results in increased muscle tension. As a motor act proceeds from little to maximum strength, motor units with precise characteristics are progressively recruited in a logical order. First are the smallest tonic motor units, followed by larger tonic units, and finally by the largest tonic units.
- Now if the motor act requires fine control only and not a great deal of tension. The recruitment of motor units might stop here. However, if strength is also required, the higher-threshold phasic units are recruited next. Depending on how much strength is required for the particular motor act, appropriate numbers and types of additional phasic motor units will be recruited.

**Activity 7.3.5. in student book on biceps and triceps muscles.**

### **Teaching resources**

The diagrams, charts and illustrations.

### Learning activity 7.3.6

- Facilitate learners to do activity 7.3.6 by doing the following:
- Ask learners to brainstorm through observation of bicep muscles and note down observations (shortening and thickening of the antagonistic muscles).
- Supervise the work how it is conducted and give the learners' opportunity to work in their respective groups.
- Help learners to make discussion in group.
- Ask learners to summarize the content.
- Ask some groups to present the work to the rest of the classmates while others provide supplements.

### Answer for activity 7.3.6

The biceps act as the agonists to lift the forearm while the triceps relax as the antagonists to support the biceps' contractions, or vice versa. The biceps are referred to as the agonist muscle, the triceps, acting in opposition, is called the antagonist and because the two muscles are located on opposite sides of the arm, the triceps must relax enough to allow the biceps to tense and contract during a curl. As it contracts, it shortens. As the triceps relaxes, it lengthens. During a triceps extension, the triceps is the agonist and the biceps is the antagonist.

### Answers of self-assessment 7.3

**Skeletal Muscle:** Skeletal muscle, as its name implies, is the muscle attached to the skeleton. It is also called striated muscle. The contraction of skeletal muscle is under voluntary control. These muscles are mainly responsible for movement of the body. Other purposes are posture maintenance, support of the joints, and heat production. While its contraction is fast and strong, skeletal muscle tires easily.

**Smooth Muscle:** Smooth muscle is found in the walls of all the hollow organs of the body. Its contraction reduces the size of these structures. Thus it regulates the flow of blood in the arteries, moves your breakfast along through your gastrointestinal tract, expels urine from your urinary bladder, sends babies out into the world from the uterus, and regulates the flow of air through the lungs. The contraction of smooth muscle is not under voluntary control. It is called involuntary muscle. It contracts slowly and is slow to tire.

**Cardiac Muscle:** Your heart is made of cardiac muscle. This type of muscle only exists in your heart. Unlike other types of muscle, cardiac muscle never gets tired. It works automatically and constantly without ever pausing to rest. Cardiac muscle contracts to squeeze blood out of your heart, and relaxes to fill your heart with blood.

**Answer is in 7.3.2 in student book.**

**Slow-Twitch muscles,** they are slower-contracting fibers (weaker) but they are very



efficient at using oxygen to create energy without lactic acid build-up. Think of these as “weaker” muscles with tons of endurance, and can go on forever. These fibres are used for high-endurance events like marathons. While **Fast-Twitch fibres**, which are white fibres, that contract very quickly (making them very strong and explosive) but they also tire out very easily.

Muscle contraction and relaxation.

- The sarcomere is made up of: thick filaments, thin filaments, Proteins that stabilize the position of the myofilaments and Proteins that regulate interactions between the myofilaments.
- The primary role of the antagonist is to counter the motion of the prime mover.
- The triceps brachii extends the forearm and is an antagonist of the biceps brachii.
- Smooth muscle cells can contract over a relatively large range of resting lengths because their actin and myosin filaments are not as rigidly organized as in skeletal muscle.
- The bats move in act of flying as aerial locomotion.
- The arboreal locomotion refers to species that live in and move through trees mode used by cats
- The aquatic locomotion is the movement on water done by fish.

## **Lesson 4: Ultrastructure and functioning of striated muscle**

### **a)Prerequisites/Revision/Introduction:**

Starting from the previous lesson of the types of muscles including structures and characteristics of the three types of muscle and make revision on it through asking questions to the learners to encourage the learners in the lessons.

### **b)Teaching resources**

The diagrams, charts, Illustrations and computer aided study materials.

### **c)Learning activity 7.4.**

- Facilitate learners to do activity 7.4 by doing the following:
- Ask learners to brainstorm the ultrastructure and functioning of striated muscle.
- Supervise the work how it is conducted and give the learners’ opportunity to work in their respective groups.
- Ask learners to make discussion in group.
- Ask learners to write the summary of the group discussions,

- Use students' products and further questions if need for summarizing and concluding the lesson.
- Through questions, guide learners to come up with a summary, write it progressively on the chalkboard or flipchart and ask learners to note it in their notebooks.
- Finally, assess the lesson through questions and then invite students to attempt self- assessment 7.4.

### Answer for activity 7.4.

### The ultrastructure and functioning of striated muscle.

Skeletal muscle is called “striated” because of its appearance consisting of light and dark bands visible using a light microscope. A single skeletal muscle cell is long and approximately cylindrical in shape, with many nuclei located at the edges (periphery) of the cell.

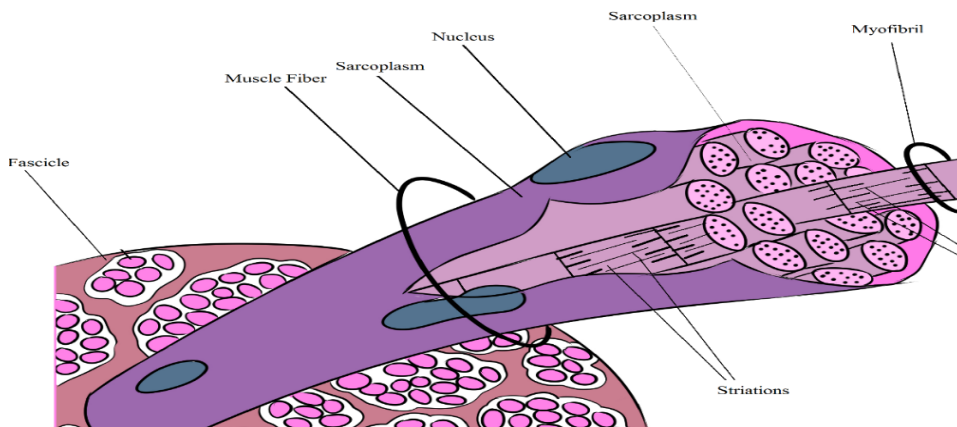

Figure 7.1. A diagram of a Muscle Cell.

### Function:

- Movement of the skeleton under conscious control, including movement of limbs, fingers, toes, neck, etc.
- Movement of tissues of facial expression under conscious control, e.g. ability to smile and to frown.

### Answers for self-assessment 7.4

- 1) Ultrastructure of muscle is characterized by a complex arrangement of many protein-protein interactions. The sarcomere is the basic repeating unit of muscle, formed by two transverse filament systems: the thick and thin filaments.
- 2) There are two contractile proteins namely: actin (thin filament) and myosin (thick filament).

- 3) Movement of the skeleton under conscious control, including movement of limbs, fingers, toes, neck, etc. and the movement of tissues of facial expression under conscious control, e.g. ability to smile and to frown.

## **Lesson 5: Sliding filament theory of muscle contraction.**

### **a) Prerequisites/Revision/Introduction:**

Reminding the learners muscle contraction, they have learnt in the previous lessons and motivate them to make research on the sliding filament theory of muscle contraction. The learners may take attentions because after activity, they will present the work done.

### **b) Teaching resources**

Illustrations and computer aided study materials, books, internet connection and drawings.

### **c) Learning activity 7.5**

Facilitate learners to do activity 7.5 by doing the following:

- Ask learners to brainstorm on the sliding filament theory of muscle contraction and make sure that both boys and girls participate and share equally the tasks before, during and after activity.
- Ask learners to make discussion in group.
- Supervise the work how it is conducted and give the learners' opportunity to work in their respective groups and by respecting gender and learners with special need if they are any.
- Use students' products and further questions if need for summarizing and concluding the lesson.
- Through questions, guide learners to come up with a summary, write it progressively on the chalkboard or flipchart and ask learners to note it in their notebooks.
- Finally, assess the lesson through questions and then invite students to attempt self- assessment 7.5. Students can do this exercise either in the course of this lesson if there is still time or as home work. Make sure you mark the students' homework. Let each student do individually this self- assessment.

### **Answer for activity 7.5**

The sliding filament theory is the basic summary of the process of skeletal muscle contraction. This progresses in sequential stages. By progressing through this sequence the filaments slide and the skeletal muscles contract and release. It undergoes eight stages, the first stage is when the impulse gets to the unit, and the impulse travels along the axon and enters the muscle through the neuromuscular junction. The second stage is for the impulse spreads along the sarcolemma and during the third stage calcium is released from the sarcoplasmic reticulum and actin sites are activated, during the fifth

stage the myosin head pulls the Actin filament and ADP and inorganic Phosphate are released. ATP binding allows the myosin to detach and ATP hydrolysis occurs during this time. **Stage Six:** Cross bridges detach while new ATP molecules are attaching to the myosin head while the myosin head is in the low-energy configuration and during stage seven the ATP is broken down and used as energy for the other areas including new cross bridge formation. Then the final stage (stage 8) begins and a drop in stimulus causes the calcium concentration to decrease and this causes muscle relaxation.

## Answers for self-assessment 7.5

- 1) A neuromuscular junction is the meeting point of a nerve fibre and the muscle fiber it supplies. Neuromuscular junctions are the locations and means by which the motor neurons of the nervous system instruct the muscle cells to take action. These instructions result in the movement of muscles and the tissues, bones and limbs attached to them.
- 2) The function of motor neurons is to release the neurotransmitter acetylcholine, which are released at a junction known as the neuromuscular junction, that bind to postsynaptic receptors, causing the muscle fibre to respond and result into a muscle movement. For example, the alpha motor neurons, also known as the lower motor neurons, usually innervate skeletal muscle, causing contractions of the muscles that result in movement.
- 3) Simplified structure of a sarcomere.

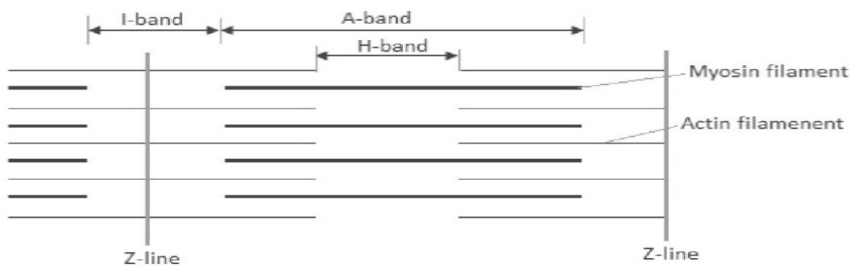

Fig 7.2. Sarcomere

## 7.6 Summary of the unit

There are three types of skeleton which are hydrostatic skeleton, endoskeleton and exoskeleton and hydrostatic skeleton is found in cold-blooded animals including invertebrates like echinoderms, cnidarians, annelids, nematodes. Human beings have endoskeleton. Exoskeleton is found in insects and all arthropods.

Hydrostatic skeleton is inside the body, made of fluid and Muscles around the fluid can press against it, exoskeleton is outside the body, made of non-living material, muscles are attached to the inside of the skeleton and does not grow, so it needs to be shed to enable the animal to grow while endoskeleton is inside the body, made of living material, muscles are attached to the inside of the skeleton and grows inside the animal.

Important of skeleton include: giving shape and form to the body, Structural Support of the Body, Protection of Internal Organs, Attachment of the Muscles, Movement of the Body, Production of Blood Cells, Storage of Minerals.

A joint is the junction between two or more bones and it is categorized into three types: immovable, slightly movable and freely movable. There are 3 types of muscle: skeletal, smooth, and cardiac muscle, muscle is a band or bundle of fibrous tissue in a human or animal body that has the ability to contract, producing movement in or maintaining the position of parts of the body.

Role of the muscles: muscles in the body provide the necessary force to move the bones or the whole body, muscles convert chemical energy into kinetic or mechanical energy, the functions of muscle tissue are: movement, stability, control of body openings and passages and heat production and the characteristics of muscles: responsiveness, conductivity, contractility and elasticity.

Muscle contraction is the activation of tension-generating sites within muscle fibers and twitch summation or treppe is the addition of a second twitch, resulting in greater tension, and it results from stimulating the muscle before it has a chance to relax completely.

Tetanus is prolonged contraction without relaxation and results from repeating stimulation before the muscle has a chance to relax at all and functional unit of contraction in a skeletal muscle fibre is the sarcomere, which runs from Z line to Z line.

A neuromuscular junction is a chemical synapse formed by the contact between a motor neuron and a muscle fibre and antagonistic muscles are pairs of muscles. The action of one member is opposite to that of the other member

Locomotion refers to the movement that causes a progression from one place to another and the following are different mode of locomotion as identified due to the types of phylum animals belong like: aerial locomotion, arboreal locomotion, aquatic locomotion, cursorial locomotion, fossorial locomotion and jumping.

Muscle ultra-structure is characterized by a complex arrangement of many protein-protein interactions and the sarcomere is the basic repeating unit of muscle, formed by two transverse filament systems: the thick and thin filaments, striated muscle is part of the locomotors system and has the task of moving and stabilizing the skeleton, a neuromuscular junction is a chemical synapse formed by the contact between a motor neuron and a muscle fibre and it is at the neuromuscular junction that a motor neuron is able to transmit a signal to the muscle fibre, causing muscle contraction.

## **7.7 Additional Information**

You are recommended to dissect frog heart to observe myogenic contraction before you go in class for the learners in order to get deeper understanding of the unit.

## 7.8 Answers for end unit assessment

1) Animals move from a place to another:

- To capture food,
- To avoid predators
- To escape dangers
- To find their mates for the reproduction and
- To find new and favourable habitats.

Plants do not migrate because most are hermaphrodite and autotroph.

2) The answers are:

- Bones: provide hard anchorage point upon which muscles can act to bring about movement/act as lever when moving/support skeletal muscles/enable the body to make movement
- Joints: provide a greater degree of flexibility and feasibility of movement/Absorb shocks in their synovial fluid.
- Muscles: convert chemical energy into kinetic or mechanical energy.

3) The answers are:

- The endoskeleton is the internal bony structure found in chordates (fish, amphibians, reptiles, birds and mammals). It is made of bones and cartilages, both of which are hard and tough tissue.
- Functions of endoskeleton:
- It provides mechanical support to the body. The bones are hard and so provide a firm surface for attachment of muscles and ligaments.
- Parts of the endoskeleton enclose and therefore protect delicate organs. For example, the skull protects the brain; the rib cage protects the heart, the lungs and the major blood vessels, the vertebral column protects the spinal cord.
- Together with the skeletal muscles and cartilage, it permits movement of the body limbs.
- The expansion and contraction of the thorax permit gaseous exchange during breathing.
- The vertebral column gives the body flexibility during locomotion.
- Other functions include making blood cells and storing calcium and phosphate.

4) The main types of synovial joints include:

**a) Ball and socket joints**

- They are made of two bones; one with rounded head and the other one

with a depression (cavity) into which the head of the first bone fits and moves freely.

- Movement is possible in all directions and usually allows rotation through 360°.
- They are unable to bear heavy loads
- Such joints are found in the shoulder where the head of the humerus fits into the glenoid cavity of the scapula.

#### **b) Hinge joints**

- They occur where the depression of bone allows the smooth condyles of another bone to fit and articulate to allow movement in one direction only.
- Only up and down movements are possible and hence a maximum stretch of 180°.
- Such joints are found in the elbow, the knee, and in the digits of the fingers and toes.

#### **c) Gliding joints**

- Such joints occur between the cervical, thoracic and lumbar vertebrae. The inter-vertebral discs not only permit the sliding movement of one vertebra over another, but also act as shock absorbers.
- These gliding joints make the vertebral column flexible, allowing the bending or curving of the back. They also permit adjustment of body posture.
- Gliding joints also occur among the metacarpals and metatarsals.

#### **d) Pivot joints**

- They occur where one bone forms a peg that enters in a cavity in the other bone.
- The peg acts as pivot over which rotation occurs e.g. atlas and axis
- It permits rotational movement (side to side movement) of the head. This is facilitated by the odontoid process of the axis which fits into the neural canal of the atlas.

5) The triceps and biceps are antagonistic muscles of our arms.

During the upward movement (lifting)

- Triceps muscles relax and extend
- Biceps muscles contract and shorten
- The radius and ulna move upwards, causing the arm to bend.

During the downward movement (lowering)

- Triceps muscles contract hence shorten
  - Biceps muscles relax and extend
  - Radius and ulna move downwards, causing the arm to straighten.
- 6) Fused Joints have the following functions: provide strength, support and protection.
  - 7) The muscles tissues are mainly responsible for movement of the body, posture maintenance, support of the joints, and heat production.
  - 8) The **MHAZI** is it an abbreviation or acronym? is the M line is inside the H zone which is inside the A band, whilst the Z line is inside the I band.
  - 9) The **refractory period** is the time after receiving a stimulus during which a nerve or muscle cell cannot respond to further stimuli.
  - 10) When it happens sarcomere becomes stimulated and then causes the release of  $\text{Ca}^{2+}$  ions from the triad vesicles into the sarcoplasm. The  $\text{Ca}^{2+}$  ions bind to Troponin C. This then interacts with Troponin I, causing the myosin sites to be unlocked and activated.
  - 11) A well labelled human skeleton as seen in student book
  - 12) A labelled diagram of human skeleton is student's book
  - 13) There are three different types of muscle cells, and each has a different structure related to its function. Cardiac muscles are designed to contract together; skeletal muscle cells have ordered striations so that they can contract farther than other muscle cells to move the body; and, visceral muscle cells are designed to contract slower and remain contracted for long periods of time.

## 7.9 Additional activities

### 7.9.1 Remedial Activities

- 1) The endoskeletons have stronger skeleton. What is its role?

**Answer:** It supports most of the body weight above ground which allows faster locomotion.

- 2) List and give an example for each type of Synovial Joints.

**Answer:**

- Gliding: Examples are between the carpals of the wrist and tarsals of the ankle.
- Pivot: Examples are between the first and second vertebrae when turning the head, between the ulna and the radius of the lower arm when turning the palm of the hand up or down.
- Hinge: Examples are bending the elbow or knee.
- Ball and Socket: Examples are the shoulder and hip joints.



3) Why are muscles twitching?

**Answer:**

Your muscles are made up of fibres that your nerves control. Stimulation or damage to a nerve may cause your muscle fibers to twitch. Most muscle twitches go unnoticed and aren't cause for concern. In some cases, they may indicate a nervous system condition and you should see your doctor.

4) Locate actin and myosin filaments in sarcomere.

**Answer:**

Myosin and actin are found in myofibrils which are located in muscle fibres.

5) What is sliding filament theory?

**Answers:**

The sliding filament theory explains the mechanism of muscle contraction based on muscle proteins that slide past each other to generate movement.

### 7.9.2 Consolidation activities

1) Describe the functions of the bones.

**Answers:** Some functions of bones are the following:

- **Structural Support of the Body:** The skeleton supports the body against the pull of gravity. The large bones of the lower limbs support the trunk when standing.
- **Protection of Internal Organs:** The skeleton provides a rigid frame work that supports and protects the soft organs of the body. The fused bones of the cranium surround the brain to make it less vulnerable to injury. Vertebrae surround and protect the spinal cord and bones of the rib cage help protect the heart and lungs.
- **Attachment of the Muscles:** The skeleton provides attachment surfaces for muscles and tendons which together enable movement of the body.
- **Movement of the Body:** Bones work together with muscles as simple mechanical lever systems to produce body movement.
- **Production of Blood Cells:** The formation of blood cells takes place mostly in the interior (marrow) of certain types of bones.
- **Storage of Minerals:** Bones contain more calcium than any other organ in the form of calcium salts such as calcium phosphate. Calcium is released by the bones when blood levels of calcium drop too low. Phosphorus is also stored in bones.

2) What is hinge joint and give examples?

**Answers: Hinge:** These joints allow movement in one plane during flexion and extension. They act, as the name implies, like the hinge of a door. Examples

are bending the elbow or knee.

- 3) During the time that a muscle is in tetanic contraction, what are the motor neurons to the muscle doing?

**Answers:** During tetanic contraction, motor neurons are firing a continuous train of closely spaced nerve impulses.

- 4) What is the role of calcium in muscle contractions?

**Answers:** The calcium is a crucial part of muscle contraction. The ionic element is released from muscles during contraction and relaxation. The release of calcium helps propagate the muscle contraction and relaxation stages.

- 5) What role does ATP play in muscle contraction?

**Answers:** The breakdown of adenosine triphosphate (ATP) in a chemical reaction with water provides energy for skeletal muscles to contract. Since the amount of ATP stored in muscles is small, metabolic pathways that generate new ATP must be activated for continued muscle contraction.

### 7.9.3 Extended activities

- 1) The hydrostatic skeleton is found in cold-blooded animals including invertebrates. Write in your own word what the cold-blooded animals mean.

**Answers:** It is an animal that does not have an internal mechanism for regulating its body temperature or cold blooded animals cannot maintain their body temperature by themselves. Their body temperature depends on their environment. Some examples of cold blooded animals are snakes, fish, crocodiles, lizards, frogs and turtles. As a general rule, most amphibians, reptiles and fish are cold blooded.

- 2) Draw a well labelled diagram of cut section view of normal knee joint.

**Answer:** The expected answer is in student book

- 3) Why doesn't muscle relax between the arrivals of nerve impulses when it is in tetanic contraction?

**Answers:** A muscle doesn't relax between nerve impulses during tetanic contraction because each nerve impulse arrives before the muscle completes the sequence of chemical and mechanical events of contraction initiated by the previous impulses.

- 4) Describe the thick filament.

**Answers:**

- Description of the thick filament
- Primarily composed of the protein myosin.
- Contains a tail region and globular head-looks like a golf club.
- Connected together by a hinge.

- Mammalian myosin dimerizes through inter twining of their tails.

5) Explain how do your muscle cells produce ATP during rapid exercise?

**Answers:** Muscle cells produce ATP anaerobically during periods of rapid exercise. ATP is the energy needed for cellular activity to occur.



## 8.1 Key Unit Competence

Explain the role of hormones in human reproduction, stages of pregnancy and foetal development

## 8.2 Prerequisites /Introduction/Revision

Students are equipped with knowledge, skills and attitudes that they have developed from the study of cells, specialized tissues, human reproductive system, reproduction, pregnancy and childbirth.

## 8.3 Cross-cutting issues

**Comprehensive sexuality** and gender education are the cross-cutting issues to be addressed within this unit.

Comprehensive sexuality will be addressed through questions that will be asked to students and to the knowledge and skills that will be developed by the unit. The questions should be like: What are the consequences of non-planned pregnancy? Is non-planned an issue in Rwanda? How young people should behave in relation to sexuality?

**Gender** will be addressed when students will understand that the biological differences in humans are the results of hormonal system. Therefore, they will be sensitised that the biological differences should not be considered in job determination for individuals since all people can achieve.

## 8.4 Guidance on introductory activity

Ask students to observe and do analysis of pictures given in student textbook or assume that there is a person A who is a male and a person B who is a female. Those people are at the age of 18. Ask students to reflect on the body characteristics of those people with the emphasis to the differences. Ask them to brainstorm what do they think to be the cause of those body differences? Probe them to know whether the cause or causes have further effects in a human body?

## 8.5 List of lessons

Number of lesson	Lesson titles/ subheadings	Objectives	Number of periods
1	Lesson 1: Menstrual cycle.	<p>Define menstrual cycle</p> <p>Describe main events of menstrual cycle</p> <p>Describe the hormonal changes involved in menstrual cycle.</p> <p>Distinguish oestrous and menstrual cycle</p>	2 periods
2	Lesson 2. Copulation. fertilization and embryo development	<p>Describe how mammals mate</p> <p>Explain how a sperm enters and fertilizes an ovum and how only one sperm fertilizes an ovum.</p> <p>Describe how an embryo develops.</p>	2periods
3	Lesson 3. Role of placenta in the development of embryo	Explain how placenta forms and discuss its functions.	1 period
4	Lesson 4. The physiological changes in females during pregnancy and parental care.	Explain the physiological changes in females during pregnancy and parental care.	1periods
5	Lesson 5. Twins and multiple birth.	<p>Explain the gestation period birth.</p> <p>Explain how twins and multiple birth arise.</p> <p>Describe the main stages of birth</p>	1 period

6	Lesson 6. Infertility or barrenness and in vitro- fertilisation.	Discuss the social and economic consequences of barrenness, producing many children by a couple and suggest methods to cope with these issues.  Describe in-vitro fertilization and the ethical implications.	2 periods
7	Lesson 7:Family planning and contraceptive methods	Discuss advantages and disadvantages of different birth control methods.	2periods
8	Causes and prevention of STIs and HIV.	State the causes and the ways of prevention of STIS and HIV	2periods
9	Assessment standard	Describe the role of hormones in human reproduction, stages of pregnancy and foetal development, selecting and using the most efficient ways to research on the internet.	1 period

## Lesson 1: Menstrual cycle

### a) Prerequisites/Revision/Introduction

Learners will learn better the events of menstrual cycle, if they have understanding on the role of hormones in human reproduction.

### b) Teaching resources

Illustrations in the students' book, or drawn diagram on a manila paper, flipchart etc.

### c) Learning activity 8.1

As a facilitator, you are expected to guide learners through the following steps:

- Ask learners to do the activity 12.1 which has the two sub activity as found in student textbook.

- Move around groups guiding and facilitating them.
- Select some groups (1, 2 or 3) to share their answers to the whole class by requesting the group representative to write them on the chalkboard or flipchart.
- Ask other groups to add any ideas on what other groups have presented if they have them.
- Remember to speak loudly so that those with low hearing ability or visual impairment get what you say.
- Remind students to write the summary as the lesson progresses and attempt questions of self- assessment 12.1.
- Use learners' products and further questions if needed for summarizing and concluding the lesson.
- Extend the lesson by asking learners to relate menstrual cycle to sexual reproduction or conception.

### **Answers for activity 8.1**

8.1.1. Before menstruation to occur, hypothalamus releases gonadotrophin releasing hormone (GnRH) which stimulates anterior pituitary gland to secrete follicle stimulating hormone (FSH) which stimulates the development of a primary follicle. It also stimulates production of oestrogen hormone (steroid hormone) by uterine cells (theca cells). Oestrogen promotes healing, repair and growth of uterine lining. It also inhibits secretion of FSH and Stimulates secretion of luteinizing hormone (LH) by pituitary gland. The surge of LH brings about ovulation, LH also stimulates secretes of progesterone hormone, Progesterone hormone maintains corpus luteum **and** Progesterone hormone also inhibits secretion of FSH and LH.

### **8.1.2. Answer is in student book**

### **Answers for self –assessment 8.1**

1. Menstrual cycle is the monthly discharge of blood a process called menstruation. The first day of menstruation is regarded as the first day of the cycle. Is occurs only in humans while oestrus cycle describes the time (phase) when female animals are both fertile and sexually receptive to male.

The Females of most species of mammals except human come into heat (oestrus) in regular cycles at particular times of year.

It is controlled by the same hormones as the human menstrual cycle such as FSH and oestrogen control the process until ripe ova are released when LH and progesterone take over.



At about 13 to 15, the level of oestrogen increase rapidly this stimulates anterior pituitary gland to secrete luteinizing hormone and the surge of LH brings ovulation.

2. Events that occur during menstrual cycle include:

Follicular phase describes the development of follicles that leads to formation of secondary oocyte in secretion of oestrogen from follicle.

Ovulation phase occurs at middle of the cycle with rejection (release) of ovum (egg) from the ovary.

Luteal phase describes the secretion of progesterone and oestrogen from corpus luteum after ovulation.

## **Lesson 2: Copulation, fertilization and embryo development**

### **a) Prerequisites/Revision/Introduction**

As a facilitator, ask students to define orally the copulation and fertilization in order to test those prerequisites.

### **b) Teaching resources**

Illustrations in the students' book or draw them on a manila paper or flipchart. You can even use other figures from internet.

### **c) Learning activity 8.2**

The learning activity 8.2 is written in students' book However, you can add more questions. Ask learners to do that activity. Guide the activity as follows:

- Ask them to do the activity 8.2.
- Move around groups guiding and facilitating them.
- Select some groups (1, 2 or 3) to share their answers to the whole class by requesting the group representative to write them on the chalkboard or flipchart.
- Ask other groups to add any ideas on what other groups have presented if they have them.
- Speak loudly so that those who have low hearing ability or visual impairment get what you say.
- Through questions, help students to summarize the lesson and conclude the lesson
- The students attempt questions of self- assessment 8.2. Students can do this exercise either in the course of this lesson if there is still time or as home work. Make sure you mark the students' homework and you give feedback to them.

## Answers of activity 8.2

The first stage is the fusion of ovum with sperm cell to give a zygote. This involves capacitation, acrosome reaction, fusion and entry, cortical reaction and nuclear fusion. After fertilisation, the zygote undergoes different stages of cell division which leads to morula, blastula, embryo and foetus.

## Answers for self-assessment 8.2

1. Copulation results ejection spermatozoa into vagina and it swims in the watery mucus of vagina and uterus up into the oviduct where the fertilisation take place in the upper part of the oviduct. From the vagina or uterus spermatozoa propel using energy from mitochondria. If ovulation has already taken place, the egg and sperm meet in the upper part of oviduct and fertilisation take place.

2. During Cortical reaction, cortical granules in the secondary oocyte releases enzymes which thicken the egg membrane so no further sperm can enter and is called fertilization membrane. The sperm discards its tail and the head and middle piece enter the cytoplasm.

3. Main stages of embryo development are cleavage, gastrulation, and organogenesis.

Cleavage is a stage in which the zygote divides without increase in mass into a ball of consisting of many daughter cells.

Gastrulation is characterised by the rearrangement of cells into distinct layers (ectoderms, mesoderm and endoderm) in vertebrates.

Organogenesis is characterised by the development of tissues and organs.

## Lesson 3: Role of placenta in the development of embryo

### a) Prerequisites/Revision/Introduction

Learners will learn better the role of placenta in the development of embryo, if they have prior knowledge and skills about placenta from Senior 3. Ask learners to state roles of placenta.

### b) Teaching resources:

Illustrations in the students' book or draw them on a manila paper of flipchart. You can even use other structures from internet.

### c) Learning activity 8.3

The learning activity 8.3 is written in students' book. However, you can add more questions. Ask learners to do that activity as you do the following:

- Move around groups guiding and facilitating them.
- Select some groups (1 or 2) to share their answers to the whole class by requesting the group representative to write them on the chalkboard or flipchart.
- Ask other groups to add any ideas on what other groups have presented if they have them.
- Speak loudly so that those who have low hearing ability or visual impairment get what you say. Summary should be written students as the lesson is progressing.
- The students attempt questions of self- assessment 8.3. Students can do this exercise either in the course of this lesson if there is still time or as home work.

### Answers to activity 8.3

- The placenta is a disc-shaped organ which is derived from embryonic and maternal tissues at the location of the allantochorion. This temporary organ develops in the first two months of the pregnancy and by the third month, it is fully functional as the principal site of exchange between the foetus and mother.
- The foetal part of the placenta consists of the allantoides and chorion. The chorion forms many large projections called chorionic villi which contain a dense network of foetal capillaries which in turn are connected to two umbilical arteries and umbilical vein in the umbilical cord.
- The umbilical arteries carry blood from the foetus to the placenta, while the umbilical vein carries blood in the opposite direction.

### Answers of Self-assessment 8.3

1. Implantation is a process by which blastocyst burrows into the uterine wall.
2. The Composition of foetal blood from mother to foetus include glucose (which passes by passive diffusion), amino acids (passes active transport), lipids by membrane lipid diffusion, oxygen is released by the maternal haemoglobin. The haemoglobin of the foetus has a higher affinity for the oxygen. The Composition of foetal blood from Foetus to Mother:

Carbon dioxide is taken up by the maternal plasma and transported to the lungs of the mother for excretion

Urea passes into the maternal blood and passes to her kidneys for excretion.

## **Lesson 4: Physiological changes during pregnancy and parental care**

### **a) Prerequisites/Revision/Introduction**

Learners must remember the role of hormones and placenta in human reproduction. As a guide, ask learners to brainstorm them. Ask learners to discuss changes that occurs in female during pregnancy.

### **b) Teaching resources**

Use textbooks and internet, manila paper Take the example of physical changes during pregnancy.

### **c) Learning activity 8.4**

The activity 8.4 in student's book requires that learners relate these changes in daily life of females in society.

- Move around groups for guiding and facilitating them.
- Select some groups (1, 2 or 3) to share their answers to the whole class by requesting the group representative to write them on the chalkboard or flipchart.
- Ask other groups to add any ideas on what other groups have presented if they have them.
- During the discussions, ask learners to relate human sexual reproduction to integrate the cross-cutting issue (comprehensive sexuality education).
- Speak loudly so that those who have low hearing ability or visual impairment get what you say.
- As the lesson progress, help the learners to write the summary in their note books and conclude the lesson.
- The students attempt questions of self- assessment 8.4. Students can do this exercise either in the course of this lesson if there is still time or as home work

### **Answer to activity 8.4**

During pregnancy, some physiological, physical and behavioural changes.

a) Some physiological changes are:

- Respiration rate rises for increased maternal oxygen consumption which is needed for demand of placenta, uterus and foetus.
- More blood vessels grow and pressure of expanding uterus on large veins causes blood to slow in its return to the heart.

- Rise up and out of pelvic cavity this action displaces the stomach and intestine.
- Blood volume increase greatly.
- Placenta produces large amount of progesterone and oestrogen by 10 to 12 week of pregnancy to control uterine activity.
- Increased requirement of calcium due to increase of parathyroid gland.
- Experiences warm (hot flashes) caused by basal metabolic rate and increased hormonal level.
- Stretching of abdomen wall and ligaments that support uterus.
- Kidney work extra hard to excrete waste products of both mother and foetus.
- Some physical changes during pregnancy:
  - Breast may become large and more tender because of increased level of oestrogen hormone progesterone thus breast get even bigger to prepare for breast feeding.
  - Nipples may stick out more.
  - By the end of third trimester, a yellow, watery, pre-milk may leak from nipples.
  - Changes in hair and nail growth and texture due to hormone changes.
  - Leg cramp caused by fatigue from carrying pregnant weight.
  - Feet and ankles may swell because of extra fluid in the body during pregnancy.
- b) Some behavioural changes during pregnancy:
  - Physical discomfort such as urinary frequency can be frustrating.
  - Fear and anxiety lessen especially foetal movement are felt.
  - Self-introspection
  - Nesting behaviour begins. Some woman exhibit mood swings and emotional liability.
- c) In parental care, degree of maturity in mammalian new borns varies from one specie to another. New born in pigs can move around and eat solid food while new born in humans; dogs and rat are quite helpless and require a lot of parental care to survive. All mammals suckle their young ones by milk which contain all the nutrients required by new born for the first few days. Parents also protect new born from predators and from unfavourable weather. Some species make nest just before delivering the new born. Some parents also become aggressive when they have young one. As the young one grow older the parent start gathering food for them. Once the new born get old enough to gather food for themselves can left on their own. In humans' parental care extends for very long time up over 18 years.

## Answers to self -assessment 8.4

1. Some physical changes during pregnancy:

- Breast may become large and more tender because of increased level of oestrogen hormone progesterone thus breast get even bigger to prepare for breast feeding.
- Nipples may stick out more.
- By the end of third trimester, a yellow, watery, pre-milk may leak from nipples.
- Changes in hair and nail growth and texture due to hormone changes.
- Leg cramp caused by fatigue from carrying pregnant weight.
- Feet and ankles may swell because of extra fluid in the body during pregnancy.

2. Parental care protects new born from predator and unfavourable weather. It also helps to provide all nutrients to new born.

3. Answers include:

- Dilation stage is a stage in which water sac filled with amniotic fluid forms and precedes the head, widening soft tissue of birth canal, cervix, vagina for canal of constant diameter. The amnion ruptures and amniotic fluid drains through vagina.
- The expulsion stage is a stage in which cervix is fully dilated while abdominal muscle bear down in supporting rhythmic contraction of uterus shorten the uterine wall and baby is pushed into and through the birth canal. The head and shoulder align themselves first.
- Placenta stage: This stage begins with complete expulsion of baby and ends with expulsion of foetal membrane. The cord is clamped and cut when delivery of baby is complete. This leads carbon dioxide enrichment into baby's blood which activates respiratory centre and baby begins to breath with the first cry at the same time foetal circulation changes to baby's own systemic and pulmonary circulation. After delivery, uterus contract so that placenta separates from uterine wall expelled out as the sign of birth end.

## Lesson 5: Twins and multiple birth

### a) Prerequisites/Revision/Introduction

As a facilitator, ask learners to define birth, multiple birth and twins orally in order to test those prerequisites. Ask learners to brainstorm the terms.

### b) Teaching resources

Use textbooks or internet, manila paper for more information about stages of birth.

### c) Learning activity 8.5

The activity 8.5 in student's book requires learners to relate birth, twins and multiple birth daily life of a female in society.

- Move around groups, guiding and facilitating students in activity.
- Select some groups (1, 2 or 3) to share their answers to the whole class by requesting the group representative to write them on the chalkboard or flipchart.
- Ask other groups to add any ideas on what other groups have presented if they have them.
- During the discussions, ask learners to relate human sexual reproduction to integrate comprehensive sexuality education.
- Speak loudly so that those who have low hearing ability or visual impairment get what you say.
- As the lesson progresses, help learners to write the summary on the note books as a result of questions that are asked.
- The students attempt questions of self- assessment 8.4. Students can do this exercise either in the course of this lesson if there is still time or as home work.

### Answer to activity 8.5

Criteria	Twins	Multiple birth
Definition	Are individuals born to the same mother at the same time?	Arise when several eggs are released at the ovulation and are fertilized
Conditions of occurring	Due to monozygotic or dizygotic	Zygote splits into several zygotes.

## Answer to self-assessment 8.5

- Birth is the act or process of bearing or bringing forth offspring gestation is period from fertilization to birth.
- Fraternal twins or non-identical twins or dizygotic twins:
- These are twins which develop from two separate egg cells fertilized by two different sperms.
- Identical twins. They develop from the same sperm and the same eggs.
- Multiple birth arises when zygote splits into several zygotes.
- The Placenta stages, the expulsion stage and Dilation stage (check in the student book)

## Lesson 6: Infertility or barrenness

### a) Prerequisites /Revision/Introduction

As a facilitator, ask learners to state the causes of infertility orally in order to test those prerequisites and ask learners to brainstorm them.

### b) Teaching resources.

Use textbooks or internet for more information about causes of infertility.

### c) Learning activity 8.6

The Activity 12.6 in student's book requires learners to relate infertility in both human male and female in Rwandan society.

- Pass around groups, guiding and facilitating them.
- Select 1 or 2 groups which will present answers to the whole class.
- Ask other groups to add the missing information if they have it.
- Help students to summarize and conclude the lesson through questions Extend the lesson by challenging learners through the questions about why environment should be sustainably protected and what would happen if not protected.
- By the aforementioned questions, the following are expected to be generated by students:
- Environment is the habitat of all populations of living organisms.
- Environment contains all resources needed by all populations in order to grow.
- If pollution is not prevented, the population sizes of populations should decrease because pollutants kill organisms in different ways
- At the end, learners with self-assessment 8.6 and be answered by each learner.



They attempt questions of self- assessment 12.6. Students can do this exercise either in the course of this lesson if there is still time or as home work.

### Answers to activity 8.6

1. Some social consequences of barrenness.

- Isolation including exclusion from ceremonies and social gathering.
- Rejection being an outcast and physical abuse perpetrated by community members.
- Stigmatization or recognizable marginalization.
- Status loss that is no respect and social fail.
- Ridicule including insults and verbal abuse.

Some economic consequences of barrenness.

- Cost of infertility treatment by either modern biomedical or traditional example healer or herbs
- No economic security including no support of others.
- Unable to find job due to harassment and feeling rejected.
- Having few relations, receiving few gifts and less land.
- Marital instability including fear of husband taking second wife.
- Divorcing childless woman
- Violence perpetrated by partner.
- Some economic consequences of producing many children.
- Children affect families' financial wellbeing across the income spectrum and parents can tell you that children are expensive, child care and endless diaper supply.
- High rate of maternal depression
- Low rate of immunization and parental care.
- Baby taxing both physical and emotional especially off work after birth.
- Income tend to go up when new members of the family arrive. Men see the boost in their earnings after birth of child.
- There is economic wellbeing decline in time around birth.

2. In-vitro fertilisation is the process of fertilisation where an egg is fertilised by sperm outside the body. It involves the fertilisation of egg cell outside the body which are then artificially implanted in the uterus to produce test tube baby. The process involves monitoring and stimulating of woman's ovulatory process removing ovum (egg) from woman's ovaries and letting sperm to fertilise them in liquid laboratory. The fertilised egg (zygote) undergoes embryo cultured for 2 to 6

days and then transferred to the same or another uterus for successful pregnancy. The embryo is implanted in woman's uterus. It is used to treat infertility of individual. The procedures can be done with couple's egg and sperm.

### **Answer to self – assessment 8.6**

1. Is the fertilisation of egg cell outside the body which are then artificially implanted in the uterus to produce test tube baby?

2. Fertilisation medication to stimulate egg production that is multiple eggs are desired because some will not fertilise. Ultrasound is used to examine ovaries and blood test sample are taken to check hormone level. Medication is provided to reduce and remove potential discomfort.

Eggs are retrieved through mirror surgical procedures that use ultrasound imaging to guide a hollow needle through pelvic cavity to remove the eggs.

The male is asked to release a sample of sperm which is prepared for combing with eggs.

Insemination, sperm and egg are mixed together and stored in laboratory dish to encourage fertilisation. If there is low probability of fertilisation, a single sperm is injected directly into egg for fertilisation. The eggs are monitored to confirm that fertilisation and cell division occur as fertilised egg become embryo.

The embryo is then transferred into woman's uterus for 3 to 5 days following egg retrieval and fertilisation. Small tube is inserted into uterus in order to transfer embryo.

## **Lesson 7: Family planning (birth control) and Contraception:**

### **a) Prerequisites/Revision/Introduction**

To understand this lesson, learners must have prior knowledge about birth. Ask probing questions such as what are the birth control methods to test whether they remember this context.

### **b) Teaching resources**

Use textbooks or internet for more information about birth control methods.

### **c) Learning activity 8.7**

The activity 8.7 in learner's book involves learners in the description of contraceptive and birth control methods. As facilitator, upon the completion of group works, facilitates them in the following ways:

- Select the 3 groups which present the answers to the whole class.
- If there are some methods which are not mentioned by presenters, ask other groups to add them.
- Permit learners to ask questions to presenters and intervene if they are not able to respond accurately.
- Use students' product and further questions if needed for summarizing and concluding the lesson.
- Challenge learners using the questions mentioned in the self –assessment 12:7 which lead them to write the summary in their notebooks
- Have a habit of giving a homework at the end of every lesson and mark it. This homework can come from the self –assessment and end unit assessment seen in student's book or from other book.

### **Answer to activity 8.7**

Contraceptive methods include:

- Oral Contraceptive pills: a chemical method of contraception. One version uses a combination of progesterone and oestrogen that inhibits ovulation. Others are single hormones that require very careful management when taken.
- Intrauterine device (IUD) the coil is placed inside the uterus.
- Condom prevents the sperm from reaching the egg.
- Cap (diaphragm) The cap is placed over the cervix to prevent the entry of sperm in semen.
- Tubal ligation. Involves the cutting of fallopian tube so that eggs cannot reach the uterus.
- Vasectomy. In men this involves cutting the vas deferens and prevents sperm entering the semen.
- Abstinence: the individual makes the choice to delay sexual intercourse until the decision to conceive a child is made

### **Answer of self- assessment 8.7**

1. The main birth control methods are: Oral Contraceptive pills, Intrauterine device, Condom, Cap (diaphragm), Tubal ligation, Vasectomy and Abstinence.

Some advantages of birth control.

- Gives great protection against unplanned pregnancy if instructions are followed.
- Condoms protect against pregnancy and STDS.
- Combinations of pills reduce/prevent cysts in breasts and ovaries.

- Advancement in education and employment.
- Improved family wellbeing.
- Improved maternal and infant health.
- Some disadvantages of birth control.
- Necessity of taking medication continually.
- High cost of medication.
- Hormonal contraceptive does not protect against STDS.
- Eggs do not be mature in the ovary for a woman using hormonal contraceptive.
- Woman must remember to take them regularly.
- Woman must begin using hormonal contraceptive in advance before become effective.
- Some woman experience with several headaches, breast tenderness, chest pain, leg cramp and swelling or pain.

## **Lesson 8: Causes and prevention of STIS and HIV**

### **a) Prerequisites/Revision/Introduction**

To understand this lesson, learners should have prior knowledge of infectious diseases from S4. Ask probing questions to test whether they remember sexual transmitted diseases.

### **b) Teaching resources:**

Textbooks or internet

### **c) Learning activity 8.8**

The activity is to be conducted in the following way:

- Guide to learners the location of the activity 8.8.
- Ask learners to join their respective groups and do that activity.
- Select the 3 groups which present the answers to the whole class.
- If there are some methods which are not mentioned by presenters, ask other groups to add them.
- Permit learners to ask questions to presenters and intervene if they are not able to respond accurately.
- Summarize the lesson and let learner to write the summary in their notebooks.
- Assess the lesson objective by using the questions mentioned in the self – assessment 8.8.

- Have a habit of giving a homework at the end of every lesson and mark it. This homework can come from the self –assessment and end unit assessment seen in student’s book or from other book.

### **Answers for activity 8.8**

- None protected sexual intercourse homosexually or heterosexually. It passes from infected semen or vagina fluid to blood of health person through damaged tissue in the vagina, penis or rectum.
- From sick mother to her baby during birth through breast milk during suckling.
- Through transfusion blood by contaminated needles.
- Through sharing contaminated sharp instruments
- Some ways of preventing STDS.
- Use of condoms during sexual intercourse.
- Know your partner better before engaging sexual intercourse.
- Avoid homosexuality this reduces the risk of STDS.
- Limit your sexual partners. The more sexual partner the high the risk of STDS.
- Get medical attention as soon as possible in case of getting infections.

### **Answers to self -assessment 8.8**

1. Acquired immune deficiency syndrome (AIDS). It is a serious disease which suppresses body defence that leading to development of a number of rare infectious diseases. It is caused by virus known as human immunodeficiency virus (HIV) while human immunodeficiency virus (HIV) it is fragile virus which does not survive well outside the body.

2. HIV is difficult to be cured because:

- HIV remains inactive in host cells for years and it cannot be targeted and destroyed.
- HIV is extraordinary variable therefore cells of immune system identify infective agents by shapes of antigen on their protein coats means that HIV cannot be detected easily by changing shape of its antigens.
- HIV destroys helper T cells which help in body defence thus difficult to control it.

### **8.6 Summary of unit.**

Menstrual cycle monthly cycle occurs after 28 days unless interrupted by pregnancy. It is monthly discharge of blood a process called menstruation. This cycle is controlled by four hormones such FSH, LH, oestrogen and progesterone secreted by anterior pituitary gland and ovary respectively. The natural cycle repeats until there is either a

pregnancy or the woman reaches menopause (the end of the reproductive phase of a woman's life). It undergoes three phases such as; follicular phase, ovulatory phase and lacteal phase.

Oestrus cycle. Is derived from Latin: oestrus meaning sexual desire. The female animal is sexually and receptive male.

Fertilization is union of male and female nuclei to form zygote. It takes place in upper part of oviduct (fallopian tube) after fertilization, Zygote travelling down the oviduct (Fallopian tube) by peristaltic contraction and by beatings of the cilia in wall of the oviduct toward the uterus. As it travels, it divides by mitosis several times to form a ball of cells called a morula. The cell divisions, which are called cleavage, increase the number of cells but not their overall size. More cell divisions occur, and soon a fluid-filled cavity forms inside the ball of cells. At this stage, the ball of cells is called a blastocyst. The blastocyst reaches the uterus and becomes embedded in the endometrium at roughly the 5<sup>th</sup> – 10<sup>th</sup> day. Once in the uterus the blastocyst burrows into the uterine wall a process called implantation. When mother's blood gets contacts with fetal blood vessels, Oxygen and nutrients enters foetus and carbon dioxide from the foetus's blood by diffusion, active transport, and selective absorption between the foetal blood and maternal blood

There are some birth control methods such as Intrauterine device, Cap (diaphragm), condom, Tubal ligation, vasectomy and Abstinence it ends with sexual transmitted infections such as: AIDS, Syphilis, Herpes and Gonorrhoea.

## **8.7 Additional information for teachers**

At birth, and usually until sexual intercourse or vigorous physical activity ruptures it, a vascularised membrane called the hymen partially covers the vaginal opening in humans. The vaginal opening and the separate urethral opening are located within a region called the vestibule, bordered by a pair of slender skin folds, the labia minora. A pair of thick, fatty ridges, the labia majora, encloses and protects the labia minora and vestibule. During sexual arousal, the clitoris, vagina and labia minora all engorge with blood and enlarge. The clitoris consists largely of erectile tissue. Richly supplied with nerve endings, it is one of the most sensitive points of sexual stimulation.

G-Spot is a sensitive area of the anterior wall of the vagina believed by some to be highly erogenous and capable of female ejaculation. The G-spot, also called the Gräfenberg spot is characterized as an erogenous area of the vagina that, when stimulated, may lead to strong sexual arousal, powerful orgasms and potential female ejaculation. It is typically reported to be located 5–8 cm (2–3 in) up the front (anterior) vaginal wall between the vaginal opening and the urethra and is a sensitive area of a female.

## 8.8 Answers to the end of unit assessment

1. The definitions are:

**a. Zygote:** is fertilized egg cell (ovum).

**b. Endometrium:** is the inner layer uterus which can shed or develop during menstrual cycle.

**c. Implantation:** is when blastocyst burrows (attaches) the uterus.

2.

a.2

b.4

c.1

d.5

e.3

4. a) FSH: It allows the follicle to develop

b) LH: Increases the size of the follicle rapidly

5. the following are the answers:

a) **Fertilization** is fusion of male and female nuclei to form zygote.

b) (i) A is mitochondria which provide energy for movement of male gamete cell.

(ii). Acrosome catalyzes the jelly of egg cell to allow entry of male gamete cell.

6. The answers:

a) **a** is oestrogen, **b** is FSH, **c** is progesterone and **d** is LH.

b) The day likely for ovulation to take place is between 10 to 15 because the level of LH increases which brings about ovulation.

c) Ovulation is the realisation of an ovum from the ovary into oviduct (fallopian tube)

- d) Any 2 physical features during ovulation are increase of cervical mucus and enlargement of breasts.

7. The answers are:

- a) Zygote.
- b) Because they developed from the same (single) sperm and same ovum during fertilisation.

7. Answers

a) Once sperm and get contact in the fallopian tube acrosome ruptures and release lytic enzyme such which hyaluronidases which digest corona radiata of the egg and soften zona pellucida and vitelline membrane that surrounding the egg.

b) Fertilised egg (zygote) is propelled down the oviduct by peristaltic contraction and by beatings of the cilia in wall of the oviduct toward the uterus. At start of the journey zygote divides to form cleavage. Cleavage involves cell cycle which divide repeatedly as it reaches the uterus (about 4 days after fertilization) to form solid mass of cells called morula which continue divide mitotically to form a hollow ball of cells called the blastocyst. The blastocyst (embryo) reaches the uterus and becomes embedded in the endometrium at roughly the 5<sup>th</sup> – 10<sup>th</sup> day. Once in the uterus the blastocyst burrows into the uterine wall a process called implantation.

8. The Yolk sac in birds where they absorb food from the separate yolk and transfers food to the gut of the developing embryo

9. Answers:

- Proliferative phase describes the thickening of endometrium of the uterus.
- Secretory phase follows ovulation and describes further thickening of endometrium in preparation for implantation.
- Menstrual cycle describes the shedding of endometrium when implantation does not occur.
- Sexual intercourse homosexually or heterosexually. It passes from infected semen or vagina fluid to blood of health person through damaged tissue in the vagina, penis or rectum.



- From sick mother to her baby during birth through breast milk during suckling.
- Through transfusion blood by contaminated needles.
- Through sharing contaminated sharp instruments.

## 8.9 Additional activities

### 8.9.1 Remedial activities

1. From which body layer in embryo does brain develop?

**2. Answers:** Ectoderm

3. List the extra embryonic membranes.

**4. Answers:** amnion, yolk sac, chorion and allantois.

5. Which membrane forms the fetal side of the placenta?

6. Answer: chorion

7. What is the role of **i) relaxin** and **ii) oxytocin** during pregnancy?

**8. Answers:** i) relaxes connective tissue in bones of pelvic girdle, ii) Stimulates uterine contraction

9. What is the name given to an embryo when it reaches 8 old weeks?

**10. Answer:** Foetus

11. Name the birth control method that is used after sexual intercourse.

**12. Answers:** Morning after pills,

13. Which type of birth control method offers some protection against sexually transmitted disease?

**14. Answer:** Condom.

### 8.9.2 Consolidated activities

1. Describe various hormones secreted by placenta during pregnancy.

**Answers:** There are three hormones:

- Human gonadotrophic hormone
- Progesterone hormone

- Oestrogen hormone.

2. Some lactating mothers have plenty of milk but it does not flow freely to nipple. They therefore have difficulty in breast feeding their babies. Suggest which hormone might lack.

**Answers:** Oxytocin.

3. Explain why internal fertilization is carried by mammal?

**Answer:** Mammals are predominantly terrestrial and internal fertilization ensures sperm do not be dehydrated by coming into contact with air

4. What are the functions of?

(i) Acrosome reaction?

(ii) Cortical reaction?

**Answers:**

(i) Acrosome reaction enable sperm to penetrate an oocyte.

(ii) Cortical reaction. To form fertilization membrane, preventing further entry of sperm into ovum.

5. Describe Features that aid of placenta to transfer materials

**Answer:**

- It provides a large surface area for the exchange
- Maternal blood flows closer to the foetal blood
- Provides a minimal barrier for diffusion and active transport of materials

6. Explain why are sperms unable to fertilize an oocyte until they have spent some time in female reproductive tract.

**Answers:** Sperm function and motility enhanced only after certain molecules on their surface have been altered by secretions in the female reproductive tract.

### 8.9.3 Extended Activities

1. Explain why sperm unable to fertilize an oocyte until they have spent at least seven hours in the female?

**Answer:** Sperm need to be activated by capacitating before fertilization to occur.

2. Describe how blastocyst burrows its way into the uterine lining during implantation.

**Answer:** By trophoblast cells digesting their way into the uterine lining.

3. A phrase commonly used to describe the first stage of birth is breaking of water. To what do you think this refers?

**Answer:** amniotic fluid

4. Why does prolactin not stimulate milk production during pregnancy?

**Answer:** effect of prolactin is inhibited progesterone and oestrogen.

5. Why does maternal blood never come into direct contact with foetal blood?

**Answer:** Because the maternal blood has high pressure which would damage foetal blood vessels.

6. Name two substances that enter the umbilical vein and two substances that leave from the umbilical artery.

**Answers:** Substances entering through umbilical vein: water, oxygen, glucose, amino acids, mineral salts, vitamins, hormones, antibodies. Substances leaving the foetus through umbilical artery: metabolic waste products such as urea and carbon dioxide.

7. What is the role of amniotic fluid?

**Answer:** The amniotic fluid is a cushion to protect foetus from knocks or bumps; it keeps temperature constant and allows the foetus to move.



## 9.1 Key unit competence

Test for biological molecules in a variety of contexts, in identifying the contents of mixtures of molecules and to follow the activity of digestive enzymes.

## 9.2 Prerequisite (knowledge, skills, attitudes and values)

The learners learnt about food nutrient and diet in senior one in which food test was introduced. Create awareness of learners the fact that the content in this unit will help them to gain knowledge, skills and attitudes that can lead them to career development in food sciences and food industry.

## 9.3 Cross-cutting issues to be addressed

This unit will address different cross-cutting issues particularly standardization culture, inclusive education, and gender education. The **standardization culture** will be addressed when students will appreciate the utilization of non-expired chemical reagents in relation to positive or good results of the experiments. Emphasis should be made so that students should always check the date of manufacture and expiration of chemicals/substances even the food material.

For addressing **inclusive education**, while students will be conducting experiments, instructional information should be given clearly and students with visual or physical impairment will be involved in learning activities by asking their colleagues who do not have impairment to perform tasks and asking them to report the results of experiments. They can sometimes use their sense organs for identifying the results of experiment.

For addressing issue of **gender**, both boys and girls should share equally responsibilities in performing experiment, arranging and cleaning the areas where experiment was conducted.

## 9.4 Guidance on the introductory activity

Introduce this unit by challenging students by using the following problem situation. You are given different substances which are in solution state. You are again asked to confirm whether those substances contain or are sugars, lipids, proteins or vitamins.

Ask them to brainstorm how they will proceed so that they can come up with good results. Use students' ideas and then introduce a whole unit.

### Answers for introductory activity

There is need to perform experiment otherwise it is not easy to confirm the type of substance given without doing experiment or a test.

## 9.5 List of lessons/sub-heading

	Lesson title	Learning objectives(from the syllabus including knowledge, skills and attitudes:	Number of periods
1	Test for starch, reducing sugars, and non-reducing sugars	Write out procedures in the identification of biological molecules Carry out tests for the identification of biological molecules Compare reducing to non –reducing sugars	2
2	Tests for proteins	Explain the importance of the reagents used in their identification of biological molecules.	2
3	Test for lipids.	Appreciate the importance of identification of food values in the food industry and in processing and packaging	
4	Test for vitamin C (Ascorbic acid).	Show resilience making observations on colour changes during food tests	1
5	Assessment:	can fully test for biological molecules in a variety of contexts, such as identifying the contents of mixtures of molecules	2

## Lesson 1: Test for starch, reducing sugars, and non-reducing sugars.

This is the first lesson of unit 3 and is a single period lesson. Before you start this lesson, you are requested to introduce the whole unit as given in the guidance on the introductory activity of this unit.

### a) Prerequisites/Revision/Introduction:

- Start this lesson by asking questions such as how can you test for the presence of starch in bread? What about the presence of sugar in a solution?
- Let students give their views. Build on students' ideas and then connect to learning activity of this lesson.

### b) Teaching resources

Starch powder, iodine solution, diluted hydrochloric acid, Benedict solution and sodium hydroxide, glucose powder, beakers, test tubes, Bunsen burner, water, droppers, pestle and mortar, measuring cylinders. If your schools do not have laboratory equipment you can take students to the nearby school where they can perform the experiment.

### c) Learning activity 9.1

For students effective learning through performing experimental activity 6.1 described in student textbook requires you to do the following:

- Plan and prepare all materials needed for this lesson.
- Provide clear instructions particularly when, what, how and why to record. For example, not respecting time could lead to poor results.
- You may help students in performing experiment by supplying other needed material.
- Ask them to do observations and record the observations
- Invite students to present their observation and make conclusions through interaction
- Use their ideas and conclude the lesson through challenging questions such as why do you say that this is a starch not white powder like chalk powder?
- Build on conclusion and extend the lesson by connecting it to how expired Benedict or Iodine reagents and food substance could not give good results for promoting issue of standardized culture.

### Answers to the activity 9.1

**Experiment 1:** The tested substance is starch and the presence of starch is indicated by the change of iodine color into dark blue/blue black.

**Experiment 2:** The tested substance must be a reducing sugar (glucose solution), the presence of reducing sugar is indicated by the change of blue color of benedict reagent to green/yellow, orange and finally red

### Answer for self-assessment 9.1

Expected observations and conclusions on the experiment are in the table below.

Experiment	Observation	Conclusion
(i) In a test tube of 4 drops of solution C1 add 2-3 drops of Iodine	Blue black/dark blue color	Presence of Starch
In another test tube of 4 drops of C1 add an equal volume of Benedict 'solution and boil for 1 min	No change the blue color of Benedict solution persist	Absence of reducing sugar
Take another test tube, put 3 drops of solution C1, add 4-5 drops of dilute hydrochloric acid and boil for 1min.  cool in water  Add some drops of sodium hydroxide until the solution can turn red litmus paper to blue color. Add 4 drops of Benedict 'solution and boil	Green/yellow, orange finally red color.	Presence of reducing sugar

- Yes, it contains starch
- Hydrochloric acid to hydrolyze starch to reducing sugar
- Sodium hydroxide is necessary to neutralize the hydrochloric acid

### Lesson 2: Test for proteins

#### a) Prerequisites/Revision/Introduction:

Do introduction by asking students to guess the type of food containing a) a)proteins and how those proteins can be tested. Based on their answers, move to the learning activity of the lesson.

#### b) Teaching resources

Test tubes, droppers, measuring cylinder pestle and mortar, beans or soybeans, Millon'



reagent, Biuret reagent, if your schools do not have laboratory equipment you can visit the nearest school.

### c) Learning activity 9.2

Effective performance of the learning activity 9.2 described in student textbook requires you to do the following:

- Plan and prepare all materials needed for this lesson.
- Provide clear instructions particularly when, what, how and why to record. For example, not respecting time could lead to poor results.
- You may help students in performing experiment by supplying the needed material
- Ask them to do observations and record the observations
- Invite students to present their observation and make conclusions through interaction
- Use their ideas and conclude the lesson through challenging questions such as why do you say that this is a protein not another substance?
- Build on conclusion and extend the lesson by connecting it to how expired Millon as well Biuret reagents or food material could not give good results for addressing issue of standardized culture.

### Answers to the activity 9.2

The observation of the learners, the color of Biuret reagent changes to pink. This confirms the presence of proteins in the sample tested.

### Self-assessment 9.2

The answer is given in the following table:

Food substance	Reagent	procedure	Observation and Conclusion
milk	*Millon's	Take 2cm <sup>3</sup> of test solution Add 2 cm <sup>3</sup> of Millon's reagent Boil for 1-2 minutes	The colour of Millon's reagent change from colourless to pink, Presence of proteins
	*Biuret's	Take 2 cm <sup>3</sup> of test solution Add 2 cm <sup>3</sup> of Biuret's Shake	The blue color of Biuret solution changes to purple Presence of proteins

What is the substance A mentioned in students book?

The same results are observed (Questions in student book)

### **Lesson 3: Test for lipids**

#### **a) Prerequisites/Revision/Introduction:**

Through questions, revise what they have learnt in senior one about food nutrients and diet. You need to focus on food/diet that contains lipids. You may also ask them to predict how the food/substance that contains lipid is identified. Build on learners' ideas and then go to the activity 9.3 given in student textbook.

#### **b) Teaching resources**

Test tubes, droppers, measuring cylinders, oil, Sudan III solution, if your schools do not have laboratory equipment you can visit the nearest school to perform the experiment

#### **c) Learning activity 9.3**

- To help students to develop competencies that are related to this lesson you need to:
- Plan and prepare all materials needed for this lesson
- Provide clear instructions on how activity 9.3 should be done
- Help students in performing experiment by supplying the needed material
- Ask them to do observations and record the observations
- Invite students to present their observation and make conclusions through interaction
- Use their ideas and conclude the lesson through challenging questions such as why do you say that this is a lipid not non-reducing sugar or protein?
- Build on conclusion and extend the lesson by connecting it to how expired Sudan III and oil could not give good results for promoting issue of standardized culture.

#### **Answers for activity 6.3**

- The presence of lipids in cooking oils is indicated by milky colour.
- The test using Sudan III solution, lipid layer sitting on top of the water layer will have a red-orange.

#### **d) Answers for self-assessment 9.3**

- You can use Ethanol: Emulsion test
- The observation: Ethanol changes from colourless to milky

- You can use the Sudan III
- Formation of layer having a red-orange colour sitting on top of water will be observed.
- In the absence of those observation there is no presence of lipids in solid X.

## Lesson 4 : Test for vitamin C

### a) Prerequisites/Revision/Introduction:

Learners have knowledge about food or other materials in which vitamin is obtained as they have learnt it from senior one in food nutrient and diet.

### b) Teaching resources

Test tubes, droppers, measuring cylinders, lemon or orange juice, DCPIP. If your schools do not have laboratory equipments you can visit the nearest school which has one.

### c) Learning activity 6.4

For smooth learning of activity, you need to do the following:

- Plan and prepare all materials needed for this lesson in advance
- Help students to do activity 6.4 through clear instructions particularly which is to be recorded and the time (end of the test or suggested time to be respected)
- You may help students in performing experiment by supplying the needed material and intervening when need be
- Ask them to do observations and record the observations
- Invite students to present their observation and make conclusions through interaction
- Use their ideas and conclude the lesson through challenging questions such as why do you say that the substance contains vitamin C not a carbohydrate?
- Build on conclusion and extend the lesson by connecting it to how expired reagent particularly DCPIP and food substance could not give good results for promoting issue of standardized culture.

## Answers for activity 9.4

The expected observations and conclusions are given in the table below.

Experiment	Observation	Conclusion
To 3cm <sup>3</sup> of DCPIP add drops of juice extracted from orange fruit	The solution decolorize of DCPIP blue colour	Presence of Vitamin C
To 2cm <sup>3</sup> of water add 2cm <sup>3</sup> of DCPIP	No change	Absence of vitamin C

Vitamin C is tested by using DCPIP (Dichlophenol indophenol), vitamin C decolorize DCPIP if there is not the presence of Vitamin C the blue color of DCPIP persist.

## Answers for Self-assessment 9.4

Procedures	Observation	Conclusion
Take a sample of juice(1cm <sup>3</sup> ) Add the juice in a test tube containing DCPIP.	The juice decolorize the blue color of DCPIP	In the tomato juice there is presence of Vitamin C

## 9.6 Summary of the unit

In this unit test for biological molecules, the experiment carried out using different reagents and food staff, indicate that:

- When testing starch using Iodine solution, the yellow color of Iodine solution turns to blue-black/dark blue if the starch is present. While during testing reducing sugar the blue colour of Benedict solution becomes green, yellow, orange and finally red.
- To test protein, the colorless Millon reagent turns to pink. Lipids can be tested by using Ethanol and water (Emulsion test) and the solution turn milky.
- In addition, the solution containing Vitamin C decolorize the solution of DCPIP.

## 9.7 Additional information

NOTICE: As a rule, a small amounts of sample should be used:

- Solid about one spatula needful(0.50-1.00g) of the substance is enough
- For liquid about 1-3cm<sup>3</sup> (4 or 5drops) of the liquid should be used.

## How to handle glassware?

While heating, it is useful to observe the following safety measures:

- Use the test tube holder or any improvised material like a folded piece of paper for holding the test tube-not your bare hands.
- Hold the test –tube at an inclined position not upright.
- Ensure uniform heating of the test tube contents by allowing heating around the surface in contact with the contents.
- Do not direct the open end of the test tube at any body
- Following instructions is very important

### Points to note when carrying out the test:

- Indicate the colour seen in the test tube at the end of the test.
- Be brief in the recording of observation

### Sources of errors:

- The blue –black or dark blue colour disappearing on heating and the experimenter missing it. No heating required
- Adding to little iodine, an excess does not cause any problem
- Forgetting to shake the solution after addition of iodine solution.
- Using unclean test tubes. With traces of starch this will give positive result even when the sample does not contain starch

## 9. 8 Answers for end unit assessment

1) Biological molecules are divided in organic molecules and inorganic molecules.

2) Reagents used are:

- a) Ethanol with water, Sudan III indicator
- b) Iodine solution
- c) Benedict’s solution

3) The teacher has to guide the learners before these practical activities.

Teacher tells to the learners the specimen given (local crops)

- a) Sorghum, maize or any other seed containing starch
- b) Potatoes, sweet potatoes, cassava...
- c) Orange fruit, lemon
- d) Sunflower, groundnut

The expected result:

- Specimen A there is presence of starch
- Specimen B presence of starch
- Specimen C presence of vitamin C
- Specimen D presence of lipids (fats)
- if the students are allowed to use HCl and NaOH together with Benedict solution; in specimen A and B there is a reducing sugar

Sample tested	Procedure	Observation	conclusion
Specimen A	Sample(2cm <sup>3</sup> ) from specimen A in a test tube add 2 to 4 drops of iodine solution	The colour turn dark blue/blue black	Presence of starch
Specimen B	Sample(2cm <sup>3</sup> ) from specimen A in a test tube labeled 2 add 2 to 4 drops of iodine solution	The colour turn dark blue/blue black	Presence of starch
Specimen C	To 3cm <sup>3</sup> of DCPIP add 3 drops of the solution extracted from specimen C	The blue colour of DCPIP disappear	Presence of vitamin C
Specimen D	Sample (2cm <sup>3</sup> ) from specimen D,add few drops of ethanol followed by equal amount of water and shake.	The colour changes from colourless to milky	Presence of fats(Lipids)

4) The expected answers to the question

- The blue color of DCPIP disappeared with the addition of pineapple juice because there is Vitamin C in pineapple juice.
- Vitamin C is involved in oxidation in the body, reduction reaction, wound healing and production of collagen fibres.
- Or simply it protects the body against diseases (scurvy)

### 5) Expected answers to the question

Food test	result	Conclusion
Sample mixed with iodine in potassium iodide	Blue-black colour	Starch present
Sample boiled with Benedict's solution	Blue colour	Reducing sugar absent
Sample treated with dilute acid, neutralized and then tested with Benedict's solution	Yellow precipitate	Reducing sugar present
Sample tested using Biuret solution	Blue ring on the surface and on shaking purple solution	Proteins present

### 6) The Unknowns for the question 6 in the student book

- Solution A -0.5% sucrose
- Solution B -1%starch solution
- Solution C -Dilute hydrochloric acid
- Solution D -Sodium hydroxide

### Answers

EXPERMENTS	OBSERVATION	CONCLUSION
(i)	Colour remains brown	Starch absent
(ii)	Colour remains blue	Reducing sugar absent
(iii)	Colour changes from blue green to yellow finally red	Non-reducing sugar absent
(iv)	Colour turns dark blue	Starch present
(v)	Colour remains blue	Reducing sugars absent
(vi)	Colour remains blue	Non-Reducing sugars absent

- Solution C is dilute hydrochloric acid and Solution D is sodium hydroxide
- To hydrolyze them to reducing sugars
- To neutralize the hydrochloric acid added.
- A is a non-reducing sugar which is present in sugar cane and milk. B is starch solution; starch is present in cassava, maize.

## 9.9 Additional activity

### 9.9.1 Remedial Activities

- 1) What is the reagent which is used for?
  - A) Testing proteins?
  - b) Testing lipids
- 2) On your choice give the food in which we can find the following substances
  - a) Starch
  - b) Vitamin C
  - c) Lipids
- 3) Which among reducing sugar and starch is tested using Benedict reagents?

### Answers for Remedial activities

- 1) Answers:
  - a) We use Biuret test or Million's reagent
  - b) We use Emulsion test (Ethanol) and Sudan III
- 2) Answers:
  - a) Tubers such as potatoes, cassava
  - b) Seeds such as maize, rice and sorghum
  - c) Orange and lemon fruits
  - d) Oil, ground nuts, sunflower
- 3) Benedict reagent is used to test Reducing sugar

### 9.9.2 Consolidation activities

- 1) Explain the chemical test that you can carry to identify the presence of proteins in a food sample
- 2) There is no special reagent to test for the presence of non-Reducing sugar. Explain the methods and procedure that you can use to identify



non-reducing sugar in a food sample.

3) What can be the source of errors in testing starch?

### Answers for consolidation activities

1) Answer:

- Proteins are tested using Biuret reagent. The reagent turns purple when it is mixed with a protein.
- A violet/purple colour is formed. The reaction takes place in alkaline solution.
- The copper (II) sulphate has Copper (II) ions that interact with the nitrogen atoms in the peptide chain that makes protein resulting to a purple colour.

2) Answer:

- Reducing sugar and non-Reducing sugar together with starch are carbohydrates.
- The test for non-reducing sugar is the test for carbohydrates.
- First of all, we test for the presence of Starch using Iodine solution
- Second we hydrolyse the sample using dilute Hydrochloric acid, and Sodium hydroxide to neutralize the acidity
- Third we test the presence of reducing sugar.
- If the sample is positive for reducing sugar test, this indicates that before hydrolysis with HCl it was a non-reducing sugar.

3) Source of errors:

- The blue –black /dark blue color disappearing on heating. No heating required
- Adding too little iodine, an excess does not cause any problem
- Forgetting to shake the solution after addition of iodine solution.
- Using unclean test tubes. With traces of starch this will give positive result even when the sample does not contain starch

### 9.9.3. Extended activities

1) You are provided with the following:

- 2 test tubes containing 2cm<sup>3</sup> each of suspensions of specimens' E and F and the solution Y.
- 4 clean test tubes, solution G -0.1% ascorbic acid solution.
- A dropper.
- 5cm<sup>3</sup> measuring cylinder.

2) Without shaking the test tubes carry out the following tests.

Record your results in the table below and answer the questions that follow.

Test	Number of drops
To 1cm <sup>3</sup> of solution Y in a test tube add drops of suspension of E until the colour disappears	
To 1cm <sup>3</sup> of solution Y in a second test tube add drops of F until the colour disappears	
To 1cm <sup>3</sup> of solution Y in a third test tube add drops of solution G until the colour disappears.	
Boil 1cm <sup>3</sup> of solution G for three minutes and cool. Add drops of this cooled solution to 1cm <sup>3</sup> of solution Y in a test tube until the colour disappears	

- Use results in (i) and (ii) in the table above and calculate the percentage of ascorbic acid in the suspensions of E. Show your working.
- Comment on difference in percentage of ascorbic acid in the two suspensions as calculated in the question 1.
- Calculate the percentage of ascorbic acid in solution G before and after boiling
- How can you explain the difference in percentage of ascorbic acid in the unboiled solution and boiled solution?

### 9.9.3. Answers for extended activities

- The specimen is:
  - Specimen E: Tomato fruit
  - Specimen F: Orange fruit
  - Suspension of E and F: Fresh Juice from tomato and orange fruits respectively.
  - Solution Y: Dichlorophenol indophenol (DCPIP)

- Solution G: 0.1% ascorbic acid solution

2) Answers:

Test	Number of drops
To 1cm <sup>3</sup> of solution Y in a test tube add drops of suspension of E until the colour disappears	20
To 1cm <sup>3</sup> of solution Y in a second test tube add drops of F until the colour disappears	10
To 1cm <sup>3</sup> of solution Y in a third test tube add drops of solution G until the colour disappears.	5
Boil 1cm <sup>3</sup> of solution G for three minutes and cool, add drops of this cooled solution to 1cm <sup>3</sup> of solution Y in a test tube until the colour disappears	7

- Percentage of ascorbic acid in suspension equals the number of the used quantity (5cm<sup>3</sup>) over the number of drops of the solution (20cm<sup>3</sup>) times the concentration of ascorbic acid solution. From here,  $E = 5/20 \times 0.1 = 0.025\%$
- Percentage of Ascorbic acid in suspension is calculated in the same way as the data summarized in the above table, so that:  $F = 5/10 \times 0.1 = 0.05\%$
- Note: 5 drops of 0.1% ascorbic acid (solution G) produces the same effect (Decolorized solution Y) as drops of solution E (E%), so that  $5 \times 0.1 = 20 \times E$ . From this equation:  $E = 5 \times 0.1 = 0.025\%$

7) Specimen F has a higher content of ascorbic acid than specimen E.

8) Before boiling the percentage is 0.1% while after boiling:  $5/7 \times 0.1 = 0.07\%$



## 10.1 Key unit competence

Explain the important roles of carbohydrates and lipids in the provision and storage of energy and for a variety of other functions.

## 10.2 Prerequisite (knowledge, skills, attitudes and values)

By questions, remind students what they have learnt in the unit 7 of senior 1 which is about food nutrients.

## 10.2 Cross-cutting issues to be addressed

In this unit, you will be addressing the two main issues among others. Those are gender education and inclusive education.

Gender education will be addressed when girls and boys will be engaged in all activities taking place in classroom and laboratory. Also, by emphasizing students that everybody regardless their gender can do great things. You can also give some examples of exemplary girls and women who are successful teachers, Doctors, Local leaders in the society where students come from.

By encouraging Students to participate during lessons, and group activities the inclusive education will be addressed. Arrange your classroom in special way to take care for those students with special needs. For blind students, help them to learn through braille method. and for those ones who have sight problems you can use large prints encourage students who are not physically impaired to support those with impairments.

## 10.3 Guidance on the introductory activity

Introduce this unit through questions about biological molecules that students have learnt in unit 6 of senior 4. Refer to the answers given by students, then introduce whole unit.

## 10.4 Teaching/learning resources

Text books, flip charts, food stuff containing starch and lipids

### Expected answers to the introductory activity

1) Lipids, Carbohydrates and Proteins.

Monosaccharide, Disaccharide and polysaccharides are classified into carbohydrates

2) Because these people have a lot of fat deposition in adipose tissue, fat (lipids) protect the body against the loss of heat.

## 10.5 List of Lessons/sub-heading

	Lesson title	Learning objectives(from the syllabus including knowledge, skills and attitudes:	Number of periods
1	Lesson1: Classes of monomers of the main biological molecules.	Recall the elements that make up carbohydrates and lipids. Define the terms monomer, polymer, macromolecule, monosaccharide, disaccharide and polysaccharide.	2
2	Lesson2: Ring forms of $\alpha$ -glucose and $\beta$ -glucose.	Describe the ring forms of $\alpha$ -glucose and $\beta$ -glucose structure.	2
3	Lesson3: Formation and breakdown of glycosidic bonds.	Explain the formation of glycosidic bonds. Appreciate the importance of carbohydrates and lipids in organisms.	1
4	Lesson4: polysaccharides (starch, glycogen and cellulose).	State the roles of carbohydrates and lipids. Interpret the charts and illustrations of molecular structure and the formation of maltose and triglycerides. Differentiate between starch and cellulose.	2

5	Lesson5: Molecular structure and functions of lipids	Describe the structure of phospholipids and relate to their functions in living organisms.  Demonstrate that phospholipids have a hydrophilic head and hydrophobic tails using a heterogeneous mixture made up of water and cooking oil.  Explain the proportion of hydrogen in carbohydrates and lipids and relate this to the amount of energy released when oxidized.  Be aware of the other roles of lipids in the formation of soap and with carbohydrates and syrups in medicine	2
6	unit assessment	Explain clearly the important roles of carbohydrates and lipids in the provision and storage of energy and for a variety of other functions.	2

### Lesson 1: Classes of monomers

This is the first lesson of unit 1 and is a single lesson. This means that it has only one period (40 Minutes). The first lesson also covers the introduction of the whole unit.

#### a) Prerequisites/Revision/Introduction.

Introduce the lesson by asking what they know or think about the monomers as they may have learnt the concept in chemistry or biology in food digestion. Similarly, connect it to what they think to be monomers in biology. Ask them to give some examples. Use their ideas and ask them to do activity 10.1 given in student textbook.

#### b) Teaching resources

Books, charts and plastic atomic model

#### c) Learning activity 10.1

You need to do the following:

- Facilitate the formation of groups by emphasizing on individual differences
- Do facilitation role for helping students to come up with good results

- Invite students to make presentations

Help students to summarize the lesson and draw the conclusion

### **Answer for activity 10.1**

1) Monomers are small unit, and when joined together make up long chain of structures called polymers.

Monosaccharide form carbohydrates

### **Answer for self-assessment 10.1**

2) Polymers: Proteins, carbohydrates, Nucleic acid

3) Monomers: Amino acids, Monosaccharide and Nucleotide

Monomers are small unit, and when joined together make up long chain of structures called polymers.

Monosaccharide form carbohydrates

Nucleotides form nucleic acid

The macromolecules of life are lipids, Nucleic acids, Carbohydrates and proteins all of those are polymers.

## **Lesson 2: Ring form $\alpha$ and $\beta$ Glucose**

### **a) Prerequisites/Revision/Introduction:**

Ask students to write down the chemical formula of glucose as they have learnt it in the study of photosynthesis. Ask them to imagine how molecules in glucose are linked as they have some knowledge and skills from senior two in chemical bonding unit. Connect to the lesson of the day from student's ideas.

### **b) Teaching resources**

Different student 's books, graph charts, simulations and computer animations, projector, Manila paper with diagrams for improvisation.

### **c) Learning activities**

You need to do the following for helping students develop competences related to this lesson:

- Help the students to form groups while catering for needs of all learners
- Provide necessary material for the activity 10.2



- Guide the students while doing activity 10.2 given in student textbook
- Give space to students to present their works

Help them to summarize the lesson and come up with conclusion

### Answers to the activity 10.2

1) Answers:

a) Monosaccharide with 3 carbon atoms is a triose.

b) With 5 carbon atoms is a pentose

c) With 6 carbon atoms is a hexose

2) Ring monosaccharide are said to be **alpha ( $\alpha$ )** if the OH group on carbon 1 is below the ring, and **beta ( $\beta$ )** when the OH group is above the ring.

3) Glucose is a monosaccharide the properties of glucose are the same as those of monosaccharide including:

- They are highly soluble in water
- They have sweet taste
- They have lower molecule mass

### Lesson 3: Formation and breakdown of glycoside bond.

#### a) Prerequisites/Revision/Introduction:

Introduce this lesson by asking students to brainstorm on how a glycosidic bond is form. Use their ideas and then take students to the learning activity.

#### b) Teaching resources

Plastic atomic model, Books, videos, charts.

#### c) Learning activities

To help students to enhance knowledge, skills and values related to this lesson, you are requested to do the following:

- Invite students to do activity 10.3 in student textbook
- Facilitate them in doing activity by asking them questions and orienting them in doing a research in teaching resources
- Involving different students in the presentation

### Answers to the activity 10.3

- 1) Use point and line to create a polymer of repeating units.
- 2) Chemical bond.
- 3) Answers are:

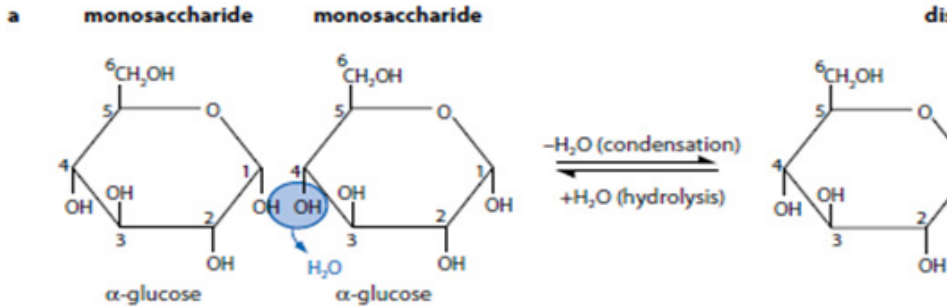

### Answers for self-assessment 10.3

- 1)  $\text{C}_{12}\text{H}_{22}\text{O}_{11}$
- 2) The glycosidic link is formed by condensation reaction/dehydration where a molecule of water is lost.

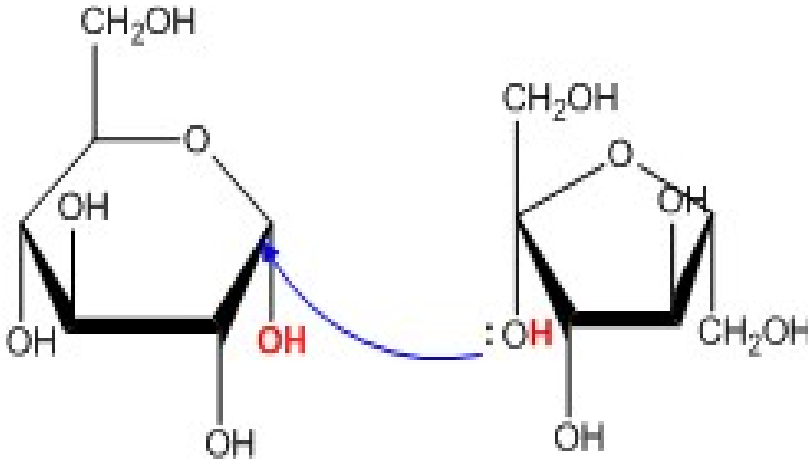

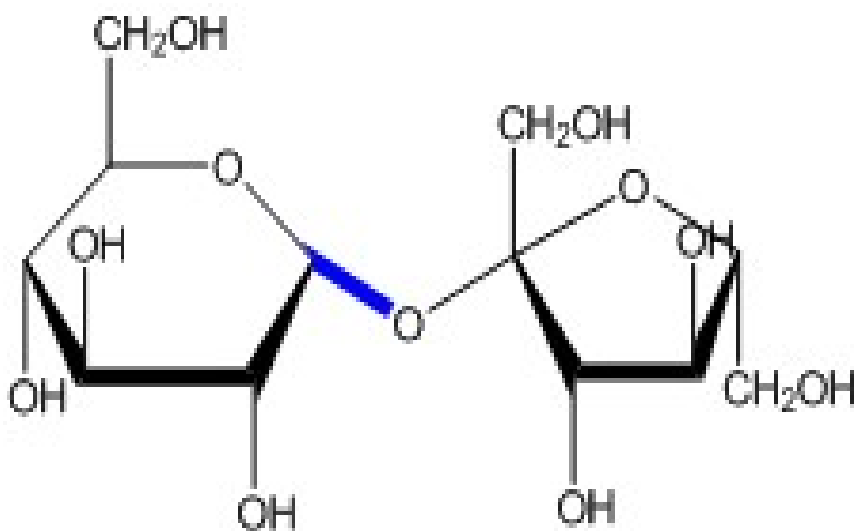

b    monosaccharide    monosaccharide                      disaccharide

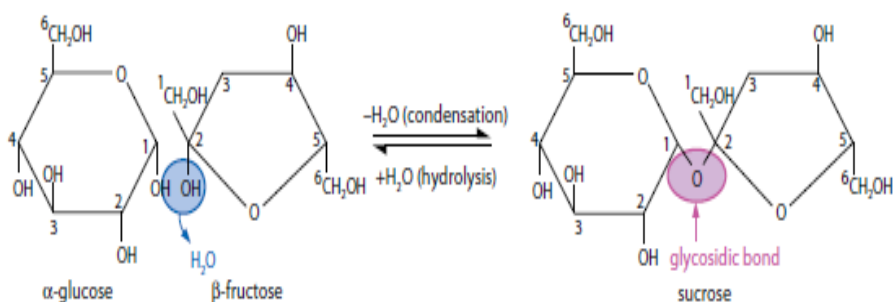

3) Answers are:

a) Glucose and fructose

b) By condensation reaction the glycosidic bond is formed between glucose and fructose

## Lesson 4: Polysaccharides starch, glycogen and cellulose

### a) Prerequisites/Revision/Introduction

Introduce this lesson by asking questions related to previous lesson.

The questions are about the meaning and types of monomers and bond type formed into different monomers. Refer to their ideas and move to the activity of the lesson as given in student textbook.

## b) Teaching resources

The following resources will help you to progress well in this lesson. Those include books, charts and plastics atomic model.

## c) Learning activity 10.4

During this learning activity, you as a facilitator you are requested to do the following for helping your students.

- Provide the necessary materials to students
- Facilitate the smooth running of activity
- Give time to students to report
- Use what students reported, ask questions for challenging the students and summarizing the lesson.

End the lesson by consolidating students' ideas in relation to the learning outcomes.

## Answers for the activity 10.4

1) Monosaccharide means single sugar; because monos: single sacchar: sugar

Polysaccharide it is a polymer of monosaccharide

2) Answers are:

a) Monosaccharide

b) Disaccharide

c) Polysaccharides

3) Figure of Starch, cellulose, or glycogen

## Answers for self-assessment 10.4

1) Hydrolysis reaction

2) Addition of water molecules to sucrose to obtain two unit of glucose

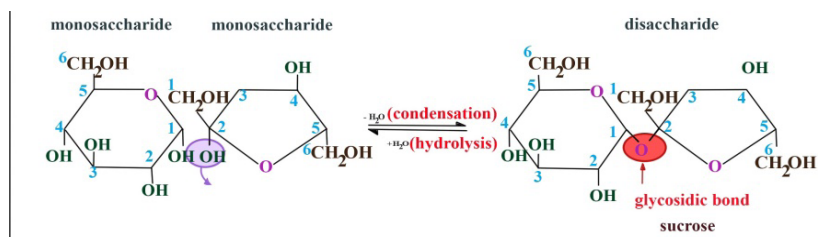

The major types of starch are: Amylose and amylopectin

Differences: Amylose is the simple structure of starch; it is unbranched chain of glucose while amylopectin is a branched structure of starch

## Lesson 5: Lipids

### a) Prerequisites/Revision/Introduction:

To achieve learning objectives of this lesson, students should be having background that are pertained to fatty acids and glycerol as components of lipids as they have background knowledge, skills and attitudes from the unit of lipids and description of cell membrane.

### b) Teaching resources: Books, charts, etc

### c) Learning activities

Help students to do learning activities provided in their textbook.

- Provide the necessary materials to students.
- Facilitate the smooth running of activity.
- Give time to students to report.
- Use what students reported, ask questions for challenging the students and summarizing the lesson.

End the lesson by consolidating students' ideas in relation to the learning outcomes.

### Answers to the activity 10.5

1) Lipids are polymer of glycerol and fatty acids

2) Oils from plants and animals are rich source of lipids: Butter, dairy products, cooking oils.

3) The scientific research show that the reason why pig do not like hot environment; the pig do not sweat. But the common myth in Rwanda it is because there is high concentration of lipids, means that lipids produce heat or act as insulators of organisms

### Answer for self-assessment 10.5

1) Glycerol and fatty acids

2) Fats are lipids which are solid at room temperature, have saturated fatty acids

3) Answers are:

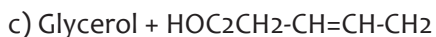
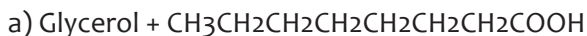

Notice: you have to show reaction and do not forget to add the water molecule.

## 10.6 Summary of the unit.

Carbohydrates and lipids are compound of carbon, they are organic molecules, Lipids and carbohydrates differ in their amount of oxygen. The carbohydrates are divided into monosaccharide, disaccharides and polysaccharide. The monosaccharide is named according to the number of carbon the commonly known are: Triose(3carbon), Pentose(5Carbon) and hexose(6carbon). Those monosaccharides can be ring form, the  $\alpha$ -glucose and  $\beta$  glucose are ring form of glucose and differ by the position of OH group.

## 10.7 Additional information

Lipids are polymer of Glycerol and fatty acids they are formed by condensation process the same to carbohydrates, lipids can be oils or fats if the fatty acids are unsaturated or saturated respectively. The main types of lipids are: Tryglycerides, Cholesterol, phospholipids and wax, carbohydrates and Lipids are energy storage of the body even though carbohydrates are the ones which are commonly used, but the lipids produce more energy compared to carbohydrates.

## 10.8 Answers for end unit assessment 7

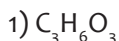

2)The answer is summarized in the following table:

Fat	Phospholipids
Glycerol plus fatty acids	Glycerol plus fatty acids
The main function is to form a compact energy store, insoluble in water so doesn't affect water potential.	Its main function is to forms a molecule that is part hydrophobic, part hydrophilic ideal for basis of cell surface membranes

3) They are used by the body to produce energy.

They are used in hormone production

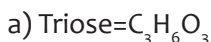

## Hydrolysis reaction

6) Answers:

a) Alpha glucose is the  $\beta$  glucose. Ring monosaccharide are said to be alpha ( $\alpha$ ) if the -OH group located on carbon 1 is below the ring and beta ( $\beta$ ) when the -OH group is above the ring.

b) Glycogen and cellulose: glycogen is made up of  $\alpha$ -glucose and exists as granules and is more highly branched while the glucose in cellulose is  $\beta$ -glucose and it is the chief constituents of cell walls in living organisms

c) Amylopectin and amylose: Amylopectin and amylose all are form of starch, means that they are polymer of  $\alpha$  glucose the only difference it is that Amylose is unbranched while Amylopectin is highly branched.

## 10.9 Additional activities

### 10.9.1 Remedial Activities:

1) A condensation reaction produces a new compound and releases a molecule of...

2) .....is the reverse of a condensation reaction

3) How do we call a single sugar molecule?

a) Monomers

b) Monosaccharide

c) Carbohydrates

d) Proteins

4) How many numbers of hydroxyl groups in a glycerol molecule?

### Answers for remedial activities

1) Release a molecules of water

2) Hydrolysis

3) (b) Monosaccharide.

4) There 3 OH group in Glycerol molecule

### 10.9.2 Consolidation activity

Suggested questions and answers for deep development of competences.

1) A phospholipid consists of:

- a) Phosphates, fat and oil
- b) Phosphoric acid, glycerol and fatty acids
- c) Phosphoric acid, fats and oil
- d) Phosphate, glycerol and fatty acids

2) The empirical formula of a compound is  $C_{51}H_{98}O_6$ . Such compound is a:

- a) Protein
- b) Lipid
- c) Vitamin
- d) Carbohydrate

3) The number of carbon atoms which form the ring in a glucose molecule are:

- a) 2
- b) 3
- c) 4
- d) 5

4) Each of the questions 1, 2, 3 consists of an assertion (statement) on the left hand side and a reason on the right hand side. Select:

- a) If both assertion and reason are true statements and the reason is a correct explanation of the assertion
- b) If both assertion and reason are true statements but the reason is not a correct explanation of the assertion
- c) If the assertion is true but the reason is an incorrect statement
- d) If the assertion is incorrect but the reason is a true statement



1	Enzymes are denatured by high temperatures	because	They are made of protein
2	Maltose and sucrose are both disaccharides but unlike maltose, sucrose is not a reducing sugar	because	It contains glucose and fructose
3	Lipids are important constituents of the plasma membrane	because	They contain the elements C, H and O with a high proportion of O <sub>2</sub> than hydrogen and carbon

### Answers for consolidation activities:

- 1) b
- 2) b)
- 3) a
- 4) The following are the answers
  1. A
  2. B
  3. C

### 10.9.3 Extended activities

- 1) Starch and glycogen are important storage carbohydrates.
  - a) State one structural similarity and one structural difference between them.
  - b) State any two organs in which starch is stored in plants.
  - c) Where is glycogen stored in animals?
- 4) Explain why it is an advantage of storing energy in large molecules?

### Answers for extended activities:

- 1) The following are the answers:
  - a) Similarities
    - Long chain of alpha glucose
    - Branching chain
    - Long chain linked by glycosidic links / bonds.

## Differences

- Starch is less branching while glycogen is profusely branching
- Starch is less soluble while glycogen is more soluble
- Starch exists as grains while glycogen exists as tiny granules
  - a) In plants, starch is stored in tubers (potatoes, cassava... ) and in stem
  - b) In animals' glycogen is stored in liver and muscles

2) Large molecules of denser monomers take up a less space than an equivalent amount of the monomer. Also, large molecules are usually insoluble in water and not easily broken down. Starch and glycogen are therefore more efficient storage units than glucose.

## 11.1 Key unit competence

Describe how protein structure is related to function and analyse the role of water as a special molecule with extraordinary properties that make life possible.

## 11.2 Prerequisites (knowledge, skills, attitudes and values)

Remember that students have learnt about proteins in the unit of food nutrients of senior four whereby they have developed knowledge, skills, attitudes and values that are related. This is similar to water as a biological molecule.

## 11.3 Cross-cutting issues to be addressed

This unit will address various cross-cutting issues including standardization culture, environmental sustainability as well as inclusive education.

Inclusive education will be addressed through activities planned in various lessons in which all students will be involved. Additionally, printing large letters and figures for catering students with visual disabilities.

## 11.4 Guidance on the introductory activity

During this activity, remember that student learnt food test in senior one and senior four in the unit pertained to food nutrient and diet. You can introduce the lesson by asking them different questions that are related to proteins that have been covered in previous unit.

### Expected answers for introductory activity:

- a) Proteins are polymer of amino acids
- b) Water ( $H_2O$ )

## 11.5 List of Lessons/sub-heading.

	Lesson title	Learning objectives	Number of periods
1	Structure of amino acid. Formation and breakage of a peptide bond	- Describe the structure of an amino acid and the formation and breakage of a peptide bond.	2
2	Structures, functions, denaturation of proteins.	<ul style="list-style-type: none"> <li>- Describe the primary, secondary, tertiary and quaternary structure of proteins.</li> <li>- Describe the molecular structure of hemoglobin as an example of a globular protein.</li> <li>- Distinguish between collagen molecules and collagen fibres</li> <li>- Appreciate the importance of globular and fibrous proteins in biological processes such as the transport of gases and providing support for tissues.</li> <li>- Express that protein structure is central to many aspects of biology, such as enzymes, antibodies and muscle contraction.</li> <li>- Explain the effect of heat, pH and chemicals on protein structure.</li> <li>- Describe the functions with an emphasis on iron in the hemoglobin molecule.</li> <li>- Devise an experiment to investigate the effect of temperature, pH and chemicals on the structure of protein.</li> <li>- Relate the structure of globular and fibrous proteins to their functions.</li> </ul>	2
4	Water and its properties	<ul style="list-style-type: none"> <li>- Investigate the effect of lowering temperature on water.</li> <li>- Acknowledge that water is a special molecule with extraordinary properties that make life possible on this planet.</li> <li>- Explain how hydrogen bonding occurs between water molecules and relate the properties of water to its roles in living organisms.</li> </ul>	2

5	End unit Assessment:	Learners have the ability describing how protein structure is related to function and describing the role of water as a special molecule with extraordinary properties that make life possible.	1
---	----------------------	---	---

## Lesson 1: Structure of amino acid

As this is the first lesson of the unit. It covers also the general introduction.

### a) Prerequisites/Revision/Introduction:

Students are equipped with knowledge and skills resulted from test for biological molecules. They know also the sources and functions of proteins.

### b) Teaching resources: Books, charts and internet.

### c) Learning activities

For helping students to develop knowledge, skills and attitudes that are related to the lesson do the following:

Ask students to work in pairs and answer to the questions found in activity 8.1.

### Answers for self-assessment 8.1

- 1) Essential amino acids (Student book).
- 2) The peptide bond formation: A condensation reaction occurs between the amino group of one amino acid and the carboxyl group of another, to form a dipeptide
- 3) Zwitterion, this is a molecule with two different charges (positive and negative) at the same time
- 4) Student book
- 5) In preparing food, we have to consider many plant food staff.

## Lesson 2: Structure and denaturation of protein

### a) Prerequisites/Revision/Introduction:

From the previous lesson students learnt about formation of polymer and condensation reaction with a loss of water molecules. Ask them to remember how condensation occurs. You may even give them the monomers of a protein and ask them to combine. Interestingly, you may ask them to predict or guess how molecules within an egg look

like? Ask also them how they will look like as an egg is boiled. You may also ask them to illustrate the structure of hemoglobin or hair.

**c) Teaching resources: Student textbook, school library textbooks, figures on manila paper, and internet.**

**d) Learning activities.**

Discuss activity 11.2: facilitate students in doing activity 11.2 found in student textbook by:

- Ask them to present their work
- Harmonize their ideas
- Help them to make a summary of the lesson through questions and come up with conclusion

**Expected answer to the activity 11.2**

1. a) Proteins structure are: Primary, secondary, tertiary and quaternary structure

b) Protein polymer are formed by condensation process where a molecule of water lost and the resulting bond is called ester link<sup>2</sup>. The idea behind this scenario it is about the denaturation of protein.

2. The plastic burn and the cords are no longer holding together, this is the same to the protein chain, when exposed to heat the peptide bonds holding the amino acids break and the protein is denatured.

**Answers for self-assessment 11.3**

1) Primary, secondary, tertiary and quaternary structure.

2) A peptide bond

3) Check student's book.

4) In the living cell denaturation of protein disturb the physiology and proper function of a cell, such as inhibition of enzyme activities which can lead to the death of the cell.

### **Lesson 3: Water**

**a) Prerequisites/Revision/Introduction.**

Water is almost known by every student in senior four classes, what is necessary here is to emphasize about the properties of water which turn water to be an important

liquid molecule in biology. You may ask question such as the importance of water and the properties of water especially those which are related with the hydrogen bond in water.

**b) Teaching resources: books, chart, internet.**

**c) Learning activity 11.4**

You have to give the guidelines for the exchanges of idea on water properties which help the water to be suitable to the organism more than other liquid.

**Answers for activity 11.4**

- 1) The medium of chemical reactions in organism is water.
- 2) The boiling point of water is greater than the boiling point of oils because of the existence of hydrogen bonds in water molecules

**Answers for self-assessment 11.4**

- 1) Check in students book
- 2) Check in students book
- 3) The high heat capacity provides a suitable medium of biochemical reactions that take place in organism by maintaining the temperature whoever the fluctuations of temperature in the environment. Take an example of an organism living in desert where the temperature can rise up to 45°C, this temperature is not ideal to the organism; the life into this region is possible thanks to the high heat capacity of water.
- 4) The ice floats over water because it is less dense than water, during the freezing of water the hydrogen bond expands and open.

**11.6 Summary of the unit.**

Proteins are polymer of amino acids; the amino acids in polypeptide are joined one to another by a peptide bond. Depending on how proteins are coiled we have; primary structure, secondary structure, tertiary structure and quaternary structure of proteins. In addition to those structures Globular proteins (soluble in water) and fibrous proteins (insoluble in water) are other types of protein. In this unit proteins and water, we talked about water and its properties; solvent, high heat capacity, freezing point and surface tension and how they are related to the biological importance of water.

## 11.7 Answers for end unit assessment.

1. Tertiary structure.

2. Answers:

a) condensation reaction

b) Starch

3. Answers:

a) latent heat of vaporization

b) Solvent property of water

c) High heat capacity

4. Notice: Explanation student book

Monomers	Bond	polymer
Nucleotides	Phosphodiester linkages	Triacylglycerol
Monosaccharide	Glycosidic linkages	Polysaccharide
fatty acids	Ester linkages	Triacylglycerol
Amino acids	Peptide bonds	polypeptides

5. During denaturation there the braking down peptide bond

## 11.8 Additional activities

### 11.8.1 Remedial Activities:

- 1) State the function of water.
- 2) Name the bond in secondary structure of proteins.
- 3) What happen to the protein if is denatured?

### Answers for Remedial activities:

- 1) Student book.
- 2) Secondary structure bond: peptide bond, hydrogen bond.
- 3) When a protein is denatured the proteins change the shape.



### 11.8.2 Consolidation activities: Suggested questions and answers for deep development of competences.

1) Answer the following questions:

a) What does the peptide bond have to do with the secondary structure of a protein?

b) Types of bonding maintain the tertiary structure of protein?

2) Label the following diagram using the terms H<sub>2</sub>O, monomer, Hydrolysis reaction, dehydration reaction and polymer. Terms can be used more than once and a term need not to be used

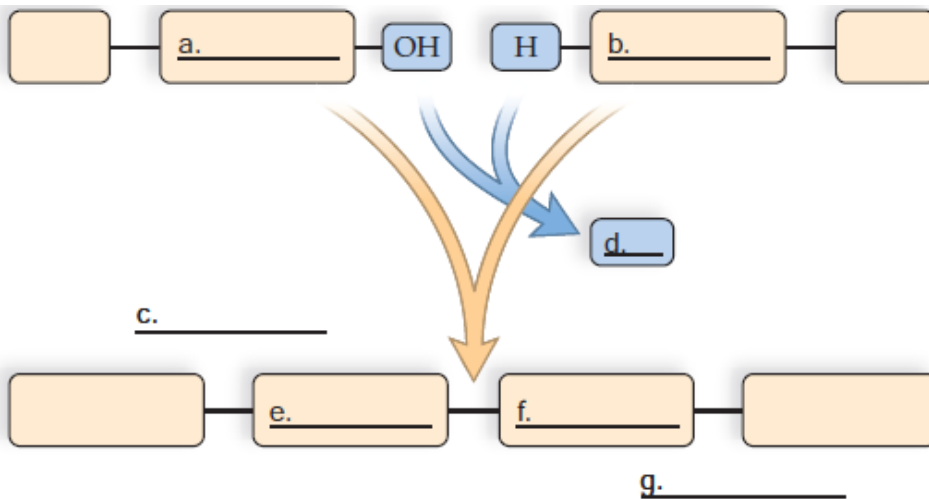

3) Explain why water has a high heat of Vaporization?

#### Answers for consolidation activities:

1) Answers:

a) The peptide bond holds the amino acids together in the secondary structure

b) Hydrogen bond, Ionic bond, hydrophobic interaction and Vander Waals interactions, Disulfide bridges

2) The following are the answers:

a) Monomer

b) Monomer

c) Dehydration reaction

d) H<sub>2</sub>O

e) Monomer

f) Monomer

g) Polymer.

3) High heat of vaporization this it is the energy (Heat) needed to transform water into vapor this energy is greater because of the high heat capacity of water.

### 11.8.3 Extended activities

- 1) Explain why children in summer can cool off by playing in a sprinkler.
- 2) Suppose you eat a serving of green beans. What reactions must occur for amino acid monomers in the protein of the beans to be converted?
- 3) How many molecules of water are needed to completely hydrolyze a polymer that is ten monomers long?

### Answers for extended activities

- 1) In summer as there is high temperature in the environment, this do not mean that the water also is hot as we know to rise water to 1°C it requires more energy. That why when children play in sprinkler during summer can cool off even though the environment is hot.
- 2) The reaction that must take place is hydrolysis reaction, after absorption in the intestine those monomers are condensed by hydration to be used by the body as proteins.
- 3) A polymer of ten monomers can be hydrolyzed by ten molecules of water.

## 12.1 Key Unit Competence

Discuss the roles of minerals and vitamins in diet.

## 12.2 Prerequisites (Knowledge, skills, attitudes and values)

The prior knowledge, skills and attitudes that students should have developed are related to food nutrients.

## 12.3 Cross-cutting issues to be addressed

Standardization culture as one most issue which will be addressed by this unit. Students will be challenged about on the relevance of eating balanced or non-balanced diet through questions like: Ask yourself if your family provide balanced diet to its members. Why is it necessary to take them? What are the consequences of not taking such diet? By using the table below, the issue can also be added by questions like do you know how much carbohydrates could be taken every day. What about vitamins? And other which can be formulated from the table below. From being challenged and being advised, students will change their mind and then appreciate the relevance of balanced diet.

**Table 12.1 Calcium requirements in different life stage groups**

Mineral	Life stage group	Age in years	Required amount per day in mg.
Calcium (Ca)	Adult	19-50	1,000
	women	51 and above	1,200
	Men	51-70	1,000
	Men	71 and above	1,200
	Pregnant women	Over 18	1,200-1400
	Breastfeeding women	Over 18	1,200-1400
	Infants	1-3	700
		4-8	1,000
		9-13	1,300
		14-18	1,300

It is not good to intake supplement salts instead of obtaining them from the diet. Too much calcium may interfere with your body’s ability to absorb other minerals, cause constipation or increase your risk of kidney stones.

**Table 12.2 Foods that are good sources of Ca and their nutritive values in Ca, Iron, and Magnesium.**

Food	Calcium	Iron	Magnesium
Milk	12%	0%	2%
Baked bean	6%	11%	10%
Soya milk	20%		
orange juice	1%	1%	2%
Green leafy vegetables	9%	15%	19%

Therefore, sensitize your family and neighbors to have green vegetables garden (akarima k’igikoni) and plant fruit trees as they are the natural sources of most vitamins and minerals.

## 12.4 Guidance on the introductory activity

Introduce the unit by asking questions so that students will provide different food stuff that they contain vitamins and mineral salts. Ask also them to guess diseases caused by lack of those food stuff. Use their ideas and then start the lesson one of the unit.

### Expected answers for introductory activity

- 1) Foods that are good sources of vitamin: green vegetables, beans, wheat, pumpkin, meat, fish, orange, banana, sunflower seed and avocado.
- 2) Some vitamins and minerals deficiency diseases are for example night blindness, rickets, beriberi, cretinism, scurvy, anemia, and goiter.

## 12.5 List of lessons/sub-heading

	Lesson name	Learning objectives	Number of periods
1	Mineral nutrients in humans.	State the mineral requirements for bodily functions.  Identify the symptoms of mineral and vitamin deficiency.	1
2	Classification of mineral nutrients	Outline the need for consumption of minerals and vitamins in small amounts.	1
3	Sources, functions and deficiency symptoms of mineral nutrients in humans.	Organize a list of foods that are good sources of vitamins and mineral salts.  Recognise the signs and symptoms of scurvy, night blindness, goitre, and anaemia.	2
4	Vitamins and the classification of vitamins.	Differentiate between water soluble and lipid soluble vitamins.	1
5	Sources, functions and symptoms of vitamin deficiency	Analyse one's eating habits and suggest improvements  Appreciate the importance of a balanced diet in relation to health and economic prosperity.  Advocate for healthy feeding methods.	1
Assessment: Students can discuss the roles of minerals and vitamins in diet			1

## Lesson 1: Mineral nutrients in humans

As this is the first lesson of the unit which is to be done in a period of 40 minutes, you are reminded to introduce the unit before this lesson. During the lesson, create awareness of learners the fact that the content in this unit will help the learners to gain knowledge which help them to avoid malnutrition in their families, which can lead them in health services mainly as nutritionists in health centers, in hospitals and in hotels. Tell learners that more details on nutrients will be studied at high levels. This will enable learners to be familiar with the importance of minerals, and vitamins.

### a) Prerequisites/Revision/Introduction

Remind students that they have learnt about food nutrients in previous levels. Through questions, students share the knowledge, skills and attitudes acquired in previous years.

### b) Teaching resources

Student's books and food stuffs.

### c) Learning activities

To facilitate smooth running of the lesson, the following are required:

- Ask learners to do individually the activity 9.1 in the student textbooks
- Working individually helps the learners to develop critical thinking, research and problem solving skills.
- Make sure that all students are working. If some of them may have got some difficulties to do the activity, help them. Remember to assist those who are weak but without giving them the knowledge.
- Invite some students to present their findings to the rest of students developing thus communication skills.
- Through challenging questions, harmonize and conclude the lesson.

### Answer for activity 12.1

Calcium (K), potassium (K), phosphorus (P), Nitrogen (N), Sulfur (S), Sodium (Na), Iron (Fe), Magnesium (Mg), Fluoride (F), zinc (Zn), Cobalt (Co), chromium, selenium and molybdenum (Mo), Manganese (Mn), Iodine (I), Chloride (Cl) .

### Answers for self-assessment 12.1

- Ten mineral nutrients required in humans: calcium (Ca), phosphorus (P), Nitrogen (N), Sulfur (S), Potassium (K), Sodium (Na), Iron (Fe), Magnesium (Mg), Iodine (I), Chloride (Cl),
- False. They are called essential not because they are more important but because they are necessary and the human body cannot make them itself.

## Lesson 2 :Classification of mineral nutrients

### a) Prerequisites/Revision/Introduction:

Remind students that they have learnt about mineral nutrients, and ask them to discuss their abundance in human body so that they can prepare themselves for this lesson.

### b) Teaching resources

Students' books, internet connectivity if available, mineral elements, etc.

### c) Learning activity 12.2

To be clear with this lesson you are asked to do the following:

- Ask students to work in pair the activity 12.2 in student's textbook.
- Assist those who have some difficulties about the activity.
- Invites any three pairs to present their findings to the rest of students.
- You welcome student's ideas, clarify them and harmonize to build up a conclusion.

### Answers for activity 12.2

Sodium and chloride are needed in relative large amounts while iodine is needed in a very small amount.

### Answers for self-assessment 12.2

- 1) Macronutrients and Micronutrients
- 2) **Macronutrients** are minerals needed by humans in relatively large amounts whereas **Micronutrients** are minerals needed by humans in relatively small amounts.
- 3) Calcium (Ca), Potassium (K), Phosphorus (P), Sodium (Na) and Magnesium (Mg).

## Lesson 3: Sources, functions and deficiency symptoms of mineral nutrients in humans.

### a) Prerequisites/Revision/Introduction:

Remind students that they have learnt about mineral nutrients in S1. Then ask them to discuss the various food stuffs rich in mineral salts and the roles that they play in human body so that they can prepare themselves for this lesson.

## **b) Teaching resources**

Students' books, graph charts, different food stuff simulations and computer animations, projector, Manila paper with diagrams for improvisation

### **Learning activity 12.3**

**For the success of this lesson, guide students to perform the activity;**

- Ask them to work in pairs the activity 12.2 in student's textbook. This help to develop critical thinking, research and problem solving skills.
- Assist those who are weak but without giving them the knowledge.
- Invite any three pairs to present their findings to the rest of students; they develop communication skills.
- Ask them to note on chalk board / Manila paper
- Through some questions, complete the incomplete students 'findings

### **Answer for the activity 12.3**

Banana, cassava, wholegrain, oranges, pumpkin, potato, beans, water melon, green leafy vegetables, poultry, eggs, liver, and milk

1) Wholegrain, green leafy vegetables, milk, eggs, liver.

### **Answer for self-assessment 12.3**

**1a=5**

**b=4**

**c=1**

**d=3**

**e=2**



## 2) Minerals required in humans and their sources

Mineral	Major dietary sources	Some major functions	Mineral deficiency diseases and their symptoms.
Ca	Milk, soy milk, green leafy vegetables, sardines	Needed for nerve and muscle action; builds bone and teeth; helps blood clot	Retarded growth, possibly loss of bone mass and bone deformation called rickets.
P	Meat, poultry, pumpkin seeds, sunflower seeds, water melon, whole grains	Component of bones, teeth, lipids, cell membrane, and nucleotides.	Phosphorus deficiency results in a form of Bone malformation known as rickets
Cu	Seafood, nuts, legumes, organ meats,	Enzyme cofactor in iron metabolism, melanin synthesis, electron transport, maintains the immune system stronger.	Growth failure, scaly skin inflammation, reproductive failure, impaired immunity.
I	Seafood, dairy products, iodized salt	Component of thyroid hormones	Cretinism, Goiter (enlarged thyroid)
Zn	oysters, beef, lamb, spinach, pumpkin seeds, squash seeds, nuts, dark, pork chocolate, beans, chicken and mushrooms.	It acts like a powerful antioxidant, is needed for proper cell division, to convert vitamin A into its active form in order to maintain proper vision, it is also needed for proper immune system functioning and wound healing.	Skin rashes and acne, thinning hair, nerve dysfunction, weak immunity, and nutrient malabsorption.

3) The best answers

- (i) a    (ii) a    (iii) a and c    (iv) a and d    (v) b    (vi) b and d  
(vii) d    (viii) c    (ix) c    (x) d

4) Goiter, rickets, scaly skin, anemia, impaired immunity.

### **Lesson 4: Vitamins and their classification.**

#### **a) Prerequisites/Revision/Introduction:**

Remind students that they have learnt about food nutrients in S1. Then ask them to list the various food stuffs rich in vitamins so that they can prepare themselves for this lesson.

#### **b) Teaching resources**

Students' books, graph, charts and different food stuffs.

#### **c) Learning activity 12.4**

**To facilitate the smooth running of the lesson you are asked to do the following:**

- Ask students to bring some food stuffs available at home or the school garden, kitchen etc.
- Ask students to work in groups on the activity 12.4 in student's textbook. This help to develop critical thinking, research and problem solving skills.
- Move around to monitor if they are some problems,
- Invites at least three groups to present their findings to the rest of students; they develop communication skills.
- Ask other students to follow carefully the presentations
- Note on chalk board / Manila paper the student's ideas.
- Confirm the correct students' ideas and correct incomplete ones.
- Through challenging questions, harmonize and conclude the lesson
- Together with students make a conclusion.

#### **Answer for the activity 12.4**

- 1) Student A lacks vitamin C while student B lacks vitamin A
- 2) Vitamin C is water soluble therefore it cannot be stored. Vitamin A is fat-soluble; it is stored in body tissues that are why it is not necessary to take it every day.

## Answers for self-assessment 12.4

- 1) 13 vitamins
- 2) They are classified based on their solubility as water-soluble and fat-soluble vitamins.

## Lesson 5 : Sources, functions and symptoms of vitamins deficiency

### a) Prerequisites/Revision/Introduction:

This is the fifth lesson of unit 9 vitamins and minerals. In this lesson you will be dealing with sources, functions of vitamins and symptoms of vitamins deficiency. The first thing to do before starting teaching is to remind students that they have learnt about food nutrients in S1. Then ask them to discuss the various food stuffs rich in vitamins so that they can prepare themselves for this lesson.

### b) Teaching resources

Students' books, graph charts, different food stuffs, simulations and computer animations, projector, Manila paper with diagrams for improvisation.

### c) Learning activities 12.5

#### For the success of this lesson, the following are needed:

- Ask students to work in groups of five on the activity 12.5 in student's textbook. This help to develop critical thinking, research and problem solving skill
- Assist those who are weak but without giving them the knowledge.
- Invite any three groups to present their findings to the rest of students; they develop communication skills.
- Harmonize and conclude on the learnt knowledge and still engage students in making their own conclusion

### Answer for the activity 12.5

Banana, wholegrain, oranges, pumpkin, water melon, green leafy vegetables, milk.

## Answers for self-assessment 12.5

### 12.6 Summary of unit

Minerals and vitamins do not supply energy like other food nutrients but help to regulate body functions, they also help body growth, and protection. Vitamins assist the functioning of enzymes as coenzymes, minerals assist them as cofactors or prosthetic group. Calcium and phosphorus provide teeth hardening. Magnesium, calcium and zinc are involved nerve and muscle function. Fat-soluble vitamins- E, K, A, D are stored in

the body's fatty tissues; their excess lead to some disorders. Water –soluble vitamins- B vitamins and C cannot be stored. Both minerals and vitamins cannot be synthesized in the human body, they must be obtained from the daily diet. Inadequate intake of minerals and vitamins cause deficiency diseases like goiter, beriberi and night blindness. The excess of minerals may result in body dysfunction.

## 12.7 Additional information

To enrich the content in student's textbook, you should consult other books and search on internet to complete some student's findings. You should also be creative when you are introducing the unit and lesson to help students to engage themselves in different lessons.

## 12.8 Answers for End unit assessment 9

1) b 2) d 3) b 4) a 5) a 6) d 7) d 8) d 9) a 10) c

11) b 12) c 13) d 14) a 15) b 16) d

17) vitamin D and vitamin biotin (vitamin B7)

18) Advice to every one: Taking food-rich in the vitamin or mineral that he/she lacks. See tables 12.1 and 12.4, student's textbook

## 12.9 Additional activities

### 12.9.1 Remedial activities

1) What are fat-soluble vitamins?

**Answer:**

Vitamin K, A, D and E.

2) Predict what could happen if someone lacks Ca in the diet.

**Answer:**

In childhood it results into rickets, in adult in osteomalacia.

3) In a tabular form, identify the major dietary sources, the functions in human bodies and the deficiency diseases of the following minerals: Ca, I, P, zn, and Cu.

**Answer:**

See the **table 12.1** in student's textbook.

4) Two mothers have to care for their children's nutrition. One mother frequently gives her child vitamin A-rich food while the other gives to her child the food poor in vitamin A. Predict what will happen to the child provided with vitamin A-poor food.

**Answer:**

Will suffer from night blindness.

**12.9. 2 Consolidation activities**

1) In human diet are required carbohydrates, proteins, fats, mineral salts and vitamins. Suggest the reasons why humans need the mineral nutrients and vitamins in their daily diet.

**Answer**

The body cannot make them itself while they are very necessary in its functions and processes.

2) Record what you ate yesterday. Decide whether this menu represents a balanced diet. If not plan how it should be changed to make it more nutritious.

**Answer**

Variable depending on one's habit diet.

3) What are differences between macronutrients and trace elements?

**Answer**

- Macronutrient is a type of food such as fat, protein and carbohydrates required in large amounts in the diet. It can also be a chemical element such as potassium, magnesium and calcium required in large amounts of plant growth.
- Traces refer to a chemical element required only in minute amounts by living organisms for normal growth.

**12.9.3 Extended activities**

1) There are two kinds of vitamins, fat-soluble and water-soluble. Explain the advantage of fat-soluble vitamins over water-soluble vitamins.

**Answer**

When they are not used, the excess is stored in body fatty tissues to be used later when they are inadequate in the diet but water-soluble vitamins the non-used by the body, dissolves in water and are excreted with urine.

2) People are advised do not take supplement vitamins and minerals but obtain them directly from the diet. Explain the disadvantage of taking supplement fat-soluble vitamins.

**Answer**

Taking vitamin supplements in capsule, chewable or liquid form is a convenient way to supplement your diet; but you should exceed what you took from the diet and get some distresses. The excess of ascorbic acid (vitamin C) for example, causes gastrointestinal disorders such as nausea, indigestion, stomach cramps, headaches, fatigue, diarrhea and vomiting. No one is allowed to take vitamins or mineral supplement if are not prescribed by a health specialist (doctor, nurse).

3) Calcium is one of the five major minerals required by human body. Explain why pregnant and lactating women require more (1200-1400 mg/day) Calcium than other life stage groups.

**Answer**

Pregnant woman requires more Ca for the development of the embryo skeleton. For a lactating woman to help better growth of bones and teeth formation of the baby.

Suppose you have got the job position and you are in charge of nutritional adviser in your sector. Give a brief account of what you will do to be effective in your job.

**Answer**

Variable depending on the nutritional habit in the sector of each student.

## 13.1 Key unit competence

Describe the mode of action and factors affecting enzymes and their importance for the existence of life.

## 13.2 Prerequisites (knowledge, skills, attitudes and values)

Learners should have the prior knowledge on the definition of a catalyst and its role from the lessons of Chemistry. They should be able to test for starch and reducing sugars such as glucose and maltose. They are also skillful in working in groups and free to make presentations of their findings.

## 13.3 Cross-cutting issues to be addressed

Emphasize on the standardization culture as they learn about the optimum temperature because as beverage and foods are boiled, enzyme are denatured and many pathogens die. However, some bacteria (Archea) can survive on high range of temperature.

Learner should also develop the Peace and Value education, Gender and Inclusive education when work in harmony in groups made of both boys and girls, students with and without disabilities.

## 10.4 Guidance on the introductory activity

Remember that it is not the first time students hear about enzyme. Ask students to briefly brainstorm in pairs why the food is not remaining in its eaten state. Ask them also what causes such change. Why some people become hungry very quickly than other. Based on their ideas, introduce the unit.

	Lesson title	Learning objectives	Number of periods
1	Lesson1: Criteria for naming enzymes.	Define the term enzyme. Explain the criteria of naming enzymes. Acknowledge that enzymes are essential in speeding up reactions that would be too slow to sustain life.	2
2	Lesson2: Characteristics of enzymes	State that enzymes function inside cells and outside cells. Explain that enzymes are globular proteins that catalyse metabolic reactions.	2
3	Lesson3: Mode of action of enzymes.	Describe the mode of action of enzymes in terms of the lock and key and the induced fit hypotheses.	2
4	Lesson4: Factors affecting enzyme action.	Explain factors affecting enzyme activity. Investigate the effects of temperature, pH, enzyme and substrate concentration, and inhibitors on enzyme activity.	2
5	Lesson5: Importance of enzymes in living organisms	Appreciate the importance of planning and carrying out experiments under controlled conditions.	2
6	Lesson6: Enzymes technology	Understand the roles of enzymes in industry and medicine.	2
7	Assessment	Classify fully enzymes and discuss the mode of action and factors affecting enzymes and their importance for the existence of life.	2

### Lesson 1 : Criteria for naming enzymes



This is the first lesson of unit 10 and is a single lesson. This means that it has only one period (40 Minutes). The first lesson also covers the introduction of the whole unit.

### **a) Prerequisites/Revision/Introduction:**

The learners should be able to state some enzymes particularly digestive enzymes such as maltase, sucrase, pepsin and Trypsin and give the role of each. You need therefore to ask question about the names of enzymes they know. You need to write them on chalkboard or white board. You can challenge them by asking to predict criteria used in naming enzymes. From the suggested names and prediction, move to the activity 10.1.

### **b) Teaching resources**

List of digestive enzymes, biology dictionary, internet, textbooks on enzymes nomenclature.

### **c) Learning activity 10**

Facilitate this activity by asking students to work in groups and do analysis of the names that they have suggested and other names that could help you and students to come up with criteria for enzymes nomenclature.

Students to come up with those names, you need to challenge them by asking questions about the similarities and differences that exist in the suggested enzymes.

You may have written those names of enzymes on flipchart so that it may facilitate the learning. Ask them to present what they have done in groups. Use the presented ideas to make a consolidation and come up with a conclusion.

### **Answers for introductory activity**

- 1) Enzymes are biological catalyst produced by a living organism to control the speed of specific biochemical reactions (metabolism) by reducing its activation energy.
- 2) Time and less energy spent
- 3) The temperature of the hot food is more or less close that at body of which the enzymes work optimally.

### **Answers for activity 13.1**

- a) Maltase hydrolyses maltose into glucose – Lactase hydrolyses lactose into glucose and galactose – Dehydrogenase catalyses the removal of hydrogen from a functional group – oxidase catalyses the oxidation of molecules – Pepsin hydrolyse the proteins into polypeptides in the acidic medium in the stomach – renine promotes the coagulation of liquid and soluble casein.
- b) Enzymes are named based on substrate catalyse, type of reaction they catalyse

of by using specific name.

### Answers for self- assessment 13.1

- Put the suffix – ase to the name of the substrate or type of reaction. Some enzyme has specific names e.g. pepsin
- Peptidase is the enzyme that catalyses the hydrolysis of peptide into single amino acids.

## Lesson 2: Characteristics of enzymes

### a) Prerequisites/Revision/Introduction

Remember that students have already learnt about the diagram of energy content (High and lower energy content) and the test for oxygen gas by relighting the glowing splint. Start the lesson by asking the following questions: What is a catalyst?

### b) Teaching resources

Test tubes, match box, liver, sands, 1% H<sub>2</sub>O<sub>2</sub> and MnO<sub>2</sub> powder. Internet, textbooks.

### c) Answers for activity 13.2

Let learners work in small groups. Make sure that they follow the procedure and come out with the following conclusions;

- 1) Both MnO<sub>2</sub> and the liver speed up the rate of reactions by which hydrogen peroxide decomposes into oxygen and water

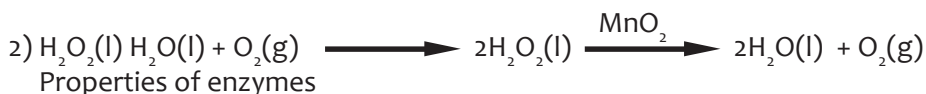

- Enzymes speed up the rate of metabolic reactions.
- Enzymes are protein in nature
- Enzymes lower the activation energy (E<sub>a</sub>) required for reactions to take place.

### Answers for self-assessment 13.2

- 1) Properties of enzymes are the following:
  - Enzymes speed up the rate of metabolic reactions.
  - Enzymes are globular proteins.
  - Enzymes lower the activation energy (E<sub>a</sub>) required for reactions to take place.
  - Enzymes are highly specific in action. Enzyme possesses active sites and

will only catalyze a reaction when the substrate and active site have complementary shapes.

- Enzymes do not change after the reaction. They remain unaltered.
- Chemical reactions catalyzed by enzymes are usually reversible e.g. enzyme carbonic anhydrase catalyses both synthesis and breakdown of carbonic acid.

2) The turnover of an enzyme is the number of reactions an enzyme molecule can catalyse in one second. Enzymes have a high turnover number because they are not altered at the end of the reaction but are capable of attaching to new molecules of substrate.

### **Lesson 3: Mode of action of enzymes**

#### **a) Prerequisites/Revision/Introduction**

Ask students to brainstorm the characteristics of enzymes which include specificity and complementarity like the case of the key and the lock. Connect the learning activity to the brainstormed ideas.

#### **b) Teaching resources**

Key and lock, Manila paper, marker pens, textbooks, internet, and simulation.

#### **c) Learning activity 13.3**

For helping students to come up with understanding as well as skills related to mode of action of an enzyme, you need to:

- Use a simulation on the mode of action of enzymes which has to be observed by students once projected
- Project it and let students watch the video.
- From the video, you ask questions.
- If there is no simulation, provide two different keys in which one opens a class lock while another could not or use at least 2 padlocks with their respective keys and show how they cannot interchange their key.
- Let them practice and ask them why one key opens the lock while another could not. Ask other questions so that students come up with ideas related to mode of action of enzymes.
- Ask students to produce or draw a model on paper or Manila paper and use that chart in explaining the mode of action of enzymes.

#### **Answers for Self- assessment 13.3**

1. The lock represents the enzymes
2. The key represents the substrate
3. The active site is on the cylinder of the lock
4. Another diagram that can better represent the induced fit hypothesis.

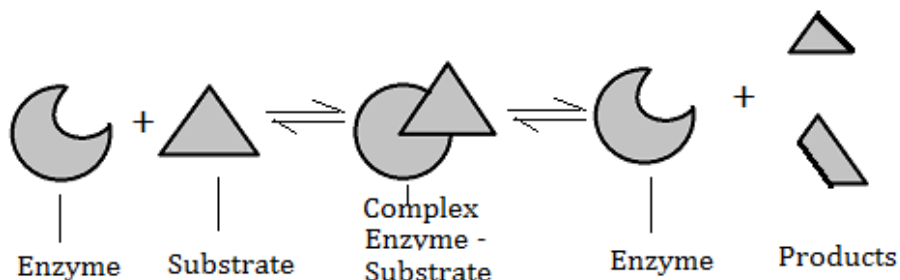

The shape of the substrate is not complementary to that of the active site of the enzyme. But the active site modifies its shape in order to form the complex enzyme-substrate.

### Lesson 4: Factors affecting enzyme action.

#### a) Prerequisites/Revision/Introduction

Ask students to individually brainstorm or to discuss in pairs the analogy of a lift and a stair for bringing about the effect of an enzyme to lower down or to speed up the activation energy. Listen their ideas and build on them towards activity 13.4.

#### b) Teaching resources

Source of heat, test tubes, starch solution, Benedict and Iodine solutions, test tubes, amylase solution, and cold water (ice).

#### c) Learning activity 13.4

To help students to come up with learning outcomes, you are advised to do the following:

- Make different groups and provide the printed handout of the procedure of the experiment.
- Provide the same amount of solution to be used to each group and emphasize on the following the procedure.

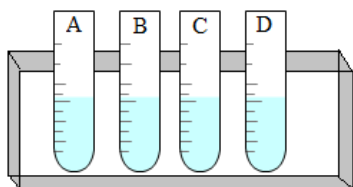

Each group of learners conducts the experiments and record the following observation:

- The solution in tube C has light blue colour because amylase has hydrolysed starch into maltose.
- Solution in tube B and D are deep blue because of the presence of HCl that denatures the enzyme amylase.
- Tube A looks blue because the enzyme amylase was not active under the cold condition.

At the end of the experiment, allow students to read the note on factors affecting the rate of enzyme controlled reactions.

You give them a table having row of temperature and the one of temperatures in degrees, so that they can do analysis and then come up with an explanation and conclusion on Q10. From their conclusion, extend it to questions or explanation about denaturation and end product inhibitor or allosteric inhibitor or allostery.

The teacher helps learners interpret the solution of worked example questions from their textbook.

### Answers of self-assessment 13.4

1) Q<sub>10</sub> is the fact that the rate of the enzyme controlled reaction doubles when the temperature is raised by 10° C

$$2) \quad (a) \quad Q_{10} \text{ at } 0^{\circ} \text{ C} = \frac{\text{Rate of reaction at } (x+10)^{\circ} \text{ C}}{\text{Rate of reaction at } x^{\circ} \text{ C}} = \frac{\text{Rate at } (0+10)^{\circ} \text{ C}}{\text{Rate at } 0^{\circ} \text{ C}} = \frac{\text{Rate at } 10^{\circ} \text{ C}}{\text{Rate at } 0^{\circ} \text{ C}} = \frac{0.1}{0.01} = x \ 10$$

$$(b) \quad Q_{10} \text{ at } 10^{\circ} \text{ C} = \frac{\text{Rate of reaction at } (x+10)^{\circ} \text{ C}}{\text{Rate of reaction at } x^{\circ} \text{ C}} = \frac{\text{Rate at } (10+10)^{\circ} \text{ C}}{\text{Rate at } 10^{\circ} \text{ C}} = \frac{\text{Rate at } 20^{\circ} \text{ C}}{\text{Rate at } 10^{\circ} \text{ C}} = \frac{0.2}{0.1} = x \ 2$$

$$(c) \quad Q_{10} \text{ at } 50^{\circ} \text{ C} = \frac{\text{Rate of reaction at } (x+10)^{\circ} \text{ C}}{\text{Rate of reaction at } x^{\circ} \text{ C}} = \frac{\text{Rate at } (50+10)^{\circ} \text{ C}}{\text{Rate at } 50^{\circ} \text{ C}} = \frac{\text{Rate at } 60^{\circ} \text{ C}}{\text{Rate at } 50^{\circ} \text{ C}} = \frac{0.2}{0.4} = x \ 0.5$$

3) Enzymes more likely to be thermostable/ resistant to Denaturation at high temperatures; processes using these enzymes can be run at high temperature / over a wide range of temperatures.

4) (a) It is the end product inhibition / allosteric inhibition

5) (b) the compound Z acts as allosteric / non-competitive inhibitor

## Lesson 5: Importance of enzymes in living organisms.

### a) Prerequisites/Revision/Introduction

Introduce this lesson by asking students to brainstorm on how enzymes are important in living organism. Build on their ideas and go to the activity 10.5

## **b) Teaching resources**

Books, internet, computer, scenarios etc.

## **c) Learning activity 13.5**

Teacher provides a scenario, books etc. to each pair of students. Ask students to read the scenario and can search for further information from textbooks or internet and afterwards brainstorm reasons of having thousands enzymes in a living organism. Teacher supplements information, challenge students through questions

## **Answers of the activity 13.5**

There are thousands upon thousands of chemical reactions that happen in the body that require enzymes to speed up their rate of reaction, or will never happen. Enzymes are very specific, so nearly each of these chemical reactions has its own enzyme to increase its rate of reaction.

## **Answers for self-assessment 13.5**

- (1) Missing terms: catalysts – living – Activation – proteins – tertiary.
- (2) (a) The main role of enzymes is to speed up the rate of reactions in living organisms
  - (b) If there were no enzymes in the cell, the metabolic reactions would stop and therefore the cell would die
  - (c) Heat increases the motions of molecules and leads to collisions between reactant molecules.

## **Lesson 6: Enzymes technology**

### **a) Prerequisites/Revision/Introduction**

Introduce the lesson by informing students that with advancement in technology, different products are manufactured. Add that, naturally some enzymes are produced like those produced by yeasts in alcoholic fermentation. Also, inform them that enzyme amylase used in school laboratory is not extracted from the human saliva. Ask them to guess if there are some technologies known that are used in enzymes manufacturing. If they know any, allow them to mention some. From the above probing question, go to the learning activity.

### **b) Teaching resources**

Starch solution, enzyme amylase, student textbooks

### **c) Learning activities**

Towards learning objective, guide students how the activity 10.6 should be done as described in students' textbook.

After reading and answering to the questions of activity, ask them to present their findings.

From what they have presented, help students to summarize the lesson through questions. Extend the conclusion of the lesson and attract learners' attention by a concept of being a job creator (financial education) through enzymes technology.

### **a) Answers for self-assessment 13.6**

Refer to the student's book; unit 10 sub-unit 6

### **b) Answers for self-assessment 13.6**

1. Alcohol and ammonium sulphate are used to precipitate the enzyme from a solution
2. High temperatures occur during many industrial processes.

## **13.6 Summary of the unit 13**

- Individual enzymes are named by adding -ase to the name of the substrate with which they react.
- Classification based on the type of reaction catalysed by the enzyme was recommended in 1961 by International Union of Biochemistry (IUB) e.g. ligase, dehydrogenase, etc
- Enzymes are protein in nature. They speed up the rate of the reaction by lowering the activation energy.
- Enzymes have generally high turnover number.
- There are two main hypotheses that explain the mode of action of enzymes: The lock and key hypothesis by Emil Fischer and the induced-fit hypothesis by Daniel Koshland
- Individual enzymes are named by adding -ase to the name of the substrate with which they react.
- Classification based on the type of reaction catalysed by the enzyme was recommended in 1961 by International Union of Biochemistry (IUB) e.g. ligase, dehydrogenase, etc

## **13.7 Additional information**

Enzymes are biocatalysts. They speed up the rate of reactions. They are named according to the type of reaction or type of substrate. Except for some of the originally studied enzymes such as pepsin, rennin, and trypsin, most enzyme names end in "ase". The International Union of Biochemistry (I.U.B.) initiated standards of enzyme

nomenclature which recommend that enzyme names indicate both the substrate acted upon and the type of reaction catalyzed. Under this system, the enzyme uricase is called urate: O<sub>2</sub>oxidoreductase, while the enzyme glutamic oxaloacetic transaminase (GOT) is called L-aspartate: 2-oxoglutarate aminotransferase. Each of the six main categories holds the following subcategories.

## Oxidoreductases

- EC 1.1 includes oxidoreductases that act on the CH-OH group of donors (alcohol oxidoreductases)
- EC 1.2 includes oxidoreductases that act on the aldehyde or oxo group of donors
- EC 1.3 includes oxidoreductases that act on the CH-CH group of donors (CH-CH oxidoreductases)
- EC 1.4 includes oxidoreductases that act on the CH-NH<sub>2</sub> group of donors (Amino acid oxidoreductases, Monoamine oxidase)
- EC 1.5 includes oxidoreductases that act on CH-NH group of donors
- EC 1.6 includes oxidoreductases that act on NADH or NADPH
- EC 1.7 includes oxidoreductases that act on other nitrogenous compounds as donors
- EC 1.8 includes oxidoreductases that act on a sulfur group of donors
- EC 1.9 includes oxidoreductases that act on a heme group of donors
- EC 1.10 includes oxidoreductases that act on diphenols and related substances as donors
- EC 1.11 includes oxidoreductases that act on peroxide as an acceptor (peroxidases)
- EC 1.12 includes oxidoreductases that act on hydrogen as donors
- EC 1.13 includes oxidoreductases that act on single donors with incorporation of molecular oxygen (oxygenases)
- EC 1.14 includes oxidoreductases that act on paired donors with incorporation of molecular oxygen
- EC 1.15 includes oxidoreductases that act on superoxide radicals as acceptors
- EC 1.16 includes oxidoreductases that oxidize metal ions
- EC 1.17 includes oxidoreductases that act on CH or CH<sub>2</sub> groups
- EC 1.18 includes oxidoreductases that act on iron-sulfur proteins as donors
- EC 1.19 includes oxidoreductases that act on reduced flavodoxin as a donor
- EC 1.20 includes oxidoreductases that act on phosphorus or arsenic in donors
- EC 1.21 includes oxidoreductases that act on X-H and Y-H to form an X-Y bond



- EC 1.97 includes other oxidoreductases

## Transferases

- EC 2.1 includes enzymes that transfer one-carbon groups (methyltransferase)
- EC 2.2 includes enzymes that transfer aldehyde or ketone groups
- EC 2.3 includes acyltransferases
- EC 2.4 includes glycosyltransferases
- EC 2.5 includes enzymes that transfer alkyl or aryl groups, other than methyl groups
- EC 2.6 includes enzymes that transfer nitrogenous groups (transaminase)
- EC 2.7 includes enzymes that transfer phosphorus-containing groups (phosphotransferase, including polymerase and kinase)
- EC 2.8 includes enzymes that transfer sulfur-containing groups (sulfurtransferase and sulfotransferase)
- EC 2.9 includes enzymes that transfer selenium-containing groups

## Hydrolases

- EC 3.1: ester bonds  
(esterases: nucleases, phosphodiesterases, lipase, phosphatase)
- EC 3.2.22: sugars (DNA glycosylases, glycoside hydrolase)
- EC 3.3: ether bonds
- EC 3.4: peptide bonds (Proteases/peptidases)
- EC 3.5: carbon-nitrogen bonds, other than peptide bonds
- EC 3.6 acid anhydrides (acid anhydride hydrolases, including helicases and GTPase)
- EC 3.7 carbon-carbon bonds
- EC 3.8 halide bonds
- EC 3.9: phosphorus-nitrogen bonds
- EC 3.10: sulfur-nitrogen bonds
- EC 3.11: carbon-phosphorus bonds
- EC 3.12: sulfur-sulfur bonds
- EC 3.13: carbon-sulfur bonds

## Lyases

- EC 4.1 includes lyases that cleave carbon-carbon bonds, such as decarboxylases (EC 4.1.1), aldehyde lyases (EC 4.1.2), oxo acid lyases (EC 4.1.3) and others (EC 4.1.99)

- EC 4.2 includes lyases that cleave carbon-oxygen bonds, such as dehydratases
- EC 4.3 includes lyases that cleave carbon-nitrogen bonds
- EC 4.4 includes lyases that cleave carbon-sulfur bonds
- EC 4.5 includes lyases that cleave carbon-halide bonds
- EC 4.6 includes lyases that cleave phosphorus-oxygen bonds, such as adenylate cyclase and guanylate cyclase
- EC 4.99 includes other lyases, such as ferrochelatase

## Isomerases

- EC 5.1 includes enzymes that catalyze racemization (racemases) and epimerization (epimerases)
- EC 5.2 includes enzymes that catalyze the isomerization of geometric isomers (cis-trans isomerases)
- EC 5.3 includes intramolecular oxidoreductases
- EC 5.4 includes intramolecular transferases (mutases)
- EC 5.5 includes intramolecular lyases
- EC 5.99 includes other isomerases (including topoisomerases)

## Ligases

- EC 6.1 includes ligases used to form carbon-oxygen bonds
- EC 6.2 includes ligases used to form carbon-sulfur bonds
- EC 6.3 includes ligases used to form carbon-nitrogen bonds (including argininosuccinate synthetase)
- EC 6.4 includes ligases used to form carbon-carbon bonds
- EC 6.5 includes ligases used to form phosphoric ester bonds
- EC 6.6 includes ligases used to form nitrogen-metal bonds

Enzymes have different optimum pH. This is why the two proteases pepsin and Trypsin work on the protein but the first at low pH in the stomach, which the second one work at high pH in the duodenum.

The induced – fit theory of enzyme action is a modified version of the lock – and – key theory. It does not depend on such precise contact being made between the substrate and the active site. In this model, the active site is able to change its shape to enfold a substrate molecule. The enzyme takes up its most effective catalytic shape after binding with the substrate, just as the shape of glove is effective by the hand wearing it.

An enzyme allows the reaction to go through a more stable transition state than would normally be the case. As a result, the rate of reaction is increased.

An **allosteric binding site** is separate from the active site. When it is occupied by a ligand, it undergoes an induced fit which affects the shape of the active site. This will affect the ability of the active site to 'recognise' the substrate and hence affect enzyme activity.

Both the active site and **allosteric binding site** are likely to contain amino acids with aliphatic side chains, some of which may be important to the binding process. The ability of a binding site to accept a wide variety of differently shaped molecules will vary depending on the specific binding site involved.

### 13.8 Answers for End unit assessment 10

4) The following are the answers:

a) The following are the explanations:

(i) A catalyst is a substance that increases the rate at which reactions take place but does not get involved in the reaction and is reused many times. Catalysts are used in industrial processes and are found in living organisms.

(ii) The lock and key means that the active site of the enzyme has a specific shape as that of a lock and the shape of the substrate can fit in as a specific key in its lock.

(iii) Activation energy is the energy required by molecules to start a reaction.

(iv)  $Q_{10}$  means the rate of a reactions doubles for every  $10^{\circ}\text{C}$  increase in temperature, up to the optimum temperature.

b) There are hundreds of different enzymes in our cells because of hundreds of different reactions taking place in cell, each enzyme only catalyses one reaction.

c) Enzymes hold the substrate in such a way as to allow them to react more easily at lower temperature than usual.

4) The following are the answers:

a) Enzyme work faster at high temperature because the heat energy provides molecules with energy; the more heat the faster the molecules move around; more likely that a substrate will bump into an enzyme; increasing temperatures, increase the rate of reactions up to a maximum point called the optimum temperature.

b) High temperatures provide so much energy that the atoms making up the enzyme vibrate; the bonds to break down; the enzyme loses its globular shape (its tertiary structure) and becomes denatured. However, a few bacterial enzymes found in hot springs and the industrial are temperature-resistant.

c) The number of  $\text{H}^+$  or  $\text{OH}^-$  ions in a solution affects the distribution of charges over the surface of the enzyme. The pH affects the ionisation of side chain in amino acid residues and affects the hydrogen bonds and di-sulphur bridges which hold the enzyme in 3D shape. Extremes of pH denature the enzyme.

- d) Enzymes catalyze different reactions and are found in different cellular environments; for example, extra-cellular digestive enzymes have to be able to work in acidic or alkaline conditions in the stomach or intestine respectively. In addition, each enzyme has a different combination of amino acid side chains.
- e) Differences between reversible and irreversible enzyme inhibitors:

Reversible enzyme inhibitor	Irreversible enzyme inhibitor
Binds loosely to the enzyme and reduces its activity	Binds permanently to enzyme
Can be removed without permanent damage	Once removed from the enzyme, it causes permanent damage.
Inhibition can be reduced when the concentration of correct substrate is increased.	Inhibition cannot be reduced by the increase of concentration of correct substrate.
e.g. malonate inhibits the enzyme succinate dehydrogenase (in Krebs' cycle)	e.g. Arsenic and cyanide permanently damage respiratory enzymes.

5) They have optimum temperatures of up to 90°C. They can be used in reactions where high temperatures are involved. They are stable at high temperatures so can be re-used many times.

6) The following are the answers:

a) I plot the curve

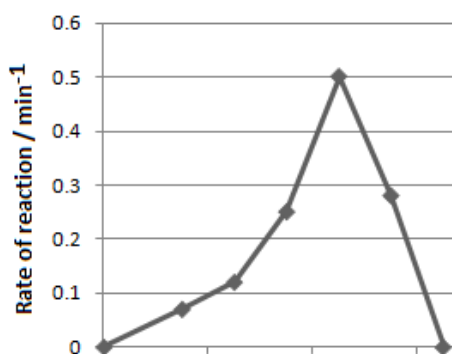

b) The optimum temperature is 45°C

c) The rate of the reaction is increasing with temperature / linear increase; rate doubles with every 10°C increase in temperature; reference to Q10.

d) Rate at 20°C is 0.1, rate at 30°C is 0.2; Rate of increase is 0.1/10°C or 0.01 per °C

7) Answers are summarized in the following table:

a) I complete the table and the plot the curve

Temperature / °C	Mass lost by reactants /mg	Rate of reaction = mass lost : temperature
10	5	0.5
20	10	0.5
30	40	1.3
40	80	2.0
50	20	0.4

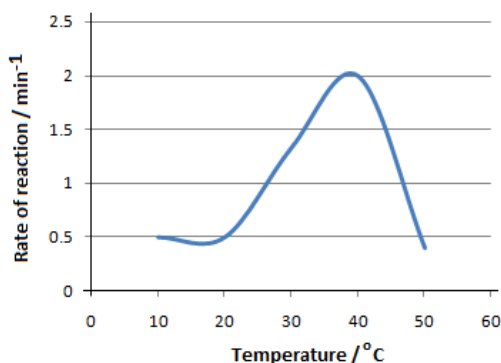

$$b) Q_{10} \text{ at } 30^{\circ}\text{C} = \frac{\text{Rate at } (30+10)\text{C}}{\text{Rate at } 30\text{C}} = \frac{\text{Rate at } 40}{\text{Rate at } 30\text{C}} = \frac{2.0}{1.333} = 1.5 \times$$

c) Between 20 and 30°C the rate of the reaction increases exponentially because the increasing temperature is giving energy to enzyme molecules but between 40 and 50°C the rate of the reaction is decreasing as the excessive heat is denaturing the enzyme which loses its globular shape/its tertiary structure.

b) The answers are:

a) Proteins

b) Linear increase in activity between pH=4-7. Calculation of the percentage increase in activity with each pH unit; reaches optimum / Peak at pH = 7.8-8.0; activity remains high until pH=9; then activity decreases; decrease in activity not as steep as the increase in the activity.

c) Increase in activity is less steep; enzyme activity over greater range of pH values; maximum activity over 4 pH units, which is much larger than obtained for human digestive enzymes.

9) The steps are the followings:

- A specific gene is introduced in the DNA of a given bacteria
- Bacteria are cultivated in a specific medium

- Enzyme is precipitated by alcohol or ammonium sulphate
- Enzyme is extracted by chromatography or electrophoresis.

## 13.9 Additional activities

### 13.9.1 Remedial activities

1) What do you understand by enzyme peptidase?

**Answer:**

Peptidase is the enzyme that hydrolyses the breakdown of peptide into amino acids.

2) What characteristic among the following does not describe enzymes?

- A Enzymes speed up the rate of reaction
- B Enzymes lower down the activation energy
- C Enzymes provide a reaction surface for a reaction to take place
- D Enzymes are hydrophilic in nature.

**Answer: A**

3) Which of the following statements is not true regarding the active site of an enzyme?

- A An active site is normally a hollow or cleft on the surface of an enzyme.
- B An active site is normally hydrophilic in nature
- C Substrates fit into active sites and bind to functional groups within the active site.
- D An active site contains amino acids which are important to the binding process and the catalytic mechanism.

**Answer: B**

4) What will happen to the rate of the enzyme controlled reaction if the temperature passes from 15°C to 25°C?

**Answers**

The rate of the reaction will double because the temperature increases by 10°C from 15°C to 25°C

5) What is meant by the end-product inhibition?

**Answers**

The end product inhibition is when the end product comes to fit in the active site of the enzyme and therefore prevents the enzyme from binding to another substrate.

6) Answer by True or False:

- A A single enzyme catalyses only a specific reaction or a closely related group of reactions
- B A single enzyme can catalyse the breakdown of several molecules of different natures
- C An enzyme can speed up or slowdown the rate of reaction
- D There are thousands of enzymes because each reaction requires its optimum conditions and its specific enzyme
- E Digestive enzymes are found in the saliva, gastric juice, pancreatic juice and the bile

**Answers:**

A. True      B. False      C. False      D. True      E. False

7) Why does an enzyme catalyse only a specific reaction or a closely related group of reactions?

**Answer**

Enzyme can only catalyse reactions in which the substrate shape fits that of its active site.

8) Differentiate between intracellular and extracellular enzymes

**Answer**

An intracellular enzyme is produced inside a microorganism while an extracellular enzyme is excreted by an organism.

### 13.9.2 Consolidated activities

Use the Excel program to draw the curve of the rate of enzyme controlled reaction from the data bellow.

Temperature / °C	0	10	20	30	40	50	60	70	80
Rate of the reaction	0.05	0.1	0.2	0.4	0.8	1.6	0.8	0.2	0.05

**Answer:**

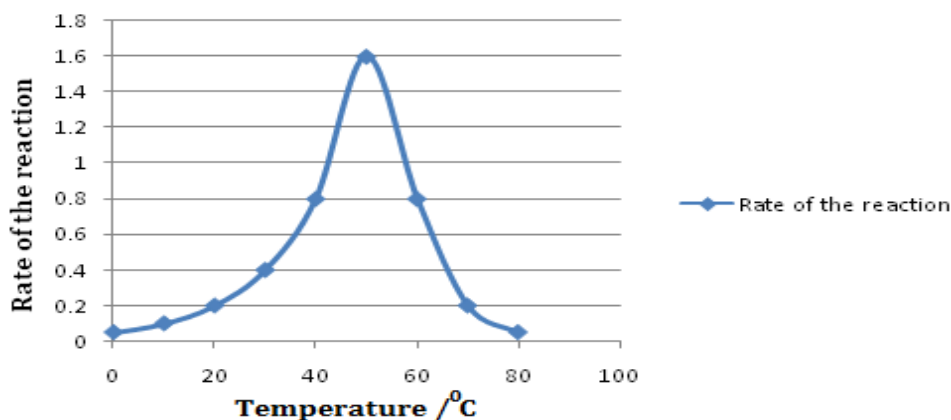

2) What do you understand by the turnover of an enzyme controlled reaction?

**Answer**

The turnover number of an enzyme is the number of reactions an enzyme molecule can catalyse in one second.

3) What is the difference between key-and-lock theory and fit induced theory?

**Answer**

In key-and-lock theory the shape of active site is complementary to that of the substrate whilst in the fit induced theory, the shape of the active site is not complementary to that of the substrate but is modified.

4) Only enzyme amylase and simple materials such as the sauce pans, empty 1.5L plastic bottles are required to carry out this activity on effect of amylase. The source of starch can maize or cassava flour, or boiled Irish potatoes.

- Boil 100g of starch in 5L of mineral water in clean a saucepan.
- Cover the saucepan and then let the mixture cool down
- Put 1L of the starch solution in each of the 4 empty and clean bottles labeled A – D.
- Put 0g – 0.1g – 0.5g and 1g of amylase powder on bottles A – D respectively.
- Shake the mixture in each bottle and then divide each into two bottles A1 and A2, B1 and B2, C1 and C2, and D1 and D2.
- Keep bottles A1 – D1 in cold conditions but A2 – D2 in warm conditions.
- After 24 hours, pipette 2 ml from each bottle which you mix with 1ml of Benedict's solution.



- Boil the samples from A1 and A2 at the same time for 1minute, then B1 and B2, C1 and C2 and finally D1 and D2.
- Record your observation and draw a conclusion.

### Answer

- There is no reducing sugar in the bottles A1 and A2 but much reducing sugar in bottle D2. Mixtures in bottles A1 and A2 served as control.
- Bottles B1, C1 and D1 have lesser reducing sugars than the bottles B2, C2 and D2.
- The enzyme amylase hydrolyzed the starch into maltose, a reducing sugar. The rate of the reaction was expressed in term of the concentration of reducing sugar in the solution.

The rate of reaction depended on the concentration of the enzyme and the temperature.

5) Ptyalin is the specific name of the salivary amylase. What is the role of ptyalin?

### Answer

Ptyalin hydrolyses the large molecules of starch into small molecules of maltose

6) Make research on the applications of enzymes is industrial processes.

### Answer

Application	Enzymes	Uses
Biological detergents	Lipase , Protease, Amylase	Use in washing powders and dishwashers to digest and break down fats, proteins and starch
	Thermostable enzymes isolated from thermophilic bacteria have been isolated and produced by genetic engineering to function over a wide range of temperature	
	Cellulase	To digest the loose damaged cellulose microfibrils, soften and brighten coloured cotton fabrics
Dairy products	Renin (from stomachs of calves) Chymosin enzymes (generally engineered from E. coli)	To coagulate milk proteins in the manufacture of cheese
	Immobilized enzyme lactase	Production of lactose-free milk

### 13.9.3 Extended activities

1. Make research on the enzyme called Alcohol dehydrogenases (ADH) and get ready to present your finding.

**Answer:** Alcohol dehydrogenases (ADH) are a group of dehydrogenase enzymes that occur in many organisms and facilitate the interconversion between alcohols and aldehydes or ketones with the reduction of nicotinamide adenine dinucleotide (NAD<sup>+</sup> to NADH). In humans and many other animals, they serve to break down alcohols that otherwise are toxic, and they also participate in generation of useful aldehyde, ketone, or alcohol groups during biosynthesis of various metabolites. In yeast, plants, and many bacteria, some alcohol dehydrogenases catalyze the opposite reaction as part of fermentation to ensure a constant supply of NAD<sup>+</sup>

2. Suggest how you would set an experiment to show that enzyme speed the rate of reaction

**Answer:** Set a control solution and a treated solution with an enzyme. Allow time for the experiment to take place. Compare both solutions at the same interval of time. Draw your conclusion.

3. Use the modelling/ natural clay or plasticine to design models of key –and-lock theory and fit induced theory

**Answer:** (Provide the modeling clay and allow learners to improvise their models which shall have the Enzyme – the active site – the substrate)

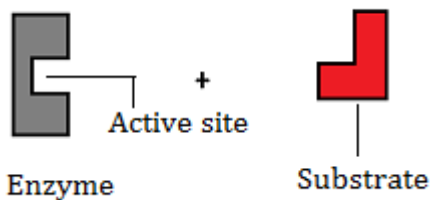

4. Plan to take students for a field trip to nearest industry that use enzyme to make their products (e.g. Bralirwa, Inyange etc)
5. It was found that both pepsin and Trypsin play the same role of breaking down protein into polypeptides. What is the relevance of having both pepsin and Trypsin?

**Answer:**

Pepsin and Trypsin amylases are useful because:

- Pepsin works in acid medium (pH = 2) while Trypsin requires a basic medium (pH = 8.2)
- There are large amounts of proteins in our diets. Pepsin alone would not enough to carry out such an activity

- If pepsin suffers end product inhibition, Trypsin will come up.
6. You can plan for a field trip to a nearest industry making dairy product and ask students to record and present their observations using the following guiding questions:
- a) What enzyme is used?
  - b) What is the maximum temperature?
  - c) How standard is the process?



## 14.1 Key Unit Competence

Explain the principles of gaseous exchange systems

## 14.2 Prerequisites (knowledge, skills, attitudes and values)

Learners should have the prior knowledge on characteristics of living things especially the respiration. All aerobic organisms need oxygen and each has a specialized respiratory organ whereby fish use gills but other vertebrates use lungs in gaseous exchange. They need also to be able to apply formulae to calculate the area and volume of an object such as cube and sphere.

## 14.3 Cross-cutting issues to be addressed

One of the most cross cutting issue to be addressed by this unit is financial education. This will be addressed when a teacher speaks about the tobacco. People waste money for cigarettes which instead of being beneficial to humans is just causing health problems.

## 14.4 Guidance on the introductory activity

The unit is introduced with the case study of Kalisa and Uwase's fish which is in introductory activity 14. Brainstorm what do you think to be the cause of death of that fish on the third day? Did you also think what could happen to people who smoke? Extend the case and then ask them to predict what will happen to people who smoke. Value what has been brainstormed and introduce the whole unit.

## Expected answers to the introductory activity

The fish died from shortage of oxygen and relate to the students' book

## 14.5 List of lessons/sub-heading

	Lesson title	Learning objectives	Number of lessons
1	Lesson1: Relationship between size and surface area to volume ratio.	Explain the relationship between size and surface area to volume ratio.	1
2	Lesson2: Modifications of gaseous exchange surfaces to speed up diffusion	Describe how different respiratory surfaces are modified to speed up the diffusion  Appreciate the evolution of gaseous exchange surfaces from simple to complex.  Dissect fish gills and observe the surface area for gas exchange.  Observe mammal's lungs and state their adaptation for gaseous exchange.	2
3	Lesson3: Characteristics of gaseous exchange surfaces.	State the characteristics of gaseous exchange surfaces.  Observe prepared slides of gaseous exchange surfaces and identify their characteristics.	1
4	Lesson4: Smoking and related risks.	Describe the effects of tar and carcinogens in tobacco smoke on the gas exchange system with reference to lung cancer and Chronic Obstructive Pulmonary Disease (COPD).  Describe the short-term effects of nicotine and carbon monoxide on the cardiovascular system.	2
5	Assessment	Explain the principles of gaseous exchange systems and diseases that impair these	1

## Lesson 1: Relationship between size and surface area to volume ratio

As this is the first lesson in this unit, within this lesson, the introduction of the entire unit is to be done in a period of this lesson.

### a) Prerequisites/Revision/Introduction:

The learners should be able to calculate the surface area and the volume of a given object but emphasize on spherical objects because they reflect the shape of alveolus. The surface area for cube is  $A=6S^2$  and its volume  $V= S^3$ . The surface area of a sphere is calculated by  $A= 4\pi^2$  and its Volume by:  $V = \frac{4\pi^3}{3}$

### b) Teaching resources

Manila papers, calculators, rulers,

### c) Learning activities

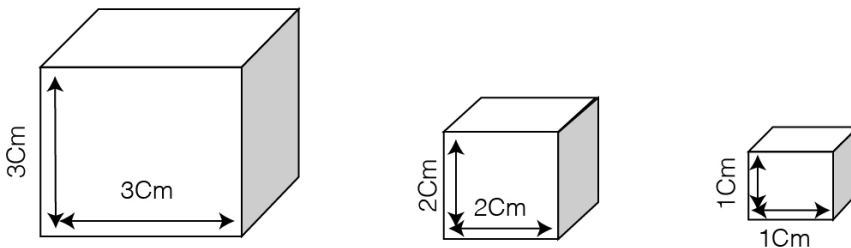

e surface  
sion that

a) Remember that for a cube, Area  $A=6S^2$  and its volume  $V= S^3$  (You better use the excel software to calculate)

Side mm	Area (A)	Volume (V)	A to V ratio
3	54	27	2
2	24	8	3
1	6	1	6

Conclusion as the size increase the volume also increases but the surface area to volume ratio decreases.

b) The surface area of a sphere is calculated by  $A=$  and its Volume by:  $V =$

Radius/ mm	Area (A)	Volume (V)	A to V ratio
3	113.04	113.04	1
1	12.56	4.2	3

2) The surface area to volume ratio is the relationship between the volume of an organ and its volume.

### **Answers for self- assessment 14.1**

1) The surface area to the volume ratio gets smaller as the cell or animal gets larger. Thus, if the cell grows beyond a certain limit, not enough material will be able to cross the membrane fast enough to accommodate the increased cellular volume. The volume of the cell will be so large that the diffusion rate will be too low to distribute necessary substances throughout the cell within a reasonable time. This brings about the need of having a mechanism of ventilation that speeds up the rate of gaseous exchange.

### **Lesson 2 :Modifications of gas exchange surfaces to speed up diffusion**

#### **a) Prerequisites/Revision/Introduction**

Knowledge, skills and attitudes related to dissection, observation and identification are needed for students.

#### **b) Teaching resources**

Fish – Guinea pig (rat or rabbit) – Insect – razor blade – dissecting dish – Hand lens

#### **c) Learning activity 14.2**

You are requested to do the following so that students will develop competences related to this lesson. Facilitate the dissection of fish and mammals. Provide the hand-outs of diagrams of respiratory systems of insects, fish and Mammal. If the school has microscope and prepared slide, students would rather complete their live observation with the microscopic observation. Students work in group and brainstorm their findings.

#### **Activity 14.2**

Observations:

- The gills and the lungs have blood capillaries; they are moist and have a large surface area.
- There are some small pores on the surface of the body of insects. These are known as spiracles. A fish has gills below the operculum. Each gill is made of thousands of tiny filaments that are in contact with water.



- The structure of the gas exchange system in insects

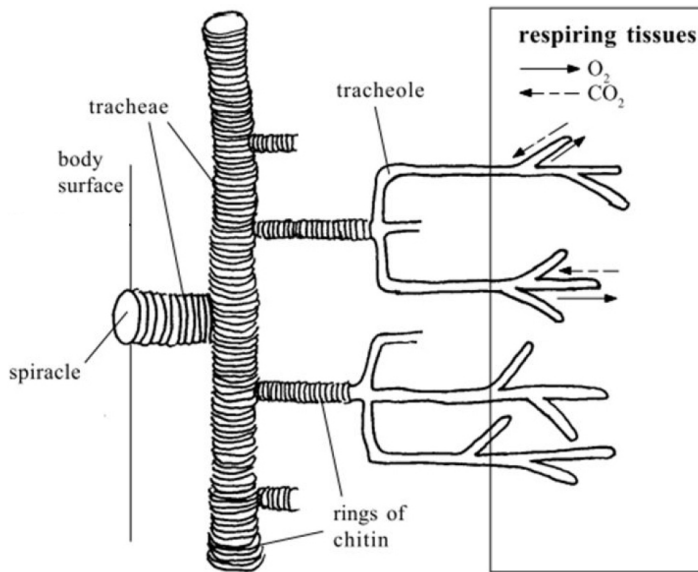

### Answers for activity 14.2

### Answers for self-assessment 14.2

#### 1) Adaptations of gills:

- The gills provide a large surface area to volume ratio
- The gills are very thin
- There is a high concentration gradient between blood in the gills and water passing over them

#### 2) Nasal cavity – pharynx – trachea – bronchi – bronchioles – alveoli

3) The skin would not provide a sufficient large surface area for gas exchange, and gaseous exchange through the skin would also result in excessive water loss.

## Lesson 3: Characteristics of gas exchange surfaces

### a) Prerequisites/Revision/Introduction

Students should have skills of conducting research from the internet or from the textbook. They should be able to summarize information in few paragraphs.

## **b) Teaching resources**

Internet and textbooks

## **c) Learning activity 14.3**

Tell students to work in groups and orient them on the source of information.

You can provide textbook or bring students in the smart computer laboratory to carry out the research. Invite them to make a report of what they have read and acquired from the reading resource.

## **Answers for self- assessment 14.3**

1) Characteristic features of respiratory surface areas common to all living organisms (unicellular and multicellular, plants and animals) are the following:

- Large surface area
- Thin surface or thin wall
- Moist surfaces area
- High diffusion deficit / concentration gradient

2) The following features of a respiratory surface helps gaseous exchange because:

- a) A good blood supply makes gases diffuse into the blood and is carried to and from the body cells.
- b) Protection in order to avoid injuries or damage of delicate organs such as the gills or the lungs involved in gaseous exchange.
- c) A thin surface to enable quick diffusions of gases.

## **Lesson 4 : Smoking and related risks**

### **a) Prerequisites/Revision/Introduction**

Introduce the lesson by asking students to brainstorm the risks associated to smoking as they may experience them. They may report that many people have the habit of smoking tobacco. Smokers have more risks of tuberculosis and cancer. Based on their ideas, move to the activity 14.4 given in student textbook.

### **b) Teaching resources for lesson**

Source of heat, test tubes, starch solution, Benedict and Iodine solutions, test tubes, amylase solution, and cold water (ice)

### c) Learning activity for lesson 14.4

Sensitize students to find diagram or picture of lungs attached by tuberculosis. If there is no if there is no network, use the suggested diagrams of individuals A and B in activity 14.4.

Ask questions about the person who suffer from tuberculosis and why? Don't argue with them who might argue that both individuals seem to be sick but emphasize to the one who looks more affected? The answer to that question should be the individual B because of the granules appearing in the lungs.

To the second question, allow some time to students read the short term and long term effects of smoking. This requires a discussion in order to focus on the change of attitude and values. You expect them to shown their concern about smoking.

### Answers of self- assessment for lesson 14.4

1) Both the parent and the baby suffer from tobacco smoke. The parent is consuming the tar, the nicotine and CO. the baby does not consume all these components in the cigarette by the immune system of the baby is still weak to protect it against the adversities of the smoke.

- The list of consequences will be generated from the notes in the students' book. They include the short term and long term consequences such as:
- Tar paralyses the cilia which remove dirt and bacteria; the accumulation of extra material in the air passage can restrict air flow.
- Smoke acts as an irritant; this causes secretion of excess mucus from goblet cells and excess fluid into the airways, making it more difficult for the air to pass through them.
- Mucus accumulating in the alveoli limits the air that they can contain and lengthens the diffusion pathway.
- Coughing of many smokers, way of trying to remove the build-up of mucus from the lungs, can cause damage to the airways and alveoli; scar tissue builds up which again reduces air movement and rates of diffusion
- Infections arise because the cilia no longer remove mucus and pathogens
- Bronchitis: Bronchitis is inflammation of the lining of the air passages and may be acute or chronic.
- Emphysema: One in every five smokers will develop the crippling lung disease called emphysema i.e. condition of gradual breakdown of the thin wall of the alveoli leading to sensation of breathlessness as the gaseous exchange reduces.
- Lung cancer: Lung cancer usually starts in the epithelium of the bronchioles

and then spreads throughout the lungs as dividing cells cease to respond to the normal signals around them and form unspecialized masses of cells called tumours. The tar in the smoke is carcinogenic i.e. contains chemicals which cause cancer. The irritation causes thickening of the epithelium by extra cell division and this may trigger the cancer. Almost all people who die from lung cancer are smokers

2) Students will design several sign posters and the teacher will appreciate and encourage them.

For example



## 14.6 Summary of unit

All aerobic organisms must obtain regular supplies of oxygen from their environment and return to it the waste gas carbon dioxide. The movement of these gases between the organism and its environment is called gaseous exchange.

Gaseous exchange always occurs by diffusion over part or the entire body surface. This is called a respiratory surface and in order to maintain the maximum possible rate of diffusion respiratory surfaces have a number of characteristics such as large surface area to volume ration, permeability, thin, moist, efficient transport system.

For insect, diffusion of gases over the whole body surface is done through spiracles. Fish use the gills while other chordates use the lungs.

## 14.7 Additional information

### a) Emphysema

Emphysema is a lung condition that causes shortness of breath. In people with emphysema, the air sacs in the lungs (alveoli) are damaged. Over time, the inner walls of the air sacs weaken and rupture — creating larger air spaces instead of many small ones. This reduces the surface area of the lungs and, in turn, the amount of oxygen that reaches your bloodstream.

When you exhale, the damaged alveoli don't work properly and old air becomes trapped, leaving no room for fresh, oxygen-rich air to enter.

Most people with emphysema also have chronic bronchitis. Chronic bronchitis is inflammation of the tubes that carry air to your lungs (bronchial tubes), which leads to a persistent cough.

You can have emphysema for many years without noticing any signs or symptoms. The main symptom of emphysema is shortness of breath, which usually begins gradually.

You may start avoiding activities that cause you to be short of breath, so the symptom doesn't become a problem until it starts interfering with daily tasks. Emphysema eventually causes shortness of breath even while you're at rest.

You need to see your doctor if you've had unexplained shortness of breath for several months, especially if it's getting worse or it's interfering with your daily activities. Don't ignore it by telling yourself it's because you're aging or out of shape. Seek immediate medical attention if:

- You're so short of breath, you can't climb stairs
- Your lips or fingernails turn blue or gray with exertion
- You're not mentally alert

## b) Cutaneous respiration

**Cutaneous respiration** is a form of **respiration** in which gas exchange occurs across the **skin** or outer integument of an organism rather than gills or lungs. **Cutaneous respiration** may be the sole method of gas exchange, or may accompany other forms, such as ventilation.

Because of their dependence on water, many amphibians have retained the traits of their ancestors, including reduced or even absent lungs. Many rely on breathing through the skin, cutaneous respiration, for some or their entire oxygen intake, and especially for carbon dioxide output.

The trait of cutaneous respiration is present in all three groups of amphibians: **Caudata** (salamanders and newts), **Anura** (frogs and toads), and **Caecilians** (uniquely legless amphibians).

Cutaneous respiration occurs by way of **countercurrent** exchange, where blood circulating through the skin flows in the opposite direction of the absorbing oxygen or surrounding water. Think of countercurrent exchange as two pipes pressed parallel together, with water flowing through at the same speed. Water in one tube is hot, and flows one direction, and water in the other tube is cold, flowing in the opposite (counter) direction. If the tubes are made of conductive material, like metal, and contact one another, heat will pass across one tube to the other.

This is similar to **crosscurrent** exchange; which bird lungs use to pick up oxygen. Blood capillaries branch across an air capillary at right angles, almost as if they were wrapped around one another. In contrast, our own lungs also pass carbon dioxide and oxygen between blood capillaries and in the tiny spaces in our lungs, but this transfer is across a gradient.

It might sound like leaving the water in the first place was an evolutionary gamble. Why did organisms adapt to live on land? And how did organisms such as amphibians keep both adaptations simultaneously?

Lungs allow a direct gas exchange with a greatly increased surface area, where oxygen and carbon dioxide are exchanged into and out of the bloodstream across grape-like pockets known as **alveoli**, or larger pockets called **faveoli** in amphibians. This adaptation allowed vertebrates to fully take on the transition to land, to develop thicker and drier skins, and to colonize areas far from water sources. Despite this, cutaneous respiration still persists in amphibians. Now let's look at some of the advantages and disadvantages of skin breathing, across the evolutionary history of vertebrates.

Embryonic vertebrate animals already exchange respiratory gases through the thin, skin-like membrane that surrounds them. But by the time they mature and are born, organisms like reptiles, birds, and mammals carry out relatively little gas exchange across the skin. This is not so in amphibians.

## 14.8 Answers for End unit assessment

1) – (D)      (2) – (E)      (3) – (B)      (4) – (C)      (5) – (A)

2) Adaptations for gaseous exchange in the lungs.

- The alveoli provide a **large surface area** for gaseous exchange
- The surfaces of the alveoli are moist for gases to dissolve before diffusion can occur
- Surfactant cells (septal cells) secrete **surfactant** (a phospholipid). This allows the surface tension of the fluid lining the inner surface of alveolus and speeds up gaseous exchange
- The alveoli have **thin** walls (on cell thick) which minimize the distance for gas diffusion
- The walls are **permeable** to diffusion of oxygen and carbon dioxide
- The alveoli are surrounded by numerous blood capillaries, which bring carbon dioxide for diffusion into the alveoli and carry away oxygen to the circulatory system
- A good **ventilation** system provides a constant supply of oxygen to the alveoli and removes carbon dioxide
- **Stretch receptors** in the lungs help to initiate the breathing relax
- **Elastic** fibers in the lungs permit optimum extension during inspiration.

3) The following are the answers:

a) When an individual suffers from Emphysema there is a gradual breakdown of the thin walls of the alveoli, decreasing the total surface area for gaseous exchange.

b) In people with emphysema, the air sacs in the lungs (alveoli) are damaged. Over time, the inner walls of the air sacs weaken and rupture — creating larger air spaces instead of many small ones. This reduces the surface area of the lungs and, in turn, the amount of oxygen that reaches the bloodstream.

c)

- Gills are efficient respiratory surface areas because:
- They provide a large surface area to volume ratio
- They are very thin to allow diffusion
- They maintain a high concentration gradient between the blood in the gills and the water passing over them

d)

- (a) **Similarities** between respiratory surface area in the fish and in the mammals
- Both have a large surface area
- Both have blood capillary network
- Both have thin wall

Differences between respiratory surface area in the fish and in the mammals

Fish	Mammals
Use gills	Use lungs
Adapted for gas exchange in water	Adapted for gas exchange in air
Unit structures for gas exchanges are gill filaments	Unit structures for gas exchange are alveoli
High affinity to oxygen	Lower affinity to oxygen

e) Tobacco smoke contains a number of carcinogens i.e. substances that cause cancer. These cause mutations that lead to uncontrolled mitosis and formation of tumours.

The tar in the smoke is also carcinogenic. The irritation causes thickening of the epithelium by extra cell division and this may trigger the cancer. Almost all people who die from lung cancer are smokers.

f) The diagram they will design will look like the following:

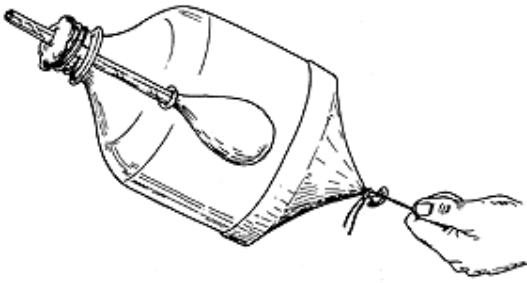

## 14.9 Additional activities

### 14.9.1 Remedial activity

1) Between an elephant and a rat which animal is expected to have a big surface area to volume? Why?

**Answer:**

It is the rat because the smaller the volume the bigger the surface area to volume ratio.

2) The diagram below shows the respiratory system in a human. Label the structures A – G.

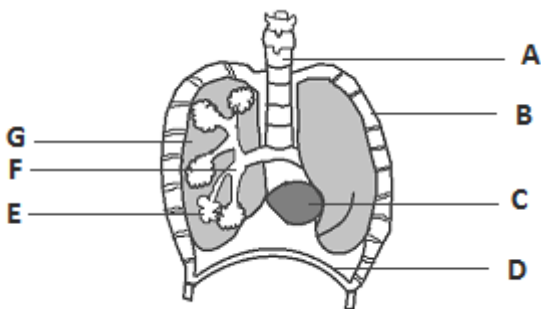

**Answer:**

A – trachea; B – rib; C – heart; D – Diaphragm; E – Alveolus; F – Bronchus; G – bronchiole.

3) List the adaptations of alveoli that make them suitable for gaseous exchange.

**Answer:**

Well ventilated and highly perfused with blood to maintain a high concentration gradient; numerous, small, and highly folded to provide a very large surface area; thin (one cell thick) to minimize diffusion distance between the blood in the capillaries and



the air in the lungs.

Name the gas in cigarette smoke that prevents oxygen from binding to haemoglobin

**Answer:**

Carbon monoxide

### 14.9.2 Consolidated activity

1) What is the consequence of having a small surface area to volume ratio?

**Answer:**

Animal with a too small surface area to volume ratio cannot meet the demand of transport of substances by diffusion.

2) Arthropods do not have the haemoglobin to transport oxygen. Explain the relevance of the tracheole system in insect to overcome the shortage of oxygen supply.

**Answer:**

Air is directly brought to the active tissues where the gas exchange is directly done by diffusion.

3) If the air contains 0.04% of CO<sub>2</sub>, calculate p (CO<sub>2</sub>). Assume that the total pressure of the air is 101.3KPa.

**Answer:**

$$P(\text{CO}_2) = 0.04\% \times 101.3\text{KPa} = 0.04\text{KPa}.$$

4) Explain why cigarette smoking increases the risk of osteoporosis

**Answer:**

Cigarette smoking lowers oestrogen levels and reduces bone mineralization

### 14.9.3 Extended activity

1) Answer the following questions:

Use excel software to find out the surface area to volume ration of the following cubes:

Side/ mm	Area (A)	Volume (V)	A to V ratio
1			

2			
3			
4			
5			
6			

(b) Plot a curve of Surface area to volume ration against the size of each cube

**Answer:**

(a)

Side/ mm	Area (A)	Volume (V)	A to V ratio
1	6	1	6
2	24	8	3
3	54	27	2
4	96	64	1.5
5	150	125	1.2
6	216	216	1

(b)

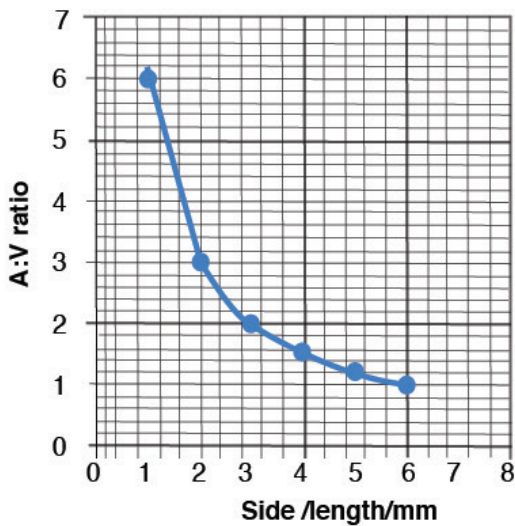

3) Why the fish cannot survive longer out of water at yet the atmosphere has plenty oxygen than water?

**Answer**

Because the gills are adapted to fix little amount of oxygen dissolved in water. The flow of water in parallel current or countercurrent direction allows the efficient gas

exchange. But the open air does not match with such an adaptation in fish.

4) Suggest why each cubic centimeter volume of a frog lung has a total gaseous exchange surface of 20 Cm<sup>2</sup>, whereas a cubic centimeter volume of a mouse lung has a gaseous exchange surface of about 800 cm<sup>2</sup>.

**Answer**

The shape of the respiratory surface areas of both frog and mouse are not the same.

5) How does tar in cigarette smoke contribute to the development of emphysema?

**Answer:** Tars irritate and damage lung tissue both mechanically and chemically.



## 15.1 Key unit competence

Describe structures of gaseous exchange organs in plants.

## 15.2 Prerequisite (knowledge, skills, attitudes and values)

For progressing well in this unit, students should be equipped with knowledge and skills pertained to photosynthesis, transpiration and gaseous exchange in animals. Knowledge and skills related to them should have been developed in studying unit 7 of senior two which is about photosynthesis, unit 5 of senior four which is about diversity of specialised tissues including parenchyma tissues and unit 11 of senior 4 which is about gaseous exchange in animals.

## 15.3 Cross-cutting issues to be addressed

Inclusive education and environment and sustainability will be developed in this unit.

For addressing inclusive education, as they may be some students with impairments such as visual and hearing. Use of illustrations as well as models which are larger will help those with visual disabilities for their effective learning. Those with hearing disabilities, sign language as in addition to enlarged pictures will effectively help the learning.

For addressing the issue of environment and sustainability, by appreciating the role of gas exchange in plants; students will understand how plants by their gas exchange whereby carbon dioxide is absorbed and oxygen being released by stomata; play important role to them so that they can cater plants.

Addressing the above issues can be done in the progress of the lesson as well as at the end of the lesson or unit depending to the situation. They can be addressed through questions or through the practices or materials used.

## 15.4 Guidance on the introductory activity

Introduce the unit by interacting with students through the statement and questions below:

As you know, all living organisms are characterized by gaseous exchange or simply by respiration. In a human being, the organs that are involved in respiration are more visible. Did you think about how do plants exchange gas? If so, how do they do? What are the structures that are involved?

Use their ideas to introduce a whole unit.

### Expected students' prediction

- Plants exchange gas through tiny pores
- The structures involved in gas exchange in plants are stoma.

### 15.5 List of lessons

	Lesson title	Learning objectives	Number of periods
1	Structure of stoma	Describe structure of stomata  Draw and label a diagram of stoma as observed under light microscope	1
2	Theories used to explain the mechanism of opening and closure of stomata	Explain the theories of opening and closure of stomata stating limitations of each.	2
3	Structural adaptations and function of stomata, lenticels and breathing roots	Explain how stomata, lenticels and breathing roots are adapted for their function.  Compare gaseous exchange structures of aquatic and terrestrial plants.  Relate the differences between the structures of aquatic and terrestrial leaves to a habitat.  Defend the relationship between structure and function in aquatic and terrestrial plants.	2
4	Assessment	Describe structures of gaseous exchange organs in plants	2

## **Lesson 1: Structure of stoma**

This is the first lesson of the unit 15 and is a single lesson. This means that it has only one period (40 minutes). The first lesson also covers the introduction of the whole unit.

### **a)Prerequisites/Revision/Introduction**

Introduce the lesson 1 by asking students to sketch and brainstorm how stoma looks like. Inform them to write down their ideas in relation to what they sketched and invite them to do activity 15.1. If your school does not have the required material for performing the suggested practical experiment, you are advised to draw pictures on Manila paper and ask students to describe them.

### **b)Teaching resources**

Leaves of *Commelina zebryne* or *Commelina clavata*, light microscopes, glass slides, cover slips, razor blade, forceps, Pasteur dropper, pictures, textbooks, diluted iodine solution.

### **c)Learning activity 15.1**

Through clear instruction as given in activity 15.1, facilitate learners to perform experiment given in 15.1.

- Ask them to do the questions given after performing experiment.
- Give them the opportunity to report their work.
- Use students' findings, challenge them through questions like why do you think it is necessary to focus on lower epidermis than upper? etc and move towards the conclusion.

### **Answers for activity 15.1**

- 1) To enable clear observation of the internal structures including stomata and neighbouring cells.
- 2) A labelled diagram of stoma

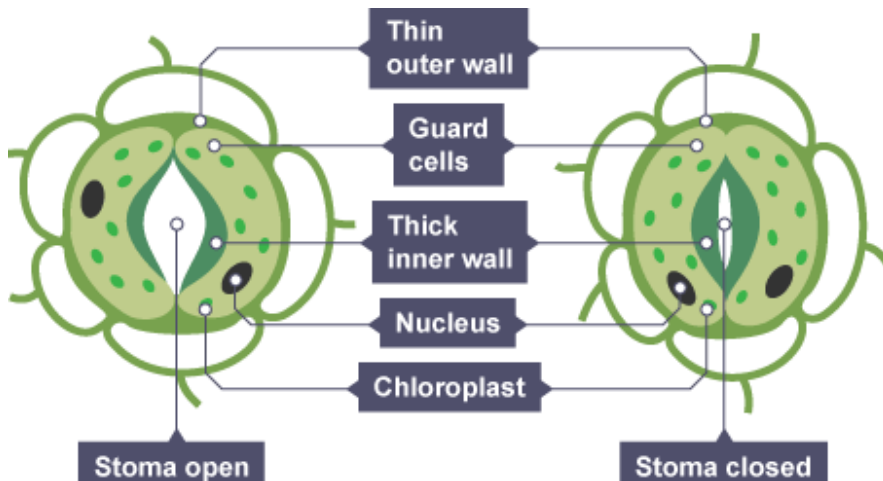

## 2) Answers for self-assessment 12.1.

1)D 2)B 3)A 4)C 5)A

### **Lesson 2:** Theories used to explain the mechanism of opening and closure of stomata

#### a) Prerequisites/Revision/Introduction

Introduce the lesson by asking students to brainstorm chemicals of life that are more important for plant cells. Connect the brainstormed ideas to the activity 15.1

#### b) Teaching resources: Figures, textbooks and internet

#### c) Learning activities

Invite students and help them to analyse the diagrams given in textbook activity 12.2 found in and do the following:

- Note down what causes the increase of guard cells' size
- Note down what causes the decrease of guard cells' size.
- Predict theories that explain the mechanism of opening and closure of stomata

Invite them to present their findings. After they have presented, consider their ideas and then clarify the theories used to explain the mechanism of opening and closure of stomata.



## Answers for activity 15.2

Entry of water and potassium in the guard cells

Theory of Photosynthesis in Guard Cells and Active Potassium Pump Theory

## Answers for self-assessment 15.2

- 1) Potassium increases the permeability of carbon dioxide into the guard cells.
- 2) Osmotic pressure will increase and guard cells will open wider.
- 3) The rate of photosynthesis is equal to the one of cell respiration or the volume of the carbon dioxide released by respiration is equal to the volume of oxygen released by photosynthesis.

## Lesson 3 :Structural adaptations and function of stomata, lenticels and breathing roots

### d) Prerequisites / Revision/Introduction

Start the lesson by asking students to observe pictures given in student textbook or on chart if there are available in school. Ask them whether those plants have the same ways of adaptation. Allow them to give their views. From their thoughts, help them to do the activity 12.3 given in student textbook.

### e) Teaching resources

Pictures or illustrations, charts, and textbook

### f) Learning activity 15.3

Ask students to make observations on the plants pictures given in the activity 12.3 and answer to the questions given in activity.

- How each of these plants is adapted for gas exchange?
- Read through the notes that follow and describe any two adaptations for gas exchange

Ask them to report their observation through diagramme

Ask them to present their work and you may challenge them through other questions so that they may deepen their understanding.

### g) Expected answers to activity 15.3

- 1) Mangroves have long aerial roots on the surface of water used for water absorption as well as gas exchange. Breathing roots by krene exhibit long aerial roots on the

surface area of the soil for gas exchange. Pneumatophores crack or break compact soil surface and develop upward to get more oxygen for gas exchange.

2) Adaptations of plants for gas exchange include: stomata, breathing roots, lenticels and cuticles

### **h) Answers for self-assessment 15.3**

Plants that inhabit arid regions (desert). Are known as xerophytic plants or xerophytes and have the following adaptations:

- Stomata sunken in grooves, reduced in number
- Ability to fix CO<sub>2</sub> at night, so the stomata are closed during the day.
- Epidermis infolded to reduce the surface area
- Leaves reduced to scales or thorns to reduce the surface area for transpiration

Plant that grows in water of high salinity, are known as halophytes. Halophytes come into contact with saline water through its roots or by salt spray, such as in saline semi-deserts, and are adapted to their environment in the following ways.

- Store water in succulent tissues which have high concentration of salt. They can thus take up water from the sea water by osmosis.
- Have extensive air spaces throughout the stem and roots making air available to all cells, and giving buoyancy to the stem and leaves at highest tides.
- They develop breathing roots called pneumatophores which grow upward and protrude out of the ground. e.g. mangrove tress.

### **15.6 Summary of the unit**

This unit 12 consists of three lessons. As described in student textbook, there are in the following order: Structure of stoma, Theories used to explain the mechanism of opening and closure of stomata, and Structural adaptations and function of stomata, lenticels and breathing roots.

The main structures involved in gas exchange in plants are stomata. Each stoma is made of two guard cells. The opening and closing of stomata is controlled by the intensity of light and the concentration of ions (K<sup>+</sup> ions, malate ions, H<sup>+</sup> ions).

In water stress, the plant secretes the abscisic acid which leads to formation of stomata in order to reduce the loss of water by stomatal transpiration.

Hydrophytes, xerophytes and halophytes have adaptations that allow plants to withstand the plenty of water, the lack of water and high salinity of in their substrates. Hydrophytes have stomata on the upper epidermis of their leaves. Xerophytes have reduced number of stomata while halophytes have succulent tissues rich in salt; some have lenticels and pneumatophores which are breathing roots.

## 15.7 Additional information

Theories of opening and closing of stomata are summarised in student textbook. The detailed is given to you so that you may be equipped with knowledge and understanding about them while using this guide. These theories are also followed by further information related to the adaption of plants in gas exchange.

The four theories of opening and closing of stomata are highlighted as follow:

### 1) Theory of Photosynthesis in Guard Cells:

Von Mohl (1856) observes that stomata open in light and close in the night. He then proposed that chloroplasts present in the guard cells photosynthesize in the presence of light resulting in the production of carbohydrate due to which osmotic pressure of guard cells increases.

Its explanation is based on following sequence:

Light → Photosynthesis in guard cells → Formation of sugar Increase of osmotic pressure of cell sap → Endosmosis takes place from subsidiary cell to guard cell → Increase of TP in guard cells → Stomata open.

### Demerits:

- Increasing the CO<sub>2</sub> concentration around the leaves should lead to wide opening of stomata but here occurs their partial closure.
- Chloroplast of guard cells are poorly developed and incapable of performing active photosynthesis.

### 1) Starch Sugar Inter-Conversion Theory:

According to Lloyd (1908) turgidity of guard cell depends on inter-conversion of starch and sugar. It was supported by Loft-field (1921). He found out that guard cells contain sugar during day time when they are open and starch during night when they are closed.

#### Sugar Inter-Conversion Part 1

Sayre (1926) observed that stomata open in neutral or alkaline pH, which prevails during day time due to constant removal of carbon-dioxide by photosynthesis. Stomata remain closed during night when there is no photosynthesis and due to accumulation of carbon-dioxide, carbonic acid is formed that causes the pH to be acidic. Thus, stomatal movement is regulated by pH due to inter-conversion of starch and sugar. Sayre concept was supported by Scarth (1932) and Small et. al. (1942).

Yin and Tung (1948) isolated for the first time phosphorylase enzyme from the guard cells. According to them starch is converted into glucose-1, phosphate in the presence of this enzyme. During the process, inorganic phosphate is also used and light and dark

phases (changing CO<sub>2</sub> concentration) control the changes in pH. The reaction may be represented as follows:

### Starch Sugar Interconversion Part 2

Steward (1964) proposed another modified scheme of inter-conversion of starch and sugar for stomatal movement. He believes that conversion of starch to Glucose -1 phosphate is not sufficient. It should be converted to glucose in order to increase sufficient osmotic pressure. For this, ATP is also required which means that the process should be through respiration in presence of oxygen. Guard cell carries enzymes like Phosphorylase, Phosphoglucomutase, Phosphatase and Phosphorylase. These enzymes help in opening and closing of the stomata.

### Starch Sugar Interconversion Part 3

Based on the above mentioned theory, process of opening and closing of stomata may be summarized as given below. In light:

Photosynthesis (1) → Decreased CO<sub>2</sub> Concentration in leaf cells (2) → Increase in pH of guard cells (3) → Hydrolysis of starch to sugar by enzymes (4) → Increase of O.P. of guard cells (5) → Endosmosis of water in guard cells (6) → Increase in T.R of guard cells (7) → Aperture

## 2) Theory of Glycolate Metabolism:

Zelitch (1963) proposed that production of glycolic acid in the guard cells is an important factor in stomatal opening. Glycolate is produced under low concentration of CO<sub>2</sub>. He suggested that glycolate gives rise to carbohydrate, thus raising the osmotic pressure and also that it could participate in the production of ATP. Which might provide energy required for the opening of stomata?

### Demerits:

- It fails to explain the opening of stomata in dark (e.g., – in succulent plants).
- In some plants stomata have been found to remain closed even during daytime.
- It fails to explain the effect of blue light on stomatal opening.

## 3) Active Potassium Pump Theory:

The concept of K<sup>+</sup> ion transport was given by Fujino. It was supported and elaborated by Levitt & Rashke in 1975. It appears to be an active mechanism which needs ATP. It is based on recent observations and (explains the mechanism as follows).

A. Opening of Stomata during Daytime (in presence of light):

Opening of stomata depends upon following conditions:

- Presence of light.
- Decrease in starch contents of guard cells.
- Increased concentration of malic acid in guard cells.
- Influx of K<sup>+</sup> ions in guard cells.
- Efflux of H<sup>+</sup> ions from guard cells.
- Intake of Cl ions by guard cells.
- Low CO<sub>2</sub> concentration in an around guard cells.
- High pH (more than 7) in guard cells (hence, alkaline medium of the cell sap in guard cells).
- High T.P. in guard cells due to endosmosis, (turgidity of cells).
- TP more towards thin wall of guard cell & stomata open.

According to Levitt, in the guard cells, starch is converted into malic acid in presence of light (during day time).

## 15.8 Answers of end unit assessment

### Section A : Objective questions

1. B.                      2. D.                      3. A.                      4. C.                      5. B.

### Section B

6. During the day, K<sup>+</sup> pumps of guard cells open and K<sup>+</sup> ions flow in guard cells by active transport. This makes guard cells permeable to carbon dioxide which is used in the chloroplast of guard cells to make glucose by photosynthesis. High amount of sugar (malate) increases the osmotic pressure in the guard cells. Water moves from the neighbouring cells into the guards cells which become turgid. The guard cells stretch backwards and the aperture of stoma opens wider. Water vapour and Oxygen are released.

7. Stems of woody plants have narrow openings or slits at intervals called lenticels. They are surrounded by loosely arranged cells where the bark is broken. They have many large air intercellular spaces through which gaseous exchange occurs. Oxygen enters the cells by diffusion while CO<sub>2</sub> leaves. Unlike the rest of the bark, lenticels are permeable to gas and water.

8. Gaseous exchange occurs in the root hair of young terrestrial plants. Oxygen in the air spaces in the soil dissolves in the film of moisture surrounding soil particles and diffuses into the root hair along a concentration gradient. It diffuses from root hair cells into the cortex where it is used for respiration. CO<sub>2</sub> diffuses in the opposite direction. In older roots of woody plants, gaseous exchange takes place through the lenticels.

9. Roots of aquatic plants e.g. water lily is permeable to water and gases. Oxygen from the water diffuses into roots along a concentration gradient.  $\text{CO}_2$  diffuses out of the roots and into the water. The roots have many small lateral branches to increase the surface area for gaseous exchange. They have air spaces that help the plants to float.

10. The mangrove plants grow in permanently waterlogged soils, muddy beaches and estuaries. They have roots that project above the ground level. These are known as pneumatophores.

(i) Refer to the student book (Figure 12.2)

(ii) Refer to the student book (Figure 12.3)

(i) Stomata open during daylight hours to allow  $\text{CO}_2$  in for photosynthesis. Stomata close at night, when no light, which reduces transpiration.

(ii) (i) During day  $\text{K}^+$  ions move into the guard cells lowering the water potential and drawing in water by osmosis. Guard cells with swollen vacuoles pull apart and stomata open.

(iii)  $\text{K}^+$  ions pass from low to high concentration by active transport. An input of energy is required provided by ATP. Protein carriers are involved in active transport across a membrane.

## 15.9 Additional activities

### 15.9.1 Remedial activities

1) Define each of the following terms: (a) Stoma – (b) pneumatophores – (c) Lenticels

2) Name the structures involved in gaseous exchange in plants

3) State the adaptations for gaseous exchange in mangroves.

#### Answers:

1) (a) Stoma is the aperture between two guard cells that opens and closes to control water transpiration and gaseous exchange in plant leaves and stems (b) Pneumatophores are breathing roots of plants (c) Lenticels are any of pores in the stems of woody plants that allow gas exchange between the atmosphere and the internal tissues.

2) Structures involved in gaseous exchange in plants are stomata, cuticles, lenticels and pneumatophores.

3) Adaptation of gas exchange in mangroves:

- Presence of stomata on leaves

- Presence of lenticels
- Presence of pneumatophores

### 15.9.2 Consolidated activities

- 1) Why do plants living at high altitudes need xeromorphic adaptations?
- 2) Why do halophytes have very little lignified tissues?
- 3) Glassworts are edible, salty tasting plants. Why do they accumulate salt in their tissues?

#### Answers:

- 1) Plants at high altitudes have xeromorphic adaptations to reduce transpiration losses when soil is frozen and free water is unavailable
- 2) Hydrophytes are supported by water
- 3) Salt is actively absorbed in tissues of glassworts to create a concentration gradient for the uptake of water by osmosis.

### 15.9.3 Extended activities

Have a Commelina leaf. Remove its upper epidermis and its lower epidermis. Use 2mm x 2mm portion from each epidermis. Mount each portion on a drop of dilute iodine solution. Observe each preparation under the lower magnification. Count the number of stomata from each side. Repeat the same procedure using the leaf of mango leaf.

a) Fill the table below:

Plant leaf	Number of stomata on lower epidermis	Number of stomata at upper epidermis.
Commelina		
Mango		

What conclusion can you draw from the data in table above?

#### Answers:

- a) The answer can vary from one student to another
- b) The leaves of monocotyledonous plants have stomata on both upper and lower epidermis but the leaves of dicotyledonous plants do not have stomata on the upper epidermis.





## 16.1 Key unit competence

Explain and demonstrate modes of locomotion in protists, insects, fish, amphibians, birds and mammals.

## 16.2 Prerequisite (knowledge, skills, attitudes and values)

In order to succeed well this unit, students should possess knowledge and understanding, skills and attitudes that are related to skeletal systems of organisms and joints and movement acquired in Unit 10 and 11 of senior 1 and 2 respectively. They should be also be able to do observation, analysis, interpretation of the pictures and then capable to present and or communicate the results.

## 16.3 Cross-cutting issues to be addressed

Among the cross cutting issues that are to be addressed by the competence - based curriculum, the issues of inclusive education, peace and values education will be addressed within this unit with the purpose of raising awareness about different movements in organisms particularly humans so that they may develop different values such as respect, self-actualisation and understanding, acceptance, among others.

For inclusive education, as the unit uses pictures for students to learn, those with special needs should be given models or tactile tools and or using scenario for students with visual impairment. Using body language will help those who cannot hear so that they may be involved in different learning activities. For the clarity and visibility of teaching materials, make sure that students can see the pictures. Additional questions may be asked at the end of each lesson after students' presentation of the findings as well as the conclusion.

Since some locomotion that are identified among organisms particularly people, further questions for hearing what can be done to such kind of organisms might be asked for promoting peace and values.

## 16.4 Guidance on the introductory activity

Give an assumption to students as provided in student textbook. Ask them to do the following reflect or brainstorm on the following questions:

- Brainstorm / reflect how an animal would look like without skeleton.
- Predict what will happen if an animal could not move due to lack of skeleton.
- Express their ideas after giving them time to think.

Appreciate their ideas/ thoughts. Inform students that by studying this unit, they will be aware about to appreciate need for locomotion, distinguish different types of locomotion depending to animals and their habitat and then appreciate locomotion and support.

### Expected students' feedback

Without that skeleton, animal would look strange and funny. It would even be incapable to move and may even die. Body shape, protection of internal organs, support of the body, production of red blood cells and storage of the calcium are possible with skeletal system.

Can you then think on the role of skeleton and muscles in living organisms?

In animals, skeleton as a framework plays important role in all animals. Without that skeleton, animal would look crazy and funny, and not even capable to move. Thus, apart from ensuring locomotion, skeleton:

- Gives the body shape by forming a frame on which the internal organs are suspended and kept in position.
- In higher chordates, the skeleton is responsible for other important functions such as protection whereby the skeleton encloses delicate organs like the heart and lungs (this is done by the ribs), spinal cord (by vertebrae), brain (by skull) etc.
- It also supports organism and this is mainly done by the vertebral column, pectoral and pelvic girdles, and limb bones for example.
- Skeleton system plays the role in production of red and white blood cells (by marrow in leg bones and ribs).
- The skeleton provides storage for calcium and phosphate which may be added to the blood when needed.

## 16.5 List of Lessons

	Lesson title	Learning objectives	Number of periods
1	Need for locomotion	<ul style="list-style-type: none"> <li>• Explain how support structures are related to the environment of the animal.</li> <li>• Observe locomotion of animals and identify reasons for their movement</li> <li>• Appreciate the need for locomotion in animals</li> <li>• Recognise that the types of locomotion of animals depends on their habitat</li> </ul>	2
2	Support and locomotion in non-muscular organisms	<ul style="list-style-type: none"> <li>• Explain non-muscular movement in Amoeba, Paramecium, Trypanosoma and Euglena.</li> <li>• Explain how support structures are related to the environment of the animal.</li> </ul>	3
3	Support and locomotion in fish	<ul style="list-style-type: none"> <li>• Explain how movements and support of fish are brought about in water.</li> <li>• Explain how support structures are related to the environment of the animal.</li> <li>• Demonstrate the arrangement of muscles in fish.</li> <li>• Dissect a fish to observe its swim bladder.</li> <li>• Develop research using internet through finding relations between muscles, joints and musculo-skeletal in fish.</li> </ul>	4
4	Support and locomotion on land or muscular skeletal basis of locomotion	<ul style="list-style-type: none"> <li>• Describe support and movement on land</li> <li>• Explain how support structures are related to the environment of the animal.</li> <li>• Observe and explain the relationship between muscles, joints and musculo-skeletal attachments in terrestrial animals.</li> <li>• Develop research using internet through finding relations between muscles, joints and musculo-skeletal.</li> </ul>	4

5	Flight/ movement through air by birds and insects	<ul style="list-style-type: none"> <li>• Describe skeletal modification in birds.</li> <li>• Explain how support structures are related to the environment of the animal.</li> <li>• Observe and explain the relationship between muscles, joints and musculo-skeletal attachments in birds.</li> <li>• Compare the flight of birds and insects.</li> <li>• Develop research using internet through finding relations between muscles joints and musculo-skeletal.</li> </ul>	4
6	Comparison of jumping movements of grasshoppers and toads	<ul style="list-style-type: none"> <li>• Observe and explain the relationship between muscles, joints and musculo-skeletal attachments in insects and amphibians.</li> <li>• Compare the jumping movement of grasshoppers and toads/frogs.</li> <li>• Develop research using internet through finding relations between muscles joints and musculo-skeletal.</li> </ul>	2
7	Assessment	<ul style="list-style-type: none"> <li>• Explain and demonstrate modes of locomotion in protists, insects, fish, amphibians, birds, and mammals.</li> </ul>	2

## Lesson 1: Need for locomotion

This is the first lesson of unit 16 and is a single lesson. This means that it has only one period (40 Minutes). The first lesson also covers the introduction of the whole unit.

### a) Prerequisites/Revision/Introduction

Ask students to state and describe (antagonists) muscles, bones, and joints. Ask the role of the afore mentioned structures in relation to the functions. Ask them to predict reasons for the increase in food production.

### b) Teaching resources

- Pictures on charts, textbooks, imaginary specimen

### c) Learning activity 16.1

Help learners to develop competencies of this lesson by doing the following:

- Help students to make groups of not more than six students each,
- Ask students to refer to their daily experience and then do activity 16.1.

- After they have worked on the activity 16.1, give opportunity to them so that they present what they come up with
- Use students' findings, challenge students through questions like why do you think some animals move only on the land while others could not? etc and move towards the conclusion?
- Extend the lesson by connecting it to how locomotion is done differently depending to the animal and its habitat

### **Answers for activity 16.1**

1) Locomotion is the movement from one place to another. It is different from the movement which is the displacement of part of an organism. Although, all organisms are characterized by the movement not the location.

2) There are different ways an animal use to move from one place to another. Those are: hopping in kangaroo, rabbit, and grasshopper for example, flying for birds and insects in general, swimming for aquatic dwellers such as fish, dolphin. There are also running, climbing, crawling, jumping, and gliding, gripping and floating.

3) Locomotion is necessary for: escaping danger fire or predator; look for food, water and shelter; reproduce or find mates; avoid competition with other animals of the same or different species; avoid unfavorable condition example migration.

### **Answers on self-assessment 16.1.**

1) Locomotion for animal is the displacement from one place to another.

2) The requirements for locomotion are the skeleton and muscles.

3) Based on their habitat, zebra, antelope and cow run; frog, grasshopper and kangaroo hop; dragonfly and bee fly; squid, fish, frog and duck swim; snake, worm and spider crawl.

4) Locomotion is necessary because it enables animals to escape danger fire or predator; look for food, water and shelter; reproduce or find mates; avoid competition with other animals of the same or different species; avoid unfavorable condition example migration.

## Lesson 2 : Support and locomotion in non-muscular organisms

### a) Prerequisites/Revision/Introduction

Start the lesson by asking learners to think about and name animals with muscles and those without muscles locomotion. Ask them to brainstorm how animals without muscular movement move about?

### b) Teaching resources

Pictures/illustrations of different species, textbook, internet

### c) Learning activities 16.2

Help learners to develop competencies of this lesson by doing the following:

- Form learning groups by considering the students' differences
- Observe paramecium under microscope under your support/ guide
- Ask them to relate their observation to pictures given in the activity 16.2
- From the pictures and observations, ask them to produce a cartoon of their observation and explain what has been produced.

### Answers for activity 16.2

A cartoon having pictures like those below is expected to be produced.

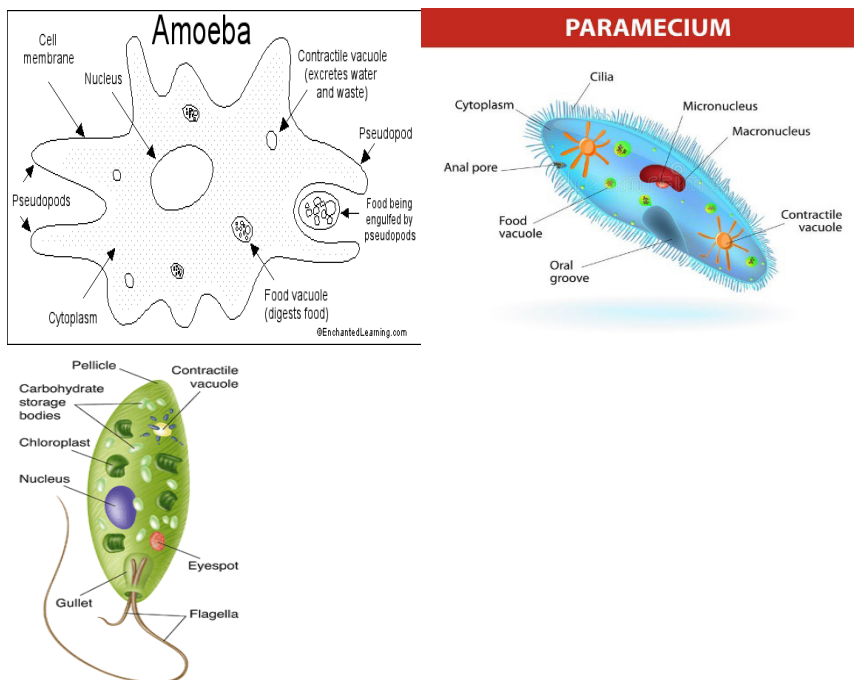

- Amoeba moves by amoeboid locomotion

- Paramecium moves by cilia or by ciliary mode
- Euglena and Trypanosoma move by flagellum or flagella

### Answers for self-assessment 16.2

- 1) Answers:
  - a) Amoeba moves by means of pseudopodia. Those pseudopodia are extended if it wants to move toward the food for example of when escaping a predator or when the habitat is not conducting.
  - b) Having cilia on their cell membrane, Paramecium caudatum is capable to move by beating their cilia in water.
  - c) (C&d) Trypanosoma gambiense, Trypanoma vaginalis, and Giardia intestinalis move by beating flagellum or flagella.
- 2) Cilia are many structures or extension of the cell membrane whereas as flagella are in most of cases one or two sometimes three in Giardia intestinalis for example. Both are functionally the same.
3. A diagramme showing locomotion in amoeba

### Lesson 3: Support and locomotion in fish

#### a) Prerequisites / Revision/Introduction:

Start the lesson by asking whether they have seen a swimming fish or a fish in general. Ask them to brain storm how a fish swims. From their thoughts, help them to do the activity 14.3 given in student textbook.

#### b) Teaching resources

Collected fresh/ live fish, pictures/figures of fishes, and dissecting equipment. Ask them to do the following activity 16.3

#### c) Learning activity 16.3

Take students in school laboratory and caution them to take care of their safety and do the the activity 16.3

- Guide them on how they observe external parts of fish
- Guide then on how they observe internal components of the fish
- Ask them to report their observation through diagramme
- Ask them to present their work challenge then about:

### Answers for activity 16.3

1. Well labelled drawn of fish with its external features particularly fins
2. Dissected fish diagramme showing swim bladder
3. Diagramme showing skeleton system with muscles arrangement

### Answers for self-assessment 16.3

1. Swim bladder helps the fish in its locomotion by changing its buoyancy thus the fish can float at any depth.
2. Illustrate how the arrangements of fish myotomes that contribute to fish locomotion in water are?

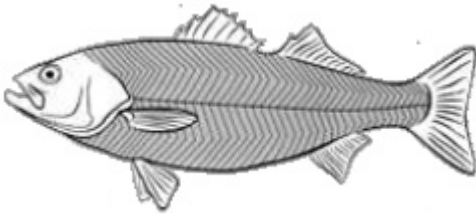

From the above fish, student shows V, W and parallel myotomes using like the above fish diagramme.

- 2) Segmental body of fish muscles gives the ability to move in undulatory swimming;
- 2) The anatomical structures that give rise the direction of a fish and preventing diving and rolling are pelvic fins.

## Lesson 4 : Support and locomotion in terrestrial / land animals

### a) Prerequisites/Revision/Introduction

Introduce the lesson by providing to students list of different animals (fish, dog, goat, chicken, cow, duck, and frog) and ask them to identify among the list species which are capable to move on land and those which are not capable to move on land. For those moving on the land ask them to brainstorm how do they move?

### b) Teaching resources

Pictures / illustrations or photographs, real specimen found in the environment, students' textbooks,



### c) Learning activity 16.4

Facilitate learners to develop competencies of this lesson by doing the following:

- Form groups of not more than six members each,
- Describe how skeleton and muscles of hind and forelimbs behave during or for the locomotion of different animals e.g. a dog, chicken, frog and worm is brought about on land.
- Show by diagrammes how the relationship between muscles, joints and musculo-skeletal attachment in mammals, birds, frog and earthworm could be.

### Answers for activity 16.4

1. During their locomotion, a limb to move from one place to another, by the action of muscles and skeleton.

- For a dog, chicken, and frog; flexor bends a limb by its contraction and extensor straightens a limb being a forelimb or hind limb.
- A dog can run as a result of losing its quadrupedal movement whereby the forelimbs move together, followed by the hind limbs due to the action of flexor and extensor.
- For a worm; the locomotion is possible by the contraction of its muscles (circular and longitudinal). Contraction of the circular muscles makes the worm thinner whereas the contraction of the longitudinal fibres shortens the worm.

2. Diagrammes showing flexor and extensor muscles. And also muscular-skeleton at the level of bone-muscle junction.

### Answers for self-assessment 16.4

- 1) The main muscles that contribute to locomotion in mammals, amphibians and birds are flexor and extensor
- 2) A diagramme showing circular and longitudinal muscles
- 3) Endoskeleton is found in mammals, birds, amphibians. In earthworm, there is hydro-skeleton type of skeleton
- 4) A diagramme showing how flexor muscles contract and bone and then extensor straightens a bone so that a limb is lifted.

## Lesson 5 : Flight/movement through air by birds and insects

### a) Prerequisites/ Revision/ Introduction

Introduce the lesson by asking students to brainstorm how birds and insects move in air. And ask also the means used by the insects as well as birds in moving in air.

### b) Teaching resources

Pictures of birds and insects, real bird and insect specimen, video of flying insect and bird

### c) Learning activity 16.5

- Help students to do activity 14.5 given in textbook
- After its completion, invite them to present
- Use their presentation to conclude the lesson

### Answers for activity 16.5

a) Forelimbs are modified into wings show different structures such are keel of sternum, pectoralis major and minor, coracoid, scapula, humerus, radius and ulna, and metacarpals. Fused vertebrae of the trunk. Bird bones are hollow which reduce weight and also there are air sacs attached to the lungs for providing necessary oxygen for respiration. Addition to the action of flexor and extensor, the contraction of pectoralis major and relaxation of pectoralis minor move up and down the wings.

b) A diagramme showing the above structures.

c) Wings are spread or not being closer each other or on the body when atmospheric pressure reduces and are very closer or not spread when atmospheric pressure increases.

d) A comparing table of the flight in birds and insects

### Answers for self-assessment 16.5

- 1) Muscles that enable the flight in birds are pectoralis major and minor which are muscles attached on the sternum.
- 2) Skeleton contribute to flight by
  - Change in its shape which gives a streamline body shape
  - Forelimbs which are changed into wings. Each forelimb has pectoralis major and minor on which flight muscles are attached.
  - Bones with empty interiorly

### 3) **Birds are describing to flying by:**

- Modification of limbs particularly forelimbs,
- Increased number of flight feathers provide a large surface area of wings without increasing the weight;
- Large and powerful pectoral muscles
- Bones of vertebrae are fused
- Enlarged sternum to provide a large surface area for attachment of the flight muscles: pectoral muscles
- Hollowed bones make birds light
- Streamlined body covered with light feathers.
- Backward arrangement of features for reducing air resistance

## **Lesson 6 : Hopping locomotion in grasshoppers and toads**

### **a) Prerequisites/ Revision/ Introduction**

Introduce this lesson by asking students to collect fresh specimen of grasshopper and toads. If not found, provides pictures of grasshoppers and toads. Ask them to observe them moving and then do activity 14.6 given in student textbook

### **b) Teaching resources**

Pictures of frog, grasshopper, textbooks, live specimen

### **c) Learning activity 16.6**

Ask students to work in group in collecting and analysing the movement of species

- Ask students to put on a cemented ground the collected specimen.
- Ask them to prudently and carefully observe them moving and then answer the questions given in activity 14.6
- Ask them to report their observation.

1) Identify and describe anatomic structures that enable them to jump

2) Illustrate how legs' muscles behave when they are resting and or jumping

## Answers for activity 16.6

1. Exoskeleton under which muscles for hopping are located the rear or back legs of a grasshopper which are long and muscular extensor tibiae muscle which contracts to extend the leg, and the flexor tibiae muscle which contracts to flex the leg. Jumping or hopping muscles pull on tendons which are attached to the tibia on either side of the joint pivot.

2. Illustration should focus on the flexor and extensor muscles whereby some contracts while others relaxes and thus the shape of a leg may be in Z shape or not as tibia extends resulting from contraction of extensor muscles and tibia flexes as a result of relaxation of extensor muscle. At rest or sitting position, the extensor muscle contracts which enables then the legs jerk or move very quickly backwards propelling the grasshopper. Similarly, to toads and frogs like in grasshopper:

- A frog is at rest; the hind legs are folded up in the shape of a letter Z.
- When it hops, the legs are quickly straightened out, lifting the animal off the ground. But toads do not travel as high as far as a frog does at each hop.
- The fore-limbs are used as shock absorbers on landing and they also support the front end of the body when the animal is at rest.

## Answers for self-assessment 16.6

1. Muscles that contribute to high jumping in a grasshopper are those (extensor and flexor) of hind legs since they are the ones for jumping.

2. When toads and grasshopper relax flexor muscles contract whereas extensor relax. When jumping, flexor relaxes whereas extensor contracts.

3. A hind leg showing a Z shape which is different from the one formed when it is on jump.

## 16.6 Summary of the unit

This unit consists of six lessons. As described in student textbook, there are in the following order: need for locomotion, support and locomotion in non-muscular organisms, support and locomotion in fish, support and locomotion in terrestrial / land animals, flight/movement through air by birds and insects, and hopping locomotion in grasshoppers and toads.

In the first lesson, the concept of locomotion is described. In the same lesson, there are the requirements for locomotion and why locomotion is very necessary. The second lesson describes the locomotion in amoeba, paramecium, and flagellate animals. The third lesson describes fish features that enable the movement and support in water. The fourth describes walking, running and crawling type of locomotion as different

modes of locomotion on land. The fifth is about how animals particularly birds and insects move in air. The last lesson is about jumping or hopping in toads/ frogs and in grasshoppers.

For each lesson, introduction, resources, learning activities and self-assessment questions have been provided. At the end of unit, end of unit assessment tasks are provided.

### **16.7 Additional information**

For effective facilitation of the learning, skeletal as well as muscular system deep knowledge and skills as students have developed in unit 10 and 11 of senior one and two respectively. Furthermore, you need to check knowledge, skills and attitudes and values that are to be achieved by similar unit in senior six so that you may not go so far but being limited to the expected unit learning outcomes.

### **16.8 Answers for End unit assessment**

1. Amoeba moves by means of pseudopodia/ cytoplasmic projections formed by its cell membrane.

Differently from amoeba, paramecium moves by cilia which are structures on its cell membrane.

Euglena and trypanosoma move by their flagellum or flagella depending to number of flagella they possess.

2. A drawing /cartoon showing different fins, scales, and shape of fish as they enable fish to move from one place to another. Also the one showing swim-bladder and muscles arrangement is necessary.

3. Fins contribute to locomotion and balance in the following ways:

- Tail fin increases the amount of water to be displaced as it enlarges area as well as provides much of the push during swimming.
- Pair of pectoral and pelvic fins bring about downward and upward movement.
- Pectoral fins control of direction of a fish in water
- Pelvic fins bring about the balance, preventing diving and rolling.
- A single dorsal and anal fins stabilizes the fish and thus preventing it from rolling or yawing.

4. The movements and support of fish in water occur by: its external features such as fins; scales, shape; muscles/myotomes arrangement into parallel, V, and W shapes.

5) Diagrammes showing relationship between muscles, joints and musculo-skeletal attachment in mammals, birds, frog and earthworm.

a) A diagramme showing muscles structures in joints when an animal is at rest or is moving part of the body. In a human, a diagramme to indicate how muscles/ muscle fibres look like at the level of kneel when someone. Also show femur as well as tibia muscles.

b) In bird, show how sternum muscles (pectorals) look like.

c) In frog, show muscles of hind legs.

d) In earthworm, show muscles when earthworm is moving forward or backward.

6) Flexor and extensor muscles work antagonistically to enable the locomotion on land, water and in air. One contracts (flexor) contracts and then bends a limb whereas extensor contracts for extending or straightening.

7) The structures that enable flight in air by bird are: wings, sternum muscles, and shape.

8) Description of how grasshopper and frogs are adapted to jumping:

- A toad is good at jumping than a grasshopper.
- Flexor and extensor are attached to the exoskeleton in insects and endoskeleton in frogs.
- There are also extensor tibiae muscle which contracts to extends the rear/backleg, and the flexor tibiae muscle which contracts to flex the leg
- Those muscles pull on tendons which are attached to the tibia on either side of the joint pivot.
- Frogs like grasshoppers hop by means of their hind limbs which are capable to be shortened and straightened as a result of its jumping muscles. They are different by having skeleton. And ability one possess over another like moving in water for frogs and flying in air for grasshoppers.
- The fore-limbs are used as shock absorbers on landing and they also prop up (to give support) the front end of the body when the animal is at rest.

#### **9) Advantages of locomotion are:**

- Escape danger fire or predator;
- Look for food, water and shelter;
- Reproduce or find mates;
- Avoid competition with other animals of the same or different species;
- Avoid overcrowding which enables offspring to move to another place;
- Avoid unfavorable condition example migration.

## 16.9 Additional activities

### 16.9.1 Remedial Activities

1) Differentiate locomotion from movement

**Answer:**

Movement is the displacement of part of an organism

Locomotion is the displacement of the whole organism from one place to another.

Movement is common to all kind of living

Locomotion is specific to animals

2) What is the function of cilia, flagella and cytoplasmic invaginations, wings, hind limbs, feathers?

**Answer:**

They enable the animals that exhibit them to move

3) How do the following animals move about? Cow, kangaroo, dog, grasshopper, toad, butterfly, Trypanosoma sp., snails, snake, paramecium moves?

**Answer:**

Cow and dog walk by limbs; kangaroo, grasshopper, and toad hop or jump by hind legs; Butterfly and grasshopper are adapted to flying by wings; snail and snake crawl, trypanosoma and paramecium move by flagella and cilia respectively.

4) What are different fins that help a fish to swim?

**Answer:**

Tail, ventral, pectoral and dorsal fins

5) With examples of organism that exhibit particular type of skeleton, distinguish the three types of skeleton that supports animals.

**Answer:**

**Hydrostatic skeleton** is found in most invertebrates and in annelids. It consists of fluid filled body cavity surrounded by antagonistic sets of muscles.

**Exoskeleton** is particular to arthropods insects for example, is a hard cuticle made of chitin which lies outside the muscles which move parts of it.

**Endoskeleton** is characteristic to bony animals. It is on which muscles are attached.

### 14.9.2 Consolidated activities

1) Based on different body structures, what does it cause the movement which may result in locomotion in animals with:

- a) Endoskeleton
- b) Exoskeleton
- c) Hydrostatic skeleton

Answer:

- a) Contraction of muscles bring about movement of their attached bones and finally to the locomotion.
- b) Muscles attached to exoskeleton in part of legs enable the locomotion
- c) For animals with hydro skeleton, the movement is brought as result from compressive contraction action.

2) Based on the table below, put the animals provided here into its respective way of locomotion: spider, rabbit, mosquito, snake, seahorse, bat, whale, penguin, worm, goose, and dragonfly.

Swim	Hop	Fly	crawl

Answer:

Seahorse	Rabbit	Bat	Snake
Whale	Goose	Mosquito	Worm
Crocodile	Penguin	dragonfly	Spider
Goose			
Penguin			

### 16.9.3 Extended activities

1) Draw and label a fish diagramme



**Answer:** a well labelled diagramme showing fins, scales, shape

2) Describe how major muscles of locomotion contribute to locomotion on land

**Answer:**

- Description of flexor and extensor as well as circular and longitudinal muscles in earthworm.
- Flexor and extensor muscles work antagonistically to enable the locomotion on land, water and in air. One contracts (flexor) contracts and then bends a limb whereas extensor contracts for extending or straightening.
- There are also extensor tibiae muscle which contracts to extend the rear/back leg, and the flexor tibiae muscle which contracts to flex the leg.
- Frogs like grasshoppers hop by means of their hind limbs which are capable to be shortened and straightened as a result of its jumping muscles.
- Draw and illustrate how muscles are arranged in a fish

**Answer:**

3) A diagramme showing muscles arranged in parallel, V, W shape



## 17.1 Key unit competence

Describe the social factors that affects good health and apply knowledge gained in familiar and unfamiliar contexts.

## 17.2 Prerequisite (knowledge, skills and attitudes)

In order to succeed well this unit, students should possess knowledge and understanding, skills and attitudes that are related to classification of diseases, non-infectious diseases in unit 11 and unit 12 of senior 1 and 2 respectively. They should be also be able to do observation, analysis, interpretation of the pictures and then capable to present and or communicate the results.

## 17.3 Cross-cutting issues to be addressed

The cross-cutting issues to be addressed by this unit include inclusive and gender education, and standardized culture.

### a) Inclusive education

This unit involves a number of activities on research from different sources and experiments that require the listening and vision. This may be challenging to students with special educational needs especially children with visual impairment. However, the teacher can do the following:

- Grouping students with special educational needs with others and assigned roles basing on individual student's abilities.
- Providing procedure earlier before the experiment so that students get familiar with them. They can be written on the chalkboard or printed depending on available resources. If you have children with low vision remember to print in appropriate fonts.
- Every important point is written and spoken. The written points help students with hearing impairment. Speaking aloud helps students with visual impairment
- Remember to repeat the main points of the lessons.

## **b) Gender education**

- Involve both girls and boys in all activities: No activity is reserved only to girls or boys.
- Teachers should ensure equal participation of both girls and boys during experiments as well as during cleaning and tidying up related activities after experiments.

## **c) Standardization culture**

- Some lessons involve carrying out experiments about diseases. Students will understand the causes of diseases and also the drugs used to treat them. Through questions they can develop awareness of the standardized culture whereby the misuse use of some drugs as well as their state could not treat diseases. Thus, learners have to always check if they are not using expired chemicals or defective apparatus.

### **17.4 Guidance on the introductory activity**

This introductory activity helps you to engage learners in the classification and patterns of disease and invite the learners to follow the next lessons.

As facilitator help the learners to develop competences in the following:

- Ask students to read and discuss the given questions.
- Engage students in working collectively the activity.
- Help students with different problems.
- Ask any four students to present their findings while others are following
- Help the learners to make summary of the group discussions.

The expected answers

Issues caused by eating without washing hands include diseases such as cholera, typhoid, amoebic dysentery, etc. They can be prevented by washing hands before eating, using toilets, not eating food which is not cleaned.

## 17.5 List of lessons/sub-heading

	Lesson title	Learning objectives	Number of periods
1	Germ theory of diseases	Appreciate the importance of germ theory of disease by showing that the death rate related to infections is greater than those caused by accidents.	1
2	Types of diseases	Identify different categories of disease and give an example of each.  Analyze and interpret records from a given hospital to identify diseases as endemic, epidemic or pandemic.  Apply knowledge gained to classify common diseases.	1
3	Common infectious diseases	Explain the theory of the disease and the causes, sources, transmission, symptoms and controls of the disease.  Discuss how global patterns of disease are studied.	1
4	Health and community	Explain criteria for good housing	1
5	Public health services	Explain the organization and functioning of public health services in Rwanda.	1
	Assessment	Describe the factors that affect good health.	2

## Lesson 1: Germ theory of diseases

### a) Prerequisites/Revision/Introduction

This is the first lesson of the fifteenth unit. In this lesson you will be dealing with works of different scientists like Louis Pasteur, Semmelweiss, Joseph Lister, Antoni vanLeeuwenhoek and Robert Koch. The first thing to do before starting teaching is to remind students that they have learnt about infectious diseases, (unit 12, Senior 2), and ask them to discuss the meaning of some terms used like immunity, antigen, aetiology, epidemiology, vector, carrier, prevention and antibody when discussing infectious disease so that they can prepare themselves for this lesson.

### b) Teaching resources

Different student's books, graph charts, simulations and computer animations, projector, Manila paper with diagrams for improvisation

### c) Learning activity 17.1

**As facilitator help the learners to develop competences in the following:**

- Ask learners to do in groups activity 15.1 in their student books
- Provide the necessary materials.
- Move around in silence to monitor if they are having some problems
- Remember to assist slow learners but without giving them the knowledge.
- Invites any three groups to present their findings to the rest of students.
- Ask other students to follow carefully the representations.
- Note on chalk board / Manila paper the student's ideas.
- Tick the correct findings and correct those ones which are incorrect and try again to complete those which are incomplete.
- Harmonize and conclude on the learned knowledge and still engage students in making that conclusion.

### Answers for activity 17.1

#### 1) The cause of death are:

- Accidents from car crashes and house burning
- Disasters such as floods,
- Diseases caused by microorganisms.
- Drug abuse such as tobacco, alcoholism.

## 2) Expected answers:

### It is difficult to eradicate malaria because:

- There is no effective vaccine against malaria
- The pathogens are transmitted by mosquitoes which are not eradicated.
- The plasmodium have become resistant to different anti-malarial drugs
- Ignorance of some people toward the disease and how it is spread.

## Answers for self-assessment 17.1

### 1) Koch's Postulates

- Postulate 1: A specific organism must always be observed in association with the disease.
- Postulate 2: The organism must be isolated from an infected host and grown in pure culture in the laboratory.
- Postulate 3: When the organism from the pure culture is inoculated into a susceptible host organism, it must cause the disease.
- Postulate 4: The infectious organism must be re-isolated from the diseased organism and grown in pure culture.

### 2) Expected answers:

- The theory of spontaneous generation was not used to explain how living organisms' canaries from non-living matter.
- When food became covered in microbes, maggots, flies, and rodents: these organisms were created by and arose from the food itself
- When the food became covered in microbes, maggots, flies, and rodents: these organisms were caused by tiny microorganisms invading a host organism.
- The theory of spontaneous generation was not used to explain why heat and refrigeration are best for preserving food

## Lesson 2: Classification of diseases

### a) Prerequisites/Revision/Introduction

This is the second lesson of the fifteenth unit. In this lesson you will be dealing with Categories of diseases. The first thing to do before starting teaching is to remind students that they have learnt about infectious diseases and non- infectious diseases in Senior one and ask them to discuss some disease they remember so that they can prepare themselves for this lesson.

## b) Teaching resources

Students' books, graph charts, simulations and computer animations, projector, Microscope, Manila paper with diagrams for improvisation

## c) Learning activity 17.2

As facilitator help the learners to develop competences in the following:

- Ask students to do in pair activity 15.2 in student's book.
- Provide the necessary materials to the learners.
- Move around in silence to monitor if they are having some problems, sharing ideas in pair.
- Encouraging slow learners during activity but without giving them the knowledge.
- Invites any three pairs to present their findings to the rest of students.
- Ask other students to follow carefully the presentations
- Note on chalk board / Manila paper the student's ideas.
- Tick the correct findings and correct those ones which are incorrect and try again to complete those which are incomplete.
- Harmonize and conclude on the learned knowledge and still engage students in making that conclusion.

## Answers for activity 17.2

- 1) There are many different diseases. Students will choose any two by their choice. As a teacher you would consider any two diseases from students' answer.

Example:

Disease	causal agents name	causal agents type	symptoms	prevention methods	Treatment
Cholera	Vibrio cholera	Bacterium	Abdominal pain vomiting Rapid dehydration diarrhea	Use clean drinking water, Proper treatment of sewage and sanitation Vaccination	tetracycline chloramphenicol



Malaria	Plasmodium falciparum, P. vivax, P. ovale, P. malariae	Protozoa	fever, anaemia, nausea, headaches, muscle pain, shivering, sweating, enlarged spleen	use insecticides, clean bushes, avoid stagnant water, sleep under net,	quinine and chloroquine, doxycycline
Tuberculosis	Mycobacterium tuberculosis	Bacterium	racking cough, coughing blood, chest pain, shortness of breath, fever, sweating, weight loss	Vaccination	Streptomycin, rifampicin, isoniazid antibiotics
Typhoid	Salmonella typhus	Bacterium	Headache, Muscular pains, Fever, rash, diarrhea mental confusion	Proper treatment of sewage and disinfection of water supplies. -personal hygiene of food. Control of flies Vaccination	Take Chloramphenicol, Ampicillin, Ciprofloxin

2) Health includes mental, spiritual, and physical well-being as well as freedom from disease.

### Answers for self-assessment 17.2

1) Expected answers are

a) False b) True c) False d) False e) False

2) Morbidity refers to incidence of disease whereas mortality refers to deaths associated with the disease.

## Lesson 3: Common infectious diseases

### a) Prerequisites/Revision/Introduction

This is the third lesson of the fifteenth unit. In this lesson you will be dealing with different infectious diseases, their mode of transmission and symptoms, modes of prevention and treatment. The first thing to do before starting teaching is to remind students that they have learnt about infectious diseases in senior two, and ask them to list some infectious diseases and their causal agents they know, so that they can prepare themselves for this lesson.

### b) Teaching resources

Students' books, graph charts, simulations and computer animations, projector, Manila paper with diagrams for improvisation

### c) Learning activity 17.3

As facilitator help the learners to develop competences in the following:

- Ask students to do in pair activity 17.3 in student's book.
- Provide the necessary materials to the learners.
- Remember to help the students with disabilities if you have them in your class.
- Move around in silence to monitor if they are having some problems, sharing ideas in pair.
- Encouraging slow learners during activity but without giving them the knowledge.
- Invites any three pairs to present their findings to the rest of students.
- Ask learners to presents their findings to the rest of the classmates by using computer and projector.
- Ask other students to follow carefully the representations
- Note on chalk board / Manila paper the student's ideas.
- Tick the correct findings and correct those ones which are incorrect and try again to complete those which are incomplete.
- Harmonize and conclude on the learned knowledge and still engage students in making that conclusion

### Answers for activity 17.3

The infectious diseases are: Cholera, typhoid, tetanus, tuberculosis, AIDS, polio, measles, Ebola, malaria, sleeping sickness, trichomoniasis, candidiasis, athlete's foot, ring worms, elephantiasis, bilharzias, syphilis, gonorrhoea.

The above diseases are infectious ones because:

- They are caused by germs
- They are transmitted from one person to another

### Answer for self-assessment 17.3

- 1) Answer is C
- 2) Bacteria pass out in faeces of infected person; carried in, water / food, consumed by uninfected person.
- 3) Cholera is a serious disease; death can occur very quickly after infection; spreads quickly in population (especially after a disaster); deaths are avoidable.
- 4) There is a high death rate from TB in countries with a high proportion of the population who are HIV-positive because:
  - TB linked with HIV infection
  - HIV weakens immune system
  - TB is an opportunistic disease
- 5) TB is an opportunistic infection because it strikes many people with a depressed immunity.
- 6) A female Anopheles (mosquito) takes a blood meal from an infected person; transfers parasite / pathogen / Plasmodium, in saliva when takes a blood meal from an uninfected person.

## Lesson 4: Health and community: criteria for good housing

### a) Prerequisites/Revision/Introduction

This is the fourth lesson of the unit fifteen. The learners already know different kinds of diseases and how to fight against them, and you are recommended to help them to discover the health impacts of housing quality. You will use the learner's ideas through group discussion about Rwanda housing conditions and learner's presentations.

### b) Teaching resources

This lesson requires some materials as cited below: Students' books, simulations and computer animations, projector, Manila paper with diagrams for improvisation, graph charts for different houses.

### **c) Learning activities 15.4**

As facilitator help the learners to develop competences in the following:

- Tell the learners to move outside the school.
- Ask learners to observe different houses around the school.
- Ask learners to compare those houses with ones of the village the come from
- Supervise the work how it is conducted and give the learners' opportunity to work in their respective groups.
- Ask learners to present what they have discovered.
- Help learners to summarize what they have learnt.
- Guide the learners to understand the importance of good housing in promoting good health

### **Answers for activity 17.4**

1) Different factors of housing quality associated with morbidity

- Infectious diseases
- Chronic illnesses
- Injuries
- Poor nutrition
- Mental disorder

### **Answer for self-assessment 17.4**

Measures are taken by Rwanda government to ensure high quality of housing conditions. To answer this question student might give different ideas. As a teacher, you can help by giving the following answers:

- Rwanda government has initiated a good project named "Bye Bye Nyakatsi" where all Rwandans could participate and get rid of grass thatched houses in our country.
- Rwanda government is aiming at constructing the model villages for the disadvantaged and poor families in different districts countrywide.
- Construction and rehabilitation of houses are controlled to ensure the high quality of housing conditions.
- Shifting people from danger zones not planned for habitation.
- Prohibition of sleeping with animals especially goats and cows in the same house
- Provision of electricity and water in villages

## Lesson 5: Public health services

### a) Prerequisites/Revision/Introduction

This is the fifth lesson of the fifteenth unit Classification and patterns of disease. In this lesson Public health services, you will be dealing with organization and functions of local state and international health services, food inspection and need for control of housing conditions, clean water, hygiene. The students already know different kinds of diseases and how to fight against them, and you are recommended to help them to discover health impacts of housing quality, clean water, and hygiene. You will use the learner's ideas through group discussion about the initiative of Rwanda Government for Rwandan's health promotion and assist learner's presentations.

### b) Teaching resources

Students' books, graph charts, simulations and computer animations, projector, Manila paper with diagrams for improvisation

### c) Learning activity 17.5

As facilitator help the learners to develop competences in the following:

- Ask students to do in individually activity 15.5 in student's book.
- Provide the necessary materials to the learners.
- Move around in silence to monitor if they are having some problems.
- Encouraging slow learners during activity but without giving them the knowledge.
- Invites any three students to present their findings to the rest of students.
- Ask other students to follow carefully the representations
- Note on chalk board / Manila paper the student's ideas.
- Tick the correct findings and correct those ones which are incorrect and try again to complete those which are incomplete.
- Help learners to harmonize and conclude on the learned knowledge and still engage students in making that conclusion.

### Answer for activity 17.5

1) The main requirements for good production to be inspected:

- Quantity
- Packing
- Labeling
- Dimension
- Weight and visual aspects.

2) The ways you can clean water at home are:

- Use of Sûr-eau
- Heating water.
- Using water purification etc. The steps of water purification are: storage reservoir, aeration, filtration, disinfection, reduction of chlorine concentration, covered service reservoir, distribution.

### **Answer for self-assessment 17.5**

1) Ways by which a personal cleanliness may be achieved.

- Hands should always be washed thoroughly with soap before preparing food, eating and after a visit to a toilet.
- Hands frequently touch many things which may carry pathogens.
- Fingernails and toenails should always be kept short and clean so that they do not provide breeding places for germs.
- It is essential to bathe frequently. This helps to prevent skin infections. Sweat and oil secretions on the skin enable bacteria and fungi to breed easily. Bath towels and sponges should not be shared with other people.
- Hair should be washed frequently to avoid lice and mites. These can spread typhus fever. Combs and hairbrushes should not be shared.
- The spaces between teeth where food particles are trapped provide excellent breeding grounds for bacteria. Teeth should therefore be cleaned at least twice a day, preferably after each meal.
- Cloths must be clean and changed frequently.
- Shoes should be worn to prevent cuts and infection by hookworms

2) How to promote hygienic food preparation

- Washing hands while preparing food
- Proper cleaning of food preparation areas
- After touching uncooked food and while preparing meals, wash the hands.
- Refrigeration of foods.
- Proper disposal of food and packaging

3) Good personal Hygiene

- Daily washing of the body and hair by using soaps
- Wash more frequently the hands or face
- Cleaning of clothes and living places
- Cover the mouth with hand while sneezing or coughing.

## 17.6 Summary of the unit

This unit of Classification and pattern of diseases comprises five lessons. Germ theory states that many diseases are caused by the presence and actions of specific microorganisms within the body. Spallanzani and Louis Pasteur observed germs in the blood of people suffering from disease; they suggested that the germs were an effect of the disease, rather than the cause. The work of Jenner and Semmelweis directed doctors and scientists to think that perhaps infectious diseases were caused by an infectious agent or 'germ.'

Louis Pasteur developed the germ theory of disease which postulates that all contagious and infectious diseases must be caused by pathogenic microorganisms.

Many types of diseases are broadly divided into two categories: Infectious diseases and Non-infectious diseases. Pathogens can spread when you have direct contact with an infected person. Pathogens can also be spread in contaminated food, water or air. Infected animals can spread pathogens to people. The study of patterns of disease and of the various factors that affect the spread of disease is called epidemiology.

Endemic disease is a disease that is always present in people e.g. malaria in tropical Africa. Epidemic disease is a disease that spreads rapidly, suddenly, and unexpectedly to affect many people e.g. cholera in refugees' camp.

Pandemic disease is a disease that affects people over very large area, such as a continent or even the whole world e.g. AIDS and TB are pandemic at present. Non-infectious diseases are also called non-communicable diseases. They are diseases that cannot be transmitted from one person to another example: albinism, kwashiorkor, cancer, diabetes, etc.

Housing refers to houses or buildings, accommodation of people. It is an important determinant of health, and substandard housing is a major public health issue.

For being healthy, only clean water must be used. Different materials are used to clean water. Health is defined as a state of complete physical, mental and social well-being and not merely the absence of disease and infirmity. Exercise, recreation and rest are other factors apart from hygiene that are important in promoting health.

## 17.7 Additional Information for teacher

Do your best to be familiar with this unit, you should read different books and search on internet whenever is available so that can be able to complete some student's incomplete findings.

Be creative when you are introducing this unit to help students to engage themselves in different lessons. We welcome your advices, corrections and questions.

## 17.8 Answers for end unit assessment

1) Expected answers are:

a) Germ theory of disease is a theory which states that “many diseases are caused by the presence and actions of specific micro-organisms within the body.”

b) Any four causes of diseases in our life.

- Genetic fault that may be passed from parents to children
- A gradual decline in function often associated with ageing.
- Drug dependence, often induced by social pressure and social behaviour.
- Disorder in mind which may or may not have a physical or chemical cause.
- Under eating or overeating
- Poor diet lacking one or more essential nutrients.
- Pathogen like bacteria, viruses, protozoa, fungi, worms.
- Drug abuse

2) Any two diseases caused by:

a) Bacteria

- Cholera, typhoid, tetanus, tuberculosis, etc.

b) Protozoa

- Malaria, sleeping sickness, trichomoniasis, etc.

c) Microscopic fungi

- Candidiasis, athlete’s foot, ring worms, etc.

3) Matching the scientists with their Scientific contributions

1----->B

2----->C

3----->A, D and E

4)

a) The vector of malaria is “female Anopheles mosquito”

b) Is D which takes place in red blood cell and C takes place in the hepatic cell (liver?)

c) Any two symptoms of malaria displayed in individual in stage E

- Fever, anaemia, nausea, headaches, shivering, etc.

5) Malaria is endemic disease in tropics because

- Tropical climate provides the best breeding and living conditions for the Anopheles mosquito which transmits malaria



- The Anopheles cycle requires areas of stagnant water and these are common within tropics
- In the tropical areas there is presence of bushes or abundant vegetation which makes suitable habitat for mosquitoes
- Plasmodium needs temperature in excess of 20°C for it to complete its cycle within the mosquito.

6) The biological factors that make malaria a difficult disease to control.

- There is no effective vaccine against malaria
- The pathogens are transmitted by mosquitoes which are not eradicated.
- The plasmodium have become resistant to different anti-malarial drugs
- Ignorance of some people toward the disease and how it is spread.

7) The precautions that people can take to avoid catching malaria.

- Drainage of stagnant water: The larval stages of the mosquito live in stagnant water, so drainage removes breeding sites. This has had some success.
- Destruction of the breeding sites of the mosquito: The larvae and pupae of mosquitoes obtain their oxygen by means of small tubes which are pushed through the water surface film. Thus any method of blocking these tubes will result in the death of the intermediate life stages of the mosquito (petrol, oil...)
- Destruction of the adult mosquitoes: This is aimed at killing the mosquitoes that enter houses. Thus, the indoor surfaces are sprayed with a persistent insecticide.
- Clean bushes nearest their homes where mosquitoes lay eggs
- Avoid stagnant water where mosquitoes lay eggs
- Sleep under net to avoid the bite of mosquitoes during the night
- Control birth that leads to population growth and this contributes to disease spread.

8) Ring vaccination is a vaccination of everyone within a certain place of \_\_\_\_\_ the outbreak of the disease.

## 17.9 Additional activities

### 17.9.1 Remedial Activities:

- 1) Among scientists you know, who has developed the germ theory of disease
- 2) Diseases are broadly divided into two categories. What are they?
- 3) What do you think is a causal agent of cholera?

- 4) What do understand with Housing?
- 5) What steps do you use to purify water at home?

**Expected answers:**

- 1) Louis Pasteur
- 2) two categories of diseases are
  - Infectious diseases
  - Non-infectious diseases
- 3) Vibrio cholerae.
- 4) Housing refers to houses or buildings, accommodation of people.
- 5) Storage reservoir, aeration, filtration, disinfection, reduction of chlorine concentration, covered service reservoir, distribution.

**17.9.2 Consolidation activities:**

- 1) Tell about the work of microbiologist Robert Koch on Cholera
- 2) Differentiate Antibody from Antigen.
- 3) Comment on inherited diseases
- 4) Suggest the importance of living in good house
- 5) In your own words explain how exercise is highly important in the promotion of good health.

**Expected answers:**

- 1) Robert Koch isolated the bacterium Vibrio cholerae which cause a Cholera disease
- 2) Difference between Antibody and Antigen is:
- 3) Antibody: is a protein produced by the body's immune system when it detects harmful substances called antigen while Antigen is any substance that causes your immune system to produce antibodies against it.
- 4) Comment on inherited diseases:

Inherited diseases are caused by a genetic fault that may be passed from parents to offspring.

- 5) Importance of living in good house is
  - Prevention of infectious disease
  - Prevention of jiggers attack
  - Prevention of injuries from small animal bites
  - It gives confidence in community

- It gives the value in community...
- Importance of exercise in the promotion of good health:
- Exercise makes the muscles strong so that they can support the body better.
- Exercise helps to get rid of excretory materials and to improve digestion.
- Exercise quickens blood circulation and improves the action of the glands and nerves.

### 17.9.3 Extended activities

- 1) What are contributions of Louis Pasteur in microbiology and medicine?
- 2) Explain how to calculate the incidence rate and mortality rate.
- 3) Work on the following question

Observe the figure and answer to the question below.



- a) What is this figure presenting?
- b) Give the effect of living organism in figure to human body life?
- 4) Observe the figure 15.7 in student book of Grass thatched houses of house quality and link it to health problems and personal community consideration
- 5) Give at least four ways by which the Personal cleanliness may be achieved in Rwanda

### Expected answers:

- 1) Contributions of Louis Pasteur in microbiology and medicine are:
  - The fight against spontaneous generation theory
  - The technique of sterile culturing of microorganisms
  - The technique of fermentation and conservation of drinks. That technique is known as Pasteurization; by treating drinks (wine and milk) at a brief period on moderate heating.
  - The technique of antiseptic surgery to prevent contamination of wounds during the surgical operations in hospitals.

2) How to calculate the incidence rate and mortality rate?

$$\text{Incidence / morbidity rate} = \frac{\text{number of cases of a given disease}}{\text{number of individuals in the population}} \times 100$$

$$\text{Mortality rate} = \frac{\text{number of death due to a given disease}}{\text{number of individuals in the population}} \times 100$$

Alternatively, it may be calculated using only those people who have disease.

$$\text{Mortality rate} = \frac{\text{number of deaths due to a given disease}}{\text{number of population with the same disease}} \times 100$$

3) Expected answer are:

a) The figure is presenting Salmonella typhus

The effect of Salmonella typhus to human body life is that it causes the disease Typhoid

4) Expected answers:

**For health problems, this kind of house may cause the following:**

- Accidents from house damaging and easy burning
- Infectious diseases like Tuberculosis and Malaria
- Injuries due to different animals' bites
- Mental disorders
- Jiggers attack...

**For community consideration**

- Lack of confidence for those people who live in this kind of house
- Community does not give value to those people who live in this kind of house
- Lack of personal and environmental hygiene
- Community considers people living in this kind of house as a burden to the society...

5) Ways by which the Personal cleanliness may be achieved are:

- Hands frequently touch many things which may carry pathogens. They must be always washed using a soap before preparing food, eating and after a visit to a toilet.
- It is essential to bathe frequently because sweat and oil secretions on the skin enable bacteria and fungi to breed easily. This helps to prevent skin infections.
- Bath towels and sponges should not be shared with other people
- Combs and hairbrushes should not be shared.

- Hair should be washed frequently to avoid lice and mites. These can spread typhus fever.
- Teeth should therefore be cleaned at least twice a day, preferably after each meal because the spaces between teeth where food particles are trapped provide excellent breeding grounds for bacteria.
- Clothes would be clean and changed frequently.
- Shoes should be worn to prevent cuts and infection by hookworms.
- Finger nails and toe nails must be always kept short and clean so that they do not provide breeding places for germs.



## 18.1 Key Unit Competence

Describe the structure and characteristics of viruses, bacteria, and fungal and non-fungal moulds.

## 18.2 Prerequisite (knowledge, skills and attitudes)

In order to succeed well this unit, students should possess knowledge and understanding, skills and attitudes that are related to classification of living things, Classification of diseases, infectious diseases and non-infectious diseases in Unit 11 and Unit 12 of senior 1 and 2 respectively. They should also be able to do observation, analysis, interpretation of the pictures and then capable to present and or communicate the results.

## 18.3 Cross-cutting issues to be addressed

### a) Inclusive education:

Since this unit requires observation and listening, special educational attention should be done for children with visual and hearing impairment. Thus, you need to:

- Group students with special educational needs with others and assigned roles basing on individual student's abilities.
- Provide procedure earlier before the experiment so that students get familiar with them. They can be written on the chalkboard or printed depending on available resources. If you have children with low vision remember to print in appropriate fonts.
- Every important point is written and spoken. The written points help students with hearing impairment. Speaking aloud helps students with visual impairment
- Repeat the main points of the lessons.

## **b) Gender education**

Involve both girls and boys in all activities: No activity is reserved only to girls or boys.

Teachers should ensure equal participation of both girls and boys during experiments as well as during cleaning and tidying up related activities after experiments.

## **c) Standardization culture**

Some lessons involve carrying out experiments. Instruction should be clear for learners to always check if they are not using expired chemicals or defective apparatus.

## **18.4 Guidance on the introductory activity**

This introductory activity helps you to engage learners in the introduction of microbiology and invite the learners to follow the next lessons.

- Ask students to read and discuss the given questions.
- Engage students in working collectively the activity.
- Help students with disabilities or with different problems.
- Write the summary of the group discussions
- Ask any four students to present their findings while others are following

### **The expected answer for introductory activity**

Because fresh milk was contaminated by microorganisms such as bacteria and some fungi.

Food in a saucepan was exposed to harmful microorganisms that made to go bad.

Food in the flask was preserved and prevented from contamination by microbes thus unaffected.



## 18.5 List of lessons/sub-heading

	Lesson title	Learning objectives (from the syllabus including knowledge, skills and attitudes)	Number of periods
1	Introduction to microbiology	<p>Explain how and why Archaeobacteria are thought to have been the first forms of life.</p> <p>Describe the main structural forms of Eubacteria.</p> <p>Explain how harmless bacteria can be changed into potentially lethal ones.</p>	1
2	The structure and life cycle of Escherichia coli	Describe the structure and lifecycle of Escherichia Coli.	1
3	The structure and life cycle of viruses	<p>Describe the basic structure of viruses.</p> <p>Explain how a retrovirus reproduces.</p> <p>Describe how plant viruses can be transmitted.</p>	2
4	Moulds	<p>Describe the main features of moulds.</p> <p>Describe the structure of Mucor hyphae.</p> <p>Explain how Mucor and Rhizopus feed and reproduce.</p>	3
5	Penicillium and Saccharomyces	<p>Describe the structure of a yeast cell.</p> <p>Explain how Saccharomyces reproduce.</p>	2
6	Protozoa that cause disease	Describe the structure and life cycle of pathogenic protozoa limited to Entamoeba hystolitica, Plasmodium and Trypanosoma.	3
	Assessment	Students can clearly describe the structure and characteristics of viruses, bacteria, and fungal and non-fungal moulds.	2

## Lesson 1: Introduction to microbiology

### a) Prerequisites/Revision/Introduction

This is the first lesson of the eighteenth unit Microbiology. In this lesson you will be dealing with microorganisms and their classification. The first thing to do before starting teaching is to remind students that they have learnt about microbes and infectious diseases, (unit 12, Senior 2), and ask them to discuss the meaning of some terms used in microbiology so that they can prepare themselves for this lesson.

### b) Teaching resources

Different student's books, different biology lab materials, graph charts, simulations and computer animations, projector, Manila paper with diagrams for improvisation.

### c) Learning activity 18.1

- Ask learners to do in groups activity 18.1 in their student books
- Provide the necessary materials.
- Move around in silence to see whether they are having some difficulties.
- Remember to assist slow learners but without giving them the knowledge.
- Remember to assist students with disabilities.
- Invites any two groups to present their findings to the rest of students.
- Ask other students to follow carefully the representations.
- Note on chalk board / Manila paper the student's ideas.
- Tick the correct findings and correct those ones which are incorrect and try again to complete those which are incomplete.
- Harmonize and conclude on the learned knowledge and still engage students in making that conclusion.

### Expected answers for activity 18.1.1

Microbiology is the study of microorganisms. Microorganisms are organisms that are too small to be seen with the naked eye, and usually require a microscope to be seen. They are also referred to as microbes. They include bacteria, viruses, some fungi and protists.

### Answers for activity 18.1.2

#### a) Archaeobacteria

- Archaeobacteria were first discovered in extreme environments such as swamps, salt lakes, hot springs. Examples include:

### 1) Methanogens:

- They have unique method of harvesting energy by converting H<sub>2</sub> and CO<sub>2</sub> in methane.
- Methanogens can live only in anaerobic condition, such as the bottom of a swamp, and in sewage where they are the source of marsh gas, because oxygen is a poison to them.

### 2) Extreme homophiles:

- These are salt-loving archaeobacteria, live in environment with very high salt concentration such as the Dead Sea. High salt concentration would kill most bacteria, but this high concentration is benefic to the growth of extreme homophiles.
- These organisms use salt to generate ATP.

### 3) Thermoacidophiles:

- This third group of archaeobacteria lives in extremely acidic environments that have extremely high temperature such as hot springs. Thermoacidophiles live at 110°C and at a pH of 2.
- Thermoacidophiles live near volcanic vents on land or near hydrothermal vents.

## b) Eubacteria

They occur in many shapes and sizes and have distinct biochemical and genetic characteristics.

Most Eubacteria have one of the three basic shapes. Eubacteria that are rod-shaped are called bacilli, sphere-shaped are called cocci (sing. Coccus) and spiral-shaped are called **spirilla** (sing. spirillum).

- The **bacilli**: bacteria with rod-shape. For example, *Clostridium tetani*, *Bacillus subtilis*
- Vibrio: comma-shaped with a single flagellum. E.g.: *Vibrio cholera*
- The cocci: bacteria with spherical shape.e.g. **Streptococci**: cocci occur in chains Staphylococci: grapelike clusters of cocci and Diplococci which is sphere shaped that are grouped two by two.
- The spirilla: bacteria with spiral shape. e.g.: *Spirillum volutans*.

## Expected answers for self-assessment 18.1

- 1) Archaeobacteria lack peptidoglycan and their membrane lipids are quite different. Also, the DNA of key Archaeobacterial genes is like those of eukaryotes.
- 2) They are identified by their shapes, the chemical nature of their cell walls, the ways they move and the ways they obtain energy.
- 3) Bacteria are essential to maintaining the living world. Some are producers, others are decomposers, and others are useful to humans.
- 4) Cell wall, cell membrane, cytoplasm, DNA, ribosomes, pili and flagella.
- 5) Some consume organic molecules synthesised by other living organisms while others make their own food from simple inorganic molecules.

## Lesson 2: Structure and life cycle of Escherichia coli

### a) Prerequisites/Revision/Introduction:

This is the second lesson of the eighteenth unit. In this lesson you will be dealing with E. coli and poisoning of food. The first thing to do before starting teaching is to remind students what they have seen about harmful bacteria and their effects on food spoilage in Senior one and senior two and ask them to discuss some disease they remember so that they can prepare themselves for this lesson.

### b) Teaching resources

Students' books, microscope, different kind of food, graph charts, simulations and computer animations, projector, Manila paper with diagrams for improvisation

### c) Learning activity 18.2

- Ask students to do in pair activity 18.2 in student's book.
- Provide the necessary materials to the learners.
- Move around in silence and see if they sharing ideas in pair.
- Assist slow learners but without giving them the knowledge.
- Remember to assist student with disabilities
- Invites any three pairs to present their findings to the rest of students.
- Ask other students to follow carefully the representations
- Note on chalk board / Manila paper the student's ideas.
- Tick the correct findings and correct those ones which are incorrect and try again to complete those which are incomplete.

- Harmonize and conclude on the learned knowledge and still engage students in making that conclusion

### Expected answers for activity 18.2.1

Life cycle of *E. coli* occurs both asexually and sexually. Asexual reproduction occurs by binary fission and sexually by conjugation. The most prevalent reproduction for *E. coli* is asexual reproductions which take place when the *E. coli* is undergoing binary fission. This type of reproduction begins with the replication of one DNA molecule.

Secondly, the copies of the genetic material attach themselves to the cell membrane.

Thirdly, when the bacterium's size has doubled from its original size, the cell membrane starts pinching inward.

Fourthly, between the two DNA molecules, a cell wall is produced. Lastly, the cell wall divides the cell into two daughter cells.

*E. coli* can also go through a second process of reproduction known as conjugation. Conjugation is a reproduction process which involves the transferring of genetic material by the sex pili between two bacteria. Basically, one has to take in consideration that this is not a sexual reproduction because there is no combination of the gametes.

### Expected answers for activity 18.2.2

**Evolution of harmful strain:** new strain of *E. coli* evolved into a much more dangerous organism. The strain acquired a gene that enabled it to produce a powerful toxin which damages the intestinal wall, causing severe diarrhoea and internal bleeding.

This may lead to internal serious dehydration and in young children and elderly people may result into death. In majority of the cases, infections of pathogenic strain of *E. coli* are not fatal and the disease clears without treatment.

**How does *E. coli* cause food poisoning?** *E. coli* is everywhere in the environment, but the deadly strain is rare. Nevertheless, it takes only ten or so of the pathogenic *E. coli* to infect a person. An outbreak of *E. coli* food poisoning was traced to drinking fresh apple juice.

Therefore, touching a source of contamination and not washing hands before handling food may be enough to cause the infection.

Meat is not the only source of infection. Contaminated person can pass the bacteria on to vegetables, and other foods. It is therefore, important to practice good hygiene even if not handling raw meat.

### **Expected answers for self-assessment 18.2**

- 1) Asexually by binary fission and sexually by conjugation.
- 2) Bacteriophage gene.
- 3) Higher than 72oc.
- 4) If food is contaminated by harmful E. coli when handling food unwashed hands.
- 5) Food can be preserved by: Food storage, packaging, pasteurisation and sterilisation.

## **Lesson 3: Structure and life cycle of viruses**

### **Prerequisites/Revision/Introduction**

This is the third lesson of the eighteenth unit. In this lesson you will be dealing with structure and life cycle of viruses, some common viral diseases, features that make virus look like living thing, features that make viruses non-living things. The first thing to do before starting teaching is to remind students that they have learnt about microbes including viruses in senior one, and ask them to list some diseases caused by viruses and their causal agents they know, so that they can prepare themselves for this lesson.

### **b) Teaching resources**

Students' books, graph charts, simulations and computer animations, projector, manila paper with diagrams for improvisation

### **c) Learning activity 18.3**

- Ask students to do individually an activity 18.3 in students' book.
- Provide the necessary materials to the learners.
- Remember to help the students with disabilities if you have them in your class.
- Move around in silence to monitor if they are having some problems.
- Assist slow learners but without giving them the knowledge.
- Invites any three learners to present their findings to the rest of students.
- Ask other students to follow carefully the representations
- Note on chalk board / Manila paper the student's ideas.
- Tick the correct findings and correct those ones which are incorrect and try again to complete those which are incomplete.

- Harmonize and conclude on the learned knowledge and still engage students in making that conclusion
- Exploitation of findings after presentation.
- Analyze and evaluate the students' findings and tell about those ones which are not complete, which are correct or incorrect.
- Together your students make a conclusion.

### Expected answers for activity 18.3.1

Structurally, viruses consist of either **ribonucleic acid (RNA) or deoxyribonucleic acid (DNA)**-never both plus a protective coat called capsomere made of protein or of protein combined with lipid or carbohydrate components.

**Vibrio**, is an entire virus particle, consisting of an outer protein shell called a capsid and an inner core of nucleic acid (either ribonucleic or deoxyribonucleic acid-RNA or DNA). The core confers infectivity, and the capsid provides specificity to the virus.

Viruses replicate by using either the lytic cycle or the **lysogenic cycle**.

Viruses affect humans and plants by causing various diseases including HIV/AIDS, polio, small pox, measles etc.

### Expected answers for activity 18.3.2

- The lytic cycle consists of five phases:
- The Bacteriophage first attaches to susceptible bacterium by attaching its tail fibers to a receptor site.
- Next the Bacteriophage releases an enzyme that weakens a spot in the cell wall of the host.
- Then the phage presses its sheath against the cell and injects its DNA into the host cell through the weak spot in the cell wall.
- The Bacteriophage leaves its capsid outside.
- The virus then takes control of the host's protein synthesizing mechanisms, transcribing mRNA from the viral DNA.
- The resulting Bacteriophage DNA is translated by ribosomes and enzymes that form Bacteriophage capsid. So the viral DNA is also replicated during this phase.
- The replicated viral genes are enclosed in the newly created virus capsid.
- During the last phase of the lytic cycle, one of the enzymes that are produced by the Bacteriophage genome causes the host cell to disintegrate, releasing new Bacteriophage. The cell disintegration is called lysis.

The enveloped viruses, the newly formed viruses move to the cell surface and force their way through the cell membrane.

### Expected answers for activity 18.3.3

Viruses that stay in their host cell for an extended period of time: days, months or years are in a lysogenic cycle. A virus that replicates through lysogenic cycle and doesn't kill the host cell immediately is called a temperate virus. Lysogenic cycle occurs as follows:

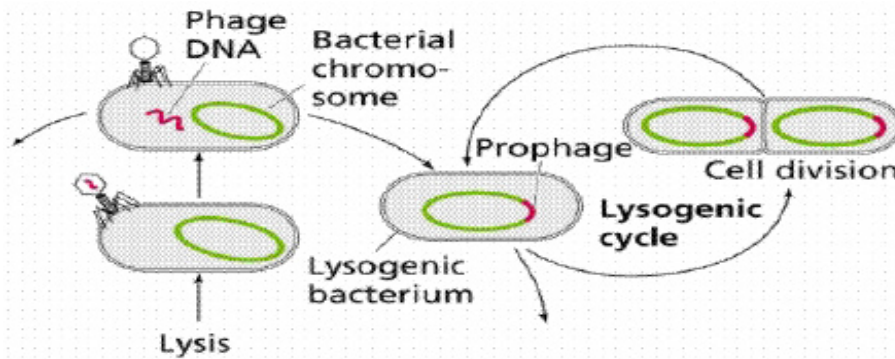

### Expected answers for activity 18.3.4

Some biologists say that they should be considered as living organisms because they possess the following features:

- They have the genetic material composed of either DNA or RNA not both.
- They cause diseases to other living things: All viruses are infectious.
- They evolve as a result of mutation and natural selection.
- They reproduce /multiply only in other living things: they are obligate intracellular parasites.
- **However**, some biologists insist that they should be regarded as non-living things due to the fact that:
  - They cannot metabolize.
  - They crystallize when in isolation.
  - They cannot reproduce outside of host.
  - They are not made of cells. This means that they have a relatively simple non-cellular organisation.
  - They cannot respond to stimuli
  - They have one type of nucleic acid, either DNA or RNA. But living cells contain both DNA and RNA.

### Expected answer for self-assessment 18.3

- 1) A bacteriophage is a virus that infects bacteria while a prophage is the lysogenic viral DNA that is embedded in the host's DNA.



- 2) A retrovirus is a virus that contains RNA.
- 3) The strength of the hypothesis is that it explains the observations. One of the weaknesses is that the viruses could not be seen, so there is no direct evidence that they exist.
- 4) One characteristic feature common to all viruses is that they enter living cells and, once inside, they use the machinery of the infected cell to multiply.
- 5) It is essential because it binds to the surface of the cell and tricks the cell into allowing it inside. Once inside, the viral genes take over.
- 6) The best way is prevention. Because once a viral disease has been contracted, it might be too late, to control the disease.

## Lesson 4: Moulds

### a) Prerequisites/Revision/Introduction

This is the fourth lesson of the unit eighteen. The learners already know two different types of fungi macroscopic and microscopic fungi in ordinary level biology, you are recommended to help them to discover the health impacts of moulds. To help, you will use the learner's ideas through group discussion about life cycle of different moulds and learner's presentations.

### b) Teaching resources

This lesson requires some materials as cited below: Students' books, simulations and computer animations, projector, Manila paper with diagrams for improvisation, graph charts for spoiled food.

### c) Learning activity 18.4

- Tell the learners to make research in groups of four members about life cycle of bread mould.
- Provide necessary materials for easing the learners' work
- Supervise the work how it is conducted and give the learners' opportunity to work in their respective groups.
- Remember to assist learners with disabilities.
- Ask learners to present what they have discovered.
- Help learners to summarize what they have learnt.
- Guide the learners to understand the importance of checking the expiry date of bread before taking it in.
- Together your students make a conclusion

#### d) Expected answer for activity 18.4

##### Life cycle of a bread mould

Asexual reproduction takes place, when cells or hyphae break off from a fungus and begin to grow on their own and sexual reproduction occurs by conjugation as described in the student book in the activity 18.4. The sexual reproduction involves conjugation. It occurs as follows:

Two hyphae from different mating types come together, making gametangia. Haploid gametes produced in the gametangia fuse with gametes of opposite mating type to form diploid nuclei. A thick wall develops around the nuclei producing zygospores that may remain dormant for months. When conditions become favorable, the zygospore germinate, undergo meiosis and develops into a new individual.

#### Expected answer for self-assessment 18.4

- 1) The cells of fungi are similar to the exoskeletons of insects in which both contain chitin.
- 2) Hyphae are tiny filaments that are only one cell thick while the mycelium is a thick mass composed of many hyphae tangled together.
- 3) Spores must land in favorable conditions. There must be a proper combination of temperature, moisture and food.
- 4) Fungi are classified according to their structure and method of reproduction.
- 5) Like ascomycete *Penicillium* reproduces asexually via conidia.
- 6) Asexual reproduction takes place, when cells or hyphae break off from a fungus and begin to grow on their own. Some fungi also produce asexually by spores. Sexual reproduction in fungi usually involves two different mating types which mate to form zygote nuclei.
- 7) Answers may vary. A typical answer might suggest that bacteria and fungi compete for the same source and fungi evolved a mechanism for killing bacteria.

### Lesson 5: *Penicillium* and *Saccharomyces*

#### a) Prerequisites/Revision/Introduction

This is the fifth lesson of the eighteenth unit. In this lesson *Penicillium* and *Saccharomyces*, you will be dealing with *Penicillium* and **antibiotics, the structure of *Penicillium***, the students already know different kinds of fungi and you are recommended to help them to discover the impact *Penicillium* and *Saccharomyces* in human life. You will use the learner's ideas through group discussion about the impact *Penicillium* and *Saccharomyces* for Rwanda's health promotion and assist learner's presentations.

## b) Teaching resources

Students' books, graph charts, simulations and computer animations, projector, manila paper with diagrams for improvisation

## c) Learning activity 18.5

- Ask students to do in individually activity 18.5 in student's book.
- Provide the necessary materials to the learners.
- Move around in silence to monitor if they are having some problems.
- Assist slow learners but without giving them the knowledge.
- Invites any three students to present their findings to the rest of students.
- Ask other students to follow carefully the representations
- Note on chalk board / manila paper the student's ideas.
- Tick the correct findings and correct those ones which are incorrect and try again to complete those which are incomplete.
- Harmonize and conclude on the learned knowledge and still engage students in making that conclusion

## Expected answers for activity 18.5

Structure of Penicillium and yeast cell

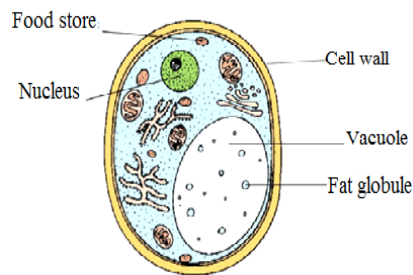
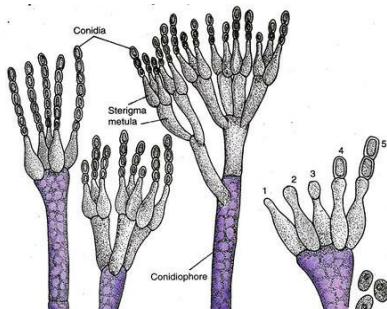

2) *Saccharomyces cerevisiae* can reproduce either asexually or sexually.

- In asexual reproduction, the single cell divides by budding and separate into two cells. Some buds group together to form colonies; other separate to grow individually into a new yeast.
- In sexual reproduction, two cells fuse to form a diploid cell which then forms haploid spores by meiosis

3) Budding is a type of asexual reproduction by which the new organism develops from an outgrowth known as bud through cell division at one particular part.

## Expected answer for self-assessment 18.5

1) Features that all yeast cells have in common are:

- Are all unicellular fungi
- They can reproduce asexually by budding
- They can reproduce sexually by fusion of two cells
- They contain a single nucleus and are usually egg shaped.
- The hyphae of *Penicillium* have cross-walls called septa but the ones of *Mucor* do not have septa.

3) Evidences for penicillin's effectiveness according to work of Fleming are:

- *Staphylococcus during experiment* has been destroyed by moulds.
- After studying *Staphylococcus* closely, Fleming concluded that the *Penicillium* mould was producing a substance that killed the *Staphylococcus*.
- Penicillin has treated wounded soldiers in Second World War.

## Lesson 6: Protozoa that cause disease

### a) Prerequisites/Revision/Introduction:

This is the fifth lesson of the eighteenth unit. In this lesson Protozoa that cause diseases, you will be dealing with characteristics, life cycle, symptoms, prevention of protozoa. The students already know different kinds of protozoa and you are recommended to help them to discover using different sources, the diseases caused by *Entamoeba histolytica*, plasmodium, and *Trypanosoma*. You will use the learner's ideas through group discussion about the characteristics and life cycle of some of protozoa and assist learner's presentations.

### b) Teaching resources

Students' books, prepared slides, graph charts, simulations and computer animations, projector, Manila paper with diagrams for improvisation.

### 2) Learning activity 18.6

- Ask students to do in groups activity 18.6 in student's book.
- Provide the necessary materials to the learners.
- Move around in silence to monitor if they are having some problems.
- Assist slow learners but without giving them the knowledge.
- Remember to assist learners with disabilities.
- Invites any three groups to present their findings to the rest of students.

- Ask other students to follow carefully the representations
- Note on chalk board / Manila paper the student's ideas.
- Tick the correct findings and correct those ones which are incorrect and try again to complete those which are incomplete.
- Harmonize and conclude on the learned knowledge and still engage students in making that conclusion

### Expected answer for activity 18.6

To answer the activity 18.6 students will be using microscope to observe the structure of Plasmodium, Entamoeba histolytica, Trypanosoma structures on prepared slides. Then, ask them to draw the viewed structure and compare them. Answers from students will not be similar. Guide them to summarize their observations and come up with the common consensus.

### Expected answers for self assessment 18.6

1) Name causal agent and vector of malaria:

a) *Plasmodium spp* (*P.falciparum*, the species that causes falciparum malaria, the most dangerous type of malaria; *P. malariae*, the species that causes quartan malaria; *P. ovale*, a species found primarily in east and central Africa that causes ovale malaria; and *P. vivax*, the species that causes vivax malaria, which tends to be milder than falciparum malaria.)

b) Female mosquitoes (the vector) belonging to the genus *Anopheles*.

2) Answers:

a) The vector of malaria is “female *Anopheles* mosquito”

b) Is D which takes place in red blood cell and C takes place in the hepatic cell (liver?)

c) Any two symptoms of malaria displayed in individual in stage E

d) Fever, anaemia, nausea, headaches, shivering, etc.

## 18.6 Summary of the unit

**Microorganisms** are organisms that are too small to be seen with the naked eye, and usually require a microscope to be seen. Microbiology is the study of microorganisms. Many microorganisms can be grown in the laboratory. Microorganisms include bacteria, viruses, some fungi and protists. Taxonomists used to classify all prokaryotes in kingdom monera, yet they slightly differ in characteristics.

Archaeobacteria were first discovered in extreme environments such as swamps, salt lakes, hot springs. Most Eubacteria have one of the three basic shapes. Eubacteria that

are rod-shaped are called **bacilli**, sphere-shaped are called **cocci** (sing. Coccus) and spiral-shaped are called **spirilla** (sing. Spirillum). *E. coli* is a rod-shaped bacterium measuring about 2.5µm by 0.5µm. It is mainly found in guts of vertebrates. It is chemoheterotroph, capable of thriving on a variety of the organic molecules. Its presence in water indicates contamination by faeces. In 1996, an outbreak of *E. coli* food poisoning was traced to drinking fresh apple juice. The existence of viruses was established in 1892, when Russian biologist **Dmitry Ivanovsky** discovered microscopic particles later known as the tobacco mosaic virus.

Viruses consist of either **ribonucleic acid (RNA) or deoxyribonucleic acid (DNA)**-never both-plus a protective coat called **capsomere** made of protein or of protein combined with lipid or carbohydrate components. DNA and RNA viruses differ in the way they use the host cell's machinery to produce new viruses. Bacteriophages are viruses that infect bacteria. Their discovery has increased biologist's understanding of virus replication. Viruses replicate by using either the **lytic cycle** or the **lysogenic cycle**.

**Viral diseases include:** Influenza, common cold, measles, mumps, Poliomyelitis and HIV/AIDS. The sexual reproduction involves **conjugation** whereas asexual reproduction occurs by spores. The non-fungal moulds include: bacterial moulds, slime moulds and water moulds. Spores of *Penicillium* are exposed and free to be dispersed as they are mature, but those of *Mucor* are enclosed in sporangia. *Entamoeba histolytica* is a protozoan parasite responsible for a disease called **amoebiasis**. Commonly known as African sleeping sickness, human trypanosomiasis is caused by the species *Trypanosomabrucei* and is transmitted to humans through either a vector or the blood of ingested animals.

### 18.7 Additional Information for teachers

Try your best to be familiar with this unit. Here you should read different books and search on internet whenever is available so that can be able to complete some student's incomplete findings. Be creative when you are introducing this unit to help students to engage themselves in different lessons. We welcome your advices, corrections and questions.

### 18.8 Answers for end unit assessment 18

1) Diseases caused by:

a) Bacteria: Tuberculosis, typhoid, cholera, tetanus, etc

b) Protozoa: Malaria, trichomoniasis, sleeping sickness, etc

c) Microscopic fungi: Ring worms, Candidiasis, athlete's foot, etc

2) The main feature of moulds is:

Moulds contain cells arranged in long thread-like filaments known as the hyphae, that form a mass called Mycelium

3) Viruses are not generally considered to be living things because:

- They cannot metabolize
- They crystallize when in isolation.
- They cannot reproduce outside of host.
- They are not made of cells. This means that they have a relatively simple non-cellular organisation.
- They cannot respond to stimuli
- They have one type of nucleic acid, either DNA or RNA. But living cells contain both DNA and RNA.

4) Answers:

a) Names of:

A: Cytoplasm

B: Mesosomes

C: Nucleoid region (DNA)

D: Flagellum

b) Importances of parts B, C and E

Parts	Importances
B	Respiration
C	Carries genetic information inherited from past generations
E	Protects the inner parts of bacteria

5) Answers

a) Names of the parts HIV virus

A: RNA

B: Reverse transcriptase enzyme

C: Protein coats

D: Glycoprotein

b) **Retrovirus** is RNA viruses that contain an enzyme called **reverse transcriptase** in addition to RNA. Reverse transcriptase uses RNA as a template to make DNA. The DNA then makes an RNA transcript of itself. This RNA is then translated into proteins that become part of new viruses. Reverse transcriptase is so given this name because it reverses the normal process of transcription, in which DNA serves as a template for producing RNA.

c) White blood cells mainly destroyed by HIV/AIDS are called **Helper T cells**.

6) The methods of reducing the risk of food poisoning by pathogenic bacteria are:

- Storage and packaging
- Pasteurization and sterilization

7) The hyphae of *Mucor* is called coenocytic because the fungal tissue is not separated by cell walls.

8) Answer

*Trypanosoma brucei*

b) Name of the parts:

A: Metacyclic trypomastigote

B: Long slender form

C: Short stumpy form

D: Procyclic trypomastigote

E: Long epimastigote

F: Attached epimastigote

9) Groups of bacteria

a. Bacillus

b. Coccus

c. Spirillum

d. Spirochete

e. Vibrios

f. Streptococcus

g. Staphylococcus

h. Diplococci

i. Chain of bacilli

## 18.9 Additional activities

### 18.9.1 Remedial Activities:

1) What do understand with prokaryote?

2) Most Eubacteria have one of the three basic shapes. What are those three shapes of Eubacteria?

3) Answer the following by true or false



The following is feature that makes viruses non-living things:

- a) Viruses crystallize when in isolation.
  - b) They cause diseases to other living things
  - c) They are not made of cells.
  - d) They cannot respond to stimuli
  - e) They evolve as a result of mutation and natural selection.
- 4) What do you think are two main types of moulds?
- 5) Who has discovered the antibiotic Penicillin?
- 6) Observe the following figure and answer the questions

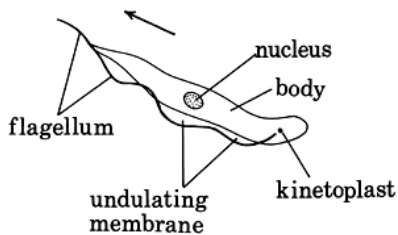

- a) What is this?
- b) Name its vector.

**Expected answers**

- 1) Prokaryote is a unicellular organism that lacks a membrane –bound nucleus, mitochondria and other membrane-bound organelle.
- 2) Shapes of Eubacteria are:
  - a) Bacilli: rod-shaped
  - b) Cocci (sing. Coccus). Sphere-shaped
  - c) Spirilla: (sing. Spirillum). Spiral-shaped
- 3) Answers
  - a) True b) False c) True d) True e) False

4) The two main types of moulds are fungal moulds and non-fungal moulds

5) Penicillin has been discovered by a scientist Sir Alexander Fleming

6) Answers:

a) Structure of Trypanosoma cell

b) Tsetse fly

### 18.9.2 Consolidation activities:

1) Suggest any three characteristics of prokaryotes

2) Suggest where Archaeobacteria are found in environment.

3) Complete the following table of some common viral diseases

Name of disease	Cause	Signs and symptoms
Influenza		
Measles		
Poliomyelitis (Polio)		
Yellow fever		
AIDS		
Hepatitis B		

4) Suggest any two uses of moulds

5) Explain how scientist Sir Alexander Fleming discovered antibiotics Penicillin.

6) What symptoms can help you to know that a person is suffering from *Entamoeba histolytica*?

### Expected answers:

1) Characteristics of prokaryotes are:

- The absence of a membrane around the nuclear materials
- The absence of clearly defined membrane-limited organelles like mitochondria, Golgi complex and lysosomes.
- The genetic material is located on a single chromosome which consists of circular double strand of DNA
- The absence of nucleolus and mitotic apparatus
- Etc.

2) Archaeobacteria were first discovered in extreme environments such as swamps, salt lakes, hot springs

3) Some common viral diseases

Name of disease	Cause	Signs and symptoms
Influenza	Myxovirus (DNA virus)	Sudden fever with headache, sore throat and muscular aches.
Measles	A paramyxovirus (RNA virus)	Occurs mainly in children. Sore throat, runny nose, watery eyes, cough and fever.
Poliomyelitis (Polio)	Poliovirus (a picornavirus) (RNA virus)	Fever, headache and feeling of stiffness in neck and other muscles. Nerve cells to muscles are destroyed causing paralysis and muscle wasting. Most cases of paralysis occur in children aged 4 – 12 years, but adults may be also affected.
Yellow fever	An arbovirus, that is arthropod-borne virus (RNA virus)	Fever, headache, backache, nausea, tenderness in pit of stomach. Affects lining of blood vessels and liver.
AIDS	HIV virus; a retrovirus (RNA virus)	Loss of appetite, loss of weight, fevers, persistent dry cough, ...
Hepatitis B	DNA virus	Infects liver, flu-like symptoms, jaundice, nausea and severe loss of appetite.

1) Uses of moulds

Even if species of *Rhizopus* and *Mucor* are responsible for the spoilage of food, they are also useful as follow:

- They are used to make the human foods. For example, *Mucor* is used with soya beans to make a cheese called sufu, in eastern Asia.
- In Indonesia, *R. oligosporus* and *R. oryzae* are used to produce a food called tempeh from boiled skinless soya beans.
- The fungal moulds belonging to the Zygomycota are used to make anaesthetics, birth control pills, meat tenderisers, and the yellow colouring agents used in margarines and butter substitutes.

## 2) Discovery of penicillium

Penicillin, the first antibiotic has been discovered in 1928 by a scientist Sir **Alexander Fleming** when he was culturing some *Staphylococcus* bacteria during his medical research. He left some Petri dishes for many days, and after he found a mouldy growth of *Penicillium notatum* contaminating a corner of one of dishes. Then Fleming realised that *Staphylococcus* next to the mould has been destroyed.

After studying *Staphylococcus* closely, Fleming concluded that the *Penicillium* mould was producing a substance that killed the *Staphylococcus*. He carried on with finding out if the broth of *Penicillium* mould contained penicillin which could destroy pathogenic bacteria.

## 3) The symptoms of *Entamoeba histolytica* are:

- Gas (flatulence) intermittent
- constipation loose stools
- stomach ache
- Stomach cramping.

### Extended activities

- 1) Compare between Phototrophs and Chemotrophs
- 2) Distinguish between Gram-positive and Gram-negative
- 3) By using the diagram discuss the life cycle of *Escherichia coli*
- 4) Using the table, compare between a virus and a living cell.
- 5) Draw and label the structure of typical yeast cell.
- 6) Describe the mode of *Trypanosoma* transmission.

### Expected answers

- 1) Phototrophs are organisms that obtain energy from light but chemotrophs those organisms that obtain energy from chemicals.

During the Gram staining technique, some bacteria having no a lipid layer along with their peptidoglycan cell wall take the gram stain and appear violet (purple) and are therefore called gram positive, while some others having a lipid layer along with their peptidoglycans cell wall do not take up the gram stain and are therefore called gram negative

## Life cycle of Escherichia coli

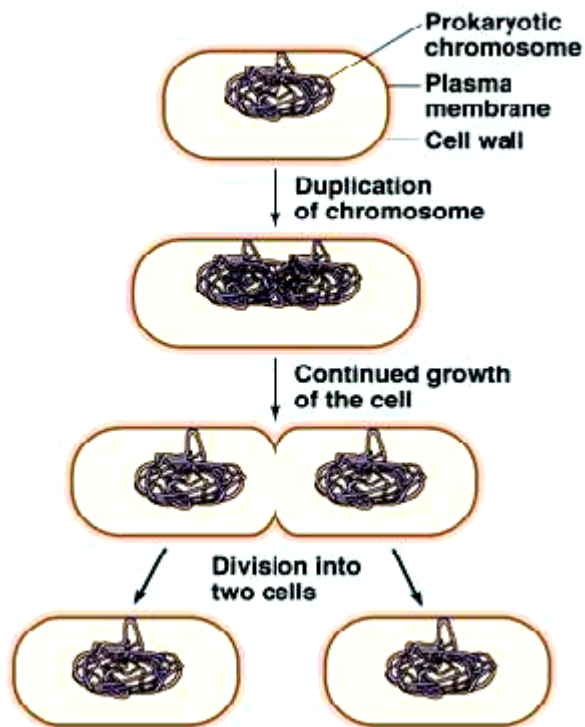

### 4) Comparison between viruses and cells

Characteristics of life	Virus	Cell
Growth	No	Yes
Homeostasis	No	Yes
Metabolism	No	Yes
Mutation	Yes	Yes
Nucleic acid	DNA or RNA	DNA
Reproduction	Only within host cell	Independently by cell division
Structure	Nucleic acid, protein covering and in some species an envelope	Cytoplasm, cell membrane, cytoskeleton and in eukaryotic cells, organelles.

### 5) The structure of yeast

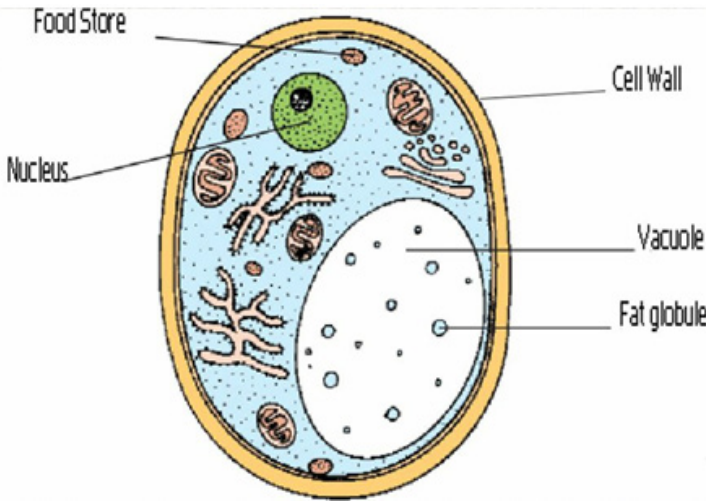

### 6) Mode of transmission of Trypanosoma

The vectors for *Trypanosoma cruzi* include members of the order Hemiptera, such as assassin flies, which ingest the amastigote or trypomastigote and carry them to animals or humans.

The parasites enter the human host through mucus membranes in the nose, eye, or mouth upon release from the insect vectors. Left untreated, Chagas' disease may cause dementia, megacolon, and megaesophagus, and damage to the heart muscle, and may result in death.

## 19.1 Key unit competence:

Explain the process of culturing microorganisms and the factors affecting their population growth.

## 19.2 Prerequisites

Introduce the unit by asking learners identify different groups of microorganisms studied in the previous unit. It is also necessary for the teacher, to ask learners about what they recall about how microorganisms reproduce. Ask learners the significance of microorganisms, what do microorganisms need in order to grow, how do we grow microorganisms in a lab?

Learners have knowledge of classification of living organisms, basically the prokaryotes like bacteria as well as eukaryotes such as protists and some microscopic fungi like yeasts, and knowledge of microorganisms will enable learners to discover a lot about culturing.

## 19.3 Cross-cutting issues to be addressed:

### a) Environment and sustainability

Take precautions during culturing to avoid microorganisms harming the form of life including humans. The attack of such harmful microorganisms can result into death of living organisms which degrades the environment. As a teacher, you are required to be creative and innovative enough, in integrating this cross cutting issue since it applicable in all lessons of this unit for example in the lessons of the role of microbes in plant and animals. Learners must recognise the significance of plants and animals in environmental protection. Learners also need to understand their positive roles in environment and sustainability.

### b) Gender

In all lessons of this unit, this cross cutting issue can be integrated. As a teacher your role is to ensure gender equality in activities you conduct inside and outside the

classroom. Gender can be integrated, for example by mix boys and girls in group work, while setting tasks and when presenting.

### **c) Comprehensive sexuality education (HIV/AIDS, STI, Family planning, Gender equality and reproductive health)**

When facilitating a lesson of common bacterial diseases, learners need to be aware that syphilis and gonorrhoea are STIs and at the same time caused by bacteria.

Lesson of the structure and classification of viruses, integrate in this cross cutting issue. Link the cause of AIDS which is HIV to this issue and emphasise on preventative measures. Learners are required to put into practice the preventative measures of HIV/AIDS and STIs.

### **Peace and values education**

The role of a teacher is to create and promote peace in a learning environment. In lesson 2.2, guide learners to ensure that all living organisms co – exist in harmony. This cross cutting issue can be integrated at any time in classroom, outside classroom, in school environment and anywhere in life. Teacher should not be a source of conflicts. Learners need to appreciate peace and values and advocate for positive behaviour among them.

## **19.4 Guidance on the introductory activity**

This activity is very essential since it captures the attention of learners: As a teacher, you are required to give such activity because it has the following benefits:

- It creates curiosity among learners and enhances active learning through doing.
- It promotes critical thinking and allows learners to predict the next lesson / unit.
- The teacher is encouraged to set clear introductory activity which can give a general picture of the whole unit if possible.



## 19.5 List of lessons.

	Lesson title	Learning objectives	Number of periods
1	Requirements for culturing of microorganisms	List and describe the roles of microorganisms and their requirements for growth.  Explain the role of environmental variables in culturing microorganisms.	2
2	Culture media	Describe the different types of culture media. Show perseverance when inoculating a solid and liquid medium.  Show concern for taking the basic precautions in the school laboratory when carrying out routine microbiological work.	3
3	Aseptic technique.	Describe the main features of aseptic techniques.  Explain how pure cultures of pure bacteria can be obtained.  Describe the methods of inoculation.  Explain how pure cultures of pure bacteria can be obtained.	3
4	Population growth of bacteria	Draw and interpret the graph of the population growth of bacteria.  Observe and compare the numbers of bacteria present in fresh and stale milk.  Carry out research on why microorganisms are particularly suitable for industrial.	3
5	Staining of bacteria and growing viruses	Distinguish between gram negative and gram positive bacteria.  Carry out an experiment to stain bacteria for examination with a light microscope.	2
6	Assessment:	Can clearly explain the process of culturing of microorganisms on different media and investigate factors affecting their population growth. (2 periods)	2

## Lesson 1: Requirements for culturing of microorganisms

### a) Prerequisite

Start the lesson by asking learners questions such as: what is meant by Microbiology and microorganisms? How do we classify microorganisms? Why are microorganisms important? Remember students have studied the five kingdoms of living organisms and previous unit of microbiology so they are expected to answer correctly the asked questions. Proceed with the lesson by introducing to them activity 19.1 in learners' book as follows:

### b) Teaching Resources:

- Manilas, markers, cards, text books or computer aided materials.

### c) Learning activities 19.1

Guide learners to develop competencies of this lesson by doing the following:

- Ask learners to make groups of not more than five students (depends on number of students in class).
- Provide each group with textbooks.
- Ask learners to brainstorm the requirements for growth of microorganisms.
- Ask learners to answer questions in activity 19.1, in student's book following the arrangement made.
- Ask learners to present their findings guide them to summarise their findings and add in any necessary requirement not addressed by learners.

### Answers for introductory activity

It is essential to culture microorganisms because they are used for various purposes for example in pharmaceutical industries to make antibiotics, vaccines and other drugs. Also are used in food and beer processing industries and for study purpose among others.

It would be dangerous to incubate cultures at temperatures close to body temperature - 37°C because doing so might allow the growth of pathogens harmful to health

### Answers for learning activity 19.1

Requirements for growth of microorganisms' essential nutrients such as:

- Source of carbon, nitrogen, growth factors, mineral salts, source of energy and water.
- Environmental variables such as: temperature, pH, oxygen concentration and ionic and osmotic balance.

## Answers for self-assessment 19.1

- 1) Culturing bacteria is a process of growing bacteria in very large numbers.
- 2) The conditions necessary for the growth of bacteria include:
  - Optimum temperature (30-40°C) for enzymes to work better.
  - Source of energy such as glucose, maltose, juice.
  - Source or other nutrients (minerals such as potassium, sodium, iron, magnesium and calcium, vitamins, proteins)
  - Air for aerobic microbes or complete absence of air for anaerobic microorganisms
- 3) Culturing is important in manufacture of antibiotics, disinfectants, and can be investigated using cultures of microorganisms their populations that have been grown for a purpose. It is important that the cultures are uncontaminated by other microorganisms, so sterile conditions are needed:
- 4) It would be dangerous to incubate cultures at temperatures close to body temperature - 37°C because doing so might allow the growth of pathogens harmful to health. So the maximum temperature used in school and college labs is 25°C. However, higher temperatures can be used industrially, and these produce faster growth.

## Lesson 2: Culture media

### a) Pre-requisite/ revision/ introduction.

Start the lesson by asking learners to explain what is meant by the term culture media? How do you grow microorganisms in a school lab? Proceed to the next step by introducing activity 19.2.

### b) Teaching Resources:

- text books, flip charts, markers, question papers. Alternatives are: computers and projectors.

### c) Learning activity 19.2

- Provide learners with text books and guide them to brainstorm steps taken during culturing and different forms of media.
- Ask each group to display and present their findings.
- The teacher evaluates learners' presentations by asking them to explain each.
- Extend the lesson by clearly highlighting the solid media, liquid media, enrichment media and selective media.

## Answers for activity 19.2

**Solid medium:** solid media are particularly suitable for bacteria and fungi and are prepared by mixing the liquid nutrient solution with a gelling agent, usually agar, at a concentration of about 1-2%, thus, producing nutrient agar.

**Liquid media:** liquid media are often useful for measuring population growth. They may be placed in a test tube, stopped by a plug of cotton wool or a metal cap, or in a glass, screw-capped bottle such as a universal bottle which holds about 25cm<sup>3</sup> enough for one agar plate.

**Enrichment media:** an enrichment medium is a medium in which substances are added to meet the requirements of which substances are added to meet the requirements of certain microorganisms in preference to others.

**A selective medium:** it is one in which one or more substances are added which inhibit the growth of all but one or few organisms.

### Answers for Self-assessment 19.2

- 1) Prepare a medium is free from any nitrogen-containing compounds but which contains all other nutrients needed for growth. Inoculate the soil, place in contact with nitrogen and incubate under sterile conditions. The only organisms which will be able to grow and multiply will be nitrogen fixers.
- 2) Nutrient agar is a nutrient jelly like substance on which many microorganisms are cultured.
- 3) Liquid Media is a sterilized media useful for measuring population growth while enrichment media is a medium in which substances are added to meet the requirements of certain microorganisms in preference to others.

## Lesson 3: Aseptic technique

### a) Prerequisite

This is a practical based lesson and as a teacher, you need to download video, YouTube clips for learners to follow the steps well. Guide learners throughout in order to develop and acquire knowledge and skills as well as attitudes and values. In addition to sterilizing and media, great care is taken by learners to ensure that they are not infected by the bacteria under investigation.

### b) Teaching Resources

- Video clips of aseptic and spread plate techniques, textbooks, flip charts and markers

### c) Learning activity 19.3

- Ask learners to watch the provided videos of aseptic and spread plate techniques.
- Ask learners to summarize their observations.
- Ask learners to analyse their findings and present
- Help learners to summarize their findings.
- Proceed the lesson by clearly explaining methods of inoculation.

### Answers for activity 19.3

#### Procedures for culturing fungi

- Aseptically, with a pair of forceps, place a sheet of sterile filter paper in a Petri dish.
- Place a sterile U-shaped glass rod on the filter paper. (Rod can be sterilized by flaming, if held by forceps.)
- Pour enough sterile water (about 4 ml) on filter paper to completely moisten it.
- With forceps, place a sterile slide on the U-shaped rod
- Gently flame a scalpel to sterilize, and cut a 5 mm square block of the medium from the plate of Sabouraud's agar or Emmons' medium.
- Pick up the block of agar by inserting the scalpel and carefully transfer this block aseptically to the centre of the slide.
- Inoculate four sides of the agar square with spores or mycelia fragments of the fungus to be examined. Be sure to flame and cool the loop prior to picking up spores.
- Aseptically, place a sterile cover glass on the upper surface of the agar cube.
- Place the cover on the Petri dish and incubate at room temperature for 48 hours.
- After 48 hours, examine the slide under low power. If growth has occurred there will be growth of hyphae and production of spores. If growth is inadequate and spores are not evident, allow the mold to grow for another 24- 48 hours before making the stained slides.
- Place a drop of lactophenol cotton blue stain on a clean microscope slide.
- Remove the cover glass from the slide culture and discard the block of agar.
- Add a drop of 95% ethanol to the hyphae on the cover glass. As soon as most of the alcohol has evaporated place the cover glass, mold side down, on the drop of lactophenol cotton blue stain on the slide. Examine the slide under microscope

### Answers for activity 19.3.1

Petri dishes 1 and 3 contains more colonies of bacteria than Petri dishes 2 and 4. This is because in Petri dishes 2 and 4, bacteria were strongly destroyed or killed by heating them.

The dishes were sealed to prevent microorganisms from air to contaminate the cultures or microbes in the culture from escaping. The experiment was controlled at 25 °C which is optimum temperature for the growth of bacteria (microorganisms) in the culture. Remember the experiment is controlled below normal body temperature for safety reasons. They should be placed upside down to prevent condensation falling onto the cultures.

### Answers for activity 19.3.2

- Yeast releases digestive enzymes which allow the transformation of glucose into ethanol as result of anaerobic fermentation.
- Alcoholic fermentation depends on a process known as malting.
- You soak barley grains in water and keep them. As germination begins, enzymes break down the starch in the barley grains into a sugary solution.
- You then extract a solution produced by malting and use it as an energy source for the yeast.
- The yeast and sugar solution mixture is then fermented to produce alcohol.
- Hops are added at this stage to give flavour.
- The beer is given time to clear and develops its flavour fully before it is put in bottles to be sold.

### Answers for self-assessment 19.3

1) A    2) A    3) A    4) C    5) A

## Lesson 4 Population growth of bacteria

### a) Prerequisite

Start the lesson by asking learners questions like: How do bacteria grow? Ask students to interpret the graphs. Learners can use the knowledge of population growth curves studied in the previous units.

### b) Teaching resources:

- Textbooks, flip charts, charts of graphs and markers, simulations, computers.

## Learning Activity 19.4

Guide learners to form groups of four each (you can consider the size of the class and available resources).

Provide learners with text books or data or graphs of bacteria.

Ask learners to present and guide them to summarize their presentations and evaluate them

After summarizing their presentations proceed with the lesson by explaining deeply each phase.

### Answers for activity 19.4

The graph showing population growth of bacteria.

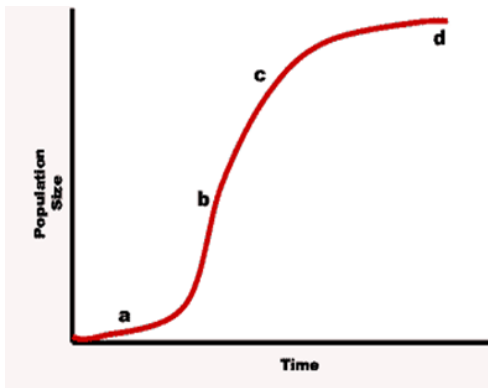

- The lag phase (a): period of adaptation of microorganisms to the new habitat thus slow growth.
- The log or exponential phase (b): period of high rate of reproduction thus rapid growth.
- The linear phase(c): the rate of reproduction slows down because of limiting factors. The limiting factors of the growth of a population include the temperature, the light, the pressure, the space, the amount of nutrients and metabolic waste products.
- The stationary phase (d): Stationary phase of plateau-growth slows down. The population remains constant because the rate of dividing is equal to the rate of death within the population.

### Answers for activity 19.4

- The fourth and second plates contain many colonies of bacteria due to rapid growth of bacteria in stale milk. The conditions are suitable since the culture was incubated at optimum temperature for bacterial growth. The growth was slower in third and first plate than in the plates with stale milk.
- Comment: milk become stale due contamination by bacteria which continue to grow faster provided suitable conditions.

### Answers for Self-assessment 19.4

1) The answers:

a) The following is the graph:

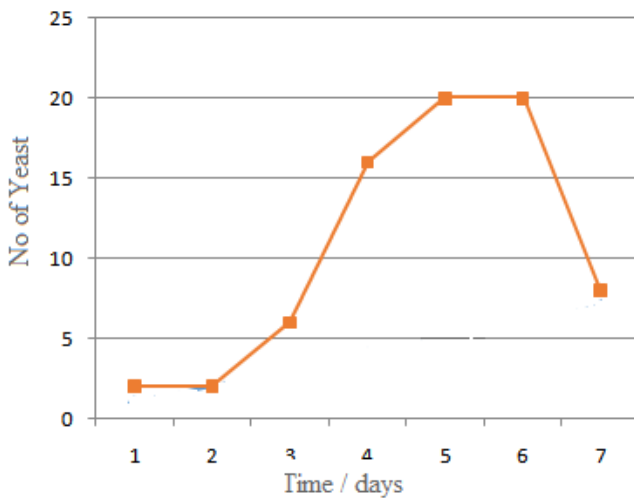

b) Banana juice contains glucose which provides necessary energy required in the process.

c) Temperature and complete absence of oxygen since respire anaerobically.

d) Between 2 and 6, there is slow growth rate due to few yeasts reproducing. Between 6 and 16, there is exponential growth rate due to high reproduction and no limiting factors while between 16 and 20 there is stationary growth due to limiting setting in and at 20, growth is constant then from 20 to 8, there is decline in number of yeasts due to death.

2) The experiment is labeled as follows: Two agar plates are required, touch one agar plate with a finger. Display the plates and leave them uncovered for 20 minutes. Then cover the plates, keep them in a safe place in the classroom. Use a hand lens to count the number of colonies after 24 and after 48 hours.



## Lesson 5: Staining of bacteria and growing viruses.

### a) Prerequisite

Ask learners to identify different stains used in staining bacteria. Learners have prior knowledge and skills of manipulating a light microscope. Use prepared slides or prepare and stain bacteria for observation.

### b) Teaching resources

- Text books, microscope, slides, stains of different colors newspapers, journals, magazines, flip charts and markers, photographs, videos

### c) Learning Activity 19.5

- Guide learners in their respective groups to use text books and prepare a presentation on importance of staining bacteria.
- Ask learners to present in their respective groups.
- Ask learners to summarize their presentations as you evaluate them.
- Answers for learning activity 19.5

Observation of Gram positive and Gram negative bacteria through a light microscope.

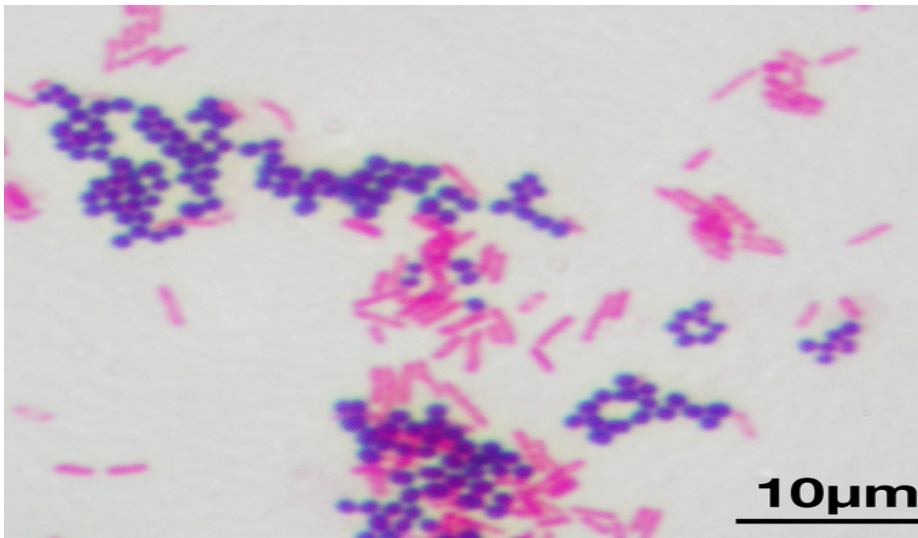

## Answers for Self-assessment 19.5

1) Match column A with column B in each case.

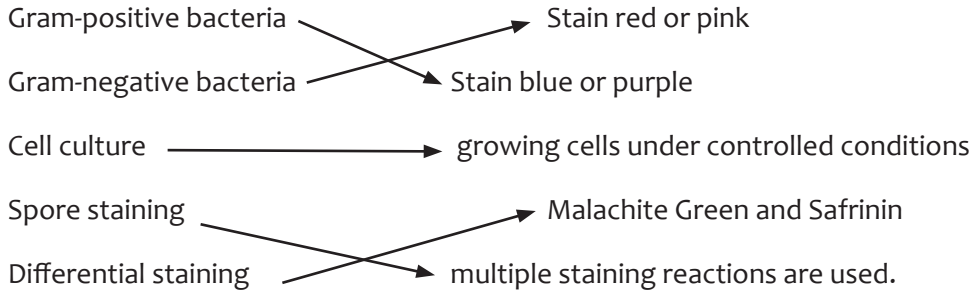

- 2) The culture of viruses is made more difficult than the culture of bacteria or fungi because viruses can only grow and multiply inside living cells.
- 3) Viruses are specific to the cells they infect because they must bind precisely to proteins on the cell surface in order to penetrate the cytoplasm.
- 4) A vaccine is a preparation of weakened or killed pathogens while antibiotics are chemical compounds that are administered to prevent the reproduction and growth of bacteria.

## 19.6 Unit summary

Many microorganisms can be grown in the laboratory. Source nutrients include: minerals such as potassium, sodium, iron, magnesium and calcium, vitamins, proteins. Temperature, pH and oxygen concentration are all important for bacterial growth. A medium is a solid or liquid preparation containing nutrients for the culture growth of microorganisms, animals. A culture is a collection of microbial cells growing on or, in a medium.

A medium is a solid or liquid preparation containing cells or plant tissue culture medium. A microbial culture undergoes four steps namely: Choice of the culture medium cells or plant tissue cultures, Sterilization of the culture medium and streaking, carrying out a pure culture.

Pure culture technique is a method of culturing microorganisms in which all of the individuals in a culture have descended from a simple individual. Sterilization, inoculation, and incubation are all required during culturing. When bacteria or any other germs are incubated in a suitable culturing medium, they reproduce by binary fission and the number of individuals increases.

In positive staining, cells structures take in the stain e.g. methylene blue while in negative staining. The purpose of staining bacteria is to see, for example, how thick of a layer of peptidoglycans their cell wall has. The culture of viruses is made more difficult than the culture of bacteria or fungi because viruses can only grow and multiply inside living cells.

### 19.7 Additional Information

- Help students to develop observation skill by practicing many experiments on microbiology.
- Points out those bacteria are almost everywhere in nature, but some few cause diseases. Make students carry out an experiment to find out where on the human body are the most bacteria.
- Ask pairs of students to prepare six Petri dishes of sterile nutrient agar. Have learners choose one of the pair for investigation. The other learner should use a separate sterile cotton swab to rub a 2cm area at five different places on the first learner's body: fore head, side of nose, cheek, and palm of the hand and on ankle. For each rubbing the learner should roll the cotton swab over the agar in one of the dishes and slow the swab away. Have learners, cover the dishes, label them, and place in an incubator or a warm spot in the room for 48hours. Then have learner pairs observe and compare the growth on each of the dishes.
- Ask learners to present their findings to the class. Help learners to develop writing skills especially scientific articles for example “viruses in the biosphere”.
- Viruses can be used in the production of vaccines that could eradicate specific diseases such as measles and polio: genetic engineers can correct genetic defects by using viruses to carry desirable genes from one cell to another.
- Harmful aspects: viruses are pathogens and resistant to antibiotics. Viral diseases that affect humans are described in the students' book.

### 19.8 Answers for end unit assessment 19

The main types of media are:

- Cultural media
- Minimal media
- Selective media
- Differential media
- Transport media
- Indicator media
- Enriched media

- 2) Pure culture is a culture containing a growth of a single kind of microorganism free from other organisms' e.g. a single species of bacteria.
- 3) Gram-positive bacteria have a single cell wall layer absorb only the violet primary stain while Gram-negative bacteria have a thin layer of peptidoglycans which the red stain that the bacteria appear red.
- 4) Methods of preventing bacterial growth in food are: sterilization, use of disinfectants, food storage and food processing.
- 5) Optimum temperature promotes bacterial growth, raising the temperature higher may reduce the growth of bacteria and very low temperatures inhibit bacterial growth.
- 6) It would not be a good idea because vaccinations prevent infections rather than attacking and destroying bacteria. The best way would be treating the infection with strong antibiotics.
- 7) Bacteria are essential to maintaining life on earth. Some are important producers, decomposers, nitrogen fixers and others are useful to humans in various ways.
- 8) Gram –positive bacteria have only one cell membrane, while Gram-negative bacteria have second outer layer of lipids and carbohydrates. Therefore, Gram-negative bacteria might more difficult to kill.
- 9) An experiment to investigate how temperature affects reproduction and growth of bacteria. The experiment is conducted as follows:

#### Materials required

- Glass-marking pencil
- 3 sterile agar plates
- Sterile cotton swabs
- Bacterial culture.
- Transparent tape.
- Hand lens.

#### Procedure:

- Put on your plastic gloves, use glass- marking pencil to label the edges of the agar plates, “3°C”, “20°C” and “37°C”.
- Dip a sterile cotton swab in the bacterial culture and wipe it back and forth in zigzag pattern over the entire surface of the agar on one plate.
- Cover the plate and seal it with transparent tape. Caution: do not open the

plates once they have been exposed to air.

- Repeat step 3 with each plate, using a new sterile swab for each plate.
- Place the plate labeled 3°C in a refrigerator. Leave the plate labeled 20°C in a place designated by the teacher; place the plate labeled 37°C in an incubator. Store each plate upside down.
- Draw a data table to represent the information as follows:
- Data table of results

Temperature	No. of colonies after 24hrs	No. of colonies after 48hrs
3°C		
20°C		
37°C		

After 24 hours, examine each plate with a hand lens. Bacterial colonies look like small white or white dots on agar surface, on the table above, record the number of bacterial colonies on each agar plate. Then return each plate in its former location.

- After a second period of 24hrs, record in your data table in (a column of 48hrs) the number of bacterial colonies on each agar plate.
- Return the agar plates to teacher for safe disposal.

10) Answers for:

a) **Aseptic technique** is using sterilized equipment and solutions and preventing their contamination while in use. Sterilization is the removal or destruction of all living organisms, including spores (inactive structures that enable some bacteria, algae, fungi and plants to survive through unfavorable periods). Bacterial and fungal spores are abundant in most environments including laboratories.

b) In **simple staining**, all the bacteria and structures in general stain the same colour. In **positive staining**, cells structures take in the stain e.g. **methylene blue** while in **negative staining** the cells repel the stain and it is taken by the background e.g. Indian ink.

- **Differential staining** on the other hand, multiple staining reactions are used that take advantage of the fact that particular types of microorganisms or specified structures of microorganism display varied staining reactions that are readily distinguishable by different colours. The purpose of staining bacteria is to see, for example, how thick of a layer of peptidoglycans possessed by their cell wall.
- **Growing viruses:** The culture of viruses is made more difficult than the culture of bacteria or fungi because viruses can only grow and multiply inside living cells. This can be done by infecting whole organisms such as plants or animals

but, where possible, cell, tissue cultures are now used. Viruses cannot be grown in standard microbiological broths or on agar plates; instead they have to be cultured inside suitable host cells.

11) Microorganisms are particularly suitable for industrial processes for the following reasons (students should do this question as a research activity and present their findings after)

- They have simple nutritional requirements.
- Their growth conditions can be controlled very precisely in fermenters (large vessels in which microorganisms are grown).
- They have fast growth rate.
- Their reactions can take place at lower temperatures than conventional industrial procedures hence lower energy costs.
- They produce higher yields and have higher specificity than conventional processes
- With microorganisms, a wide range of chemicals can be used and produced
- Some complex chemicals such as hormones and antibiotics can be manufactured which are difficult to produce by other methods and specific isomers can be produced.
- The genetics of microorganisms are relatively simple and techniques for genetic manipulation are continually advancing.

## **19.9 Additional activities**

### **19.1 Remedial activities**

- 1) What are four main types of microorganisms?
- 2) Why do we culture microorganisms in the lab?
- 3) Why are bacteria used in yoghurt making?
- 4) Identify four macro and micronutrients.

### **Answers for Remedial Activities**

- a) Microorganisms include the following types: bacteria, viruses, protists such as protozoa and some fungi like yeasts.
- b) For study purpose.
- c) They multiply so fast and change milk to yoghurt.
- d) Macronutrients include; these are required by microorganisms in

relatively large amounts. Carbon, oxygen, hydrogen nitrogen, sulfurs and phosphorous are components of carbohydrates, lipids, proteins and nucleic acids.

### 19.9.2 Consolidation activities

Most fungi have evolved the ability to produce spores through both sexual and asexual reproduction. How is this advantageous?

Why are microorganisms a serious problem, to agriculture in tropical regions of the world than they are in temperate regions?

#### Consolidation answers

- 1) With both methods of reproduction, fungi increase their chance of reproducing in different environmental conditions. Asexual reproduction is adaptive to more constant, favorable conditions, whereas sexual reproduction is adaptive to those that are harsh and unstable.
- 2) Tropical regions are warmer, and have more moisture which is one of the favorable conditions for growth of microorganisms.

### 19.9.3 Extension activities

- 1) The passage below describes how a student grows a culture of microorganisms on an agar plate. Petri-dishes and culture medium containing agar, carbohydrate, protein and mineral ions are heated to 120°C for 15 minutes. The culture medium is poured into the Petri dishes and left to set. An inoculating wire loop is passed through a flame until red hot, allowed to cool and then dipped into a container of microorganisms. The loop is then streaked across the medium in the Petri dish. The Petri dish is sealed with adhesive tape and incubated at a temperature not exceeding 25°C. Use the passage to answer the questions that follow:

In each case, give one reason why the following procedures were carried out.

- a) Carbohydrate was used in the culture medium.
  - b) The culture medium and Petri dishes were heated to 120°C for 15minutes
  - 3) The inoculating wire loop was cooled before being used to transfer microorganisms.
  - d) The Petri dish was sealed with adhesive tape.
  - e) The temperature at which the microorganisms are grown was not allowed to exceed 25°C.
- 2) Suggest measures you can use to prevent food spoilage by microorganism.

3) An experiment was conducted to determine the effectiveness of different antibiotics against a certain strain of bacteria. Four disks each soaked in different antibiotic were placed in Petri dish where the bacteria were growing. The results are summarized below.

### Effects of antibiotics

Antibiotic	Observation after one week
A	Growth retarded for 6mm diameter
B	Growth not retarded
C	Growth not retarded
D	Growth retarded for 2mm diameter

Which antibiotics were the least effective at retarding the growth of the bacteria? Explain your answer using data from the experiment.

From the experiment above which antibiotics might be most effective treatments for an infection caused by this strain of bacteria? Explain your answer using data from the experiment.

### Answers for extension activities

#### 1) Answers

- c) To provide the necessary energy.
- d) To sterilize the medium
- e) To prevent the destruction of bacteria
- f) To prevent microorganisms in air from contaminating the culture
- g) This greatly reduces chances of pathogens growing which might be harmful to humans.

2) In order to prevent food spoilage by bacteria at home, we can treat food in the following ways;

- Cooking- the heat denatures enzymes and other proteins. This kills bacteria.
- Pasteurising- this involves heating to 72 degrees celcius for 15seconds and then cooling.
- Drying, salting and coating in sugar – these methods dehydrate any bacteria as water leaves them by osmosis.
- Smoking- the food develops a hardened, dry outer surface and smoke contains antibacterial chemicals.



- Pickling – this uses an acid pH to kill bacteria by denaturing their enzymes other proteins.
  - Cooling and freezing- these do not kill bacteria but retard enzyme activity so their metabolism, growth and reproduction are very slow.
- 3) Antibiotic B and C were least effective. The growth of the bacteria was not retarded at all.

Antibiotic A and D would be good treatments because both retarded the growth of the bacteria.



## 20.1 Key Unit Competence

Explain the biotechnology involved in the production of ethanol, biogas and bread making

## 20.2 Prerequisite

The learners learnt about culturing microorganisms such as Bacteria in senior four, units nineteen. This will help students to develop competences (knowledge, skills and attitudes) that will help them to use technology in job creation.

## 20.3 Cross-cutting issues to be addressed

This unit will address different cross-cutting issues particularly standardization culture, inclusive education, and gender education. The **standardization culture** will be addressed when students will appreciate the conception of food and beverages in relation to positive or good results of the activities. Emphasize should be made so that students should always check the date of manufactured and expiration of chemicals/substances, beverages and even the food material.

For addressing **inclusive education**, while students will be conducting learning activities and experiments, instructional information should be given clearly and students with visual or physical impairment will be involved in learning activities and experiments. They can sometimes use their sense organs for identifying the results and final products such as breads, and other beverages in learning activities and experiments. Also, when forming groups for learning activities, when carrying out practical activities, and when cleaning materials that have been used during practical activities: students with disability should be considered and helped regarding their specific cases: hearing impairment, vision impairment, students without arms and legs; you the teacher and other students should help them to achieve the competences as required in all teaching-learning activities.

For addressing issue of **gender**, both boys and girls should share equally responsibilities in different learning activities and arranging materials and proper hygiene in experiments.

**Financial education.** This cross-cutting issue should be integrated in the sub-headings which require observing specimens under microscope. When guiding students on how to manipulate the microscope, you should give a caution of handling them carefully as they are very expensive, and that the country spends a lot of money to buy them.

## 20.4 Guidance on the introductory activity

Introduce this unit by challenging students through asking different questions like:

- 1) What is the role of microorganisms in biotechnology and genetic engineering?
- 2) Can you think on your own understanding on how bread, juice and beer are made?
- 3) Why do bacteria become resistant to antibiotics?
- 4) Make discuss on the biogas production.

Ask them to brainstorm on the above questions so that they can come up with good results and give room to students so that they may share their thoughts. Use students' ideas and then introduce a whole unit.

## 20.5 List of lessons

#	Lesson title	Learning objectives	Number of periods
1	Role of bacteria in Biotechnology and genetic engineering.	<p>State that bacteria are useful in biotechnology and genetic engineering due to their rapid reproduction rate and their ability to make complex molecules.</p> <p>Discuss why bacteria are useful in biotechnology and genetic engineering. Focus on: lack of ethical concerns over their manipulation and growth, genetic code shared with all other organisms, and presence of plasmids.</p> <p>Show concern for the role of bacteria in genetic engineering.</p>	2

2	Immobilization of enzymes. Focused on: use of pectinase in fruit juice production, lactase to produce lactose-free milk, and biological washing powders that contain enzymes and biosensors.	Investigate and describe the use of pectinase in fruit juice production and lactase to produce lactose-free milk.	2
3	Application of enzyme technology.	Describe the role of anaerobic respiration in yeast during bread-making. Compare leavened and unleavened bread. Appreciate the role of anaerobic respiration in the production of ethanol and in yeast during bread-making.	2
4	Fermentation and fermenters and production of penicillin	Explain how fermenters are used in the production of penicillin. Describe the role of the fungus Penicillin in the production of the antibiotic penicillin. Interpret and explain graphs showing how the pH and the concentration of penicillin in a culture changes over time when the pH is controlled and not controlled.	2
5	Antibiotics: Antibiotic resistance and implications of antibiotic use	Defend the role played by antibiotics in treatment of bacterial diseases.	2
6	Biogas production	Describe the three stages of biogas production and the role of bioreactors in economically poor rural communities Apply the knowledge of bioreactors, using cow dung, agricultural waste and domestic waste to prepare and produce biogas. Appreciate the role of biogas production in reducing the environmental degradation.	2
7	Assessment:	Learners can explain clearly the biotechnology involved in the production of ethanol, cheese, yogurt, antibiotics, biogas and bread making	2

## **Lesson 1: Role of bacteria in Biotechnology and genetic engineering.**

### **a) Prerequisites**

The learners learnt about culturing microorganisms such as Bacteria in senior four, units nineteen. This will help students to develop competences (knowledge, skills and attitudes) taught in this lesson.

### **b) Teaching resources**

- Online resources, CDs, simulations, diagrams, charts, micrographs and illustrations and text books

### **c) Learning activity 20.1**

Facilitate learners to do activity 20.1 and develop competencies in this lesson by doing the following:

- Ask learners to brainstorm on the role of bacteria in biotechnology and genetic engineering.
- Supervise the work how it is conducted and give the learners' opportunity to work in their respective groups.
- Ask learners to make discussion in group.
- Ask learners to write the summary of the group discussions,
- Use students' products and further questions if need for summarizing and concluding the lesson.
- Through questions, guide learners to come up with a summary, write it progressively on the chalkboard or flipchart and ask learners to note it in their notebooks.
- Finally, assess the lesson through questions and then invite students to attempt self- assessment 20.1.

### **Answers to the activity 20.1**

Expected answers are under the unit 20 (lesson one) in student book.

### **Answer for self-assessment 20.1**

- 1) The biotechnology is the use of biological processes, organisms, or systems to manufacture products intended to improve the quality of human life.
- 2) Genetic engineering is the use of genetic knowledge to artificially manipulate genes. It is one of the fields of biotechnology.
- 3) Expected answers are under the unit 20 (lesson one) in student book.

## Lesson 2: Immobilization of enzymes.

### a) Prerequisites/Revision/Introduction:

Do introduction by asking students to discuss on role of pectinase on fruit juice production and lactase to produce lactose-free milk and write reports.

### b) Teaching resources

Online resources, CDs, simulations, diagrams, charts, micrographs, illustrations, cultured microorganisms.

### c) Learning activity 20.2

Facilitate learners to do activity 20.2 and develop competencies in this lesson by doing the following:

- Ask learners to brainstorm the action of enzymes with reference to pectinase in fruit juice production and lactase to produce lactose-free milk in the activity 20.2
- Supervise the work how it is conducted and give the learners' opportunity to work in their respective groups.
- Ask learners to make discussion in group.
- Ask learners to write the summary of the group discussions,
- Use students' products and further questions if need for summarizing and concluding the lesson.
- Through questions, guide learners to come up with a summary, write it progressively on the chalkboard or flipchart and ask learners to note it in their notebooks.
- Finally, assess the lesson through questions and then invite students to attempt self- assessment 20.2.

### Answers to the activity 20.2

Expected answers are under the unit 20 (lesson two) in student book.

## Answers for self-assessment 20.2

### 1) Advantages/Disadvantages of Immobilizing Enzymes

Advantages Getting Started	Disadvantages
Enzymes are not present with products so purifications/ downstream processing costs are low.	Immobilization requires additional time, equipment and materials so is more expensive to set up.
Enzymes are immediately available for reuse. Allows for continuous processes	Immobilized enzymes may be less active as they cannot mix freely with the substrate.
Immobilized enzymes are more stable because immobilizing matrix protects enzyme molecules.	Any contamination is costly to deal with because the whole system would need to be stopped.

### 2) Use of pectinase in fruit juice production:

- The pectin content of the fruit is increased, making the nutritional value of the juice higher.
- The pectin content of the fruit is reduced, making the energy content of the juice lower.
- The pectin content of the fruit is reduced, making the juice easier to extract.
- The pectin content of the fruit is increased, giving the juice a thicker texture.

### 3) The role of lactase in **making lactose-free milk**:

- The enzyme lactase breaks down the sugar lactose, which is found in milk, into the sugars glucose and galactose.
- Immobilized lactase can be used to produce lactose-free milk: normal milk is poured down a column containing the immobilized lactase enzymes, which break down the lactose.

### 4) Expected answers are under the unit 20 (lesson two) in student book.

## Lesson 3: Application of enzyme technology.

### a) Prerequisites/Revision/Introduction:

Through question of revision on the application of enzyme technology, do you think on the application of enzyme technology? Build on learners' ideas and then go to the activity 20.3 given in student textbook.



## b) Teaching resources

Online resources, CDs, simulations, diagrams, charts, micrographs, illustrations, cultured microorganisms.

## c) Learning activity 20.3

Help students to develop competencies that are related to this lesson you need to facilitate learners to do activity 20.3 by doing the following:

- Ask learners to brainstorm on the application of enzyme technology.
- Supervise the work how it is conducted and give the learners' opportunity to work in their respective groups.
- Ask learners to make discussion in group.
- Ask learners to write the summary of the group discussions,
- Use students' products and further questions if need for summarizing and concluding the lesson.
- Through questions, guide learners to come up with a summary, write it progressively on the chalkboard or flipchart and ask learners to note it in their notebooks.
- Finally, assess the lesson through questions and then invite students to attempt self- assessment 20.3

## Answers for activity 20.3

Summarized report on materials and procedures on bread making

### Ingredients

- 450g (3 cups) plain bread flour
- 1 tablespoon (12g/2 sachets) dried yeast
- 2 teaspoons caster sugar
- 1/2 teaspoon salt
- 250ml (1 cup) warm milk
- 2 tablespoons melted butter
- Water
- Timer

### Procedures

Procedures are summarized in the following four stages:

**Step 1:** Combine flour, yeast and sugar in a large bowl. Stir in salt. Make a well in the

centre. Add milk and butter.

**Step 2:** Use a wooden spoon to stir the mixture until well combined, then use your hands to bring the dough together in the bowl. Turn onto a lightly floured surface and knead for 10 minutes or until the dough is smooth and elastic.

**Step 3:** Brush a large bowl with olive oil to grease. Place the dough in the bowl and cover with a damp tea towel. Set aside in a warm, draught-free place to prove for 45 minutes-1 hour or until the dough has almost doubled in size.

**Step 4:** Punch down the centre of the dough with your fist. Turn into a lightly floured surface. Knead for 2 minutes or until the dough is elastic and has returned to its original size. Continue following your recipe.

### **Answers for self-assessment 20.3**

- 1) Expected answers are under the unit 20 (lesson three) in student book.
- 2) Expected answers are under the unit 20 (lesson three) in student book.
- 3) Expected answers are under the unit 20 (lesson three) in student book.

## **Lesson 4: Fermentation, fermenters and production of penicillin**

### **a) Prerequisites**

Students have competences on immobilization of enzymes, and use of enzymes in food industry.

### **b) Teaching resources**

Use charts, online resources, CDs, diagrams, micrographs, and test books, computer animations, projector, Manila paper with diagrams for improvisation

### **c) Learning activity 20.4**

Help students to develop competencies that are related to this lesson you need to facilitate learners to do activity 20.4 by doing the following:

- Help students to form groups, and provide learning-materials to be used in the activity.
- Request students in their groups for working on the activity 20.4 from the students' text books,
- Monitor how the students are progressing towards the competences to be developed. Boost those who are still behind (but without communicating to them the knowledge).
- Move around the class, listening to students as they discuss and looking at their answers.

- Ask learners to write the summary of the group discussions,
- Through questions, guide learners to come up with a summary, write it progressively on the chalkboard or flipchart and ask learners to note it in their notebooks.
- Finally, assess the lesson through questions and then invite students to attempt self-assessment 20.4.

#### Answers to the activity 20.4

Penicillin is produced commercially by growing the fungus *Penicilliumchrysogenum* in large stirred fermenters. A solution of essential salts and a nitrogen source are put into the fermenter together with an inoculum of the fungus. All procedures are performed aseptically. The PH of the medium is regulated with ammonium salts at 6.5 to 7.0. Lactose (a slowly hydrolysed disaccharide) is added to promote cell growth and reproduction and minimize penicillin production. On completion of fermentation (usually 6-7 days) the broth is separated from the fungal mycelium and penicillin extracted. This penicillin can then be modified by chemical procedures to yield a variety of semisynthetic penicillins.

#### Answers for the self-assessment 20.4

- 1) **A fermenter** also known as a bioreactor is an apparatus that maintains optimal conditions for culture and growth of microorganisms to be used in large-scale fermentation and in the commercial production of antibiotics.
- 2) **Downstream processing** is a type of industrial production of penicillin that refers as the extraction and purification of a biotechnological product from fermentation or at the end of culture process. Usually the contents of fermenter are first separated into liquid component and a solid component which contain the cells. This is usually done by filtration or centrifugation, while **upstream processing** is a type of industrial production of penicillin that encompasses any technology that leads to the synthesis of a product and includes the exploration, development and production.
- 3) Penicillin is an antibiotic produced commercially by growing the fungus *Penicilliumchrysogenum* that fight against infections and pathogens.
- 4) In laboratory, it is relatively easy to grow microbes on a small scale in petri dishes, test tubes and flasks, given a suitable nutrient medium, and good environmental conditions, while, producing chemicals like penicillin antibiotic from microbes on an industrial scale becomes more complicated as a big number of organisms have to be grown for the venture to be commercially viable.
- 5) The continuous culture is described as an open system, because nutrients are added and cells harvested at a constant rate, so that the volume of suspension is also kept constant. This means that fermenters does not have to be emptied, cleaned and refilled very often. The production is almost continuous.

- 6) Batch culture or batch fermentation is described as closed system, because cells are grown in a fixed volume of liquid medium in closed vessels. The conditions are set up and not changed from outside once fermentation starts; for example: no microorganisms, nutrients, or fluid are added or removed from the culture during the incubation period. That is why the process is described as a closed system.
- 7) Expected answer is in students' text books, unit 20, in lesson 4.
- 8) Continuous cultures are very expensive because they need very high equipment to maintain constant conditions, and highly skilled staff to operate the equipment.
- 9) Expected answer is in students' text books, unit 20, in lesson 4.

## **Lesson 5 Antibiotics: Antibiotic resistance and implications of antibiotic use.**

### **a) Prerequisites**

Students have competences on Fermentation, fermenters and production of penicillin as an antibiotic. Ask questions on how penicillin is produced.

### **b) Teaching resources**

Use charts, online resources, CDs, diagrams, micrographs, and test books, computer animations, projector, Manila paper with diagrams for improvisation.

### **c) Learning activity 20.5**

- Help students to develop competencies that are related to this lesson you need to facilitate learners to do activity 20.5 by doing the following:
- Help students to form groups, and provide learning-materials to be used in the activity.
- Request students in their groups for working on the activity 20.5 from the students' text books,
- Monitor how the students are progressing towards the competences to be developed. Boost those who are still behind (but without communicating to them the knowledge).
- Move around the class, listening to students as they discuss and looking at their answers.
- Ask learners to write the summary of the group discussions,
- Allow students to present their findings to the whole class.
- Through questions, guide learners to come up with a summary, write it progressively on the chalkboard or flipchart and ask learners to note it in their notebooks.

- Finally, assess the lesson through questions and then invite students to attempt self-assessment 20.5

### **Answers for activity 20.5**

Expected answer for activity 20.5 is in the students' text book, unit 20, lesson 5.

### **Answers for the self-assessment 20.5**

- 1) Antibiotic resistance occurs when an antibiotic has lost its ability to effectively control or kill bacterial growth; in other words, the bacteria are “resistant” and continue to multiply in the presence of therapeutic levels of an antibiotic.
- 2) Bacteria may become resistant into two ways: by genetic mutation or by acquiring resistance from another bacterium.
- 3) Antibiotic resistance traits can be lost, but this reverse process occurs more slowly. If the selective pressure that is applied by the presence of an antibiotic is removed, the bacterial population can potentially revert to a population of bacteria that responds to antibiotics
- 4) Excessive use of antibiotic continues to generate unwanted side effects; the overuse of antibiotics continues to have severe health consequences around the world.
- 5) Genetically, antibiotic resistance spreads through bacteria populations both “vertically,” when new generations inherit antibiotic resistance genes, and “horizontally,” when bacteria share or exchange sections of genetic material with other bacteria. People can pass the resistant bacteria to others; foreexample, by coughing or contact with unwashed hands.

## **Lesson 6: Biogas production**

### **a) Prerequisites**

Students have competences on Fermentation, fermenters and production of penicillin as an antibiotic. Ask questions on how penicillin is produced.

### **b) Teaching resources**

Use charts, online resources, CDs, diagrams, micrographs, and test books, computer animations, projector, Manila paper with diagrams for improvisation.

### **c) Learning activity 20.6**

Help students to develop competencies that are related to this lesson you need to facilitate learners to do activity 20.6 by doing the following:

- Conduct students to visit a nearest biogas plants in your region: describe the stages of biogas production and its significance in your area.
- Ordering students to follow explanations from the agent of the biogas plant about the processes of biogas production.
- Monitor how the students are progressing towards the competences to be developed.).
- Ask learners to write the summary of what the agent has said.
- Allow students to present what they heard from the agent to the whole class.
- Through questions, guide learners to come up with a summary, write it progressively on the chalkboard or flipchart and ask learners to note it in their notebooks.
- Finally, assess the lesson through questions and then invite students to attempt self-assessment 20.6.

### Answer for the activity 20.6

Expected answer for activity 20.6 is in the students' text book, unit 20, lesson 6.

### Answers to the self-assessment 20.6

1) Acetogenic reactions produce acetate, and Hydrogen and carbon dioxide.

2) The archaebacteria generate methane either:

- By reducing the carbon dioxide:  $\text{CO}_2 + 4\text{H}_2 \longrightarrow \text{CH}_4 + \text{H}_2\text{O}$ , or
- By converting acetate:  $\text{CH}_3\text{COOH} \longrightarrow \text{CH}_4 + \text{CO}_2$

## 20. 6 Summary of the unit

Biotechnology is a broad discipline in which biological processes, organisms, cells or cellular components are exploited to develop new technologies. New tools and products developed by biotechnologists are useful in research, agriculture, industry and the clinic. There are some disadvantages: immobilization requires extra time, equipment and work; there may be a reduction in reaction rates if enzymes cannot mix freely with the substrate; and immobilized enzymes cannot be used if one of the substrates is insoluble. There are several advantages of using immobilized enzymes as the following: (i) reuse (ii) continuous use (iii) less labor intensive (iv) saving in capital cost (v) minimum reaction time (vi) less chance of contamination in products, (vii) more stability (viii) improved process control and (ix) high enzyme: substrate ratio. Enzymes are applied in Brewing, medical, baking, cheese, yoghurt and in bread making.

Fermentation is anaerobic breakdown of organic compounds by living cells that produces ethanol and carbon dioxide or lactate. *Antibiotics* are powerful medicines that fight certain infections by either stopping bacteria from reproducing or by destroying them.

Biogas typically refers to a mixture of different gases produced by the breakdown of organic matter in the absence of oxygen. There are three stages of biogas production which are the following: **anaerobic fermentation** by eubacteria including *Lactobacillus*, which converts the organic waste into a mixture of organic acids and alcohol, with some Hydrogen, Carbon dioxide, and acetate, **acetogenic reaction** by *bacteria* such as *acetobacterium* which, in addition to acetate, produce hydrogen and Carbon dioxide from the organic acid and alcohol and **methanogenic reactions** by archaeobacteria, including Methanobacterium, Metanococcus, and Methanospirillum.

## 20.7 Additional information for the teacher

There are numerous sub-fields of biotechnology. They are:

1. **Red biotechnology** is biotechnology applied to medical processes. Some examples are the designing of organisms to produce antibiotics, and the engineering of genetic cures to cure diseases through genomic manipulation.
2. **White biotechnology**, also known as **grey biotechnology**, is biotechnology applied to industrial processes. An example is the designing of an organism to produce a useful chemical. White biotechnology tends to consume less in resources than traditional processes when used to produce industrial goods.
3. **Green biotechnology** is biotechnology applied to agricultural processes. An example is the designing of an organism to grow under specific environmental conditions or in the presence (or absence) of certain agricultural chemicals. One hope is that green biotechnology might produce more environmentally friendly solutions than traditional industrial agriculture. An example of this is the engineering of a plant to express a pesticide, thereby eliminating the need for external application of pesticides. Whether or not green biotechnology products such as this are ultimately more environmentally friendly is a topic of considerable debate.
4. The term **blue biotechnology** has also been used to describe the marine and aquatic applications of biotechnology, but its use is relatively rare.

## 20.8 Answers of end unit assessment

- 1) Answer is B
- 2) Answer is A
- 3) Answer is B
- 4) Answer is A

**5) Fermentation** is an anaerobic breakdown of organic compounds by living cells (microorganisms) that produces ethanol and carbon dioxide or lactate (lactic acid).

6) The biogas can contribute to the economic development of Rwanda as:

- It can be used as a fuel; it can be used for any heating purpose, such as cooking. In the UK, for example, biogas is estimated to have the potential to replace around 17% of vehicle fuel.
- It can also be used in a gas engine to convert the energy in the gas into electricity and heat.
- Biogas can be compressed, the same way the natural gas is compressed to compressed natural gas (CNG), and used to power motor vehicles.

7) There are five different techniques of immobilizing enzymes: (i) adsorption, (ii) covalent bonding, (iii) entrapment, (iv) copolymerization or cross-linking, and (v) encapsulation. (More explanations can be seen in the student's book, unit 20, lesson 2, in senior 4).

8) Even if antibiotics play a major role in actual medicine, the excessive use of antibiotics continues to generate unwanted side effects, and continues to have severe health consequences around the world.

9) Breads made with yeast is normally allowed to rest for an hour so that it can rise and double in size.

10) The main ingredients include: bread-flour, dry yeast ('rapid rise'), levain (sourdough), salt, water, sugar, and eggs.

11) The advantages of using immobilized enzymes are: (i) reuse (ii) continuous use (iii) less labor intensive (iv) saving in capital cost (v) minimum reaction time (vi) less chance of contamination in products, (vii) more stability (viii) improved process control and (ix) high enzyme: substrate ratio.

12) The composition of biogas varies depending upon the origin of the anaerobic digestion process. Landfill gas typically has methane concentrations around 50%.

	Formula	%
Methane	CH <sub>4</sub>	50-75
Carbone dioxide	CO <sub>2</sub>	25-50
Nitrogen	N <sub>2</sub>	0-10
Hydrogen	H <sub>2</sub>	0-1
Hydrogen sulphide	H <sub>2</sub> S	0-3
Oxygen	O <sub>2</sub>	0-0.5



13) The production of biogas involves three stages and three communities of microorganisms namely

a) **Anaerobic fermentation** by eubacteria including *Lactobacillus*, which converts the organic waste into a mixture of organic acids and alcohol, with some Hydrogen, Carbon dioxide, and acetate.

b) **Acetogenic (acetate-producing) reaction** by bacteria such as acetobacterium which, in addition to acetate, produce hydrogen and Carbon dioxide from the organic acid and alcohol.

c) **Methanogenic (methane-producing) reactions** by archaeobacteria, including Methanobacterium, Methanococcus, and Methanospirillum. The archaeobacteria generate methane either:

- By reducing the carbon dioxide:  $\text{CO}_2 + 4\text{H}_2 \longrightarrow \text{CH}_4 + \text{H}_2\text{O}$ , or
- By converting acetate:  $\text{CH}_3\text{COOH} \longrightarrow \text{CH}_4 + \text{CO}_2$ .

## 20.9 Additional activity

### 20.9.1 Remedial Activities

- 1) What do you understand with biotechnology?
- 2) Why are enzymes added to washing powder?
- 3) Describe the role of the fungus *Penicillium* in the production of the antibiotic penicillin.
- 4) Explain why the biological washing-powder should not be used in boiling water.

### Answers for remedial activities

1. Biotechnology is a controlled and deliberate manipulation of biological systems (whether living cells or cell components) for the efficient manufacture or processing of useful products.
2. The biological washing powders contain enzymes like protease and lipase to remove protein stains and fat/grease from clothes. The enzymes break down proteins or fats on the fabric, forming water-soluble substances that can be washed away.
3. Penicillin is produced commercially by growing the fungus *Penicillium chrysogenum* in large stirred fermenters.
4. Enzymes are denatured at high temperature, and will not wash properly.

### 20.9.2 Consolidation activities

- 1) State the advantages of using immobilized enzymes.
- 2) Silk is a material made from protein. Explain why the biological washing powder should not be used to wash silk clothes.
- 3) Justify why specialized biologists should minimize the build-up of end-products during scaling-up.
- 4) Explain why antibiotics affect bacteria and not viruses.

### Answers of consolidated activities

1. The advantages of using immobilized enzymes are: (i) reuse (ii) continuous use (iii) less labor intensive (iv) saving in capital cost (v) minimum reaction time (vi) less chance of contamination in products, (vii) more stability (viii) improved process control and (ix) high enzyme: substrate ratio.
2. There is protease in the biological washing powder. This would digest the protein in the silk so the clothes would get spoiled.
3. Specialized biologists should minimize the build-up of end-products during scaling-up production, because the build-up of end products acts as inhibitors which may reduce production.
4. Penicillin as an antibiotic affects bacterium which are biotic and not viruses which are abiotic.

### 20.9.3 Extended activities

- 1) Defend the role played by antibiotics in treatment of bacterial diseases.
- 2) Compare leavened and unleavened bread.
- 3) Draw a well labeled diagram of a fermenter.
- 4) Identify three communities of microorganisms that are involved in each stage of biogas production.

Describe the differences in the concentration of penicillin in the culture when the pH is controlled and when the pH is not controlled.

### Answers for extended activities

- 1) Expected answers are under the unit 20 (lesson three) in student book.
- 2) Expected answers are under the unit 20 (lesson three) in student book.

- 3) Expected answer is in students' text books, unit 20, lesson 4
- 4) The three communities of microorganisms that are involved in each stage of biogas production include:
- Eubacteria including *Lactobacillus*, which converts the organic waste into a mixture of organic acids and alcohol, with some Hydrogen, Carbon dioxide, and acetate.
  - *Bacteria* such as acetobacterium which, in addition to acetate, produce hydrogen and Carbon dioxide from the organic acid and alcohol.
  - *Archaeobacteria* including Methanobacterium, Metanococcus, and Methanospirillum.

## References

- Brainard Ph.D, J. (2015). CK-12 Biology Foundation textbook next generation.
- Campbell and Reece (2008). Biology, 8th edition, Pearson international Edition, San Francisco, USA.
- Campbell, R. (1999). Biology. Fifth Edition. Pearson international Edition, San Francisco, USA.
- Edition, O. s. (2008). Dictionary of Biology. Oxford: Oxford University press.
- Government, W. (2005). Guidance for teaching. England: Charles Darwin House.
- Ibrahim, S. (2006). Solutions to examination paper UCE Biology paper 1 and 2. Kampala: PEAK Publisher Ltd.
- Jones, M., Fosbery, R., Gregory, J., & Taylor, D. (2014). Cambridge International AS and A Level Biology coursebook fourth Edition. United Kingdom: Cambridge University Press.
- Jones, M., Fosbery, R., Gregory, J., & Taylor, D. (2014). Cambridge International AS and A Level Biology coursebook fourth Edition. United Kingdom: Cambridge University Press.
- Juliet, M., and Magondu, J., M. V. (2017). Biology for Rwanda. Kigali: Easter African Educational publishers
- Kent, M. (2000). Advanced biology. A new mainstream text for the new specifications. Oxford University Press, New York.
- Kinyua S.W; and Mtungai M.N. (2013). Top Mark Revision Biology, Second Edition. Nairobi: KLB
- M.B.B Roberts, (1986). Biology for life. 2nd edition, Thomas Nilsson and sons Ltd, London UK
- Mackean, D.G, and Hayward, D. (2014). Cambridge IGCSE biology 3rd edition. London: Hadder education
- Mader, S. (2004). Biology. Eighth Edition. New York: McGrawHill company
- Mader, S. S., Baldwin, A., Roush, R., and Stephanie Songer, M. T. (2010). Biology 10th Edition. Boston: McGraw-Hill companies
- Mary, J., and Forcebery, R. (2004). Cambridge International AS and A Level. United Kingdom: CAMBRIDGE University press.

Mary, J., and Forcebery, R. (2004). Cambridge International AS and A Level. United Kingdom: CAMBRIDGE University press.

Miller/Prentice Hall, L. (2006). Biology, Florida students' and teachers' edition. Boston: Pearson edition.

Neil, C. A., Jane B. Reece, L. A., Michael L. Cain, S. A., V. Minorsky, P., and B. Jackson, R. (2009). Biology 8th edition. San Francisco: Pearson

Owaka, M., & Kavita, P. (n.d.). Revision Biology test it and fix it. Oxford: Oxford press.

Peter K; Frank S. (2008). OCR Biology. British: British Library

Roberts, M. B. B. (1986). Biology for life. 2nd edition, Thomas Nilsson and sons Ltd, London UK

Rwanda Ministry of Natural resources. (2016). National biodiversity and action plan. Kigali.

Suift M., I. A. (2004). Agriculture, Ecosystem and Environment. Nairobi: ELSEVIER.

Taylor, D. (2008). Biological science. Cambridge: Cambridge university press.

Toole, G, and Toole, S. (1999). Biology for advanced level 4th edition. United Kingdom: Nelson thornes

<https://study.com/academy/practice/quiz-worksheet-louis-pasteur-germ-theory-of-disease.html>

<https://study.com/academy/practice/quiz-worksheet-louis-pasteur-germ-theory-of-disease.html>

