

Physics

FOR ASSOCIATE
NURSING PROGRAM

Student's Book 4

© 2021 Rwanda Basic Education Board

All rights reserved

This book is property of the Government of Rwanda. Credit must be given to
REB when the content is quoted.

FOREWORD

Dear Student,

Rwanda Basic Education Board is honored to present to you this Physics Book for Senior four which serves as a guide to competence-based teaching and learning to ensure consistency and coherence in the learning of physics subject. The Rwandan educational philosophy is to ensure that you achieve full potential at every level of education which will prepare you to be well integrated in society and exploit employment opportunities.

The government of Rwanda emphasizes the importance of aligning teaching and learning materials with the syllabus to facilitate your learning process. Many factors influence what you learn, how well you learn and the competences you acquire. Those factors include the instructional materials available among others. Special attention was paid to the activities that facilitate the learning process in which you can develop your ideas and make new discoveries during concrete activities carried out individually or with peers.

In competence-based curriculum, learning is considered as a process of active building and developing knowledge and meanings by the learner where concepts are mainly introduced by an activity, a situation or a scenario that helps the learner to construct knowledge, develop skills and acquire positive attitudes and values.

For effective use of this textbook, your role is to:

- * Work on given activities which lead to the development of skills
- * Share relevant information with other learners through presentations, discussions, group work and other active learning techniques such as role play, case studies, investigation and research in the library, from the internet or from your community;
- * Participate and take responsibility for your own learning;
- * Draw conclusions based on the findings from the learning activities.

I wish to sincerely extend my appreciation to REB staff who organized the editing process of this book. Special gratitude goes to the lecturers, teachers, illustrations and designers who diligently worked to successful completion of this book. Any comment or contribution would be welcome for the improvement of this textbook for the next edition.

Dr. Nelson MBARUSHIMANA

Director General, REB

ACKNOWLEDGEMENT

I wish to express my appreciation to all the people who played a major role in editing process of Physics book for senior four. It would not have been successful without their active participation.

Special thanks are given to those who gave their time to read and refine this textbook to meet the needs of competence-based curriculum. I owe gratitude to different Universities and schools in Rwanda that allowed their staff to work with REB to edit this book. I therefore, wish to extend my sincere gratitude to lecturers, teachers, illustrators, designers and all other individuals whose efforts in one way or the other contributed to the success of this edition.

Finally, my word of gratitude goes to the Rwanda Education Board staff particularly those from Curriculum, Teaching and Learning Resources Department who were involved in the whole process of editorial work.

Joan MURUNGI,

Head of Department of Curriculum, Teaching and Learning Resources

Table of Contents

<i>Foreword</i>	<i>iii</i>
<i>Acknowledgement</i>	<i>iv</i>
<i>Introduction</i>	<i>1</i>
Unit 1:Thin lenses	4
Types of lenses and their characteristics	6
Terms used in lenses.....	8
Ray diagrams and properties of images formed by lenses	17
The thin lens formula	25
Magnification	29
Combination of lenses.....	36
Refraction through prisms.....	42
Dispersion of light by a prism.....	57
Unit 2 :Optical instruments	64
Definition of an optical instrument.....	65
Defects of vision and their correction	69
A lens camera	75
The slide projector.....	82
Microscope.....	85
Telescopes	100
Reflecting telescopes.....	109
Unit 3:Moments and Equilibrium of Bodies	114
Scalar and vector quantities.....	115
Turning effect of force.....	118
Equilibrium of a body	123
Centre of gravity and center of mass.....	130
Unit 4 :Work, Energy and Power	143
Work.....	144
Energy	148
Power.....	159
Linear momentum and impulse.....	163
Collisions.....	172
Unit 5 :Kirchhoff's Laws and Electric Circuits	189
Generators and receptors	201
Ohm's law for a circuit having a cell and a resistor	210
Interpretation	216
Receptors.....	223
Kirchhoff's rules	227

Unit 6 :Sources of Energy in the World	239
Fossil fuel	242
Nuclear fuel.....	243
Renewable sources	244
Extraction and creation of renewable and non-renewable energy sources	257
Unit 7 :Projectile and uniform circular motion	261
Circular motion	271
Angular displacement θ	272
Centripetal acceleration.....	273
Periodic time, frequency	274
Centripetal force.....	278
Unit 8:Universal gravitational field and potential	292
Universal gravitational field potential	293
Relation between the universal gravitational constant and force of gravity (g and G).....	299
Kepler’s Laws.....	299
Unit 9 :Electric field and electric potential.....	305
Coulomb’s law.....	308
Electric field	315
Field strength and charge density	320
Potential difference.....	322
Motion of electric charges in an electric field	327
Lightening and lightening arrestor	329
Unit 10:Applications of thermodynamics laws	333
Thermal energy and internal energy.....	335
Thermodynamic systems.....	337
The first law of the thermodynamics	344
Second Law of thermodynamics	359
Petrol engine	368
Diesel engine.....	369
The Refrigerator	370

Introduction

Changes in schools

This text book is part of the reform of the school curriculum in Rwanda: that is changes in what is taught in schools and how it is taught. It is hoped this will make what you learn in school useful to you when you leave school, whatever you do then.

In the past, the main thing in schooling has been to learn knowledge – that is facts and ideas about each subject. Now the main idea is that you should be able to use the knowledge you learn by developing **skills** or **competencies**. These skills or competencies include the ability to think for yourself, to be able to communicate with others and explain what you have learnt, and to be creative, that is developing your own ideas, not just following those of the teacher and the text book. You should also be able to find out information and ideas for yourself, rather than just relying on what the teacher or text book tells you.

Activity-based learning

This means that this book has a variety of **activities** for you to do, as well as information for you to read. These activities present you with material or things to do which will help you to learn things and find out things for yourself. You already have a lot of knowledge and ideas based on the experiences you have had and your life within your own community. Some of the activities, therefore, ask you to think about the knowledge and ideas you already have.

In using this book, therefore, it is essential that you **do all the activities**. You will not learn properly unless you do these activities. They are the most important part of the book.

In some ways this makes learning more of a challenge. It is more difficult to think for yourself than to copy what the teacher tells you. But if you take up this challenge you will become a better person and become more successful in your life.

Group work

You can also learn a lot from other people in your class. If you have a problem it can often be solved by discussing it with others. Many of the activities in the book, therefore, involve discussion or other activities in groups or pairs. Your teacher will help to organise these groups and may arrange the classroom so you are always sitting in groups facing each other. You cannot discuss properly unless you are facing each other.

Research

One of the objectives of the new curriculum is to help you find things out for yourself. Some activities, therefore, ask you to do research using books in the library, the internet if your school has this, or other sources such as newspapers and magazines. This means you will develop the skills of learning for yourself when you leave school. Your teacher will help you if your school does not have a good library or internet.

Icons

To guide you, each activity in the book is marked by a symbol or **icon** to show you what kind of activity it is. The icons are as follows:



Thinking Activity

Thinking Activity icon

This indicates thinking for yourself or in groups. You are expected to use your own knowledge or experience, or think about what you read in the book, and answer questions for yourself.



Practical Activity

Practical Activity icon

The hand indicates a practical activity, such as a role play on resolving a conflict, taking part in a debate or following instructions on a map. These activities will help you to learn practical skills which you can use when you leave school.



Writing/Research Activity

Writing Activity icon

Some activities require you to write in your exercise book or elsewhere.



Group Activity

Group Work Activity icon

Group work means that you are expected to discuss something in groups and report back on what your group discussed. In this way you learn from each other and how to work together as a group to address or solve a problem.



Fieldwork Activity

Fieldwork Activity icon

Field work is an enjoyable and practical part of Social Studies. For these activities, you will need to go out of the classroom to study parts of your environment, such as the way that rivers flow, or the distance between landmarks in your school grounds or any other tours in relation to the activity.



Discussion/Vocabulary
Reading

Discussion Activity icon

Some activities require you to discuss an issue with a partner or as part of a group. It is similar to group work, but usually does not require any writing, although some short notes can be written for remembrance..



Computer/Internet Activity

Computer/Internet Activity icon

Some activities require you to use a computer in your computer laboratory or elsewhere.



Pair Activity

Pairing Activity icon

This means you are required to do the activities in pairs and exchange ideas



Listening Activity

Listening Activity icon

The listening activity requires learners to carefully listen to the teacher or fellow learner reading a passage, poem or extraction on the subject and then answer the questions



Observation Activity

Observation Activity icon

Learners are expected to observe and write down the results from activities including experiments or social settings overtime.

Good luck in using the book.

Unit 1

Thin lenses

Key unit Competence

Explain the properties of lenses and image formation by lenses.

My goals

By the end of this unit, I will be able to:

- * explain physical features of thin lenses
- * state the types of lenses and explain their properties
- * differentiate between lenses and curved mirrors
- * explain the phenomenon of refraction of light by lenses
- * construct the ray diagrams for formation of images by lenses
- * explain the defects of lenses and how they can be corrected
- * describe the daily applications of lenses

INTRODUCTORY ACTIVITY

Using a hand lens, candle (object) and a plain paper (screen).

- Light the candle
- Place the candle hand lens and plain paper on the same line respectively
- Vary the position of the hand lens and see the variation of the image on the screen.

Questions

1. Discuss on the image formed on the screen (nature).
2. Try to draw a ray diagram of your observation and then discuss the properties of the hand lens.
3. Discuss on the changes of your observation on the screen that are taking place as you varyate the positions of the hand lens.
4. Discuss other types of lenses and brainstorm their different uses.

Introduction

The scientific study of light and optical material is involved in the making of spectacles, cameras, projectors and optical instrument.

The most important optical materials are the various kinds of glass, but many others such as plastics, polaroid, synthetics and natural crystals have increasingly useful application.

In this unit we shall consider the behavior of certain component of lenses and its images formation.

Observe and think

Look at yourself in a flat mirror and choose one of the following that identifies your observation;

- a) my image is clearly seen without changes.
- b) my image shows some changes.

What do you think

- a) What do you think about formation of your image by the mirror?
- b) What are the characteristics of this image formed?

Key concept

Image formation through a mirror.

Discovery activity

- a) Look through a plain glass window and observe what happens. Discuss with your neighbor on what is observed.
- b) Look through an open window and discuss with your neighbor about the observations.
- c) Compare the observations in part (a) and (b) above.
- d) Look through the lenses and describe the nature of image formed.

What I discover

Just curved mirrors change images, certain transparent medium called lens alter what you see through them.

A lens is a transparent medium (usually glass) bound by one or two curved surfaces. Different lenses give various natures of images depending on their characteristics.

Types of lenses and their characteristics

A lens is a piece of glass with one or two curved surfaces. The lens which is thicker at the centre than at the edges is called a convex lens while the one which is thinner at its centre is known as a concave lens. The curved surface of the lens is called a meniscus. The lens in the human eye is thicker in the centre, and therefore it is a convex lens

Activity 1



Required Materials

- Notebook
- 2 convex lenses
- 2 concave lenses
- Flashlight or a torch bulb
- White paper

Procedure

1. Look closely at the lenses and answer these questions in your notebook:
 - a. How are the lenses shaped?
 - b. How are the lenses alike?
 - c. How are the lenses different?
2. Look through the lenses at the pages of a book, your hands, a hair, and other things. Draw what you see in your notebook and label each picture with the type of lens with which you observed the object. Be sure to answer the following questions:
 - a. How does a concave lens make things look like?
 - b. How does a convex lens make things look like?
3. Lenses bend light in different directions. Shine a flashlight through the lenses onto a piece of white paper and then answer the following questions in your notebook:
 - a. In what direction do convex lenses bend light?
 - b. In what direction do concave lenses bend light?

4. Shine the flashlight through different combinations of lenses: two convex lenses, two concave lenses, one concave and one convex lens. Draw pictures of what you see and answer these questions:
 - a. What happens when you use multiple lenses at the same time?
 - b. Can you use two different lenses to make things far away appear closer?
5. If you can, darken the room and place a convex lens between a sunlit window and a white piece of paper. Place the lens close to the paper and then slowly move the lens towards the window. Draw a picture of what you see in your science notebook.

Do you see that rays change the direction after the lens? How do the emergent rays from each of the lenses behave?

The light rays from the ray box change the direction after passing through the lens. They are therefore refracted by the lens. Hence, lenses form images of objects by refracting light.

You can see that the rays from the convex lens are getting closer and closer to a point. The rays are thus converging, and hence a convex lens is called a converging lens. You can also see that the refracted rays from the concave lens are spreading out. This kind of lens is called diverging lens.

Summary:

1. A lens is a transparent medium (usually glass) bounded by one or two curved surfaces. There are two types of lenses; a convex lens also called a converging lens and a concave lens also known as a diverging lens.
2. A convex lens is the one which is thicker at the centre than at the edges. A concave lens is the one which is thinner at the centre than at the edges.

The figure below shows three classifications of convex lenses and three classifications of concave lenses.



Biconvex lens

Plano convex

Converging meniscus



Biconcave lens

Plano concave

Diverging meniscus

Figure 1.1: Cross section of three classifications of converging and diverging lenses and their representation

Terms used in lenses

Activity 2



- (i) Place a convex lens on a white sheet of paper with its sharp edge perpendicular to the paper.
 - (ii) Draw two parallel lines each touching the apex of the lens.
 - (iii) Measure the length between the two lines.
- Write down in your notebook the comments about the length measured?

The length between the lines is the width of the lens. This width of the lens is called the aperture of the lens.

Activity 3



- Place two similar Plano convex lenses together so that the two plane surfaces are in contact.
- Write down in your notebook your observation.

When do the two Plano convex lenses form a bi-convex lens? The two plane surfaces of the Plano convex lenses form a vertical line which divides the lens into two halves. This line is called the axis of the lens.

Activity 4



- (i) You have learned about symmetry in secondary mathematics. How many lines of symmetry does a convex lens have?
- (ii) Place a convex lens on a white sheet of paper and perpendicular to it, draw its outline.

- (iii) Draw its lines of symmetry.
- (iv) Where do these lines meet?
- (v) Repeat the above steps ii) and iii) but with a concave lens.

Discuss in your group and write down in your notebook the observation.

Lenses have two lines of symmetry, a vertical line and a horizontal line. The vertical line is called the axis of the lens (already seen in activity 2). The horizontal line is known as the principal axis of the lens.

Notice that these lines meet at a point. This point is the centre of the lens, called the optical centre of the lens denoted by **O**.



Activity 5

- (i) Place a convex lens on a white sheet of paper and draw its outline.
- (ii) Produce the outlines so as to make spheres from which the lens was cut.

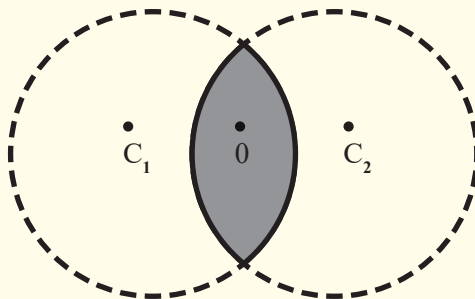

Figure 1.2: Drawing a biconvex lens

- (iii) Note the centres C_1 and C_2 of the spheres formed.
- (iv) Join the two centres of the spheres.
- (v) Measure the distance between each centre and the optical centre.

What do you notice about the measured distance?

Can you see that the distances, OC_1 and OC_2 are equal?

Repeat the same but with a concave lens.

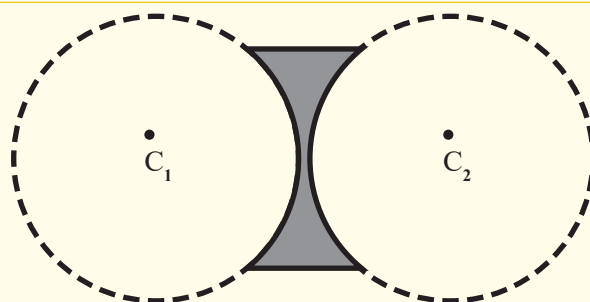

Figure 1.3: Drawing a biconcave lens

Do you see that the concave lens is not part of the spheres?

Discuss with your neighbour and write in your notebook the observation.

The centre of each sphere is called the centre of curvature of the surface of a lens and the distance from the centre of curvature to the optical centre is the radius of curvature of the surface. Since the convex lens forms part of the spheres, its centre of curvature is real and hence its radius of curvature.

Activity 6



- (i) Use a torch to produce several rays of light to shine on the convex lens.

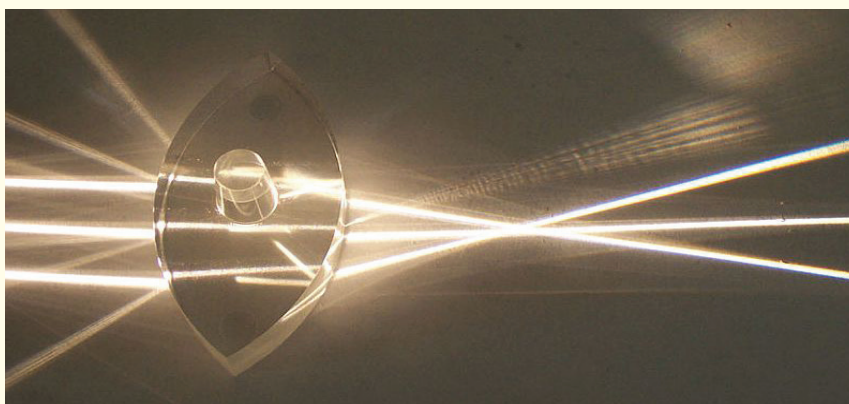

Figure 1.4: Light through a converging lens

- (ii) Look at rays emerging from the lens.

Can you see that the rays converge to a point? Which name do you give to this point? Write down the observation in your notebook.

Repeat the experiment but with the concave lens. Write down the observation in your notebook.

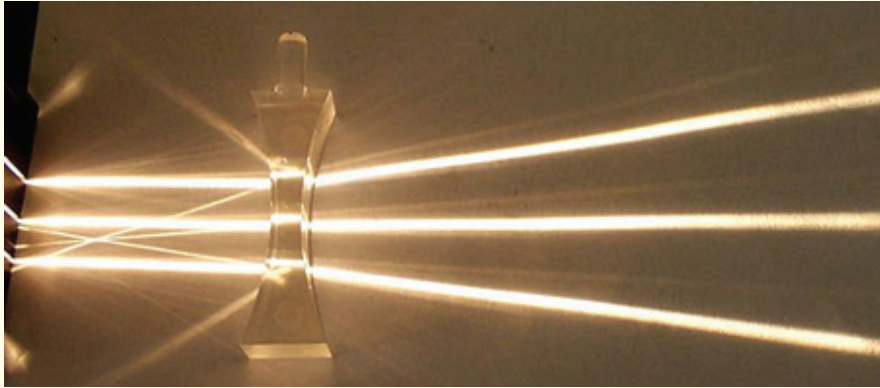

Figure 1.5: Light through a diverging lens

This point to which all parallel rays converge after refraction by a convex lens is called the principal focus of the convex lens.

The rays emerge from the lens when they are spreading out. They are diverged and appear to come from a point. This point from which the rays appear to diverge after refraction by the concave lens is the principal focus of the lens.

Since rays converge to this point for the case of a convex lens, the principal focus of a convex lens is real. The principal focus of a concave lens is virtual as the rays appear to come from it.

Repeat the above experiments by changing the lenses so that their right sides become the left.

Do you see that the same thing happens for each?

Light can travel into the lens from the left or from the right. It therefore has two principal foci on both sides of the lens.

The principal focus of a lens is also called the focal point of the lens, and it is denoted by F .



Activity 7

- (i) Hold a convex lens in a lens holder so that the rays of light from a distant tree are focused on a white piece of paper by moving the paper to and fro from the lens.
- (ii) Measure the distance from the lens to the sheet of paper. Repeat the above experiment with a fatter lens.

Does the fatter lens give a shorter focal length or a longer one?

Discuss on the observation and write short notes in your notebook.

Since the image forms where the refracted rays meet and because the rays from the distant tree are parallel, the piece of paper must then be at the principal focus of the lens. This distance from the lens to the image is the focal length of the lens. The focal length of the lens is thus the distance from the centre of the lens to the principal focus. It is always denoted by f .

The fatter lens has a shorter focal length, implying that the thicker the lens, the shorter the focal length and vice versa.

We have already seen that the lens has two principal foci. It means that these principal foci are at equal distances on the opposite sides of the lens.

Repeat the experiment with the concave lens.

What do you notice?

The image cannot be seen. This is because the concave lens has a virtual principal focus.

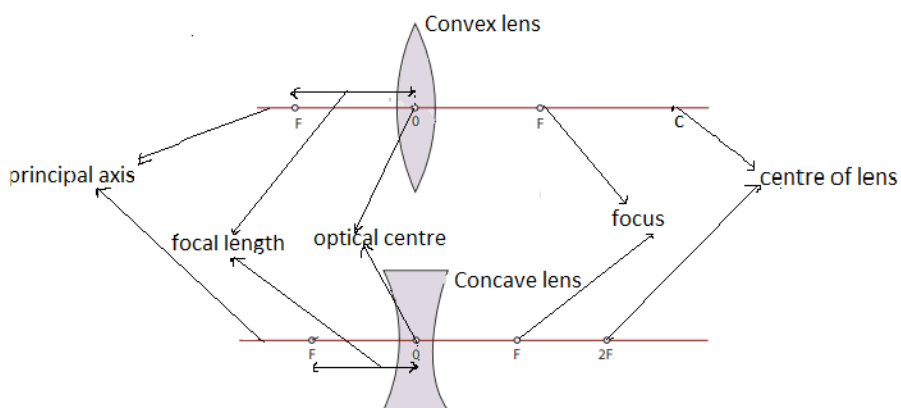

Figure: Terms used in lenses

Activity 8



Read and interpret the sentences below and fill in the table redrawn in your notebook.

- The distance between the edges of the lens.
- The line through the optical centre at right angles to the lens or the line passing through the optical centre that joins the centers of curvature of the two surfaces of the lens.
- A point on the principal axis to which all rays parallel and close to the axis converge in case of a convex lens or from which they appear to diverge in case of a concave lens after passing through the lens.
- The distance from the optical centre to the principal focus of the lens.
- A plane containing a focal point in which all parallel rays close to the axis converge or appear to diverge after refraction by the lens.
- The center of the lens or point in which vertical line through the lens meets the principal axis.

Table: Definition of terms used in lenses

Vocabulary terms in lenses	Corresponding definition
Focal point or principal focus	
Focal plane	
Aperture	
Principal axis	
Optical centre	
Focal length.	

Go Further

Visit the library and draw the diagrams in your notebook using convex and concave lenses. Indicate all terms defined in the table above on the diagrams.

Refraction of light through lenses

Lenses can be thought of as a series of tiny refracting prisms, each of which refracts light to produce an image. These prisms are near each other (truncated) and when they act together, they produce a bright image focused at a point.

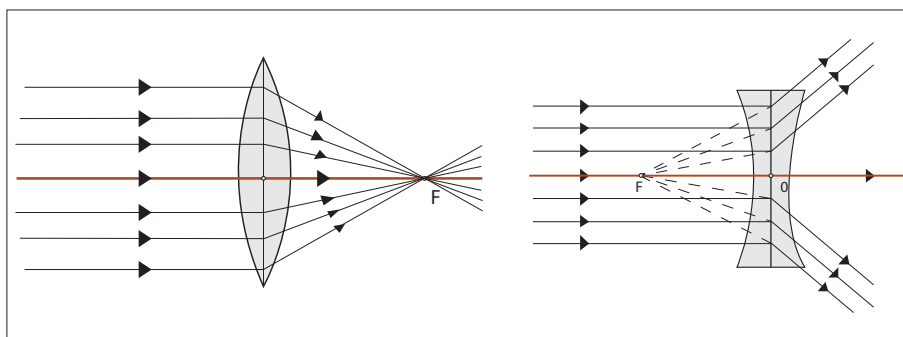

Figure 1.6: Action of converging and diverging lenses

Each section of a lens acts as a tiny glass prism. The refracting angles of these prisms decrease from the edges to its centre. As a result, light is deviated more at the edges than at the centre of the lens.

The refracting angles of the truncated prisms in a converging lens point to the edges and so bring the parallel rays to a focus.

The truncated prisms of the diverging lens point the opposite way to those of the converging lens, and so a divergent beam is obtained when parallel rays are refracted by this lens because the deviation of the light is in the opposite direction.

The middle part of the lens acts like a rectangular piece of glass and a ray incident to it strikes it normally, and thus passes undeviated.

Properties of images formed by lenses

Activity 9



- (i) Hold a hand lens about 2m from the window. Look through the lens. (CAUTION: Do not look at the sun).

What do you see?

- (ii) Move the lens farther away from your eye.

What changes do you notice?

- (iii) Now, hold the lens between the window and a white sheet of paper, but closer to paper.

- (iv) Slowly move the lens away from the paper towards the window. Keep watching the paper.

What do you see? What happens as you move the paper?

Do you see that an inverted image of trees outside is formed on the paper?
How do you think the image is formed?

Rays come from all points on the objects. Where these rays meet or appear to meet after refraction by the lens is the position of the image.

Activity 10



You are provided with a lamp, a convex lens of known focal length, a lens holder and a white sheet of paper.

- (i) Arrange the apparatus as shown below to investigate different images formed when the object (lamp) is placed at different positions from the lens.

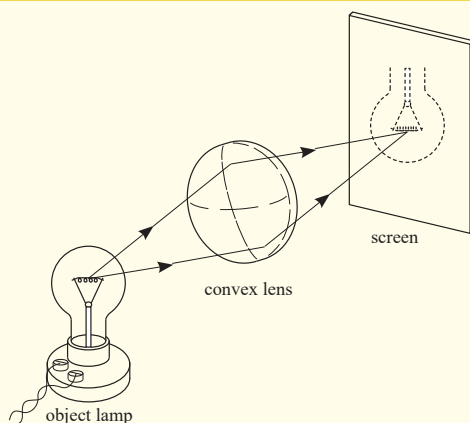

Figure 1.7: Image of a lamp formed by a convex lens

- (ii) For each position of the object, move the screen (white sheet of paper) until you get a sharp image.
(iii) Fill in the table to show your results

Position of Object	Position of Image	Image Real or Virtual	Image Inverted or Erect	Image smaller or larger than object
At infinity				
Outside 2F				
Between 2F and F				
At F				
Between F and the lens				

Can you see that some images are larger than the object, some smaller and others same size as the object?

Do you notice that the images are inverted? What do you notice when an object is between F and the lens? Can you see that it is not seen on the screen?

Repeat the above experiment but with a concave lens of known focal length.

What do you notice in your observation?

Now, remove the screen and observe with the eye.

What do you notice? Do you see that the image is small and upright (erect)?

Notice that an image cannot be seen on the screen irrespective of the position of the object. The nature of the image formed by a convex lens depends on the position of the object along the principal axis of the lens.

The principal focus of a lens plays an important part in the formation of an image by a lens since parallel rays from the object converge to it, and thus, we consider points F and 2F when describing the nature of the images formed by the lens. These images can be larger or smaller than the object or same size as the object. When an image is larger than the object, we say that it is magnified and when it is smaller, we say that it is diminished. Images which can be formed on the screen are Real images. Because light rays pass through these images, real images can be formed on the screen. All real images formed by the convex lens are inverted.

When an object is between F and the lens, there is no image formed on the screen. The image formed is not real and is only seen by removing the screen and placing an eye in its position. We say that it is a virtual image. For a

virtual image, rays appear to come from its position. Unlike for a convex lens where the nature of the image depends on the position of the object, a concave lens gives only an upright, small, virtual image, and is situated between the principal focus and the lens for all positions of the object.

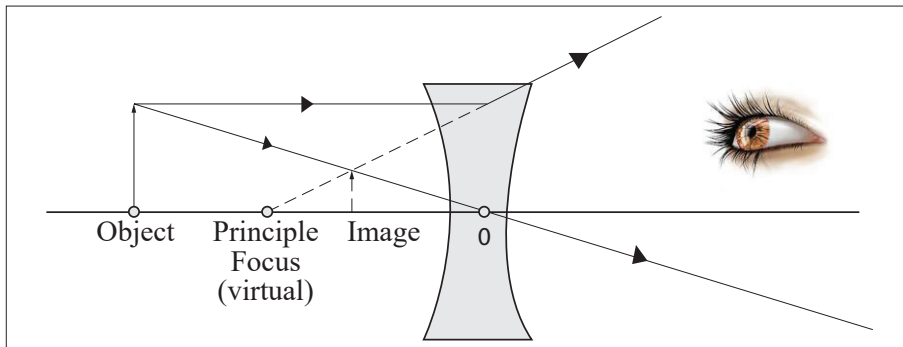

Figure 1.8: Viewing virtual image of diverging lens

Critical thinking:

1. Design an experiment to study images formed by convex lenses of various focal lengths. How does the focal length affect the position and size of the image produced?
2. Suppose you wanted to closely examine the leaf of a plant, which type of a lens would you use? Explain your decision.

Ray diagrams and properties of images formed by lenses



Activity 11

Shine on a convex lens in a dark room using a torch bulb. How many rays do you see emerging from the lens?

Notice that the emergent rays are infinite

We have already seen that an image is formed where rays from the object meet. Rays come from all points on the objects. However, for simplicity, only a few rays from one point are considered when drawing ray diagrams. Where these rays meet or appear to meet after refraction by the lens is the position of the image.

To locate the position of the image, two of the following three rays are considered.

1. A ray parallel to the principal axis which after refraction passes through the principle focus or appears to come from it.

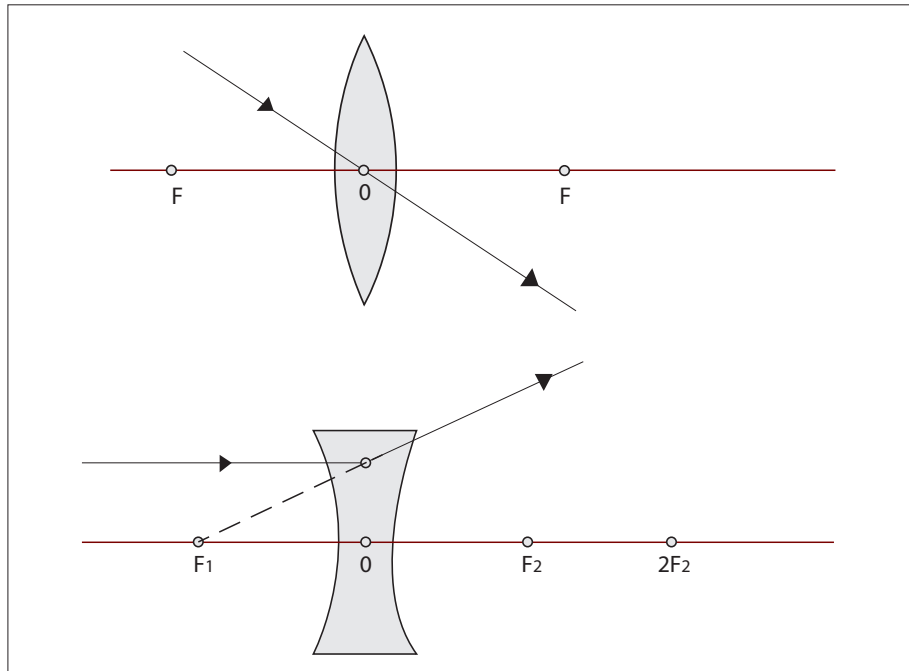

Figure 1.9: Refraction of a ray parallel to the principal axis

2. A ray through the optical centre which passes through the lens undeviated (un deflected).

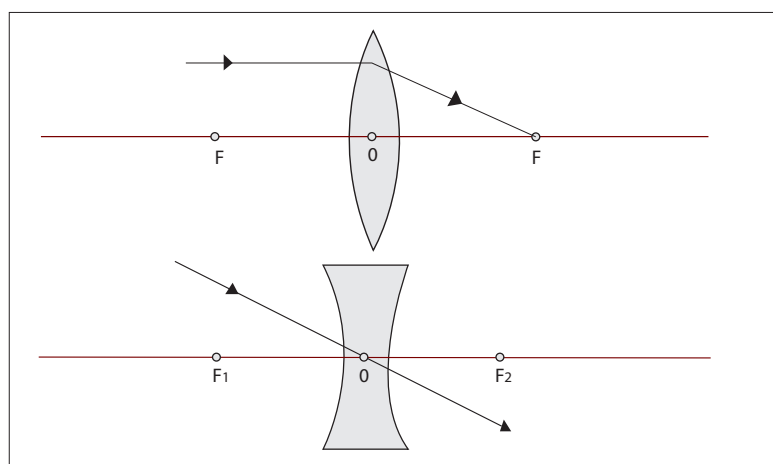

Figure 1.10: Ray passing through the optical centre

3. A ray through the principal focus which is refracted parallel to the principal axis.

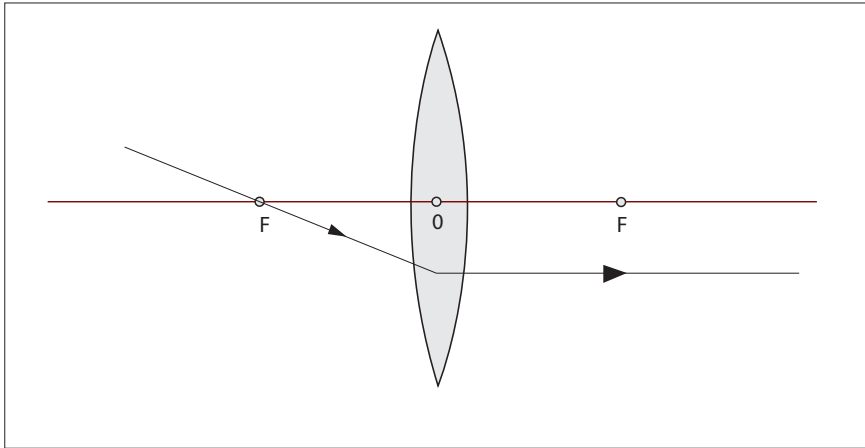

Figure 1.11: Refraction of a ray passing through the focus

The central part of a lens acts as a small parallel –sided block which slightly displaces but does not deviate a ray passing through it and for a thin lens, the displacement can be ignored.

In ray diagrams, a thin lens is represented by a straight line at which all the refraction is considered to occur. In reality, bending takes place at each surface of the lens.

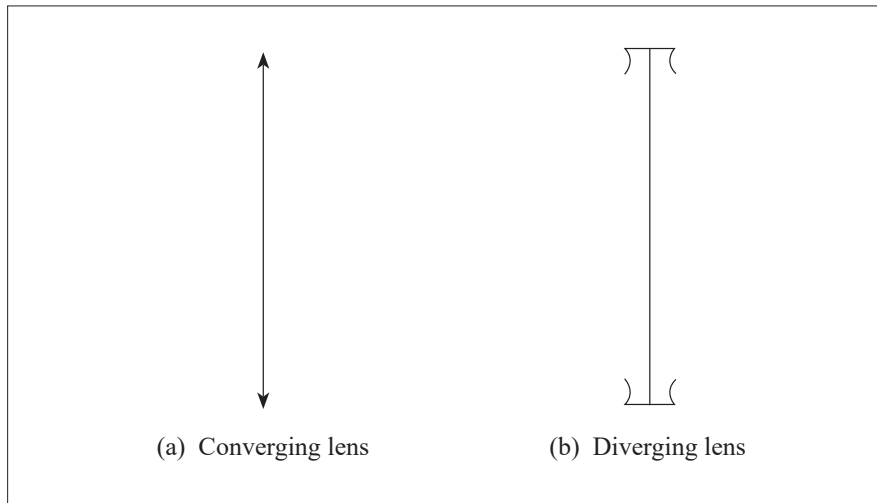

Figure 1.12: Representation of convex and concave lenses in ray diagrams

Activity 12



- (i) On a graph paper, draw a long horizontal line to represent the principal axis of the lens and a shorter line, at right angles to represent a thin lens.
- (ii) Using 2cm to represent 10 units on both axes, mark the position of F on each side of the lens at 20cm from the lens. Also mark the points 2F at twice the focal length of the lens.
- (iii) Mark the position of an object (pin), 20cm tall on the principal axis at a distance of 45cm from the lens.
- (iv) Draw a line from the top of an object parallel to the axis that will pass through F after passing through the lens.
- (v) similarly, draw a line that passes through the centre of the lens.
- (vi) Mark the position on the principal axis where the two lines meet.
- (vii) Measure the distance of this position from the lens.

The position where the two lines meet is the position of the image.

Is the image inverted or upright?

The tip of the image is at the point where the two lines meet. Since the object is standing on the principal axis, the bottom of the image is also at the axis, hence the image is inverted.

Measure the height of the image (using the scales).

Is the image magnified or diminished?

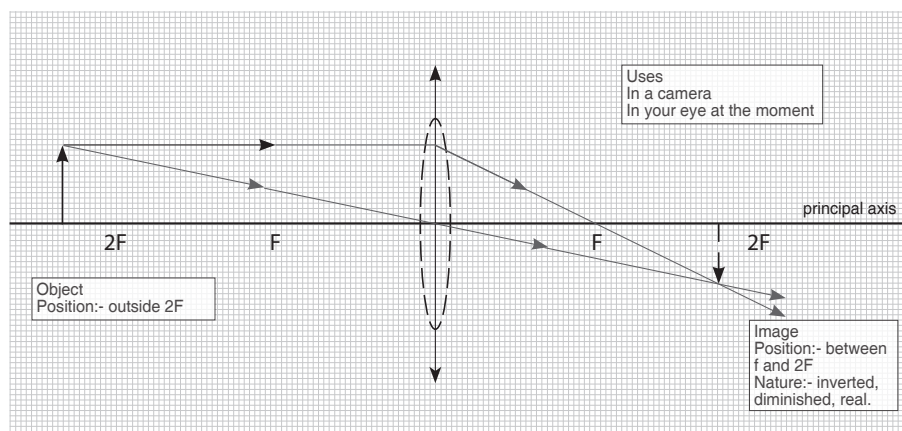

Figure 1.13: The position of the image formed by a lens

Ray diagrams for a convex lens

Object between the lens and F

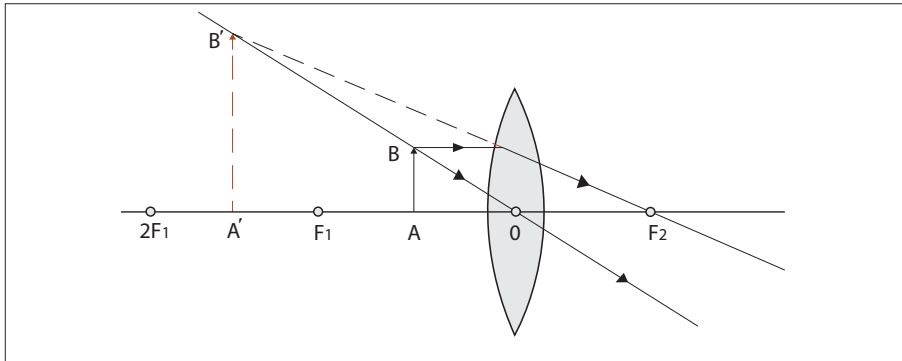

Figure 1.14: Images of an object between O and F

Nature of image

The image is virtual, erect, larger than the object and behind the object.

Application activity 1.1

How is this lens useful when the object is in this position?

Object at F

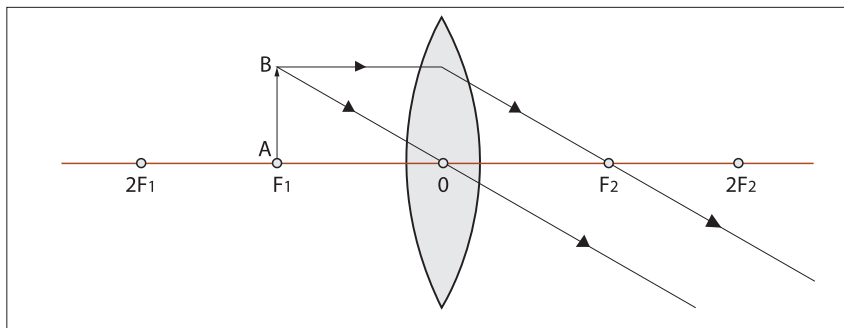

Figure 1.15: Image of an object at infinity

Nature of image

The image is formed at infinity.

Application activity 1.2

Can you think of how useful is the lens when an object is at its focal point?
What is it?

Object between F and 2F

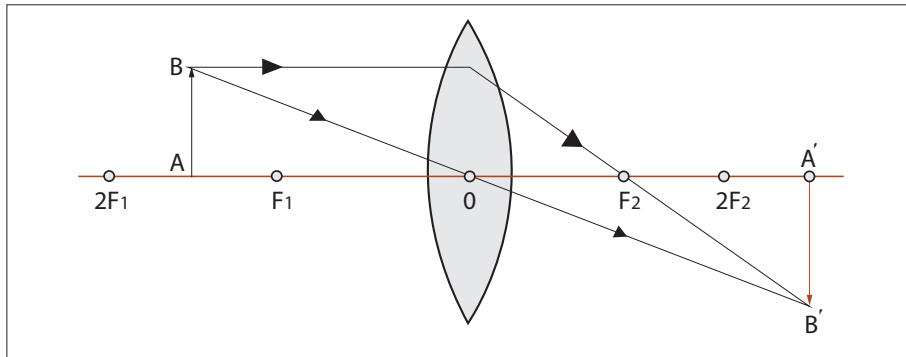

Figure 1.16: Image of an object between F and 2F

Nature of image

The image is real, inverted, larger than object (magnified) and beyond 2F.

Application activity 1.3

How is the lens useful when the object is in the above position?

Object at 2F

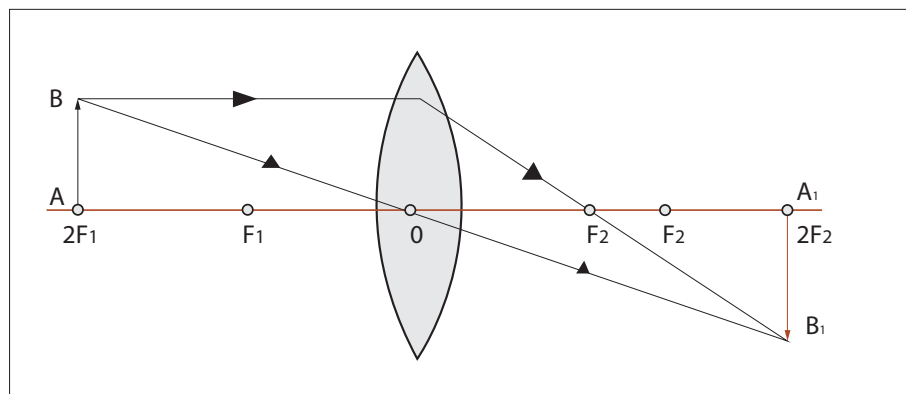

Figure 1.17: Image of an object at 2F

Nature of image

The image is real, inverted and same size as object.

Object beyond $2F$

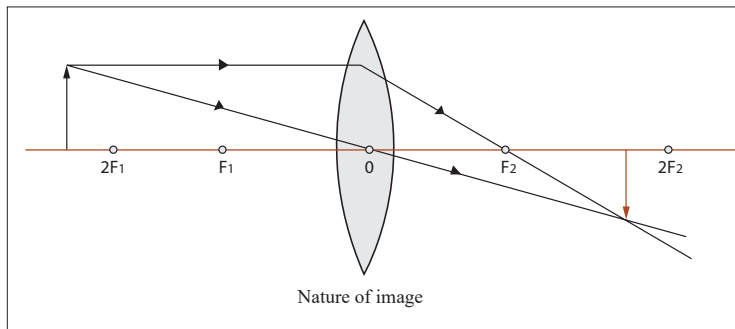

Figure 1.18: Image of an object beyond $2F$

The image is real, inverted, smaller than object (dimensional) and is formed between F and $2F$.

Application activity 1.4

What can be a daily application of the lens when an object is in this position?

Object at infinity

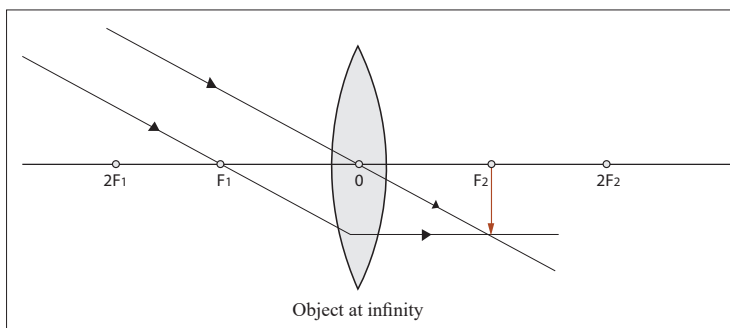

Figure 1.19: Image of an object at infinity

Nature of image

The image is real, inverted, smaller than object and is formed at F .

When an object is between the lens and the principal focus, the rays from the object never converge, instead they appear to come from a position behind the lens. In this case, the lens is used as a simple magnifying glass because it forms an upright and magnified image (Figure 1.14).

When an object is at the principal focus of the lens, refracted rays emerge from the lens parallel to each other, and the lens is used as a search light torch, and theatre spotlights (Figure 1.15).

Figure 1.16 shows that when an object is between F and $2F$, the lens forms a magnified real image. In this case, a lens is used as a film projector.

When an object is beyond $2F$ (Figure 1.18), a lens forms real and small image. The lens is used as a camera because this small, real image can be formed on a piece of film.

Ray diagrams for a concave lens

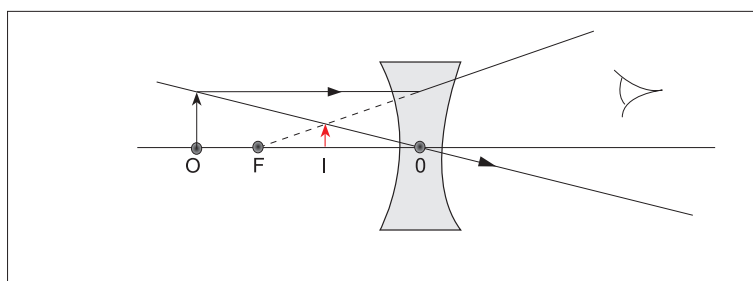

Figure 1.20: Formation of an image by a diverging lens

Accurate construction of ray diagrams

Problems for locating the position of the image can be solved by constructing a ray diagram as an accurate scale drawing on a graph paper.

Activity 13



An object 2cm high stands on the principal axis at a distance of 9cm from a convex lens. If the focal length of the lens is 6cm, what is the nature, size and position of the image.

Scale: Let 1cm on the paper represent 2cm of actual distance.

Example

1. An object is placed 40 cm away from a diverging lens of focal length 20cm. If it is 2 cm high, determine graphically the position, size and nature of the image.
2. Let 1cm on the paper represent 10 cm on the horizontal axis and 1cm on the vertical axis of the actual distance.

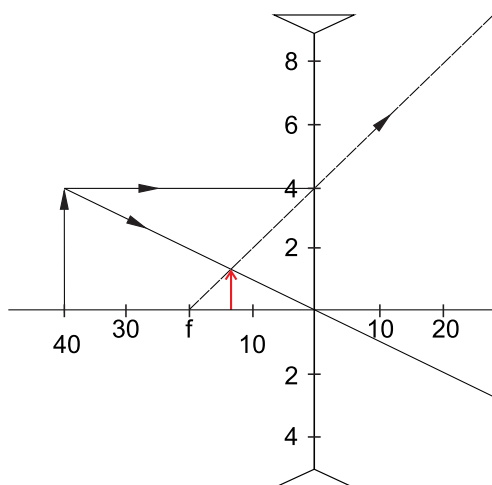

Figure 1.21: Position of an image formed by a lens

The image is virtual, erect, 0.7cm tall and is formed at 13cm from the lens on the same side as the object.

The thin lens formula



Activity 14

Using the same question in the above activity (13), find the position of the image v for an object at a distance u in front of a convex lens of focal length f , using the formula

$$\frac{1}{u} + \frac{1}{v} = \frac{1}{f}$$

What value of the image distance have you got?

Compare the value obtained with the one obtained from a ray diagram.

What do you notice in accordance to your observations?

Activity 15



- (i) Draw a ray diagram to determine the nature and position of the image of an object placed 10cm from a diverging lens of focal length 15cm.
- (ii) Using the above information, find the nature and position of the image using a lens formula. (assign f a negative sign during your substitution).

What is the location of the image?

The lens formula gives the relationship between the object distance, u , image distance, v , and the focal length, f of the lens.

This relation is given by

$$\frac{1}{u} + \frac{1}{v} = \frac{1}{f}$$

Where u is the distance of the object from the lens, v the image distance and f the focal length of the lens.

The sign convention

From activity 13, we notice that all the distances are measured from the optical centre and in activity 14, we substituted for u , v and f using positive numerical values. It therefore follows that distances of real images and real principal focus are positive.

In activity 14, then you will notice that the image distance from the lens is negative but equal to the distance determined graphically. This distance is obtained by using a negative numerical value of the focal length. Since a concave lens has a virtual principal focus, and forms virtual images, distances of virtual images and virtual principal foci are negative. Sign convention states that real is positive while virtual is negative. This should be put under consideration when one is using the lens formula to solve problems.

Derivation of the lens formula

Convex lens

Consider a point object O on the principal axis, at a distance, u greater than the focal length from the lens.

Suppose that a ray from O is incident on the lens at a small height h above the axis and is refracted to form an image I at a distance v from the lens.

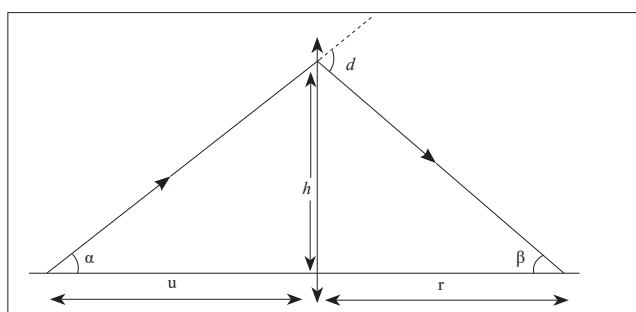

Figure 1.22: Diagram of deriving lens formula

Let α and β be angles the incident ray and the refracted ray make with the axis

If the incident ray suffers a small deviation, d , then, from fig. 1.22,

$d = \alpha + \beta$ (Two interior angles of a triangle are equal to one opposite exterior angle). Since the ray strikes the lens at a height, h , it follows that:

$$\tan \alpha = \frac{h}{u} \text{ and } \tan \beta = \frac{h}{v}$$

For thin lenses, α and β are very small, and thus $\tan \alpha \approx \alpha$ and $\tan \beta \approx \beta$ in radians.

Therefore, $\alpha = \frac{h}{u}$ and $\beta = \frac{h}{v}$

$$\text{So, } d = \frac{h}{u} + \frac{h}{v} \quad (1)$$

Now consider a ray from a finite object parallel to the principal axis and incident on the lens at the small height, h . After refraction, this ray passes through the focal point, F , a distance, f , from the lens.

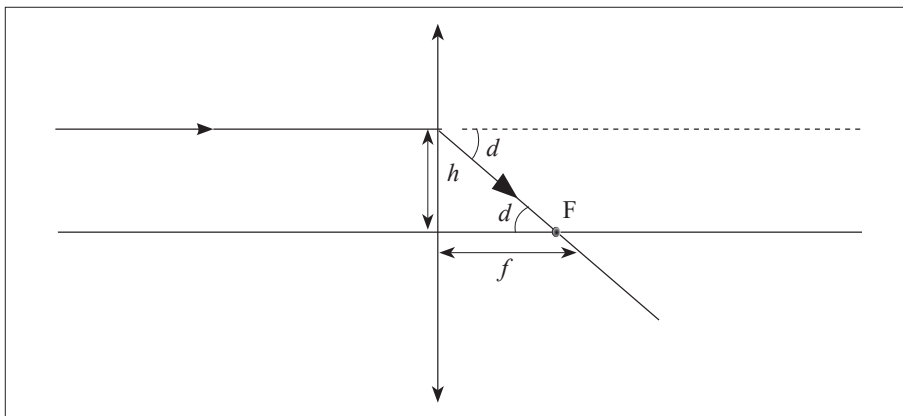

Figure 1.23: Position of an image of an object at infinity

This incident ray suffers the same deviation, d , as above since the lens is considered as a small angle prism and all rays entering a small angle of prism at small angles of incidence suffer the same deviation. From the figure above, the deviation, d , is equal to the angle the refracted ray makes with the axis (alternate angles)

$$\text{Thus } \tan d = \frac{h}{f}$$

For d small, $\tan d \approx d$

$$\text{Therefore, } d = \frac{h}{f} \quad (2)$$

From (1) and (2)

$$\frac{h}{u} + \frac{h}{v} = \frac{h}{f}$$

Dividing by h on both sides, we have $\frac{h}{u} + \frac{h}{v} = \frac{h}{f}$

Hence for any lens of focal length f , $\frac{h}{u} + \frac{h}{v} = \frac{h}{f}$

Dividing by h , we have $\frac{1}{u} + \frac{1}{v} = \frac{1}{f}$

Thus the $\frac{1}{u} + \frac{1}{v} = \frac{1}{f}$ equation applies to converging lenses.

Concave lens

Consider a point object O on the principal axis of the diverging lens at a distance, u , so that its image is formed at a distance, v .

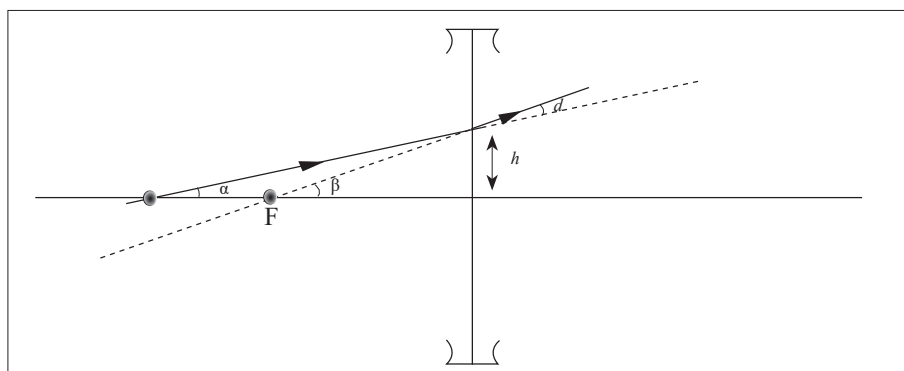

Figure 1.24: Deriving a lens formula using a diverging lens

Let angles α and β be the angles made by the incident and refracted rays with the axis respectively.

From the diagram, $\alpha + d = \beta$

Thus $d = \beta - \alpha$

But $\tan \alpha = \frac{h}{v}$ and $\tan \beta = \frac{h}{u}$ for small angles, $\tan \alpha \approx \alpha$ and $\tan \beta \approx \beta$.

$$\text{Then } d = \frac{h}{v} - \frac{h}{u} \quad (1)$$

Now consider a ray from a finite sized object parallel to the axis. This ray appears to come from the focal point F after refraction.

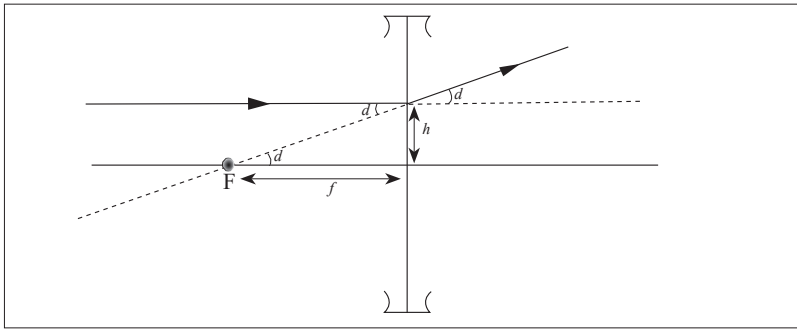

Figure 1.25: Image formed by a diverging lens of an object at infinity

From the diagram, $\tan d = \frac{h}{f}$

But for d very small $\tan d \approx d$

Thus $d = \frac{h}{v}$ (2)

If we introduce the “real is positive” sign convention, the focal length of the diverging lens is negative and the distance v in equation (1) is also negative since it’s a virtual image.

Therefore, it follows from the above equations that $\frac{-h}{f} = \frac{-h}{v} - \frac{h}{u}$

Dividing by, $-h$, we have $\frac{1}{u} - \frac{1}{v} = \frac{1}{f}$

Thus this lens equation $\frac{1}{u} - \frac{1}{v} = \frac{1}{f}$ applies to diverging lenses. To all cases of real and virtual objects and images, we use the sign convention rule.

Magnification

Activity 16



- Using the same drawing in activity 15, measure the heights of the object and the image respectively.
- Find the ratio of the image height to the object height.
- How many times is the image larger than the object?
- Now, find the ratio of the distance of image from the lens to the distance of object from the lens.
- Compare the two ratios.

What do you notice in accordance to your observation?

You can notice that the ratio of image height to object height is equal to that of image distance to object distance from the lens. This ratio is called Linear magnification of the image. It tells us the number of times the image is larger than the object. It is sometimes called Lateral or transverse magnification.

Thus, the lateral, transverse or linear magnification of an image produced by the lens is the ratio of image size to the object size or image distance to object distance.

$$\text{Mathematically, } m = \frac{\text{Image height}}{\text{object height}} \quad \text{or} \quad m = \frac{\text{Image distance}}{\text{object distance}}$$

$$\text{Hence } m = \frac{v}{u}$$

Applications of the lens formula

The following examples show how to apply the lens equation, $\frac{1}{u} + \frac{1}{v} = \frac{1}{f}$ correctly.

Example

An object is placed 20cm from a converging lens of focal length 15 cm. Find the nature, position and magnification of the image.

The object is real and therefore $u = +20\text{cm}$

Since the lens is converging, $f = +15\text{cm}$

$$\text{Substituting in } \frac{1}{u} + \frac{1}{v} = \frac{1}{f}$$

$$\text{We have, } \frac{1}{20} + \frac{1}{v} = \frac{1}{15}$$

$$\text{Therefore, } \frac{1}{v} = \frac{1}{15} - \frac{1}{20}$$

$$\frac{1}{v} = \left(\frac{4-3}{60}\right)\text{cm}^{-1}$$

$$\text{Hence, } v = 60\text{cm}$$

Since v is positive, the image is real and it is 60cm from the lens.

$$\text{Magnification, } m = \frac{v}{u}$$

$$\text{Thus } m = 3$$

Therefore, the image is three times taller than the object.

Application activity 1.5

1. An object is placed 12cm from a converging lens of focal length 18 cm. Find the nature and the position of the image.
2. Find the nature and position of the image of an object placed 15cm from a diverging lens of focal length 15cm.

Critical thinking exercise

From the magnification formula and the lens formula, show that the image distance v can be related to the focal length of the lens by $m = \frac{v}{f} - 1$.

Least possible distance between object and real image with converging lens

Activity 17



You are provided with a convex lens of known focal length, a pin and a white screen.

- (i) Place an object (pin) in front of a concave lens at a distance greater than the focal length.
- (ii) Place the screen on the other side of the lens and move it to and fro until a clear image is seen.
- (iii) Measure the distance between the object and the screen.
- (iv) Repeat the above procedures for other values of object distance.
- (v) Compare the corresponding distances between the object and the image with the focal length of the lens.
- (vi) Are the distances between corresponding objects and images greater than four times the focal length of the lens?
- (vii) Discuss in your groups and write short notes in your notebook.

Experiments show that it is not always possible to obtain a real image on a screen although the object and the screen may both be at a greater distance from a converging lens than its focal length. Theory shows that the minimum distance between the object and the screen for an image to be formed is four times the focal length, $4f$. Therefore, the distance between an object and a screen must be equal to or greater than four times the focal length.

Consider a point object O on the principal axis of a converging lens forming an image I.

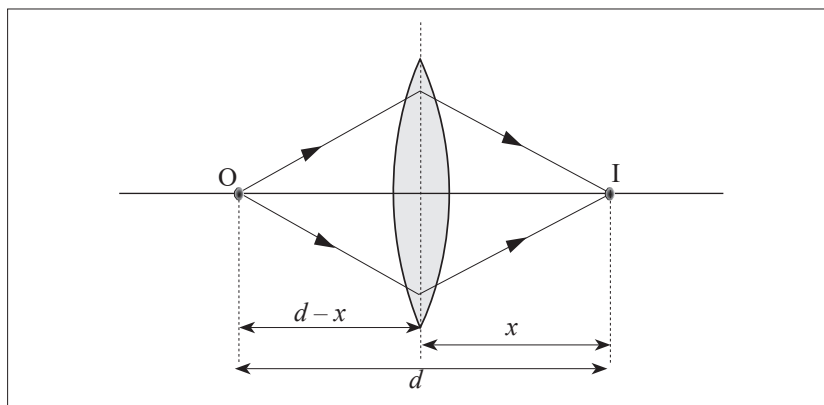

Figure 1.26: Minimum distance between object and image

Suppose that the image distance is x , and the distance between object and image is d , then the object distance $u = d - x$.

Substituting in the lens equation, $\frac{1}{f} = \frac{1}{x} + \frac{1}{d-x}$

We therefore have $\frac{1}{f} = \frac{d-x+x}{x(d-x)} = \frac{d}{dx-x^2}$

It follows that, $fd = dx - x^2$.

Hence, $x^2 - dx + df = 0$

This is a quadratic equation, and for a real image, the roots of this equation must be real.

Applying the condition for real roots $b^2 - 4ac \geq 0$ for the general quadratic equation $ax^2 - bx + c = 0$,

Then, $d^2 - 4df \geq 0$

It follows that $d^2 \geq 4df$

Thus $d \geq 4f$

Thus the distance d between the object and the screen must be greater than or equal to $4f$ otherwise no image can be formed on the screen.

Power of the lens

Activity 18



- (i) Focus a distant object through the window with a thin lens.
- (ii) Note the distance of the screen from the lens.
- (iii) Repeat the above procedures with a thicker lens.
- (iv) Compare the distances of the images formed for each case.

Do you notice that the image formed by the thicker lens is nearer to the lens than that formed by the thinner one?

Discuss and write short notes in your note book.

Since the image formed by the thicker lens is nearer, the thicker lens is more powerful than the thinner lens of the same material. We have already seen that an image of a distant object forms at the focus of the lens and the thicker the lens the shorter the focal length. So the power of the lens depends on its focal length, that is, as the focal length becomes shorter, the power increases. The power of the lens is defined as the reciprocal of its focal length in metres.

$$\text{Power of a lens} = p = \frac{1}{f}$$

The standard unit of power of a lens is a Dioptre.

Application activity 1.6

1. Calculate the power of the lens of focal length of 15 cm.
2. A converging lens has a power of 0.02D, what is its focal length?

Determination of the focal length of the lens

Converging lens

Rough method



Activity 19

- (i) Place a converging lens on a table while facing a window.
- (ii) Place a white screen behind the lens.

Move the screen to and fro (forwards and backwards) until a sharp image of a distant object is seen on the screen.

Discuss and write down the observation in your notebook.

Measure the distance from the lens to the screen.

The distance from the lens to the screen is the focal length of the lens since rays from a distant object strike the lens when they are parallel.

Graphical determination of focal length of a convex lens



Activity 20

You are provided with a lamp, a screen with cross wires, a convex lens, a lens holder and a white sheet of paper

- (i) Set up the lens in front of an illuminated object at a given distance $u=15\text{cm}$ and adjust the screen until a sharp image is seen.

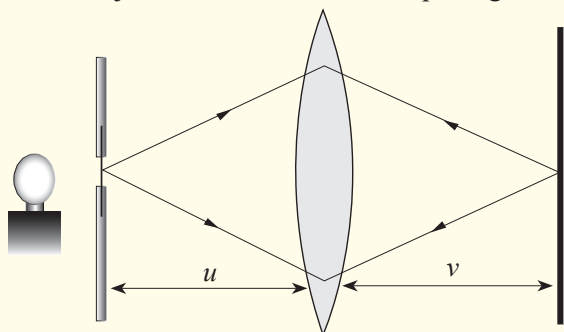

Figure 1.27: Focal length of a lens by u and v method

- (ii) Measure the distance, v from the lens to the screen.
 (iii) Repeat the above for values of $u = 20 \text{ cm}, 25 \text{ cm}, 30 \text{ cm}, 35 \text{ cm}, 40 \text{ cm}$ and 45 cm .
 (iv) Record your results in a suitable table including values of uv and $u + v$.

u / cm	v / cm	$u + v / \text{cm}$	uv / cm^2

- (v) Plot a graph of uv against $u + v$.
 (vi) Find the slope (gradient), of the graph.

From $\frac{1}{u} + \frac{1}{v} = \frac{1}{f}$

It follows that $\frac{u+v}{uv} = \frac{1}{f}$,

Thus, $f = \frac{uv}{u+v}$,

Therefore, finding the slope of the graph gives the mean value of the focal length.

Similarly, from $\frac{u+v}{uv} = \frac{1}{f}$

It implies that $uv = f(u+v)$

The above expression is an equation of a line and hence a graph of uv against $u+v$ is a straight line passing through the origin and its slope is the focal length f of the lens.

Instead of using an illuminated object, a pin may be set up in front of the lens so that it forms a real image on the opposite side whereby the position of this image can be located by the help of a search pin using the method of no-parallax.

Diverging lens

Determination of focal length of a diverging lens by Concave mirror method

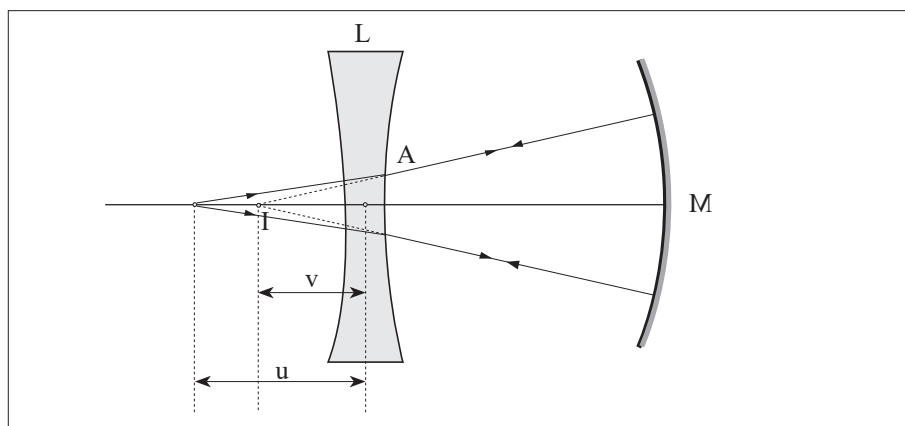

Figure 1.28: Focal length of a diverging lens



Activity 21

You are provided with a concave lens, concave mirror of known radius of curvature, a screen with cross wires and a lamp.

- (i) Place an object in front of a concave lens (diverging lens) at a measurable distance from the lens.
 - (ii) Place a concave mirror behind the lens so that a diverging beam is incident on it.
 - (iii) With the object and the lens in position, move the mirror to and fro until an image coincides with the object.
 - (iv) Measure the object distance.
 - (v) Measure the distance between the lens and the mirror, L_m .
 - (vi) Calculate the image distance v from the lens $v = r - L_m$, where r is the radius of curvature of the mirror.
 - (vii) Find the focal length of the lens using $\frac{1}{u} + \frac{1}{v} = \frac{1}{f}$
- Discuss on the observation and write short notes in your notebook.

We have already seen that a concave lens forms virtual images of real images which cannot be seen on the screen. So, to determine the focal length of a diverging lens, we need to form a virtual object for the diverging lens so that a real image is produced. This is achieved in the experiment by putting a concave mirror behind the lens so as to reflect back the diverging rays from the lens.

As you saw in your lower secondary classes, when an object is placed at the principal focus of a concave mirror, the image is formed at the same position with it. Now, since the object and its image are coinciding, it means that they are at the centre of curvature of the mirror; v is negative as I is a virtual image for the lens, and as the object and image are coincident, the rays must be incident normally on the mirror M . Thus, reflected rays from the mirror pass through its centre of curvature which is the position of the virtual image.

Combination of lenses

In our next unit, we shall talk about instruments which use lenses to focus objects. Among others, a microscope uses a combination of two lenses to focus objects.

Effective focal length of a combination of lenses

Activity 22



- a) (i) Focus a distant tree through a window using a convex lens onto a white sheet of paper.
- (ii) Measure the distance from the lens to the paper.
- b) (i) With the convex lens still in position, place another convex lens similar to the above besides and in contact with it.
- (ii) Move the paper to and fro until a clear image of the tree is focused on it.
- (iii) Measure the distance from the lenses to the white sheet of paper.

Derivation of the expression of effective focal length of the lens combination. The focal length, f of a combination of two thin lenses of focal lengths f_1 and f_2 respectively can be found by considering a point object O placed on the principal axis of the lenses in contact.

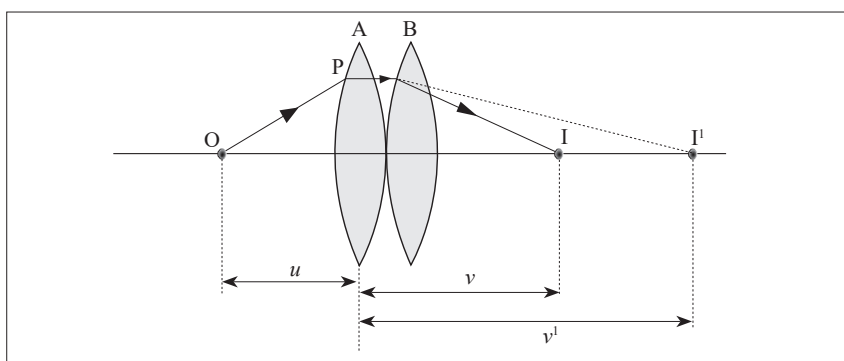

Figure 1.29: Focal length of a converging lens

In the absence of lens B, ray OP would pass through point I' which would be a real image of lens A.

If u is the object distance and v' is the image distance, then from the lens formula;

$$\text{It follows that } \frac{1}{f_1} = \frac{1}{u} + \frac{1}{v'} \quad (\text{i})$$

With lens B in position, I' acts as a virtual object for this lens forming an image at I .

This means that for lens B, the object distance is $-v'$ and the image distance is v . Thus using the lens formula, it follows that $\frac{1}{f_2} = \frac{1}{-v'} + \frac{1}{v}$ (ii)

Adding (i) and (ii) to eliminate v' , we have, $\frac{1}{f_1} + \frac{1}{f_2} = \frac{1}{u} + \frac{1}{v} - \frac{1}{v'} + \frac{1}{v}$

Hence $\frac{1}{f_1} + \frac{1}{f_2} = \frac{1}{u} + \frac{1}{v}$

Since I is the image of O by refraction through both lenses, then using the lens formula, $\frac{1}{u} + \frac{1}{v} = \frac{1}{f}$ where f is the focal length of the combination.

Thus $\frac{1}{f_1} + \frac{1}{f_2} = \frac{1}{F}$

Therefore, the expression for the focal length of the combined lenses is given by $\frac{1}{F} = \frac{1}{f_1} + \frac{1}{f_2}$

This formula applies to any two thin lenses in contact, such as two converging lenses, or a converging and diverging lens. When the formula is to be used, the sign convention must be applied.

Since the image formed by the first lens lies on the back side of the second lens, that image is treated as a virtual object for the second lens (that is, in the thin lens equation, P is negative). The same procedure can be extended to a system of three or more lenses. Because the magnification due to the second lens is performed on the magnified image due to the first lens, **the overall magnification of the image due to the combination of lenses is the product of the individual magnifications:**

$$M = m_1 \times m_2$$

Where m_1 is the Magnification of the first lens and m_2 the Magnification of second lens. This equation can be used for combinations of any optical elements such as a lens and a mirror. For more than two optical elements, the magnifications due to all elements are multiplied together.

Example

A thin converging lens of focal length 8cm is placed in contact with a diverging lens of focal length 12cm. Calculate the focal length of the combination.

$$f_1 = + 8\text{cm (Converging lens)}$$

$$f_2 = - 12 \text{ cm (Diverging lens)}$$

$$\text{From } \frac{1}{F} = \frac{1}{f_1} + \frac{1}{f_2}$$

$$\text{It implies that } \left(\frac{1}{F} = \frac{1}{8} - \frac{1}{12} \right) \text{cm}^{-1}$$

$$\text{It follows that } \frac{1}{F} = \left(\frac{3-2}{24} \right) \text{cm}^{-1}$$

Thus, $F = +24\text{cm}$

The positive sign shows that the combination of the two lenses acts like a converging lens.

Application activity 1.7

1. An object O is placed 12cm from a thin converging lens P of focal length 10cm and an image is formed on a screen S on the other side of the lens. A thin diverging lens, Q is now placed between the converging lens and S, 50cm from the converging lens. Find the position and nature of the final image if the focal length of the diverging lens is 15cm.
2. An object is placed 6.0cm from a thin converging lens A of focal length 5.0cm. Another thin converging lens B of focal length 15cm is placed co-axially with A and 20cm from it on the side way from the object. Find the position, nature and magnification of the final image.

Defects of lenses and their corrections



Activity 23

- (i) Place a white sheet of paper on a horizontal ground.
- (ii) Hold a glass ruler above the paper so as to focus rays from the sun on to the paper.
- (iii) Observe carefully the image formed on the sheet of paper.
- (iv) Repeat the above with the convex lens.

What have you observed?

Share the ideas about the observations.

Notice that the image has coloured patches. This defect where by an image formed has coloured patches is called chromatic aberration.

There are two kinds of defects; spherical aberration and chromatic aberration.

Spherical aberration

This arises in lenses of larger aperture when a wide beam of light incident on the lens, not all rays are brought to one focus. As a result, the image of the object becomes distorted. The defect is due to the fact that the focal length of the lens for rays far from the principal axis are less than for rays closer to a property of a spherical surface and as a result, they converge to a point closer to the lens.

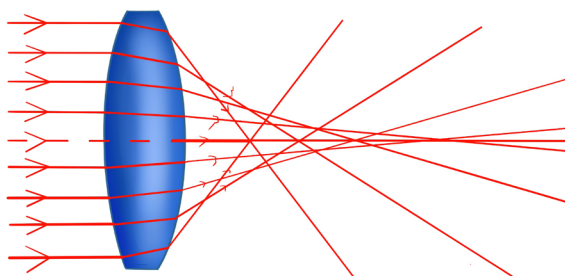

Figure 1.30: Spherical aberration

This defect can be minimised (reduced) by surrounding the lens with an aperture disc having a hole in the middle so that rays fall on the lens at a point closer to its principal axis. However, this reduces the brightness of the image since it reduces the amount of light energy passing through the lens.

Chromatic aberration

This occurs when white light from an object falls on a lens and splits it into its component colours. These colours separate and converge to different foci, and this results into an image with coloured edges.

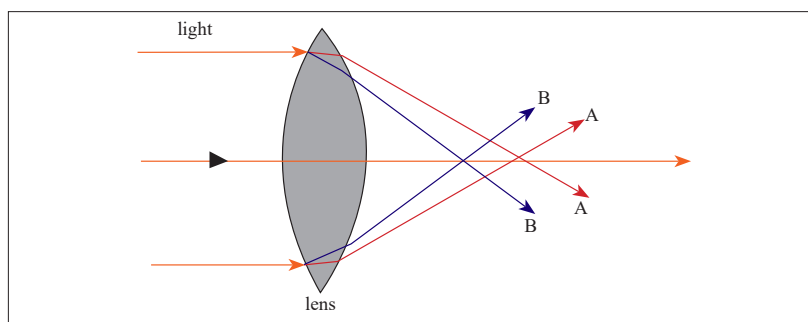

Figure 1.31: Chromatic aberration

The separation takes place because the material of a glass of a lens has different refractive indices for each colour. The colours travel at different speeds in

glass: red colour with the greatest and the violet with the least. As a result, violet is deviated most and red is the least deviated

Thus, a converging lens produces a series of coloured images of an extended white object as shown in the figure above (exaggerated for clarity).

Chromatic aberration can be minimised by using an achromatic lens called an achromatic doublet. This consists of a converging lens of crown glass combined with a diverging lens of flint glass cemented together with Canada balsam.

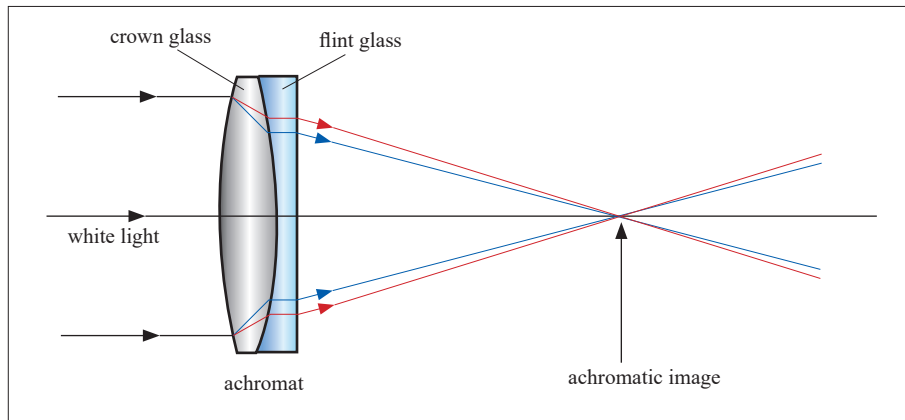

Figure 1.32: An Achromatic doublet

The flint glass of the diverging lens produces the same dispersion as the crown glass of the converging lens but in the opposite direction and the overall combination is converging. As a result, the achromatic combination converges the white light to one focus.

Coma aberration

Another type of aberration is coma, which derives its name from the comet-like appearance of the aberrated image. In general, a bundle of parallel rays passing through the lens at a fixed distance from the centre of the lens are focused to a ring-shaped image in the focal plane, known as a comatic circle.

The sum of all these circles results in a V-shaped or comet-like flare. As with spherical aberration, coma can be minimized by choosing the curvature of the two lens surfaces to match the application. Lenses in which both spherical aberration and coma are minimized are called best form lenses.

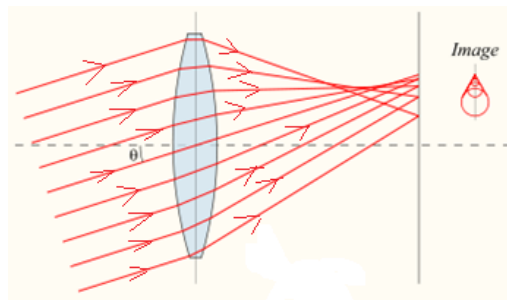

Fig.1. 31 Coma aberration

Activity 24



Discuss with your neighbour the applications of lens combinations in daily lives and write short notes in your notebook.

Refraction through prisms

Activity 25



Problem

Have you ever heard of a prism?
How does it look like?

Procedures

- a) Consider the shapes of the glasses provided below. Observe them clearly and identify the shape of a prism. Explain your reasoning in your notebook.

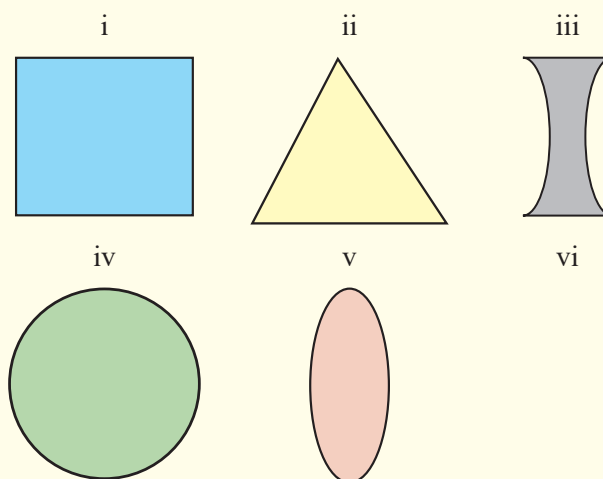

Figure 1.33: An Achromatic doublet

- b) With the help of a teacher, have different shapes of glasses. Touch, observe and identify the real shape of the prism.
- c) Examine the features of the one selected as a prism. Discuss them with your neighbour and write them in your notebook.

In optics, a prism is transparent material like glass or plastic that refracts light. Atleast two of the flat surfaces must have an angle less than 90° between them. The exact angle between the surfaces depends on the application.

Terms associated with refraction through prism



Activity 26

- (i) Place a glass prism on a white sheet of paper fixed on a soft board and mark its outline ABC.

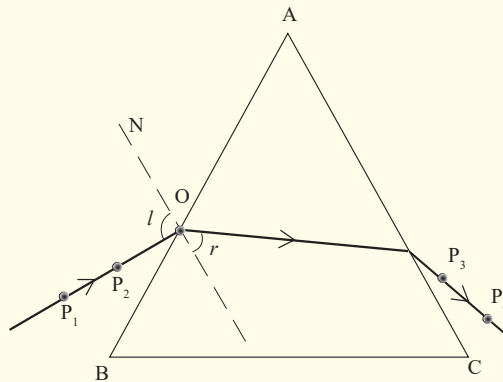

Figure 1.34: Investigating the path of a ray through a prism

- (ii) Remove the glass prism and measure an angle between two slanting faces of the prism.
- (iii) Draw a normal line ON, and draw a line making a given angle with the normal.
- (iv) Place the glass prism back in its outline and stick two pins, P_1 and P_2 in the paper along the line. While looking through the prism through face AC, stick pins P_3 and P_4 in the paper exactly in line with image, I_1 and I_2 of the pins, P_1 and P_2 .
- (v) Remove the prism and join points P_3 and P_4 .
- (vi) Join point O to the point where the line through P_3 and P_4 meets face AC.
- (vii) Discuss the observations through presentations.

1. What name can you give to the angle between the line passing through pins P_1 and P_2 and the normal ON ?
2. What do you think is the name of an angle between the normal ON and the line from the point where the line through P_3 and P_4 meets face AC ?
3. What is the name of the line that passes through P_3 and P_4 ?
4. What do you think is the name of an angle between the line passing through P_3 and P_4 and the normal to AC ?

Angle A : This is called refracting angle or angle of the prism. It is the angle between the inclined surfaces of the prism.

Angle i ; This is the angle of incidence on the first face of the prism.

Angle r_1 ; This is the angle of refraction on the first face of the prism.

Angle r_2 ; This is the angle of refraction on the second face of the prism.

Angle i_2 ; This is the angle of emergence from second face of the prism. Sometimes this is denoted by letter e .

General formulae for the prism

Activity 27



In groups of four, use geometry of the above drawn figure and derive the relation $r_1 + r_2 = A$.

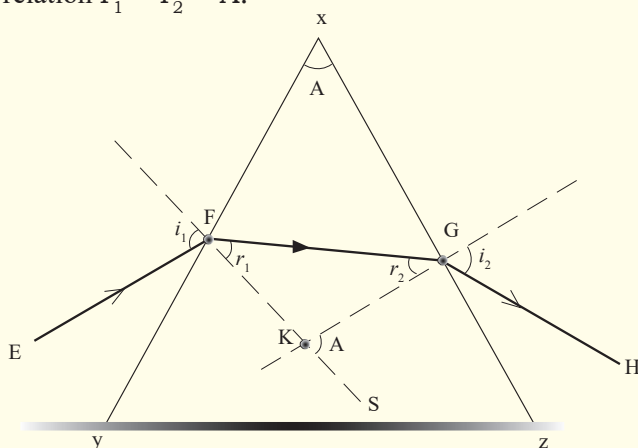

Figure 1.35: Refraction through prism

In the figure, EF is a ray incident on the refracting surface YX of the prism XYZ from air and then to air from surface XZ of the prism. KF and KG are normals at the points of incidence and emergence of the ray respectively.

Now, from the geometry of quadrilateral XFKG,

$$\angle XFK + \angle XGK = 180^\circ \text{ and}$$

$$A + \angle FKG = 180^\circ \dots\dots\dots(1)$$

But since FKS is a straight line,

$$\angle FKG + \angle GKS = 180^\circ \dots\dots\dots(2)$$

Comparing equation (1) and (2), it means that, $\angle GKS = A$.

Using $\triangle KFG$, $\angle GKS$ is an opposite exterior angle of r_1 and r_2

$$\text{Thus, } r_1 + r_2 = \angle GKS.$$

$$\text{Hence, } r_1 + r_2 = A$$

Note that given i_1, r_1 and i_2, r_2 as angles of incidence and refraction at F and G as shown and n is the prism refractive index, then Snell's law holds.

$$\text{That is; } \sin i_1 = n \sin r_1, \text{ and}$$

$$\sin i_2 = n \sin r_2$$

The position and shape of the third side of the prism does not affect the refraction under consideration and so is shown as an irregular in Fig.

Example

A ray of light falls from air to a prism of refracting angle 60° at an angle of 30° . Calculate the angle of emergence on the second face of the prism (Take refractive index of the material of glass, $n_g = 1.5$).

Solution

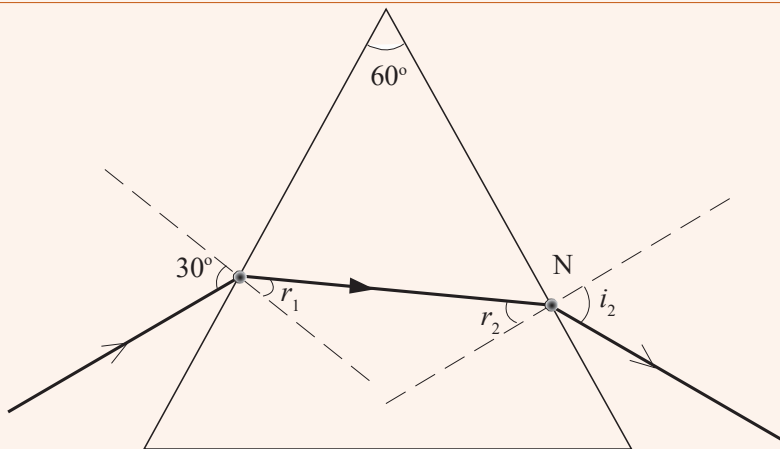

Figure 1.36: Ray through a prism

$$\text{Therefore } \sin r_1 = \frac{0.5}{1.5}$$

$$r_1 = \sin^{-1} \frac{0.5}{1.5}$$

$$\text{Hence, } r_1 = 19.5^\circ$$

$$\text{But } r_1 + r_2 = A$$

$$\text{It follows that } r_2 = 60^\circ - 19.5^\circ \\ = 40.5^\circ$$

$$\text{Now, on the second face, } n_g \sin r_2 = n_a \sin i_a$$

$$\text{Thus, } 1.5 \sin 40.5^\circ = \sin i_2$$

$$\text{So, } i_2 = \sin^{-1}(0.9747)$$

$$\text{Hence the angle of emergence} = 77^\circ$$

Example

A prism of refracting angle of 67° and index of refraction of 1.6 is immersed in a liquid of refractive index 1.2. If a ray travelling through a liquid makes an angle of incidence of 53° . Calculate the angle of emergence of the ray from the second face of prism.

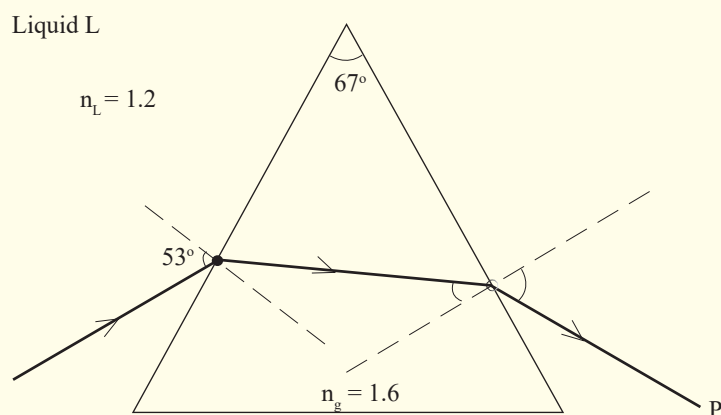

Figure 1.37: Example of a ray through a prism

Suppose that n_1 is the refractive index of the liquid

$$\text{From Snell's law } n_1 \sin i_1 = n_g \sin r_1$$

$$\text{Thus, } 1.2 \sin 53^\circ = 1.6 \sin r_1$$

$$r_1 = \sin^{-1}(0.5990)$$

$$\text{So, } r_1 = 36.8^\circ$$

$$\text{But } r_1 + r_2 = A$$

It follows that $r_2 = 67^\circ - 36.8^\circ$

Hence, $r_2 = 30.2^\circ$

Now

$n_g \sin r_2 = n_L \sin i_2$ (on the second face)

$$1.6 \sin 30.2 = 1.2 \sin i_2$$

$$i_2 = \sin^{-1}(0.6707)$$

Thus, $i_2 = 42^\circ$

The emergent ray makes an angle of 42° with the normal at the second face of the prism.

Example

A ray of light incident from air to a prism of refracting angle 60° grazes the boundary on the second face of the prism. Find the angle of incidence of the ray on the first face. (Take $n_g = 1.52$).

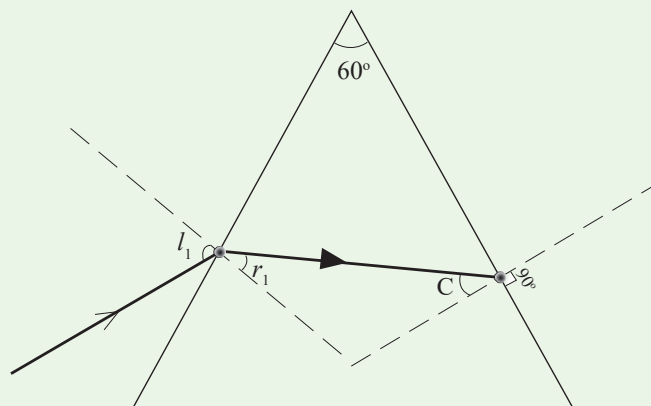

Figure 1.38: Diagram related to exercise

Solution

Since the ray grazes the boundary, $r_2 =$ critical angle C and $i_2 = 90^\circ$.

From Snell's law, $n_g \sin C = n_a \sin 90^\circ$ (on the second face)

But $n_a = 1$ and $\sin 90 = 1$

$$\text{Thus } \sin C = \frac{1}{1.52}$$

Hence $C = \sin^{-1} \frac{1}{1.52} C = 41.1^\circ$

Now

$$r_1 + C = A$$

Thus

$$\begin{aligned} r_1 &= 60^\circ - 41.1^\circ \\ &= 18.9^\circ \end{aligned}$$

On the first face, $n_a \sin i_1 = n_g \sin r_1$

Thus, $\sin i_1 = 1.52 \sin 18.9^\circ$

$$i_1 = \sin^{-1} (0.4924)$$

Hence, $i_1 = 29.5^\circ$

The angle of incidence on the first face = 29.5° .

Deviation of light by a prism

Activity 28



Have you ever heard of the word deviation?

List down in your notebook at least two ways in which light can be deviated.

Light can be deviated by reflection and refraction. Since a prism refracts light, it therefore changes its direction.



Activity 29

You are provided with a glass prism of refracting angle 60° , four optical pins, a white sheet of paper, a soft board and fixing pins.

- (i) Place a prism on a white sheet of paper and mark its outline ABC.

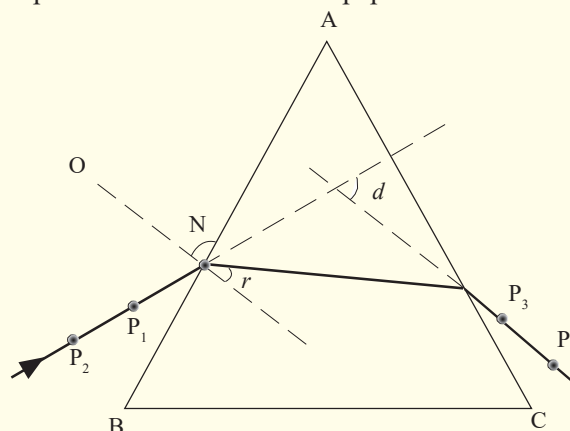

Figure 1.39: Diagram related to activity

- (ii) Remove the prism and draw a normal line ON to face AB and draw a line making an angle of 10° to ON to represent the incident ray.
- (iii) Place back the prism in its outline and fix pins P_1 and P_2 along the line.
- (iv) While looking through the other face AC of the prism, fix pins P_3 and P_4 so that they appear in line with images of P_1 and P_2 .
- (v) Remove the prism and draw a line through P_3 and P_4 on to face AC of the prism.
- (vi) Measure the angle of deviation d .

A prism deviates light on both faces. These deviations do not cancel out as in a parallel sided block where the emergent ray, although displaced, is parallel to the incident ray surface. The total deviation of a ray due to refraction at both faces of the prism is the sum of the deviation of the ray due to refraction at the first surface and its deviation at the second face.

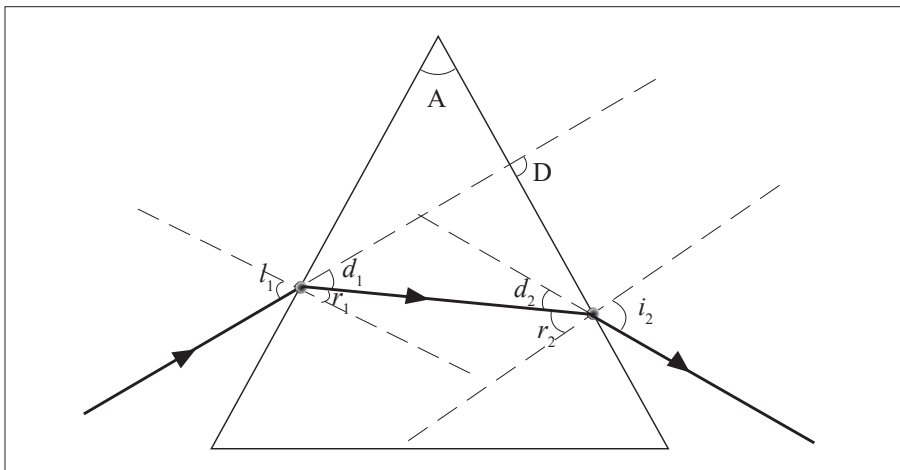

Figure 1.40: Diagram related to activity

Let d_1 and d_2 be angles of deviation at the first and second faces of the prism respectively.

$$\text{Total deviation } D = d_1 + d_2$$

Angle of deviation at the first face, $d_1 = i_1 - r_1$ and the angle of deviation at the second face, $d_2 = i_2 - r_2$

$$\begin{aligned} \text{Thus } D &= i_1 - r_1 + i_2 - r_2 \\ &= (i_1 + i_2) - (r_1 + r_2) \end{aligned}$$

But $r_1 + r_2 = A$

Therefore $D = (i_1 + i_2) - A$

Angle of minimum deviation and determination of refractive index n of a material of the prism

Activity 30



- (i) Place a prism on a white sheet of paper and mark its outline ABC.

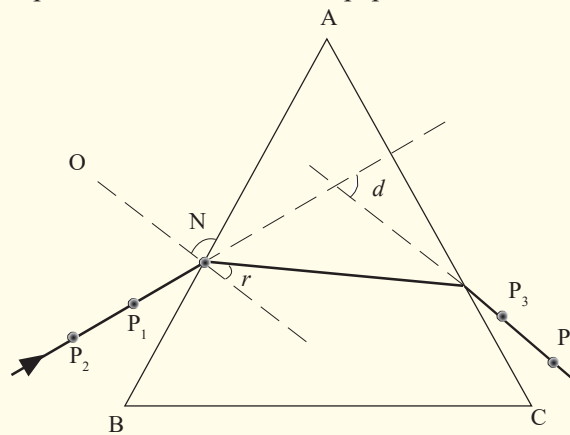

Figure 1.41: A prism on a sheet of paper

- (ii) Remove the prism and draw a normal line ON, and then several lines at different angles to ON to represent the incident rays.
- (iii) Place the prism back in its outline and fix pins P_1 and P_2 along one line.
- (iv) While looking through the other face AC of the prism, fix pins P_3 and P_4 in such a way that they appear in line with images of P_1 and P_2 .
- (v) Remove the prism, and draw a line through P_3 and P_4 .
- (vi) Measure angle of deviation d of the ray.
- (vii) Repeat the above procedures for other values of i .

(viii) Record your values in a suitable table.

$i/^\circ$	$d/^\circ$

(ix) Plot a graph of deviation d against angle of incidence.

The graph is a U-curve and its minimum value corresponds with the angle of minimum deviation. So D_{\min} can be read from the deviation axis. Experiment shows that as the angle of incidence i is increased from zero, the deviation begins to decrease continuously to some minimum value D_{\min} and then increases to a maximum as i is increased further to 90° .

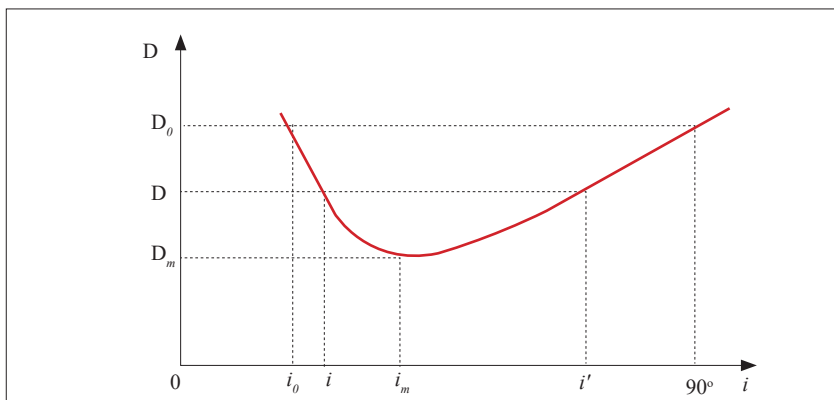

Figure 1.42: Curve of minimum deviation

From the variation fig 1.41 above, there is one angle of incidence which gives a minimum deviation. The experiment shows that this minimum deviation occurs when the angle of emergence is exactly equal to the angle of incidence and the two internal angles of refraction are equal. At this value, a ray passes symmetrically through the prism and the ray inside the prism is perpendicular to the directing plane, see figure 1.42.

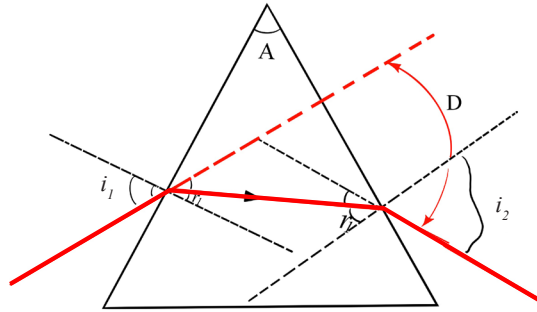

Figure 1.43: Minimum deviation

Since the angle of emergence $i_2 =$ angle of incidence i_1 , it follows that

$$i_1 = i_2 = i \text{ and } r_1 = r_2 = r$$

$$\text{From deviation } D = i_1 + i_2 - A$$

$$D_{\min} = i + i - A$$

$$D_{\min} = 2i - A$$

Angle of minimum deviation and the refractive index n of the material

Experimentally, it is shown that when the angle of incidence increases, the deviation decreases, passes at a maximum then increases. When the deviation is minimal, the angles of incidence and emergence are equal.

Considering the equation $A = r_1 + r_2$ we have: $r_1 = r_2 = r_m = \frac{A}{2}$, and also equations $\sin i_1 = n \sin r_1$ and $\sin i_2 = n \sin r_2$ become identical and give: $i_1 = i_2 = i_m$

This allows us to calculate for which incidence we have the minimum deviation. Finally the last equation gives the value of that deviation:

$$D_m = 2i_m - A$$

$$\text{From these relations, we deduce: } i_m = \frac{D_m + A}{2} \Rightarrow \sin \frac{D_m + A}{2} = n \sin \frac{A}{2}$$

Therefore The refractive index of material is:

$$n = \frac{\sin\left(\frac{D_{\min} + A}{2}\right)}{\sin\left(\frac{A}{2}\right)}$$

Example

A glass prism of refracting angle 60° has a refractive index of 1.5. Calculate the angle of minimum deviation for a parallel beam of light passing through it.

Solution

$$n = \frac{\sin\left(\frac{D_{\min} + A}{2}\right)}{\sin\left(\frac{A}{2}\right)}$$

$$\text{Thus, } 1.5 = \frac{\sin\left(\frac{D_{\min} + 60}{2}\right)}{\sin\left(\frac{60}{2}\right)}$$

$$\begin{aligned} \text{It follows that } D_{\min} &= 2 \sin^{-1}(0.75) - 60 \\ &= 97.2^\circ - 60^\circ \end{aligned}$$

$$\text{Hence, } D_{\min} = 37.2^\circ.$$

Application Activity 1.8

A glass prism of refracting angle 72° and index of refraction 1.66 is immersed in a liquid of refractive index 1.33. What is the angle of minimum deviation for a parallel beam of light passing through the prism?

Deviation of light by a small angle prism

Consider a ray incident almost normally in air in a prism of small refracting angle A (less than about 6° or 0.1 radian) so that the angle of incidence i is small.

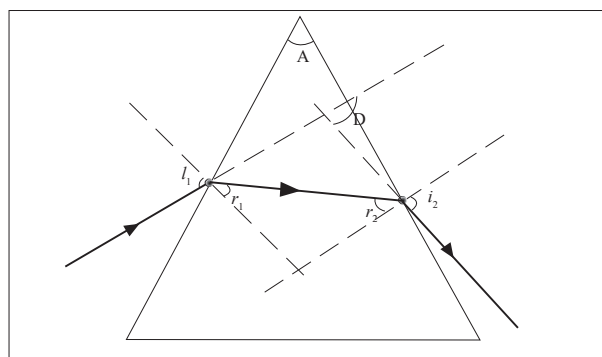

Figure 1.44: Small angle prism (Angles exaggerated for clarity)

Since i is small, r is also small. Now if n is the refractive index of the material of the prism, $n_a \sin i_1 = n \sin r_1$

For $n_a = 1$ (refractive index of air);

$$n = \frac{\sin i}{\sin r} \dots\dots\dots (1)$$

For small angles, the sine and tangent of an angle is nearly equal to the angle in radians. Thus $\sin i \approx i$ and $\sin r \approx r$

Therefore $\sin i_1 \approx i_1$ and $\sin r_1 \approx r_1$

Hence equation (1) becomes $i_1 = n r_1 \dots\dots\dots (2)$

Also $A = r_1 + r_2$, and so if A and r_1 are small, r_2 and i_2 will also be small.

From $n \sin r_2 = n_a \sin i_2$ and for $\sin i_2 \approx i_2$

It follows that $n r_2 = n_a i_2$

But $n_a = 1$

Thus $i_2 = n r_2 \dots\dots\dots (3)$

But the deviation D of a ray passing through any prism is given by

$$D = (i_1 - r_1) + (i_2 - r_2)$$

Substituting for i_1 and i_2

$$\begin{aligned} D &= nr_1 - r_1 + nr_2 - r_2 \\ &= (nr_1 + nr_2) - (r_1 + r_2) \\ &= n(r_1 + r_2) - (r_1 + r_2). \end{aligned}$$

But $A = r_1 + r_2$

So $D = An - A$

Factorising out A ,

$$\text{Hence } D = A(n - 1)$$

Thus the deviation D for a small angle prism is $D = A(n - 1)$

The expression $D = A(n - 1)$ shows that for a given angle A , all rays entering a small angle prism at small angles of incidence suffer the same deviation.

Example

Light is incident at a small angle on a thin prism of refracting angle 5° and refractive index 1.52 . Calculate the deviation of the light by the prism.

Solution

For small angle prism, $D = (n - 1)A$

$$n = 1.52 \text{ and } A = 5$$

$$\text{Thus } D = (1.52 - 1)5.$$

$$= 0.52 \times 5 = 2.6^\circ$$

Example

A mono chromatic light is incident on one refracting surface of a prism of refracting angle 60° , made of glass of refractive index 1.50 . Calculate the least angle of incidence for the ray to emerge through the second refracting surface.

Solution

The least angle is the angle of incidence for which there is grazing emergence at the second face of the prism.

$$\text{On the second face, } \sin 90 = n_g \sin C$$

$$\text{Thus } 1 = 1.5 \sin C$$

$$\text{Hence } C = \sin^{-1}\left(\frac{1}{1.5}\right) = 41.8^\circ$$

$$\text{Since } R + C = A$$

$$\text{It follows that } r = 60^\circ - 41.8^\circ = 18.2^\circ$$

$$\text{Now on the first face, } 1 \times \sin i = 1.5 \sin 18.5$$

$$i = \sin^{-1}(0.4685)$$

$$\text{Thus } i = 27.9^\circ$$

So the least angle of incidence for a ray to emerge on the second face of a 60° prism of refractive index 1.5 is 27.9° .

Determination of refractive index of a material of a prism

Activity 31



- (i) Place a glass prism on a white sheet of paper fixed on a soft board and mark its outline ABC.

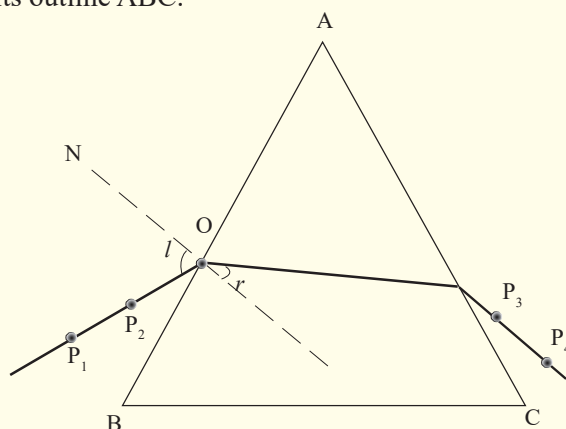

Figure 1.45: Diagram related to this activity

- (ii) Remove the glass prism and draw a normal line ON, and several lines at different angles to ON to represent incident rays.
- (iii) Place the glass prism back in its outline and stick two pins P_1 and P_2 in the paper along one of the lines drawn to represent an incident ray. While looking through the prism through face AC, stick pins P_3 and P_4 in the paper exactly in line with image, I_1 and I_2 of the pins, P_1 and P_2 .
- (iv) Remove the prism and join points P_3 and P_4 . This line represents the emergent ray.
- (v) Join point O to the point where the line through P_3 and P_4 meets face AC. This ray represents the refracted ray.

(vi) Measure angle of refraction, r .

(vii) Repeat the above procedures for other values of i .

(viii) Record your results in a table including values of $\sin i$ and $\sin r$.

i°	r°	$\sin i$	$\sin r$

(ix) Plot a graph of $\sin i$ against $\sin r$ and find the slope of the graph.

(x) Discuss through group presentation about the graph obtained.

The graph is a straight line graph and the gradient represents the mean value which is the refractive index of the material.

Dispersion of light by a prism



Activity 32

- (i) Place a plane mirror in a basin and then pour water into the basin.
- (ii) Leave the water to settle and slowly place the basin on sunshine so that the plane mirror reflects the light rays from the sun on a white wall or iron sheet.
- (iii) Observe what is formed on the wall(iron sheet).

Discuss with your group and write in your notebook about the observation.

Sunlight split into many colours when it fell into water. This process is called dispersion. Dispersion is the splitting of light into its component colours.



Activity 33

- (i) Place a prism in the centre of a piece of paper so that its refracting surface is directly facing the windows in order to receive light from the sun.
- (ii) Place a white screen on the far side of the prism so that the refracted rays hit it.
- (iii) Observe what is formed on the screen.
- (iv) In brief, write in your notebook the observation.

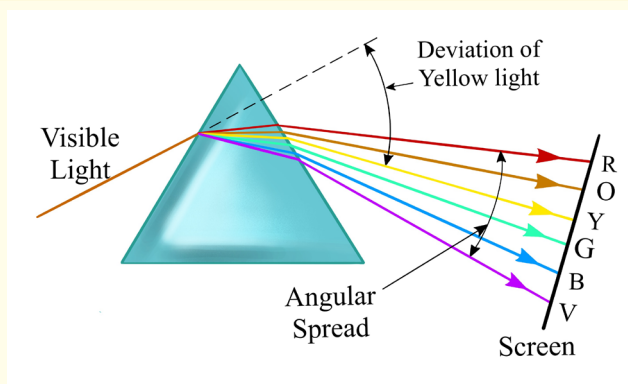

Figure 1.46: Dispersion of white light

A band of seven colours is formed on the screen. The colours are in order of Red, orange, yellow, green, blue, indigo and violet (ROYGBIV) which are colours of rainbow. This band of colours is called a spectrum. Thus, when a narrow beam of white light falls on a glass prism, it splits into a range of colours and these colours separate to form a spectrum, a process called dispersion. This occurs because white is not a single colour but mixture of all colours of the rainbow. The prism refracts each colour by a different amount because the colours travel at different speeds in the glass and thus the glass has different refractive indices for each colour. The speed of a red colour is greatest and that of a violet colour is the least, and so the refractive index of a material of the prism for red colour is the least and that of the violet colour is the greatest. Now it follows that since the angle of incidence in air is the same for all the colours, red is deviated least by the prism and the violet rays are the most deviated as shown in the figure above (exaggerated for clarity because the colours overlap).

Applications of total internal reflection of light by a prism

Activity 34



- (i) You are provided with a glass prism with angles measuring 45° - 45° - 90° .
- (ii) Place the prism on a sheet of paper and use a ray-box to shine in a ray of light as shown in the figure below.

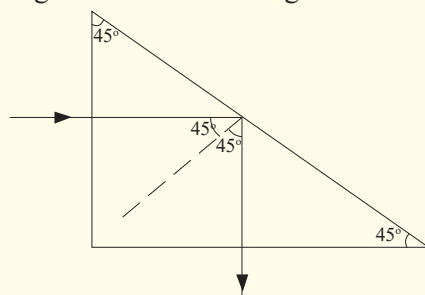

Figure 1.47: Refraction of light through a prism

- (iii) What do you notice about the phenomenon above?

Notice that light goes straight through the first surface and when it meets the second surface, it is internally reflected. So, the long side of the prism acts as a mirror and turns light through an angle of 90° . Two prisms of the same type

as above can be arranged in away and used in a periscope; an instrument used to see the top of an obstruction.

Use of prisms in periscopes



Activity 35

- (i) Arrange two prisms provided and shine on one of the prisms using a ray box as shown below.

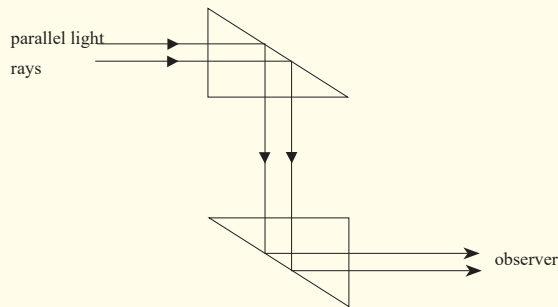

Figure 1.48: Refraction of light through a prism

- (ii) Discuss in your respective group about the phenomenon.

Light is turned through 90° at each prism and it emerges parallel to the incident light. In prism periscopes, light from an object is turned through 90° at each prism and reaches the observer at a different altitude to that of an object. So the image of the object is formed at another altitude but is same size as object.

Activity 36



- (i) Place the same prism above on a piece of paper and use your ray box to shine on it as shown below.

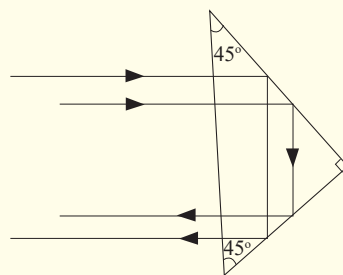

Figure 1.49: Diagram related to activity

- (ii) What do you notice?
You can see that rays of light are turned through 180° .

An arrangement of two prisms each turning light through an angle of 180° is used in prism binoculars; instruments used to view hidden objects. This will be discussed in the next unit.

Critical Thinking Exercise

- a) Give reasons why prism rather than plane mirrors are used in periscopes and prism binoculars.
- b) Explain why diamonds are cut with their sides flat and others slanting.

In periscopes and prism binoculars, plane mirrors can be used but prisms are preferred because of the following reasons.

In the first place, a prism allows light to undergo total internal reflection and thus the images are formed by total internal reflection where as a mirror allows light to both reflect and refract at its surface. So for a prism, all the light (100%) from the object is reflected but for a mirror some light is absorbed (about 95% is reflected) and thus a prism produces a brighter image than a mirror.

The silvering on the mirrors wears off with time but with prism no silvering is needed.

Some mirrors, for example, thick plate mirrors produce multiple images of one object because of reflections and refractions at the surfaces and inside the glass but a prism produces anyone image.

Diamonds are cut that way so as to make use of total internal reflection. The multiple reflections inside diamond make it bright.

END UNIT ASSESSMENT

1. An object of height $h = 7$ cm is placed a distance $p = 25$ cm in front of a thin converging lens of focal length $f = 35$ cm.
 - a) What is the height, location, and nature of the image?
 - b) Suppose that the object is moved to a new location a distance $p = 90$ cm in front of the lens. What now is the height, location, and nature of the image?
2. How far must an object be placed in front of a diverging lens of focal length 45 cm in order to ensure that the size of the image is fifteen times less than the size of the object? How far in front of the lens is the image located?

3. An object is placed (a) 20 cm, (b) 5 cm from a converging lens of focal length 15 cm. Find the nature, position and magnification of the image in each case.
4. Find the nature and position of the image of an object placed 10 cm from a diverging lens of focal length 15 cm.
5. A coin 3 cm in diameter is placed 24 cm from a converging lens whose focal length is 16 cm. Find the location, size, and nature of the image.
6. An object is placed 30.0 cm in front of a converging lens and then 12.5 cm in front of a diverging lens. Both lenses have a focal length of 10.0 cm. for both cases, find the image distance and describe the image.
7. A 4.00 cm tall light bulb is placed a distance of 45.7 cm from a double convex lens having a focal length of 15.2 cm. Determine the image distance and the image size.
8. A 4.00 cm tall light bulb is placed a distance of 8.30 cm from a double convex lens having a focal length of 15.2 cm. Determine the image distance and the image size.
9. A 4.00 cm tall light bulb is placed a distance of 35.5 cm from a diverging lens having a focal length of 12.2 cm. Determine the image distance and the image size.
10. A beam of parallel rays spreads out after passing through a thin diverging lens, as if the rays all came from a point 20.0 cm from the center of the lens. You want to use this lens to form an erect, virtual image that is the height of the object.
 - a) Where should the object be placed? Where will the image be?
 - b) Draw a principal ray diagram.
11. A ray of light incident at an angle i on a prism of angle, A , passes through it symmetrically. Write an expression for the deviation, d , of the ray in terms of i and A . Hence find the value of d , if the angle of the prism is 60° and the refractive index of the glass is 1.48.
12. A beam of monochromatic light is incident normally on the refracting surface of a 60° glass prism of refractive index 1.62. Calculate the deviation caused by the prism.
13.
 - a) Define the critical angle of a medium.
 - b) One side of a triangular glass prism put in a pool of water of refractive index $4/3$ and the other side was left open to air. A ray

of light from water was incident on the prism at an angle $i = 21.7^\circ$. The light just grazes as it emerges out of the prism. Given that the refractive index of glass 1.52, determine the refracting angle A of the prism.

14. A monochromatic light is incident at an angle of 45° on a glass prism of refracting angle 70° in air. The emergent ray grazes the boundary of the other refracting surface of the prism. Find the refractive index of the material of glass.
15. A prism of diamond has a refracting angle of 60° . A ray of yellow light is incident at an angle of 60° on one face. Find the angle of emergence if the refractive index of diamond for yellow light is 2.42.
16. A ray of light just undergoes total internal reflection at the second face of a prism of refracting angle 60° and refractive index 1.5. What is its angle of incidence on the first face?
17. A sharp image is located 78.0mm behind a 65.0mm-focal-length converging lens. Find the object distance (a) using a ray diagram, (b) by calculation.
18. What is (a) the position, and (b) the size of the image of a 7.6cm high flower placed 1.00m from a 50.0mm focal length camera lens?
19. An object is placed 10cm from a lens of 15m of focal length. Determine the image position.
20. Two converging lenses A and B, with focal lengths $f_A = 20\text{cm}$ and $f_B = -25\text{cm}$, are placed 80cm apart, as shown in the figure (1). An object is placed 60cm in front of the first lens as shown in figure (2). Determine (a) the position, and (b) the magnification, of the final image formed by the combination of the two lenses.

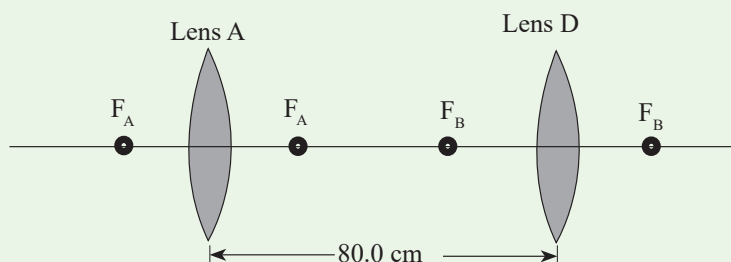

21. Where must a small insect be placed if a 25cm focal length diverging lens is to form a virtual image 20cm in front of the lens?
22. Where must a luminous object be placed so that a converging lens of focal length 20cm produces an image of size four times bigger than the object (Consider the case of a real image and the case of a virtual)

23. From a real object AB we want to obtain an inverted image four times bigger than the object. We place a screen 5m away the object. Specify the kind, the position and the focus of the lens to use. Give the graphical and the algebraic.
24. In cinematography the film is located at 30m from the screen and the image has a magnification of 100. Determine the focal length of the lens used in projection
25. An object AB of 1cm is placed at 8cm from a converging lens of focal length 12cm. Find its image (Position, nature and the size).
26. An object of 2cm is placed at 50cm from a diverging lens of focal length 10cm. Determine its image.
27. An object located 32.0 cm in front of a lens forms an image on a screen 8.00 cm behind the lens. (a) Find the focal length of the lens. (b) Determine the magnification. (c) Is the lens converging or diverging?
28. A movie star catches the reporter shooting pictures of her at home. She claims the reporter was trespassing. To prove her point, she gives as evidence the film she seized. Her 1.72m height is 8.25mm high on the film and the focal length of the camera lens was 210mm. How far away from the subject was the reporter standing?
29. A lighted candle is placed 33cm in front of a converging lens of focal length $f_1=15\text{cm}$, which in turn is 55cm in front of another converging lens of focal length $f_2=12\text{cm}$. (a) Draw a ray diagram and estimate the location and the relative size of the final image. (b) Calculate the position and relative size of the final image.

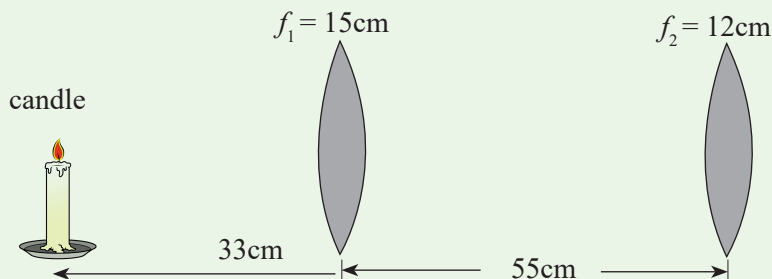

Figure 1.50

30. When an object is placed 60cm from a certain converging lens, it forms a real image. When the object is moved to 40cm from the lens, the image moves 10cm farther from the lens. Find the focal length of this lens.

Unit 2

Optical instruments

Key unit Competence

Describe and use optical instruments.

My goals

By the end of this unit, I will be able to:

- * explain an optical instrument.
- * explain the physical features of a human eye.
- * describe the image formation by the eye.
- * identify the physical features of a simple and compound microscope.
- * explain the applications of simple and compound microscopes.
- * differentiate between simple and compound microscopes.
- * explain the operation of a lens camera and its application.
- * explain the operation of a slide projector and its applications.
- * describe the physical features of a telescope.
- * list different types of telescopes.
- * demonstrate the operation of telescopes.
- * differentiate between telescopes and microscopes.
- * identify the physical features of prism binoculars.

INTRODUCTORY ACTIVITY

When a patient goes to hospital having a headache and fever, a doctor may require a blood test for malaria. When a sample of blood is taken, it is not possible to check whether a patient has malaria or not. But a laboratory technician may need to test the blood using some instrument and decide whether the patient has malaria or not.

Questions:

- (i) Which instrument do you think may be used to test malaria from blood sample?
- (ii) In summary, discuss how that instrument function.
- (iii) What other instrument do you think can be used for such purpose?

Introduction

Once the rules for predicting how rays travel through lenses have been discussed; a fantastic range of practical devices began to appear which aided the development of the modern world. The simple magnifying glass became the basis for telescopes, microscopes and spectacles. These devices were modified to improve the projection of images and with the discovery and development of light-sensitive chemicals, gave birth to modern photography and cinematography.

Definition of an optical instrument



Activity 2.1

In our daily activities and development, we observe different things in environment or in universe. Sometimes, some objects cannot be easily observed using our naked eyes. We need to see these very small things at big distance.

- (i) What do you think we use to observe those distant or very small bodies?
- (ii) Discuss the properties used by those instruments?
- (iii) Name at least four instruments that people use to observe distant or very small objects.

We use our eyes to see and view different objects. The eye cannot be used to view clearly these objects at night, and some distant objects or hidden objects. Objects which cannot be viewed by the eye can be focused using other instruments. All the instruments used to aid vision are called Optical instruments.

Man has always shown interest in observing things in a more detailed manner. In your early secondary, you looked at the uses of mirrors. We have also learnt in unit 1 of this book that lenses are used to focus objects. When the lenses or mirrors or both are arranged in a way, the arrangement can be used to observe objects in a more detailed manner. The arrangement makes what we call a compound optical instrument. The compound instruments include a compound microscope, telescopes, prism binoculars etc.

THE HUMAN EYE

The eye is a biological instrument used to see objects at different distances. It uses a convex lens system to form a small, inverted, real image of an object in front of it.

Structure of the eye

Activity 2



- (i) In groups of two, look at one another's eye.
- (ii) Observe critically its external shape.
- (iii) Observe it carefully and note its behaviour as one tries to see some objects in class.

Notice that the eye ball is round and fleshy.

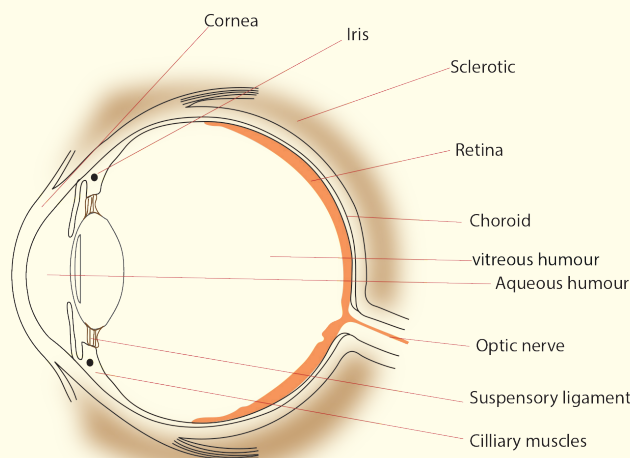

Figure 2.1: Anatomy of an eye

Functions of the parts of the eye

The cornea: It is made out of a fairly dense, jelly like material which provides protection for the eye, and seals in the aqueous humour. It also provides most of the power of the eye (59 Dioptres), having about 46 Dioptres. So it provides most of the bending of light rays.

The aqueous humour: This is a watery liquid that helps to keep the cornea in a rounded shape, similar to that of a lens.

The iris: This controls the amount of light entering the eye. The amount of light that enters the eye is one of the factors determining how focused an image is on the retina. The brighter the light the eye is exposed to, the smaller the iris' opening will be. The brighter the light the eye is exposed to, the smaller the iris' opening will be. The iris is the coloured part of the eye as seen from the outside. The iris opening or a gap through which light passes is called a pupil.

The lens: This is used to focus an image on the retina. It controls the bending of light rays by change of its shape, a process called accommodation, which is done by the ciliary muscles.

The ciliary muscles: These control the thickness of the lens during focusing. By contracting or squeezing the lens, they make it thicker and vice versa. Because the power of the lens is directly related to its thickness, the ciliary muscles change the power of the lens by their movement.

The retina: This is the light sensitive part of the eye and it is where images are formed. It contains millions of tiny cells which are sensitive to light. The cells send signals along the optic nerve to the brain. So the retina is the screen of the eye and the image is formed by successive refraction at the surfaces between air, the cornea, the aqueous humour, the lens and vitreous humour. The retina is black, which prevents any light rays that hit it from reflections and thereby changing the image.

The vitreous humour: This is a jelly like substance that helps the eye to keep its round shape. It is very close in optical density to the lens material.

The yellow spot: This is a small area on the retina where the sharpest image, that is, the finest detail can be seen.

The optic nerve: This is the nerve that transmits images received by the retina to the brain for interpretation. The part of the eye where the optic nerve joins the retina is called the **blind spot** because no images can be observed at this point.

Angular magnification or magnifying power of an optical instrument

Accommodation of the eye

Accommodation of the eye is the ability of the eye to see near and distant objects. The eye is capable of focusing objects at different distances by automatic adjustment of the thickness of the eye lens which is done by the ciliary muscles. To focus a distant object, the eye lens is made thinner, so less powerful, and the rays from the object are brought to focus on the retina by the eye lens. In this case, the ciliary muscles are relaxed and pull the lens. For nearer objects, the eye lens must be made thicker and hence more powerful so that the rays from the near object can be brought to a focus on the retina. In this case, the ciliary muscles tighten and squeeze the lens.

Near point and far point of the eye

Activity 5



- (i) Hold a book at an arm's length and move it closer to find the nearest distance that you can focus the words clearly without straining your eyes.
- (ii) Approximate the distance between your eyes and the book.
- (iii) What does this distance represent?

The near point of the eye is the nearest point that can be focused by the unaided eye. It is a closest distance that the 'normal' human eye can observe clearly; without any strain to the eye. It is called the least distance of distinct vision. The near point of a normal eye is 25 cm.

Activity 6



- (i) Look at the trees around your school.
- (ii) Now, try to look at objects far from the school.
- (iii) Are you able to focus the distant objects?
- (iv) Measure this distance from the object to your eye.
- (v) Write down your observation in the notebook.

Notice that you can not be able to measure this distance. The distance from a distant object to the eye is the far point of the eye. The far point of the eye is infinity. The far point is the farthest point that can be focused by the eye.

The distance of 25 cm from the eye is called distance of most distinct vision or least distance for distinct vision. The range of accommodation of the normal eye is thus from 25 cm to infinity. This range is based upon the average human eye which has an age of 40 years. Young persons have a much wider range but the average 70 year – old has a reduced range.

People with normal vision can focus both near and distant objects.

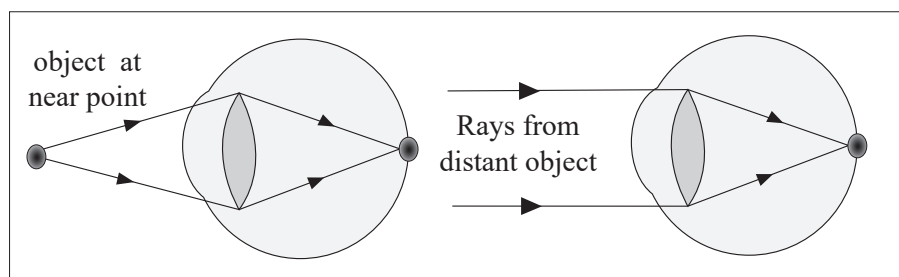

Figure 2.4: Near and far points of a normal eye

Defects of vision and their correction



Activity 7

- (i) Have you seen before some people putting on eye glasses?
- (ii) What do you think these glasses(spectacles) are used for.

People put on eye glasses for different reasons. Some people wear them in order to read a text, some put them on to see near objects if their eyes cannot be able to do so while others put them on so as to focus distant objects; others wear them for fun like sun goggles

Short-sightedness (myopia)



Activity 8

- (i) Hold a book at an arm's length and move the lens so that the prints are read without the eye getting strained.
- (ii) Now, try to read the words on a chalkboard a distance from the book.
- (iii) Are you able to focus both near and distant objects?

People with normal vision can focus clearly near and distant objects. Those who only focus near objects are said to be short-sighted, meaning that they see nearer.

Short-sightedness is the defect whereby a person can see near objects clearly but cannot focus distant objects. His far point is nearer than infinity. This is because the eyeball is too long or the lens is too strong so that rays of light from a distance object are focused in front of the retina.

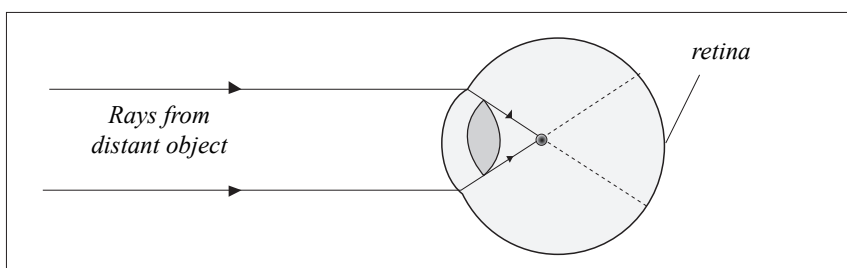

Figure 2.5: Short-sightedness

The rays are focused in front of the retina because the focal length of the eye lens is too short for the length of the eye ball. This defect can be corrected by wearing a concave (diverging) spectacle lens. The rays of light from a distant object are diverged so that they appear to come from a point near, and so they are focused by the eye.

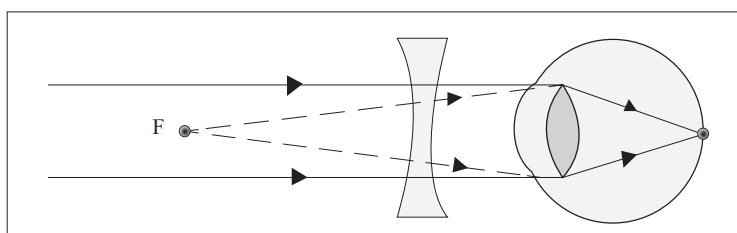

Figure 2.6: Correction of short sight

Rays from object at infinity appear to come from a near point F and converge to the retina.

Long-sightedness (hypermetropia)

This is where a person is able to see distant objects clearly but cannot focus near objects. This is because either his eye ball is too short or the eye lens is too weak (thin) so that rays of light from a close object are focused behind the retina. This eye's near point is further than 25 cm.

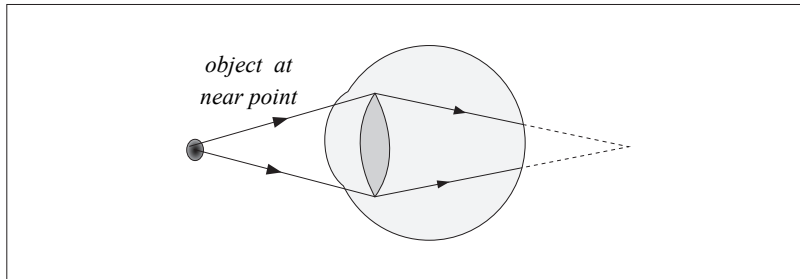

Figure 2.7: Long-sight

The image of the near object is focused behind the retina because the focal length of the eye lens is too long for the length of the eye ball. This defect can be corrected by wearing a convex lens spectacle. The rays of light from a near object are converged so that the rays appear to come from a point far, and so are focused by the eye.

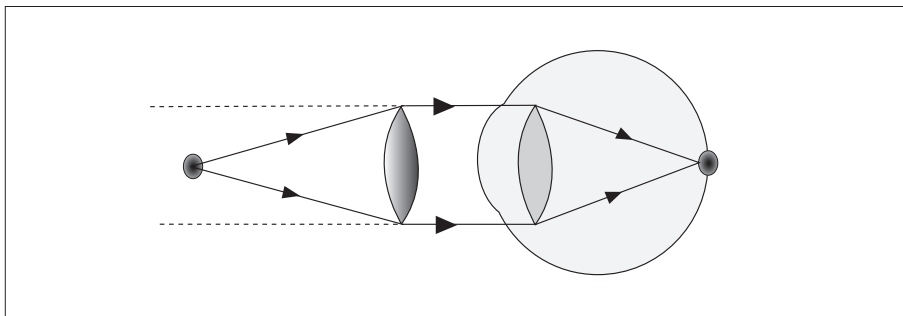

Figure 2.8: Correction of long sight

Rays from a near object O appear to come from a distant object.

Presbyopia

Activity 9



- (i) How many of you still have their grandparents?
- (ii) Have you ever tried to observe how grand parents observe objects?
- (iii) Discuss with your neighbour and write in your notebook results of your discussion.

When people grow older, their eye lens become stiff and it becomes hard for the ciliary muscles to adjust it. Such people have a defect called Presbyopia. Presbyopia is the stiffening of the eye lens such that it is less capable of being adjusted by the ciliary muscles. This means that the eye lens becomes less flexible and loses its power (ability) to accommodate for objects at different distances. This defect is corrected by wearing bifocals spectacles whose lenses have a top part for looking at distant objects and a bottom part for close ones. These bifocal spectacles have a diverging top part to correct for distant vision and converging lower part for reading.

Astigmatism

This is the defect that occurs if the curvature of the cornea varies in different directions so that rays in different planes from an object are focused in different positions by the eye and the image is distorted. A person suffering from astigmatism sees one set of lines more sharply than others. This defect is corrected by wearing corrected lenses. These help to bend the incoming rays to correct for irregular refraction.

Example

The far point of the defective eye is 1m. What lens is needed to correct this lens. With this lens, at what distance from the eye is its near point, if the near point is 25cm without the lens?

Solution

This far point is less than infinity, so the person is short sighted and he needs a diverging lens of $f = 1\text{m}$

This lens refracts the rays and appear to come from new near point

$u = \text{New near point}$

$v = -25\text{ cm}$ because the image is virtual in diverging lens $f = -1\text{m} = -100\text{cm}$

$$\text{From } \frac{1}{f} = \frac{1}{u} + \frac{1}{v}$$

$$\text{It follows that } \frac{-1}{100} = \frac{1}{u} + \frac{-1}{25}$$

$$\text{Thus } \frac{1}{u} = \left(\frac{1}{25} - \frac{1}{100} \right) \text{cm}^{-1}$$

Hence $u = 33.3\text{cm}$

This is the new near point distance.

Formation of an image by the eye

Light enters the eye through the transparent cornea, passes through the lens and is focused on the retina. The retina is sensitive to light and sends messages to the brain for interpretation. Although the image is inverted, the brain interpretes it correctly.

Visual Angle

Activity 3



- (i) Go outside class and view the trees around.
- (ii) Are the trees of the same height?

Notice that some trees at a distance, look shorter than the nearby trees when it is not the case? Why do you think it is so?

Discuss and write down in your notebook about your observation.

The height of an object depends on the angle of elevation of its top from the eye. The larger the angle, the taller the objects. This angle is called the visual angle.

The visual angle is the angle subtended at the eye by an object.

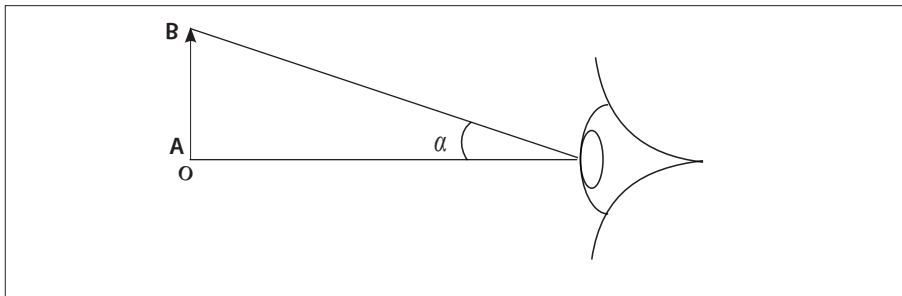

Figure 2.2: Visual Angle

Let us observe the flame of a candle: its two extremities A and B are seen by an eye at a certain angle. Expressed in radians, this angle has a measure: $\alpha = \frac{AB}{D}$

This angle decreases when the distance D increases and increases when the distance D decreases. It also increases when the length AB increases and decreases when AB decreases. We call it visual angle of the object.

Lead the learners to define the visual angle of an object as the angle between two rays of light from extremities of the object and penetrating into the eye of an observer.



Activity 4

- (i) In groups of four, explain why trees in a forest appear to be of the same size.

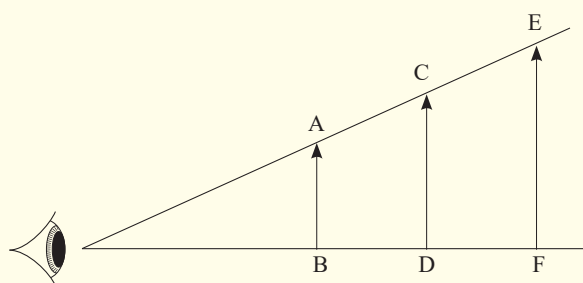

Figure 2.3: Visual Angle of trees

Objects that subtend the same angle at the eye appear to be of the same size as viewed by the eye.

The apparent size of an object depends on the size of its image on the retina. For example, the two objects above; AB and CD appear to have same size because they subtend the same angle θ at the eye. This explains why trees in a forest appear to have the same height. It is defined as the ratio of the apparent size of the final image i.e angle subtended by the image at the position of eye to the apparent size of the object i.e angle subtended by the object at the eye.

We have seen that we can use other instruments apart from the eye to aid vision. So, angular magnification or magnifying power of an optical instrument can also be defined as the ratio of the angle subtended at the eye by the image when the optical instrument is used to the angle subtended by the object at the unaided eye (when the instrument is not used). If β is the angle subtended at the eye by the image and α is the angle subtended by the object at some distance by unaided eye, then the angular magnification $M = \frac{\beta}{\alpha}$



Application activity 2.1

1. Name the part of the eye
 - a) which controls how much light enters it,
 - b) on which the image is formed,
 - c) which changes the focal length of the crystalline lens.
2. A farsighted person has a near point of 100 cm. Reading glasses must have what lens power so that this person can read a newspaper at distance of 25 cm? Assume the lens is very close to the eye.
3. A nearsighted eye has a near and far point of 12 cm and 17 cm, respectively.
 - a) What lens power is needed for this person to see distant objects clearly, and
 - b) What then will be the near point?
Assume that the lens is 2.0 cm from the eye (typical for eyeglasses).

A lens camera



Activity 10

- (i) Make a paper box and carefully use a pin to make a tiny hole in the centre of the bottom of the paper box.
- (ii) Place a piece of wax paper on the open end of the box. Hold the paper in place with the rubber band.
- (iii) Turn off the room lights. Point the end of the box with a hole in a bright window.
- (iv) Look at the image formed on the wax paper.

Which kind of image have you seen? Is it upside down or right side up. Is it smaller or larger than the actual object? What type of image is it?

The image is upside down. The pin hole helps you to see the image of the object. This device is called a pin hole camera.

Activity 11



- (i) When you were going to register for Rwanda National Examinations, you took some photographs.
- (ii) What device did the person that took your photograph use?



Figure 2.9: Taking a photo

In our daily lives, we take photographs. We use a lens camera to take these photographs.

Activity 12



- (i) Enlarge the hole in the pinhole camera above at the front of the box and hold convex lens over the hole.
- (ii) Adjust the position of the lens for either near or far objects to make a sharp image on the screen.
- (iii) Is the image erect or inverted? If the objects are coloured, is the image coloured?

Notice that the image formed is inverted and coloured if the object is coloured. By placing a lens above the hole, you are making a lens camera from a pin hole camera.

Formation of images by a lens camera



Activity 13

- (i) Draw a ray diagram for the formation of an image of an object placed at a point beyond $2F$ of a thin converging lens.
- (ii) State the nature and size of the image.
Is the image bigger or smaller?

We have already seen that when an object is beyond $2F$ of a thin converging lens, the image formed is smaller than the object.

A camera consists of a light-tight box with a convex (converging) lens at one end and the film at the other end. It uses the convex lens to form a small, inverted, real image on the film at the back.



Figure 2.10: The lens camera

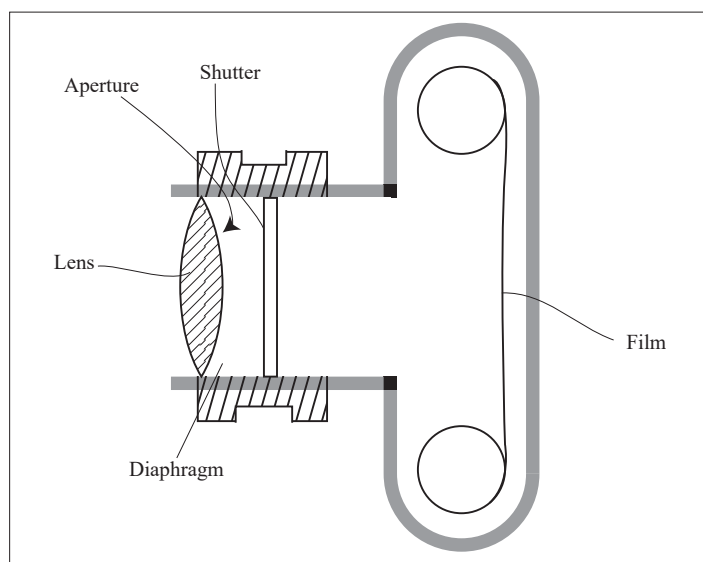

Figure 2.11: The lens camera

The lens focuses light from the object onto a light sensitive film. It is moved to and fro so that a sharp image is formed on the film. In many cameras, this happens automatically. In cheaper cameras, the lens is fixed and the photographer moves forwards and backwards to focus the object.

The diaphragm is a set of sliding plates between the lens and the film. It controls the aperture (diameter) of a hole through which light passes.

In bright light, a small aperture is used to cut down the amount of light reaching the film and in dim light, a large hole is needed. Very large apertures give blurred images because of aberrations so the aperture has to be reduced to obtain clear images.

In many cameras, the amount of light passing through the lens can be altered by an aperture control or stop of variable width. This size of the hole is marked in f – numbers i.e 1.4, 2, 2.8, 4, 5.6, 8, 11, 16, 22, 32. The smaller the f -number, the larger the aperture. An f -number of 4 means the diameter d of the aperture is $\frac{1}{4}$ the focal length, f of the lens. To widen the aperture, the f number should therefore be decreased.

The aperture also controls the depth of field of the lens camera. The depth of field is a range of distances in which the camera can focus objects simultaneously. This depth of field is increased by reducing the aperture.

This large depth of field ensures a large depth of focus. The depth of focus is the tiny distance the film plane can be moved to or from the lens without defocusing the image. A large depth of focus means that both near and far objects appear to be in focus at the same time which is obtained by a small hole in the diaphragm.

The shutter controls the exposure time of the film. It opens and closes quickly to let a small amount of light into the camera.

The exposure time affects the sharpness of the image. When the exposure time is short, the image is clear (sharp) but when it is long the image becomes blurred.

The film. This is where the image is formed. It is kept in darkness until the shutter is opened. It is coated with light sensitive chemicals which are changed by the different shades and colours in the image. When the film is processed, these changes are fixed and the developed film is used to print the photograph.

Note that a diminished image is always formed on the film and that the image of distant object is formed on a film at distance f from the lens. For near objects, the lens is moved further away from the film (closer to the object) to obtain a clear image. In this case, the film is at a distance greater than f of the lens. Digital cameras are similar to film cameras except that the light does not form an image on photographic film. The image in a digital camera is formed on a charge-coupled device (CCD).

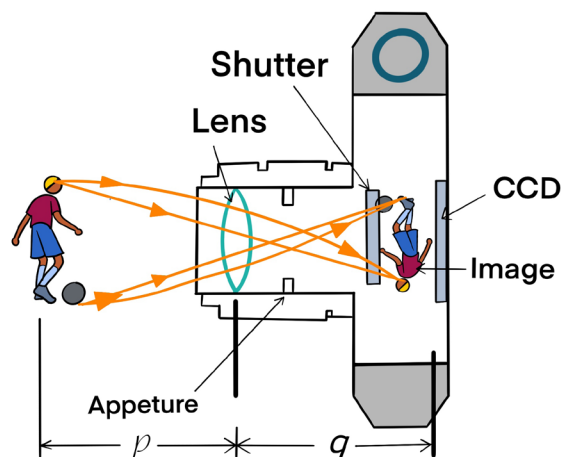

Figure 2.12: Cross-sectional view of a simple digital camera

The CCD is the light-sensitive component of the camera. In a nondigital

camera, the light from the lens falls onto photographic film. In reality, $p \gg q$. The intensity I of the light reaching the CCD is proportional to the area of the lens. Because this area is proportional to the square of the diameter D , it follows that I is also proportional to D^2 . Light intensity is a measure of the rate at which energy is received by the CCD per unit area of the image. Because the area of the image is proportional to q^2 and the intensity is also proportional to $1/f^2$ and therefore that $I \propto D^2/f^2$

The ratio f/D is called the f-number of a lens:

$$f - \text{number} = \frac{f}{D}$$

Hence, the intensity of light incident on the CCD varies according to the following proportionality:

$$I \propto \frac{1}{\left(\frac{f}{D}\right)^2} \propto \frac{1}{(f - \text{number})^2}$$

The f-number is often given as a description of the lens's "speed." The lower the f-number, the wider the aperture and the higher the rate at which energy from the light exposes the CCD; therefore, a lens with a low f-number is a "fast" lens.

Example

The lens of a digital camera has a focal length of 55 mm and a speed (an f-number) of $f/1.8$. The correct exposure time for this speed under certain conditions is known to be $\frac{1}{500}$ s.

- Determine the diameter of the lens.
- Calculate the correct exposure time if the f-number is changed to $f/4$ under the same lighting conditions.

Solution

- Remember that the f-number for a lens relates its focal length to its diameter.

$$f - \text{number} = \frac{f}{D} \text{ so}$$

$$D = \frac{f}{f - \text{number}} = \frac{55\text{mm}}{1.8} = 30.5\text{mm}$$

- b) The total light energy hitting the CCD is proportional to the product of the intensity and the exposure time. If I is the light intensity reaching the CCD, the energy per unit area received by the CCD in a time interval Δt is proportional to $I \times \Delta t$. Comparing the two situations, we require that $I_1 \times \Delta t_1 = I_2 \times \Delta t_2$ where t_1 is the correct exposure time for $f/1.8$ and t_2 is the correct exposure time for $f/4$.

$$I_1 \times \Delta t_1 = I_2 \times \Delta t_2$$

$$\frac{\Delta t_1}{(f_1 - \text{number})^2} = \frac{\Delta t_2}{(f_2 - \text{number})^2}$$

$$\Delta t_2 = \left(\frac{f_2 - \text{number}}{f_1 - \text{number}} \right)^2 \times \Delta t_1 = \left(\frac{4}{1.8} \right)^2 \times \left(\frac{1}{500} \text{s} \right) = 0.009 \text{ s}$$



Application activity 2.2

1. A camera gives a clear image of a distant landscape when the lens is 8 cm from the film. What adjustment is required to get a good photograph of a map placed 72 cm from the lens?
2. The lens of a certain 35 mm camera (where 35 mm is the width of the film strip) has a focal length of 55 mm and a speed (an f-number) of $f/1.8$. The correct exposure time for this speed under certain conditions is known to be $(1/500)$ s.
 - a) Determine the diameter of the lens.
 - b) Calculate the correct exposure time if the f-number is changed to $f/4$ under the same lighting conditions.

The slide projector

Activity 14



- (i) Have you ever seen an instrument called a slide projector?
- (ii) What is that instrument used for?
- (iii) Have you ever watched a cinema where the pictures are seen on the white wall?
- (iv) What device were they using to throw the pictures on the screen (wall or white cloth)?
- (v) Where do you think the pictures came from?
- (vi) Are the images small or large?

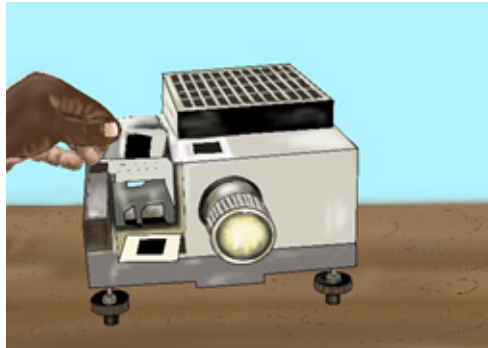

The pictures are thrown on the screen using a slide projector.

A projector is a device used to throw on a screen a magnified image of a film or a transparent slide. It produces a magnified real image of an object.

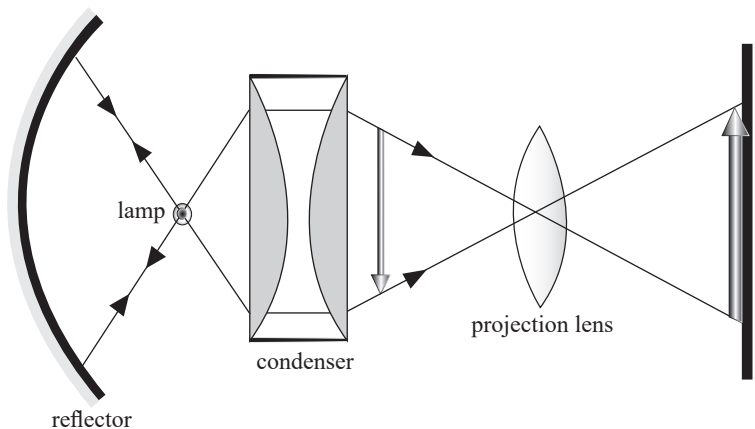

Figure 2.13: Projector

A slide projector is an opto-mechanical device for showing photographic slides. It consists of an illumination system and a projection lens. The illumination system consists of a lamp, concave reflector and the condenser. The illuminant is either a carbon electric arc or a quartz lamp to give a small but very high intensity source of light in order to make the image brighter.

The lamp is situated at the centre of curvature of the mirror so that the rays are reflected back along their original path. The concave mirror reflects back light which would otherwise be wasted at the back of the projector housing. The condenser consisting of two Plano concave lenses collects light which would otherwise spread out and be wasted, and concentrates it on to the film (slide) so that it is very bright and evenly illuminated.

The light is then scattered by the film and focused by a convex projection lens on to the film. The projection lens is mounted in the sliding tube so that it is moved to and fro to focus a sharp image on the screen.

Example

1. A slide projector has a converging lens of focal length 20.0cm and is used to magnify the area of a slide, 5cm^2 to an area of 0.8m^2 on a screen. Calculate the distance of the slide from the projector lens.

Solution

(Linear scale factor)² = Area scale factor

A linear scale factor is the linear magnification and area scale factor is the area magnification of an image.

$$\text{Area scale factor is given by } \frac{\text{Area of image}}{\text{Area of object}} = \frac{0.8}{0.0005} = 1600$$

$$\text{Linear scale factor} = \sqrt{\text{Area scale factor}}$$

$$\text{Linear scale factor} = \frac{v}{u}$$

$$\text{So, } \frac{v}{u} = \sqrt{1600} = 40$$

$$\text{Thus } v = 40u$$

$$\text{From the lens formula, } \frac{1}{f} + \frac{1}{u} + \frac{1}{v}$$

$$\frac{1}{u} + \frac{1}{40u} = \frac{1}{20}$$

$$\text{Therefore, } \frac{40 + 1}{40u} = \frac{1}{20}$$

$$\frac{41}{40u} = \frac{1}{20}$$

It follows that $40u = 820\text{cm}$

Hence, $u = 20.5\text{cm}$

Thus, the distance of the slide from the projector is 20.5cm.



Application activity 2.3

1. A colour slide has a picture area 2.4 cm x 3.6 cm. Find the focal length of the projection lens which will be needed to throw an image 1.2m x 1.8m on a screen 5m from the lens.
2. A projector projects an image of area 1 m² onto a screen placed 5m from the lens. If the area of the slide is 4 cm², calculate;
 - (i) The focal length of the projection lens.
 - (ii) The distance of the slide from the lens

Activity 15



Make a projector on the bench using a ray box lamp, a single convex lens (focal length about 5 cm) for the condenser; a slide; a convex lens (focal length 5cm or 10cm) as the projection lens and a sheet of paper for the screen.

Is the image inverted?

By how much is it magnified?

Note that if the film is placed just after the lamp, the object would be poorly illuminated. So to give a bright picture, a condenser is included. The film O is placed between F and 2F of the projection lens so that the image I is real, inverted and magnified. The film is put in the projector while it is upside down so that the picture on the screen is upright.

Microscope

Simple Microscope (Magnifying Glass)

Activity 16



- (i) Hold a hand lens at above the word Rwanda at a distance of about 4cm from the word.
- (ii) Move the lens farther away slowly from the word while observing the word through the lens.
- (iii) What changes do you notice after observing?
- (iv) Share ideas with your neighbour and write your observation in your notebook.



Figure 2.14: Children observing using a magnifying glass

The word Rwanda becomes larger and larger and finally disappears. This word gets larger because of the lens. We say that it is being magnified by the lens.



Activity 17

- (i) Place your hand on a table and hold a hand lens above it and do the same as in activity 16.
- (ii) What do you notice?



Figure 2.15: Magnifying glass

Notice that the hair (fur) and other small holes on the skin are seen clearly. These parts of the skin are made bigger by the glass lens and this enables one to see them clearly. This lens which magnifies images is called a magnifying glass or a simple microscope.

A magnifying glass consists of a thin converging lens and It is used to view very small organisms or parts of organisms which cannot be easily seen by the naked eye.

Formation of images by a magnifying glass

Activity 18



Using the knowledge from thin lenses, draw a ray diagram to show the formation of an image by a magnifying glass.
State the characteristics of the image formed.

We have already seen in unit 1 that when an object is between the lens and its principal focus, the image formed is magnified and upright. So, a magnifying glass forms a virtual, upright, magnified image of an object placed between the lens and its principal focus.

Activity 19



Making a simple microscope

- (i) Use a pin or a nail to make a hole about 2 mm in diameter in a piece of a kitchen foil or glass.
- (ii) Carefully let a drop of water fall on the hole so that it stays there and acts as a tiny lens with short focal length.
- (iii) Use it to observe prints on a piece of paper.

Simple microscope (magnifying glass) in normal adjustment.

The magnification of a magnifying glass depends upon where it is placed between the user's eye and the object being viewed and the total distance between them.



Activity 20

- (i) Carefully place a magnifying glass above some prints on a piece of paper and adjust it until they are seen clearly.
- (ii) Make sure that you don't feel any strain in the eye while you are observing.
- (iii) What do you think is the position of the image from the eye?

The image is at the least distance of vision since the eyes are not strained and the magnifying glass is said to be in normal adjustment.

A microscope is in normal adjustment if the final image is formed at the near point, and it is not in normal adjustment if the final image is at infinity.

Magnifying power of a simple microscope

We have already seen that the size of the image depends on the angle subtended by the object on the eye called the visual angle. Thus, the magnifying power depends on the visual angle.

It is defined as the ratio of the angle subtended by the image to the lens to the angle subtended by the object at the near point to the eye.

- a) Magnifying power of a simple microscope in normal adjustment

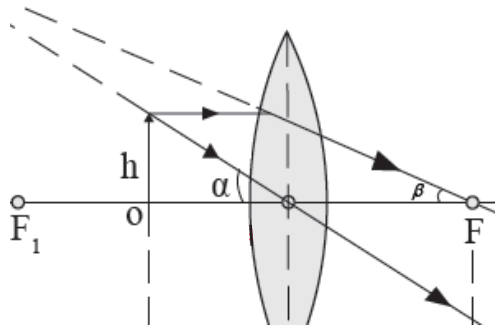

Figure 2.16: Image formed by a magnifying glass

Consider an object of height h placed at a given distance from the lens.
Let β be the angle subtended by the image I to the lens.

From the figure, $\tan \beta = \frac{h_1}{D}$

Assuming that rays are paraxial and that the eye is very close to the lens.

It implies that β is very small and $\tan \beta \approx \beta$.

$$\text{Thus } \beta = \frac{h_1}{D} \quad (1)$$

Now suppose that the object is viewed at the near point by the unaided eye and that it subtends an angle of α at the eye.

$$\text{Now } \tan \alpha = \frac{h}{D}$$

For α small, $\tan \alpha \approx \alpha$.

$$\text{Thus } \alpha = \frac{h}{D} \quad (2)$$

It follows that the magnifying power (angular magnification) M is given by

$$M = \frac{\beta}{\alpha} = \frac{\frac{h_1}{D}}{\frac{h}{D}} = \frac{h_1}{D} \times \frac{D}{h} = \frac{h_1}{h}$$

$$M = \frac{h_1}{h}$$

But $\frac{h_1}{h}$ = linear magnification produced by a lens or magnifying glass,

$$M = \frac{v}{f} - 1$$

Hence the magnifying power, $M = \frac{v}{f} - 1$

Since the image is at the near point (least distance of distinct vision), the image distance v is equal to $-D$, (negative for a virtual image).

$$M = \frac{-D}{f} - 1$$

This gives the maximum magnifying power of a simple microscope.

Note that in calculations, the value of the magnifying power is negative. The negative sign can always be neglected since magnification cannot be negative. The object distance can take any value in the range from the focal point to the point where it lies at the near point and if the object is at the focal point, then the object distance is equal to the focal length and the image is at infinity, and the microscope is not in normal adjustment.

- b) Magnifying power of a simple microscope when it is not in normal adjustment

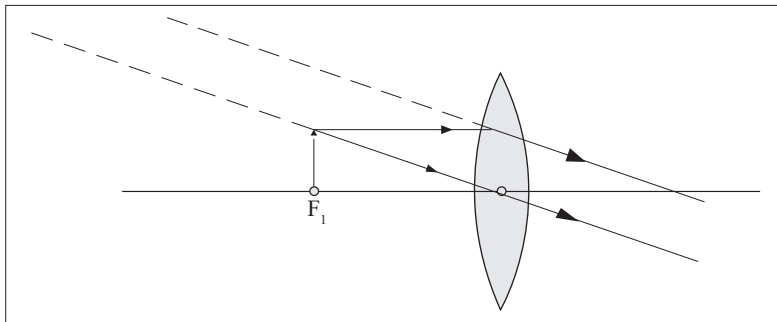

Figure 2.17: Angular magnification or magnifying power of an optical instrument

Angular magnification, $M = \frac{\beta}{\alpha}$

From the figure, $\tan \beta = \frac{h}{f}$

For α small, $\tan \beta \approx \beta$.

Thus, $\beta = \frac{h}{f}$

Diagram (not using a microscope)

From the figure, $\tan \alpha = \frac{h}{D}$

For α small, $\tan \alpha \approx \alpha$.

$$\text{Thus, } \alpha = \frac{h}{D}$$

It follows that, angular magnification, $M = \frac{\frac{h}{f}}{\frac{h}{D}}$

$$\text{Hence, } M = \frac{D}{f}$$

This is the minimum magnifying power of the simple microscope.

Note that, in this case, D is positive since it is of a real image from the eye, and from the formula, angular magnification is high for a lens of short focal length.

Example

A magnifying glass has a focal length of 5cm. Find the angular magnification and the position of an object if the image is formed at the position of least distinct vision of 25cm.

Solution

Since the image is formed at the position of least distinct vision, the magnifying glass is in normal adjustment. Thus, the image is virtual.

$$f = 5\text{cm}, D = 25\text{cm}$$

$$M = \frac{-D}{f} - 1$$

$$M = \frac{-25\text{cm}}{5\text{cm}} - 1 = -6$$

Thus, the maximum angular magnification is 6

But since angular magnification for a magnifying glass = linear magnification

As the image is formed at the least distance of distinct vision from the lens then: $v = -D$

$$\text{It follows that } -6 = \frac{v}{u} = \frac{-25}{u}$$

$$\text{Thus, } 6u = 25$$

$$\text{Hence } u = 4.2\text{cm}$$

Application activity 2.4

1. Find the angular magnification produced by a simple microscope of focal length 5cm when used not in normal adjustment.
2. Explain why angular magnification of a simple microscope is high for a lens of short local length.
3. Why the image formed by magnifying glass is free from chromatic abberation.

Activity 21



In groups of five, discuss why the image formed in a magnifying glass is almost free of chromatic abbreviation.

When an object is viewed through the magnifying glass, various coloured images corresponding to I_R , I_V for red and violet rays are formed but each image subtends the same angle at the eye close to the lens and therefore these colours overlap. The overlap of these colours makes a virtual image seen in a magnifying glass free of a chromatic abberation.



Group Activity 22

Provided a magnifying glass, go outside and pick different kinds of leaves. Examine, with the use of a magnifying glass, the structures of the leaves. Discuss in details the structural characteristics of each leaf



Group Activity 23

You are provided with dirty water in a glass container. Use the magnifying glass provided and view some living organisms in it. Record what you see.



Activity 24



Figure 2.18: Observing a tooth with a magnifying glass

- (i) Observe critically and describe the activity being done in the photograph.
- (ii) State other uses of a magnifying glass.

Uses of magnifying glass: Magnifying glasses have many different uses. Some people use it for fun activities such as starting fires, or use the lens to help them read. You can start a fire with a magnifying glass when the sun rays are concentrated on the lens. Some retail stores sell reading glasses with the double convex lens. In everyday life, magnifying glasses can be used to do a variety of things. The most common use for magnifying glasses would be how scientists use them, they use magnifying glasses to study tiny germs

The compound microscope

Activity 25



Have you ever heard or seen an instrument called a compound microscope?

What is it used for?



Figure 2.19: Different Rwandans using compound microscopes

The compound microscope is used to detect small objects; is probably the most well-known and well-used research tool in biology.

Activity 26



Observe the above pictures carefully and discuss places where a compound microscope is used in daily life.

In daily life, microscopes are used in hospitals, in biology laboratories, etc.



Activity 27

- (i) You are provided with two lenses of focal lengths 5cm and 10cm together with a half meter ruler and some plasticine.
- (ii) Arrange the lenses as shown in the figure below.

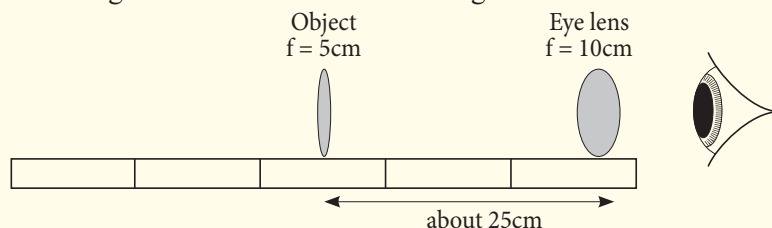

Figure 2.20: An arrangement of lenses

- (iii) Move the object to and fro until it appears in focus.

What do you notice about the image? Is it distorted? Is it coloured differently in any way?'

By arranging the lenses as above, you have actually made a compound microscope. We have already seen how a single lens (magnifying glass) can be used to magnify objects. However, to give a higher magnifying power, two lenses are needed. This arrangement of lenses makes a compound microscope. It produces a magnified inverted image of an object.

A compound microscope is used to view very small organisms that cannot be seen using our naked eyes for example micro organisms.



Figure 2.21: A compound microscope

A compound microscope consists of two convex lenses of short focal lengths referred to as the objective and the eye piece. The objective is nearest to the object and the eye piece is nearest to the eye of the observer. The object to be viewed is placed just outside the focal point (at a distance just greater than the focal length) of the objective lens. This objective lens forms a real, magnified, inverted image at a point inside the principal focus of the eye piece. This image acts as an object for the eye piece and it produces a magnified virtual image. So the viewer, looking through the eye piece sees a magnified virtual image of a picture formed by the objective i.e of the real image.

Image formation in a compound microscope

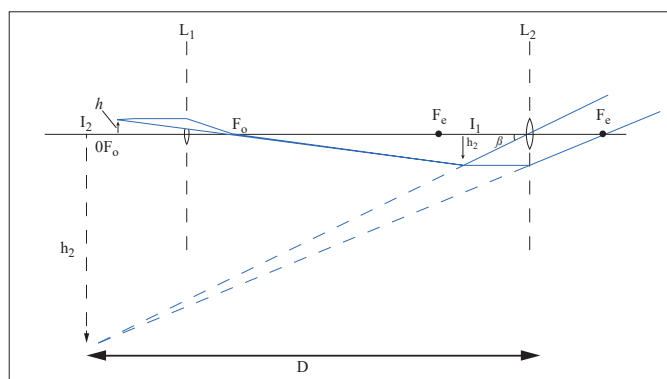

Figure 2.22: Images formed by a compound microscope

An objective lens L_1 forms a real magnified image I_1 of an object O just placed outside its principal focus F_0 . I_1 is formed just inside the principal focus F_e of the eye piece L_2 , which acts as a magnifying glass and produces a magnified, virtual image I_2 of I_1 .

Compound microscope in normal adjustment (normal use)



Activity 28

You are provided with a bird's feather; observe it critically using a compound microscope and draw it in a fine detail. Make sure you observe the features when your eyes are relaxed.

When the eyes are relaxed, the image is at the near point and the compound microscope is said to be in normal adjustment. The compound microscope is in normal adjustment when the final image is formed at the near point (least distance of distinct vision), D of the eye.

Angular magnification (magnifying power) of a compound microscope

The magnifying power of a compound microscope is the ratio of the angle subtended by the final image to the eye when the microscope is used to the angle subtended by the object the unaided eye.

Angular magnification of a compound microscope in normal use

We have already seen that when a microscope is in normal use, the image I_2 is formed at the least distance of distinct vision, D from the eye. Thus $v = D$.

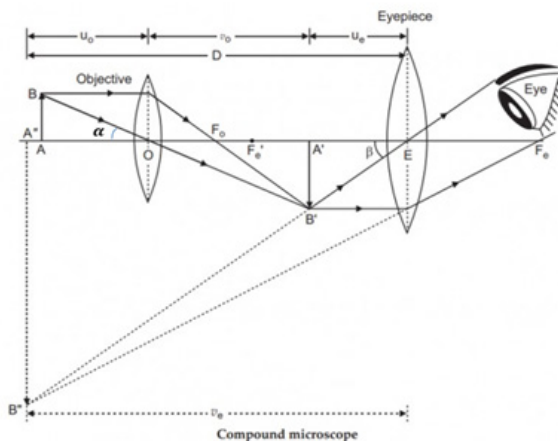

Figure 2.23: Images formed by a microscope in normal use

Consider an object of height h at a given distance slightly greater than the focal length of the objective lens.

Suppose that the final image has a height h_2 and is formed at a distance v from the eye piece and that it subtends an angle β to the eye. $M = \frac{\beta}{\alpha}$

From the figure, $\tan \beta = \frac{h_2}{D}$

Supposing that the eye is very close to the eye piece, β is very small and $\tan \beta \approx \beta$

Hence $\beta = \frac{h_2}{D}$

Now suppose that the object subtends an angle of α when placed at the near point, D , when viewed by a naked eye.

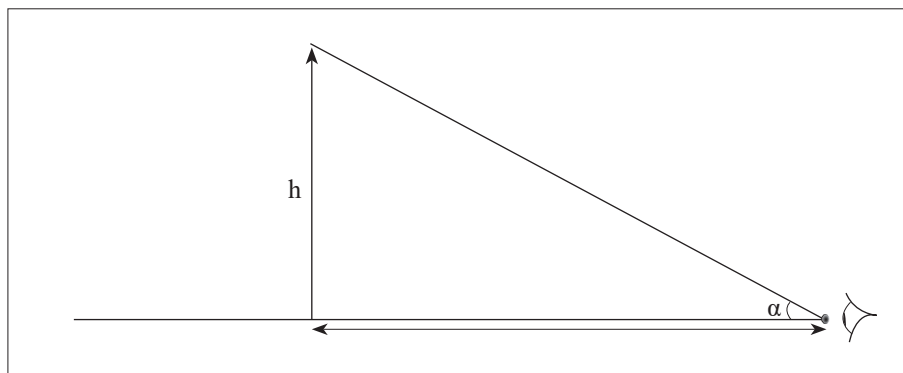

Figure 2.24: Object viewed by a naked eye

From the figure, $\tan \alpha = \frac{h}{D}$

For α small, $\tan \alpha \approx \alpha$

Thus $\alpha = \frac{h}{D}$

Hence, the angular magnification (magnifying power) is given by

$$M = \frac{\frac{h_2}{D}}{\frac{h}{D}} = \frac{h_2}{h}$$

Introducing the height of image due to the objective, h_1 . $M = \frac{h_2}{h_1} \times \frac{h_1}{h}$

But $\frac{h_1}{h_2}$ is linear magnification, m_e of image due to eyepiece and $\frac{h_1}{h}$ = linear magnification, m_o of image due to objective lens

It follows that $M =$ linear magnification due to eyepiece lens \times linear magnification due to objective

$$\text{Thus } M = m_e \times m_o$$

We have already seen that linear magnification is also given by $m = \frac{v}{f} - 1$, where v is the image distance from the lens and f is the focal length.

It follows that linear magnification due to the objective lens, $m_o = \frac{v_o}{f} - 1$, and that due to the eye piece, $m_e = \frac{v_e}{f} - 1$

$$\text{Therefore, } M = \left(\frac{v_e}{f_e} - 1 \right) \left(\frac{v_o}{f_o} - 1 \right)$$

But $v_e = -D$ (since the Image formed by the eye piece is virtual).

For the eye piece, $v = -D$ (since it's a virtual image)

$$\text{Hence } M = \left(1 + \frac{D}{f_e} \right) \left(1 + \frac{v_o}{f_o} \right)$$

From the above expression, it can therefore be seen that if f_o and f_e are small, M becomes large. So the angular magnification M can be made high if the focal lengths of the objective and eye piece are both small.

Angular magnification of a compound microscope when not in normal use:

We have already seen that when a microscope is not in normal adjustment, the final image is formed at infinity i.e $v = \infty$.

Suppose that an object of height h is at a given position from the objective lens, forming an image of height h_l .

$$\text{Angular magnification, } M = \frac{\beta}{\alpha}$$

$$\text{From the figure, } \tan \beta = \frac{h_l}{f_e}$$

$$\text{Suppose that the object is viewed using the naked eye, } \tan \alpha = \frac{h}{D}$$

For $v = -D$ very small, $\tan \beta \approx \beta$ and $\tan \alpha \approx \alpha$

$$\text{Thus } \beta = \frac{h_l}{f_e} \text{ and } \alpha = \frac{h}{D}$$

$$\begin{aligned} \text{Therefore, } M &= \frac{\frac{h_1}{f_c}}{\frac{h}{D}} = \frac{h_1}{f_e} \times \frac{D}{h} \\ &= \frac{h_1}{h} \times \frac{D}{f_e} \end{aligned}$$

But $\frac{h_1}{h}$ linear magnification of the objective lens given by $\frac{v_o}{f_o} - 1$

$$\text{Hence angular magnification } M = \frac{D}{f_e} \left(\frac{v_o}{f_o} - 1 \right)$$

Example

A compound microscope has an eye piece of focal length 2.50cm and an objective of focal length 1.60cm. If the distance between the objective and eye piece is 22.1cm, calculate the magnifying power produced when the final image is at infinity.

Solution

If the final image is at infinity, the objective forms an image at the focal point of the eye piece.

Let f_e be the focal length of the eye piece and f_o of the objective

The position of an image of l_o from $L_o =$ separation – focal length of eye piece v_e

$$= (22.1 - 2.50) \text{ cm}$$

$$v_e = 19.5 \text{ cm}$$

$$\text{Magnifying power } M = \frac{D}{f_e} \left(\frac{v_e}{f_o} - 1 \right)$$

But for a normal eye, $D = 25 \text{ cm}$

$$\text{Thus } M = \frac{25}{2.5} \left(\frac{19.5}{1.6} - 1 \right) = 111.8$$



Activity 29

Viewing specimens

The purpose of this exercise is to view micro organisms found in pond water while learning to operate a microscope.

Equipment

- * Microscope
- * Jar of pond water
- * Slide
- * Coverslip
- * Dropper

Procedure

1. Collect a jar of pond water containing micro organisms. To ensure that you capture the largest number of micro organisms, do not simply scoop a jar of water from the centre of a pond. Instead, fill the jar partway with pond water and then squeeze water into the container from water plants or pond scum.
2. Prepare a specimen of pond water.



- a) Using the dropper, place a few drops of pond water onto the centre of a clean, dry slide.



- b) Hold the side edges of the coverslip and place the bottom edge on the slide near the drop of pond water.



- c) Slowly lower the coverslip into place. The water should spread out beneath the coverslip without leaving any air bubbles. If air bubbles are present, you can press gently on the coverslip to move the air bubbles to the sides.

3. Set up the microscope.
 - a) Remove the dust cover from the microscope.
 - b) Plug in the microscope.
 - c) Turn on the microscope's light source.
4. View the specimen with the low-power objective. Move the slide around on the stage using your fingers or the control knobs until you find a micro organism.
5. View the micro organism with the high-power objective.
6. Sketch a picture of the micro organism.
7. Repeat steps 4, 5, and 6 until you have sketched atleast five different micro organisms.
8. Turn off the microscope.
 - a) Carefully, lower the objective to its lowest position by turning the coarse' adjustment knob.
 - b) Turn off the light source.
 - c) Remove your slide. Clean the slide and cover slip with water.
 - d) Unplug the microscope and store it under a dust cloth.

Application activity 2.5

A compound microscope consists of a $10\times$ eyepiece and $50\times$ objective 17.0 cm apart. Determine (a) the overall magnification, (b) the focal length of each lens, (c) the position of the object when the final image is in focus with the eye relaxed. Assume a normal eye, so $N = 25$ cm.

Telescopes



Activity 30

You have heard in your early secondary that there are some heavenly and distant earthly bodies that cannot be seen by our naked eyes. How did the people know that there exist such bodies?

Which instrument do you think is used to see these bodies and to observe what takes place on these bodies?

Why do you think it is difficult to see distant objects using our eyes?

Telescopes are instruments used to view distant objects such as stars and other heavenly bodies. Distant objects are difficult to see because light from them has spread out by the time it reaches the eyes, and since our eyes are too small to gather much light.

There are two kinds of telescopes; refracting telescopes and reflecting telescopes.

Refracting telescopes



Activity 31

- (i) Hold a convex lens of focal length 5cm close to your eye.
- (ii) Hold another lens of focal length 20cm at an arm's length.
- (iii) Use the lens combination to view distant objects.
- (iv) Adjust the distance of the farther lens until the image is clear (take care not to drop the lenses).

What type of image do you see?

The above lens combination is a refracting telescope. It is called a refracting telescope because it forms an image of the object by refracting light. Therefore, Refracting telescopes use lenses and they form images by refraction of light. Below are different kinds of refracting telescopes.

Astronomical telescope

The telescope made in the above activity is called an astronomical telescope. It consists of two convex lenses, the objective lens of long focal length and an eye piece lens of short focal length.

An astronomical telescope in normal adjustment

Using a telescope made in activity (30) above, view a distant object by moving the lenses so that the eyes are relaxed.

What do you think is the position of the image?

When the eyes are relaxed, the image is at infinity and the telescope is in normal adjustment. Therefore, an astronomical telescope is in normal adjustment when the final image is formed at infinity.

Activity 32



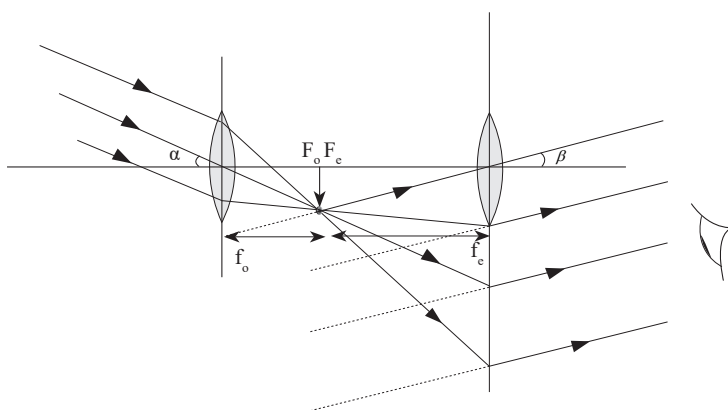

Figure 2.25: An astronomical telescope in normal adjustment

The rays of light coming from a distant object form a parallel beam of light. This parallel beam is focused by the objective lens and it forms a real, diminished image at its principal focus F_o . The eye piece is adjusted so that this image lies in its focal plane. This image acts as the object for the eye piece and the eye piece produces the image at infinity.

Note that in normal adjustment, the eye is relaxed or unaccommodated when viewing the image. In this case, the eye has minimum strain.

Magnifying power or angular magnification of an astronomical telescope

The magnifying power of a telescope is the ratio of the angle subtended by the image to the eye when the telescope is used to the angle subtended at the unaided eye by the object. Since the telescope length is very small compared with the distance of the object from either lens, the angle subtended at the unaided eye by the object is the same as that subtended at the objective by the object.

Angular magnification of an astronomical telescope in normal adjustment

In normal adjustment, the magnifying power (angular magnification) of an astronomical telescope is given by:

$$M = \frac{\text{angle subtended at the eye by the final image at infinity}}{\text{angle subtended at the objective by the object}}$$

Let β = angle subtended by the final image at the eye and α = angle subtended by the object at the objective

$$\text{Hence, } M = \frac{\beta}{\alpha}$$

Supposing that the eye is close to the eye piece and h_1 is the image of image I1 formed by the objective, then $\tan \alpha \approx \alpha$ and $\tan \beta \approx \beta$

$$\text{It follows that } M = \frac{\frac{h_1}{f_e}}{\frac{h_1}{f_0}} = \frac{h_1}{f_e} \times \frac{f_0}{h_1}$$

$$\text{Therefore, } M = \frac{f_0}{f_e}$$

Note

- (i) From the above expression, M is high when eye piece focal length f_e is short and the objective focal length f_0 is long. This explains the fact why the objective lens of long focal length and the eye piece lens of short focal length are used during the construction of the astronomical telescope.
- (ii) For a telescope in normal adjustment, the separation of the objective and the eye piece is $f_0 + f_e$

Activity 33



Discuss and give a summary of differences between a compound microscope and an astronomical telescope.

The table below shows the differences between a compound microscope and an astronomical telescope.

Compound microscope	Astronomical telescope
In normal adjustment, the final image is at near point.	The final image is at infinity
The objective lens has a short focal length.	The objective has a long focal length.
The object is near (it is used to view near and small objects)	The object is at infinity (used to see distant objects).
The distance between the objective lens and eye piece is greater than $f_0 + f_e$.	Distance between the objective and the eye piece is $f_0 + f_e$.

Example

An astronomical telescope has an objective lens of focal length 120 cm and an eye piece of focal length 5 cm. If the telescope is in normal adjustment, what is;

- (i) The angular magnification (magnifying power)
- (ii) The separation of the two lenses?

Solution

$$(i) \quad M = \frac{f_o}{f_e} = \frac{120}{5} = 24$$

$$(ii) \quad \text{Separation} = f_o + f_e = 120 + 5 = 125 \text{ cm}$$

Application activity 2.6

An astronomical telescope is used to view a scale that is 300 cm from the objective lens. The objective lens has a focal length of 20cm and the eye piece has a focal length of 2 cm. Calculate the angular magnification when the telescope is adjusted for minimum eye strain.

An astronomical telescope with the final image at the near point

In this case, the image is seen in detail but the telescope is not in normal adjustment (use) because the eyes are strained.

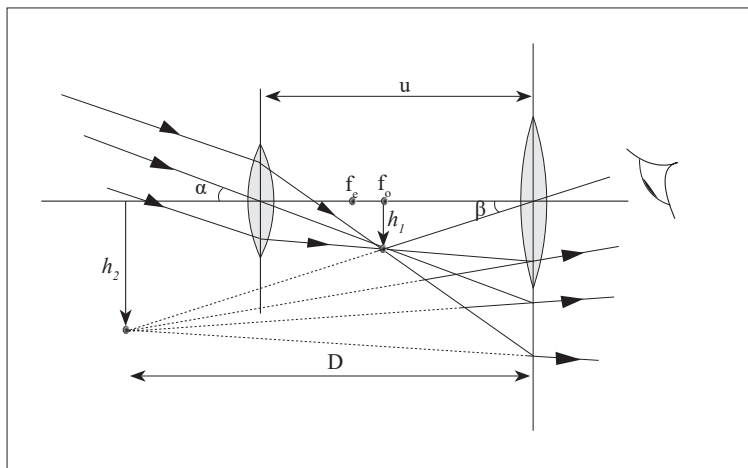

Figure 2.26: Image formed by an astronomical telescope

The objective forms an image of a distant object at its focus F_o . The eye piece is moved so that this image is at a position inside its focus. This image acts as

the object for the eye piece which acts as a magnifying glass and thus forms a magnified, virtual image.

Suppose that β is the angle subtended by the final image at the eye, and h_1 is the height of the image formed by the objective lens and that the angle subtended at the unaided eye is that subtended at the objective by the object, α

For the eye close to the eye piece

$$\tan \alpha \approx \alpha = \frac{h_1}{f_0} \quad \tan \beta \approx \beta = \frac{h_2}{D}$$

$$\text{Hence } M = \frac{\frac{h_2}{D}}{\frac{h_1}{f_0}}$$

$$\text{Thus } M = \frac{h_2}{D} \times \frac{f_0}{h_1} = \frac{f_0}{D} \left(\frac{h_2}{h_1} \right)$$

$$\text{But } \frac{h_2}{h_1} = \text{linear magnification due to the eye piece, } m_e = \frac{v_e}{f_e} - 1$$

It follows that

$$M = \frac{f_0}{D} \left(\frac{v_e}{f_e} - 1 \right) = \frac{f_0}{D} \left(\frac{D}{f_e} - 1 \right) = \frac{f_0}{D} \times \frac{D}{f_e} \left(1 - \frac{f_e}{D} \right) = \frac{f_0}{f_e} \left(1 - \frac{f_e}{D} \right)$$

Hence, it means that for an astronomical telescope with final image at near point, the magnifying power (Angular magnification is given by

$$M = \frac{f_0}{f_e} \left(1 - \frac{f_e}{D} \right)$$

As the final image is virtual, in calculation, D is negative, and note that separation of the lenses = $f_0 + u_e$.

The eye ring

The eye ring is the best position to place the eye in order to be able to view as much of the final image as possible. The best position for an observer to place the eye when using a microscope is where it gathers most light from that passing through the objective. In this case, the image is brightest and the field of view is greatest. In case of the telescope, all the light from a distant object must pass through the eye ring after leaving the telescope. So by placing the eye at the eye ring, the viewer is able to see the final image as much as possible.

Terrestrial telescope

An astronomical telescope produces an inverted image, so it is not suitable for viewing objects on the earth. It is suitable for viewing stars and other heavenly bodies. A terrestrial telescope provides an erect image and this makes it suitable to view objectives on the earth.

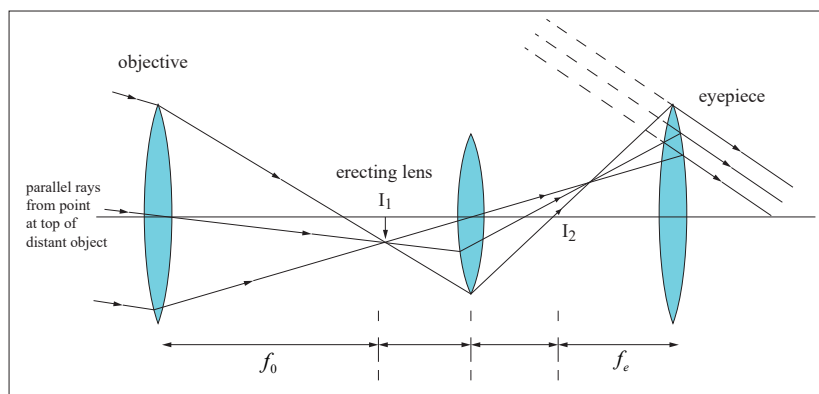

Figure 2.27: The terrestrial telescope

It consists of an erecting lens L of focal length f between the objective and the eye piece. The objective lens form an inverted image I_1 . The lens L is placed at a distance of $2f$ from the image I_1 . The image I_1 acts as the object and an erect image I_2 of the same size as I_1 is formed at $2f$ beyond the erecting lens. This image I_2 acts as an object for the eye piece and in the usual way the eye piece forms the final image at infinity.

Note that the angular magnification of the terrestrial telescope is similar to that of the astronomical telescope because the erecting lens has no effect on the angular magnification produced but only inverts the image I_1 so that the final image is upright.

Activity 34



Discuss the advantages and disadvantages of a terrestrial telescope over an astronomical telescope.

The advantage a terrestrial telescope has over an astronomical telescope is that it produces an upright image. However, the telescope is so long. It is much longer than other kinds of refracting telescopes. Its length is given by $= f_0 + f_e + 4f$.

The erecting lens also reduces the intensity of light emerging through the eye piece which makes the final image faint.

Galilean Telescope

Activity 35



- (i) Hold a concave lens of focal length 5cm close to your eye.
- (ii) Hold another convex lens of focal length 20cm at an arm's length.
- (iii) Use the lens combination to view distant objects.
- (iv) What is the nature of the image?

The above lens combination is a Galilean telescope. A Galilean telescope consists of an objective lens which is a convex lens of long focal length and an eye piece which is a concave lens of short focal length. It forms erect images both in normal and not in normal adjustment.

Galilean telescope in normal adjustment

The objective lens would produce an image I_1 in the absence of the eye piece. With the eye piece in position at the distance f_e from I_1 , I_1 acts as a virtual object to the eye piece and a virtual image of it is formed at infinity since I_1 is at the focal point of the eye piece.

Angular magnification for a Galilean telescope in normal adjustment

Let h_1 be the height of image, l_1 , β be angle subtended at the eye and α be the angle subtended at the unaided eye by the object which is very nearly equal to the angle subtended by the object at the objective lens.

$$\text{Angular magnification} = \frac{\alpha}{\beta}$$

For the eye very close to the telescope,

$$\tan \alpha = \frac{h_1}{f_0} \quad \text{and} \quad \tan \beta \approx \beta = \frac{h_1}{f_e}$$

Therefore, angular magnification M is given by: $M = \frac{f_0}{f_e}$

Hence $M = \frac{f_0}{f_e}$, this is similar to that of the astronomical telescope.

Galilean telescope with final image at near point

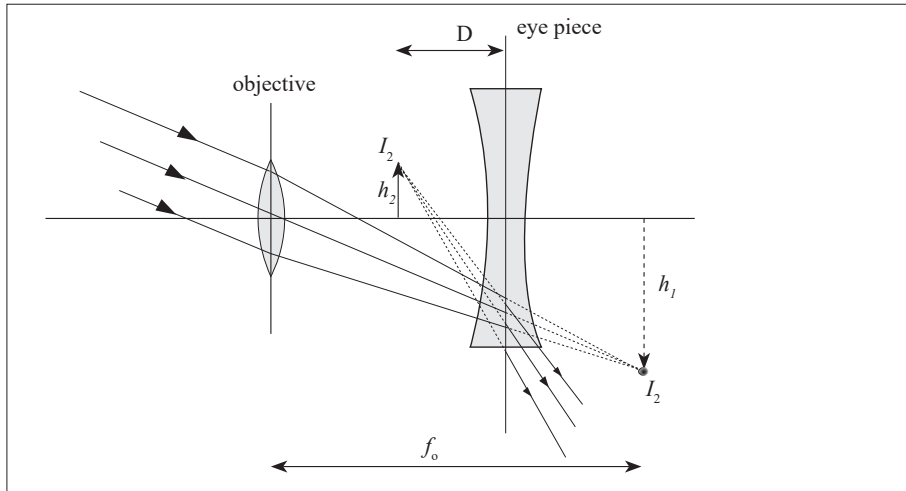

Figure 2.28: The Galilean telescope

The final image in a Galilean telescope can also be viewed at the near point of the eye when the telescope is not in normal adjustment.

The final image in a Galilean telescope can also be viewed at the near point of the eye when the telescope is not in normal adjustment.

The objective lens forms the image I_1 at a distance greater than the focal length of the eye piece. This image acts as a virtual object for the eye piece and an erect image of it is formed at a distance D . Thus $v = -D$ (since the image is virtual).

Angular magnification is thus given by $M = \frac{\beta}{\alpha}$

From the fig; $\tan \beta = \frac{h_2}{D}$ and $\tan \alpha = \frac{h_1}{f_0}$ where h_1 is the height of image I_1 and h_2 is the height of image I_2

From $M = \frac{\beta}{\alpha}$, it follows that $M = \frac{\frac{h_2}{D}}{\frac{h_1}{f_0}} \times \frac{h_2}{D} \times \frac{f_0}{h_1} = \frac{f_0}{D} \times \frac{h_2}{h_1}$

But $\frac{h_2}{h_1} = m_e =$ linear magnification due to the eyepiece

It follows that $M = \frac{f_0}{D} \times m_e$

But $m_e = \frac{v_e}{f_e} - 1$

$$\text{Thus, } M = \frac{f_0}{D} \left(\frac{v_e}{f_e} - 1 \right)$$

$$\text{Therefore, } M = \frac{f_0}{D} \times \frac{D}{f_e} \left(1 - \frac{f_e}{D} \right)$$

$$\text{But } v_e = -D$$

$$\text{Hence } M = \frac{f_0}{f_e} \left(1 - \frac{f_e}{D} \right)$$

Activity 36



Discuss the advantages and disadvantages of a Galilean telescope over an astronomical telescope and write them in your notebook.

Unlike in an astronomical telescope where the final image is inverted, the final image formed in a Galilean telescope is erect. The telescope is also shorter than an astronomical telescope and hence portable. The distance between the lenses is given by $f_0 - f_e$.

On the other hand, a Galilean telescope has a small field of view and its eye ring is virtual (since the eye piece is concave) that is, it is between the lenses and so inaccessible to the eye.

Reflecting telescopes



Activity 37

Take the case of a TV satellite dish in the neighborhood. Discuss and explain the functioning and principle of a satellite dish.

Reflecting telescopes consist of a large concave mirror of long focal length as their objective. There are three kinds of reflector telescopes, all named after their inventors.

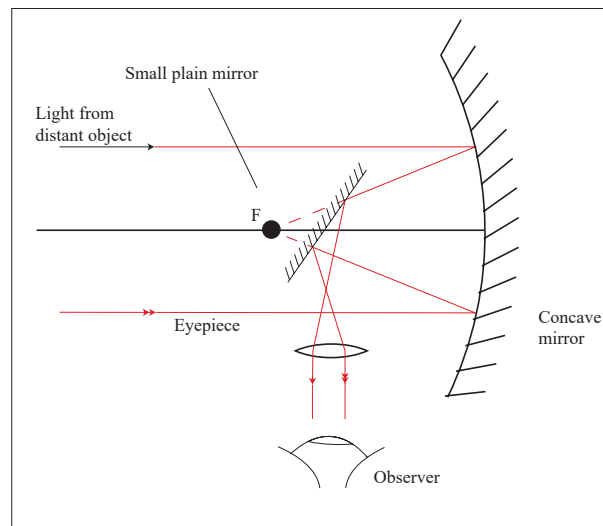

Figure 2.29: The Newtonian reflecting telescope

The Newtonian telescope is commonly used by amateur astronomers. A small plane mirror is used to direct the light from the concave mirror, which acts as an objective into an eye piece. Rays from a distant object are reflected by the objective (concave mirror) to the plane mirror. This reflects the rays to form a real image I_1 which can be magnified by an eye piece or photographed by putting a film at I_1 .

Note that the plane mirror deflects the rays of light side ways without changing the effective focal length f_0 of the objective.

In normal adjustment, the angular magnification of the Newtonian reflection telescope is given by $M = \frac{f_0}{f_e}$

Cassegrain reflecting telescope

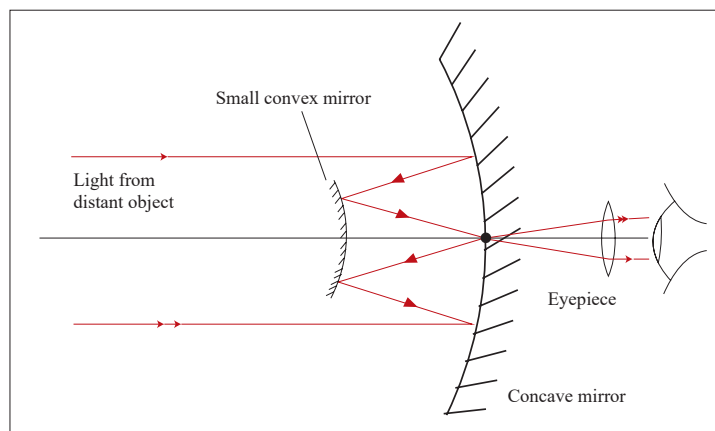

Figure 2.30: The cassegrain reflecting telescope

This is the type used in most observatories. It consists of a concave mirror which acts as an objective, a small convex mirror and the eye piece lens. Light from a distant object is reflected by the concave mirror to the convex mirror which reflects it back to the centre of the concave mirror where there is a small hole to allow the light through. So the convex mirror forms the final image (real) at the pole of the objective.

Coude Reflector Telescope

This is a combination of Newtonian and cassegrain reflector telescopes.

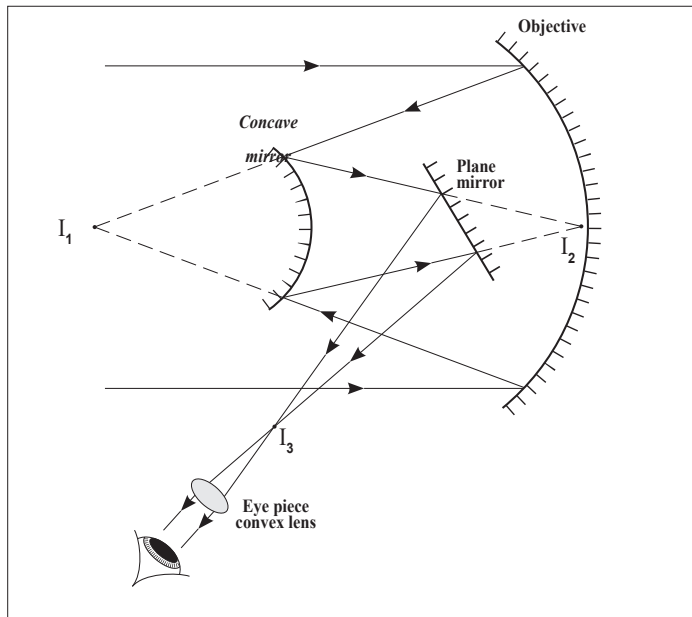

Figure 2.31: The reflecting telescope

The plane and convex mirrors used in reflecting telescopes are used to bring the light to a more convenient focus where the image can be photographed and magnified several times by the eye piece for observation.



Activity 38

Discuss and explain the advantages of reflecting telescopes over refracting telescopes.

The reflecting telescopes are free from chromatic aberration since no refraction occurs. The image formed is brighter than in refracting telescopes where there is some loss of light during refraction at the lens surfaces.

Spherical aberration can be eliminated by using a parabolic mirror instead of a spherical mirror as an objective. They have a power because of higher ability to distinguish two closely related objects because of the large diameter of the parabolic mirror. We say that they have a high resolving power. They are easier to construct since only one surface requires to be grounded.

Critical Thinking Exercise

What is meant by the resolving power of an optical instrument? Explain its usefulness.

Explain why astronomers use reflecting telescopes rather than refracting telescopes?

Prism binoculars

Activity 39



Have you ever asked yourself how tourists and scientists are able to see distant animals and birds in a forest or any hidden places?

Discuss with your neighbour and write in your notebook the observation.

Tourists and scientists use prism binoculars to view wild animals and birds in hidden places such as caves and forests.

These consist of a pair of refracting astronomical telescopes with two totally reflecting prisms between each objective and eyepiece. The prisms use total internal reflection to invert rays of light so that the final image is seen the correct way. These prisms reflect up and down the light and by doing so, they shorten the length of the instrument.

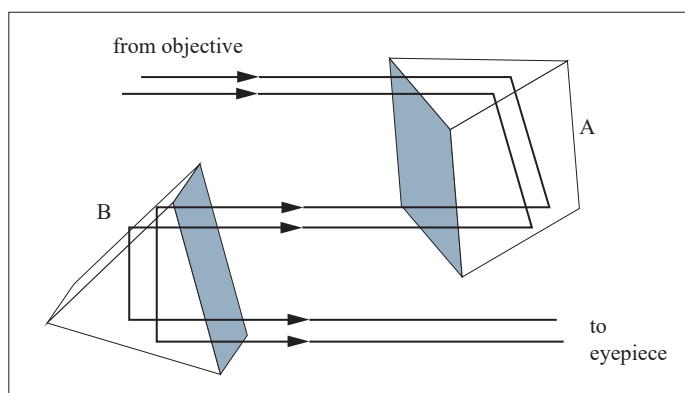

Figure 2.32: Arrangement in prism binoculars

Prism A causes lateral inversion and prism B inverts vertically so that the final image is the same way round and same way up as the object. Each prism reflects light through 180° . This makes the effective length of each telescope three times shorter than the distance between the objective and the eye piece. So good magnifying power is obtained with compactness.

END UNIT ASSESSMENT

1. A certain nearsighted person cannot see distinctly objects beyond 80 cm from the eye. What is the power in diopters of the spectacle lenses that that will enable him to see distant objects clearly?
2. Explain the difference between the terms magnifying power and magnification, as used about optical systems. Illustrate this, by calculating both, in the case of an object placed 5.0 cm from a simple magnifying glass of focal length 6.0 cm, assuming that the minimum distance of distinct vision for the observer is 25 cm.
3. An eyepiece is made of two positive thin lenses, each of focal length $f = 20$ mm, separated by a distance of 16 mm.
 - (a) Where must a small object viewed by the eyepiece be placed so that the eye receives parallel light from the eyepiece?
 - (b) Does the eye see an erect image relative to the object? Is it magnified?
 - (c) Use a ray-trace diagram to answer these questions by inspection.
4. A common telephoto lens for a 35 mm camera has a focal length of 200 mm; its range from to (a) What is the corresponding range of aperture diameters? (b) What is the corresponding range of image intensities on the film?
5. What is the maximum stop rating of a camera lens having a focal length of and a diameter of ? If the correct exposure at , what exposure is needed when the diaphragm setting is changed to ?

Unit 3

Moments and Equilibrium of Bodies

Key Unit Competence

Analyse the principle of moments and equilibrium of bodies. .

My goals

By the end of this unit, I should be able to:

- * Explain the principle of moments and apply it to equilibrium of a body.
- * Come out with the effects of forces when applied onto a body.
- * Know the effects of forces.

INTRODUCTORY ACTIVITY

When a patient goes to hospital having a headache and fever, a doctor may require a blood test for malaria. When a sample of blood is taken, it is not possible to check whether a patient has malaria or not. But a laboratory technician may need to test the blood using some instrument and decide whether the patient has malaria or not.

Questions:

- Which instrument do you think may be used to test malaria from blood sample?
- In summary, discuss how that instrument function.
- What other instrument do you think can be used for such purpose?

Introduction

In here, we shall majorly concentrate on the turning effect of force. As you know, it is very hard to close a door when you apply force near its turning point. That's why door handles are always put at the end of the door so that the distance from the turning point to where force is applied increases. This increases the turning effect of the force applied. Which is the effect of forces on bodies one of our interest in this unit.

Scalar and vector quantities



Activity 1

Try to stand bricks in a line behind one another. Push one brick.

- (i) What happens to other bricks?
- (ii) What if in the process one brick stops, what would happen?

In daily life, we normally pull the objects from one place to another. When pulling a goat that is to be tethered, obviously it will take the direction of the pull. We can call this a force. **This is a quantity that changes body's state of rest or uniform motion.**

You noticed that after pushing your friend he/she changed position and direction. Hence, a force has both magnitude and direction. This quantity can be termed as a **vector quantity**. This is a quantity with both magnitude and direction.



Activity 2

- (i) Using the above example, discuss in groups or as a class other vector Quantities.
- (ii) Analyse the effects of these physical quantities.
- (iii) In daily life, how are these quantities utilised?
- (iv) Ask your friend what time is it?

You will realise that he/she will tell the exact time not even indicating direction. Such a quantity is termed to be a **scalar quantity**.

A scalar quantity is a physical quantity that is defined by only magnitude (size).

Other examples of scalar quantities are **volume, mass, speed, and time intervals**. The rules of ordinary arithmetic are used to manipulate scalar quantities.

Application activity 3.1

Of the following physical quantities, group them in different sets of scalar and vector quantities: mass, energy, power, weight, acceleration, velocity, momentum, time, impulse, magnetic flux density, pressure, displacement.

Force as vector

Activity 3



1. As an individual or a group push the desk.
2. What happens to it?
3. What causes the change in position?
 - a) Let as a class move to:
 - (i) Football pitch.
 - (ii) Net ball pitch.
 - (iii) Basket ball play ground.

Try to kick a ball. What happens to it? What causes it to change its position?

Note what you observe.

Also, as you sit reading this book, you eventually feel tired. This is because of gravitational force acting on your body and yet you remain stationary.

From the above examples, we can define the “quantity force”. We have to know the direction and the magnitude. For that matter, we conclude that the force is vector quantity. We can think of force as that which causes an object to accelerate.

What happens when several forces act simultaneously on an object? In this case, the object accelerates only if the net force acting on it is not equal to zero. The net force acting on an object is defined as the vector sum of all forces acting on the object. (We sometimes refer to the net force as the total force, the resultant force, or the unbalanced force.)

Application activity 3.2

1. is an example of a scalar quantity
 - a) Velocity.
 - b) Force.
 - c) Volume.
 - d) Acceleration.
2. is an example of a vector quantity
 - a) Mass.
 - b) Force.
 - c) Volume.
 - d) Density.
3. A scalar quantity:
 - a) always has mass.
 - b) is a quantity that is completely specified by its magnitude.
 - c) shows direction.
 - d) does not have units.
4. A vector quantity
 - a) can be a dimensionless quantity.
 - b) specifies only magnitude.
 - c) specifies only direction.
 - d) specifies both a magnitude and a direction.
5. A boy pushes against the wall with 50 kilogrammes of force. The wall does not move. The resultant force is:
 - a) -50 kilogrammes.
 - b) 100 kilogrammes.
 - c) 0 kilogrammes.
 - d) -75 kilogrammes.
6. A man walks 3 miles north then turns right and walks 4 miles east. The resultant displacement is:
 - a) 1 kilometre SW
 - b) 7 kilometres NE
 - c) 5 kilometres NE
 - d) 5 kilometres E
7. A plane flying 500km/hr due north has a tail wind of 45 mi/hr the resultant velocity is:
 - a) 545 kilometres/hour due south.
 - b) 455 kilometres/hour north.
 - c) 545 kilometres/hour due north.
 - d) 455 kilometres/hour due south.
8. The difference between speed and velocity is:
 - a) Speed has no units.

- b) Speed shows only magnitude, while velocity represents both magnitude (strength) and direction.
 - c) They use different units to represent their magnitude.
 - d) Velocity has a higher magnitude.
9. The resultant magnitude of two vectors
- a) Is always positive.
 - b) Can never be zero.
 - c) Can never be negative.
 - d) Is usually zero.
10. Which of the following is not true.
- a) Velocity can be negative.
 - b) Velocity is a vector.
 - c) Speed is a scalar.
 - d) Speed can be negative.

Table summarising Scalar and vector Quantities

Scalars	Vectors
Speed	Velocity
Temperature	Acceleration
Distance	Displacement
Area	Force/Weight
Entropy	Momentum
Volume	Drag

Turning effect of force

Moment of a force about a point

Every time we open a door, turn on a tap or tighten up a nut with a spanner, we exert a turning force. The combined effect of the force and distance which determines the magnitude of the turning force is called the **moment of the force or torque** and is defined as follows:

“The **moment** (turning effect) of a force about a point is the force multiplied by the perpendicular distance from the place where the force is applied to that point.” Fig. a

$$M = Fr_{\perp} = Fr \sin \theta$$

Or **Moment** is force times lever arm where r is the lever arm, and the perpendicular symbol (\perp) reminds us that we must use the distance from the

axis of rotation that is perpendicular to the line of action of the force (Fig.3.1 a). The SI unit for moment is N m.

A **lever arm or moment arm** is the perpendicular distance from the axis of rotation to a line drawn along the direction of the force.

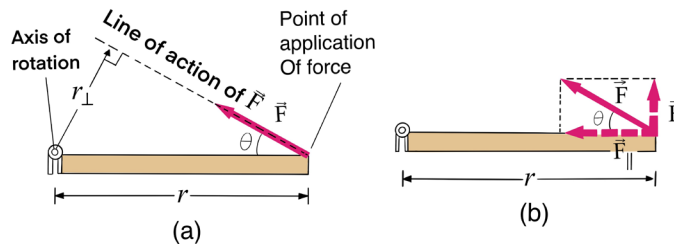

Figure 3.1: Lever arm

An equivalent way of determining the torque associated with a force is to resolve the force into components parallel and perpendicular to the line that connects the axis to the point of application of the force, as shown in Fig. 3.1b. The component F_{\parallel} exerts no torque since it is directed at the rotation axis (its lever arm is zero). Hence the torque will be equal to F_{\perp} times the distance r from the axis to the point of application of the force:

$$M = rF_{\perp} = Fr \sin \theta$$

Activity 4



- (i) Suspend a meter rule at its middle point, either by passing a string through a hole or a knife edge. If necessary stick plasticine one on each side to make it balance exactly.
- (ii) Tie loops of thread to several
- (iii) Hang a 0.5 N weight A (the load) on the left hand side of the ruler on the 34 cm mark (16 cm) from the fulcrum)
- (iv) Place another weight 0.2 N (the effort) on the other side and move it until the ruler balances.

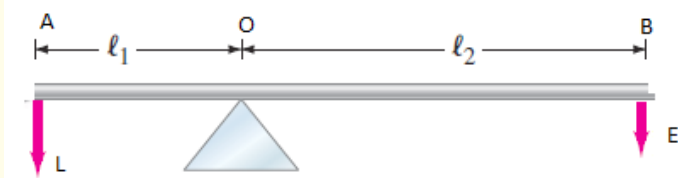

- (v) Note the distances of the weights from the fulcrum, i.e. from the midpoint.
- (vi) Record the results in a suitable table as shown in the table.

- (vii) Repeat several times with (a) the same weights in different position, and (b) different weights.

Weight A	d_{AO}	$W_A d_{AO}$	Weight B	d_{BO}	$W_B d_{BO}$
0.5N	16cm	8 N cm	0.2N	40cm	8 N cm

The table suggests that when the turning effects of forces acting on an object are balanced the sum of clock wise moments is the same as the sum of anticlockwise moments. This is the principle of moment

Principle of moment of force

When a body is in equilibrium (balanced), the sum of the anticlockwise moments about any point is equal to the sum of the clockwise moments about the same point.

$$\sum_{i=1}^n \mu_i^+ = \sum_{i=1}^m \mu_i^-$$

Example

In kinesiology (the study of human motion), it is often useful to know the location of the center of mass of a person. This can be determined with the arrangement shown fig A. A plank of weight 40 N is placed on two scales separated by 2.0 m. A person lies on the plank and the left scale reads 216 N and the right scale reads 314 N as shown in fig B. What is the distance from the left scale to the person's center of mass?



Solution

Calculate the torque about the CM of the person:

$$216(2 - x) - 40(1 - x) - 314x = 0 \Leftrightarrow x = 0.8 \text{ m}$$

Note that the person's weight which we could find using $\sum F_y = 0$ doesn't enter into the calculation because I chose the pivot at the center of mass.

Moment of a couple

Two equal and opposite parallel forces whose lines of action do not coincide form what is called a **moment of couple**. The two forces always have a turning effect, or moment, and called a **net torque**, which is given by force times lever arm: $\tau_1 = F_1 d_1$ and $\tau_2 = F_2 d_2$

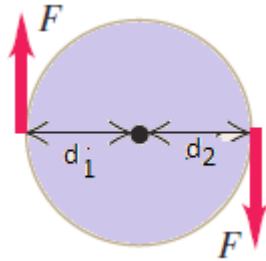

Figure 3.2: Moment of a couple

Because each force produces clockwise rotation or anticlockwise rotation, both torques are negative or positive i.e.

$$\tau = \pm Fd_1 \pm Fd_2 = \pm F(d_1 + d_2) = Fd$$

Torque of couple is force time perpendicular distance between forces.

A **torque** is a quantity that measures the ability of a force to rotate an object around some axis. Net torque produces rotation. A torque is positive or negative; depending on the direction the force tends to rotate an object. Torques that produce counterclockwise rotation are defined to be **positive**.

Example

A basketball is being pushed by two basketball players during tip-off. Assuming each force acts perpendicular to the axis of rotation through the centre of ball the ball; find the net torque acting on the ball.

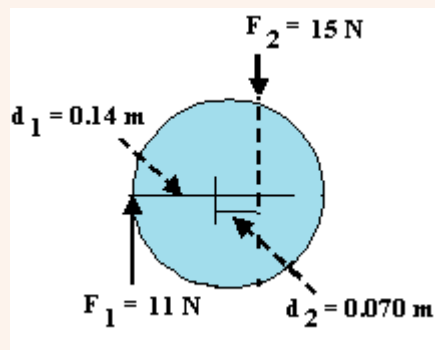

Solution

$$\text{Net torque: } \tau_{net} = F_1 d_1 + F_2 d_2$$

Because each force produces clockwise rotation, both torques are negative.

$$\tau_{net} = -(15 \times 0.14) - (11 \times 0.70) = -2.9 \text{ Nm}$$

The net torque is negative, so the ball rotates in a clockwise direction.

Torque should not be confused with work

Torque ($\tau = Fd \sin \theta$) and work ($W = Fd \cos \theta$) can both be expressed in units of N m, so be careful to distinguish torque and work. The components of a force that produces work is parallel to a distance (the displacement), while the component of force that produces torque is perpendicular to a distance (the lever arm).

Torque should not be confused with force. Forces can cause a change in linear motion, as described by Newton's second law. Forces can also cause a change in rotational motion, but the effectiveness of the forces in causing this change depends on both the forces and the moment arms of the forces, in the combination that we call *torque*.

If two or more forces are acting on a rigid object, as shown in Fig.3.3, each tends to produce rotation about the pivot at O . We use the convention that the sign of the torque resulting from a force is positive if the turning tendency of the force is counterclockwise and is negative if the turning tendency is clockwise.

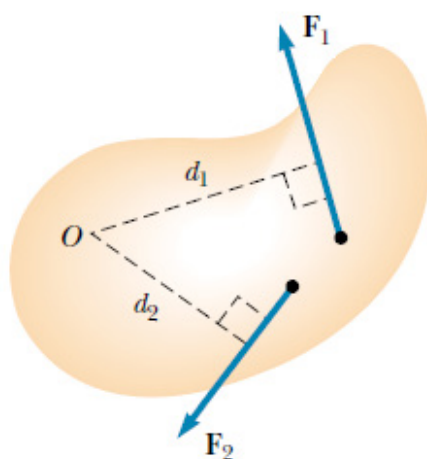

Figure 3.3: The force F_1 tends to rotate the object counterclockwise about O , and F_2 tends to rotate it clockwise.

Equilibrium of a body

Conditions for equilibrium

Objects in daily life have at least one force acting on them (gravity). If they are at rest, then there must be other forces acting on them as well so that the net force is zero. A book at rest on a table, for example, has two forces acting on it, the downward force of gravity and the normal force the table exerts upward on it (Fig. 3.4).

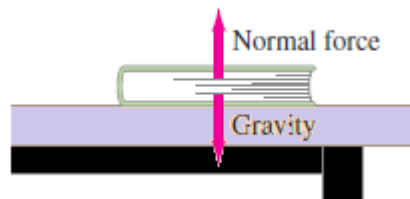

Figure 3.4: The book is in equilibrium; the net force on it is zero

Because the book is at rest, Newton's second law tells us that the net force on it is zero. Thus the upward force exerted by the table on the book must be equal in magnitude to the force of gravity acting downward on the book. Such an object is said to be in **equilibrium** (Latin for "equal forces" or "balance") under the action of these two forces. This is often called the **first condition for equilibrium** (Fig.3.5a).

Force not only push or pull but have a **turning-effect or moment about an axis**. In cases of equilibrium the moments have also to be considered. If forces act at different points on an extended body an additional requirement must be satisfied to ensure that the body has no tendency to rotate: The sum of the torques about any point must be zero (Fig.3.5.b). This is called the **second condition for equilibrium**.

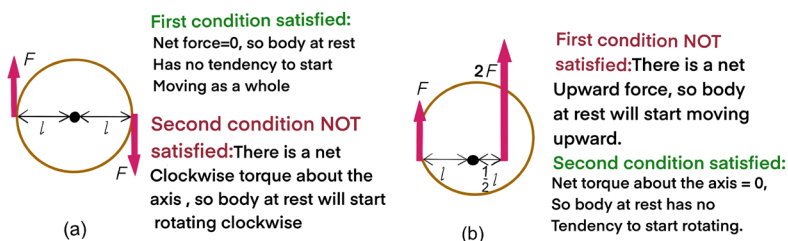

Figure 3.5: (a) This body has no tendency to accelerate as a whole, but it has a tendency to start rotating (b) This body has a tendency to accelerate as a whole but no tendency to start rotating.

Conditions of equilibrium of a body under the action of forces

- (i) The vector sum of all external forces (\vec{F}_{ext}) is zero;

$$\sum \vec{F}_{ext} = \vec{0}$$

- (ii) The sum of the moments of all **external forces** (M) about any line is zero:

$$\sum M = 0$$

A rigid body is in **mechanical equilibrium** when the sum of all forces on all particles of the system is zero (i.e. when all the particles of the system are at rest or that its center of mass moves with constant velocity relative to the observer and the total force on each particle is permanently zero), and also the sum of all torques on all particles of the system is zero so that its state of rotational motion remains constant. The bodies are rigid if they do not deform under the action of applied forces.

We will apply the first and second conditions for equilibrium to situations in which a rigid body is at rest (no translation or rotation). Such a body is said to be in **static equilibrium** (Fig. 3.6). But the same conditions apply to a rigid body in uniform *translational* motion (without rotation), such as an airplane in flight with constant speed, direction, and altitude. Such a body is in equilibrium but is not static.

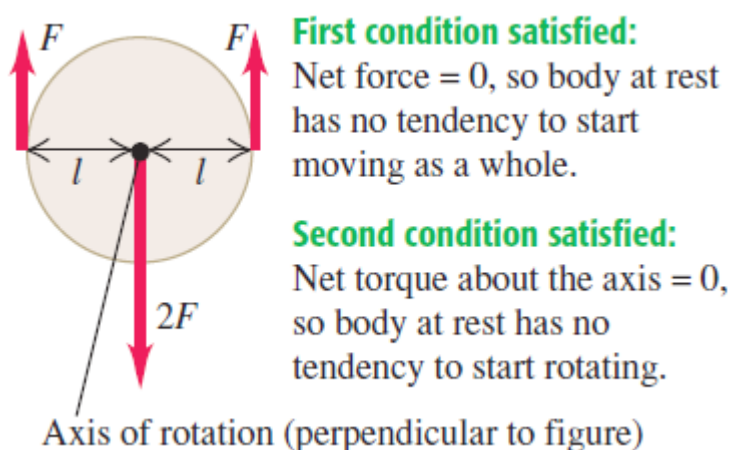

Figure 3.6: To be in static equilibrium, a body at rest must satisfy both conditions for equilibrium: It can have no tendency to accelerate as a whole or to start rotating

The above conditions of equilibrium are also used to determine the resultant of **non-parallel, non-concurrent** systems of forces i.e. all of the lines of action of the forces in this system do not meet at one point. The parallel force system was a special case of this type. Since all of these forces are not entirely parallel, the position of the resultant can be established using the graphical or algebraic methods of resolving co-planar forces

There are a number of ways in which one could resolve the force system that is shown. One graphical method would be to resolve a pair of forces using the parallelogram or triangle method into a resultant. The resultant would then be combined with one of the remaining forces and a new resultant determined, and so on until all of the forces had been accounted for. This could prove to be very complex if there are a great number of forces. The algebraic solution to this system would potentially be simpler if the forces that are applied to the system are easy to break into components.

■ **Addition of Forces in a Plane (Stevinus law)**

If all the forces acting on a body act in a plane, they are called coplanar forces. If they have a common point of application they are called concurrent forces

Consider a body that is subjected to two forces F_1 and F_2 , whose lines of action intersect at point A (Fig. 3.7). It is postulated that the two forces can be replaced by a statically equivalent force R . This postulate is an axiom; it is known as the **parallelogram law of forces**. The force R is called the resultant of F_1 and F_2 . It is the diagonal of the parallelogram for which F_1 and F_2 are adjacent sides.

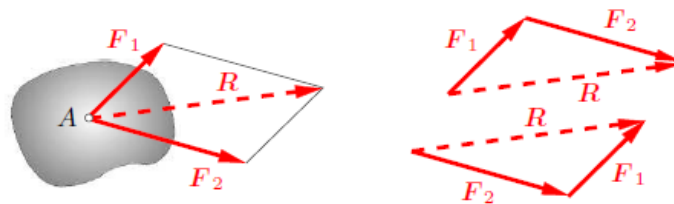

Figure 3.7: Parallelogram law of forces

Now consider a system of n forces that all lie in a plane and whose lines of action intersect at point A (Fig. 3.8). Such a system is called a **coplanar system of concurrent forces**. The resultant can be obtained through successive application of the parallelogram law of forces. Mathematically, the summation may be written in the form of the following vector equation:

$$R = F_1 + F_2 + F_3 + \dots + F_n = \sum_{i=1}^n F_i$$

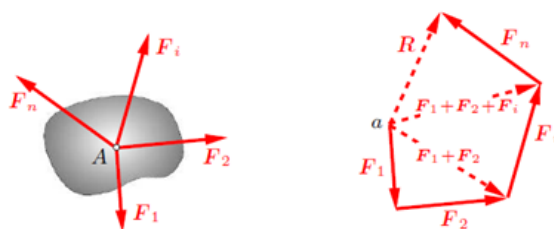

Figure 3.8: Successive application of the parallelogram law of forces

■ Representation in Cartesian Coordinates

It is usually convenient to resolve forces into two components that are perpendicular to each other. The directions of the components may then be given by the axes x and y of a Cartesian coordinate system (Fig. 3.8). The quantities F_x and F_y are called the coordinates of the vector F or components of F .

$$F = F_x i + F_y j$$

Where $F_x = F \cos \theta$, $F_y = F \sin \theta$, $F = \sqrt{F_x^2 + F_y^2}$ and $\tan \theta = \frac{F_y}{F_x}$

It will be shown that the coordinates of the resultant of a system of concurrent forces can be obtained by simply adding the respective coordinates of the forces

In general, if F_1 and F_2 make an angle θ , the resultant R is given by:

$$R = \sqrt{F_1^2 + F_2^2 + 2F_1F_2 \cos \theta}$$

Examples

1. A hiker begins a trip by first walking 25.0 km southeast from her car. She stops and sets up her tent for the night. On the second day, she walks 40.0 km in a direction 60.0° north of east, at which point she discovers a forest ranger's tower.
 - (a) Determine the components of the hiker's displacement for each day.
 - (b) Determine the components of the hiker's resultant displacement R for the trip. Find an expression for R in terms of unit vectors.
 - (c) Determine the magnitude and direction of the total displacement.

Solution

- (a) If we denote the displacement vectors on the first and second days by A and B , respectively, and use the car as the origin of coordinates, we obtain the vectors shown in Figure below.

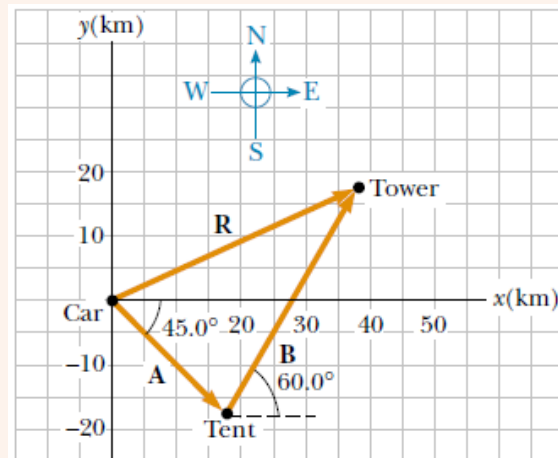

Displacement A has a magnitude of 25.0 km and is directed 45.0° below the positive x axis, its components are

$$A_x = A \cos(-45.0) = 17.7 \text{ km}$$

$$A_y = A \sin(-45.0) = -17.7 \text{ km}$$

The second displacement B has a magnitude of 40.0 km and is 60.0° north of east. Its components are

$$B_x = B \cos(60.0) = 20.0 \text{ km}$$

$$B_y = B \sin(60.0) = 34.6 \text{ km}$$

- (b) The resultant displacement for the trip has components given by

$$R_x = A_x + B_x = 17.7 + 20.0 = 37.7 \text{ km}$$

$$R_y = A_y + B_y = -17.7 + 34.6 = 16.9 \text{ km}$$

In unit-vector form, we can write the total displacement as

$$\vec{R} = (37.7\vec{i} + 16.9\vec{j})\text{km}$$

$$(c) \quad R = \sqrt{(37.7)^2 + (16.9)^2} = 41.3 \text{ km} \quad \text{and} \quad \theta = \tan^{-1}\left(\frac{16.9}{37.7}\right) = 24.1^\circ$$

Therefore, the displacement is: 41.3 km, 24.1° north of east from the car

2. Under what circumstances would a nonzero vector lying in the xy plane have components that are equal in magnitude?

Solution

Any vector that points along a line at 45° to the x and y axes has components equal in magnitude.

3. In what circumstance is the x component of a vector given by the magnitude of the vector times the sine of its direction angle?

Solution

If the direction of a vector is specified by giving the angle of the vector measured clockwise from the positive y -axis, then the x -component of the vector is equal to the sine of the angle multiplied by the magnitude of the vector.

4. If $\mathbf{A} = \mathbf{B}$, what can you conclude about the components of \mathbf{A} and \mathbf{B} ?

Solution

Any vector that points along a line at 45° to the x and y axes has components equal in magnitude.

■ Lami's theorem

Lami's theorem gives the conditions of equilibrium for three forces acting at a point O . Lami's theorem states that *if three forces acting at a point are in equilibrium, then each of the force is directly proportional to the sine of the angle between the remaining two forces.*

Let us consider three forces \vec{P} , \vec{Q} and \vec{R} acting at a point O (Fig below). Under the action of three forces, the point O is at rest, then by Lami's theorem,

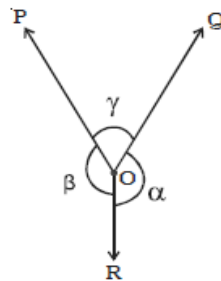

$$\frac{\bar{P}}{\sin \alpha} = \frac{\bar{Q}}{\sin \beta} = \frac{\bar{R}}{\sin \gamma}$$

Branch of mechanics which deals with state of equilibrium is called **statics**. **Statics** is the branch of mechanics concerned with the analysis of loads (force, torque/moment) on physical systems in static equilibrium, that is, in a state where the relative positions of subsystems do not vary over time, or where components and structures are at a constant velocity. When in static equilibrium, the system is either at rest, or its center of mass moves at constant velocity. The study of moving bodies is known as dynamics, and in fact the entire field of statics is a special case of dynamics.

Stability and Balance

An object in static equilibrium, if left undisturbed, will undergo no translational or rotational acceleration since the sum of all the forces and the sum of all the torques acting on it are zero. However, if the object is displaced slightly, three outcomes are possible:

- Equilibrium is said to be **stable** if small, externally induced displacements from that state produce forces that tend to oppose the displacement and return the body or particle to the equilibrium state. Examples include a weight suspended by a spring or a brick lying on a level surface.
- Equilibrium is **unstable** if the least departure produces forces that tend to increase the displacement. An example is a ball bearing balanced on the edge of a razor blade.
- **Static Equilibrium (neutral equilibrium)** is equilibrium where all forces are balanced, but it also applies to bodies in uniform or accelerated motion. For example, a book resting on a table applies a downward force equal to its weight on the table. According to the third law, the table applies an equal and opposite force to the book. This force occurs because the weight of the book causes the table to deform slightly so that it pushes back on the book like a coiled spring.

By summing up

- A system is said to be in stable equilibrium if, when displaced from equilibrium, it experiences a net force or torque in a direction opposite the direction of the displacement.
- A system is in unstable equilibrium if, when displaced from equilibrium, it experiences a net force or torque in the same direction as the displacement from equilibrium.

- A system is in neutral equilibrium if its equilibrium is independent of displacements from its original position.

Fig.3.9 and Fig.3.10 summarise these different types of equilibrium.

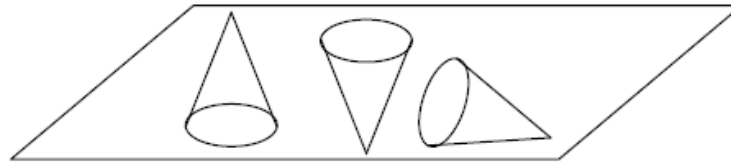

Figure 3.9: A cone in stable, unstable and neutral equilibrium on the horizontal surface

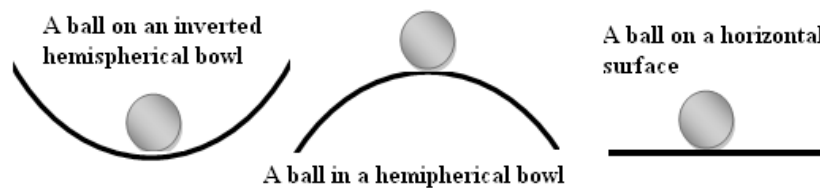

Figure 3.10: A ball in Stable, Unstable and neutral equilibrium

Centre of gravity and center of mass

Concept of centre of gravity and center of mass

The **center of gravity** is the average location of the weight of an object. The centre of gravity is defined as the point of application of the resultant force due to the earth's attraction on it. The center of gravity is a geometric property of any object.

The centre of gravity of a body also coincides with its centre of mass. The **center of mass** of an object may be defined as the point at which an applied force produces acceleration but no rotation

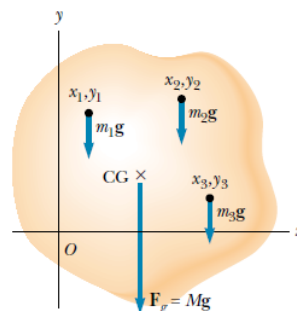

Figure 3.11: The center of gravity of an object is located at the center of mass if g is constant over the object

Centre of gravity and base of support of a body

1. For balance to exist, the line of gravity must intersect the base of support.
2. If the area of the base of support of an object is increased, this tends to increase the stability of the object.
3. The lower the center of gravity is above the base of support the more stable the object tends to be. (This is true even though the size of the base of support is unchanged.)
4. Objects that are more massive tend to be more stable.
5. For an object, the farther the line of gravity's intersection is from the edge of its base of support the more stable the object tends to be in that direction.

Determining the center of gravity

Determining the center of gravity is very important for any flying object. In general, determining the center of gravity (cg) is a complicated procedure because the mass (and weight) may not be uniformly distributed throughout the object. If the mass is uniformly distributed, the problem is greatly simplified. If the object has a line (or plane) of symmetry, the center of gravity lies on the line of symmetry.

For a solid block of uniform material, the center of gravity is simply at the average location of the physical dimensions.

Example

For a triangle of height h , the Center of Gravity is at $h/3$, and for a semi-circle of radius r , the cg is at $\frac{4r}{3\pi}$, for a rectangular block, $50 \times 20 \times 10$, the center of gravity is at the point (25, 10, 5).

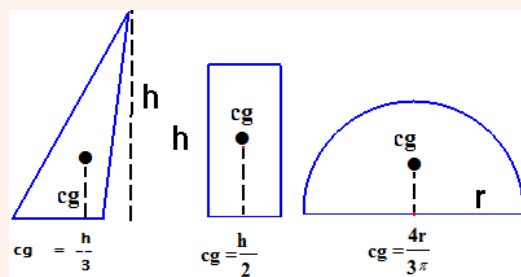

Figure 3.12: Centre of gravity

Activity 5



To determine the centre of gravity of different regular shapes

Apparatus

- * Manila paper, scissors, a pencil and a ruler

Procedure

- Make a number of shapes from a manila paper, as below:

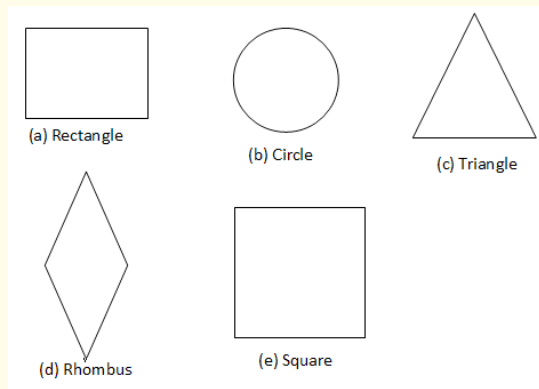

- Find the centre of gravity of those different figures.

Conclusion

The point of intersection of diagonals (a,d and e), bisectors (c) , diameters(b) is the centre of gravity of those figures

For a general shaped object, there is a simple mechanical way to determine the center of gravity:

In Step 1, you hang the object from any point and you drop a weighted string (plumb line) from the same point. Draw a line on the object along the string.

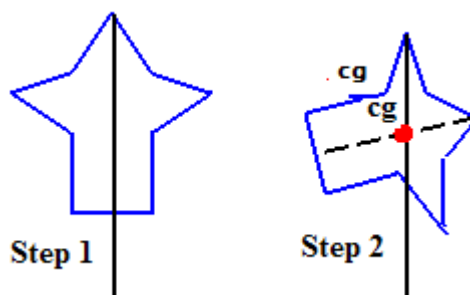

Figure 3.13: General shape

For Step 2, repeat the procedure from another point on the object you now have two lines drawn on the object which intersect. The center of gravity is the point where the lines intersect. This procedure works well for irregularly shaped objects that are hard to balance.

Activity 6



To determine the centre of gravity of an irregularly shaped lamina

Apparatus

* A plumb line, a thread, a stand and a cardboard

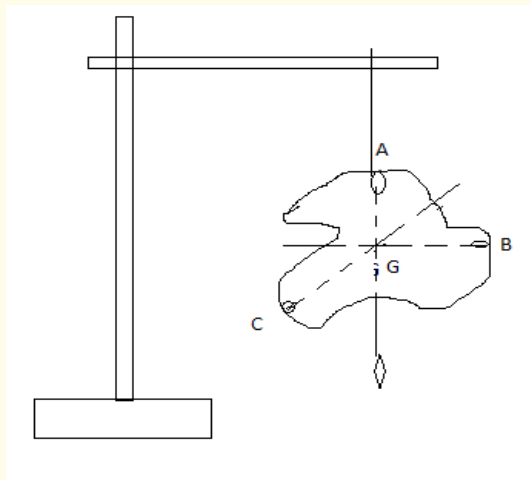

Procedure

- Make 3 holes, A, B and C on the edges the cardboard.
- Suspend it by a rod through the hole A as shown in Figure2.4
- Tie a plumb line on the rod beside the cardboard.
- After the cardboard and plumb line have stopped swinging, draw a vertical line on the cardboard as set by plumb line.
- Repeat the experiment using other holes B and C. The lines intersect at a point noted G
- Balance the cardboard with the tip of a pencil at the point of intersection of the three lines. What do you observe?

Observation

The suspended object will always rest with its centre of gravity vertically below the point of support. The object balances on the tip of the pencil if placed at its centre of gravit.

Determination of the center of mass

Consider several point masses $m_1, m_2, m_3 \dots m_n$. If the position vectors relative to a fixed origin O are r_1, r_2, \dots, r_n .

The centre of mass is define by

$$(m_1 + m_2 + m_3 + \dots + m_n)r_G = m_1r_1 + m_2r_2 + m_3r_3 + \dots + m_nr_n$$

$$\text{Total mass } M = m_1 + m_2 + m_3 + \dots + m_n = \sum_{i=1}^n m_i$$

$$m_1r_1 + m_2r_2 + m_3r_3 + \dots + m_nr_n = \sum_{i=1}^n m_i r_i$$

$$\text{The position vector of G: } r_G = \frac{\sum_{i=1}^n m_i r_i}{\sum_{i=1}^n m_i}$$

In the x - y plane: $m_1(x_1, y_1), m_2(x_2, y_2), \dots, m_n(x_n, y_n)$

$$\text{Then } r_G(x, y) \text{ where } x = \frac{\sum_{i=1}^n m_i x_i}{\sum_{i=1}^n m_i} \text{ and } y = \frac{\sum_{i=1}^n m_i y_i}{\sum_{i=1}^n m_i}$$

Examples

- Three people of roughly equivalent mass m on a lightweight (air-filled) banana boat sit along the X-axis at positions $x_1 = 1.0$ m, $x_2 = 5.0$ m, and $x_3 = 6.0$ m. Find the position of the CM.

Solution

$$X_{cm} = \frac{mx_1 + mx_2 + mx_3}{m + m + m} = 4.0m$$

- A system consists of the following masses in the xy -plane 40 kg at coordinates $(x = 0; y = 5.0m)$, 7.0 kg at $(x = 3.0; y = 8.0)$ and $(x = -3.0m; y = -6.0m)$. Find the position of its center of mass.

Solution

$$CM \left\{ \begin{array}{l} x = \frac{\sum_i^n m_i x_i}{\sum_i^n m_i} = 0.83 \text{ m} \\ y = \frac{\sum_i^n m_i y_i}{\sum_i^n m_i} = 2.9 \text{ m} \end{array} \right.$$

Stability and center of gravity

Consider a ball suspended freely from a string is in stable equilibrium, for if it is displaced to one side, it will return to its original position (Fig. 3.14a) due to the net force and torque exerted on it. On the other hand, a pencil standing on its point is in unstable equilibrium. If its center of gravity is directly over its tip (Fig. 3.14b), the net force and net torque on it will be zero. But if it is displaced ever so slightly as shown—say, by a slight vibration or tiny air current—there will be a torque on it, and this torque acts to make the pencil continue to fall in the direction of the original displacement.

Finally, an example of an object in neutral equilibrium is a sphere resting on a horizontal tabletop. If it is moved slightly to one side, it will remain in its new position—no net torque acts on it.

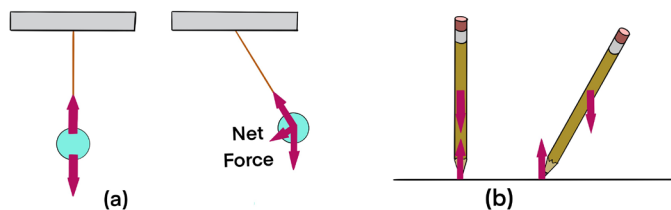

Figure 3.14: (a) Stable equilibrium, and (b) unstable equilibrium

In general, an object whose center of gravity (CG) is below its point of support, such as a ball on a string, will be in stable equilibrium. Consider a standing refrigerator (Fig. 3.15a). If it is tipped slightly, it will return to its original position due to the torque on it as shown in Fig. 3.15b. But if it is tipped too far, Fig. 3.15c, it will fall over. The critical point is reached when the CG shifts

from one side of the pivot point to the other. When the CG is on one side, the torque pulls the object back onto its original base of support, Fig. 3.15b. If the object is tipped further, the CG goes past the pivot point and the torque causes the object to topple, Fig. 3.15c.

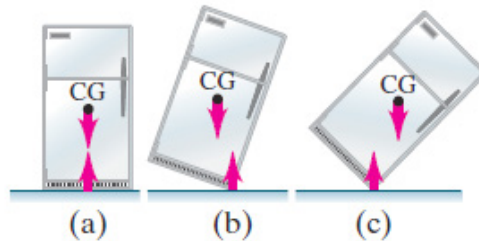

Figure 3.15: Equilibrium of a refrigerator resting on a flat floor

In general,

- an object whose center of gravity is above its base of support will be stable if a vertical line projected downward from the CG falls within the base of support. This is because the normal force upward on the object (which balances out gravity) can be exerted only within the area of contact, so if the force of gravity acts beyond this area, a net torque will act to topple the object.
- the larger the base and the lower the CG, the more stable the object.
- an object tends to fall when its center of gravity is away from the base that supports it.

Applications of equilibrium

Tower Crane – Method of Joints

The tower crane shown in the figure below consists of tower DCE fixed at the ground and two jibs AC and CB. The jibs are supported by tie bars AD and DB, and are assumed to be attached to the tower by pinned connections. The counterweight WC weighs and the crane has a lifting capacity of W.

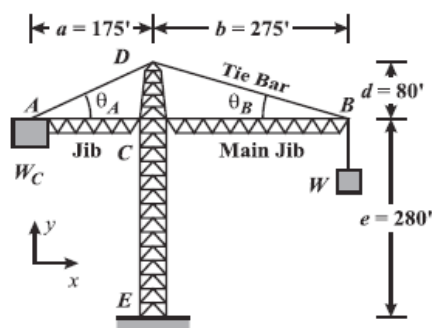

Beam balance

It consists of a pivoted horizontal lever of equal length arms called the beam, with a weighing pan also called scale, scale pan or boson, suspended from each arm.

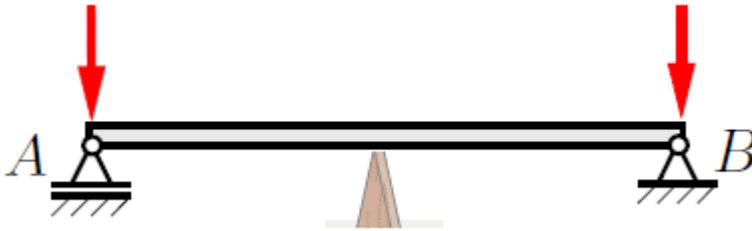

The unknown mass is placed on one pan and standard masses are added on the other pan until it is as close to equilibrium as possible. In precision balances a slider mass is moved along a graduated scale. The slider position gives a fine collection to the mass value.

Example

A uniform meter stick supported at the 25 cm mark is in equilibrium when a 1 kg rock is suspended at the 0 cm end (as shown in Fig.). Is the mass of the meter stick greater than, equal to, or less than the mass of the rock? Explain your reasoning.

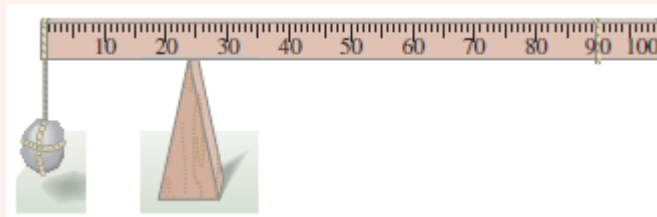

Solution

$$1 \text{ kg} \times 25 \text{ cm} = 25 \text{ cm} \times m$$

$$\Leftrightarrow m = 1 \text{ kg}$$

therefore the mass of the meter stick is equal to the mass of the rock.

Application Activity 3.3

A friend of yours that has been sick comes from the hospital where he had gone for medication telling you that he is 62 kg and that is what is indicated on his medical papers.

Imagine you have the following

- * A strong wood bar of a bout 5m (or any length as long as you know its actual length) and has a mass of 10kg.
- * A wood that you can use as a pivot
 - a) Since you know the exact mass of your friend and that of the wood. Explain all the procedures you can follow to know your mass. In your procedures include all the necessary equations and diagrams you may need to use.
 - b) Do you think the mass (your mass) you obtained is accurate? Explain your reasoning.
 - c) What do you think may be the source of errors in determining your mass? Or any unknown mass?
 - d) Basing on your knowledge and understanding you have obtained from this unit, how can this unit be applied in your career you are pursuing?

END UNIT ASSESSMENT

1. The uniform bar shown below weighs 40 N and is subjected to the forces shown. Find the magnitude, location, and direction of the force needed to keep the bar in equilibrium.

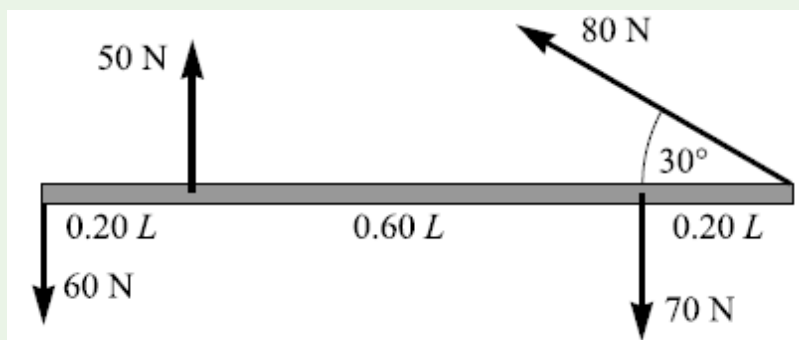

2. System given below is in equilibrium. If the potential energies of objects A and B are equal, find the mass of object A in terms of G. (Rod is homogeneous and weight of it is G.)

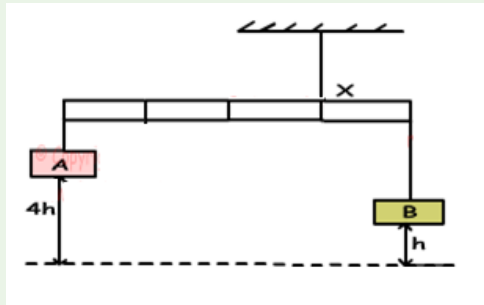

A 172 cm tall person lies on a light (massless) board which is supported by two scales, one under the top of her head and one beneath the bottom of her feet see Fig. The two scales read respectively 35.1 kg and 31.6 kg. What distance is the center of gravity of this person from the bottom of her feet?

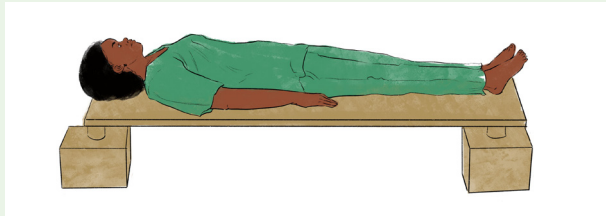

3. **A)** A seesaw consisting of a uniform board of mass $M = 10\text{kg}$ and length $l = 2\text{m}$ supports a father and daughter with masses m_f and m_d , 50 and 20kg respectively as shown in the Figure below.

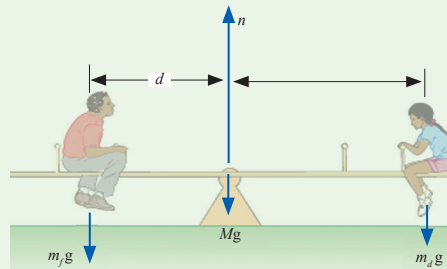

The support (called the fulcrum) is under the center of gravity of the board, the father is a distance d from the center, and the daughter is a distance $l/2$ from the center.

- Determine the magnitude of the upward force n exerted by the support on the board.
 - Determine where the father should sit to balance the system.
- B)** Three children are trying to balance on a seesaw, which consists of a fulcrum rock, acting as a pivot at the center, and a very light board 3.6 m long (see fig.).

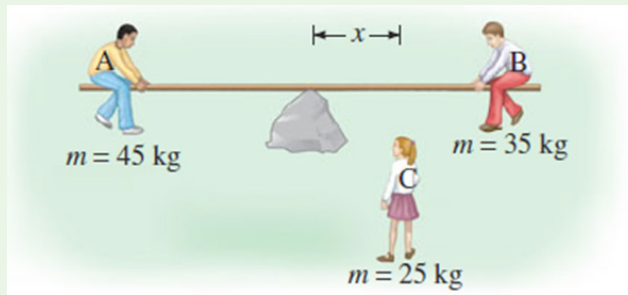

Two playmates are already on either end. Boy A has a mass of 45 kg, and girl B a mass of 35 kg. Where should girl C, whose mass is 25 kg, place herself so as to balance the seesaw?

4. A uniform 1500kg beam, 20m long, supports a 15,000kg printing press 5 from the right support column, see the figure. Calculate the force on each of the vertical support columns.

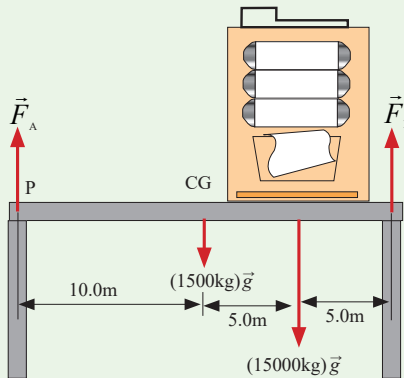

Figure 3.15: Indicating forces developed in a beam

5. A horizontal rod AB is suspended at its ends by two strings. (See the figure below). The rod is 0.6m long and its weight of 3N acts at G where AG is 0.4m and BG is 0.2m. Find the tensions X and Y
- 6.

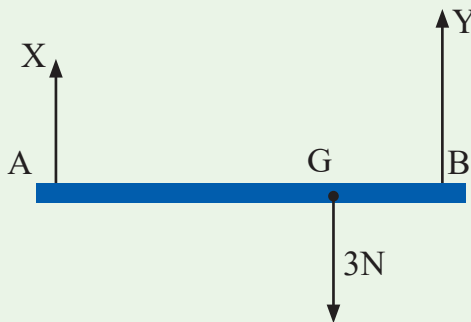

Figure 3.16: Indicating forces on a beam supported by two strings

7. A block of mass 330kg is suspended by three unstretchable ropes as shown on the figure below. If the system is in equilibrium,
- determine T_1 ,
 - If $\theta_1 = 15^\circ$, $\theta_2 = 30^\circ$, find the tensions in the ropes.

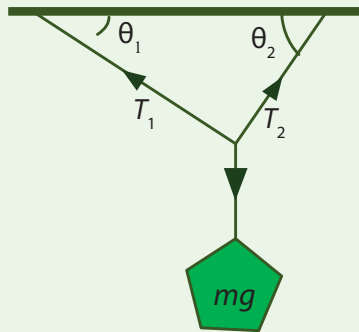
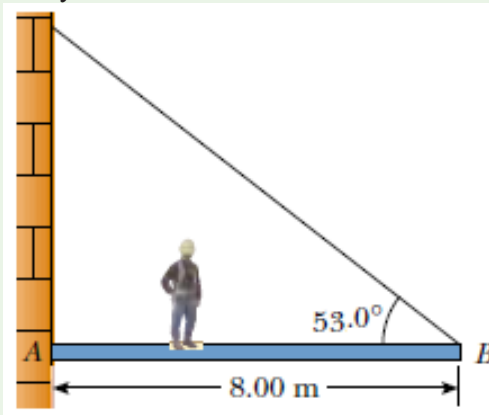

Figure 3.17: Showing a body of mass supported by 2 strings

8. A uniform horizontal beam with a length of 8.00 m and a weight of 200 N is attached to a wall by a pin connection. Its far end is supported by a cable that makes an angle of 53.0° with the beam (Fig. 3.21). If a 600 N person stands 2.00 m from the wall, find the tension in the cable as well as the magnitude and direction of the force exerted by the wall on the beam.



*Fig.3. 21 A uniform beam supported by a cable.
A person walks outward on the beam*

The coefficient of static friction between the ladder and the ground is 0.53. How far up the ladder can the firefighter go before the ladder starts to slip?

9. A homogeneous beam of length 2.20m and of mass $m = 25.0$ kg is fixed on a wall by a hinge and is held in horizontal position by a metallic string making angle of $\theta = 30.0^\circ$ as shown in the figure below. It holds a mass $M = 28.0$ kg suspended at its extremity. Determine the components of the force \vec{F} exerted by the wall on the beam at the hinge and components of the tension \vec{T} in the metallic string.

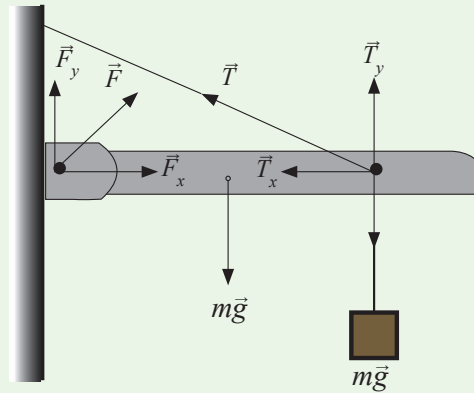

Figure 3.19: Showing forces acting on a bar fixed at one point with a mass connected at one point

Unit 4

Work, Energy and Power

Key Unit Competence

Evaluate the relation between work, energy and power and the resulting phenomena.

My goals

By the end of this unit, I will be able to:

- * define work done, energy and power.
- * state the formulae of work, energy and power.
- * explain how power depends on energy.
- * explain how gravitational potential energy.
- * identify the difference between potential energy and kinetic energy
- * describe strain and work done in deforming materials

INTRODUCTORY ACTIVITY

Kaliza and Kalisa are classmates in senior four sciences. When Kaliza mops the class alone; she can do it in only 30 minutes. But when Kalisa is given the same task of mopping the class, he can do it in 45 minutes.

Questions

1. Discuss the work being done as in the above case study. In your own words define the term work.
2. Sometimes people do confuse the term work and energy. Are they different? Are they the same? Explain your choice.
3. Between Kaliza and Kalisa who is more powerful? Why?
4. By research find the meaning of the terms: Work, energy and power

Introduction

In real life, we always use the term **work**. Which means “task to be accomplished. But before the task to be done, one must have **energy**. Then if a given work is done in a given time, we say that one has power i.e work done in a given time.

Work

Review of the idea of work



Activity 1

Study and interpret the diagram below

CASE I

Work is done when a force moves its point of application along the direction of its action.

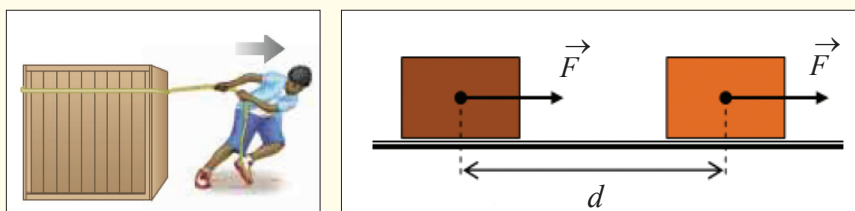

Figure 4.1: The force and the displacement have the same direction

- * How is the force applied onto the body?
- * Why does it change its position?
- * What if the body is 10 times the mass of the boy. Would the body change its position? Why?
- * State the direction of application of force.

From the fig. 4.1 and your deductions, how can you define Work?

CASE II

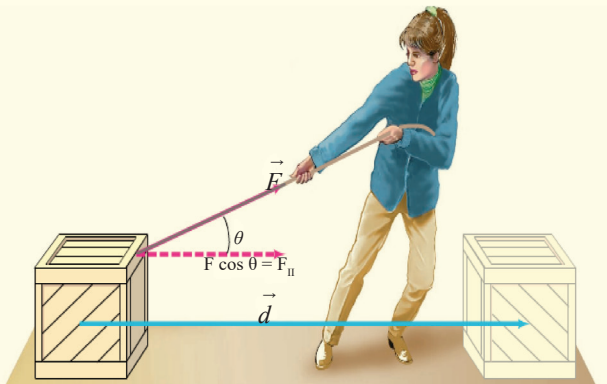

Figure 4.2: The force and the displacement make a certain angle

Activity 2



Aim; To relate distance, force and work

Let us as a class visit any where people are constructing a house, a bridge, road.

Ask them why they are paid?

Ask them how they measure what they do.

From the diagram (CASE I)

The work is done when a force moves its point of application along the direction of its action.

Let $W = \text{Force} \times \text{distance}$

$$W = F \times d$$

$$1\text{Nm}=1\text{Joule}$$

In the second case, the work done is defined as the product of the component of the force in the direction of the motion and displacement in that direction. That is: $W = F \times \cos \theta$

There is another unit of work called kilogram-metre, which is the work done by a force of 1kg when its application point moves through a distance of 1 m

$$1 \text{ kgf} = 9.81\text{N}$$

The SI unit of work is joule (J)

$$1 \text{ J} = 1 \text{ N} \times 1 \text{ m}$$

Then the **Joule** is the work done by a force of 1N when its application point moves through a distance of 1 meter in the direction of force.

Work is the scalar although force and displacement are both vectors.

Expressions of some kinds of work

Work of the gravitational force



Activity 3

- Hold a book in your hands at a height say h .
- Leave it to fall vertically onto the ground.

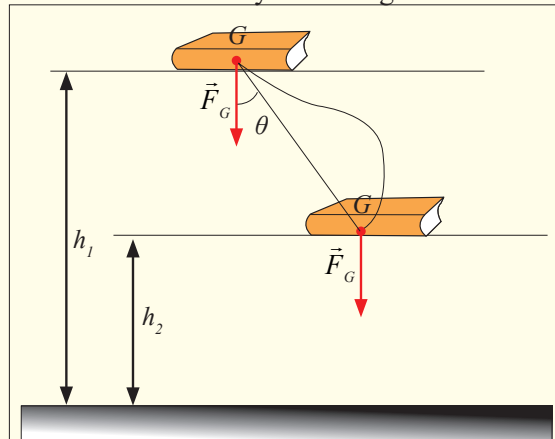

Figure 4.3: Object falling under gravity

NOTE:

If it moves from h_1 to h_2 under the gravitational force W following the path GG' , the work done is: $W = F_G \times \overline{GG'} \times \cos \theta$
 $\overline{GG'} \cos \theta = h_1 - h_2$, we have: $W = F_G (h_1 - h_2)$

From the deductions, it can be noted that:

The work done by the gravitational force does not depend on the path followed but on the change of the height.

Work done by the force of pressure

Activity 4



Requirements

* A syringe with a piston.

Aim: To determine work done by a piston.

* Pull the piston through a small distance Δx as shown in the figure below.

Assuming you applied a force F , What is the work done?

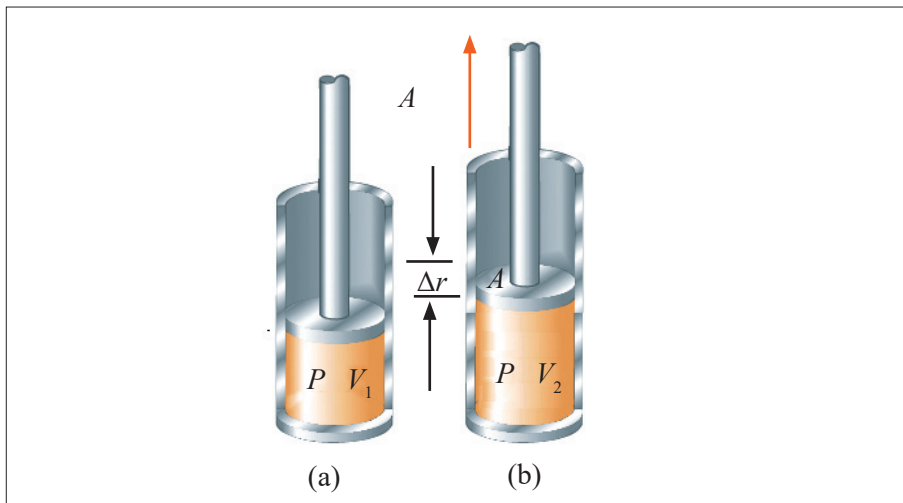

Figure 4.4: Heating the gas, the piston moves up

Note:

From Pressure being the force per unit area, we know that gas exerts pressure on the inside surface of the container.

Let us consider gas confined in a cylinder by a piston. If p is the pressure in the cylinder A , the area of the piston, heating the gas, the piston moves up, the volume increases but the pressure remains constant. If Δx is the displacement of the piston, the force which moves it is given by:

$F = P \times A$ The work during the displacement is:

$$W = F \times \Delta x$$

$$W = P \times A \times \Delta x$$

$A \times \Delta x = \Delta V$, the change of the volume

Then we have: $W = P \times \Delta V = P(V_2 - V_1)$

Application Activity 4.1

A force acting on a particle varies with x , as shown in Figure below. Calculate the work done by the force as the particle moves from $x = 0$ to $x = 6.0$ m.

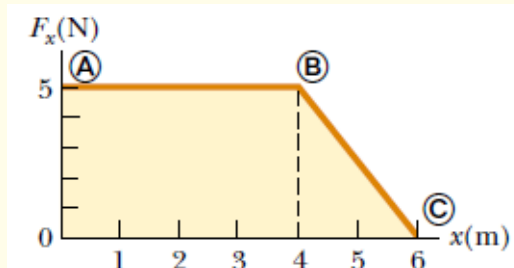

Energy

Activity 5



Ask yourself why some times you feel like not working or bored. What do you normally say when you are asked why you are not performing any duty? Use what comes into your mind to define energy.

Normally we say that Energy is ability of a body to do work.

It's measured in Joules like work. When an interchange of energy occurs between two bodies, we can consider the work done as a measure of the quantity of energy transferred between them. It has the same units as work and heat i.e. Joule.

The displacement is that of *the point of application of the force*. If the force is applied to a particle or a non-deformable, non-rotating system, this displacement is the same as the displacement of the particle or system. For deformable systems, however, these two displacements are often not the same.

Force is *not* necessarily the cause of the object's displacement. For example, if you lift an object, work is done by the gravitational force, although gravity is not the cause of the object moving upward! An important consideration is that work is an energy transfer. If W is the work done on a system and W is positive, energy is transferred to the system; if W is negative, energy is transferred *from* the system. Whenever work is done energy is transferred or converted from one form to another. Work is performed not only in motion and

displacement (mechanical work); it is done also by fire flame and electricity in electric lamps.

Example

The gravitational force exerted by the Sun on the Earth holds the Earth in an orbit around the Sun. Let us assume that the orbit is perfectly circular. The work done by this gravitational force during a short time interval in which the Earth moves through a displacement in its orbital path is

(a) zero (b) positive (c) negative (d) impossible to determine.

Solution

(a). The force does no work on the Earth because the force is pointed toward the center of the circle and is therefore perpendicular to the direction of the displacement.

Categories of Energy in Our Environment

There are several forms of energy in our environment e.g. mechanical energy, heat energy, light energy, electromagnetic energy, electric energy, nuclear energy, sound energy, chemical energy stored in petrol, food and other materials, moving matter such as water, wind, falling rocks, etc.

Furthermore, one form of energy can be converted to another. For example, when an electric motor is connected to a battery, the chemical energy in the battery is converted to electrical energy in the motor, which in turn is converted to mechanical energy as the motor turns some device.

Scientists classify forms of energy into two major categories: Potential energy and Kinetic energy.

Potential energy



Activity 6

How do we know that things have energy just because of their height? Well, let's think about the following process:

1. You lift a ball off the ground until it is above your head.
2. You drop it.
3. It is moving fast right before it hits the ground.
4. Draw a conclusion.

Potential energy may be defined as the energy possessed by an objects or bodies due to their position or state of strain or the position of their parts. Potential energy is energy deriving from position. Potential energy is referred to as stored energy because it can be looked at as energy which will be used when time comes for it to be used. Thus a stretched rubber band has elastic potential energy.

Kinds of potential energy:

a) Chemical potential energy

Activities such as tug of war or riding a bicycle, we use energy provided by the food we eat. In cars or motorcycles, petrol is used to provide energy. Petrol contains energy which makes these vehicles move. Food and petrol contain energy called chemical potential energy. It is called chemical energy because it is from the chemical bonds found in the food or petrol it is potentially available for use when it is needed.

b) Elastic potential energy

Restoring force

A block on a horizontal, frictionless surface is connected to a spring. If the spring is either stretched or compressed a small distance from its unstretched (equilibrium) configuration, it exerts on the block a force that can be expressed as $F = -k x$

x is the position of the block relative to its equilibrium ($x = 0$) position

- k is a positive constant called the force constant or the spring constant of the spring. The units of k are N/m.
- The negative sign in Equation signifies that the force exerted by the spring is always directed *opposite* to the displacement from equilibrium.

This force law for springs is known as **Hooke's law**. Because the spring force always acts toward the equilibrium position ($x = 0$), it is sometimes called a **restoring force**.

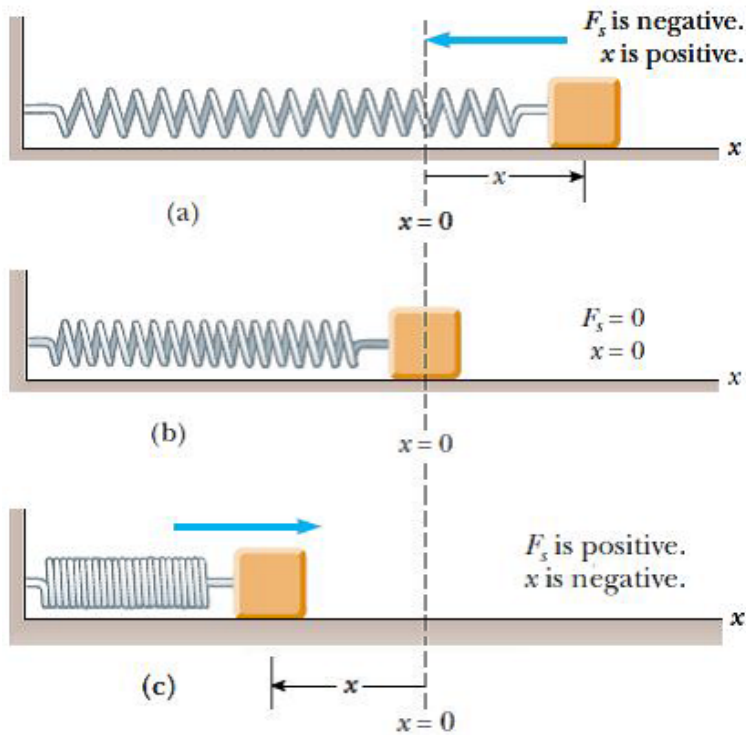

On the above figure The force exerted by a spring on a block varies with the block's position x relative to the equilibrium position $x = 0$. (a) When x is positive (stretched spring), the spring force is directed to the left. (b) When x is zero (natural length of the spring), the spring force is zero. (c) When x is negative (compressed spring), the spring force is directed to the right.

The work done by the spring force is positive because the force is in the same direction as the displacement of the block (both are to the right), and it is given by

$$W = \frac{1}{2} k x^2$$

Elastic Potential Energy

Activity 7



Aim; *To find out whether there is energy stored in elastic Materials*

In laboratory,

- * Try to perform experiment arranging your apparatus as shown in the figure below.
- * What do you observe after putting a mass on the spring.
- * What would happen if the mass of the body is given a small displacement downwards?

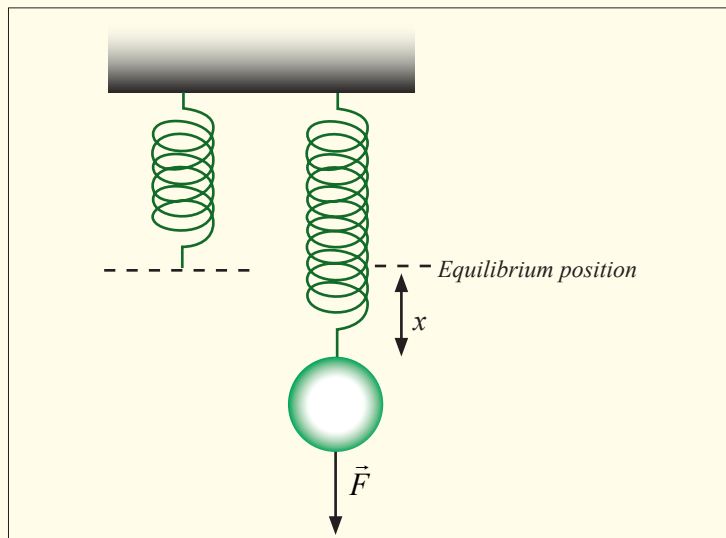
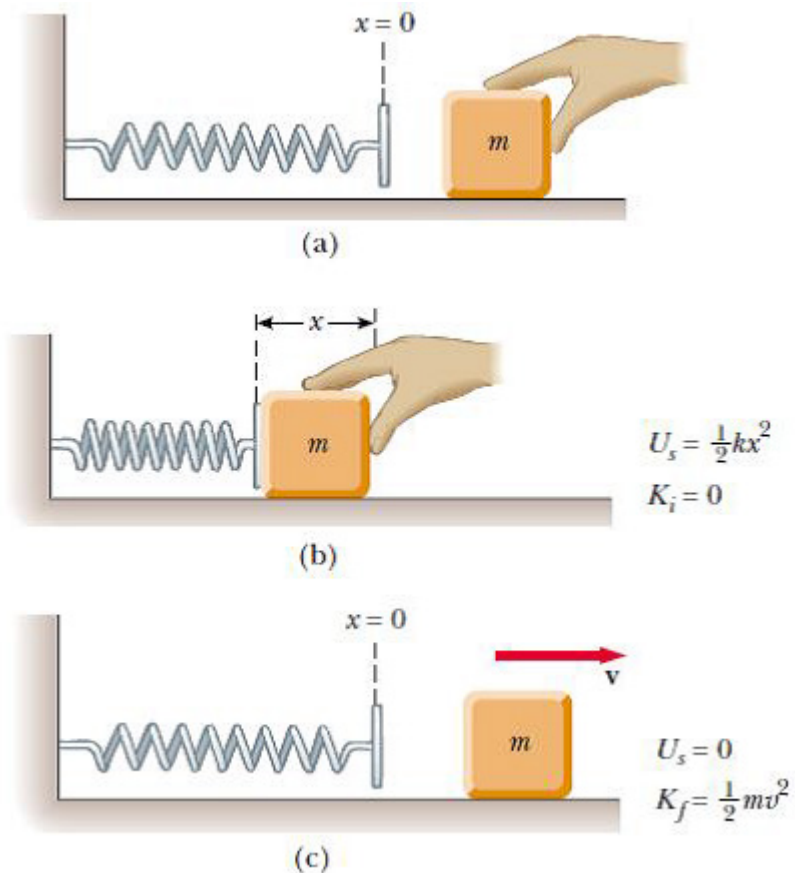

Figure 4.5: A force exerted on a mass attached on a spring extends the spring

The elastic potential energy of the system can be thought of as the energy stored in the deformed spring (one that is either compressed or stretched from its equilibrium position).

Consider Figure below, which shows a spring on a frictionless, horizontal surface.



On the above figure, An undeformed spring on a frictionless horizontal surface. (b) A block of mass m is pushed against the spring, compressing it a distance x . (c) When the block is released from rest, the elastic potential energy stored in the spring is transferred to the block in the form of kinetic energy.

When a block is pushed against the spring as shown in the above figure, the spring is compressed a distance x , the elastic potential energy stored in the spring is given by

$$U = \frac{1}{2}k x^2$$

When the block is released from rest, the spring exerts a force on the block and returns to its original length. The stored elastic potential energy is transformed into kinetic energy of the block, The elastic potential energy stored in a spring is zero whenever the spring is undeformed ($x = 0$). Energy is stored in the spring only when the spring is either stretched or compressed.

Furthermore, the elastic potential energy is a maximum when the spring has reached its maximum compression or extension (that is, when $x = x_{\max}$ is a maximum).

c) Gravitational potential energy (potential energy of position)

An object raised to a height has energy due to the position it is at. An object raised to a higher level has more gravitational potential energy. The gravitational potential energy of a mass m , at a height h , is: $PE = mgh$

Gravitational potential energy is the potential energy of the object–Earth system. This potential energy is transformed into kinetic energy of the system by the gravitational force.

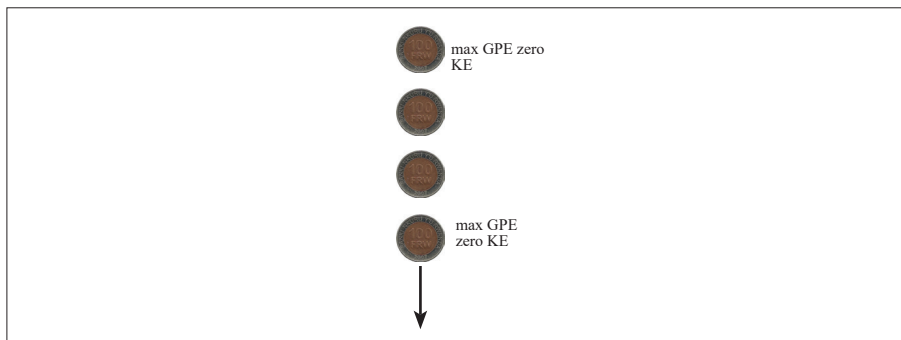
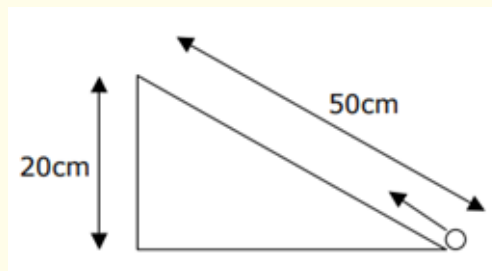

Figure 4.6: Showing change in energy as body falls

Application Activity 4.2

1. A box has a mass of 5.8 kg. The box is lifted from the garage floor and placed on a shelf. If the box gains 145 J of Potential Energy (E_p), how high is the shelf?
2. A man climbs on to a wall that is 3.6 m high and gains 2268 J of potential energy. What is the mass of the man?
3. A 800g ball is pulled up a slope as shown in the diagram below. Calculate the potential energy it gains.



4. Graph below shows relation between force (F) and the change in length (x). What is the spring potential energy based on graph below?

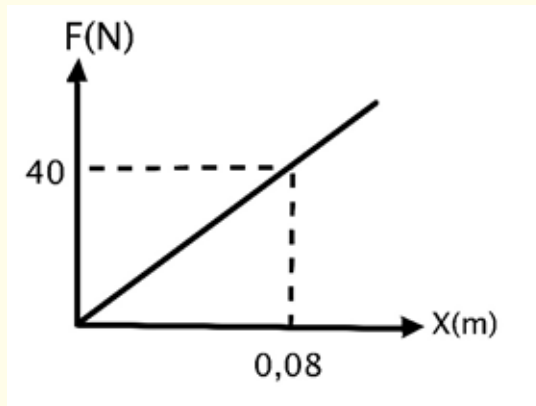

Kinetic energy

Kinetic energy is the form of energy possessed by moving bodies. Such bodies have the ability to do work e.g. a flying bullet can kill a dangerous wild animal. Wind (a moving mass of air) flowing streams, falling rocks, heat flowing from a body at high temperature to one at a lower temperature, electricity (flowing electrons), moving cars, lorries, busses, etc, all have kinetic energy. Kinetic energy of a body is dependent upon both the body's mass and speed.

Mathematically, $KE = \frac{1}{2} m v^2$

Work – Kinetic Energy Theorem

Suppose that a single constant force F acts on a particle in its direction of motion and causes it to accelerate, increasing the speed from an initial value u up to a final value v . recall that for an object with constant acceleration.

$$v^2 - u^2 = 2 a x \quad \text{knowing that } a = \frac{F}{m} \quad \text{then}$$

$$v^2 - u^2 = 2 \frac{F}{m} x \Leftrightarrow Fx = \frac{1}{2} m v^2 - \frac{1}{2} m u^2$$

$$\text{the work done by a force is } W = Fx \quad \text{so} \quad W = \frac{1}{2} m v_f^2 - \frac{1}{2} m v_i^2$$

According to the **work-kinetic energy theorem** if an external force acts upon a rigid object, causing its kinetic energy to change from KE_i to KE_f , then the mechanical work (W) is given by

$$W = \Delta KE = KE_f - KE_i = \frac{1}{2}mv_f^2 - \frac{1}{2}mv_i^2$$

where m is the mass of the object and v is the object's velocity

It can be stated in words: *the net work done on an object is equal to the change in its kinetic energy.*

Examples

1. A 145 g baseball is thrown with a speed of 25 m/s.
 - a) What is its kinetic energy?
 - b) How much work was done on the ball to make it reach this speed, if it started from rest?

Solution

- a) The kinetic energy is $K.E = \frac{1}{2}mv^2 = \frac{1}{2} \times 0.145 \times 25 = 45.3 \text{ J}$
- b) Since the initial kinetic energy was zero, the net work done is just equal to final kinetic energy is 45.3 J.

2. A block of mass 1.6 kg is attached to a horizontal spring that has a force constant of $1.0 \times 10^3 \text{ N/m}$, as shown in Figure below. The spring is compressed 2.0 cm and is then released from rest. Calculate the speed of the block as it passes through the equilibrium position $x = 0$ if the surface is frictionless.

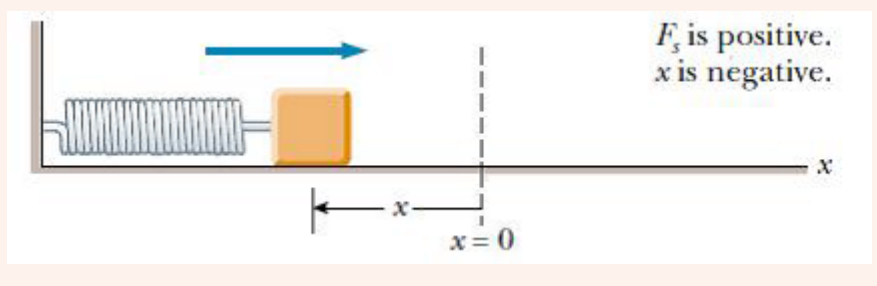

Solution

In this situation, the block starts with $U = 0$ at $x_i = -2.0\text{cm}$ we want to find v_f at $x_f = 0$ to find the work done by the spring with

$$x_f = x_i = 2.0\text{cm} = 0.02\text{m}$$

$$W_s = \frac{1}{2}kx^2 = \frac{1}{2}(1.0 \times 10^3)(0.02)^2 = 0.2\text{ J}$$

Using the work–kinetic energy theorem with $v_i = 0$, we obtain the change in kinetic energy of the block due to the work done on it by the spring

$$W_s = \frac{1}{2}m(v_f^2 - v_i^2) = \frac{1}{2}mv^2 \Leftrightarrow v = \sqrt{\frac{2W_s}{m}} = \frac{2 \times 0.2}{1.6} = 0.50\text{m/s}$$

Total Mechanical energy

Mechanical energy can be either kinetic energy (energy of motion) or potential energy (stored energy of position). Objects have mechanical energy if they are in motion and/or if they are at some position relative to a zero potential energy position (for example, a brick held at a vertical position above the ground or zero height position).

We call Mechanical energy is the sum of kinetic energy and all forms of potential energy associated with an object or group of objects i.e. $E = PE + KE$

Conservation of mechanical energy

If a body of mass m is thrown vertically upwards with an initial velocity v_0 at A, it has to do work against the constant force of gravity.

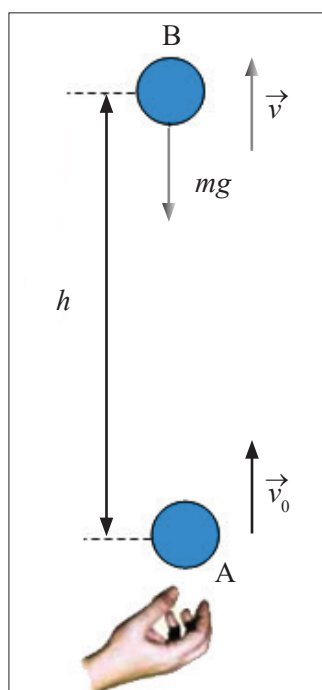

Figure 4.7: The loss of potential energy is the gain of kinetic energy

When it has risen to B, the velocity becomes v .

By definition of kinetic energy: loss of kinetic energy between A and B = work done against gravity

By definition of potential energy: gain of potential energy between A and B = work done against gravity. Then the loss of kinetic energy = gain of potential energy.

$$\frac{1}{2} mv_0^2 - \frac{1}{2} mv^2 = mgh, \text{ and we can write}$$

$$\Delta k.e = \Delta p.e$$

This is called the **principle of conservation of mechanical energy** and maybe stated as follows: **“The total amount of mechanical energy of an isolated body is a constant”**.

Example

A 6.0 kg block initially at rest is pulled to the right along a horizontal by a constant horizontal force of 12 N; Find the speed of the block after it has moved 3.0 m.

- If the surfaces in contact is frictionless surface.
- If the surfaces in contact have a coefficient of kinetic friction of 0.15.
- Suppose the force F is applied at an angle as shown in(Fig.b). At what angle should the force be applied to achieve the largest possible speed after the block has moved 3.0 m to the right?

Thus, the net external force acting on the block is the 12 N force. The work done by this force is

$$W = F \times d = \frac{1}{2}mv^2 = 12 \times 3 = 36J$$

Using the work–kinetic energy theorem and noting that the initial kinetic energy is zero, we obtain

$$W = F \times d = \frac{1}{2}mv^2 \Leftrightarrow v = \sqrt{\frac{2Fd}{m}} = \sqrt{\frac{2 \times 36}{6}} = 3.5m/s$$

- d) The normal force balances the gravitational force on the block, and neither of these vertically acting forces does work on the block because their points of application are displaced horizontally. The applied force does work:

$$w_{app} = F_{app} \times d = 12 \times 3 = 36J$$

The change in kinetic energy of the block due to friction is

$$w_f = -\mu mgd = 0.15 \times 6 \times 9.8 \times 3 = -26.5J$$

The final speed of the block

$$\frac{1}{2}mv_f^2 + \frac{1}{2}mv_i^2 = W_{app} + W_f \Leftrightarrow v_f = \sqrt{\frac{2(W_{app} + W_f)}{m}} = \sqrt{\frac{2(36 - 26.5)}{6}} = 1.8m/s$$

Power



Activity 8

Interpret the diagrams below



Figure 4.8: A man lifting heavy bags



Figure 4.9: Ladies digging

- * Have you ever done any of the two? If not, have you ever seen people doing such activities?
- * If yes, how long did you take to accomplish the work?

From all the observations, power is the work done per unit time. The concept power involved here is **the rate of doing work**. If an amount of work W is carried out a time t , the power for that time is defined to be: $p = \frac{W}{t}$

We can also express the power delivered to a body in terms of the force that acts on the body and its velocity. Thus, for a particle moving in one dimension, the relation above becomes:

$$p = \frac{W}{t} = \frac{Fx}{t}$$

In the case of uniform motion, $v = \frac{x}{t}$, then the power delivered is $p = Fv$

Units

The S.I unit of power is the *joule per second* (J/S). This unit is used so often that it has been given a special name, the *watt* abbreviated (W) and 1(W) =(J/S).

Definition: A watt is the power when one joule of work is done for a second.

The SI unit of power is the Watt (or J/s) in honor of James Watt (1736-1819). Thus $W=1J/s$

A larger unit called the **horsepower (hp)** is also used: $1 \text{ hp} = 736 \text{ W} = 0.736 \text{ kW}$

When the utility companies sell electric energy, they measure the energy sold in a unit called the kWh (kilowatt-hour). They do this because a joule is very small inconvenient unit for their purposes.

1 kWh is the total work done in 1 hour (3600 s) when the power is 1 kW (103 J/s), so

$$1 \text{ kWh} = (10^3 \text{ J/s})(3600 \text{ s}) = 3.6 \text{ MJ}$$

The kilowatt-hour is a unit of work or energy, not power. Our electricity bills carry the energy consumption in units of kWh.

Alternative Formulae for Power

$$P = \frac{dW}{dt} = \frac{F \cdot dS}{dt} = F \times v$$

Thus the power associated with force F is given by $P = F \cdot v$ where v is the velocity of the object on which the force acts.

$$\text{Thus } P = F \cdot v = F \times v \cos \theta$$

Special cases

$$\text{Power} = \text{work/time} = \text{Energy/time} = U/\text{time} = K/\text{time} = (mgh)/t = (1/2mv^2)/t$$

If a gun fires 'n' bullets each of mass 'm' with a velocity 'v' in 't' seconds, the power of the gun is given by

$$P = \frac{n\left(\frac{1}{2}mv^2\right)}{t}$$

The power of a machine is measured by the number of units of work it can do in one unit of time.

Examples

1. When a particle rotates in a circle, a force acts on it directed toward the center of rotation. Why is it that this force does no work on the particle?

Solution

The force is perpendicular to every increment of displacement. Therefore,

$$p = mv$$

2. Discuss whether any work is being done by each of the following agents and, if so, whether the work is positive or negative: (a) a chicken scratching the ground, (b) a person studying, (c) a crane lifting a bucket of concrete, (d) the gravitational force on the bucket in part (c), (e) the leg muscles of a person in the act of sitting down.

Solution

(a) Positive work is done by the chicken on the dirt. (b) No work is done, although it may seem like there is. (c) Positive work is done on the bucket. (d) Negative work is done on the bucket. (e) Negative work is done on the person's torso.

3. When a punter kicks a football, is he doing any work on the ball while his toe is in contact with it? Is he doing any work on the ball after it loses contact with his toe? Are any forces doing work on the ball while it is in flight?

Solution

Yes. Force times distance over which the toe is in contact with the ball. No, he is no longer applying a force. Yes, both air friction and gravity do work.

4. Cite two examples in which a force is exerted on an object without doing any work on the object.

Solution

Force of tension on a ball rotating on the end of a string. Normal force and gravitational force on an object at rest or moving across a level floor.

5. As a simple pendulum swings back and forth, the forces acting on the suspended object are the gravitational force, the tension in the supporting cord, and air resistance. (a) Which of these forces, if any, does no work on the pendulum? (b) Which of these forces does negative work at all times during its motion? (c) Describe the work done by the gravitational force while the pendulum is swinging.

Solution

a) Tension (b) Air resistance (c) Positive in increasing velocity on the downswing.

Negative in decreasing velocity on the upswing.

Linear momentum and impulse

Momentum

The **linear momentum** (or “momentum” for short) of an object is defined as the product of its mass and its velocity. Momentum (plural is *momenta*) is represented by the symbol \vec{p} . If we let m represent the mass of an object and \vec{v} represent its velocity, then its momentum \vec{p} is defined as

$$p = m\vec{v}$$

Velocity is a vector, so momentum too is a vector. The direction of the momentum is the direction of the velocity, and the magnitude of the momentum is $p = mv$. Because velocity depends on the reference frame, so does momentum; thus the reference frame must be specified. The unit of momentum is that of mass \times velocity, which in SI units is kg m/s. There is no special name for this unit.

Everyday usage of the term *momentum* is in accord with the definition above. According to the equation of momentum, a fast-moving car has more momentum than a slow-moving car of the same mass; a heavy truck has more momentum than a small car moving with the same speed. The more momentum an object has, the harder it is to stop it, and the greater effect it will have if it is brought to rest by striking another object. A football player is more likely to be stunned if tackled by a heavy opponent running at top speed than by a lighter or slower-moving tackler. A heavy fast-moving truck can do more damage than a slow-moving motorcycle.

Momentum (symbol: p) of an object is the product of the **mass** and **velocity** of a moving body.

Example

Calculate the linear momentum of the car in the figure below.

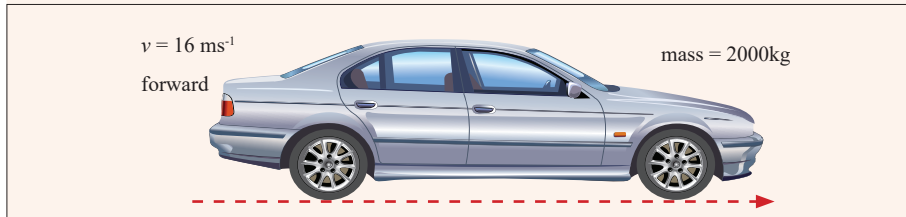
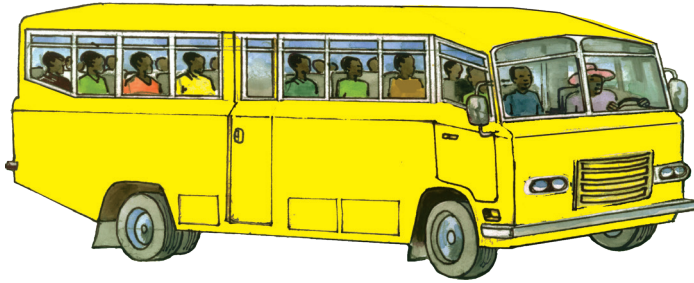

Figure 4.10: A car of mass m moves with velocity v

Solution

$$\begin{aligned}
 \text{Momentum } p &= m \cdot v \\
 &= (2000) (16) \\
 &= 32000 \text{kgms}^{-1} \text{ forwards} \\
 \text{Units: } &\text{kg} \cdot \text{m} \cdot \text{s}^{-1}.
 \end{aligned}$$

<p>If an object is at rest, it has no momentum no matter how large its mass. Momentum is not the same as inertia.</p> <p>Momentum = (Mass)(0) = 0</p>	<p>A bullet can have a large momentum even if it has a small mass, because it is moving at high velocity.</p> <p>(Mass) (velocity) = Momentum</p>



A bus can have a **large momentum** even if it is moving very slowly because it has a **large mass**

(Mass)(velocity) = Momentum

Figure 4.19: The linear momentum depends on the mass and velocity of the object

The linear momentum of a system of particles is the vector sum of the momenta of all the individual objects in the system:

$$\vec{p} = \sum_i^n m_i v_i = m_1 v_1 + m_2 v_2 + \cdots + m_n v_n$$

Where \mathbf{P} is the total momentum of the particle system, m_i and v_i are the mass and the velocity vector of the i^{th} object and n is the number of objects in the system.

Example

A 2250 kg pickup truck has a velocity of 25 m/s to the east. What is the momentum of the truck?

Solution

Given: $m = 2250 \text{ kg}$ $v = 25 \text{ m/s to the east}$ Unknown: $P = ?$

Use the momentum equation $P = mv = 2250 \times 25 = 5.6 \times 10^4 \text{ kg m/s to the east.}$

Conservation of momentum



Activity 9: Field work

As a class, visit a place with a pool table.
Let each and every body try to hit the ball using the playing stick.
What happens when one ball hits another?
State and observe what you notice.
Draw a conclusion.



Figure 4.12: A man hitting a billiard ball



Activity 10: Fieldwork

- * As a class, visit a place where there is billiard.
- * Try to arrange the balls with the help of your teacher or any of the learners who have ever played it.
- * Let one of you hit the white ball to strike/hit the rest.
- * State what you observe after the white ball has hit the balls.
- * Draw your conclusion from your observations.
- * Repeat the same procedures using balls in the play grounds.

Suppose that a moving Ball A on the pool table of mass m_1 and velocity \vec{v}_1 collides with another ball B, of mass m_2 and velocity \vec{v}_2 , moving in the same direction:

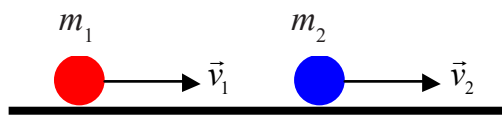

Figure 4.14: Two objects in motion having different speeds

From Newton's third law, the force F exerted by A on B is equal and opposite to that exerted by B on A. Also the time t during which the force acted on B is equal to the time during which the force of reaction acted on A.

So, if \vec{p}_1 is the momentum of A and \vec{p}_2 the momentum of B, we can write before collision: $\vec{p}_1 = m_1\vec{v}_1$ and $\vec{p}_2 = m_2\vec{v}_2$

The momentum of the system constituted by the two masses is

$$\vec{p} = \vec{p}_1 + \vec{p}_2, \quad \vec{p} = m_1\vec{v}_1 + m_2\vec{v}_2$$

Suppose that after collision, the velocity of A becomes \vec{v}_1' and the one of B becomes \vec{v}_2' .

$$\text{So } \vec{p}_1' = m_1\vec{v}_1' \text{ and } \vec{p}_2' = m_2\vec{v}_2'$$

$$\vec{p}' = \vec{p}_1' + \vec{p}_2', \text{ and } \vec{p}' = m_1\vec{v}_1' + m_2\vec{v}_2'$$

$$\vec{p} = \vec{p}' \Rightarrow m_1\vec{v}_1 + m_2\vec{v}_2 = m_1\vec{v}_1' + m_2\vec{v}_2'$$

$$m_2\vec{v}_2' - m_2\vec{v}_2 = -m_1\vec{v}_1' + m_1\vec{v}_1$$

$$m_2(\vec{v}_2' - \vec{v}_2) = -m_1(\vec{v}_1' - \vec{v}_1) \Rightarrow m_2(\Delta\vec{v})_2 = -m_1(\Delta\vec{v})_1$$

The principle of conservation of the linear momentum law states that: *"If no external forces act on a system of colliding objects, the total momentum of the objects in a given direction before collision equals to the total momentum in same direction after collision"*.

Application activity 4.3

Truck Collision

Study the pictures below carefully

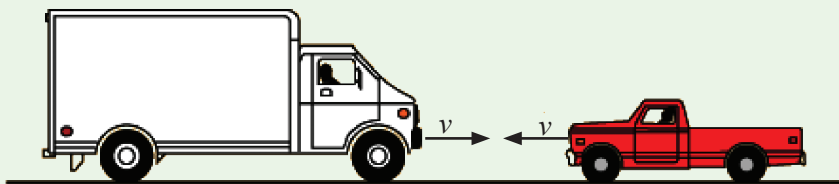

Figure 4.13: Two trucks moving towards one another

In a head-on collision:

1. Which truck will experience the greatest force?
2. Which truck will experience the greatest change in momentum?
3. Which truck will experience the greatest change in velocity?
4. Which truck will experience the greatest acceleration?
5. Which truck would you rather be in during the collision?

Impulse



Activity 11

- * Move out the class to the play ground.
- * In pairs (one pair at a time), kick a ball so that it is moving with a low speed. Let your friend stop it. Ask him/her what he/she felt. Let your friend do the same.
- * For the second time, make sure that you kick the ball by applying a strong force so that it moves faster. Let your friend try to stop it. Ask him/her what this time he/she has felt?
- * Go back in class and summarise what you observed and felt while in the play ground.

Definition

If one exerts a force \vec{F} on moving a object in time t , the velocity of the object changes. We say that its momentum changes too. **The product of the force \vec{F} and the time t in which it acts is called *impulse* represented by \vec{I} . $\vec{I} = \vec{F} \times \Delta t$**

In S.I units, the unit of impulse is Newton-second [Ns].



Figure 4.15: Air-bags in automobiles have saved countless lives in accidents. The air-bag increases the time interval during which the passenger is brought to rest

Application activity 4.4

A ball of mass of 0.4kg is thrown against a brick wall. It hits the wall moving horizontally to the left with a velocity of 10 m/s and rebounds to the right.

- Find the Impulse of the net force on the ball during its collision with the wall.
- If the ball is in contact with the wall for 0.01s, find the average force that the wall exerts on the ball during the collision.

Relationship between impulse and momentum

Suppose a force F acts on a body of mass m and gives it an acceleration a , the relationship between impulse and momentum can be seen by using Newton's second law.

From Newton's second law,

$$\vec{F} = m\vec{a}, \quad \vec{a} = \frac{\Delta\vec{v}}{\Delta t} \text{ then } \vec{F} = \frac{m\Delta\vec{v}}{\Delta t} \Rightarrow \vec{F}\Delta t = m\Delta\vec{v}$$

$$\vec{I} = \vec{F}\Delta t \text{ and } \Delta\vec{p} = m\Delta\vec{v}$$

$$\text{So } \vec{I} = \Delta\vec{p}$$

The impulse is equal to the total change of momentum.

Example

A 1400 kg car moving westward with a velocity of 15 m/s collides with a utility pole and is brought to rest in 0.3 s. Find the magnitude of the force exerted on the car during the collision.

Solution

$$F = \frac{m(\vec{v}_f - \vec{v}_i)}{\Delta t} = -70000 \text{ N}$$

The force is 70000N to the east.

Applications

Slow down of a moving object by a constant force

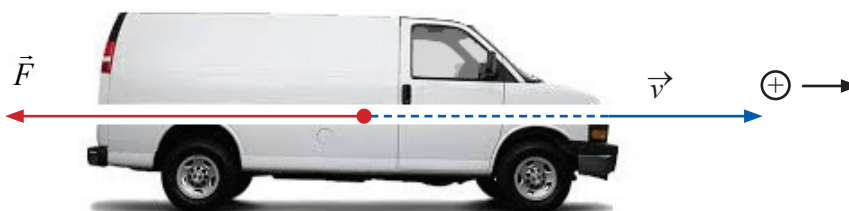

Figure 4.16: The velocity and the force have opposite directions

Let us consider a rectilinear uniform motion of velocity v , of a moving object of mass m on which a retarding constant force acts parallel to the path. Let t be the time. The impulse on the object is given by: Impulse = Ft

The final linear momentum is zero when the initial linear momentum is mv , its projection on the axis is given by:

$$\text{Linear momentum} = mv$$

Since the impulse is equal to change of momentum, it follows that $Ft = 0 - mv$, then $t = m \frac{v}{F}$.

Recoil back of a rifle

Suppose a bullet of mass m , is, fired from a rifle of mass M with velocity \vec{V} . Initially the total linear momentum is zero. From the principle of the conservation of linear momentum, when the bullet is fired, the total momentum of bullet and rifle is still zero, since external force has acted on them. So if \vec{v} is the velocity of the rifle, we write: $M\vec{v} + m\vec{V} = \vec{0}$

Considering magnitude, we write $0 = -Mv + mV$ because \vec{v} and \vec{V} are in the opposite direction.

Then: $\frac{v}{V} = \frac{m}{M}$

Thus, if a rifle of mass M throws a bullet of mass m with a speed V , it moves back with a velocity: $v = \frac{m}{M}V$

WORK

Carefully interpret the diagram below.

Why do you think after firing the cap of soldier moved away from his head?

Again, do you think that the soldier remained in same position as he was in before? Explain your answer.

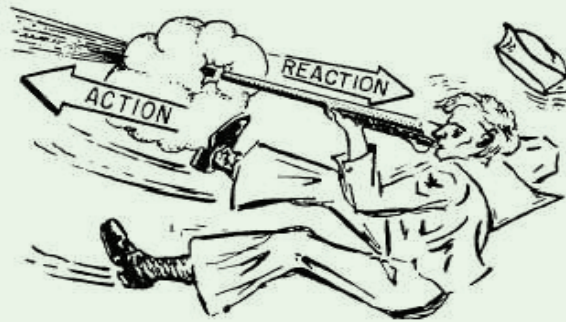

Figure 4.17: Firing the rifle and the bullets move in opposite directions

Application activity 4.5

- Two bodies of mass 3kg and 5kg travelling in opposite directions on a horizontal surface collide. The velocities of the bodies before collision are 6m/s and 5m/s respectively. Given that after collision the two separate and move in the same direction in which the 5kg body was moving before collision, and the velocity of the 5kg mass is 1m/s, find the speed of the 3kg body after impact. Find also the loss in the energy.
- A body of mass 2kg initially moving with a velocity of 1m/s is acted upon by a horizontal force of 6N for 3seconds. Find
 - Impulse given to the body
 - Final speed of the body

Collisions



Activity 12

To know what happens to bodies after impact/colliding.

To know the effect of collision on the velocities and masses of bodies after colliding.

Observe the diagram below carefully assuming the black car to have a larger mass than a white one and answer the questions that follow.



Figure 4.18: Collision of two vehicles

Questions about the picture above:

- Do you think after collision, the two cars continue moving? Explain why?
- From what you observed, what is the effect of collision?
- After separating the cars, do you think the masses of the cars changed? Explain why.

Note: We can define collision as an interaction between bodies in which the time intervals during which the bodies interaction is small relative to the time for which we can observe them.

In collision the total momentum of colliding objects is always conserved. Usually, however, their total kinetic energy is not conserved; some of it is changed to heat or sound energy, which is recoverable. **Such collisions are said to be inelastic.**

For example, when a lump of putty falls to the ground, the total momentum of putty and earth is conserved, that is, the putty loses momentum and the earth gains an equal amount of momentum. But all the kinetic energy of putty is changed to heat and sound on collision.

An **Inelastic collision is the collision where the total kinetic energy is not conserved** (total momentum always conserved in any type of collision). If the total kinetic energy is conserved, the collision is said to be *elastic*. **For example, the collision between two smooth smoker balls is approximately elastic.**

Elastic collision

In here, we shall consider objects colliding in a straight line and thereafter they move with different speeds in the same direction.

Elastic collision in one dimension

Let m_1 and m_2 be masses of two objects moving with speeds \vec{v}_1 and \vec{v}_2 .

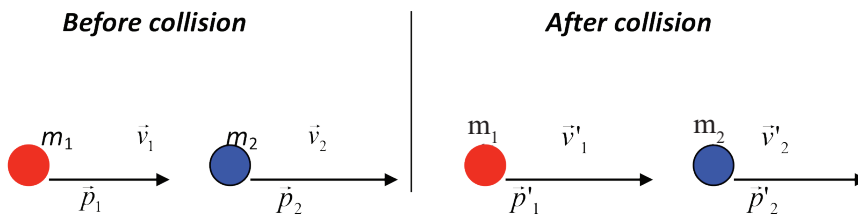

Figure 4.19: Diagram of two objects before and after collision

For a body of mass m moving with a velocity v , the kinetic energy is given by the relation $k.e = \frac{1}{2}mv^2$ and for a system of particles, the total kinetic energy is: $k.e = \sum_i k.e_i$. Then we have:

Before collision:

$$p = \Sigma p_i = m_1v_1 + m_2v_2 \quad (1)$$

$$k.e = \Sigma k.e_i = \frac{1}{2} m_1v_1^2 + \frac{1}{2} m_2v_2^2 \quad (2)''$$

After collision

$$p' = \Sigma p'_i = m_1v'_1 + m_2v'_2 \quad (3)$$

$$k.e' = \Sigma k.e'_i = \frac{1}{2} m_1v'^2_1 + \frac{1}{2} m_2v'^2_2 \quad (4)''$$

The collision being elastic: $p = p'$ and $K.e = K.e'$

$$\begin{cases} m_1 v_1 + m_2 v_2 = m_1 v'_1 + m_2 v'_2 \\ \frac{1}{2} m_1 v_1^2 + \frac{1}{2} m_2 v_2^2 = \frac{1}{2} m_1 v'^2_1 + \frac{1}{2} m_2 v'^2_2 \end{cases}$$

$$\Rightarrow \begin{cases} m_1 v_1 + m_2 v_2 = m_1 v'_1 + m_2 v'_2 \\ m_1 v_1^2 + m_2 v_2^2 = m_1 v'^2_1 + m_2 v'^2_2 \end{cases}$$

$$\begin{cases} m_1(v_1 - v'_1) = m_2(v'_2 - v_2) \\ m_1(v_1^2 - v'^2_1) = m_2(v'^2_2 - v_2^2) \end{cases}$$

$$\Rightarrow \begin{cases} m_1(v_1 - v'_1) = m_2(v'_2 - v_2) & (1)' \\ m_1(v_1 - v'_1)(v_1 + v'_1) = m_2(v'_2 - v_2)(v'_2 + v_2) & (2) \end{cases}$$

Dividing (2) and (1), we get:

$$\frac{m_1(v_1 - v'_1)(v_1 + v'_1)}{m_1(v_1 - v'_1)} = \frac{m_2(v'_2 - v_2)(v'_2 + v_2)}{m_2(v'_2 - v_2)}$$

$$v'_2 = v_1 + v'_1 - v_2$$

$$\text{Then we have: } \begin{cases} v'_2 = v_1 + v'_1 - v_2 \\ m_1 v_1 + m_2 v_2 = m_1 v'_1 + m_2 v'_2 \end{cases}$$

$$\Rightarrow m_1 v_1 + m_2 v_2 = m_1 v'_1 + m_2(v'_1 + v_1 - v_2)$$

$$\Rightarrow m_1 v_1 + m_2 v_2 = m_1 v'_1 + m_2 v'_1 + m_2 v_1 - m_2 v_2$$

$$\Rightarrow m_1 v_1 + 2m_2 v_2 = v'_1(m_1 + m_2) + m_2 v_1$$

$$\Rightarrow v'_1(m_1 + m_2) = m_1 v_1 + 2m_2 v_2 - m_2 v_1$$

$$\Rightarrow v'_1 = \frac{m_1 v_1 + 2m_2 v_2 - m_2 v_1}{(m_1 + m_2)}$$

$$\Rightarrow v'_1 = \frac{(m_1 - m_2)v_1 + 2m_2 v_2}{m_1 + m_2}$$

In the same way, we can find v_2 with $v_1 = v_2 + v_2 - v_1$ and it's shown that:

$$v'_2 = \frac{m_2 v_2 + 2m_1 v_1 - m_1 v_2}{(m_1 + m_2)}$$

$$\Rightarrow v'_2 = \frac{(m_2 - m_1)v_2 + 2m_1v_1}{m_1 + m_2}$$

Notice: If $m_1 = m_2$, $v_2 = 0$ then $v'_1 = 0$ and $v'_2 = v_1$.

Special cases:

- Consider the case when the mass of one body, is equal to that of the other. And the particle 2 is initially at rest, when they collide the velocity of the first become zero and the velocity of the second is equal to the velocity of the first one before collision.

$$\text{i.e. } m_1 = m_2 \text{ and } v_1 = v'_2 \text{ and } v'_1 = 0$$

- if $m_1 \gg m_2$ and $v_2 = 0$ so that $v'_1 \approx v_1$ and $v'_2 \approx 2v_1$

That is a heavy particle collides with head-on with a light one that is at rest, heavy particle continue its motion unaltered after the collision and the light particle rebounds with a speed equal to about twice the initial speed of the heavy particle. an example of such collision would be that of the moving heavy atom such as uranium striking a light atom such as hydrogen.

- if $m_2 \gg m_1$ and $v_2 = 0$ so that $v'_1 \approx -v_1$ and $v'_2 \approx 0$

That is a light particle collides with head-on with a heavy one that is at rest, heavy particle remain approximately at rest, the light particle has a velocity reversed.

Example is that a golf ball hitting a brick wall. The wall remains at rest, and the ball bounces back with its speed unchanged.

Example

A Ball of 0.1kg makes an elastic head-on collision with a ball of unknown mass that is initially at rest. If the 0.1 kg ball rebounds at one third of its original speed. what is the mass of the other ball?

Solution

$$V_1' = \left(\frac{m_1 - m_2}{m_1 + m_2}\right)v_1 + \left(\frac{2m_2}{m_1 + m_2}\right)v_2$$

$$-\frac{1}{3}V_1 = \left(\frac{m_1 - m_2}{m_1 + m_2}\right)V_1 + 0$$

$$-\frac{1}{3} = \left(\frac{0.1 - m_2}{0.1 + m_2}\right) \Leftrightarrow m_2 = 0.2 \text{ kg}$$

Elastic collision in two or three dimensions

To understand this, use billiards as shown in the previous lesson



Figure 4.20: A man hitting a billiard ball

Some times after hitting the balls, they do not move in a straight line most especially (those who know how to play it) when you want to score in the centre hole. You must make sure that you hit the ball in target so that it moves at a certain angle.

Activity 13



- Try to hit a billiard ball as shown in figure above.
- Observe what happens when one ball hits another.
- Note down your observations.
- Present your findings/observation to the whole class.

On Striking the balls ,energy and momentum is conserved.

Conservation of momentum and energy can also be applied to collisions in two or three dimensions and in this case the vector nature of momentum is important.

One common type of non-head-on collision is one for which one particle (called the “projectile”) strikes a second particle initially at rest (the “tangent” particle). This is the common situation in games such as billiards.

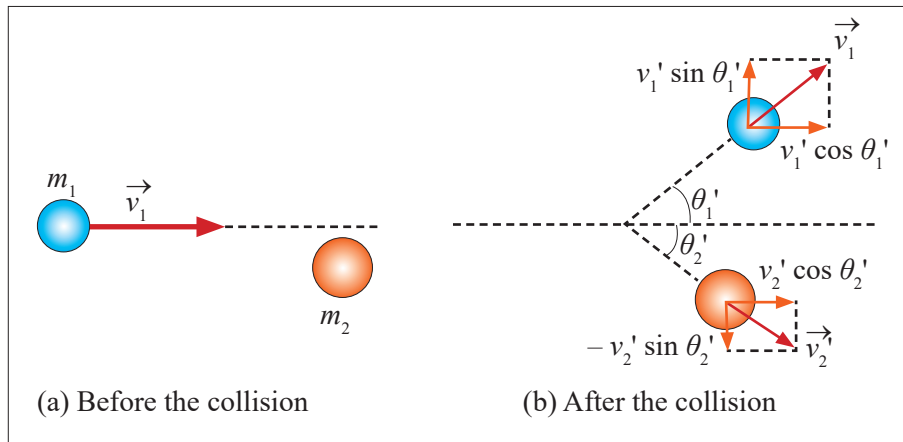

Figure 4.21: Diagram of collision in two dimensions

The figure 4.21 shows particle 1 (the projectile m_1) heading along the x-axis towards particle 2 (the tangent m_2) which is initially at rest. If these are, say, billiard balls, m_1 strikes m_2 and they go off at angles θ_1' and θ_2' , which are measured relative to m_1 's initial direction (the x-axis)

Let us now apply the conservation of momentum and kinetic energy for an elastic collision like that on figure above. From conservation of kinetic energy, since $v_2=0$, we have:

$$\frac{1}{2} m_1 v_1^2 = \frac{1}{2} m_1 v_1'^2 + \frac{1}{2} m_2 v_2'^2 \quad (1)$$

We choose the xy plane to be the plane in which lie the initial and final momenta. Since momentum is a vector, and is conserved, its components in x and y directions remain constant. In the x direction

$$m_1 v_1 = m_1 v_1' \cos \theta_1' + m_2 v_2' \cos \theta_2' \quad (2)$$

Since there is no motion in the y direction initially, the y component of the total momentum is zero:

$$0 = m_1 v_1' \sin \theta_1' + m_2 v_2' \sin \theta_2' \quad (3)$$

We have three independent equations. This means we can solve for utmost three unknowns. If we are given m_1 , m_2 , v (and v_2 , if not zero), we cannot uniquely predict the final variables v_1' , v_2' , θ_1' and θ_2' , since there are four of them, θ_2' , for example, can be anything. However, if we measure one of these variables, say θ_1' , then the other three variables (v_1' , v_2' , and θ_2') are uniquely determined and we can calculate them using the above three equations.

Example

The figure shows an elastic collision of two pucks on a friction air hockey table. Puck A has mass $m_A=0.500\text{kg}$ and B has mass $m_B=0.300\text{kg}$. Puck A has an initial velocity of 4.00m/s in the positive-direction and a final velocity of 2.00m/s in unknown direction. Puck B is initially at rest. Find the final velocity V_{2B} of puck B and the angle α and β in the figure.

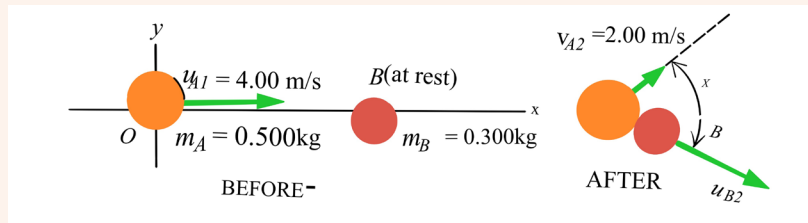

Solution

Because the collision is elastic, the initial and final kinetic energies are equal:

$$\frac{1}{2} m_A v_A^2 = \frac{1}{2} m_A v_{Af}^2 + \frac{1}{2} m_B v_{Bf}^2$$

$$v_{Bf}^2 = \frac{m_A v_A^2 - m_A v_{Af}^2}{m_B}$$

$$v_{Bf} = 4.47 \text{ m/s}$$

conservation of the X- Component of the total momentum gives

$$m_A v_{Ax} = m_A v_{Af x} + m_B v_{Bf x}$$

$$(0.500)(4.00) = (0.500)(2.00)(\cos \alpha) + (0.300)(4.47)(\cos \beta) \quad (\text{Equ.1})$$

conservation in Y-component gives

$$0 = m_A v_{Af y} + m_B v_{Bf y}$$

$$0 = (0.500)(2.00)(\sin \alpha) - (0.300)(4.47)(\sin \beta) \quad (\text{Equ.2})$$

these are two simultaneous equation for α and β . Solve those equation by using different methods we get

$$\alpha = 36.9^\circ \text{ and } \beta = 26.6^\circ$$

Note that: A quick way to check the answers is to make sure that the Y-momentum, which was zero before collision, is still zero after the collision. The Y-momenta of the pucks are:

$$P_{A2Y} = (0.500)(2.00)(\sin 36.9^\circ) = +0.600 \text{ Kg.m / s}$$

$$P_{B2Y} = -(0.300)(4.47)(\sin 26.6^\circ) = -0.600 \text{ Kg.m / s}$$

the sum of these values is zero, as it should be.

Inelastic collision

Collisions in which kinetic energy is not conserved are called inelastic collisions. Some of the initial kinetic energy in such collisions is transformed into other types of energy, such as thermal or potential energy.

A common example of a **perfectly inelastic** collision is when two objects collide and then stick together afterwards and move with a common velocity after colliding.

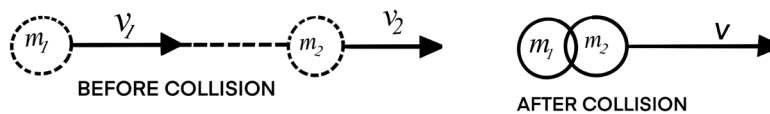

Apply the conservation of momentum

$$m_1 v_1 + m_2 v_2 = (m_1 + m_2) V$$

call the **coefficient of restitution**, e for a one-dimensional collision, the ratio of relative speed after impact and relative speed before impact:

$$e = \frac{v_{2f} - v_{1f}}{v_{1i} - v_{2f}}$$

Coefficient of restitution,

$$e = \frac{\text{velocity of separation after collision}}{\text{velocity of approaching before collision}} = \frac{v_{2f} - v_{1f}}{v_{1i} - v_{2f}}$$

For : An elastic collision, $e = 1$

An inelastic collision, $0 \leq e < 1$, $e = 0$ with for sticking after collision.

Examples

1. The figure below show two particles moving in opposite direction. find the commun velocity after collision, the initial and final kinetic energies of the system.

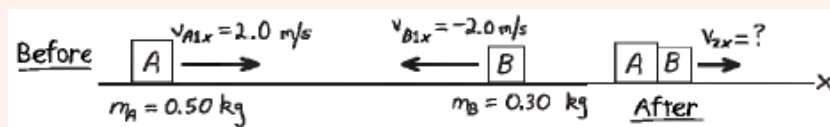

Solution

From conservation of the X-component of momentum

$$\begin{aligned} m_A v_A + m_B v_B &= (m_A + m_B) v_{2X} \\ v_{2X} &= \frac{m_A v_A + m_B v_B}{m_A + m_B} \\ &= \frac{(0.50)(2.0) + (0.30)(-2.0)}{0.50 + 0.30} \\ &= 0.50 \text{ m/s} \end{aligned}$$

the commun velocity is positive, the griders move together to the right(in the X-direction).

Before collision the kinetic energies of the griders A and B are:

$$\begin{aligned} K_A &= \frac{1}{2} m_A v_{AX}^2 = \frac{1}{2} (0.50)(2.00)^2 = 1.0 \text{ J} \\ K_B &= \frac{1}{2} m_B v_{BX}^2 = \frac{1}{2} (0.30)(-2.00)^2 = 0.60 \text{ J} \end{aligned}$$

The total kinetic energies before collision is 1.6J

The kinetic energy after collision is

$$\frac{1}{2} (m_A + m_B) v_{2X}^2 = \frac{1}{2} (0.50 + 0.30)(0.50)^2 = 0.20 \text{ J}$$

2. An Object A of mass 2 kg is moving with a velocity of 3 m/s and collides head on with an object B of mass 1 kg moving in the opposite direction with a velocity of 4 m/s. After collision both objects sticks, so that they move with a common velocity v . calculate v .

Solution

Answer: $v = \frac{2}{3} \text{ m/s}$

3. A 1 800 kg car stopped at a traffic light is struck from the rear by a 900 kg car, and the two become entangled, moving along the same path as that of the originally moving car. If the smaller car were moving at 20.0 m/s before the collision, what is the velocity of the entangled cars after the collision?

Solution

The phrase “become entangled” tell us that this is a perfectly inelastic collision.

Answer: $v=6.67\text{m/s}$

Other examples of collision

The Ballistic Pendulum

1. The ballistic pendulum (seen figure below) is an apparatus used to measure the speed of a fast-moving projectile, such as a bullet. A bullet of mass m_B is fired into a large block of wood of mass m_W suspended from some light wires and makes a completely inelastic collision with it. The bullet embeds in the block, and the entire system swings through a height h . How can we determine the speed of the bullet from a measurement of h ??

Solution

Let configuration (A) be the bullet and block before the collision, and configuration (B) be the bullet and block immediately after colliding.

The bullet and the block form an isolated system, so we can categorize the collision between them as a conservation of momentum problem.

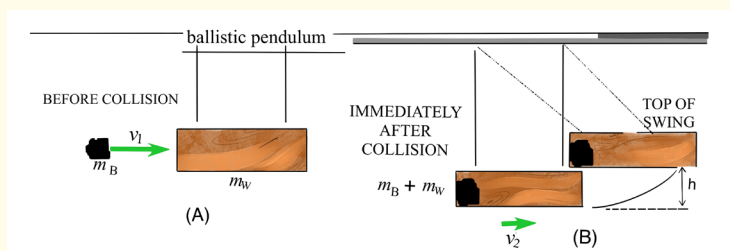

Figure 4.22: Diagram of a ballistic pendulum

Note that v_1 is the velocity of the bullet just before the collision and v_2 is the velocity of the bullet-block system just after the perfectly inelastic collision.

The collision is perfectly inelastic collision; the law of conservation of linear momentum gives the speed of the system right after the collision. Noting that $v_w = 0$. Then

$$m_B v_1 = (m_B + m_w) v_2$$

$$v_2 = \frac{m_B v_1}{m_B + m_w}$$

The kinetic energy of block-bullet is $K = \frac{1}{2} (m_B + m_w) v_2^2$. This is less than the kinetic energy before collision, the collision is inelastic, the block-bullet is swing up and comes to rest for an instant at a height h , where the kinetic energy is zero and the potential energy is $(m_B + m_w)gh$; it then swing back down. The energy conserved gives

$$K = \frac{1}{2} (m_B + m_w) v_2^2 = (m_B + m_w)gh \Leftrightarrow v_2 = \sqrt{2gh}$$

now substitute this expression into the momentum equation to find an expression for the variable

$$v_1 = \left(\frac{m_B + m_w}{m_B} \right) \sqrt{2gh}$$

- Let's check our answers by plugging in some realistic numbers. If $m_B = 5.00 \text{ g} = 0.005 \text{ kg}$, $m_w = 2.00 \text{ kg}$ and $h = 3.00 \text{ cm} = 0.03 \text{ m}$, find: the initial speed of the bullet, the speed of the block just after impact, and kinetic energy before and after impact?

Solution

The initial speed of the bullet is

$$v_1 = \left(\frac{m_B + m_w}{m_B} \right) \sqrt{2gh}$$

$$v_1 = \frac{(0.005 + 2.00)}{0.005} \sqrt{2(9.8)(0.03)} = 307.5 \text{ m/s}$$

The speed of the block just after impact is

$$v_2 = \sqrt{2gh} = \sqrt{2(9.8)(0.03)} = 0.767 \text{ m/s}$$

Kinetic energy just before impact is

$$K = \frac{1}{2} (0.005)(307.5)^2 = 236.4 \text{ J}$$

Kinetic energy of bullet and block just after impact is

$$K = \frac{1}{2} (2.005)(0.767)^2 = 0.589 \text{ J}$$

Nearly all kinetic energy disappears as the wood splinters and the bullet and block become hotter.

An automobile collision

A 1000Kg compact car is travelling North at 15 m/s when it collides with a 2000 kg truck travelling East at 10m/s. all occupants are wearing seat belts are there are no injuries, but the two vehicles are thoroughly tangled and move away from the impact point as one mass. The insurance adjustor has asked you to find the velocity of the wreckage just after the impact. What do you tell her? The figure below show the situation

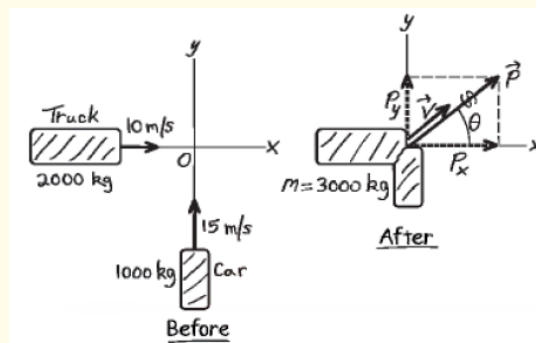

the total momentum along x-axis

$$\begin{aligned}
 P_X &= P_{CX} + P_{TX} = m_C v_{CX} + m_T v_{TX} \\
 &= (1000)(0) + (2000)(10) \\
 &= 2.0 \times 10^4 \text{ Kg.m / s}
 \end{aligned}$$

$$\begin{aligned}
 P_Y &= P_{CY} + P_{TY} = m_C v_{CY} + m_T v_{TY} \\
 &= (1000)(15) + (2000)(0) \\
 &= 1.5 \times 10^4 \text{ Kg.m / s}
 \end{aligned}$$

The magnitude of \vec{P} is

$$P = \sqrt{(2.0 \times 10^4)^2 + (1.5 \times 10^4)^2} = 2.5 \times 10^4 \text{ Kg.m / s}$$

and its direction is given by the angle

$$\begin{aligned}
 \tan \theta &= \frac{P_Y}{P_X} = \frac{1.5 \times 10^4}{2.0 \times 10^4} = 0.75 \\
 \theta &= 37^\circ
 \end{aligned}$$

The total momentum before collision is the same as just after collision. the total mass $M = m_C + m_T = 3000 \text{ Kg}$ and $P = M.V$. The direction of V just after collision is the same as that of the momentum and its magnitude is

$$V = \frac{P}{M} = \frac{2.5 \times 10^4}{3000} = 8.3 \text{ m / s}$$

If the velocities of the two objects make a certain angle before collision and after collision they stick together, analytically we have this situation:

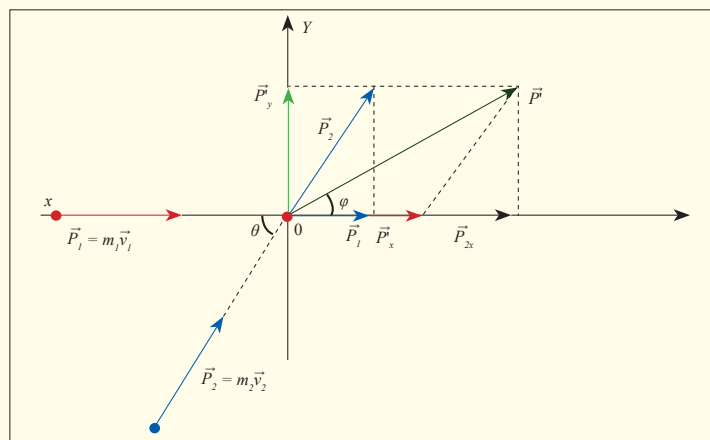

Figure 4.22: The velocity and the force have opposite directions

There is no conservation of kinetic energy; there is only conservation of momentum. $\vec{P} = \vec{p}_1 + \vec{p}_2 = \vec{P}' = (m_1 + m_2) \vec{v}'$

If there is no change of direction, we have:

$$p' = \sqrt{p_x^2 + p_y^2}$$

$$\text{With: } \begin{cases} p_x = p_1 + p_2 \cos \theta \\ p_y = 0 + p_2 \sin \theta \end{cases} \Rightarrow \begin{cases} p_x = p_1 + p_2 \cos \theta \\ p_y = p_2 \sin \theta \end{cases}$$

$$\text{We have: } v' = \frac{p'}{m_1 + m_2}$$

This velocity v' is the magnitude of the common velocity after collision.

It's directed through an angle φ given by: $\tan \varphi = \frac{p_y}{p_x}$

This angle is the angle formed by the direction of the common velocity and the initial direction of \vec{p}_1 .

END UNIT ASSESSMENT

“Work, Energy and Power”

1. A worker lifts up a stone of 3.5kg to a height of 1.80m each 30s. Find the work done in one hour.
2. Calculate the kinetic energy and the velocity required for a 70kg pole vaulter to pass over a 5.0m high bar. Assume the vaulter's centre of mass is initially 0.90m off the ground and reaches its maximum height at the level of the bar itself.
3. Calculate the power required of a 1400 kg car under the following circumstances
 - a) The car climbs a 10° hill at a steady 80km/h and
 - b) The car accelerates from 90 to 110km/h in 6.0s to pass another car on a level road. Assume the force of friction on the car is 700N in both parts of the problem.
4. A woman of mass 75kg walks up a mountain of height 20m.
 - a) What is the work done?
 - b) The walking up being done in 1.5 min, find the power,
 - c) What time will be taken by this woman to walk up the 20m in order to develop a power of 73W?

5. A stone of 2000kg falls from the top of a tower of height $H = 200\text{m}$. What is the total mechanical energy? What is the $P.e$ at height $h = \frac{H}{2}$ and its $K.e$?
6. An object of 2kg falls freely during 5s. What is the kinetic energy? What will be the kinetic energy if the object is thrown downward with the speed of 4m/s? $g = 10\text{m/s}^2$.
7. A small object A_0 of mass 50g is suspended by a string of 80cm of length of negligible mass. It's moved away from the equilibrium position to the point A. The angle A_0OA being 60° , what is the change of the potential energy.

Linear momentum and impulse

1. What is the momentum of an 18.0g sparrow flying with a speed of 15.0m/s?
2. A moving object has an acceleration of 2.4m/s^2 . It reaches in 12s a momentum of 800kgm/s. Compute the mass of that object and the force acting on it.
3. An object of mass 200g slides without friction on a horizontal surface and strikes a vertical obstacle and moves back following the same direction with a speed of 11m/s Find the impulse.
4. An object of mass $m = 100\text{g}$ falls freely during 3s:
 - a) Find the received impulse,
 - b) Deduce the change of the speed.
 - c) Generalize to find the law of the free fall $h = \frac{1}{2}gt^2$
5. One drops a ball of mass m from a height h_0 above the ground. The ball bounces till the point situated at the height h_1 . Find the impulse received by the ball from the ground. Given that $h_0 = 2.55\text{m}$, $h_1 = 2\text{m}$, $m = 0.2\text{kg}$, $g = 10\text{m/s}^2$.
6. A 10,000kg railroad car travelling at a speed of 24.0m/s strikes an identical car at rest. If the cars lock together as result of collision, what is their common speed afterward?
7. Calculate the recoil back velocity of 4.0kg rifle which shoots a 0.050kg bullet at a speed of 280m/s.

Collisions

- Two objects of masses m_1 and m_2 slide on a horizontal table without friction. The first has a speed \vec{v}_1 and the second has a speed \vec{v}_2 . They strike together. Assuming that the collision is elastic, find speeds v_1' and v_2' after collision in the following cases:
 - \vec{v}_1' and \vec{v}_2' have the same direction,
 - \vec{v}_1' and \vec{v}_2' have opposite direction.
- A proton travelling with a speed $8.2 \times 10^5 \text{ m/s}$ collides elastically with a stationary proton in a hydrogen target. One of the protons is observed to be scattered at a 60° angle. At what angle will the second proton be observed, and what will be the velocities of the two protons after the collision?
- A 15,000kg railroad car travels alone on a level frictionless track with a constant speed of 23.0m/s. A 5000kg additional load is dropped onto the car. What then will be its speed?
- A 90kg fullback is travelling 5.0m/s and is stopped by a tackler in 1s. Calculate (a) the original momentum of the fullback, (b) the impulse imparted to the tackler and (c) the average force exerted on the tackler.
- A billiard ball of mass $m_A = 0.400\text{kg}$ moving with a speed $v_A = 200\text{m/s}$ strikes a second ball, initially at rest, of mass $m_B = 0.400\text{kg}$. As a result of the collision, the first is deflected off at an angle of 30° with a speed of $v_A = 1.20\text{m/s}$. (a) Taking the x to be the original direction of motion of ball A, write down the equations expressing the conservation of momentum for the components in the x and y directions separately, (b) solve these equations for the speed, v_B , and angle α , of ball B. Assume the collision is elastic.
- Two billiard balls of equal mass move at right angles and meet at the origin of an xy coordinates system. One is moving upward along the y axis at 3.00m/s, the other is moving to the right along the x axis with a speed of 4.80m/s. After the collision (assumed elastic), the second ball is moving along the positive y axis. What is the final direction of the first ball, and what are their two speeds?
An explosion breaks a block of stone in three pieces A, B and C of respective masses m_1 , m_2 and m_3 . Immediately after explosion the speeds $v_1=15\text{m/s}$, $v_2=7\text{m/s}$ and $v_3=50\text{m/s}$. Vectors \vec{v}_1 and \vec{v}_2 form a right angle. Assuming that $m_1=1.5\text{kg}$ and $m_2=3\text{kg}$, determine the direction of \vec{v}_3 and m_3 .

Group work

1. Two masses $m_1 = 5\text{Kg}$ and $m_2 = 10\text{Kg}$ have velocities $u_1 = 2\text{m/s}$ according to x positive axis and $u_2 = 4\text{m/s}$ according to y positive axis. They collide and they get stuck. What is the final velocity after collision?
2. A lorry of transport of goods is empty and has a mass of 10000kg . When the lorry moves at 2m/s on a horizontal plane, it collides another lorry loaded, of total mass 20000kg ; this last being initially at rest but with released breaks. If the two Lorries stuck together, after collision, what is their speed after collision?

3. a) With which velocity the loaded lorry must travel so that after collision the two remain at rest?
4. a) Distinguish between elastic collision and inelastic collision.
b) Suppose two balls A and B of masses m_1 and m_2 are moving initially (in the same direction) along the same straight line with velocities u_1 and u_2 respectively. The two balls collide. Let the collision be perfect elastic. After collision, suppose v_1 is the velocity of A and v_2 is the velocity of B along the same straight line. Prove that:

$$v_1 = \frac{(m_1 - m_2) u_1}{m_1 + m_2} + \frac{2m_2 u_2}{m_1 + m_2} \text{ and } v_2 = \frac{(m_1 - m_2) u_2}{m_1 + m_2} + \frac{2m_1 v_1}{m_1 + m_2}$$

- c) A ball of 0.1kg makes an elastic head-on collision with a ball of unknown mass that is initially at rest. If the 0.1kg ball rebounds at one third of its original speed, what is the mass of the other ball?
5. a) A 40g golf ball initially at rest is given a speed of 30m/s when a club (a specially shaped stick for striking a ball) strikes. If the club and the ball are in contact for 1.5ms . what average force acts on the ball?
b) Is the effect of the ball's weight during the time of contact significant? Why or why not?

Unit 5

Kirchhoff's Laws and Electric Circuits

Key Unit Competence

Analyse the complex electric circuits using Kirchhoff's laws

My goals

By the end of this unit, I will be able to:

- * analyse complex electric circuits using Kirchhoff's laws.
- * identify sources of electric current.
- * describe components of simple electric circuits.
- * state Kirchhoff's laws and apply them to solve problems in electric circuits.
- * acquire practical skills to manipulate apparatus and evaluate experimental producers.
- * explain the differences between the potential difference and electromotive forces.

Introductory activity

Provided two bulbs, cell holder, bulb holder, voltmeter, ammeter, connecting wires and a switch.

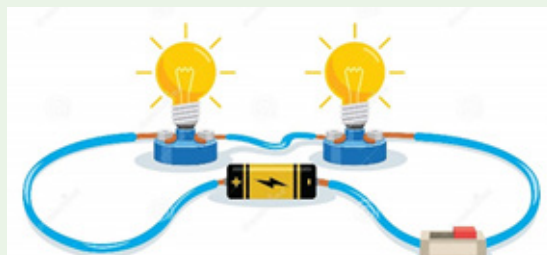

1. Make a simple electric circuit (as in the above figure) and comment on your observation
2. On the circuit made in (1), add a voltmeter and an ammeter.
3. What would happen if you remove one bulb from the circuit?
4. Would there be another type of connection of the circuit? Try it and comment your observation.
5. Discuss on the function of each element in provided list.

Introduction

This unit is ^{Wire}one of the most interesting units in Physics. Even if you ask someone who did not have enough studies in Physics he or she will tell you that People studying physics will be engineers specifically electricians. This Unit addresses the principles those electricians use in their career.

Review of elements of simple electric circuits and their respective role

An electric current consists of moving electric charges. Electric current must flow in electric devices connected by conductors (wires). The motion of electrons in a conductor is compared to water flow in a pipe. To move electrons, there must be a source of electric current, a cell, a battery, a generator which acts as a pump of water.

Making a simple circuit



Activity 1

Making a simple electric circuit with a bulb, a battery and wires

Materials:

- * 2 pieces of copper wire
- * 1 bulb
- * 1 battery

Procedure

1. Examine diagrams A-J below. Predict whether the circuit will be complete, and record your prediction on the chart below.
2. Demonstrate the arrangements to test your predictions..

PREDICTION CHART

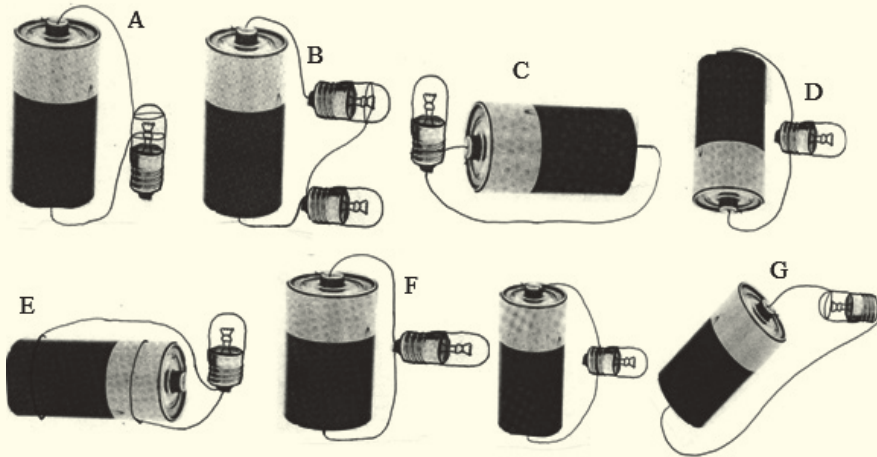

Activity 1

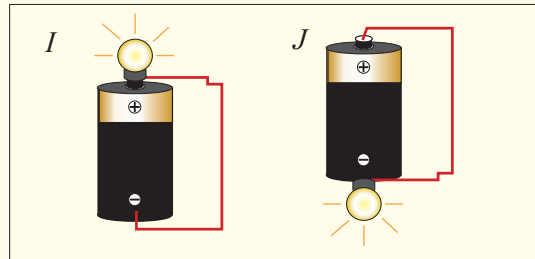

Figure 5.1: Different connections

What makes the bulb light?

You may already understand an electrical circuit, or this may seem like magic to you. Give what your teacher demonstrated some thought. Why do you think the bulb in the diagram lights?

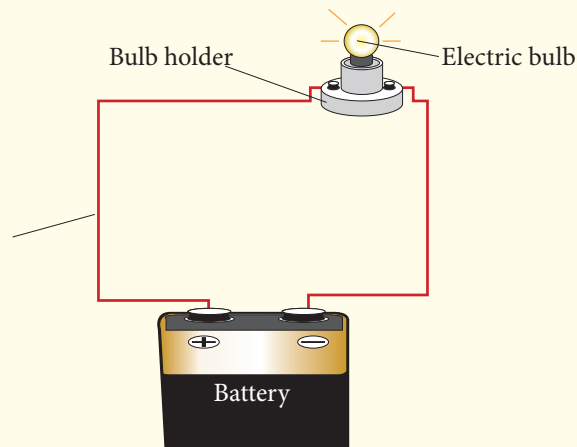

Figure 5.2: Simple circuit

It would be useful here to summarize some basic electricity points which you may know already.

- a) A current flows along a metal or wire when a battery is connected to it.
- b) The current is due to free electrons moving along the metal.
- c) The battery has a potential difference p.d or voltage between its poles due to chemical changes inside the battery. The p.d. pushes the electrons along the metal.

One pole of the battery is called the positive (+) pole, the other is called the negative (-) pole. The “conventional” current, shown by an arrow, flows in a circuit connected from the + to the – pole. The electrons carrying the current along the circuit wires actually move in the opposite direction to the conventional current but this need not to be taken in account in calculations or circuit formulae.

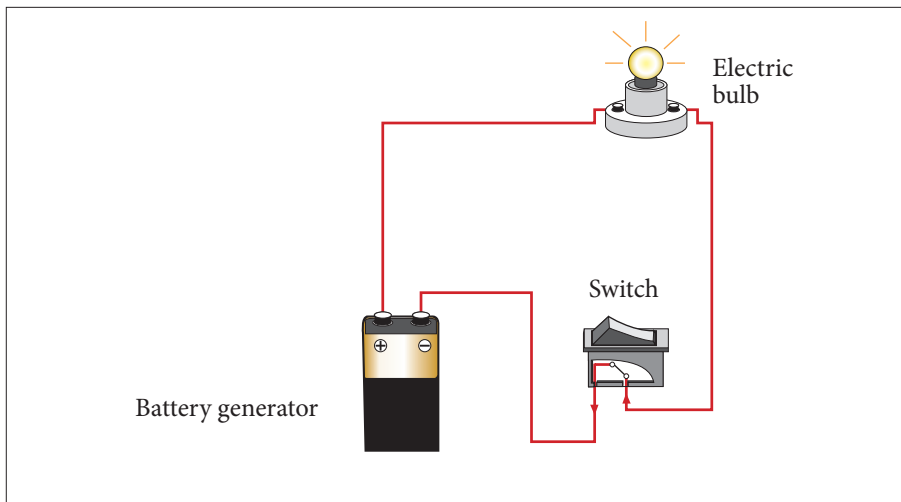

Figure 5.3: Diagram of a simple electric circuit

Any path along which electrons can flow is a **circuit**. For a continuous flow of electrons, there must be a complete circuit with no gaps. A gap is usually provided by an electric switch that can be opened or closed to either cut off or allow energy flow.

Most circuits contain more than one device that receives electric energy from the circuit. These devices are commonly connected in a circuit in one of two ways, series or parallel. When connected in series, the devices and wires connecting them form a single pathway for electron flow between the

terminals of the battery, generator or wall socket. When connected in parallel, the devices and wires connecting them form branches, each of which is a separate path for the flow of electrons.

Making a series and parallel circuit

Activity 2



Making a series circuit

Materials:

- * 1 Battery .
- * 3 Bulbs.
- * 3 bulb holders .
- * Assembled battery holder.
- * 4 Pieces of copper wire (as needed).

Procedure

1. Construct a complete circuit with a battery and a bulb.
2. Using another wire, add a second bulb as shown on the picture below.

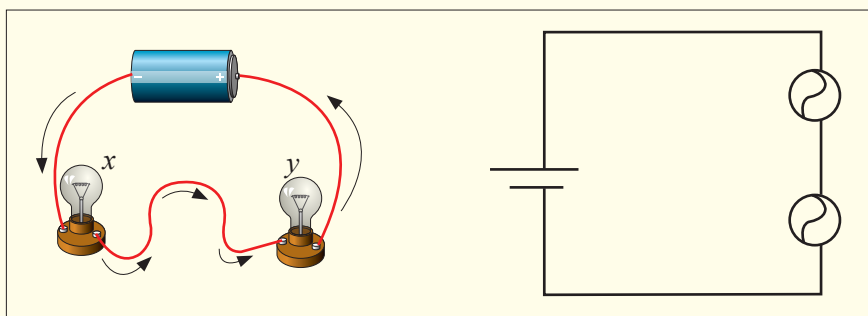

Figure 5.4: A series circuit

3. What did you notice happened to the first bulb when the second bulb was added?

4. Look carefully at how the series circuit is set up. Write a prediction of what you think will happen if you unscrew one of the bulbs.

Why did you make this prediction?

5. Unscrew bulb "X". Describe what happens to bulb "Y".

6. Tighten bulb "X", and unscrew bulb "Y". Describe what happens to bulb "X".

7. Add a third bulb to your series circuit. What happens to the brightness of the bulbs each time another bulb is added to the series?

8. Add a third bulb to your series circuit. What happens to the brightness of the bulbs each time another bulb is added to the series?

9. Draw a schematic diagram of the circuit you constructed with three bulbs.

Activity 3



Making a parallel circuit

Materials:

- * 1 battery
- * 3 bulbs
- * Assembled battery holder 3 bulb holders
- * 6 pieces of copper wire

Procedure

1. Construct a complete circuit with one battery and one bulb.
2. Using another two wires, add a second bulb as shown in the figure below.

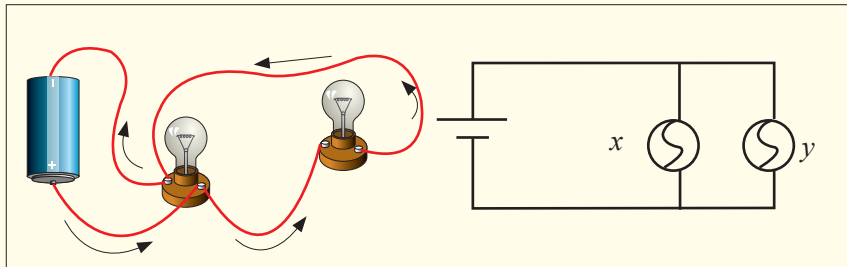

Figure 5.5: A parallel circuit

3. What do you notice happened to the first bulb when the second bulb was added?

4. Look carefully at how a parallel circuit is set up. Write a prediction of what you think will happen if you unscrew one of the bulbs in the parallel circuit.

Why did you make this prediction?

5. Unscrew bulb "X". Describe what happens to bulb "Y".

6. Tighten bulb "X" and unscrew bulb "Y". Describe what happens to bulb "X".

After carrying out experiments for series and parallel circuits,

- * What advantages and disadvantages can you note for the two cases?
- * What are the characteristics of a series connection and a parallel connection?

Application activity 5.1

1. If a battery provides a high voltage, it can _____.
 - a. do a lot of work over the course of its lifetime
 - b. do a lot of work on each charge it encounters
 - c. push a lot of charge through a circuit
 - d. last a long time
2. Which of the following is true about the electrical circuit in your flashlight?
 - a) Charge moves around the circuit very fast - nearly as fast as the speed of light.
 - b) The battery supplies the charge (electrons) which move through the wires.
 - c) The battery supplies the charge (protons) which move through the wires.
 - d) The charge becomes used up as it passes through the light bulb.
 - e) The battery supplies energy which raises charge from low to high voltage.
 - f) Nonsense! None of these are true.

series connections of resistors

For a series combination of two resistors, the currents are the same in both resistors because the amount of charge that passes through R1 must also pass through R2 and R3 in the same interval of time.

The potential difference at the generators is equal to the sum of potential difference at each resistor mean that The potential difference applied across the series combination of resistors will divide between the resistors.

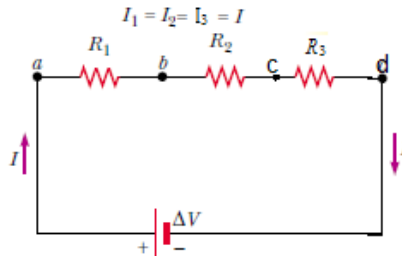

We know that $I = \frac{V}{R}$, $\leftrightarrow V = I \times R$

$$I_1 = \frac{V_1}{R_1}, \quad I_2 = \frac{V_2}{R_2}, \quad \text{and } I_3 = \frac{V_3}{R_3} \text{ as}$$

$$V = V_1 + V_2 + V_3 \text{ and also } I = I_1 = I_2 = I_3$$

$$IR = IR_1 + IR_2 + IR_3 \leftrightarrow$$

$$IR = I(R_1 + R_2 + R_3)$$

$$\leftrightarrow R_{eq} = R_1 + R_2 + R_3$$

Therefore, the equivalent resistors

$$R_{eq} = R_1 + R_2 + R_3 + \dots + R_n$$

The circuit becomes:

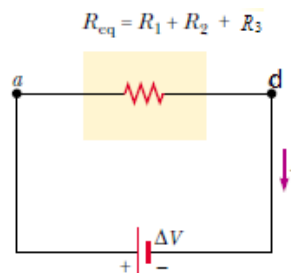

Parallel connection of resistors

The total current equal to the sum of the current pass through the separate branches.

The potential difference is the same at each resistor and at the generator or cell.

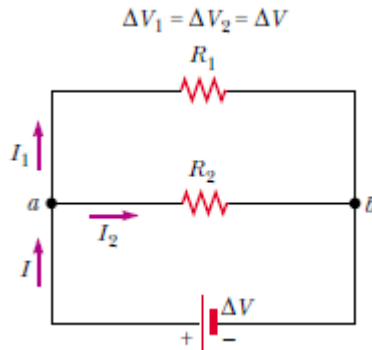

$$I = \frac{V}{R} \text{ and } V = IR, I_1 = \frac{V_1}{R_1} \text{ and } I_2 = \frac{V_2}{R_2} \text{ as } I = I_1 + I_2,$$

$$\text{and } \frac{V}{R} = \frac{V_1}{R_1} + \frac{V_2}{R_2} \text{ as } V = V_1 = V_2 = V_3 = \dots V_n, \quad \frac{V}{R} = V \left(\frac{1}{R_1} + \frac{1}{R_2} \right)$$

$$\text{Therefore } \frac{1}{R_{eq}} = \frac{1}{R_1} + \frac{1}{R_2} + \frac{1}{R_3} + \dots \frac{1}{R_n}$$

The circuit becomes:

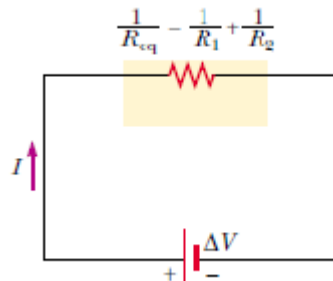

Conclusion

Series and parallel connections each have their own distinctive characteristics.

In a series circuit, the current is the same at all points; it is not used up. In a parallel circuit the total current equals the sum of the currents in the separate branches.



Figure 5.6: From electric lines to houses, all household lights and appliances are connected in parallel because a parallel circuit allows all devices to operate on the same voltage

Application activity 5.2

1. As the number of resistors in a series circuit increases, the overall resistance _____ (increases, decreases, remains the same) and the current in the circuit _____ (increases, decreases, remains the same).+
2. Three resistors are connected in series. If placed in a circuit with a 12 V power supply. Determine the equivalent resistance, the total circuit current, and the voltage drop across and current at each resistor.

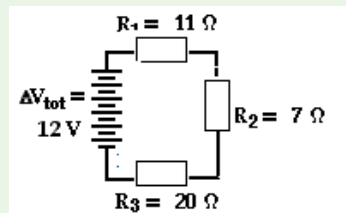

(Redraw this img Cleary using data:)

$$V_{tot} = 12 \text{ V}, \quad R_1 = 11 \Omega, \quad R_2 = 7 \Omega \text{ and } R_3 = 20 \Omega$$

3. Determine the values of the current at and electric potential difference across each of the resistors in a parallel circuit.

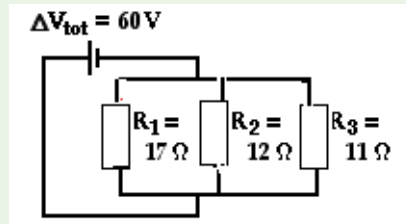

Generators and receptors

Electromotive force

Activity 4



Electromotive force of a generator

Materials

- * Battery of 6V,
- * Rheostat
- * Voltmeter
- * Ammeter
- * Connecting wires

Procedure

1. Make the connection as shown in the following figure.

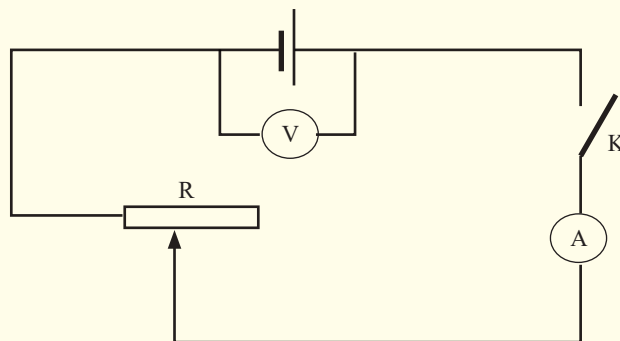

Figure 5.7: Diagram related to activity 4

2. Write down the voltage and the current indicated by the voltmeter and the ammeter when the switch is open.
3. Close the switch and vary the current in the circuit by varying the values of the rheostat and every time write down values of voltage and current indicated respectively by voltmeter and Ammeter.
4. Fill in the following table the obtained data:

Voltage V [V]						
Current I [A]						

5. When you vary the value of the resistance of the rheostat, does the intensity of current remain constant? Why?
6. Does the voltage remain constant?
7. What is the maximum voltage that you have got? How is this voltage called?
8. In general, if a charge Q (in coulombs) passes through a source of emf E (in volts) which relation will give the electrical energy W supplied by the source (in joules)?
9. Which relation will give the total power of the source?

Interpretation

A voltmeter connected to terminals of a battery measures the voltage between terminals of battery. When the switch was closed, we have noticed that there was a current across the circuit and the value of the voltage has been changed.

By varying the value of the resistance of the rheostat, current in the circuit is changed; voltage indicated by the voltmeter changes also, it decreases when current increases. Its maximum value is reached when the switch is open. Such voltage is called electromotive force E (emf) of the battery.

The *electromotive force emf* E of a source (a battery, generator, etc) is the energy transferred to electrical energy when unit charge passes through it. In other words, we can say that the emf of a source of electrical energy is its terminal p.d. on open circuit.

The emf of a battery is the maximum possible voltage that the battery can provide between its terminals.

The unit of emf like the unit of p.d; is the volt [V] and equals the emf of a source which transfers 1 Joule of energy when 1 coulomb passes through it.

In general, if a charge Q (in coulombs) passes through a source of emf E (in volts), the electrical energy supplied by the source W (in joules) is:

$$W = QE \Rightarrow W = EIt \text{ so } E = \frac{W}{Q}$$

Then the electric energy provided to the circuit by the source is given by the relation above. The electric power P , in this case is given by:

$$P = EI \text{ so } E = \frac{P}{I} \text{ where } I \text{ is the electric current in the circuit.}$$

Examples

1. What is the power supplied by a cell of emf 4.5V, knowing that a current of 0.5A flows in the circuit?
2. Find the emf of a generator of power 12W sending a current of 1A in an external circuit.

Solution

$$1. \quad P = EI = 0.5 \times 4.5 = 2.25 \text{ W}$$

$$2. \quad E = \frac{P}{I} = \frac{12}{1} = 12 \text{ W}$$

Internal resistance



Activity 5

Existence of internal resistance in a generator

- * Consider a certain number of cells which you put in an electric apparatus, like a radio...
- * With your cheek, feel their temperatures before use.
- * Put the cells in your apparatus and let them work for a certain time.
- * Remove the cells and again with your cheek, feel the new temperature of the cells then answer the following questions:

- Are the two temperatures of the cells equal? (Before and after use)
 - If not, what do you think is the cause of different temperatures?
 - Is one part of the current produced by the generator consumed by it? Why?
- * The same observations can be made by feeling the temperature of the battery of a telephone before a call and after a call of about 10 minutes. Have you felt the increasing of temperature of a phone after using it? If yes, you think it's due to what?



Figure 5.8: The phone burnt due to the high temperature developed in the battery during the charging and use of the phone at the same time

The term internal resistance refers to the resistance within an emf. The terminal p.d. of a cell on closed circuit is also the p.d. applied to the external circuit.

In an external circuit electrical energy is changed onto other forms of energy and we regard the terminal p.d. of a cell on closed circuit as being the number of joules of electrical energy changed by each coulomb in the external circuit.

Not all the electrical energy supplied by a cell to each coulomb is changed in the external circuit. The “lost” energy per coulomb is due to the cell itself having resistance. Each coulomb has to “waste” some energy to get through the cell itself and so less is available for the external circuit. The resistance of a cell is called its internal resistance [r] and depends among other things on its size.

The electric power dissipated as heat in a cell is given by: $P_i = I^2 r$

Examples

1. The power dissipated as heat in a cell is of 7W, find its internal resistance if a current of 2A flows through it.
2. Find the power dissipated as heat in a generator of internal resistance 0.6Ω crossed by a current of 3A.

Solution

1. $r = \frac{P_i}{I^2} = \frac{7}{4} = 1.75\Omega$
2. $p_i = I^2 r = 3^2 \times 0.6 = 5.4W$

Remark: Any electrical generator, then, has two important properties, an emf E and an internal resistance r . E and r may be represented separately in a diagram, though in practice they are together between the terminals. To represent a cell, we can write (E, r) . So we can think of the battery as an “electric pump”, with its emf E pushing the current round the circuit through both the external (outside) resistor R and internal resistance r

In an electric circuit, a generator is then represented by the following symbol:

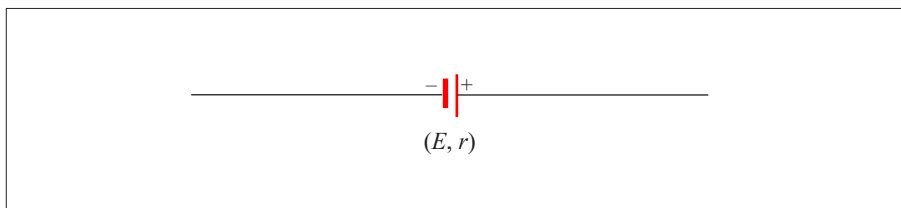

Figure 5.9: Representation of a generator in an electric circuit



Activity 6

Experiment to find the emf (E) and the internal resistance (r) of a cell

Materials

- * 1.5V (approx) cell,
- * Resistance box,
- * Push switch,
- * Digital Ammeter (0-1A).

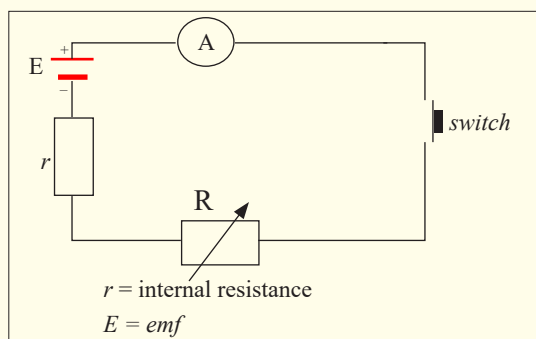

Figure 5.10: Diagram related to activity 7

Procedure

1. Check the scale on the digital Ammeter by comparing to other Ammeters.
2. Set R at 10 Ohms. Reduce in steps of 1 Ohm, recording resistance and current. Read the Ammeter as accurately as possible. Release switch (**not** a tap switch) after each reading, otherwise the cell will run down during the experiment.
3. Repeat the readings, increasing R back up to 10 Ohms. Obtain average values of I , the current for each value of the resistance.
4. Calculate $\frac{1}{I}$.
5. Plot a graph of R against $\frac{1}{I}$. Draw the best possible straight line through the points (they might be quite scattered) in Excel, put the equation of the line on the graph.

The gradient of this graph is the emf of the cell. The negative intercept on the y-axis is the internal resistance.

Relationship between the P.d and the emf at terminals of a cell of a closed circuit

Activity 7



Relation between the Emf and the P.d

Materials

- * Dry cell,
- * Analogy multimetres (2),
- * Rheostat and switch.

Procedure

1. Set up the circuit as shown.

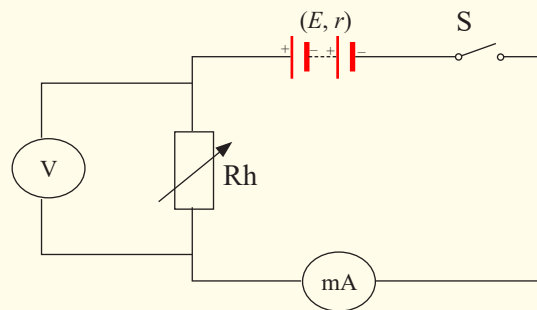

Figure 5.11: Diagram related to activity 8

2. Set the resistance of the rheostat to a large value to protect the circuit before switch on the circuit.
3. Set the milliammeter to the range 0-1 A or suitable range.
4. Set the voltmeter to the range 0-5V or suitable range.
5. Switch on the circuit. Record down the readings of the Ammeter and voltmeter. Slide the rider of the rheostat to another position. Record the readings of the ammeter and voltmeter again. Tabulate the results.

Results

P.d. across the rheostat V [V]							
Current flowing in the circuit I [A]							

Questions

Verify that $V = E - I(r + R_A)$ where V is the potential difference across the rheostat, E is the emf of the cell, r is the internal resistance and R_A is the internal resistance of the Ammeter.

Interpretation

The electrical energy provided by the generator is consumed by the generator itself and by the external circuit.

Let be:

P_i : The power supplied by a cell in the internal resistance;

P_e : The power supplied by a cell in the external circuit

If P is the total power supplied by a cell, we can write: $P = P_i + P_e$

I being the intensity of the current provided by the cell, we write:

$$EI = rI^2 + RI^2$$

$$EI = I(rI + RI)$$

$$E = rI + RI$$

$$E = rI + V$$

$$\text{Then: } V = E - rI$$

The previous relation $V = E - rI$ shows that $V < E$

If $I = 0$, we have $V = E$, means the p.d. is equal to emf if the generator does not work.

Examples

1. What is the voltage at terminals of a battery of emf 3V and internal resistance 0.3Ω when sending a current of 1.5 A in a circuit?
2. Knowing that the voltage at terminals of a cell is 1.5V and the current crossing the circuit is 1.2 A. Find its emf if its internal resistance is of 0.4Ω .

Solution

$$1. \quad V = E - Ir = 3 - (1.5 \times 0.3) = 2.55V$$

$$2. \quad E = V + Ir = 1.5 + (1.2 \times 0.4) = 1.98V$$

Efficiency of a cell

Activity 8



Analysis of the relation $P = P_i + P_e$

Study the relation $P = P_i + P_e$ and answer the following questions.

- In the relation, there are three quantities representing power. The power supplied to the external circuit, the one dissipated in the cell by Joule's effect and the one which is the total power supplied by the cell. Match each power by its symbol in the relation.
- Is the total power supplied by the cell consumed by the external circuit? If yes, why? And if not, why?
- In general, how do you call the ratio of the amount of power produced by a machine and the power put into it?
- What is the unit of the physical quantity described in the question above?
- The ratio of the power supplied by the cell to the external circuit and the total power supplied by the cell has a special name. Have you ever heard it? If yes what is it? What is its unit?
- Is there another way to write that ratio using the power supplied by the generator in the internal circuit? If yes find it.
- Is there a way to write the same quantity using the emf and voltage at terminal of a cell?

Since the relation above involves the total power in the circuit, which is the sum of the power supplied in the external circuit and the power dissipated in the cell itself, this one is useful. It's used to find the efficiency of the cell and how to calculate the voltage at terminals of a cell or battery.

To calculate the efficiency of the cell.

The ratio $\eta = \frac{P_e}{P}$ is the efficiency of a cell, where P_e : the power supplied by a cell to the external circuit and P is the total power supplied by the cell.

The efficiency is expressed as percentage %.

We can write:
$$\eta = \frac{P_e}{P} = \frac{P - P_l}{P} = 1 - \frac{P_l}{P}$$

We can deduce other relations:
$$\eta = \frac{P_e}{P} = \frac{V}{E} \Rightarrow \eta = \frac{V}{E} \%$$

Ohm's law for a circuit having a cell and a resistor

Activity 9



From the observation of the following diagram and analysing different elements deduce a relation

Questions:

- State the Ohm's law.
- Observe the following diagram and list constituting elements.

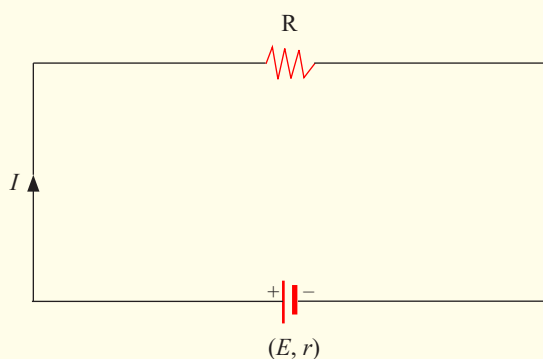

Figure 5.12: Circuit having a cell and external resistance

- Do these elements make an electric circuit? If yes, why?
- Are these elements connected in series or in parallel? Why?
- How can you find the total resistance of a series connection?
- Having the total power supplied by a cell, the power supplied by a cell in an external circuit and the power distributed by the internal resistance. Write the relation between them.
- Write down relations for each type of power and substitute them in the relation above. (Powers dissipated in internal and external resistances must be written in terms of resistance)
- From the relation found, deduce the emf E . The relation found expresses the Ohm's law for a circuit having a cell and a resistor.
- Express the intensity of the current for this specific case.

Pouillet's law

We can obtain a form of Ohm's law by considering a segment of straight wire of uniform cross-sectional area A and length l , as shown in Figure 5.8. A potential difference is maintained across the wire, creating in the wire an electric field and a current.

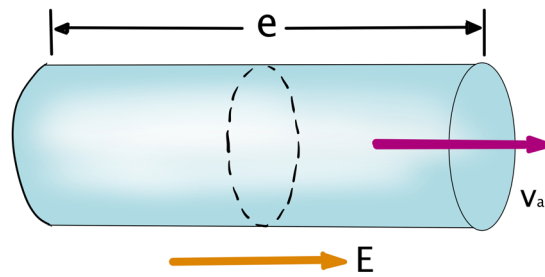

Fig.5. 8 A uniform conductor of length and cross-sectional area A.

The equation representing the dependency of the resistance (R) of a cylindrically shaped conductor (e.g., a wire) upon the variables which affect it, is called **Pouillet's law**,

$$R = \rho \frac{L}{A}$$

where

- L represents the length of the wire (in m). The longer the wire, the more resistance that there will be
- A represents the cross-sectional area of the wire (in m^2). The wider the wire, the less resistance that there will be to the flow of electric charge. When all other variables are the same, charge will flow at higher rates through wider wires with greater cross-sectional areas than through thinner wires.
- ρ represents the resistivity of the material (in $\Omega \cdot m$). Some materials are better conductors than others and offer less resistance to the flow of charge; they are better conductors. Silver is one of the best conductors but is never used in wires of household circuits due to its cost. Copper and aluminum are among the least expensive materials with suitable conducting ability to permit their use in wires of household circuits.

Resistivity of a material is numerically the resistance of a sample of unit length and unit cross-section area, at a certain temperature. The resistivity of a material is dependent upon the material's electronic structure and its temperature. For most (but not all) materials, resistivity increases with increasing temperature.

Examples

- 1.(a) Calculate the resistance per unit length of a 22-gauge Nichrome wire, which has a radius of 0.321 mm.
 (b) If a potential difference of 10 V is maintained across a 1.0 m length of the Nichrome wire, what is the current in the wire? The resistivity of Nichrome is. $\rho = 1.5 \times 10^{-6} \Omega m$

Answer

The cross-sectional area of this wire is

$$A = \pi r^2 = \pi(0.321 \times 10^{-3} m)^2 = 3.24 \times 10^{-7} m^2$$

Use Pouillet's law to find the resistance per unit length:

$$\frac{R}{L} = \frac{\rho}{A} = \frac{1.5 \times 10^{-6} \Omega m}{3.24 \times 10^{-7} m^2} = 4.6 \Omega / m$$

(b) Ohm's law gives $I = \frac{\Delta V}{R} = \frac{10 V}{4.6 \Omega} = 2.2 A$

2. Suppose you want to connect speakers. (a) If each wire must be 20 m long, what diameter copper wire ($\rho = 1.68 \times 10^{-8} \Omega m$) should you use to keep the resistance less than per wire? (b) If the current to each speaker is 44.0 A, what is the voltage drop across each wire?

Answer

From

$$R = \frac{\rho L}{A} \Rightarrow A = \frac{\rho L}{R} = \frac{1.68 \times 10^{-8} \Omega m \times 20 m}{0.10 \Omega} = 3.4 \times 10^{-6} m^2$$

The cross-sectional area A of a circular wire is related to its diameter d by

$$A = \frac{\pi d^2}{4} \Leftrightarrow d = \sqrt{\frac{4A}{\pi}} = \sqrt{\frac{4 \times 3.4 \times 10^{-6}}{\pi}} = 2.1 mm$$

From Ohm's law, $V = RI = (4.0 \Omega)(0.10 A) = 0.40 V$

Application activity 5.3

1. The total power of a battery is of 9V and its internal resistance 3Ω . Knowing that the current crossed is of 0.4A. Find the efficiency of the battery.
2. A generator of internal resistance 2Ω sends a current of 4A in a resistor of resistance 10Ω . Calculate its power.
3. An external resistance of 4Ω is connected to an electric cell of emf 1.5V and internal resistance 2Ω . Calculate the intensity of the current flowing the external resistance.
4. An electric cell of emf 1.5V and internal resistance 2Ω is connected in series with a resistance of 28Ω . Calculate the power dissipated as heat in the cell.

Combination of cells

Activity 10



Cells wired in parallel and in series

Materials:

- * 3 batteries
- * 2 bulbs
- * 3 assembled battery holders
- * 2 bulb holders
- * 6 pieces of copper wire

Procedure

1. Construct a complete circuit with one battery and one bulb.
2. Observe the brightness of the bulb.
3. Construct the circuit below. Are these batteries in series or parallel?

How can you tell?

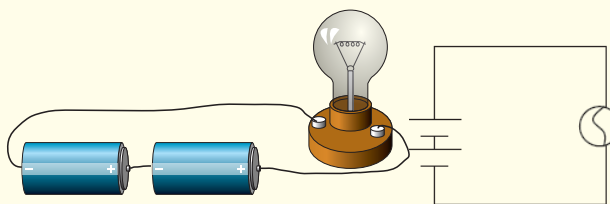

Figure 5.13: Cells in series

4. Observe the brightness of this bulb. Is the bulb brighter than it was with one battery?

5. If you added a third battery to this circuit in series, what do you think would happen to the brightness of the bulb?

Why do you think this?

6. Add a third battery to this circuit. Describe what happens to the bulb as this battery is added to this circuit in series and why you think the bulb is acting in this way.

7. Construct another complete circuit with one battery and one bulb. Record again what the brightness of the bulb is using your brightness metre.

8. Look at the pictures below, are the batteries in the picture in series or parallel?

How can you tell?

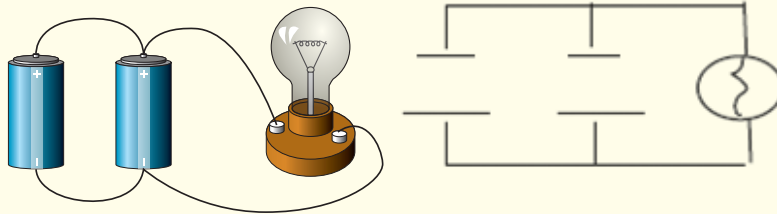

Figure 5.14: Cells in parallel

Construct the circuit in 8. Is the bulb brighter with two batteries than it was with one battery?

9. Add one more battery to this circuit in parallel. Describe what happens to the bulb as one more battery is added to this circuit in parallel and why you think the bulb is acting this way.

10. Connect then two batteries in opposition to mean the positive (negative) terminals of batteries are connected together and the two free negative (positive) terminals are connected to the bulb. What happens to the bulb?

11. Connect two batteries in series in opposition with one battery. When the two free ends of the combination are connected to terminals of the bulb, what happens to the brightness of the bulb?

Interpretation

Combination in series

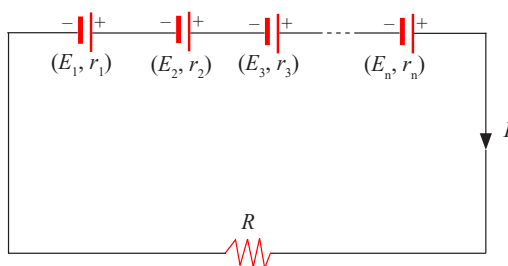

Figure 5.15: Cells combined in series

Let us consider cells combined in series of, respectively, emf and internal resistance E_1, E_2, E_3, \dots , and $r_1, r_2, r_3, \dots, r_n$.

The p.d at the terminals of the combination is

$$\begin{aligned} V_t &= V_1 + V_2 + V_3 + \dots + V_n = E_1 - Ir_1 \\ &= E_1 - Ir_1 + E_2 - Ir_2 + E_3 - Ir_3 + \dots + E_n - Ir_n \\ &= E_1 + E_2 + E_3 + \dots + E_n - I(r_1 + r_2 + r_3 + \dots + r_n) \end{aligned}$$

Then $E_t = E_1 + E_2 + E_3 + \dots + E_n$ and $r_t = r_1 + r_2 + r_3 + \dots + r_n$

We write $E_t = \sum_{i=1}^n E_i$ and $r_t = \sum_{i=1}^n r_i$

When two or more cells are arranged in series, the total emf is the algebraic sum of their emfs and the total internal resistance is the algebraic sum of their internal resistances

For n identical cells of emf E and internal resistance r each, we have:

$$E_t = nE \text{ and } r_t = nr$$

The intensity of the current produced is: $I = \frac{E_t}{R + r_t} = \frac{nE}{R + nr}$

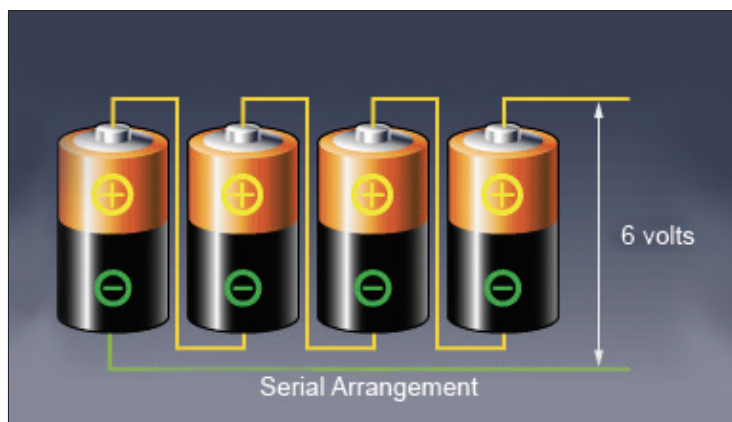

Figure 5.16: Each cell is of emf 1.5V: The emf of the combination is 6V, to mean $1.5V + 1.5V + 1.5V + 1.5V$

Note: A series arrangement is used to increase the voltage, also the total internal resistance of the circuit, so the energy loss due to internal resistance is greater than for a single cell.



Figure 5.17: In a torch, cells are in series: The three cells in the figure above act like one cell of emf which equals to the sum of the three cells

Examples

- Four 1.5V cells are connected in series to a 12Ω lightbulb. If the resulting current is 0.45A, what is the internal resistance of each cell, assuming they are identical and neglecting wires?
- A certain number of cells of emf 1.5V and internal resistance 2Ω are connected in series. When connected this combination to an external resistance of 10Ω , a current of 500mA flows in this resistance. Find the number of cells used.

Solution

$$1. \quad I = \frac{nE}{R + nr} \Leftrightarrow r = \frac{\left(\frac{nE}{I}\right) - R}{n}$$

$$r = \frac{\left(\frac{4 \times 1.5V}{0.45A}\right) - 12\Omega}{4} = 0.33\Omega$$

$$2. \quad I = \frac{nE}{R + nr} \Leftrightarrow n = \frac{IR}{E - Ir}$$

$$n = \frac{(0.5A)(10\Omega)}{1.5V - (0.5A)(2\Omega)} = 10 \text{ Cells}$$

Combination in opposition

Let us see also what the result could be if the cells were associated in opposition

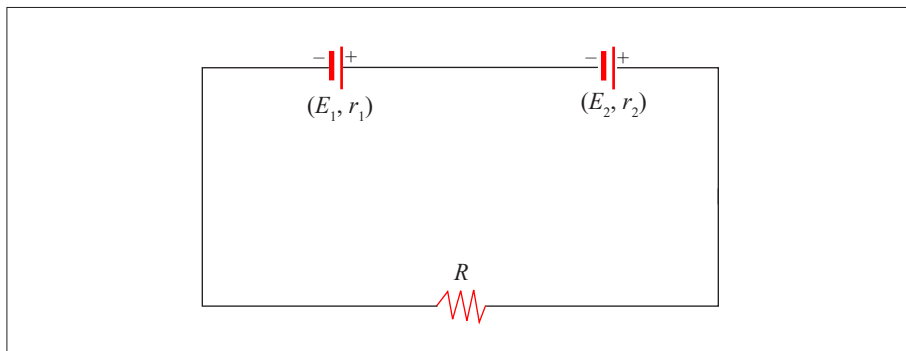

Figure5.18: Cells combined in opposition

Let us combine two cells in opposition. Two terminals of same sign are connected together. The direction of the current in the circuit will be determined by the direction of the current produced by the cell having the higher emf. For internal resistances they are in series. So we write:

$$\begin{aligned} E_t &= |E_2 - E_1| \\ &= E_2 - E_1 \text{ if } E_2 > E_1 \\ &= E_1 - E_2 \text{ if } E_1 > E_2 \\ &= 0 \text{ if } E_1 = E_2 \text{ and } r_t = r_1 + r_2 \end{aligned}$$

The intensity of the current which will flow in the circuit is: $I = \frac{E_2 - E_1}{r_1 + r_2 + R}$

Note: You might think that connecting batteries in opposition would be wasteful. For more purposes, that will be true. But such an opposition arrangement is precisely how a battery charger works.

Example

A cell of emf 2V and internal resistance 0.2Ω is associated in opposition with another cell of emf 1.5V and internal resistance 1.2Ω . Calculate the intensity of the current knowing that the external resistance is 1.1Ω .

Solution

$$I = \frac{E_2 - E_1}{r_1 + r_2 + R} = \frac{2 - 1.5}{0.2 + 1.2 + 1.1} = 0.2 \Omega$$

Combination in parallel

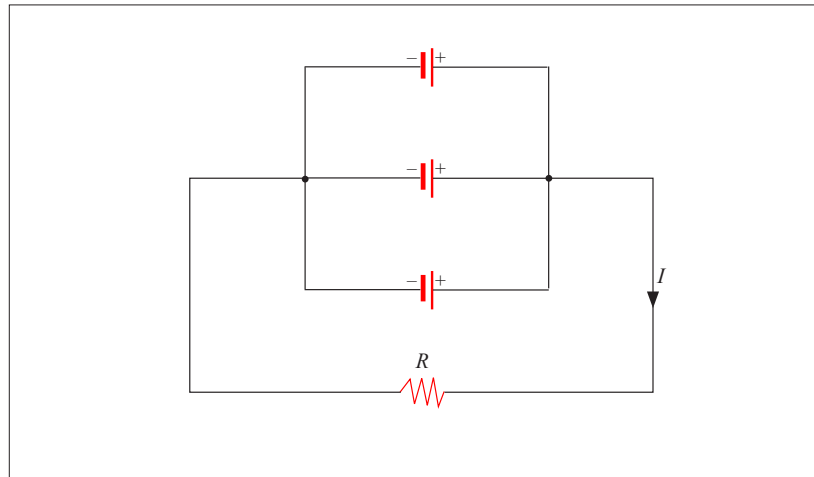

Figure 5.19: Identical cells combined in parallel

Consider a parallel arrangement of n identical cells having (E, r) as characteristics each. The total emf of the arrangement is the emf of one cell and the total internal resistance is found considering the parallel arrangement of resistors. Then, we have: $E_t = E$ and $r_t = \frac{r}{n}$

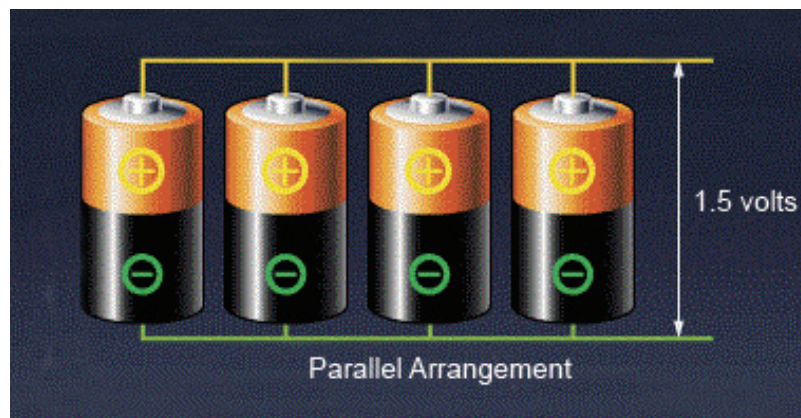

Figure 5.20: Each cell having an emf of 1.5 V, the total emf is of 1.5V

The intensity of the current produced is:

$$I = \frac{E_t}{R + r_t} = \frac{E}{R + \frac{r}{n}} = \frac{E}{\frac{nR + r}{n}}, \text{ finally } I = \frac{nE}{nR + r}$$

Note: The parallel arrangement is useful normally only if the emfs are the same. A parallel arrangement is not used to increase the voltage, but rather to provide large currents. Each of the cells in parallel has to produce only a fraction of the total current, so the energy loss due to internal resistance is less than for a single cell; the batteries will be exhausted less quickly.

Examples

1. We have 8 cells of emf 1.5V and internal resistance 2Ω . Calculate the intensity of the current flowing in an external resistance of 1Ω connected to the terminals of the 8 cells combined in parallel.
2. Six cells of unknown emf and internal resistance of 2Ω are associated in parallel. When an external resistance of 1Ω is connected to this combination a current of 1.5A is produced. Calculate the emf.

Solution

1.
$$I = \frac{nE}{nR + r} = \frac{8 \times 1.5}{8 \times 1 + 2} = 1.2 \text{ A}$$
2.
$$E = \frac{I(nR + r)}{n} = \frac{1.5(6 \times 1 + 2)}{6} = 2 \text{ V}$$

Mixing series and parallel combinations

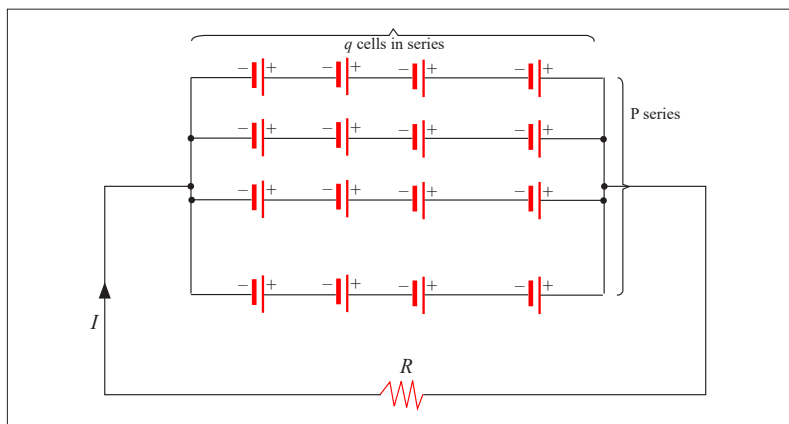

Figure 5.21: Mixing of a series and parallel combination

Consider a combination having p series having q cells each.

The total emf at terminals of the combination is the emf of one series, that means

$$E_t = qE \text{ and } r_t = \frac{qr}{p}$$

The intensity of the current flowing in the circuit is given by:

$$I = \frac{E_t}{R + r_t} = \frac{qE}{R + \frac{qr}{p}} = \frac{qE}{\frac{pR + qr}{p}} = \frac{pqE}{pR + qr}$$

The total number n of cells in the circuit is $n = pq$, then: $I = \frac{nE}{pR + qr}$

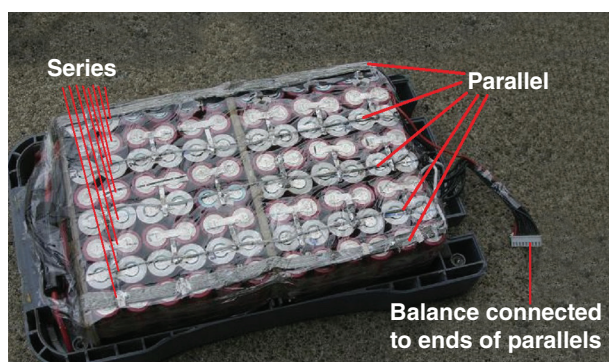

Figure 5.22: Identical series combined in parallel

Example

Four cells of emf 4.5V each and internal resistance 2Ω are combined in series. The combination is connected to an external resistance of 24Ω

- What is the intensity of the current?
- Same question if the cells are combined in parallel.
- Same question if the combination has two parallel series of two cells each.

Solution

- $$I = \frac{nE}{R + nr} = \frac{4 \times 4.5}{24 + 4 \times 2} = 0.56 \text{ A}$$
- $$I = \frac{nE}{nR + r} = \frac{4 \times 4.5}{4 \times 24 + 2} = 0.18 \text{ A}$$
- $$I = \frac{nE}{pR + qr} = \frac{4 \times 4.5}{2 \times 24 + 2 \times 2} = 0.346 \text{ A}$$

Receptors



Activity 11

Distinguishing a receptor from a passive resistor

- a) Observe the following devices and name them



Figure 5.23: Some appliances

- b) What is the use of each one?
 c) The flowing of the current in them produces the same effect? Explain.
 d) Among them, which ones transform the whole electric energy consumed in heat and which ones transform a part of electric energy consumed in another kind of energy which is not heat?
 e) As we had in the case of generators, what are characteristics of these apparatuses?

Conclusion: Among the apparatuses above, there are some which transform the total electric energy consumed into heat and some transform just a part into heat, other part transformed into another type of energy which is not heat. Those which transform the whole quantity of electric energy consumed into heat are *passive resistors* or *passive receptors* and those transforming a part of the consumed electric energy in another form of energy which is not heat are called *receptors* or *active receptors*.

The main characteristics are back electromotive force and internal resistance.

Back electromotive force

Back electromotive force (emf) is normally used to refer to the voltage that is developed in electric motors. This is due to the relative motion between the magnetic field from the motor's field windings and the armature of the motor!

Internal resistance

The *internal resistance* of a receptor r' is its ability to oppose electric current. When a receptor is traversed by an electric current, part of the energy consumed is transformed into heat. The power dissipated in the receptor by joule effect is: $P_j = I^2 r'$

The p.d at terminals of a receptor



Activity 12

Find the P.d at terminals of a motor

Materials

- * Electric motor
- * Ammeter
- * Voltmeter
- * Power supply

Procedure

1. Make the connection as shown in the figure below.

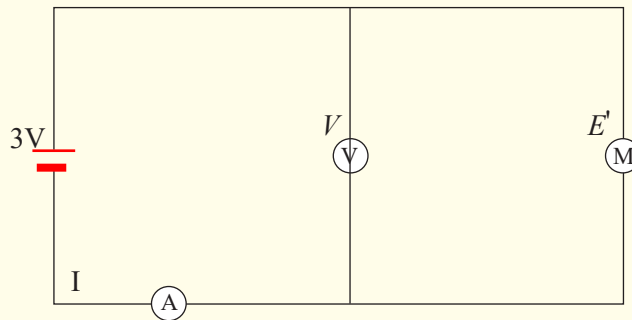

Figure 5.24: Circuit containing a receptor

Measure the voltage (V) between terminals of the motor (M) and the current I in the circuit.

Questions

- What is the net electrical power received by the motor?
- What becomes this power and how is it transformed?
- What is the relation between the voltage and the back electromotive force?
- From the relation found, how do you calculate the intensity of the current flowing?

Application activity 5.4

- A circuit has in series a generator of emf 6V and internal resistance 0.1Ω , a receptor of back emf 1.5V and internal resistance 0.4Ω and a passive resistor of 8.5Ω . Calculate:
 - The intensity of the current flowing in the circuit.
 - The power supply by the generator.
 - The quantity of heat produced in the resistor in one minute.
- A battery has an emf of 12.0V and an internal resistance of 0.05Ω . Its terminals are connected to a load resistance of 3.00Ω . (a) Find the current in the circuit and the terminal voltage of the battery. (b) Calculate the power delivered to the load resistor, the power delivered to the internal resistance of the battery, and the power delivered by the battery.
- Calculate the terminal voltage for a battery with an internal resistance of 0.9Ω and an emf of 8.5V when the battery is connected in series with (a) an 81Ω resistor, and (b) 810Ω .
- A 9V battery whose internal resistance r is 0.5Ω is connected in the circuit shown in the figure.

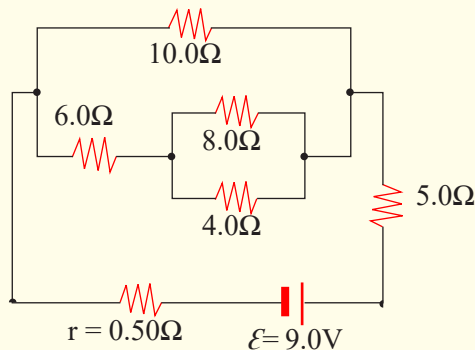

Figure 5.25: Related circuit to question 4

- a) How much current is drawn from the source?
 - b) What is the terminal voltage of the battery?
 - c) What is the current in the 6Ω resistor?
5. What is the internal resistance of a 12V car battery whose terminal voltage drops to 8.4V when the starter draws 75A? What is the resistance of the starter?
6. A 1.5V dry cell can be tested by connecting it to a low-resistance Ammeter. It should be able to supply at least 22A. What is the internal resistance of the cell in this case, assuming it is much greater than that of the Ammeter?
7. A cell whose terminals are connected to a wire in nickel silver of resistivity $30 \times 10^{-6} \Omega\text{cm}$ and cross sectional area 0.25mm^2 and length 5m sends a current of 160mA. When the length is reduced to a half, the intensity of the current is of 300mA. Calculate:
- a) The internal resistance.
 - b) The emf of the cell.
8. A cell ($E = 1.5\text{V}$, $r = 1.3\Omega$) sends a current in an external resistance of 3Ω . Calculate:
- a) The intensity of the current in the circuit.
 - b) The p.d at terminals of the cell.
 - c) The power of generator.
 - d) The efficiency of the cell.
9. A battery is composed by 120 cells in series. Each element has an emf of 2V and an internal resistance of 0.001Ω . The combination is connected to an external resistance of 4.8Ω . Calculate:
- a) The intensity of the current in the circuit.
 - b) The voltage at terminals of the battery.
 - c) The energy dissipated by joule effect when the current flows in the circuit in one hour.

Kirchhoff's rules



Activity 13

Find the equivalent Resistance

In this experiment, you will investigate three ideas using combinations of resistors in series and in parallel. Remember that the **total** or **equivalent resistance** in a series circuit is given by: $R_{\text{eq}} = R_1 + R_2 + \dots$

For a parallel circuit, the equivalent resistance is given by:

$$1/R_{\text{eq}} = 1/R_1 + 1/R_2 + \dots$$

In this experiment you will be using a digital multimeter (DMM) which can function as either a voltmeter or an Ammeter.

The voltmeter must always be wired in parallel with the resistor whose voltage you are measuring. The ammeter, used to measure current, must always be wired in series. Disconnect the meter from the circuit before you change the function setting. Failure to follow these procedures can result in serious damage to the meter. Be sure that you use the correct units with your data.

Materials

- * 1 multimeter.
- * 1 330 Ω or 240 Ω resistor.
- * 1 1000 Ω (1K Ω) resistor.
- * 1 2000 Ω (2K Ω) resistor.
- * 1 3000 Ω (3K Ω) resistor or 1 3300 Ω (3.3K Ω) resistor.
- * 1 0- 10K resistor substitution box.
- * 2 spade lugs.
- * 2 2' red banana wires.
- * 2 2' black banana wires.
- * 4 4" black banana wires.

Procedure

1. Set the DMM function switch to "Ohms" (Ω). Measure and record the resistance of the resistors R_1, R_2, R_3, R_4 .
2. Figure 5.25 is a sketch of the components. In this sketch, the DMM is wired in parallel with R_3 in order to measure the voltage V_3 . Wire the circuit shown in Figure 1, but do not connect it to the power supply until it has been approved by your lab instructor. Once it has been approved, apply power. Set the DMM to DCV. Connect the black banana wire to COM and the red wire to the V- Ω input. Measure the power supply voltage (V_{ps}) and the voltages across R_1 (V_1), R_2 (V_2), R_3 (V_3), and R_4 (V_4) as indicated in Figure 5.26.

3.

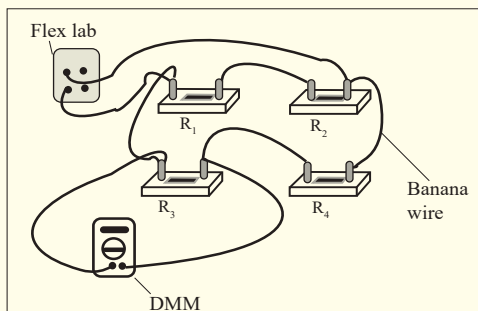

To measure voltage, set the meter to DCV and wire it in parallel with the resistors. This meter is set up to measure V_3 , the voltage across R_3

Figure 5.26: Voltage measurements

4. Unplug the circuit and disconnect the meter. Change the function switch on the DMM to direct current amperes. Move the red wire to the “mA/μA terminal.

Study Figure 5.27 and notice the way the ammeter is wired in series with the resistors. Again, have the lab instructor approve the circuit before you plug it in. Make the current measurements I_1 , I_2 , and I_3 indicated in Figure 4 of 5.27

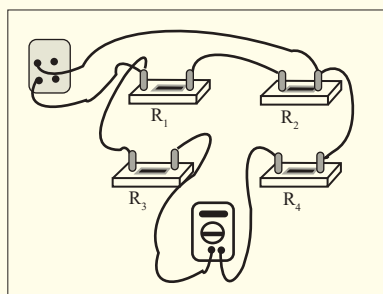

To measure current, set the meter to DCmA and wire it in series with the resistors. This meter is set up to measure I_3 , the current through R_3 and R_4 . Note that the positive lead to the meter must be removed.

Figure 5.27: Current measurements

5. R_1 and R_2 are in series. R_3 and R_4 are also in series. The two series circuits are in parallel. Calculate the equivalent resistance, R_{eq} , for the entire circuit. Show your working.
6. Set the decade resistance box to the value you calculated for R_{eq} for the circuit. Be sure the DMM is set on DCA and wire the DMM and the resistance box in series with the power supply. Measure I_{eq} .
7. Turn everything off, disconnect the components and put the equipment away neatly.

Simple circuits can be analysed using the expression $V = IR$ and the rules for series and parallel combinations of resistors. Very often, however, it is not possible to reduce a circuit to a single loop. The procedure for analysing more complex circuits is greatly simplified if we use two principles called *Kirchhoff's rules*:

Junction rule: *The sum of the currents entering any junction in a circuit must equal the sum of the currents leaving that junction:* $\sum I_{in} = \sum I_{out}$

Loop rule: *The sum of the potential differences across all elements around any closed circuit loop must be zero:* $\sum_{closed\ loop} V = IR$

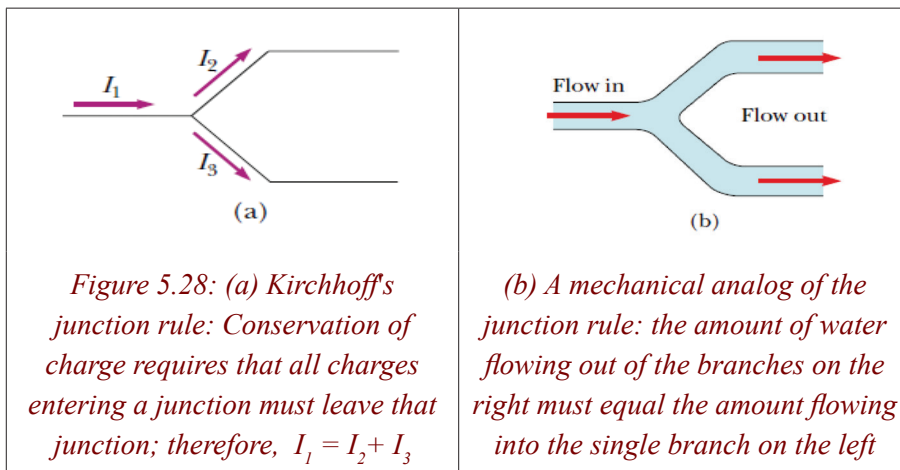

Kirchhoff's first rule is a statement of conservation of electric charge. All charges that enter a given point in a circuit must leave that point because charge cannot build up at a point. If we apply this rule to the junction shown in Figure 5.27, we obtain $I_1 = I_2 + I_3$

Kirchhoff's second rule follows from the law of conservation of energy. Let us imagine moving a charge around a closed loop of a circuit. When the charge returns to the starting point, the charge–circuit system must have the same total energy as it had before the charge was moved. The sum of the increases in energy as the charge passes through some circuit elements must equal the sum of the decreases in energy as it passes through other elements. The potential energy decreases whenever the charge moves through a potential drop $-IR$ across a resistor or whenever it moves in the reverse direction through a source of emf. The potential energy increases whenever the charge passes through a battery from the negative terminal to the positive terminal.

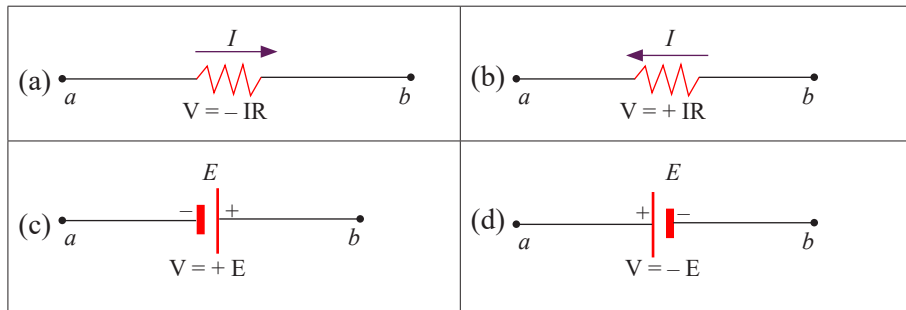

Figure 5.29: Rules for determining the potential differences across a resistor and a battery (the battery is assumed to have no internal resistance). Each circuit element is traversed from left to right

Examples

- A single-loop circuit contains two resistors and two batteries, as shown in figure 5.29 (neglect the internal resistances of the batteries).
 (a) Find the current in the circuit. (b) What power is delivered to each resistor? What power is delivered by the 12V battery?

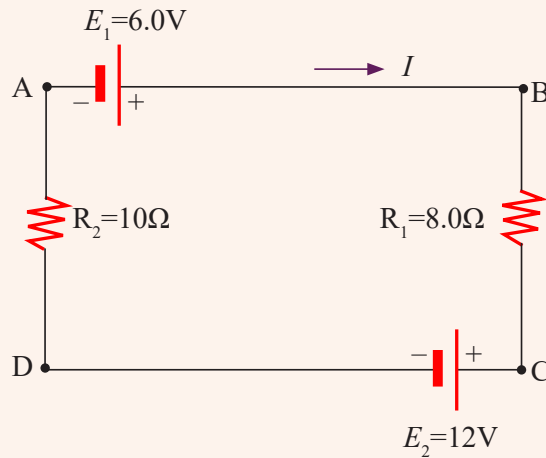

Figure 5.30: Related figure to question 1

2. Find the currents I_1 , I_2 , and I_3 in the circuit shown in Figure 5.31

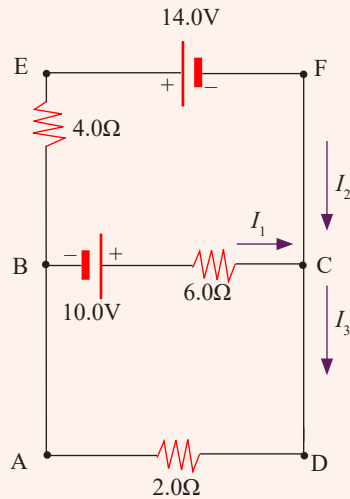

Figure 5.31: Related figure to question 2

3. (a) Under steady-state conditions, find the unknown currents I_1 , I_2 , and I_3 in the multi loop circuit shown in the figure 5.32.
 b) What is the charge on the capacitor?

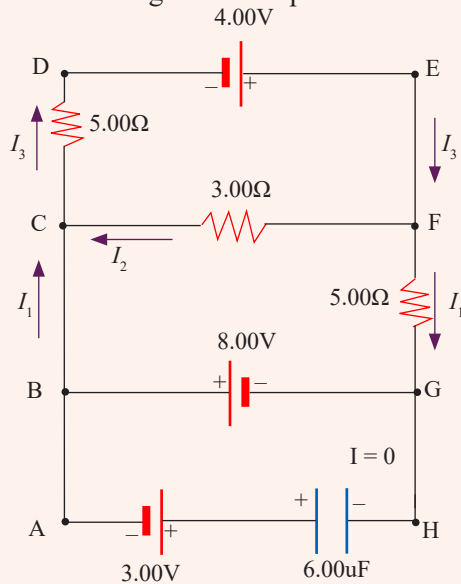

Figure 5.32: Related figure to question 3

Solution

1. (a) We do not need Kirchhoff's rules to analyse this simple circuit, but let us use them anyway just to see how they are applied. There are no junctions in this single-loop circuit; thus, the current is the same in all elements. Let us assume that the current is clockwise, as shown in Figure in the question. Traversing the circuit in the clockwise direction, starting at a, we see that $A \rightarrow B$ represents a potential difference of E_1 , $B \rightarrow C$ represents a potential difference of $-IR_1$, $C \rightarrow D$ represents a potential difference of E_2 , and $D \rightarrow A$ represents a potential difference of $-IR_2$. Applying Kirchhoff's loop rule gives:

$$\sum \Delta V = 0 \Rightarrow E_1 - IR_1 - E_2 - IR_2 = 0$$

Solving for I and using the values given in the Figure, we obtain:

$$I = \frac{E_1 - E_2}{R_1 + R_2} = \frac{6 - 12}{8 + 10} = -0.33 \text{ A}$$

The negative sign for I indicates that the direction of the current is opposite the assumed direction. Notice that the emfs in the numerator subtract because the batteries have opposite polarities. In the denominator, the resistances add because the two resistors are in series.

- (b) Using the relation of the power dissipated as heat in a resistor, we have:

$$P_1 = I^2 R_1 = (0.33)^2 (8.0) = 0.87 \text{ W}$$

$$P_2 = I^2 R_2 = (0.33)^2 (10) = 1.089 \text{ W}$$

Hence, the total power delivered to the resistors is $P_1 + P_2 = 2 \text{ W}$. The 12V battery delivers power $IE_2 = 4 \text{ W}$. Half of this power is delivered to the two resistors, as we just calculated.

2. To analyse the circuit, we arbitrarily choose the directions of the currents as labeled in Figure. Applying Kirchhoff's junction rule to junction C gives.

$$I_1 + I_2 = I_3 \quad (1)$$

We now have one equation with three unknowns, I_1 , I_2 , and I_3 . There are three loops in the circuit, ABCDA, BEFCB and AEFDA.

We therefore need only two loop equations to determine the unknown currents. (The third loop equation would give no new information).

Applying Kirchhoff's loop rule to loops ABCDA and BEFCB and traversing these loops clockwise, we obtain the expressions

$$ABCD A: 10.0 - 6.0 I_1 - 2.0 I_3 = 0 \quad (2)$$

$$BEFCB: -14.0 + 6.0 I_1 - 10.0 - 4.0 I_2 = 0 \quad (3)$$

Note that in loop BEFCB we obtain a positive value when traversing the 6Ω resistor because our direction of travel is opposite the assumed direction of I_1 . Expressions (1), (2), and (3) represent three independent equations with three unknowns. Substituting Equation (1) into Equation (2) gives

$$\begin{aligned} 10.0 - 6.0 I_1 - 2.0 I_1 + I_2 &= 0 \\ 10.0 &= 8.0 I_1 + 2.0 I_2 \quad (4) \end{aligned}$$

Dividing each term in Equation (3) by 2 and rearranging gives

$$-12.0 = -3.0 I_1 + 2.0 I_2 \quad (5)$$

Subtracting Equation (5) from Equation (4) eliminates I_2 , giving

$$22.0 = 11.0 I_1,$$

We Find $I_1 = 2A$

Using this value of I_1 in Equation (5) gives a value for I_2 :

$$2 I_2 = 3.0 I_1 - 12.0 = 3.0 \times 2.0 - 12.0 = -6.0$$

Then $I_2 = -3A$

Finally, $I_3 = I_1 + I_2 = -1A$

Note that I_2 and I_3 are both negative. This indicates only that the currents are opposite the direction we chose for them. However, the numerical values are correct.

3. (a) First note that because the capacitor represents an open circuit, there is no current between G and B along path GHAB under steady-state conditions. Therefore, when the charges associated with I_1 reach point G, they all go toward point B through the 8.00-V battery; hence, $I_{GB} = I_1$.

Labelling the currents as shown in the Figure and applying the junction rule to junction C, we obtain

$$I_1 + I_2 = I_3 \quad (1)$$

Loops' rule applied to loops DEFCD and CFGBC, traversed clockwise, gives

$$DEFCD: 4.00 - 3.00 I_2 - 5.00 I_3 = 0 \quad (2)$$

$$CFGBC: 3.00 I_2 - 5.00 I_1 + 8.00 = 0 \quad (3)$$

From Equation (1) we see that $I_3 = I_1 + I_2$, which, when substituted into Equation (3), gives

$$8.00 I_2 - 5.00 I_3 + 8.00 = 0 \quad (4)$$

Subtracting Equation (4) from Equation (2), we eliminate I_3 and find that

$$I_2 = -\frac{4}{1.0} = -0.364 \text{ A}, \quad I_2 = -0.364 \text{ A}$$

Because our value for I_2 is negative, we conclude that the direction of I_2 is from C to F in the 3Ω resistor. Despite this interpretation of the direction, however, we must continue to use this negative value for I_2 in subsequent calculations because our equations were established with our original choice of direction.

Using $I_2 = 0.364 \text{ A}$ in Equations (3) and (1) gives $I_1 = 1.38 \text{ A}$ and $I_3 = 1.02 \text{ A}$

b) We can apply Kirchhoff's loop rule to loop BGHAB (or any other loop that contains the capacitor) to Find the potential difference ΔV_{CAP} across the capacitor. We use this potential difference in the loop equation without reference to a sign convention because the charge on the capacitor depends only on the magnitude of the potential difference.

Moving clockwise around this loop, we obtain

$$-8.00 + \Delta V_{CAP} - 3.00 = 0$$

then $\Delta V_{CAP} = 11 \text{ V}$ Because $Q = C \Delta V_{CAP}$ the charge on the capacitor is $Q = (6.00)(11.0 \text{ V}) = 66.0 \mu\text{F}$

END UNIT ASSESSMENT

1. In What is the potential drop across an electric hot plate that draws 5.0 A when its hot resistance is $24\ \Omega$
2. It is desired to make a wire that has a resistance of $8.0\ \Omega$ from 5.0 cm^2 of metal that has a resistivity of $9.0 \times 10^{-8}\ \Omega\text{m}$. What should be the length and cross-sectional area of the wire?
3. A wire that has a resistance of $5.0\ \Omega$ is passed through an extruder so as to make it into a new wire three times as long as the original. What is the new resistance?
4. When two unknown resistors are connected in series with a battery, the battery delivers 225 W and carries a total current of 5.00 A . For the same total current, 50.0 W is delivered when the resistors are connected in parallel. Determine the values of the two resistors.
5. Determine i_1 , i_2 , and i_3 and v_1 , v_2 , and v_3 in the following circuit

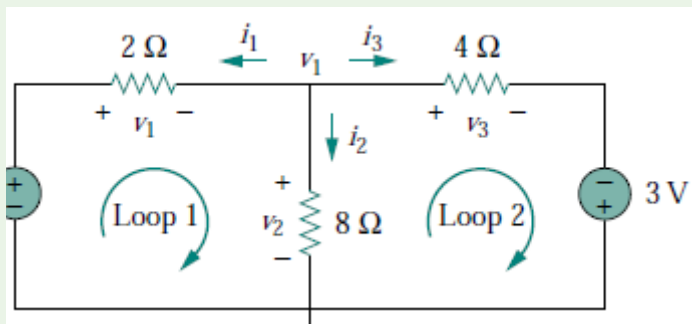

6. Consider the circuit shown in Figure below. Find
(a) the current in the $20.0\ \Omega$ resistor and (b) the potential difference between points a and b .

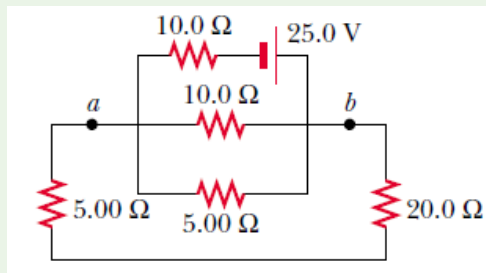

7. Determine i_1 , i_2 , and i_3

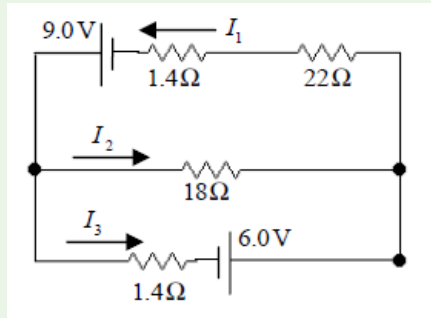

8. In figure below, the battery has an internal resistance of 0.7Ω . Find
 i. the current drawn from battery,
 ii. the current in each 15Ω resistor,
 iii. The terminal voltage of the battery.

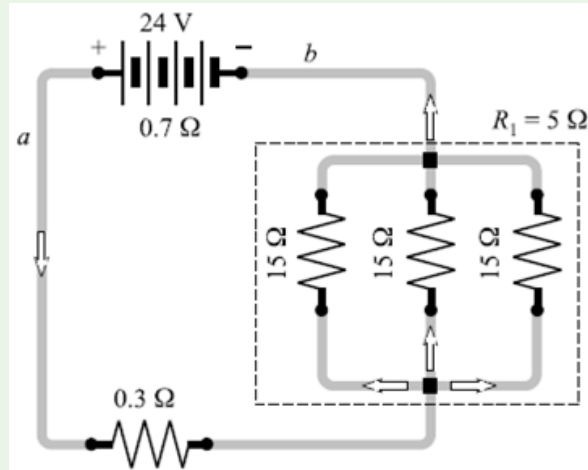

9. The circuit shown in figure below contains two batteries, each with an emf and an internal resistance, and two resistors. Find (a) the current in the circuit (magnitude and direction); (b) the terminal voltage V_{ab} of the 16.0 V battery; (c) the potential difference V_{ac} of a with respect to point c .

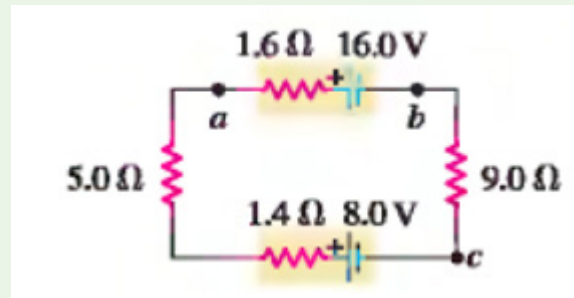

10. Find the currents in the circuit given below:

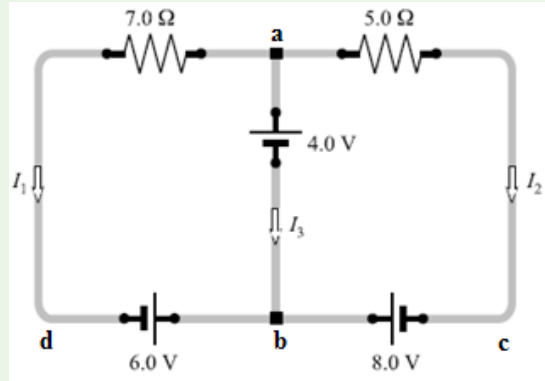

11. In figure below, find I_1 , I_2 , and I_3 if S is

- (a) Open
(b) Closed

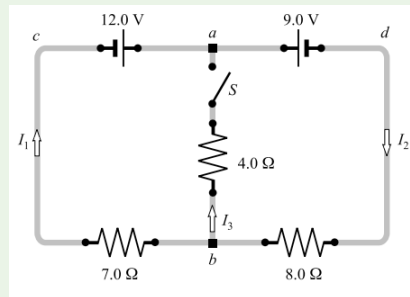

12. (a) Determine the currents I_1 , I_2 , and I_3 in figure below. Assume the internal resistance of each battery is $r = 1.0 \Omega$.

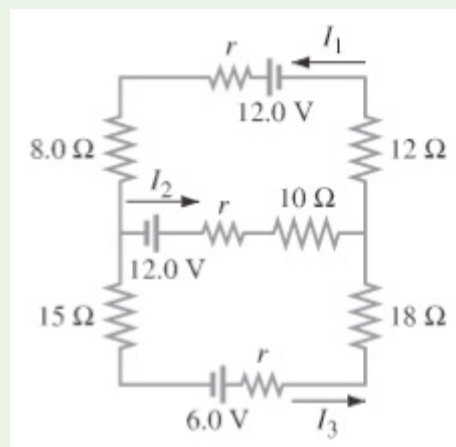

- (b) What is the terminal voltage of the 6.0 V battery?
(c) What would the current I_1 be if the 12Ω resistor is shorted out?

13. A dead battery is charged by connecting it to the live battery of another car with jumper cables as shown in the figure. Determine the current in the starter and in the dead battery.

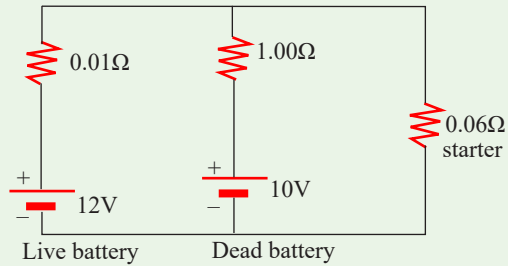

14. The current in the figure below is 0.125 A in the direction shown. For each of the following pairs of points, what is their potential difference and which point is at the high potential?

a) A,B; b) B,C; c)C,D; d) D,E; e) C,E; f) E,C.

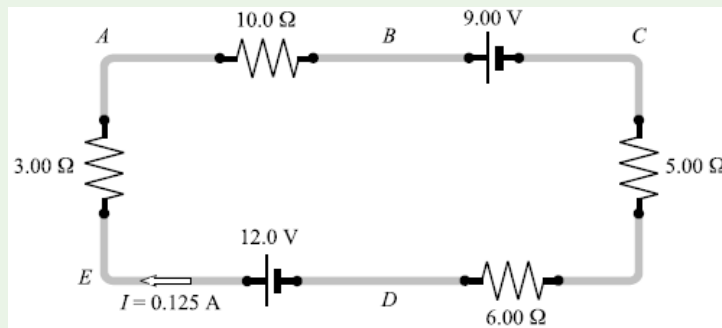

Unit 6

Sources of Energy in the World

Key unit Competence

Evaluate the energy sources in the world

My goals

By the end of this unit, I will be able:

- * identify sources of energy in Rwanda.
- * outline the basic features of renewable and non renewable energy sources.
- * evaluate energy uses and availability in Rwanda.
- * identify various advantages and disadvantages of various energy sources.
- * be aware of the moral and ethical uses associated with use of energy.

Introductory activity

At hospital, during patient treatment, doctors recommend to patients to take a balanced diet. That is true because as a patient takes medicines and eat very well, it yields a quick recovery and one gets strong.

Questions:

- 1.What do you think is contained in food that we eat?
- 2.Discuss why it is very important to take a sunbath when a person is sick?
- 3.Discuss other different sources of energy in environment?

Introduction

Origins of the power used for transportation, for heat and light in dwelling and working areas, and for the manufacture of goods of all kinds, among other applications. The development of science and civilization is closely linked to the availability of energy in useful forms. Modern society consumes vast amounts of energy in all forms: light, heat, electrical, mechanical, chemical, and nuclear. The rate at which energy is produced or consumed is called power, although this term is sometimes used in common speech synonymously with energy.



Activity 1

Answer these questions.

- a) What do you think when you hear the word “*energy*”? Give its definition and that of the term “*energy source*”.
- b) Among scientists and energy professionals, a standard list of current energy sources would include: biomass (plant matter), nuclear, coal, oil, geothermal, solar, hydro (rivers), wave or tidal, natural gas, wind. Add other sources of energy which you may know.
- c) From the list given in (b) what is the major category of renewable energy?
- d) Between renewable and non-renewable energy which one produces a little or no pollution or hazardous waste and pose few risks to public safety? How the other produces it?
- e) e) Discuss in groups this consequence above.
- f) f) List as many as you can uses of renewable energy sources.

Read carefully these key terms in the table below then give answers to related questions.

Key Terms

Biomass energy	Energy released from plants (wood, corn, etc) through combustion or other chemical process
-----------------------	--

Fossil fuel	A non-renewable energy resource that began to form millions of years ago from the remains of once living plants and animals. Its current forms include petroleum, coal and natural gas.
Geothermal energy	Heat energy from the earth.
Hydropower	Transformation of the energy stored in a depth of water into electricity.
Non renewable energy	Resources, such as fossil fuels that cannot be replaced by natural processes at the same rate it is consumed.
Photovoltaic	A chemical process that releases electrons from a semi-conductor material in the presence of sunlight to generate electricity.
Renewable energy	Resources, such as wind and water that can be recycled or replaced at a rate faster than they are consumed.
Solar Energy	Energy from the sun; often captured directly as heat or as electricity through a photovoltaic process.
Uranium	An element that releases heat as it undergoes radioactive decay.
Wind energy	Energy transferred with the motion of air in the lower atmosphere that arises from differential heating of the earth. The energy in the wind can be extracted as mechanical energy to do work such as grind grains (a wind mill) or generate electricity (wind turbine).
Wave energy	Wave power captures the energy of ocean surface waves, and tidal power. Converting the energy of tides, are two forms of hydropower with future potential; however, they are not yet widely employed commercially.

Worldwide, wood is the largest source of biomass for non-food energy, but other sources are also used, including municipal wastes and crop wastes. Crops such as sugar cane are used to make alcohol for transportation fuel. In many developing countries, wood is the most important energy source. Global resources of geothermal energy (the heat contained below Earth's surface) are so immense that they are usually considered to be renewable. But this classification is not strictly correct, since the heat stored in any given volume of rock or underground water is depletable. In addition, the most easily accessed geothermal resources, natural hot springs and geysers, will not last for more than a few decades if exploited for energy on a large scale.

Estimates vary widely as to how long fossil fuels, oil, coal, and natural gas will last. These estimates depend on assumptions about how much fossil fuel remains in the ground, how fast it will be used, and how much money and effort will be spent to recover it. However, most estimates agree that, if present rates of consumption continue, **proven oil and natural gas reserves will run out in this century, while coal reserves will last more than 200 years. Once they are used, these energy sources cannot be replaced.**

Fossil fuel

Fossil fuels are fuels formed by natural processes such as anaerobic decomposition of buried dead organisms. The age of the organisms and their resulting fossil fuels is typically millions of years, and sometimes exceeds 650 million years. Fossil fuels contain high percentages of carbon and include coal, petroleum and natural gas.



Figure 6.1: Coal, one of fossil fuel

- How it works? - Making power from fossil fuels

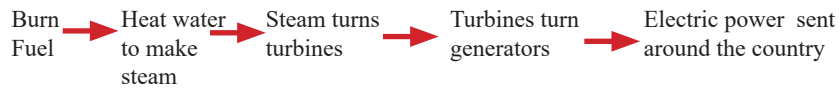

Rwanda's main fossil fuel resource is methane gas. It is estimated that there are 50 billion cubic metres of exploitable methane, which is the equivalent of 40 million tons of petrol (TOE) laying at the bottom of the Lake Kivu under 250 metres of water. Of the 55 billion cubic metres (cum) Standard Temperature and Pressure, STP) of methane gas reserves, 39 billion cum (STP) are potentially extractable. This represents a market value of USD 16 billion, equivalent to 31 million Ton Oil Equivalent (TOE). The technical and economic feasibility of methane gas exploitation has been clearly demonstrated since 1963 by the small methane extraction pilot unit at Cape Rubona with a capacity of 5000 cum of methane per day at 80 % purity. The resource is estimated to be sufficient to generate 700 mW of electricity for 55 years with Rwanda's share being 350 mW.



Figure 6.2: A methane gas extraction plant on Lake Kivu

Nuclear fuel

Nuclear fuel is a material that can be 'burned' by nuclear fission or fusion to derive nuclear energy.



Figure 6.3: Uranium, one of nuclear sources

Most nuclear fuels contain heavy fissile elements that are capable of nuclear fission. When these fuels are struck by neutrons, they are in turn capable of emitting neutrons when they break apart. This makes possible a self-sustaining chain reaction that releases energy with a controlled rate in a nuclear reactor or with a very rapid uncontrolled rate in a nuclear weapon.

“...Rwanda should choose a path to renewable energy—although nuclear is the best other alternative; Rwanda does not have the technology to generate nuclear energy.

Even if Rwanda was ready to develop it despite the international laws and regulations, nuclear energy poses a great danger especially, Rwanda being located in a volcanic region. Nuclear energy for Rwanda in my opinion is a no go option”. *New times May 21, 2015*

Renewable sources

Renewable energy is generally defined as energy that comes from resources that are not significantly depleted by their use, such as sunlight, wind, rain, tides, waves and geothermal heat. Renewable energy is gradually replacing conventional fuels in four distinct areas: electricity generation, hot water/ space heating, motor fuels, and rural (off-grid) energy services.



Figure 6.4: Sources of renewable energy

Generally, Rwanda is well endowed with renewable energy resources, but most potential still remains untapped. Micro hydro-power in particular constitutes a significant potential for rural power supply with many areas having ample rainfall and most streams and rivers unexploited. Solar irradiation is high - between 4-6 kWh/m²/day - but diffusion is hampered by high initial cost and limitations on high load usage. Biogas is promising for thermal energy needs for farms and small institutions, especially considering the large number of households that own cows and other livestock.

Geothermal

Geothermal energy is from thermal energy generated and stored in the Earth. Thermal energy is the energy that determines the temperature of matter.



Figure 6.5: Source of geothermal energy

According to a study by Geothermal Energy Association, geothermal potential in Rwanda ranges from 170 - 340 MW. In Rwanda geothermal is a main

energy policy priority and forms a significant part of the 7-year electricity development strategy including a very ambitious action plan targeting 150 MW of generation capacity by 2017 (which represents up to 50% of total generation). A Geothermal Act and a geothermal exploration and development paper have been drafted although a proposal for a feed-in-tariff for geothermal still needs to be developed. Three sites (Rubavu, Karongi and Rusizi) were identified already in the 1980's with resource temperatures in excess of 150°C which could be suitable for geothermal power generation. In early 2012, test drilling commenced to explore possibilities to harness energy in Rubavu, Karisimbi, Kinigi located in western region as well as Bugarama in southern region. The Government has self-financed and contracted the first exploratory drilling in 2013.

Biomass and biofuels

Biomass is biological material derived from living, or recently living organisms. It most often refers to plants or plant-derived materials which are specifically called *lignocellulosic biomass*. As an energy source, biomass can either be used directly via combustion to produce heat, or indirectly after converting it to various forms of biofuel. Conversion of biomass to biofuel can be achieved by different methods which are broadly classified into: *thermal*, *chemical*, and *biochemical* methods.

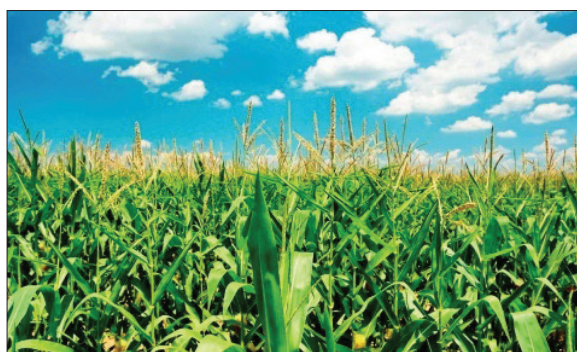

Figure 6.6: Biological material

In Rwanda, It has been observed that if an average household used 1.8 tonnes of firewood in a year to satisfy its cooking needs with a traditional stove, the same household would use 3.5 tonnes of wood if it were to switch to charcoal with an improved stove. The use of charcoal in urban areas, in combination with high urban growth rates, therefore is a worrisome phenomenon that accelerates pressure on wood resources. Peat is also a resource the government intends to promote use of. It is estimated that there exists in Rwanda estimated reserves of 155 million tons of dry peat spread over an area of about 50,000

hectares. About 77% of peat reserves are near Akanyaru and Nyabarongo rivers and the Rwabusoro plains Potential for Peat-to-Power Generation. Peat in the Rwabusoro marshland and around the Akanyaru river can fuel 450 mW of electricity generation for 25 years. Currently, a cement plant and some prisons utilize peat for cooking.

How it works - Burning landfill or digester gas to make power



Figure 6.7: Burning landfill and digester gas to make power

Biogas has been introduced in the country many years ago and Rwanda has gained international recognition for its program in prisons and large institutions. The Government in 2008 announced a policy to introduce biogas digesters in all boarding schools (estimated at around 600 schools), large health centres and institutions with canteens to reduce the consumption of firewood. This process started in 2010 but until today the focus has been mainly on installations for schools. In total, about 50 large biogas digesters have been constructed in institutions in Rwanda and the biogas systems that have been installed in the prisons over the last decade have reduced firewood consumption by up to 40% and improved hygienic conditions.



Figure 6.8: Construction works of the digester chamber for a fixed dome bio-gas plant. Biogas will play a key role in reducing pressure on the country's forests

Activities in the domestic biogas sector started much later. It is estimated that over 120,000 households have dairy cows that are kept under zero grazing conditions to reduce soil erosion and also due to lack of grazing areas. These numbers are increasing due to the governments programs to increase the number of families with dairy cows.



Figure 6.9: Use of biogas for cooking in Gicumbi district



Figure 6.10: Use of biogas for lighting in Gicumbi district

Solar energy (photovoltaic cells and solar heating panels)

Photovoltaic Cells

Solar energy, radiant light and heat from the sun, is harnessed using a range of ever-evolving technologies such as solar heating, photovoltaic, concentrated solar power, solar architecture and artificial photosynthesis.



Figure 6.11: Focusing solar energy

The Rwandan government is set to commission the first utility-scale solar photovoltaic (PV) plant at eastern Rwanda's Rwamagana district in August 2014. The project, with a production capacity of 8.5 mW, has commenced testing, stated local reports. Dutch company Gigawatt Global is the developer of the project, while Norwegian firm Scatec Solar has agreed to operate and maintain the plant.



Figure 6.12: Israel's Energiya Global is behind a new solar project in Rwanda

Solar Heating Panels

A solar thermal collector collects heat by absorbing sunlight. A collector is a device for capturing solar radiation. Solar radiation is energy in the form

of electromagnetic radiation from the infrared (long) to the ultraviolet (short) wavelengths.



Figure 6.13: In Rusizi, solar heating panels on a roof of a house

The term “solar collector” commonly refers to solar hot water panels, but may refer to installations such as solar parabolic troughs and solar towers; or basic installations such as solar air heaters.

Hydroelectric power, wind power and wave power

Hydroelectricity



Figure 6.14: Hydroelectric power station

Energy in water can be harnessed and used. Since water is about 800 times denser than air, even a slow flowing stream of water, or moderate sea swell, can yield considerable amounts of energy. Hydroelectricity is the term referring to electricity generated by hydropower; the production of electrical power through the use of the kinetic energy of falling or flowing water. It is the most widely used form of renewable energy, accounting for 16% of global electricity consumption.



Figure 6.15: Hydro electric Power Plant Project on River Nyabarongo

The country currently has about 57 MW installed hydropower generating capacity. Hydroelectric power is mainly from the northern and southern parts of the country (Musanze , Rubavu and Rusizi) namely from the following power plants: Ntaruka, Mukungwa , Rubavu, Gihira as well as Rusizi 1 and Rusizi 2. A number of new sources are supposed to come on line within the coming years adding a capacity of 232 MW by 2013. This includes the hydropower site Nyaborongo with 27.5 MW in Muhanga and Ngororero Districts planned to come on line by February 2013 but currently experiencing delays, and numerous mini/micro hydro plants adding up to 35 MW. The new hydropower plant, Rukarara located in Nyamagabe district, Southern Province, with 9.5 MW and costs of US\$ 23.5 million was commissioned in January 2011. Construction for this plant had already started in 2007.

Wind Power

Airflows can be used to run wind turbines. Modern utility-scale wind turbines range from around 600 kW to 5 MW of rated power, although turbines with rated output of 1.5–3 MW have become the most common for commercial use; the power available from the wind is a function of the cube of the wind speed, so as wind speed increases, power output increases up to the maximum output for the particular turbine.



Figure 6.16: Airflow can run a turbine

Wind Potential in Rwanda has not been fully exploited for power generation although potential wind power that Rwanda has in some areas may provide with possible solutions such as water pumping, windmill and electricity generation. A study of wind speed distribution has been made. (In this study, the results have been found for the average wind speeds and directions for 3 stations (Kigali, Rubavu and Huye) from 1985 to 1993.

These results can be summarised as follows:

- Direction of wind varies from 11 to 16°.
- Wind speed varies from 2 to 5.5m/s

The analysis of the wind energy possible solution for energy supply in rural areas of Rwanda, was undertaken to estimate the wind power potential. In total data from 4 stations (Kamembe, Huye, Nyagatare and Rubavu) have been analysed by the National Meteorological Division in 1989. Once again, the data from 3 synoptic sites (Kigali, Huye and Rubavu) are analysed by the Weibull function. The considered data has been used to evaluate the annual frequency of wind speed and the direction of wind, yearly variation of the monthly average, annual and daily variation, and vertical profile of wind energy potential. Nevertheless more detailed data is still required. In 2010 a wind system was put in place to serve the Rwanda office of information RBA on Mount Jali overlooking Kigali. This is the same site for the 250KW solar system feeding to the grid. There is need for more thorough assessment of the wind potential in the country.

Wave Power

Wave power captures the energy of ocean surface waves, and tidal power, converting the energy of tides, are the two forms of hydropower with future potential; however, they are not yet widely employed commercially.



Activity 2

Energy Source research

Purpose

Although most of the energy consumed in Rwanda comes from fossil fuel sources, there are many other potential sources of energy available. In all cases, there are pros and cons (advantages and disadvantages) to our use of these sources. Some of the energy sources are limited by their availability or environmental impact; others need technological improvements before they can become widely used. For scientists and engineers, research is the best way to learn about unknown topics.

In this section, we will examine information about energy sources and how those sources are used to produce electrical energy. We can use this information to help us understand the various pros and cons that affect our use of different energy sources. In this activity, each group of students will begin to become an expert on one aspect of each source of energy and report their findings back to the class.

Procedure

1. Break into a group of 2-3 learners.
2. Choose or accept an assignment to research one particular question about each source of energy.
3. Using the provided information packet, find the answer to your question for all seven energy sources.
4. Once you have answered your question for all seven sources, answer the two conclusion questions.

As a class, we will fill in the energy sources chart based on your findings.

Research Questions

1. What is this energy source? Where can we find it in Rwanda?
2. How do we harness the energy? (How does it work?)
3. Are there different types or uses of this source? If yes, what are the differences?
4. How is this energy source currently used? For example: At farms, in industry etc. Could this source be used in a family home?

Note: Prepare a report summarizing your research and present the report to the class.

Primary energy sources take many forms, including nuclear energy, fossil energy-like oil, coal and natural gas - and renewable sources like wind, solar, geothermal and hydropower. These primary sources are converted to electricity, a secondary energy source, which flows through power lines and other transmission infrastructure to your home and business.



Activity 3

Discussion Questions

1. If you had to choose an energy system to tell your community about based only on the aspect you researched, which system would you choose? Why?
2. Why do we as a nation depend so much on fossil fuels? **AND** what do you think we could do to reduce this dependence on fossil fuels?

Note: Prepare a report summarizing your research and present the report to the class.

Energy source	“Pros”	“Cons”
Biomass		
Fossil fuels		
Geothermal		
Hydropower		
Nuclear		
Solar		
Wind		

While listening to the other groups in your class present their information, list some “pros” and “cons” (advantages and disadvantages) of using their energy source to solve your problem. While listening to the students in your group present their information, list some “pros” and “cons” of using that energy source to solve the energy problem.

Advantages and disadvantages of renewable and non-renewable energies



Activity 6

Do research in the library or internet and complete the task below

- Complete the chart below about the basic types of renewable energy resources.

Type	Definition	Examples	Advantages	Disadvantages
Solar				
Hydropower				
Wind Energy				
Geothermal				
Biomass				

- List those energy sources that are fossil fuels.

- What main advantage do fossil fuels have over the renewable energy resources?

- What are two main disadvantages of fossil fuels compared to renewable energy?

The sun, prime source of world energy

Solar energy comes from thermonuclear fusion; 30% of solar energy arriving on higher layers of atmosphere are reflected in space. 47% of that energy are absorbed by the ground and oceans during daytime and become the Earth's internal energy. The remaining 23% of solar energy are used in evaporation of water of oceans. When it rains, a part of energy is transformed into potential gravitational energy, stocked in mountains, lakes, which are the sources of hydroelectric power. About 0.2% is used by convection currents in atmosphere and creates wind energy. Finally 0.02% is absorbed by plants during photosynthesis and is stocked by them in form of chemical energy.

Plants are sources of biomass. Photovoltaic cells transform solar energy in electrical energy.

The table below show the summary of energy sources

Energy source	Advantages	Disadvantages
Solar	<ul style="list-style-type: none"> • Unlimited supply. • Causes no air or water pollution. 	<ul style="list-style-type: none"> • May not be cost effective. • Storage and backup are necessary. • Reliability depends on availability of sunlight.
Hydropower	<ul style="list-style-type: none"> • Abundant, clean, and safe. • Easily stored in reservoirs. • Relatively inexpensive way to produce electricity • Offers recreational benefits like boating, fishing, etc. 	<ul style="list-style-type: none"> • Can have a significant environmental impact. • Can be used only where there is a continuous water flow. • Best sites for dams have already been developed.
Fossil fuels	<ul style="list-style-type: none"> • Available in plenty. • Easier to find. • Extremely efficient. • Easier to transport. • Generate thousands jobs. • Easy to set up. 	<ul style="list-style-type: none"> • Environment degradation. • Need truckloads of reserves. • Public health issues. • Finite energy source. • Rising cost. • Health of coal-mining workers.
Wind	<ul style="list-style-type: none"> • Is a “free” source of energy. • Produces no water or air pollution. • Wind farms are relatively inexpensive to build. • Land around wind farms can have other uses. 	<ul style="list-style-type: none"> • Requires constant and significant amounts of wind. • Wind farms require significant amounts of land. • Can have a significant visual impact on landscapes.
Nuclear	<ul style="list-style-type: none"> • Lower greenhouse gas emissions. • Powerful and efficient. • They can produce power continuously and need to be shut down for maintenance purpose only. We say they are reliable. • Cheap electricity. 	<ul style="list-style-type: none"> • High construction costs due to complex radiation containment systems and procedures. • High subsidies needed for construction and operation, as well as loan guarantees. • High-known risks in an accident. • Unknown risks for others.
	<ul style="list-style-type: none"> • Low fuel cost. • Easy transportation. 	<ul style="list-style-type: none"> • Long construction time. • Target for terrorism (as are all centralized power generation sources).

biomass	<ul style="list-style-type: none">• Abundant and renewable.• Can be used to burn waste products.	<ul style="list-style-type: none">• Burning biomass can result in air pollution.• May not be cost effective.• May result in deforestation.
geothermal	<ul style="list-style-type: none">• Provides an unlimited supply of energy.• Produces no air or water pollution.	<ul style="list-style-type: none">• Start-up/ development costs can be expensive.• Maintenance costs, due to corrosion, can be a problem.

Extraction and creation of renewable and non-renewable energy sources

Activity 5



Creation of renewable and non renewable energy

From what you have already learned, you'll do also research and tell how these energies are created: Solar energy, hydropower, wind energy, geothermal energy, and biomass. Try to find or to formulate how they are extracted.

You'll fill the table below

Energy	Creation	Extraction
Solar		
Hydropower		
Wind		
Geothermal		
Biomass		
Nuclear		
Fossil fuel		

Creation

Non-renewable resources

A non-renewable resource (also called a finite resource) is a resource that does not renew itself at a sufficient rate for sustainable economic extraction in meaningful human time-frames. An example is carbon-based, organically-derived fuel. The original organic material, with the aid of heat and pressure, becomes a fuel such as oil or gas.

Earth minerals and metal ores, fossil fuels (such as coal, petroleum, and natural gas), nuclear fuels, and groundwater in certain aquifers are all non-renewable resources.

Natural resources such as coal, petroleum (crude oil) and natural gas take thousands of years to form naturally and cannot be replaced as fast as they are being consumed. Eventually it is considered that fossil-based resources will become too costly to harvest and humanity will need to shift its reliance to other sources of energy. These resources are yet to be named.

Renewable resources

Natural resources, known as renewable resources, are replaced by natural processes and forces persistent in the natural environment. There are intermittent and reoccurring renewable and recyclable materials, which are utilized during a cycle across a certain amount of time, and can be harnessed for any number of cycles.

The production of goods and services by manufacturing products in economic systems creates many types of waste during production and after the consumer has made use of it. The material is then incinerated, buried in a landfill or recycled for reuse. Recycling turns materials of value that would otherwise become waste into valuable resources again.

The natural environment, with soil, water, forests, plants and animals are all renewable resources, as long as they are adequately monitored, protected and conserved. Sustainable agriculture is the cultivation of plant and animal materials in a manner that preserves plant and animal ecosystems over the long term. The overfishing of the oceans is one example of where an industry practice or method can threaten an ecosystem, endanger species and possibly even determine whether or not a fishery is sustainable for use by humans. An unregulated industry practice or method can lead to complete resource depletion.

Extraction

Resource extraction involves any activity that withdraws resources from nature. This can range in scale from the traditional use of preindustrial societies, to global industry. Extractive industries are, along with agriculture, the basis of the primary sector of the economy. Extraction produces raw material which is then processed to add value. Examples of extractive industries are hunting, trapping, mining, oil and gas drilling, and forestry. Natural resources

can add substantial amounts to a country's wealth, however a sudden inflow of money caused by a resource boom can create social problems including inflation harming other industries ("Dutch disease") and corruption, leading to inequality and underdevelopment, this is known as the "resource curse".

The table below show the summary of creation and extraction of energy

Energy	Creation	Extraction
Geothermal	Geothermal energy comes from the intense heat within the earth. The heat is produced by the radioactive decay of elements below the earth's surface.	Hydrothermal energy has two basic ingredients: water and heat. Water beneath the earth's surface contacts the heated rocks and changes into steam. Depending on the steam's temperature, it can heat buildings directly or can power turbines to generate electricity
Wind	Wind is air in motion. It is caused by the uneven heating of the earth's surface by the sun.	Wind power has been used for thousands of years to convert the wind's kinetic (motion) energy into mechanical energy for grinding grain or pumping water. Today, wind machines are used increasingly to produce electricity.
Solar	Is produced in the core of the sun. In a process called nuclear fusion, the intense heat in the sun causes hydrogen atoms to break apart and fuse together to form helium atoms. A very small amount of mass is lost in this process.	Solar Power is extracted by turning the sun's rays into useful energy that can be used to power homes and businesses. Solar Power is processed and refined by the PV panels use the photovoltaic effect to convert the energy from the sun into electricity, which can then be used to replace a buildings usual supply of electricity
Hydropower	Is energy that comes from the force of moving water. Hydropower is a renewable energy source because it is replenished constantly by the fall and flow of snow and rainfall in the water cycle.	As water flows through devices such as a water wheel or turbine, the kinetic (motion) energy of the water is converted to mechanical energy, which can be used to grind grain, drive a sawmill, pump water, or produce electricity

Biomass	Biomass is any organic substance that can be used as an energy source. The most common examples are wood, crops, seaweed, and animal wastes.	The energy is stored in biomass through the process of photosynthesis, in which plants combine carbon dioxide, water, and certain minerals to form carbohydrates. The most common way to release the energy from biomass is burning. Other less used ways are bacterial decay, fermentation, and conversion.
Fossil fuel	It is almost impossible to ignore fossil fuel use in the world today. Fossil fuels come in three main forms: coal, natural gas and petroleum (oil). Fossil fuels were created by dead organic matter millions of years ago.	Extraction produces raw material which is then processed to add value. Examples of extractive industries are hunting, trapping, mining, oil and gas drilling, and forestry.

END UNIT ASSESSMENT

1. Differentiate between renewable and non-renewable energy resources?
2. Using a table to distinguish renewable and nonrenewable resources:
Sun, coal, water, natural gas, wood, petroleum, wind, nuclear fission, biomass
3. Which instrument is used to measure a wind energy?
4. What kind of energy will people be using in the future? Why?
5. What are benefits of renewable energy?
6. Why don't people use more renewable energy now?
7. Are there reasons to use more renewables now rather than wait until the non-renewables run out?

Unit

7

Projectile and uniform circular motion

Key Unit Competence

Analyse and solve problems related to projectile and circular motion.

My goal

By the end of this unit, I will be able to:

- * define and explain terms used in projectile motion.
- * discuss the different applications of projectile motion.
- * apply concepts of projectile and circular motion in real life.
- * differentiate between projectile motion and circular motion.

Introductory activity

Take the case of a basketball player shooting the ball into the basket's net from a given distance at a given angle as shown in the figure below then answer to the following questions.



1. Discuss on the motion of the ball after being shot
2. Discuss other situation where one can observe such a kind of motion.
3. Explain how this kind of motion is important in normal life activities.
4. Contrast between projectile motion and circular motion using typical examples.

Introduction

We have different kinds of sports, for examples; football, netball, tennis amongst others. A lot of reasoning is needed while playing football to score one of which is to kick a ball at a certain angle (i.e. to move above the ground). We say that the ball is projected. This also applies to basket ball; the ball to enter the round ring for a score it has to be thrown at a certain angle. Hence, projected. The same principle is used by the military in shooting and launching their missiles.

Projectile Motion



Activity 1: Field study

Aim; *To study motion of bodies in free space*

- a) Out of class, (in pitch, or in school compound), throw a ball, a stone or any body upward.
- b) State what happens.
- c) Hold a ball in your hands and release it to fall.
- d) Is the motion of the ball same as in the first case?
- e) Note down your observation.
- f) Relate your observations for bodies moving linearly.

Caution

While throwing a stone or any body, take care so that it does not harm you.

We can define a projectile as any body thrown into space/air. The path taken is called a trajectory. The motion of a projectile unless taken otherwise is a free motion under gravity. We assume that air resistance is negligible in this kind of motion.

We have three cases: oblique projection, vertical projection and horizontal projection.

Projection at an angle above the horizontal

- Study the picture below carefully.
- Go outside class and try to kick the ball so that it does not roll on the ground.
- State when will the ball cover a long horizontal range. (State down the conditions for that to occur).



Figure 7.1: A football player kicking a ball at a certain angle

From the figure above, if the ball is kicked so that it does not roll on the ground, it will move at certain angle *relative to the ground*.

Activity 2



- In the ground, kick the football individually.
- By observing, the flight of the ball state whether it will cover a longer horizontal distance when it is projected at a large angle or a small angle.
- Explain your observation and note down any key points in your book.

Consider a projectile having a certain mass, projected at a speed \vec{v}_0 at an angle α to the horizontal.

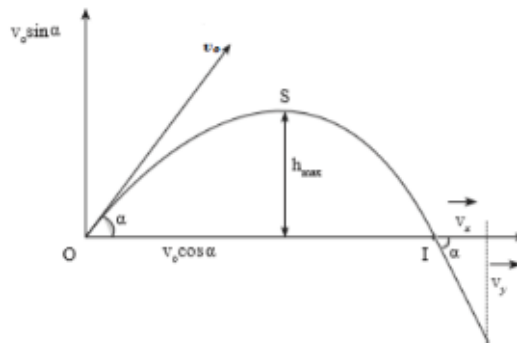

Figure of graph of projectile motion

Upward projection

From the figure above, a football player can kick the ball and it takes the motion of a projectile.



Figure 7.2: An object thrown at an angle above the horizontal

This is the motion in the x - y plane; we consider axis OX and OY . \vec{v}_0 has two components even the acceleration. We have:

For the acceleration; $\begin{cases} \vec{a}_x = 0 \\ \vec{g}_y = -\vec{g} \end{cases}$ Thus:

For the velocity \vec{v}_0 : $\begin{cases} v_x = u_x - at \\ \quad = v_0 \cos \alpha \\ v_y = u_y + at \\ \quad = v_0 \sin \alpha - gt \end{cases}$

According to OX axis, we have the rectilinear uniform motion whose velocity is constant and has value $v_{ox} = v_o \cos \alpha = \text{constant}$

According to OY axis, we have the uniform decelerated rectilinear motion with acceleration $v_o \sin \alpha - gt$.

Equations of the Motion

For horizontal motion,

$\alpha_x = 0$, $u_x = v_o \cos \alpha$, constant and $x = u_x + \alpha_x t$, we have

$$x = x = v_o t \cos \alpha \quad (1)$$

For vertical motion,

$$\begin{aligned} v_y &= v_y + \alpha_y t \\ &= v_o \sin \alpha - gt \quad (2) \end{aligned}$$

$$\begin{aligned} \text{height } y &= u_y t + \frac{\alpha_y t^2}{2} \\ &= tv_o \sin \alpha - \frac{gt^2}{2} \quad (3) \end{aligned}$$

Equations (1) and (3) represent the parametric equations of the motion.

Using the equations developed above, obtain the parametric equation.

$$\text{We have: } y = xt \tan \alpha - \frac{1}{2} g \left(\frac{x^2}{v_o^2 \cos^2 \alpha} \right) \quad (4)$$

The equation (4) is the equation of trajectory for body moving under projectile motion.

Calculation Of The Maximum Height

Let y_{\max} be the maximum height reached by the projectile.

$y = y_{\max}$ if and only if $v_y = 0$ and $v_o \sin \alpha - gt$

$$0 = v_o \sin \alpha - gt \quad t = \frac{v_o \sin \alpha}{g} \quad (5)$$

The relation gives the time taken to reach the maximum height y_{\max} (h_{\max})

Let us introduce (5) in (3), we find:

$$\begin{aligned}
 h_{max} &= 0 - \frac{g}{2} \left(\frac{v_0 \sin \alpha}{g} \right)^2 \\
 &= \frac{v_0^2 \sin^2 \alpha}{2g} \\
 h_{max} &= \frac{v_0^2 \sin^2 \alpha}{2g}
 \end{aligned}$$

Therefore: h is negative because its direction is opposite to the direction of g .

The Horizontal Range of the Projectile

The horizontal distance travelled by a projectile from the initial position ($x = y = 0$) to the position where it passes $y = 0$ during its fall is called the *horizontal range* R .

It's the horizontal distance travelled during the time of flight t_f .

To calculate this range denoted by R , it's important to know that $R = x_{max}$.

When $y = 0$ and $y = x \tan \alpha - \frac{1}{2} g \frac{x^2}{v_0^2 \cos^2 \alpha}$,

$$x \tan \alpha - \frac{1}{2} g \frac{x^2}{v_0^2 \cos^2 \alpha} = 0$$

$$\text{We have: } x \left(\tan \alpha - \frac{1}{2} g \frac{x}{v_0^2 \cos^2 \alpha} \right) = 0$$

$x_1 = 0$, x_1 represents the initial position

$$\tan \alpha - \frac{1}{2} g \frac{x^2}{v_0^2 \cos^2 \alpha} = 0 \rightarrow \tan \alpha = \frac{1}{2} g \frac{x^2}{v_0^2 \cos^2 \alpha}$$

$$x_{max} = \frac{2v_0^2 \sin \alpha \cos \alpha}{g}$$

$$\Rightarrow R = x_{max} = \frac{v_0^2 \sin 2\alpha}{g}$$

We can show this relation using another way:

$$R = (v_0 \cos \alpha) t_f \text{ where } t_f = \frac{2v_0 \sin \alpha}{g} \text{ is the total time of the flight because}$$

$$\begin{aligned}
 t_f &= t_{um} + t_m \\
 R &= v_0 \cos \alpha \times \frac{2v_0 \sin \alpha}{g} = \frac{2v_0^2 \sin \alpha \cos \alpha}{g}
 \end{aligned}$$

$$R = \frac{v_0^2 \sin 2\alpha}{g}$$

Velocity at a given point a of the trajectory

At each time: $v^2 = v_x^2 + v_y^2$, $\sqrt{v_x^2 + v_y^2}$, where $v_x = v_0 \cos \alpha$ and $v_y = v_0 \sin \alpha - gt$

$$v = \sqrt{v_0^2 \cos^2 \alpha + (v_0 \sin \alpha - gt)^2}, \quad v = \sqrt{v_0^2 \cos^2 \alpha + v_0^2 \sin^2 \alpha - 2v_0 \sin \alpha \cdot gt + g^2 t^2}$$

$$\Rightarrow v = \sqrt{v_0^2 (\cos^2 \alpha + \sin^2 \alpha) - 2v_0 \sin \alpha \cdot gt + g^2 t^2}$$

$$\Rightarrow v = \sqrt{v_0^2 - 2gtv_0 \sin \alpha + g^2 t^2}$$

Example

1. A particle is projected from a point on a horizontal plane and has an initial velocity of 45 ms^{-1} at an angle of elevation of $\tan^{-1}\left(\frac{3}{4}\right)$. Find the time of flight and the range of the particle on the horizontal plane.

Solution

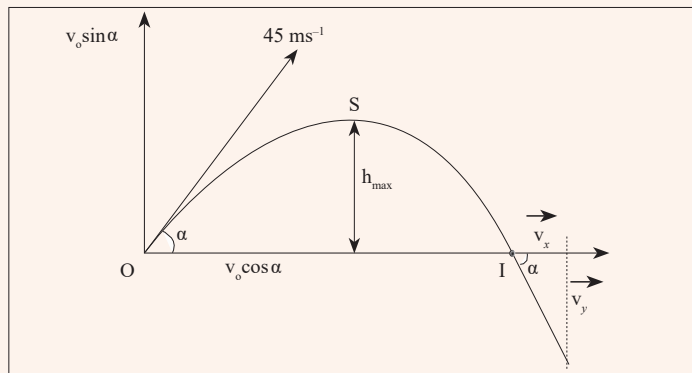

Figure 7.3: Showing movement of a particle at an angle

Vertical Motion

The total time of the flight can be found from the equation:

On Y-axis, $y = v_0 \sin \alpha t - \frac{1}{2} g t^2$

$$\alpha = \tan^{-1}\left(\frac{3}{4}\right) \Rightarrow \alpha = 36.9, \sin \alpha = 0.60042$$

$$45 \times 0.60042t - \frac{1}{2} \times 4.9^2 = 0$$

$$t(27.009 - 4.9t) = 0$$

$$\text{Either } t = 0 \text{ or } 27.009 - 4.9t = 0 \Rightarrow t = \frac{27.009}{4.9} = 5.5s$$

Then the total time of flight is 5.5s

The range $R = v_0 \cos \alpha t$, $\cos \alpha = 0.7997$

$$R = 45 \times 0.7997 \times 5.5 = 247.5m$$

Downward projection

Note:

The motion of the projectile has also two components:

- a) A rectilinear uniform motion in the horizontal direction with velocity $v_{ox} = v_0 \cos \alpha$ and parametric equation $x = (v_0 \cos \alpha)t$.
A vertical accelerated motion downward in the vertical direction with initial velocity: $v_{oy} = v_0 \sin \alpha$, acceleration $\gamma = g$ and parametric equation: $y = (v_0 \sin \alpha)t + \frac{1}{2}gt^2$.

Thus the parametric equations are:
$$\begin{cases} x = (v_0 \cos \alpha) t & (1) \\ y = (v_0 \sin \alpha) t + \frac{1}{2}gt^2 & (2) \end{cases}$$

where t is the parameter.

From (1): $t = \frac{x}{v_0 \cos \alpha}$, t in $y = v_0 \sin \alpha \cdot \frac{x}{v_0 \cos \alpha} + \frac{1}{2}g \left(\frac{x}{v_0 \cos \alpha} \right)^2$

$y = x \tan \alpha + \frac{g}{2v_0^2 \cos^2 \alpha} x^2$ is the equation of the trajectory. The trajectory is

a path taken by the projectile.

Velocity at a given point of the trajectory, $\vec{v} = \vec{v}_x + \vec{v}_y$, $v = \sqrt{v_x^2 + v_y^2}$, with $v_x = v_0 \cos \alpha$ and $v_y = v_0 \sin \alpha + gt$

$$v = \sqrt{v_0^2 \cos^2 \alpha + (v_0 \sin \alpha + gt)^2}$$

Horizontal projection



Activity 3

- Place a stone on top of a table.
- Displace it so that its motion takes the shape below.
- Try to observe the motion carefully.
- Note down what you observe and share it with your class members.

Take care

In throwing the stone / displacing it, you should take care so that it does not hit you because it may harm you.

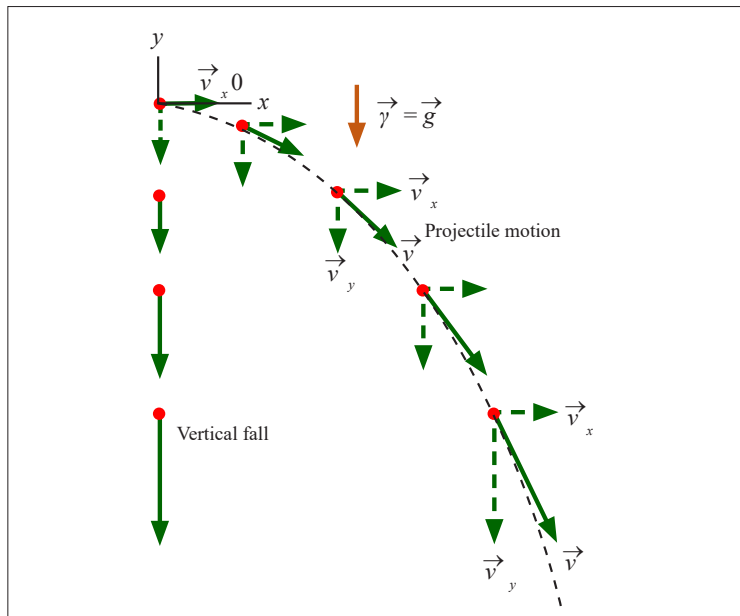

Figure 7.4: An object thrown horizontally

For horizontal motion; $v_x = v_o \cos \theta$ but $\theta = 0$

According to Ox, we have RUM with $v_x = v_o$ constant

According to OY, we have a free fall with $v_{0y} = 0$ and $v_y = gt$

Parametric equations are:

$$x = v_0 t \quad (1)$$

$$y = \frac{1}{2} g t^2 \quad (2)$$

From (1) $t = \frac{x}{v_0}$, in (2) $y = \frac{1}{2} g \frac{x^2}{v_0^2}$, represents the equation of a parabola

The speed at a given point of the trajectory is $v = \sqrt{v_x^2 + v_y^2} = \sqrt{v_0^2 + g^2 t^2}$

Vertical projection

For this case, we consider the oblique projection where $\alpha = \frac{\pi}{2}$. We find the equations for vertical projection.



Activity 4

Using the information given above;

- Derive the equations for the motion.
- Study the picture below and do the same.
- State the condition when the body attains maximum height.

$$v = 0\text{m/s}$$

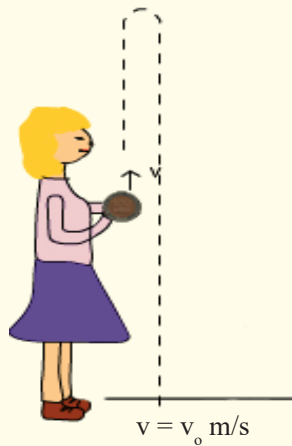

Figure 7.5: Showing the path taken by a body when thrown vertically

Examples of application of projectile motions are as follow:

- Football kicked in a game
- A cannonball fired from a cannon.
- A bullet fired from a gun
- A disc thrown in the sport of discus throw.
- The flight of golf ball.
- A jet of water escaping a hose.
- Motorcycles and cars jumping in extreme sports

Application activity 7.1

1. A gun has a muzzle velocity of v (i.e. a shell leaves the gun with an initial speed of v). Find the horizontal range of the gun when the angle of projection is 30° . Find also the maximum horizontal range of the gun.
2. A stone is thrown from the top of a cliff (as shown in figure below) 70 m high at an angle of 30° below the horizontal and the sea 20 m from the bottom of the cliff. Find the initial speed of the stone and the direction in which it is moving when it hits the sea.

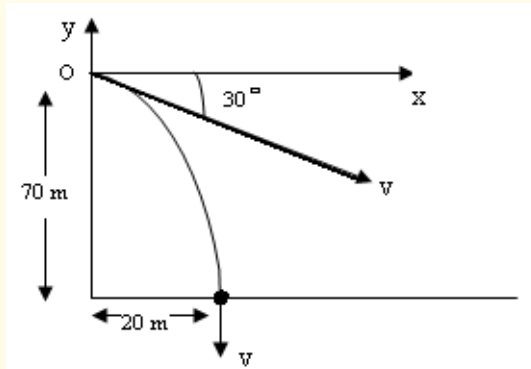

3. A man fires a rock out of a slingshot directly upward. The rock has an initial velocity of v . How long will it take for the rock to return to the level he fired it at?

Circular motion



Activity 5

Study carefully the motion of the ball shown below.
 State what would happen if at any point the thread holding the ball breaks?
 Note and record your observation.

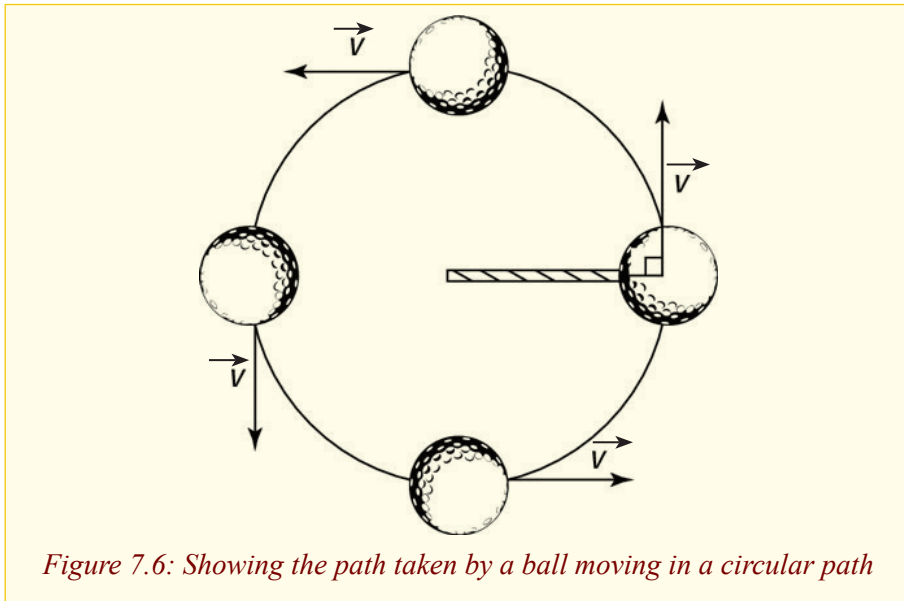

Figure 7.6: Showing the path taken by a ball moving in a circular path

A motion is said to be circular if the trajectory is a circle of constant radius R .

The motion is *uniform* if the body describes in equal angular displacements in equal times.. Even if the motion is uniform, it has an acceleration because the velocity changes after every moment since its direction keeps changing.

Angular displacement θ

Definition of key terms in circular motion

1. **Angular displacement** is the angle through which an object moves on a circular path.

$$\theta = \theta_0 + \omega t$$

2. **Linear velocity** is the measure o the rate of change of displacement with respect to the time when the object moves along a straight path. it is a vector quantity.



$$v_r = r \times \omega$$

3. **Angular velocity** is the rate change of angular position of rotating body.

$$\omega = \frac{d\theta}{dt}$$

4. **Angular acceleration** is the time of rate change of angular velocity.

$$\alpha = \frac{d^2\theta}{dt^2}$$

5. **Linear acceleration** is defines as the rate change of velocity without change in the direction.

Centripetal acceleration

As we said, in a circular uniform motion, there is acceleration. This acceleration is called centripetal acceleration. The easiest way of proofing this formula is as follow:

Consider an object moving with a constant speed (a scalar which has no direction) round a circle of radius r .

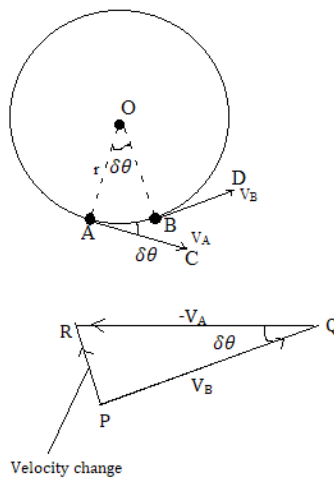

Velocity change from A to B $= \vec{v}_B - \vec{v}_A = \vec{v}_B + (-\vec{v}_A)$. PQ is drawn to represent in magnitude v_B as v and the direction (BD); QR ton represent in magnitude $(-v_A)$ as v and direction CA .

$$\text{Velocity change} = \vec{v}_B + (-\vec{v}_A) = \vec{PR}$$

When Δt is small , the angle AOB or is small . thus angle PQR , equal

to $\Delta\theta$, is small. PR then the points towards O, the Centre of the circle the velocity change or acceleration is directed towards the Centre. the magnitude of the acceleration a is given by

$$a = \frac{\text{velocity change}}{\text{time}} = \frac{PR}{\Delta t}$$

$$a = \frac{v\Delta\theta}{\Delta t}$$

Since $PR = v\Delta\theta$.

The limit when Δt approaches zero,

$$\frac{\Delta\theta}{\Delta t} = \frac{d\theta}{dt} = \omega$$

the angular speed. But $v = r\omega$, hence, since $a = v\omega$ This implies that

$$a = \frac{v^2}{r} \text{ or } r\omega^2$$

Periodic time, frequency



Activity 6

- * Go to the play ground.
- * Make sure you round the playground two times.
- * Note and observe the time taken to make one complete revolution.
- * What do you call the time taken to move around the play ground.

I should know that:

- **Period [T]:** The period is the time taken for a full revolution of the motion $\theta = \omega t$ if $\theta_0 = 0$

For one turn, $\theta = 2\pi$ rad and $t = T$

We have: $2\pi = \omega T$

Then

$$T = \frac{2\pi}{\omega} \text{ and } \omega = \frac{2\pi}{T}$$

↓ [s]
↘ [rad]
↘ [rad/s]

From the activity 6, you made two rounds in a given time. The number of rounds made in a Unit time is called frequency.

Therefore,

- **Frequency [f]**: is the number of rotation per unit time

$$\text{It's given by } f = \frac{1}{T} = \frac{\omega}{2\pi} \Rightarrow \omega = 2\pi f$$

Notice: In S.I units, the frequency is in [rotations/sec], unit called *Hertz* [Hz].

In summary

Key terms	Symbol	Formula	Unit
Angular displacement	θ	$\theta = f(t)$	[rad]
Curvilinear displacement	S	$S = f(t)$	[m]
Angular velocity	ω	$\omega = \frac{\Delta\theta}{\Delta t}$	[rad/s]
Linear velocity	v	$v = \frac{\Delta S}{\Delta t}$	[m/s]
Angular acceleration	A	$A = \frac{\Delta\omega}{\Delta t}$	[rad/s ²]
Acceleration	γ	$\left\{ \begin{array}{l} \text{centripetal acceleration } \gamma_c = R \left(\frac{d\theta}{dt} \right) \\ \text{tangential acceleration } \gamma_T = R \left(\frac{d^2\theta}{dt^2} \right) \end{array} \right.$	[m/s ²] [m/s ²]

Distance time-graph of a uniform circular motion

When an object executes a circular motion of constant radius R , its projection on an axis executes a motion of amplitude a that repeats itself back and forth, over the same path.

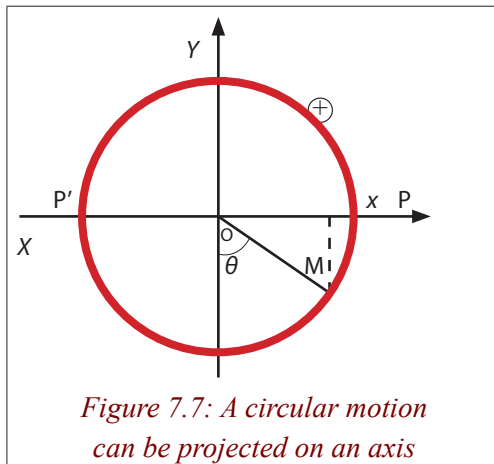

When M executes a uniform circular motion, its projection on X-axis executes a back and forth motion between positions P and P' about O.

Considering the displacement and the time, we find the following graph

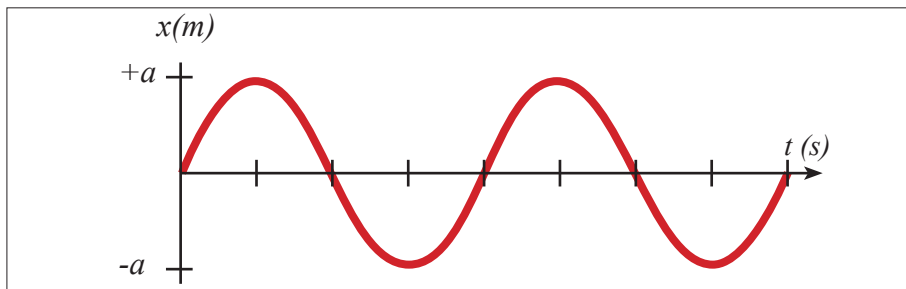

Figure 7.8: Distance-time graph of a uniform circular motion

Example

1. A 40 kg child sits on the edge of a carnival ride at a radius of 4 m. The ride makes 3 revolutions in 6 s.

(a) The period of revolution for this ride is

- (A) $\frac{1}{2}$ rev/s
- (B) $\frac{1}{2}$ s
- (C) 2 rev/s
- (D) 2 s
- (E) 4 s

(b) The speed of the child is most nearly

- (A) 4 m/s
- (B) 12 m/s
- (C) 24 m/s
- (D) 120 m/s
- (E) 360 m/s

Solution

(a) C

$$\text{Period } T = \frac{6 \text{ s}}{3 \text{ rev}} = 2 \text{ s}$$

(b) B

$$v = \frac{2\pi r}{T} = \frac{2\pi(4 \text{ m})}{2 \text{ s}} = 12 \text{ m/s}$$

2.A 150 g ball at the end of a string is revolving uniformly in horizontal circle of radius 0.600 m; the ball makes 2.00 revolutions in a second. What is its centripetal acceleration?

Solution

If the ball makes two complete revolutions per second then the Period is

$$T = \frac{1}{f} = 0.500 \text{ s}$$

The distance traveled in this time is the circumference of the circle, therefore the ball has speed:

$$v = \frac{2\pi r}{T} = 7.54 \text{ m/s}$$

The centripetal acceleration is

$$a_R = \frac{v^2}{r} = 94.8 \text{ m/s}^2$$

Centripetal force

If you try to move / run in a circular path, you will finally notice that you keep moving in a circle even when you try to stop. There is a force that keeps you more in a circular path called **centripetal force**.

Since a body moving in a circle (or a circular arc) is accelerating, it follows from Newton's first law of motion that there must be force acting on it to cause the acceleration.

This force, like the acceleration, will also be directed toward the centre and is called the *centripetal force*. The value F of the centripetal force is given by Newton's second law, that is:

$F = m\gamma = \frac{mv^2}{R}$ Where m is the mass of the body and v is its speed in circular path of radius R . If the angular velocity of the body is ω , we can also say, since $v = R\omega$,

$$F = mR\omega^2$$

When a ball is attached to a string and is swung round in horizontal circle, the centripetal force which keeps it in a circular orbit arises from the tension in the string.

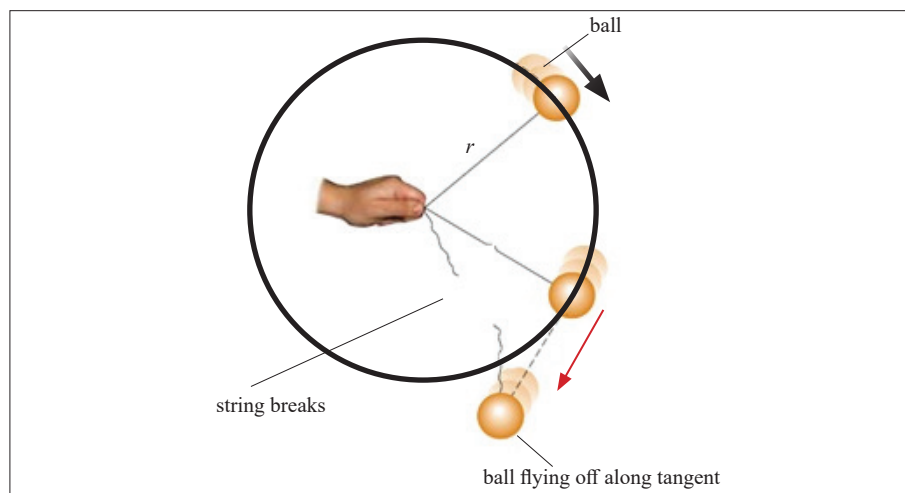

Figure 7.9: Increasing the velocity, the tension in the string increases and the string can break

Other examples of circular motion will be discussed. In all cases, it is important to appreciate that the forces acting on the body must provide a resultant force of magnitude $\frac{mv^2}{R}$ toward the centre.

Example

1. A 40 kg child sits on the edge of a carnival ride at a radius of 4 m. The ride makes 3 revolutions in 6 s. The force which is holding the child on the ride is most nearly

- (A) 30 N
- (B) 160 N
- (C) 320 N
- (D) 1440 N
- (E) 2880 N

Solution

D

$$F = \frac{mv^2}{r} = \frac{(40 \text{ kg})(12 \text{ m/s})^2}{4 \text{ m}} = 1440 \text{ N}$$

2. Estimate the force a person must exert on a string attached to a 0.150 kg ball to make the ball revolve in a horizontal circle of radius 0.600 m. The ball makes 2.00 revolutions per second.

Answer:

$$F = \frac{mv^2}{r} = \frac{m(2\pi fr)^2}{r} = 4m\pi^2 fr = 14 \text{ N}$$

Application of circular motion

Vertical and horizontal circle

Vertical circle

Taking the approach that the ball moves in a vertical circle and is not undergoing uniform circular motion, the radius is assumed constant, but the speed v changes because of gravity. Nonetheless, the formula of centripetal

acceleration is valid at each point along the circle, and we use it at point 1 and 2. The free-body diagram is shown in the figure 8.10 for the positions 1 and 2.

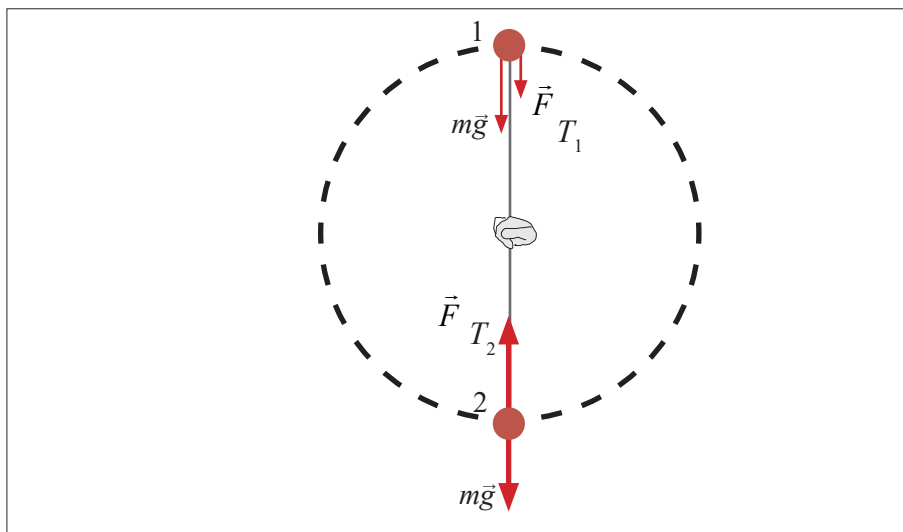

Figure 7.10. Free-body diagrams for position 1 and 2

- a) At the top (point 1), two forces act on the ball: the force of gravity and the tension force the cord exerts at point 1. Both act downward and their vector sum acts to give the ball its centripetal acceleration. We apply Newton's second law, for a vertical direction, choosing downward as positive since the acceleration is downward (toward the centre):

$$\sum \vec{F} = ma \Rightarrow F_{T_1} + mg = m \frac{v_1^2}{r} \quad (\text{at top})$$

From this equation, we can see that the tension force F_{T_1} at point 1 will get larger if v_1 (ball's speed at top of circle) is made larger, as expected.

But we are asked for the minimum speed to keep the ball moving in a circle. The cord will remain taut as long as there is tension in it. But the tension disappears (because v_1 is too small), the cord can go limp and the ball will fall out of its circular path. Thus, the minimum speed will occur if $F_{T_1} = 0$, for

which we have: $mg = m \frac{v_1^2}{r}$ (minimum speed at top)

We solve for v_1 : $v_1 = \sqrt{gr}$

This is the minimum speed at the top of the circle if the ball is to continue moving in a circular path.

- b) When the ball is at the bottom of the circle (point 2 in the figure 8.10), the cord exerts its tension force F_{T_2} upward, whereas the

force of gravity, still acts downward. So we apply Newton's second law, this time choosing upward as positive since the acceleration is upward (toward the centre):

$$\sum F = m\gamma \Rightarrow F_{T_2} - mg = m \frac{v_2^2}{r} \quad (\text{at bottom})$$

$$\text{We solve for } F_{T_2}: \sum F = m\gamma \Rightarrow F_{T_2} = mg + m \frac{v_2^2}{r}$$

The second case is the case of a force on revolving ball (horizontal) which is: Estimate the force a person must exert on a string attached to a ball to make the ball revolve in a horizontal circle of radius r .

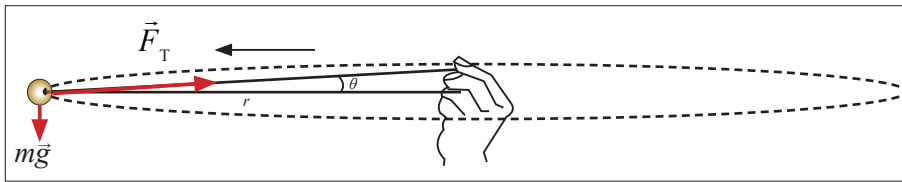

Figure 7.11: An object in a horizontal circular motion

The forces acting on the ball are the force of gravity, downward, and the tension that the string exerts toward the hand at the centre. The free-body diagram for the ball is as shown in the figure 8.11. The ball's weight complicates matter and makes it a little difficult to revolve a ball with the cord perfectly horizontal. We assume the weight is small and put $\theta=0$ in the figure 8.11. Thus the tension will act nearly horizontally and, in any case, provides the force necessary to give the ball its centripetal acceleration.

We apply Newton's second law to the radial direction.

$$\sum F = m\gamma \text{ where } \gamma = \frac{v^2}{r} \Rightarrow F_T = m \frac{v^2}{r}$$

Example

A puck of mass 0.500 kg is attached to the end of a cord 1.50 m long. The puck moves in a horizontal circle as shown in the figure. If the cord can withstand a maximum tension of 50.0 N, what is the maximum speed at which the puck can move before the cord breaks?

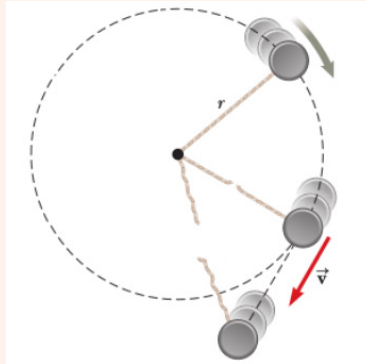

$$T = m \frac{v^2}{r}$$

$$v = \sqrt{\frac{Tr}{m}} \Leftrightarrow v_{\max} = \sqrt{\frac{T_{\max}r}{m}}$$

$$v_{\max} = \sqrt{\frac{T_{\max}r}{m}} = \sqrt{\frac{(50 \text{ N})(1.50 \text{ m})}{0.500 \text{ kg}}} = 12.2 \text{ m/s}$$

Satellite cycling the earth

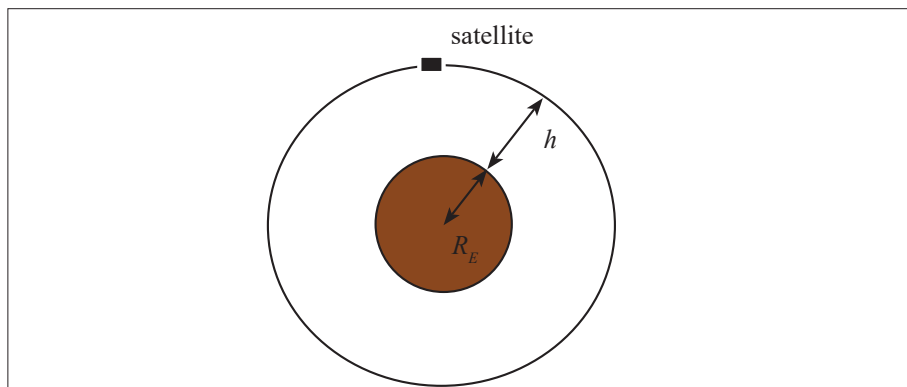

Figure 7.12: A satellite at altitude h from the earth

The centripetal force which keeps an artificial satellite in orbit round the earth is the gravitational attraction of the earth for it. For a satellite of mass m travelling with speed v in circular orbit of radius $(R_E + h)$ measured from the centre of the earth. R_E is the radius of the earth, h is the height where the satellite is.

$$\text{We can write: } F_{cp} = W \Rightarrow \frac{mv^2}{R_E + h} = mg \Rightarrow \frac{v^2}{R_E + h} = g \Rightarrow v^2 = g(R_E + h)$$

$$\text{Then: } v^2 = \sqrt{g(R_E + h)}$$

The time for the satellite to make one complete orbit (the period) is given by:

$$T = \frac{2\pi}{\omega}, \quad v = (R_E + h)\omega \Rightarrow \omega = \frac{v}{R_E + h},$$

$$T = \frac{2\pi(R_E + h)}{v} = \frac{2\pi(R_E + h)}{\sqrt{g(R_E + h)}} = \frac{2\pi(R_E + h)\sqrt{g(R_E + h)}}{g(R_E + h)}$$

$$T = \frac{2\pi\sqrt{g(R_E + h)}}{g}$$

We can use a similar formula to find the velocity (speed) of a satellite cycling the earth.

$$v = \sqrt{G \frac{M_E}{(R_E + h)}}$$

$$\text{In fact: } F_{cp} = \frac{mv^2}{R_E + h} \text{ and } W = G \frac{M_E m}{(R_E + h)^2}$$

$$F_{cp} = W \Rightarrow \frac{mv^2}{R_E + h} = G \frac{M_E m}{(R_E + h)^2} \Rightarrow v^2 = G \frac{M_E}{R_E + h}$$

$$v = \sqrt{G \frac{M_E}{(R_E + h)}}$$

Example

1. A satellite is in a circular orbit around the Earth at an altitude of 1 000 km. The radius of the Earth is equal to $R_E = 6.37 \times 10^6 \text{ m}$, and its mass is $M_E = 5.98 \times 10^{24} \text{ kg}$. Find the speed of the satellite, and then find the period, which is the time it needs to make one complete revolution.

Solution

$$R_E = 6.37 \times 10^6 \text{ m}, \quad M_E = 5.98 \times 10^{24} \text{ kg}, \quad h = 1\,000 \text{ km} = 10^6 \text{ m}$$

$$T = \frac{2\pi\sqrt{g(R_E + h)}}{g} = 6.29 \times 10^3 \text{ s} = 105 \text{ min}$$

$$v = \sqrt{G \frac{M_E}{(R_E + h)}} = 7.36 \times 10^3 \text{ m/s}$$

2. Venus orbits the sun at a radius of $1.08 \times 10^{11} \text{ m}$ with an orbital period of 228 days. Find the mass of the sun in kg.

Solution:

For consistency, let's convert days to seconds:

$$(228 \text{ d}) \left(\frac{24 \text{ h}}{\text{d}} \right) \left(\frac{3600 \text{ s}}{\text{h}} \right) = 1.97 \times 10^7 \text{ s}$$

$$v = \sqrt{\frac{GM}{r}} = \frac{2\pi r}{T}$$

$$M = \frac{4\pi^2 r^3}{GT^2} = \frac{4\pi^2 (1.08 \times 10^{11} \text{ m})^3}{\left(6.67 \times 10^{-11} \frac{\text{N}\cdot\text{m}^2}{\text{kg}^2} \right) (1.97 \times 10^7 \text{ s})^2} = 1.92 \times 10^{30} \text{ kg}$$

The table of

constants in the front of your textbook lists the mass of the sun as $1.99 \times 10^{30} \text{ kg}$

Conical pendulum



Activity 7

DO THIS!

- * Tie a thread of about 50cm on retort stand.
- * On a thread, tie a pendulum bob.
- * Displace the bob through a certain angle.
- * Displace the bob through a certain angle. What do you observe.
- * Release the bob to move through a certain angle so that it moves in a horizontal circle.
- * Try to investigate forces acting in the bob.
- * Relate your findings to fig. 8.13.

A small object of mass m is suspended from a string of length L . The object revolves with constant speed v in a horizontal circle of radius r , as shown in Figure 8.13. Because the string sweeps out the surface of a cone, the system is known as a conical pendulum.

Let us find an expression for v .

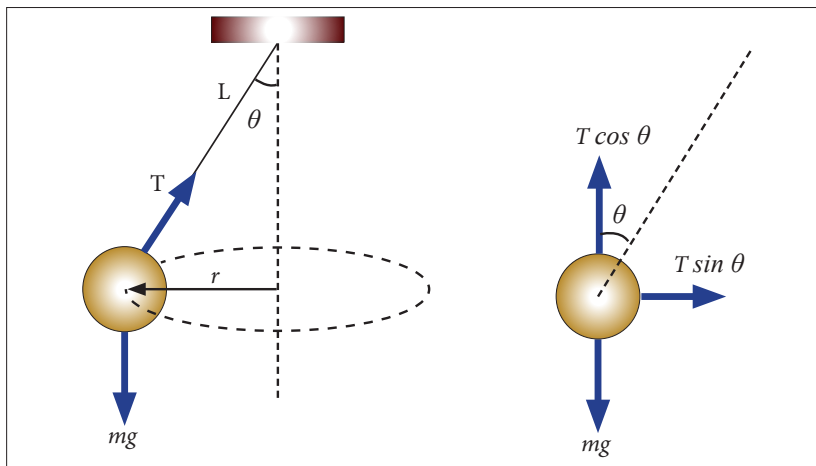

Figure 7.13: The conical pendulum and its free-body diagram

To analyse the problem, begin by letting θ represent the angle between the string and the vertical. In the free-body diagram shown, the force \vec{T} exerted by the string is resolved into a vertical component $T \cos \theta$ and a horizontal component $T \sin \theta$ acting toward the centre of revolution. Because the object does not accelerate in the vertical direction, $\sum F_y = m\gamma_y = 0$ and the upward

vertical component of \vec{T} must balance the downward gravitational force. Therefore, $T \cos\theta = mg$ (1)

Because the force providing the centripetal acceleration in this example is the component $T \sin\theta$, we can use the formula of centripetal acceleration to obtain

$$\sum F = T \sin \theta = m\alpha = \frac{mv^2}{r} \quad (2)$$

Dividing (2) by (1) and using $\frac{\sin\theta}{\cos\theta} = \tan\theta$, we eliminate T and find that

$$\tan \theta = \frac{v^2}{rg} \Rightarrow v = \sqrt{rg \tan \theta}$$

From the geometry in Figure 7.13, we see that $r = L \sin \theta$; therefore, $v = \sqrt{Lg \sin \theta \tan \theta}$

Note that the speed is independent of the mass of the object.

A steel ball of mass 0.5kg is suspended from a light inelastic string of length 1 m. The ball swings in a horizontal circle of radius 0.5 m. Find

- (i) The centripetal force and tension in the string.
- (ii) The angular Speed of the ball.

Example

A cord 5 m long is fixed at one end and to its other end is attached a weight which describes a horizontal circle of radius 1.2 m. compute the speed of the weight in the circular path. Find its time period.

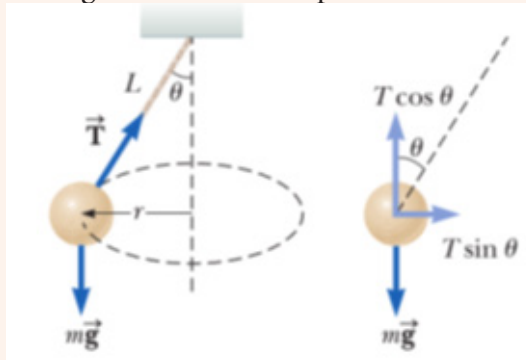

Solution

Given: Length of conical pendulum $L = 5.0 \text{ m}$; radius of circular path of bob $r = 1.20 \text{ m}$ and $g = 9.8 \text{ m/s}^2$

By Pythagoras theorem

$$L^2 = r^2 + h^2$$

$$h = \sqrt{L^2 - r^2} = \sqrt{5^2 - 1.2^2} = 4.85 \text{ m}$$

$$T = 2\pi\sqrt{\frac{h}{g}} = 2\pi\sqrt{\frac{4.85}{9.8}} = 4.41 \text{ s}$$

$$v = \frac{2\pi r}{T} = \frac{2\pi \times 1.2}{4.41} = 1.7 \text{ m/s}$$

Road banking

Circular motion on JOB



Activity 8

A car negotiating a corner

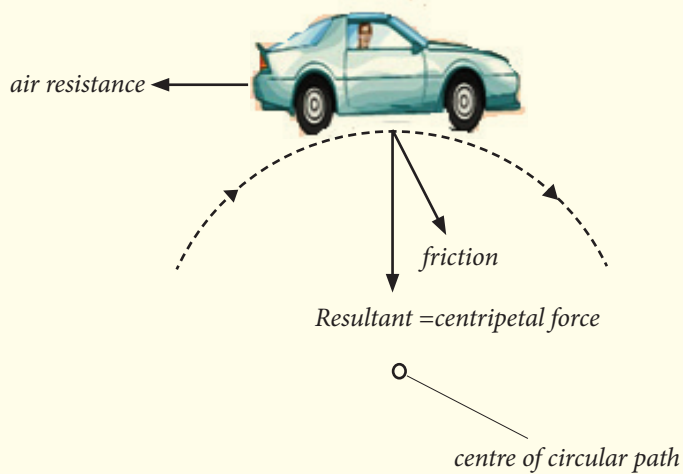

Figure 7.14: Traveling on a circular bend

The successful negotiation of a bend on a flat road therefore depends on the tyres and the road surface being in a condition that enables them to provide a sufficiently high frictional force, otherwise skidding occurs. Safe cornering that does not rely on friction is achieved by “banking” the road.

The problem is to find the angle α at which the bend should be banked so that the centripetal force acting on the car arises entirely from a component of the normal force \vec{N} of the road.

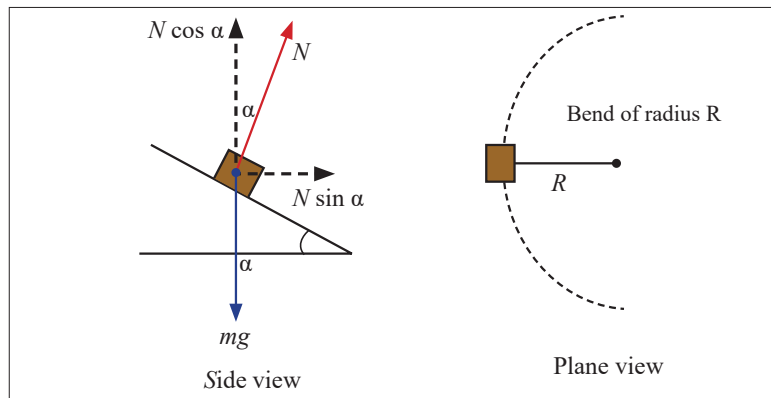

Figure 7.15: Rounding a bend

Treating a car as a particle and resolving \vec{N} vertically and horizontally we have; since $N \sin \alpha$ is the centripetal force $N \sin \alpha = \frac{mv^2}{R}$ where m and v are the mass and the speed respectively of the car and R is the radius of the bend. Also, the car is assumed to remain in the same horizontal plane and so has no vertical acceleration, therefore $N \cos \alpha = mg$.

Hence by division: $\tan \alpha = \frac{v^2}{gR} \Rightarrow v^2 = Rg \tan \alpha$

$$v = \sqrt{Rg \tan \alpha}$$

The equation shows that for a given radius of bend, the angle of banking is only correct for one speed.

Spinning dryer is also known as tumble dryer is a powered household appliance that is used to remove moisture from a load of clothing, bedding another textures, usually shortly after they are washed in a washing machine.

Example

1. The car has a mass m and a speed v as it moves around the track of radius R . Which of the following expressions can be used to find the value of the coefficient of friction between the tires and the road?

(A) $\mu = \frac{gR}{v}$

(B) $\mu = \frac{gv}{R}$

(C) $\mu = vgR$

(D) $\mu = \frac{v^2}{gR}$

(E) $\mu = \frac{mv^2}{R}$

Solution

D

$$f = \mu F_N = \frac{mv^2}{R}, \text{ and } F_N = mg, \text{ so } \mu mg = \frac{mv^2}{R}, \text{ and } \mu = \frac{v^2}{gR}$$

Career centre

Learn more about careers in physics where projectile and circular motion are applied.

END UNIT ASSESSMENT

1. A body is projected upwards from the level ground at an angle of 50° with the horizontal has an initial speed of 40 m/s. how long will it be before it hits the ground?
2. A body is projected downwards at an angle of 30° with the horizontal from the top of a building 170m high. Its initial speed is 40m/s.
 - a) How long will it take before striking the ground?
 - b) Find out how far from the foot of the building the body will strike,
 - c) What the angle with the horizontal?
3. A body is projected from the ground at the angle of 30° with the horizontal at an initial speed of 128m/s, ignoring air friction, determine:
 - a) In how many seconds, it will strike the ground?
 - b) How high it will go?
 - c) What is its range will be?
4. A ball is thrown upwards at an angle of 30° to the horizontal and lands on the top edge of a building that is 20m away, the top edge is 5m above the throwing point. How fast was the ball thrown?
5. A projectile is fired with initial velocity $v_0=95\text{m/s}$ at an angle θ . After five seconds it strikes the top of hill. What is the elevation of the hill above the point of firing? At what horizontal distance from the gun does the projectile lands?
6. A ball is thrown from the top of the one building towards a tall building 50m away. The initial velocity of the ball is 20m/s at 40° above the horizontal. how far above all below its original level, will the ball strikes the opposite wall?
7. A projectile is fired with horizontal velocity of 330m/s from the top of a cliff 80m high.
 - a) How long will it take for the projectile to strike the level ground at the base of the cliff?
 - b) How far from the foot of the cliff will strike?
 - c) With what velocity will it strike?
8. A 0.3kg mass attached to 1.5m long string is whirled around the horizontal circle at a speed of 6m/s.

- a) What is the centripetal acceleration of the mass?
 b) What is the tension of the string?
9. (Moderate), a race car, moving at a constant tangential speed of 60m/s , takes one lap around a circular track in 50 seconds. Determine the magnitude of the acceleration of the car.
10. An object that moves in uniform circular motion has a centripetal acceleration of 13m/s^2 . If the radius of the motion is 0.02m , what is the frequency of the motion?
11. Find the centripetal acceleration for a n object on the surface of a planet with the following characteristics: radius and 1day seconds.
12. An 8.0g cork is swung in a horizontal circle with a radius of 35 cm . it makes 30 revolutions in 12 seconds. What is the tension in the string? (Assume the string in nearly horizontal).
13. A 15g stopper is swung in a horizontal circle with a radius of 0.80meters . The tension in the string is 1.5Newtons . Find the speed of the stopper and determine how long it takes to complete 30 revolutions. (assume the string is very nearly horizontally)
14. A brass ball with a mass of 120 grams is suspended from that is 60.0 cm long. The ball is given a push and it moves in a horizontal circle. The string is not nearly horizontal. It forms an angle of just 22.6 degrees from the vertical. (this is sometimes called a conical pendulum because the string sweeps out the surface of a cone.
- a) Draw free body diagram indicating the forces acting on the ball.
 b) What is the y-component of the tension force equal to? how do you know?
 c) Use trigonometry to find the x-component of the tension force.
 d) What is the radius of the ball's motion?
 e) Use your answer to c and d to find the speed of the ball

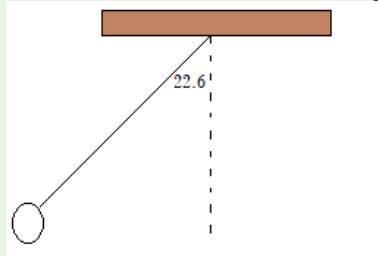

Unit 8

Universal gravitational field and potential

Key Unit Competence

Explain the gravitational field, gravitational potential and their applications in planetary motion.

My goals

By the end of this unit, I will be able to:

- * explain universal gravitation field.
- * describe the factors affecting force of gravity.
- * state and explain Kepler's laws of planetary motion.
- * investigate planetary motion using computer simulation.

Link to other subjects

Geography and Astronomy (Landslides, motion of planets and satellites)

Chemistry (Electrons orbiting the nucleus).

Introductory activity

In observatory, people can see different heavenly bodies such as planets, stars, moons, asteroids, comets and others moving in the universe. The most question that people ask themselves is to know what hold those bodies in their positions in the universe.

Questions

1. Discuss on what you think maintain planets in their position when revolving around the Sun.
2. Discuss the factors that the motion planets depend on.
3. Give other examples of bodies that use same properties in the case study above.

Introduction

The Universe is composed of different planets one of which is the earth.

All objects on the earth remain on it. They cannot move away unless acted on by external forces. This shows that there is a region around it that provides a force that attracts these earthly objects.

Since the earth is part of the universe it follows that a round the universe there is attracting field.

This is called universal gravitational field.

Universal gravitational field potential

To have potential is to have energy, therefore gravitational field potential is the ability of gravity to attract other objects.

Gravitational field

Questions to think about!

1. What force that unites us as Banyarwanda?
2. How do you feel if you come close to a fellow munyarwanda when you find him/her outside our country?
Relate the situation to the force around the earth.
3. What makes you feel attracted to your fellow munyarwanda?

A field is a region of space where forces are exerted on objects with certain properties.

The diagram represents the Earth's gravitational field. The lines show the direction of the force that acts on a mass that is within the field.

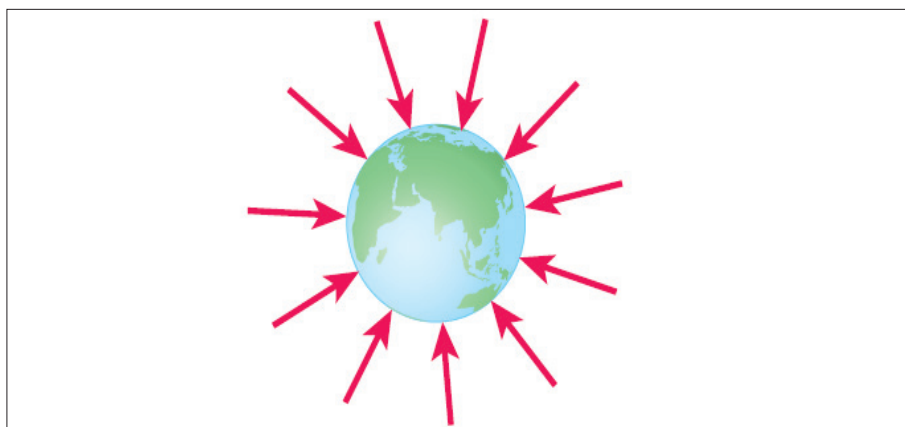

Figure 8.1: Earth's gravitational field

This diagram shows that:

- Gravitational forces are always attractive – the Earth cannot repel any objects.
- The Earth's gravitational pull acts towards the centre of the Earth.
- The Earth's gravitational field is radial; the field lines become less concentrated with increasing distance from the Earth.

The force exerted on an object in a gravitational field depends on its position.

The less concentrated the field lines, the smaller the force. If the *gravitational field strength* at any point is known, then the size of the force can be calculated.

The gravitational field strength g at any point in a gravitational field is the force per unit mass at that point: $g = \frac{F}{m}$

Close to the Earth's surface, g has the value of 9.81Nkg^{-1} , though the value of 10Nkg^{-1} is often used in calculations.

Gravitational field strength is a vector quantity: its direction is towards the object that causes the field.

In studying gravitation, Newton concluded that the gravitational attractive force that exists between any two masses:

- Is proportional to each of the masses.

- Is inversely proportional to the square of their distances apart.

The law states that ‘**The force of attraction between two masses m_1 and m_2 a distance r apart is directly proportional to the product of masses and inversely to the square of distance r of separation.**’

This force acts along the line joining the two particles. In magnitude, the force is given by: $F = G \frac{m_1 m_2}{r^2}$

where m_1 and m_2 are the masses of the two particles, r is the distance between the centres of mass and $G = 6.67 \times 10^{-11} \text{Nm}^2 \text{kg}^{-2}$ is the universal constant of gravitation.

Examples

1. What is the acceleration due to gravity at Moon’s surface? Moon’s mass is $7.35 \times 10^{22} \text{kg}$, the radius of the Moon is $1.7 \times 10^6 \text{m}$, the universal gravitational constant is $6.67 \times 10^{-11} \text{N.m}^2 / \text{kg}^2$.

Solution

Formula:

$$g = \frac{F}{m} = \frac{GMm}{r^2} = \frac{GMm}{r^2 m} = \frac{GM}{r^2}$$

$$g = \frac{6.67 \times 10^{-11} \times 7.3 \times 10^{22}}{(1.7 \times 10^6)^2} = 1.62 \text{m} / \text{s}^2$$

2. The force of gravity that acts on an object on the surface of Mars is 20 N. What is the force of gravity will act on the same object on the surface of the Earth? $g = 9.80 \text{N} / \text{kg}$

Solution

$$w = mg_m = 20 \text{N}$$

$$m = \frac{F}{g_m} = \frac{20 \text{N}}{g_m}$$

$$\text{Or } g_m = \frac{GM_m}{r_m^2}$$

$$F_e = g \times m = 9.80 \times \frac{F}{g_m} = \frac{9.80 \times 20}{\frac{GM_m}{r_m^2}} = \frac{9.80 \times 20 \times r_m^2}{GM_m}$$

$$F_e = \frac{9.80 \times 20 \times (3.39 \times 10^6)^2}{(6.67 \times 10^{-11} \times 6.39 \times 10^{23})} = 53 \text{ N}$$

Dimensions of gravity

$$[G] = \frac{[F][r^2]}{[M_1][M_2]} \quad [G] = \frac{MLT^{-2}L^2}{M.M}$$

$$[G] = M^{-1}L^3T^2$$

The S.I unit of G is $Nm^2 kg^{-2}$

A point mass is one that has a radial field, like that of the Earth.

A graph that shows inverse square law.

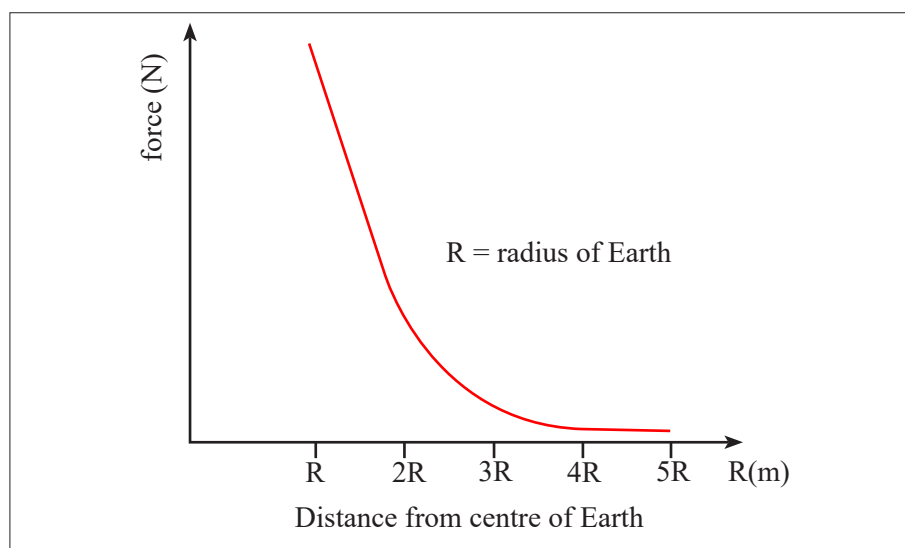

Figure 8.2: Variation of the force of gravity with the distance

Gravitational potential energy

Potential and potential energy



Figure 8.3: The car at the top of the hill has more potential energy than the one at the bottom

Question about fig. 8.3

- The car at the top of the hill has more potential energy than the one at the bottom, but relative to ground level they both have zero. why?
- Note and record in your notebook your analysis.

Using this reference point:

- All objects at infinity have the same amount of potential energy; zero.
- Any object closer than infinity has a negative amount of potential energy, since it would need to acquire energy in order to reach infinity and have zero energy.

The gravitation potential energy is defined as the energy possessed by object because of its position in a gravitational field.

The gravitational potential at a point in a gravitational field is the potential energy per unit mass placed at that point, measured relative to infinity.

Calculating potential and potential energy

When an object is within the gravitational field of a planet, it has a negative amount of potential energy measured relative to infinity. The amount of potential energy depends on:

- The mass of the object.
- The mass of the planet.

- The distance between the centres of mass of the object and the planet.

The Centre of mass of a planet is normally taken to be at its centre.

The gravitational potential energy measured relative to infinity of a mass, m , placed within the gravitational field of a spherical mass M can be calculated using: $p.e = \frac{GMm}{r}$.

Gravitational potential, V , is given by the relationship: $V = -\frac{GM}{r}$.

Gravitational potential is measured in **Jkg⁻¹**.

Examples

1. A satellite of mass 1000 kg moves in a circular orbit of radius 7 000 km round the earth, assumed to be a sphere of radius 6 400 km. calculate the total energy needed to place the satellite in orbit from the earth, assuming $g = 10 \text{ N / kg}$ at the earth's surface.

Solution

Total energy = increase in potential energy and kinetic energy:

$$E = \frac{GMm}{r_e} - \frac{GMm}{r_o} + \frac{1}{2}mv^2$$

$$E = \frac{GMm}{r_e} - \frac{GMm}{2r_o}$$

But $\frac{GM}{r_e^2} = g$, or $\frac{GM}{r_e} = gr_e$

$$E = mgr_e - \frac{mgr_e^2}{2r_o} = mg \left(r_e - \frac{r_e^2}{2r_o} \right)$$

$$E = 1000 \times 10 \left(6.4 \times 10^6 - \frac{6.4^2 \times 10^{12}}{2 \times 7 \times 10^6} \right) = 3.5 \times 10^{10} \text{ J}$$

2. Calculate the gravitational potential on the surface of the earth from the following data. Radius of the earth = $6.37 \times 10^8 \text{ cm}$, the mean density of the earth = 5.5 g / cm^3 and $G = 6.67 \times 10^{-11} \text{ N.m}^2 / \text{kg}^2$.

Solution

We know that $\rho = \frac{m}{v}$, $m = \rho \times v = \rho \times \frac{4}{3}\pi R^3$

$$\text{Formula: } V = -\frac{GM}{R} = -\frac{G}{R} \left(\frac{4}{3}\pi R^3 \rho \right) = \frac{4\pi GR^2 \rho}{3}$$

$$V = -\frac{4 \times 3.14 \times 6.67 \times 10^{-11} \times (6.37 \times 10^6)^2 \times 5.5 \times 10^3}{3} = -6.22 \times 10^7 \text{ J/kg}$$

Relation between the universal gravitational constant and force of gravity (g and G)

A small object of mass m , placed within the gravitational field of the Earth, mass M , experiences a force, F , given by: $F = G \frac{Mm}{r^2}$

Where r is the separation of the centres of mass of the object and the Earth.

It follows from the definition of **gravitational field strength as the force per unit mass that the field strength at that point, g , is related to the mass of**

the Earth by the expression: $g = \frac{F}{m} = \frac{GM}{r^2}$

The same symbol, g , is used to represent:

- Gravitational field strength.
- Free-fall acceleration.

Kepler's Laws



Activity 1: Field work

As a class, let us visit one of the roundabouts (where three roads meet). Try to see/check how cars, motorcycles, bicycles move around it.

Qn i) Does the features on a roundabout move?

Assuming a roundabout to be a sun and vehicles to be planets, what can you say?

1. Discuss your findings in groups of 5 members.
2. Present your findings to the whole class.
3. Note down the observation.
4. Present your work to the teacher for marking.



Activity 2



Check on the watch (that one with a clock hand).

Look at where the second hand is fixed.

While the hand is rotating about a fixed point, describe the shape the second hand describes!

Figure 8.4: Rotation about a fixed point

We can relate the movement of the minute hand as the movement of planets about the sun.

Kepler's first law: The path of each planet about the sun is an ellipse with the sun at one focus (or planets describe ellipse about the sun as one focus).

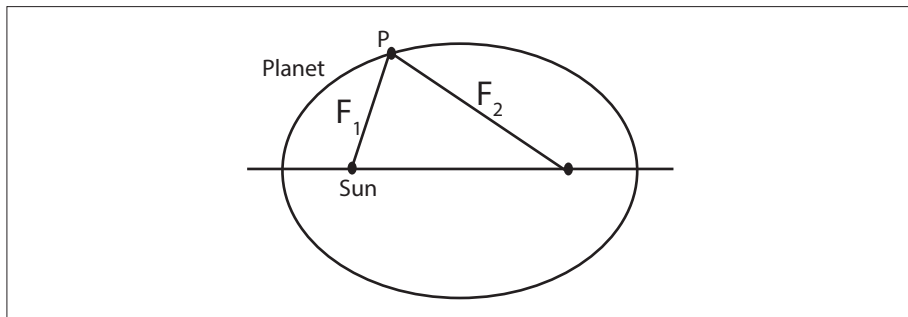

Figure 8.5: The trajectory of P is an ellipse

Kepler's second law: The line joining the sun to the moving planet sweeps out equal areas in equal times.

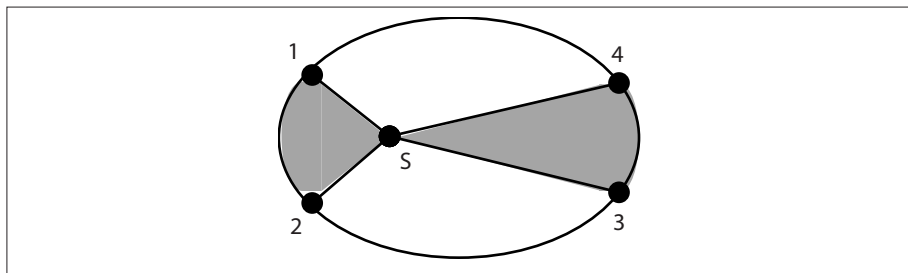

Figure 8.6: The area S12 is equal to the area S34

If planet P takes the same time to travel from 1 to 2 as from 3 to 4 then the shaded areas are equal.

Kepler's third law: The squares of the times of revolution T of the planets about the sun are proportional to the cubes of their mean distances r from it: $\frac{T^2}{r^3} = \text{constant}$

The value of this constant is $\frac{T^2}{r^3} = \frac{4\pi^2}{GM}$, M is the mass of the sun in this case.

Example

If the Earth is rotating around of the sun by using a period $T=356$ days.

The distance between the centers of earth and the sun is $1.5 \times 10^{11} \text{ m}$ (r_{es}) and the mass of the Earth is m , then find out the mass of the sun (M_s).

Solution

By using third law of Kepler: $T^2 = k(r_{es})^3$

$$\frac{GM_s m}{(r_{es})^2} = mr_{es} \omega^2 = \frac{mr_{es} 4\pi^2}{T^2}$$

$$M_s = \frac{4\pi^2 (r_{es})^3}{GT^2} = \frac{4\pi^2 \times (1.5 \times 10^{11})^3}{6.67 \times 10^{-11} \times (365 \times 24 \times 3600)^2} = 2 \times 10^{30} \text{ kg}$$

Proof of Kepler's third law

Activity 3



- Using Newton's law of gravitation (Formula) and the formula that keeps the planet in circular paths (Formula for centripetal force), Derive expression for Kepler's third law of planetary motion
- Put your derivation in your notebook after discussing it with your friends.

Planetary data applied to Kepler's third law

Planet	Mean radius of the planet[m]	Mass[kg]	Period of rotation[s]	Mean radius of orbit r [metres]	Period of revolution T [seconds]	$\frac{r^3}{T^2}$

Sun	6.96×10^8	1.98×10^{30}	2.3×10^6	-	-	-
Mercury	2.34×10^6	3.28×10^{23}	5.03×10^6	5.79×10^{10}	7.60×10^6	3.36×10^{18}
Venus	2.22×10^6	4.83×10^{24}	?	1.08×10^{11}	1.94×10^7	3.35×10^{18}
Earth	6.37×10^6	5.98×10^{24}	8.62×10^4	1.49×10^{11}	3.16×10^7	3.31×10^{18}
Mars	3.32×10^6	6.40×10^{23}	8.86×10^4	2.28×10^{11}	5.94×10^7	3.36×10^{18}
Jupiter	6.98×10^7	1.90×10^{27}	3.54×10^4	7.78×10^{11}	3.74×10^8	3.36×10^{18}
Saturn	5.82×10^7	5.6×10^{26}	3.61×10^4	1.43×10^{12}	9.30×10^8	3.37×10^{18}
Uranus	2.37×10^7	8.67×10^{25}	3.85×10^4	2.87×10^{12}	2.66×10^9	3.34×10^{18}
Neptune	2.24×10^7	1.05×10^{26}	5.69×10^4	4.50×10^{12}	5.20×10^9	3.37×10^{18}
Pluto	3.00×10^6	5.37×10^{24}	?	5.90×10^{12}	7.82×10^9	3.36×10^{18}
Moon	1.74×10^6	7.34×10^{22}	2.36×10^8	3.84×10^8	2.36×10^6	To find

Examples

- Calculate the force of gravity between two bowling balls each having a mass of 8.0kg, when they are 0.50m apart.

Solution

$$\text{Force} = \frac{Gm^1m^2}{r^2}$$

Where m is mass

G gravitational constant = $6.67 \times 10^{-11} \text{ Nm}^{-2}$

R is distance between masses

$$F = \frac{6.67 \times 10^{-11} \times 8 \times 8}{0.5^2} \text{ N}$$

$$F = 1.70752 \times 10^{-8} \text{ N}$$

$$F = 1.7 \times 10^{-8} \text{ N}$$

- At the surface of a certain planet, the gravitational acceleration g has a magnitude of 2.0 m/s^2 . A 4.0kg brass ball is transported to this planet. Give:
 - The mass of the brass ball on the earth and on the planet; and
 - The weight of the brass ball on the earth and on the planet.

Solution

- a) The mass of an object cannot change
Therefore mass remains as 4.0kg
- b) Weight = mg (on the earth)
 $m = 4.0\text{kg}$
 $g = 10.0\text{ms}^{-2}$
 Then weight = 4.0×10.0
 Weight = 40.0N
 On the planet
 Weight = mg where $m = 4.0\text{kg}$, and $g = 2.0\text{ms}^{-2}$
 Weight = $4.0 \times 2.0 = 8\text{N}$

END UNIT ASSESSMENT

- Calculate the effective value of g , the acceleration of gravity, (a) 3200m, (b) 3200km, above the earth's surface.
- Determine the net force on the moon ($m_m = 7.36 \times 10^{22}\text{ kg}$) due to the gravitational attraction and both the earth ($m_e = 5.98 \times 10^{24}\text{ kg}$) and the sun ($m_s = 1.99 \times 10^{30}\text{ kg}$) assuming they are at right angles to each other.

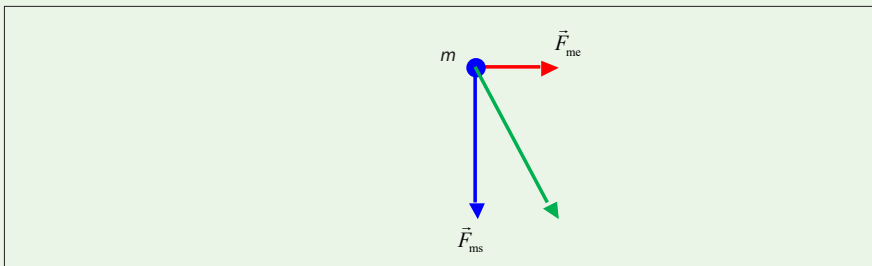

Figure 8.7: Relation to question 2

- It takes Mars 1.9 years to complete an orbit around the sun. use Kepler's third law to determine the average distance between Mars and the Sun. (Give your answer in AU)
- Mars has two moons Phobos, and Deimos. Use the data given to test if these moons obey Kepler's third law of planetary motion.

Phobos: $r = 9400\text{km}$; $T = 7.66\text{ hours}$

Deimos: $r = 23,500\text{km}$; $T = 30.4\text{ hours}$

5. Use the data for Deimos in the previous question (2) to determine the mass of Mars if it is $6.4 \times 10^{23} \text{ kg}$
6. The free fall on the surface of Mars is 3.7 m/s^2 . Determine the radius and average density of the red planet.
7. An exoplanet is discovered orbiting a star with a mass of $1.6 \times 10^{30} \text{ kg}$. The orbital period is 12 days ($1.04 \times 10^6 \text{ seconds}$). What is the orbital radius of the star?
8. Calculate the force of attraction between two 90kg spheres of metal space so that their centers are 40 cm apart.
9. The average density of solids near the surface of the earth is $\rho = 4 \times 10^3 \text{ kg / m}^3$. On the assumption of a spherical planet of the uniform density, calculate the universal gravitational constant G.
10. A mass m_1 is equal to 1kg weighs one sixth as much on the surface of the moon as on the earth. Calculate the mass m_2 of the moon.
The radius of the moon is $1.738 \times 10^6 \text{ m}$.

Unit 9

Electric field and electric potential

Key Unit Competence

Analyze the electric field and electric potential.

My goals

By the end of this unit, I will be able to:

- * define electric field and electric potential.
- * explain the relationship between electric potential and electric field intensity.
- * describe functioning of lightening arrestors.
- * identify the dangers of lightening and how to avoid them.

Introductory activity

When you pass nearby an electric power station, you may notice some sign post as shown in figure below.



This is to show that, the high voltage on the grid may affect people who dares to approach it.

Questions

1. Discuss about the reasons behind the information given by the sign post.
2. Is it possible that electricity can affect someone without touching the wires (cables)?
3. Discuss other areas where you can get such sign post and explain the reason behind.

Introduction

Have you ever heard sound due to lightening? If yes, what do you think was the cause?

If not, ask your friend in your class, at home, or neighbour about lightening.

Scientifically, lightening and thunder are effects of electric charges created in space (will be discussed later).

Attraction and repulsion of charges



Activity 1

In this section, you will observe the characteristics of the two types of charges, and verify experimentally that opposite charges attract and like charges repel.

Equipment

- * Two lucite rods
- * One rough plastic rod
- * Stand with stirrup holder
- * Silk cloth
- * Cat's fur



Figure 9.1: Attraction and repulsion

Procedure

1. Charge one lucite rod by rubbing it vigorously with silk. Place the rod into the stirrup holder as shown in Figure.
2. Rub the second lucite rod with silk, and bring it close to the first rod

3. What happens? Record the observations in your notes.
4. Rub the rough plastic rod with cat's fur, and bring this rod near the lucite rod in the stirrup. Record your observations.
5. What do you conclude?
6. Note down observation in your notebook.

For reference purposes, according to the convention originally chosen by Benjamin Franklin, the lucite rods rubbed with silk become positively charged, and the rough plastic rods rubbed with cat's fur become negatively charged. Hard rubber rods, which are also commonly used, become negatively charged.

Coulomb's law

Activity 2



Materials

- * Coulomb's Law apparatus
- * Electrophorus (The electrophorus is a simple electrostatic induction device. It's an inexhaustible source of charge”).
- * Silk cloth.
- * A computer for the graph and quick calculation.

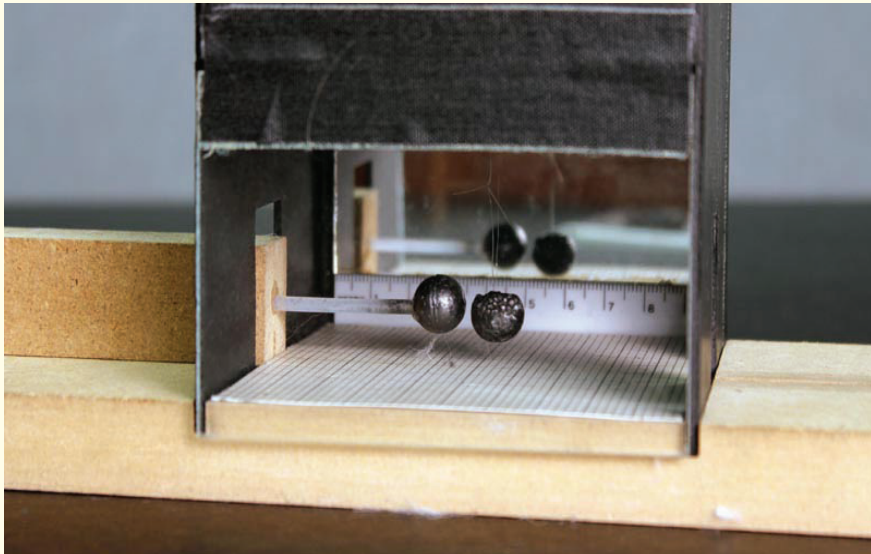

Figure 9.2: Coulomb's apparatus

Procedure

1. Take a moment to check to position of the hanging ball in your Coulomb apparatus. Look in through the side plastic window. The hanging ball should be at the same height as the sliding ball (i.e. the top of the mirrored scale should pass behind the centre of the hanging pith ball, as in Figure 10.3 below). Lift off the top cover and look down on the ball. The hanging ball should be centred on a line with the sliding balls. If necessary, adjust carefully the fine threads that hold the hanging ball to position it properly.
2. Charge the metal plate of the electrophorus in the usual way by rubbing the plastic base with silk, placing the metal plate on the base, and touching it with your finger.
3. Lift off the metal plate by its insulating handle, and touch it carefully to the ball on the left sliding block.
4. Slide the block into the Coulomb apparatus without touching the sides of the box with the ball. Slide the block in until it is close to the hanging ball. The hanging ball will be attracted by polarization, as in Section III of this lab. After it touches the sliding ball, the hanging ball will pick up half the charge and be repelled away. Repeat the procedure if necessary, pushing the sliding ball up until it touches the hanging ball.
5. Recharge the sliding ball so it produces the maximum force, and experiment with pushing it towards the hanging ball. The hanging ball should be repelled strongly.
6. You are going to measure the displacement of the hanging ball. You do not need to measure the position of its centre, but will record the position of its inside edge. Remove the sliding ball and record the equilibrium position of its inside edge that faces the sliding ball, which you will subtract from all the other measurements to determine the displacement d .
7. Put the sliding ball in, and make trial measurements of the inside edge of the sliding ball and the inside edge of the hanging ball. The difference between these two measurements, plus the diameter of one of the balls, is the distance r between their centres. Practice taking measurements and compare your readings with those of your lab partner until you are sure you can do them accurately. Try to estimate measurements to 0.2 mm.

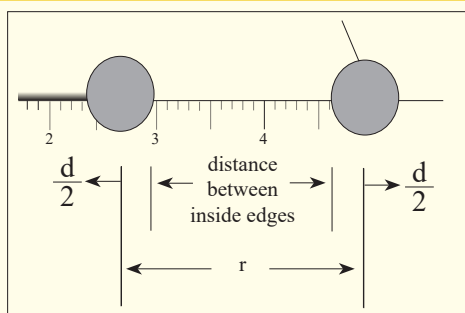

Figure 9.3: The positions of the inside edges are marked. The difference between these positions plus the diameter of one ball is the distance between the centres of the balls

8. Take measurements, and record the diameter of the balls (by sighting on the scale).
9. Remove the sliding ball, and recheck the equilibrium position of the inside edge of the hanging ball.
10. You can record and graph data in Excel or by hand (although if you work by hand, you will lose the opportunity for 2 mills of additional credit below). Recharge the balls as in steps 1 – 4, and record a series of measurements of the inside edges of the balls. Move the sliding ball in steps of 0.5 cm for each new measurement.
11. Compute columns of displacements d (position of the hanging ball minus the equilibrium position) and the separations r (difference between the two recorded measurements plus the diameter of one ball).
12. Plot (by hand or with Excel) d versus $\frac{1}{r^2}$. Is Coulomb's Law verified?
13. For an additional credit of 2 mills, use Excel to fit a power-law curve to the data. What is the exponent of the r -dependence of the force? (Theoretically, it should be -2.000 , but what does your curve fit produce?)
14. For your records, you may print out your Excel file with a table and graph of your numerical observations and any other electronic files you have generated.

Interpretation

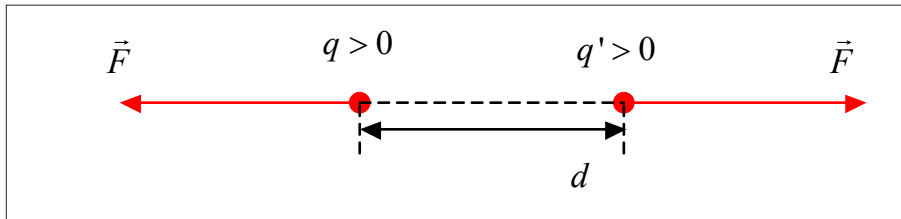

Figure 9.4: Coulomb's law, the diagram shows the force between two forces

Knowledge of the forces that exist between charged particles is necessary for an understanding of the structure of the atom and of matter. The magnitude of the forces between point charges was first investigated quantitatively in 1785 by Coulomb, a French scientist. The law he discovered is stated as follows:

“The force between two point charges is directly proportional to the product of charges divided by the square of their distance apart”.

Mathematically we have: $F = k \frac{qq'}{d^2}$ Where, k is a positive constant.

Note that a positive F tends to increase d .

In the S.I, the unit of charge is the **coulombs** [C].

In S.I units, the coulomb constant k has the following value for charges in vacuum: $k \approx 9 \times 10^9 \text{N} \cdot \text{m}^2 / \text{C}^2$

Often k is replaced by $\frac{1}{4\pi\epsilon_0}$, where $\epsilon_0 = 8.85 \times 10^{-12} \text{C}^2 / \text{N} \cdot \text{m}^2$ is called the **permittivity of a vacuum**.

In term of it, Coulomb's law becomes, for vacuum: $F = \frac{1}{4\pi\epsilon_0} \frac{qq'}{d^2}$

When the surrounding medium is not a vacuum, forces caused by induced charges in material reduce the force between point charges. If the material has a dielectric constant K , then ϵ_0 in Coulomb's law must be replaced by $K\epsilon_0 = \epsilon$, where ϵ is called the permittivity of the material. Then: $F = \frac{1}{4\pi\epsilon} \frac{qq'}{d^2}$ with $K\epsilon_0 = \epsilon$

For vacuum, $K = 1$; for air $K = 1.0006$, and is thus often taken to be 1.

Sometimes it's better to write: $F = k \frac{qq'}{d^2}$ where $k = \frac{1}{4\pi\epsilon}$ and $\epsilon = \epsilon_r \epsilon_0$

ϵ_0 : Permittivity of free space = 8.85×10^{-12} USI

ϵ_r : Relative permittivity of a given medium

The relative permittivity, ϵ_r , of a medium is the ratio of its permittivity ϵ to that of a vacuum ϵ_0 . So: $\epsilon_r = \frac{\epsilon}{\epsilon_0}$

Although ϵ and ϵ_0 have dimensions, ϵ_r is a number and has no dimensions.

$$\text{We can write: } F = \frac{1}{4\pi\epsilon} \frac{qq'}{d^2} = \frac{1}{4\pi\epsilon_0\epsilon_r} \frac{qq'}{d^2}$$

$$\text{In the vacuum: } \epsilon_r = 1, \text{ then } F = \frac{1}{4\pi\epsilon_0} \frac{qq'}{d^2}$$

$$F = \frac{1}{4\pi\epsilon_0} = 9.10^9 \Rightarrow F = 9.10^9 \frac{qq'}{d^2}$$

$$\text{In a medium of relative permittivity } \epsilon_r, \text{ this formula is written: } F = \frac{9.10^9}{\epsilon_r} \frac{qq'}{d^2}$$

Some values of ϵ_r

- Air: $\epsilon_r = 1.0006$
- Vacuum: $\epsilon_r = 1.00$
- Water (pure): $\epsilon_r = 80$
- Alcohol: $\epsilon_r = 26$
- Glass: $\epsilon_r =$ from 3 to 9
- Polythene: $\epsilon_r = 2.3$
- Perspex: $\epsilon_r = 2.6$
- Paper (waxed): $\epsilon_r = 2.7$
- Mica: $\epsilon_r = 7$
- Barium titanate: $\epsilon_r = 1200$

Examples

1. If two equal charges, each of 1C, are separated in air by a distance of 1 km, what would be the force between them?

Solution

$$q_1 = q_2 = 1\text{c}$$

Distance between charges is 1km=1000m

$$k = 9 \times 10^9$$

Formula:

$$F = \frac{k \times q_1 \times q_2}{r^2} = \frac{9 \times 10^9 \times 1c \times 1c}{(1000m)^2} = 9000N$$

2. Determine the force between two free electrons spaced $1A^0$ apart.

Solution

$$q_1 = q_2 = |-1.6 \times 10^{-19} C|$$

$$k = 9 \times 10^9$$

Formula:

$$F = \frac{k \times q_1 \times q_2}{r^2} = \frac{9 \times 10^9 \times (1.6 \times 10^{-19})^2}{(10^{-10})^2} = \frac{2.304 \times 10^{-28}}{10^{-20}} = 2.304 \times 10^{-48} N$$

3. Two equally charged pith balls are 3cm apart in air and repel each other with a force of $4 \times 10^{-5} N$. Find the charge of each ball.

Solution

Distance between charges = 3cm = 0.03m

$$F = 4 \times 10^{-5} N$$

Formula:

$$4 \times 10^{-5} = \frac{k \times q^2}{r^2} = \frac{9 \times 10^9 \times q^2}{(0.03)^2}$$

$$\frac{3.6 \times 10^{-8}}{9 \times 10^9} = q^2$$

$$\sqrt{4 \times 10^{-18}} = q$$

$$q_1 = q_2 = 2 \times 10^{-9} C$$

4. How many electrons are contained in $-1C$ of charge? What is the total mass of these electrons?

Solution

$$q = -1c$$

$$q = ne$$

$$-1c = n \times (-1.6 \times 10^{-19})$$

$$\frac{-1c}{(-1.6 \times 10^{-19})} = n$$

$$n = 6.25 \times 10^{18} \text{ electrons}$$

Quick check

1. If two equal charges, each of 1C, are separated in air by a distance of 1 km, what would be the force between them?
2. Determine the force between two free electrons spaced 1AO apart.
3. Two equally charged pith balls are 3cm apart in air and repel each other with a force of 4×10^{-5} N. Find the charge of each ball.
4. How many electrons are contained in -1 C of charge? What is the total mass of these electrons?

Application activity 9.2

1. Two points charges q_1 and q_2 are 3m apart, and their combined charge is $20\mu\text{C}$.
 - a) If one repels the other with a force of 0.075N, what are the two charges?
 - b) If the one attracts the other with a force of 0.525N, what are the magnitudes of charges?
2. Two point charges of q and q^1 coulombs separated by a distant of 5m repel with a force of 0.072N. After having been put in contact, one replaces them at the same distance. Then they repel with a force of 0.081N. Calculate the charges before contact.
3. Two balls have identical masses of 0.1g each. When suspended to 10cm - long strings, they make an angle of 15° with the vertical. If the charges on each are the same, how large is each charge?

4. A test charge $q = +2\mu\text{C}$ is placed halfway between a charge $q = +6\mu\text{C}$ and a charge $q = +4\mu\text{C}$ which are 10cm apart. Find the force on the charge test and its direction.
5. Three point charges are placed at the following points on the x axis: $+2\mu\text{C}$ at $x = 0$, $-3\mu\text{C}$ at $x = 40\text{cm}$, $-5\mu\text{C}$ at $x = 120\text{cm}$. Find the force on the $-3\mu\text{C}$ charge.
6. Charges $+2$, $+3$ and $-8\mu\text{C}$ are placed at the vertices of an equilateral triangle of side 10cm. Calculate the magnitude of the force acting on the $-8\mu\text{C}$ charge due to the other charges.

Electric field

Notions and definitions

Questions to think about

- a) You have learned about Coulomb's law and you have seen that when an electric charge is brought near to another, there is an attractive or a repulsive force. Does that force acts when charges are in contact or it acts even at a certain distance?
- b) If so, what can be the reason?
- c) Does that force increase or decrease when the distance between charges increases?

After responding to those questions, you'll see that around an electric charge is a region so that when another charge is placed in it, it undergoes an electric force. That region is called electric field created by the first charge.

An electric field can be defined as a region where an electric force is obtained. It's a region where an electric charge experiences a force.

If a very small charge, positive point charge q is placed at any point in an electric field and it experiences a force F , then the field strength E (also called the E -field) at that point is defined by the equation: $E = \frac{F}{q}$.

In words, the magnitude of E is the force per unit charge and its direction is that of \vec{F} (that is to say of the force which acts on a positive charge). Electric field is therefore a vector and we can write: $\vec{E} = \frac{\vec{F}}{q}$

If F is in newtons [N] and q is in coulombs [C], then the unit of E is [NC⁻¹]. We shall see later that a more practical unit of E is volt-meter⁻¹ [Vm⁻¹].

***E* due to a point charge**

The magnitude of \vec{E} due to an isolated positive point charge $+q$ at the point P distance d away, in a medium of permittivity, ϵ , can be calculated by imagining a very small charge $+q'$ to be placed at P.

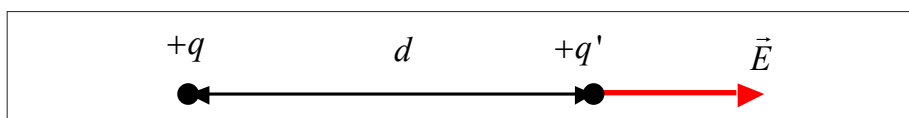

Figure 9.5: The direction of the electric force is the same as the one of the electric field

By the Coulomb's law, the force F on q' is:

$$F = \frac{1}{4\pi\epsilon} \frac{qq'}{d^2}$$

But E is the force per unit charge, that is; $E = \frac{F}{q'}$. So, $E = \frac{1}{4\pi\epsilon} \frac{q}{d^2}$

\vec{E} is directed away from $+q$, as shown. If a point charge $-q$ replaced $+q$, \vec{E} would be directed toward $-q$ since unlike charges attract.

The following diagrams show it:

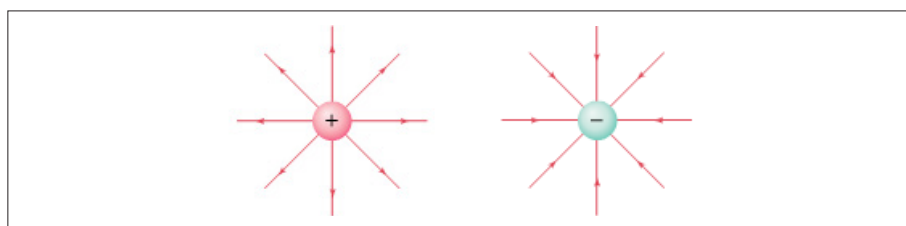

Figure 9.6: Directions of electric field of positive and negative point charge

The above expression shows that E decreases with distance from the point charge according to an inverse square law. The field due to an isolated point charge is therefore non – uniform but it has same value at equal distances from the charge and so has spherical symmetry.

Examples

Compute:

- The electric field E in air at a distance of 30cm from a point charge $q_1 = 5.0 \times 10^{-9} \text{ C}$
- The force on a charge $q_2 = 4.0 \times 10^{-10} \text{ C}$ placed 30cm from q_1 , and
- The force on charge $q_3 = -4.0 \times 10^{-10} \text{ C}$ placed 30cm from q_1 (in the absence of q_2)

Solution

$$\text{a) } E = \frac{k \times q_1}{r^2} = 9 \times 10^9 \text{ N.m}^2 / \text{C}^2 \times \frac{5.0 \times 10^{-9} \text{ C}}{(0.30\text{m})^2} = 0.50 \text{ kN / C}$$

directed away from q_1 .

$$\text{b) } F_E = Eq_2 = (500 \text{ N / C})(4.0 \times 10^{-10} \text{ C}) = 2.0 \times 10^{-7} \text{ N} = 0.2 \times 10^{-6} \text{ N}$$

Directed away from q_1 .

$$\text{c) } F_E = Eq_3 = (500 \text{ N / C})(-4.0 \times 10^{-10} \text{ C}) = -0.20 \times 10^{-6} \text{ N}$$

This force is directed toward q_1

Field lines (lines of force)



Activity 4: Lab zone

Existence of field lines

This shows the shape of electric fields, in much the same way that magnetic fields are demonstrated with iron filings.

Materials

- * Power supply, EHT, 0-5kV.
- * Semolina.
- * Electric fields apparatus.
- * Castor oil.

Procedure

- a) Fill the electrode unit with a layer of castor oil to a depth of about 0.5cm. Sprinkle a thin layer of semolina over the surface. (A thin piece of glass tubing drawn out to give a fine pointed stirrer is helpful so that the semolina is evenly distributed.) It is better to start with too little semolina than to start with too much. You can always increase the quantity later.
- b) Place the electrodes in the castor oil. Connect the positive and negative terminals of the EHT power supply to the electrodes. Adjust the supply to give 3,000 to 4,000 volts. When the voltage is switched on, the field lines will be clearly visible.
- c) Try electrodes of different shapes. For example, one can be a 'point' electrode whilst the other is a plate, or two point electrodes can be used. A wire circular electrode with a point electrode at the centre will show a radial field. The field with two plates quite close together should also be shown.

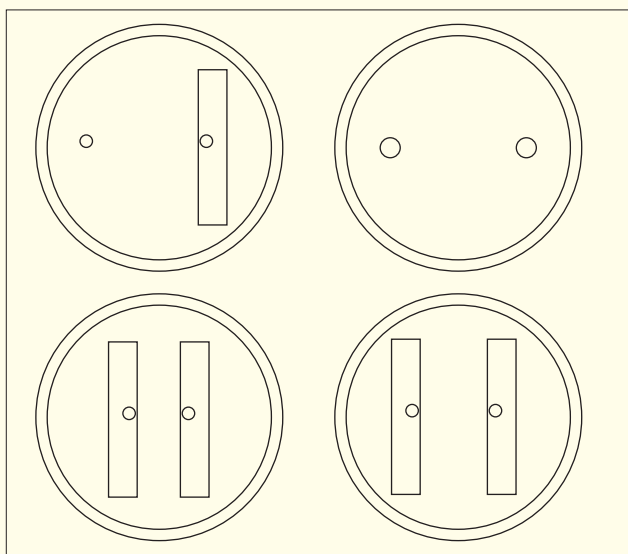

Figure 9.7: Electrodes of different shapes

A *line of force* or *field lines* is defined as a line such that the tangent to it at a point is in the direction of force on a small positive charge placed the point.

Arrows on the lines of force show the direction of the force on a positive charge; the force on a negative charge.

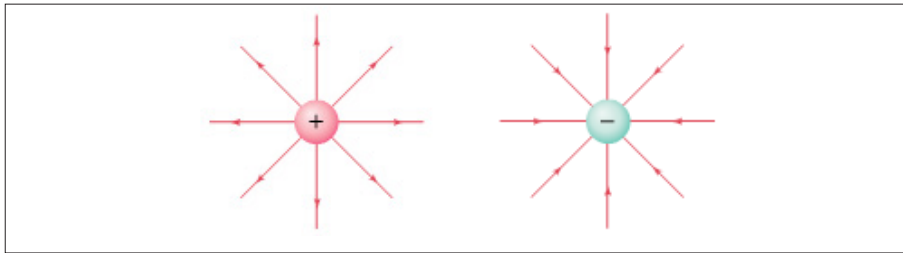

Figure 9.8: Field lines of isolated charges

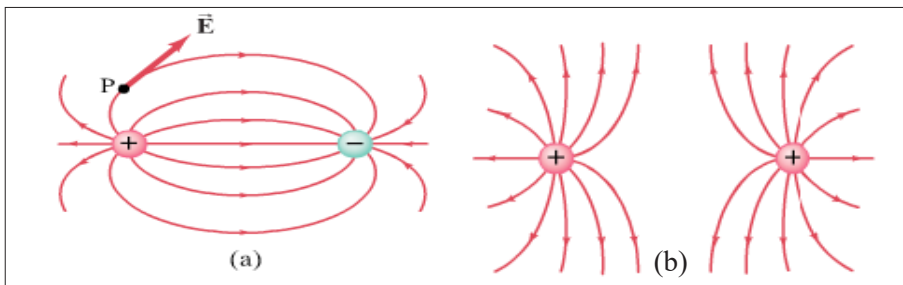

Figure 9.9: Field lines of unlike charges and like charges

Uniform electric field

A uniform electric field is one in which \vec{E} has the same magnitude and direction at all points, there is a plane symmetry and the field lines are parallel and evenly spaced.

This is the case for example of electric field between two parallel – plate carrying charges which have opposite signs.

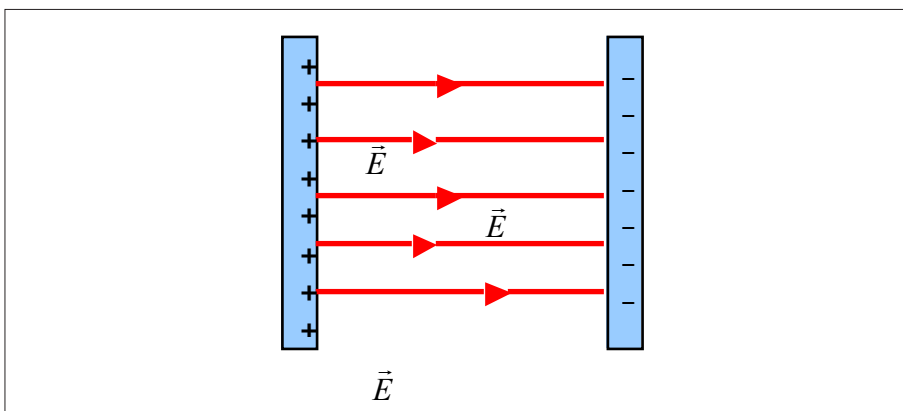

Figure 9.10: Field lines in a uniform field

Electric field due to a distribution of electric charges

Activity 5



Electric field due to a distribution of charges

Materials

- * A sheet of paper
- * A pen
- * A ruler

Procedure

1. Represent a distribution of charges where you have charges of different signs.
2. Represent a point A where you want to find the total electric field.
3. At the point, A represents directions of electric fields vectors produced by each charge.
4. Do the sum of electric fields. Remember that an electric field is a vector. When they make a certain angle between them, use the method of parallelogram. When they have the same direction or opposite directions, use the appropriate method.
5. Establish a mathematical relation of the total electric field due to the distribution of charges.

Field strength and charge density

So far as external effects are concerned, an isolated spherical conductor having a charge q uniformly distributed over its surface behaves like a point charge q at its centre. If r is the radius of the sphere, the field strength E at its surface is therefore given by:

$$E = \frac{1}{4\pi\epsilon} \frac{q}{r^2}$$

The charge per unit area of the surface of the conductor is called the charge density σ (sigma) and since a sphere has the surface area $4\pi r^2$, we have;

$$\sigma = \frac{q}{4\pi r^2}.$$

Therefore, $q = 4\pi r^2\sigma$ and so $E = \frac{\sigma}{\epsilon}$.

This expression has been derived by considering a sphere but it gives E at surface of any charges conductor. It's called *Gauss' theorem*.

Quick check

1. Two point charges of $1\mu\text{C}$ and $9\mu\text{C}$ respectively are situated at two points A and B 8cm apart. Find the point of the straight line AB where the electrostatic field is zero.
2. Two charges of $+1\mu\text{C}$ and $-1\mu\text{C}$ are placed at the corners of the base of an equilateral triangle. The length of a side of a triangle is 0.7m. Find the electric field intensity at the apex of the triangle.

Application activity 9.2

1. A uniform electrostatic field exists between two parallel plates having equal charges of opposite signs. An electron initially at the rest escapes from the surface negatively charged and strikes the surface of the other plate, situated at 2cm in $1.5 \times 10^{-8}\text{s}$.
 - a) Calculate the electric field,
 - b) Calculate the speed of the electron at the time of the impact with the second plate.
2. An electron is situated in a uniform electric field of intensity or field-strength $1,200,000\text{Vm}^{-1}$. Find the force on it, its acceleration, and the time it takes to travel 20mm from rest (electron mass, $m = 9.1 \times 10^{-31}\text{kg}$).
3. A point charge $-30\mu\text{C}$ is placed at the origin of coordinates. Find the electric field at the point $x = 5\text{m}$.
4. A $5.0\mu\text{C}$ point charge is placed at the point $x = 20\text{cm}$, $y = 30\text{cm}$, Find the magnitude of E due to it
 - a) At the origin.
 - b) At $x = 1.0\text{m}$, $y = 1.0\text{m}$.
5. The ball of an electrostatic pendulum of mass 2.5g has a charge of $0.5\mu\text{C}$.
 - a) What must be the intensity of a horizontal electrostatic field so that the wire makes an angle of 30° with the vertical?
 - b) What angle makes the wire with the vertical if the electrostatic field has an intensity of 10^4NC^{-1} ?

Potential difference

Work of electric force

Activity 6



Find the expression of the work done by an electric force

- When can we say that we have a uniform electric field?
- Draw a diagram showing two plates of opposite signs (the left plate is positive and the right one is negative) between which the electric field is uniform.
- Show the direction of field lines in the electric field.
- Between the two plates, put a positive charge at a point A which has to travel toward a point B in the field.
- Represent the direction of the vector force on the line joining A and B.
- Write down the expression of the force undergone by the charge.
- What is the expression of the work done if the charge has to move from A to B (in the final formula)?

Particles that are free to move, if positively charged, normally tend towards regions of lower voltage (net negative charge), while if negatively charged they tend to shift towards regions of higher voltage (net positive charge).

However, any movement of a positive charge into a region of higher voltage requires external work to be done against the field of the electric force, work equal to that electric field would do in moving that positive charge the same distance in the opposite direction. Similarly, it requires positive external work to transfer a negatively charged particle from a region of higher voltage to a region of lower voltage.

The electric force is a conservative force: work done by a static electric field is independent of the path taken by the charge. There is no change in the voltage (electric potential) around any closed path; when returning to the starting point in a closed path, the net of the external work done is zero.

Potential in a field

Activity 7



Understanding the potential in a field

- What kind of energy has a body when it's held above the earth? If the body has to move under the force of gravity, does it move from a point of great height to one of less or it's the inverse?

2. Do you agree or not that points in the earth's gravitational field have potential values depending on their heights?
3. According to you, can this theory be similar to the one established for electric field? Explain.
4. For charges, instead of saying gravitational potential for gravitational field, can we say electric potential for the case of electric field? Explain.
5. Can points around the charge be said to have electric potential?
6. How can we define the electric potential at a point?

Potential generally refers to a currently unrealized ability. The term is used in a wide variety of fields, from physics to the social sciences to indicate things that are in a state where they are able to change in ways ranging from the simple release of energy by objects to the realization of abilities in people.

Although the concept of electric potential is useful in understanding electrical phenomena, only differences in potential energy are measurable. If an electric field is defined as the force per unit charge, then by analogy an electric potential can be thought of as the potential energy per unit charge. Therefore, the work done in moving a unit charge from one point to another (e.g., within an electric circuit) is equal to the difference in potential energies at each point.

Potential difference, work, energy of charges



Activity 8

Potential energy, work, energy of charges

- a) Consider two points A and B in an electrostatic field of strength E , and suppose that the force on a positive charge q has a component \vec{F} in the direction AB. Then if we move a positively charged body from B to A, we do work against this component of the field \vec{E} . The potential at A and at B are not equal. How can we define the potential difference between A and B?
- b) From the definition in (a), if V_A is the electric potential at the point A and V_B the electric potential at the point B. Knowing that if move a positive charge from A to B, the force \vec{F} produces a work W_{AB} . With which formula can we calculate the potential difference between A and B?

- c) The unit of the potential difference has a special name called volt [V]. Can you find its unit in S.I units knowing that that 1V is equal to 1 unit of what you have to find?
- d) Considering potential difference theory, the energy is expressed in another unit called electron-volt [eV]. How can you define an electron-volt? What is the relation between an [eV] and a joule [J]?
- e) From your knowledge, what is the instrument used to measure the potential difference in the circuit and how is it connected?

Electric potential is a location-dependent quantity that expresses the amount of potential energy per unit of charge at a specified location. When a Coulomb of charge (or any given amount of charge) possesses a relatively large quantity of potential energy at a given location, then that location is said to be a location of high electric potential. And similarly, if a Coulomb of charge (or any given amount of charge) possesses a relatively small quantity of potential energy at a given location, then that location is said to be a location of low electric potential. As we begin to apply our concepts of potential energy and electric potential to circuits, we will begin to refer to the difference in electric potential between two points.

Relation between E and V

Activity 9



Relation between E and V

1. What is the relation to find the work done by an electric force to move a charge from A to B, knowing that the distance between A and B is d ?
2. What is the relation of the work using the potential difference?
3. Equalize the two relations and deduce the value of E . The relation found is the one between E and V .
4. From the expression found, deduce the new unit of the electric field E .
5. Write down the relation between E and V found, express in equation of V , write the electric field produced by a charge at a point deduce the electric potential created by a charge at a point situated at a distance d from it.

The effect of any charge distribution can be described either in terms of electric field or in terms of electric potential. Electric potential is often easier to use since it is a scalar whereas electric field is a vector. There is an intimate connection between the potential and the electric field. Let us consider the case of a uniform electric field, such as that between the parallel plates (fig.) whose difference of potential is V_{ba} .

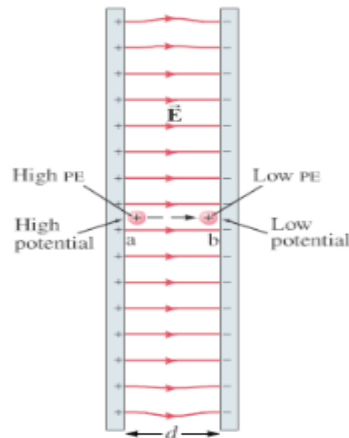

The work done by the electric field to move a positive charge q from a to b is equal to the negative of the change in potential energy, so

$$W = -q(V_b - V_a) = -qV_{ba}$$

We can also write the work done as the force times distance, where the force on q is $F = qE$, so

$$W = Fd = qEd$$

Where d is the distance (parallel to the field lines) between points a and b . we now set these two expressions for W equal and find

$$qV_{ba} = -qEd, \text{ or}$$

$$V_{ba} = -Ed$$

If we solve for E , we find

$$E = -\frac{V_{ba}}{d}$$

The units for electric field can be written as volts per meter (V/m) as well as newton per coulomb (N/C).

The minus sign tells us that \vec{E} points in the direction of decreasing potential V .

Examples

In figure below, the potential difference between the metal plates is 40v.

- Which plate is at the higher potential?
- How much work must be done to carry a +3.0C charge from B to A? from A to B?
- How do we know that the electric the electric field is in the direction indicated?
- If the plate separation is 5.0mm. what is the magnitude of **E**?

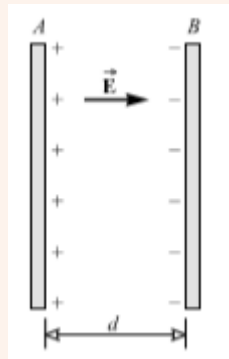

Solution

- Plate A is at the higher potential.
- Work to be done from B to A is $w = qv = 3.0C \times 40v = 120J$
- As the charge is moving from A to B, negative work (-120J) is done.
- A positive test charge between the plates experiences a force directed from A to B and this is, by definition, direction of the field.

$$E = \frac{V}{d} = \frac{40v}{(0.0050m)} = 8000v / m$$

Motion of electric charges in an electric field

Activity 10



Figure 9.11: The inside of a TV set

- Observe the picture and say it represents the inside of which apparatus.
- You see a tube called cathode ray tube (CRT) Search on internet and give its main parts.
- Doing the research, give a small idea about its principle of functioning.

In the process of functioning you'll find that charges (electrons) are produced, are sent in motion in an electric field and reach a fluorescent screen. Here we are interested in the motion of the electric field.

On the figure below, charges, here we consider electrons, with a horizontal vector velocity of magnitude v_0 entering between two horizontal plates P_1 and P_2 separated by a distance d . A p.d $V = V_{P_1} - V_{P_2}$ is applied between the plates.

We assume the electric field between the plates is uniform and acts on electrons on a horizontal distance l measured from 0. The point A is the point I where electrons get out the electric field; l is the distance through which the uniform field acts and x the horizontal trajectory travelled by electrons. In the electric field, an electric force acts vertically on the charges. So there is deflection of electrons in the electric field.

- Why the upper plate must be charged positively and the lower plate charged negatively for this case?

- e) If $l = x$, the motion being in the plane, find the equation of the horizontal motion.
- f) Find the equation of the vertical motion.
- g) Write down the second Newton's law of the motion of those electrons, write the electric force from which electrons are subjected and deduce the acceleration of the motion.
- h) Show that the trajectory of the motion between plates is a parabola and give its equation.
- i) Calculate the velocity of electrons at the point A where they leave the electric field.

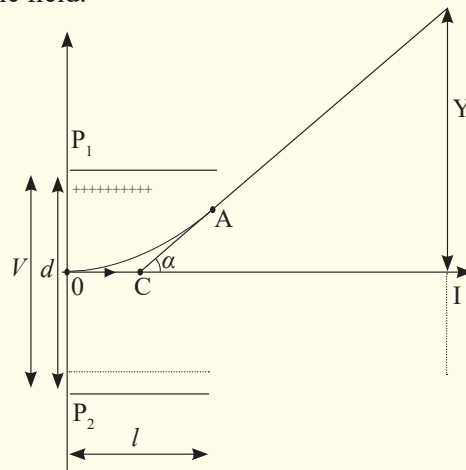

Figure 9.12: Motion of a charge in an electric field

There are so many applications of cathode ray tube which is a practical example of the motion of electrons in an electric field in daily life. For example TV sets, oscilloscope, etc. use cathode ray tubes.



Figure 9.13: The image shows a signal received by a fluorescent screen of a CRT

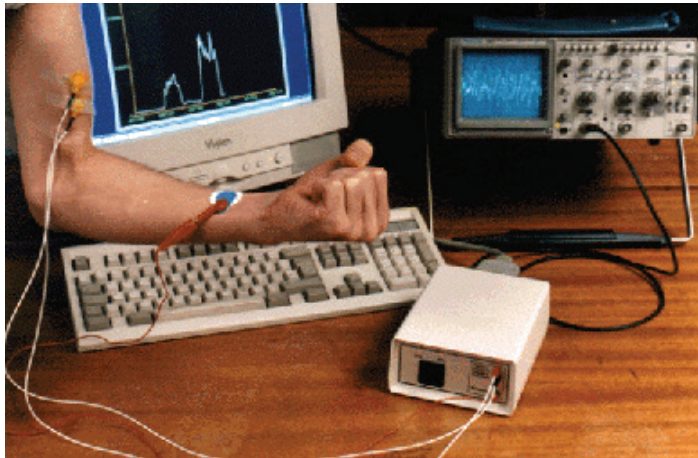

Figure 9.14: Oscilloscopes are used in hospitals for different purposes. Here it's measuring the pressure of people

Lightening and lightening arrestor



Activity 11

Lightening and lightening arrestor

- Surely, you have heard a thunder before the rainfall. What do you observe in the sky during it?
- According to you, this is due to what?
- Is the fact observed dangerous?
- If yes, do you know some consequences which you have observed or heard?
- If yes, is there a way to be protected from it?
- Do some research on internet to know more about it and submit the result of your research to the teacher.

Some explanation

What you observe is called *Lightening* which is a sudden electrostatic discharge (the sudden flow of **electricity** between two electrically charged objects caused by contact, an electrical short, or dielectric breakdown) during an electrical storm between electrically charged regions of a cloud (called intra-cloud lightening or IC), between that cloud and another cloud (CC lightening), or between a cloud and the ground (CG lightening). The charged regions in the atmosphere temporarily equalise themselves through this discharge referred

to as a *strike* if it hits an object on the ground. Although lightening is always accompanied by the sound of thunder, distant lightening may be seen but be too far away for the thunder to be heard. Lightening strikes can be damaging to buildings and equipment, as well as dangerous to people.



Figure 9.15: A lightening flash during a thunderstorm



Figure 9.16: A thunder struck tree

Buildings often use a *lightening protection* or *lightening rod* system consisting of a lightening rod (also called a lightening conductor) and metal cables to divert and conduct the electrical charges safely into the ground. Another form of lightening protection system creates a short circuit to prevent damage to equipment. The electrically conducting metal skin of commercial aircraft is isolated from the interior of to protect passengers and equipment.

Often, the lightening protection is mounted on top of an elevated structure, such as a building, a ship, or even a tree, electrically bonded using a wire or electrical conductor to interface with ground or “earth” through an electrode, engineered to protect the structure in the event of lightening strike. If lightening hits the structure, it will preferentially strike the rod and be conducted to the ground through the wire, instead of passing through the structure, where it could start a fire or cause electrocution. Lightening rods are also called *fnials*, air terminals or strike termination devices.

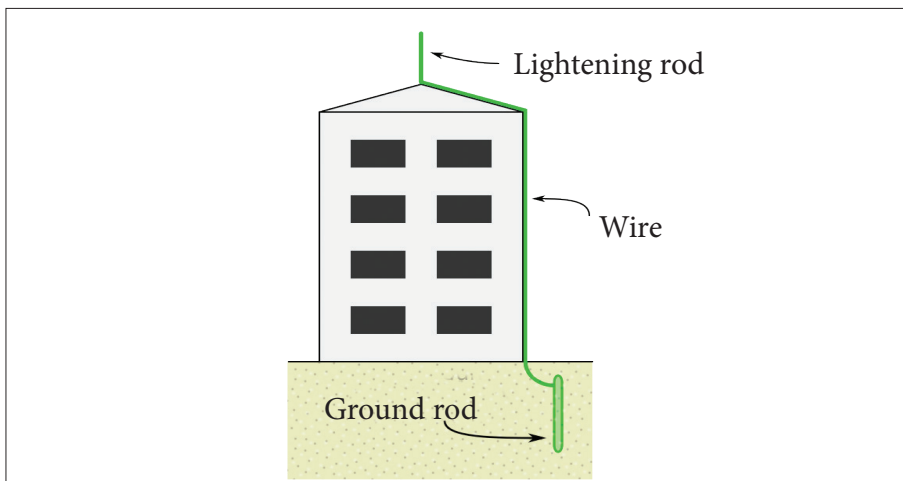

Figure 9.17: Diagram of a simple lightning protection system

In a lightning protection system, a lightning rod is a single component of the system. The lightning rod requires a connection to earth to perform its protective function. Lightning rods come in many different forms, including hollow, solid, pointed, rounded, flat strips or even bristle brush-like. The main attribute common to all lightning rods is that they are all made of conductive materials, such as copper and aluminum. Copper and its alloys are the most common materials used in lightning protection.

END UNIT ASSESSMENT

- Two point charges Q_1 and Q_2 are 3m apart, and their combined charges is $20 \mu C$.
 - If one repels the other with a force of 0.075N. What are the two charges?
 - If one attracts the other with a force 0.525 N, what are the magnitudes of charges?
- A test charge $Q = +2 \mu C$ is placed a half way between a charge $Q_1 = +6 \mu C$ and a charge $Q_2 = +4 \mu C$ which are 10 cm apart. Find the force on the test charge and its direction.
- A point charge, $-30 \mu C$ is placed at the origin of the coordinates. Find the electric field at the point $x=5$ m on the x-axis.
- Four equal magnitude $4 \mu C$ charges are placed at the corners of a square that is 20 cm on each side. Find the electric field intensity at the center of the square, if the charges are all positive.
- What is the absolute potential of 20 cm radius metal sphere that carries a charge of $65 nC$?
- A point charge $Q_1 = 2 \mu C$ is placed at the origin of coordinates. A second $Q_2 = -3 \mu C$, is placed on x-axis at $x=100$ cm. at what point (or points) on the x-axis will absolute potential be zero?
- The electron in hydrogen atom is most probably at distance $r = 5.29 \times 10^{-11} m$ from the proton which is the nucleus of the atom. Evaluate the electric potential energy U of the atom.
- Briefly describe how a lightning conductor can safeguard a tall building from being struck by lightning. (in essay form).

Unit 10

Applications of thermodynamics laws

Key unit Competence

Evaluate the applications of first and second laws of thermodynamics in real life.

Unit goals

By the end of this unit, I will be able to:

- * differentiate between Internal energy and total energy of a system.
- * explain the work done by the expanding gas.
- * state the first law of thermodynamics.
- * state the second law of thermodynamics.
- * explain thermodynamic processes in heat engines.

Introductory activity



Mutesi is a parent of two children at a certain school. Before she takes them to school, she first makes sure that she prepares food and drinks for them and packs some in flasks so that her children can eat and drink during lunch time.

She then drives them to school before she reports to her working place and then from the school she then diverts to her working place which is about 5 km away from the school.

The parking yard at her work place is a plain place without any shade but she makes sure that her car is parked near a tree that is near the parking yard to prevent it from different damages among which is destruction of tyres of the car.

- Explain why Mutesi makes use of flasks not normal utensils like metallic bowls while packing foods and drinks for her children.
- Is there heat exchange inside the flasks? Explain your reasoning.
- Imagine on a certain day these two children only eat food and leaves, the drink in the flask and by mistake they forget flask in the store and the mother come to pick it the next day. Do you think the contents in the flask will be at the same temperatures? Explain all scientific phenomena that may lead to either loss or gain in energy of the contents in the flask.
- Explain why in most cases the outer covering of a flask is always made of a poor conductor? Explain how quality and efficiency of these flasks can be improved by manufactures.

- e) Based on statements above, Mutesi normally parks her car under a shade to prevent her car from being exposed to sunshine. Explain how during hot days the tyres of a car may burst.
- f) Her Car uses petrol in operation. During operation of her car, the engine draws fuel (Petrol) air mixture from the tank into the engine, explain all the processes that take place in the engine.

Introduction

Before, you learnt that:

- Heat is a form of energy.
- Heat can be changed / transformed from one form to another.

So, if in a system heat changes from one form to another, its called thermal dynamic system.

The systems to discuss in this unit include refrigerators, heat pumps, car engines. Remember that heat is the measure of total internal energy of a body. This means that particles of a body vibrate because of energy they have.

Thermal energy and internal energy



Activity 1

Have you ever boiled water on a sauce pan with a cover?
Describe what happens to the cover when water boils?

When water boils, the vapour pushes the cover off the sauce pan. You have already seen in your early secondary that heat is a form of energy. Therefore, when this saucepan is heated, the heat gained is used to boil off the water and extra work is done to push the sauce pan cover. This total heat energy supplied is called thermal energy.

Science in action! Discover

- Explain why an inflated bicycle tube bursts when it is left on sunshine for a very long time.
- Similarly explain why a balloon full of air bursts as it rises in the atmosphere.
- Note down your observation in your exercise books.

You already know the characteristics of the three states of matter that is; solids, liquids and gases. In this unit, we shall be interested in studying the behaviour of molecules in matter.

When the bicycle tube is left exposed to sunshine, it gets heated and the molecules in the gas gain energy and hence its kinetic energy increases. As a result, they collide frequently with the walls of the tube and therefore exert high pressure on the walls and the tube bursts.

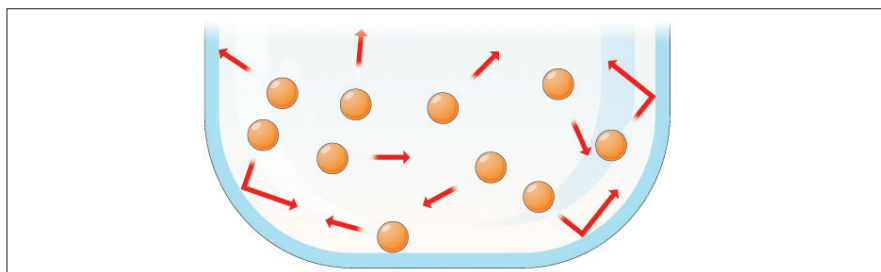

Fig 10.1: Pressure of the gas

The same thing happens with the balloon in air.

The energy possessed by the molecules of the gas is called internal energy of the gas. This energy depends on the temperature of the gas. When a gas is heated its temperature increases and hence the average speed of molecules also increases increasing the internal energy of the gas. Further increase of heat supplied means that extra energy is absorbed by the molecules of the gas, hence expanding and pushing the tyre. As a result the tyre bursts.

The internal energy is defined as energy associated with random disordered motion of particles.

Activity 2



List down three utensils used for cooking food in your homes.
Describe how these utensils are used to cook the food. Are they always left open while cooking?



Fig 10.2: Preparing food at home

In all the above, there exists energy exchanges and such things are called systems. Systems can either be closed or open. When water is being boiled in an open sauce pan, vapour is allowed to escape. It is an example of an open system. When someone cooks meat using a closed container, no gas is allowed to escape. Its an example of a closed system.

Whenever heat flows to or from a system, or work is done on or by a system, there is a change in the energy of this system. The study of the processes that cause these energy changes is termed **thermodynamics**.

Thermodynamic systems

Heat is the energy that flows by conduction, convection or radiation from one body to another because of a temperature difference between them. These

bodies where exchange of heat to other forms of energy occurs are called thermodynamic systems.

A thermodynamic system consists of a fixed mass of matter, often a gas, separated from its surroundings, perhaps by a cylinder and a piston. For example heat engines such as a petrol engine, a steam turbine and jet engine all contain thermodynamic systems designed to convert heat into mechanical work. Head pumps and refrigerators are thermodynamic devices for transferring heat from a cold body to a hotter one.

A thermodynamic system is any object or set of objects that we wish to consider. Everything else in the universe we will refer to as its environment or the surroundings. A system is separated from the remainder of the universe by a boundary. The boundary may be at rest or in motion.

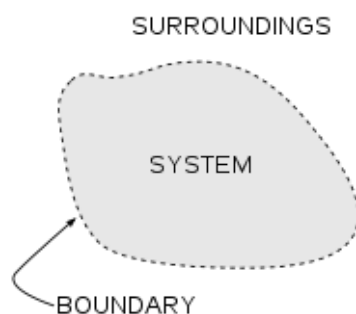

A system can be homogeneous or heterogeneous. It can be gaseous, liquid or solid state. A system is in **equilibrium** when its properties do not change with time.

A **closed system** is one for which no mass enters or leaves but may enter heat exchanged with the environment. A closed system is sometimes referred to as a **control mass** because the matter composing the system is assumed known for all time. A closed system is said to be **isolated** if no energy in any form passes across its boundaries, otherwise it is not isolated.

In an **open** system, mass may enter or leave as well as energy. An open system is sometimes referred to as a control volume because the location composing the system is assumed known for all time. The surface surrounding the **control volume** is sometimes known as a **control surface**. The control surface can be along a real surface of the system or it can be an imaginary surface chosen for

convenience. In general, a control mass can change shape and volume, but a control volume cannot.

In such devices, energy is transferred from one system to another by a force moving its point of application in its own direction.

The energy of a system, whether transferred to it as heat or work is termed as the internal energy of the system.

When there is no heat transfer between two systems, that is, the two are at the same temperature, they are said to be in thermal equilibrium.

Activity 3



Have you ever observed smoke moving in the atmosphere. Move outside class and go towards the kitchen and observe how smoke is moving. Describe briefly how it moves. Why does it move like that?

You have already seen in your early secondary that molecules in a gas are more further apart and are always in constant random motion while moving at high speed colliding with one another and the walls of the container, and when the gas is heated their speed increases.

Smoke particles are always in random motion and when they are moving in air, they collide with air molecules and a zigzag pattern is seen.

Similarly, when smoke is put in a container and then closed, the particles are seen to be in a random motion. Smoke is an example of a real gas.

In thermodynamics, we are mainly interested in ideal gas. At higher temperatures, a real gas behaves like an ideal gas.

Activity 4



Have you ever heard of an ideal gas? What are the differences between a real gas and an ideal gas?

When a gas is heated, molecules move further apart and the forces of attractions between them become negligible and the gas becomes ideal.

When the molecules become further apart, the gas expands and the volume of the individual molecule becomes so small compared to the entire volume of

the gas. It therefore becomes negligible compared to the volume of the gas and the gas becomes ideal.

When the molecules are colliding with one another, collisions are assumed to be perfectly elastic. In this case, the gas becomes ideal because for a real gas we expect to have time between approach and separation during collision.

Work done by an expanding gas



Activity 5: Discover

Explain why a pump gets hot when one pumps air into a tyre.

When you compress air in a bicycle pump, your muscles transfer energy to the handle, which in turn transfers energy to the molecules of air in the pump. This additional energy makes the molecules move faster. As they are compressed into a smaller space, they also collide more often with the wall of the pump, so they transfer more energy to the metal wall and it becomes hot.

We have already seen how heat can be transferred, so you probably have a good idea what Q means. Work is simply a force Multiplied by distance in the direction of force.

A gas can be heated by compressing it, for example with a bicycle pump. Hence the temperature of the gas can be raised either by doing work in compressing it or by heating it. Likewise the temperature can be lowered by either making the gas do work in expanding or by extracting heat from it.

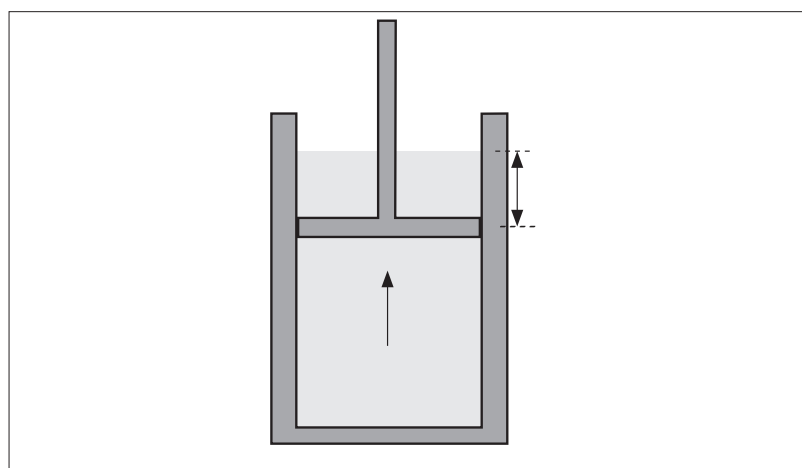

Fig 10.3: When you compress air

Consider a mass of gas enclosed in a cylinder by a frictionless piston of cross-section area A which is in equilibrium under the action of an external force, F , acting downwards (i.e. pressing the gas). Let this force be infinitely reduced so that the piston is pushed up by the gas a distance Δx , which is so small that the pressure of the gas is virtually unchanged by the expansion.

If the gas is heated, it will expand and push the piston thereby doing work on the piston. If the piston is pushed down, on the other hand, it does work on the gas. This is an example on how work is done by a thermodynamic system.

The piston must be held in position by force PA (by definition of pressure).

The external work done by the gas, ΔW against F will be;

$$\Delta W = F\Delta x = PA\Delta x = P\Delta V,$$

$\Delta V = A\Delta x$ is the increase in volume of the gas.

Suppose that the pressure is kept constant during the expansion, and the gas expands from V_1 to V_2 , then the total work done by the gas is given by calculus as; $W = \int dW = \int PdV$

It follows that; $W = P(V_2 - V_1)$

Example

Steam to drive an old-fashioned steam locomotive is supplied at a constant gauge pressure of $1.75 \times 10^6 \text{ N/m}^2$ (about 250 psi) to a piston with a 0.200-m radius.

Find the work done by the steam when the piston moves 0.800 m.

Solution

$$W = P\Delta V = 1.75 \times 10^6 \times (0.2)^2 \times 3.14 \times 0.8$$

$$W = 1.76 \times 10^5 \text{ J}$$

Specific heat capacities of gases

Gases are considered to have a number of specific heat capacities. A change in temperature of a gas is likely to cause large changes in pressure and volume of the gas but for solids or liquids, the change in pressure is neglected.

In your early secondary, you have already seen that heat energy is calculated by measuring the mass of liquids and solids. However, in gases, we replace the mass with the number of moles of a gas.

When the specific heat capacity of a gas is measured in terms of its moles, it is known as principal specific heat capacity. There are two important heat capacities: the molar heat capacity and constant volume (C_v) and molar heat capacity at constant pressure (C_p).

The principal molar heat capacity at constant volume (C_v) is defined as the heat required to increase the temperature of one mole of a gas at constant volume by one Kelvin.

The principal molar heat capacity at constant pressure (C_p) is the amount of heat required to increase the temperature of one mole of a gas at constant pressure by one Kelvin.

The molar heat capacities have units $\text{Jmol}^{-1}\text{K}^{-1}$.

Since at constant volume, the work done by a gas is zero from ($W=P\Delta V$, $\Delta V=0$), then it is evident that the principal K molar heat capacity at constant pressure, C_p is greater than that at constant volume, C_v . Why?

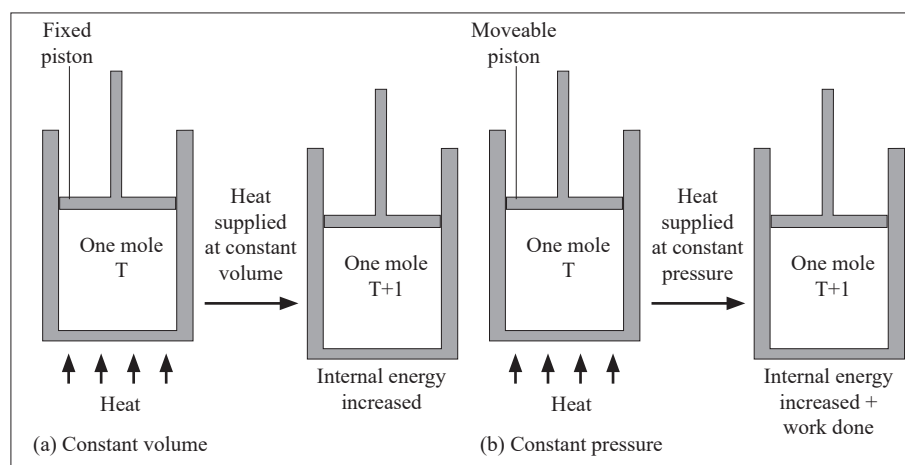

Fig 10.4: Piston in a cylinder

The reason as to why this is so can be done by considering cylinders in (a) and (b) each initially containing one mole of gas at temperature T and pressure, P . The piston in (a) is fixed and that in (b) is frictionless and can move freely but has a constant force applied to it. If heat is supplied to each until the

temperature has risen by one Kelvin, the increase of internal energy must be the same in each case (Since the temperature rise is the same).

All the heat supplied in case (a) is used to increase the internal energy of the gas. In (b), however, the gas expands and work is done by it on the piston; the heat supplied in this case equals the increase of internal energy plus the work done in the expansion of the gas.

Application activity 10.1

1. Which statement best describes the concept of a system?

- A. the subject of the analysis
- B. an object with fixed set of molecules
- C. a fluid-solid mixture
- D. an object that radiates heat into its environment

2. Consider a refrigerator in a kitchen. Take the refrigerator and everything in it to be our system. Which best describes the system's surroundings?

- A. All of the air in the kitchen.
- B. Any one standing in the kitchen.
- C. The air inside the refrigerator
- D. Everything in the universe external to the system.

3. Consider a refrigerator in a kitchen. Take the refrigerator and everything in it to be our system. Which best describes the system's boundary?

- A. All of the air in the kitchen.
- B. The thin region separating the system from everything else.
- C. The air inside the refrigerator.
- D. The outer walls of the refrigerator.

4. Which of the following statements are true?

- A. A closed system is necessarily an isolated system
- B. An isolated system is necessarily a closed system
- C. A system cannot be both closed and isolated.
- D. The concepts of closed and isolated in regards to a system are independent concepts.

5. True or False: A system is in steady state if its properties are independent of time.

The first law of the thermodynamics

The first law of thermodynamics states that "in a closed system the energy is conserved in any transfer of energy from one form to another. **Means that the change in internal energy of a system is equal to the heat added to the system minus the work done by the system**" this law is known as the law of energy conservation.

$$\Rightarrow \Delta U = Q - W$$

Where ΔU is the change in internal energy.

Q is heat added to a system

W is the work done by the system

When we warm a gas so that it expands, the heat ΔQ we give to it appears partly as an increase ΔU to its *internal energy* and hence its temperature and partly as the energy needed for the external work done ΔW . Thus from the first law of thermodynamics, we may write:

$$\Delta Q = \Delta U + \Delta W \quad (1)$$

If the expression of the gas occurs and no friction forces are present

$$\Delta W = P.\Delta V \quad (\text{Because } \Delta W = F\Delta l = P.A\Delta l)$$

So, from (1) :

$$\Delta Q = \Delta U + P.\Delta V \quad (2)$$

Equation (2) then is a mathematical statement of the first law of thermodynamics applied to the case of energy changes with a gas.

In the relation $\Delta Q = \Delta U + \Delta W$ is the external work done by the gas. We can express the relation in different way if heat ΔQ is given to the gas and ΔW is the external work done on the gas when it is compressed, for example, in this case, the increase in the internal energy of the gas ΔU is given by:

$$\Delta U = \Delta Q + \Delta W \quad (3)$$

The work done on the gas is $P\Delta V$ and so

$$\Delta U = \Delta Q + P\Delta V$$

Example

Compute the internal energy change and temperature change for the two processes involving 1 mole of an ideal monatomic gas.

- 1500 J of heat are added to the gas and the gas does no work and no work is done on the gas
- 1500 J of work are done on the gas and the gas does no work and no heat is added or taken away from the gas

Solution

$$\text{a) } \Delta U = Q - W = 1500\text{J} - 0 = 1500\text{J}$$

$$\Delta U = \frac{3}{2}nR\Delta T; \Delta T = \frac{2\Delta U}{3nR} = \frac{2 \times 1500}{3 \times 1 \times 8.3145} = 12.0\text{ K}$$

$$\text{b) } \Delta U = Q - W = 0 - (-1500\text{J}) = 1500\text{J}$$

$$\Delta U = \frac{3}{2}nR\Delta T; \Delta T = \frac{2\Delta U}{3nR} = \frac{2 \times 1500}{3 \times 1 \times 8.3145} = 12.0\text{ K}$$

Relationship between C_p and C_v .

Consider one mole of a gas at a pressure P , temperature T and volume V , heated to cause the same temperature change, ΔT first at constant volume and secondly, at constant pressure.

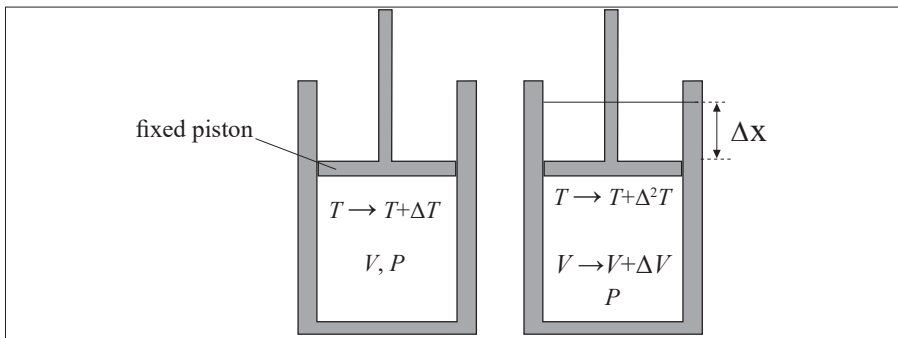

Fig 10.5: At constant volume

From the first law of thermodynamic, At constant volume,

$$\Delta Q = \Delta U + \Delta W$$

$$\Delta Q = 1 \times C_v \Delta T + \Delta W$$

It therefore follows that $\Delta Q = C_v \Delta T + \Delta W$(i)

At constant pressure, $\Delta Q = \Delta U + \Delta W$

In this case, $\Delta U = C_v \Delta T$, $\Delta W = P \Delta V$ and $\Delta Q = C_p \Delta T$

From equation (i)

$$\Delta Q = \Delta U + \Delta W, \dots\dots\dots(ii)$$

It follows that $C_p \Delta T = C_v \Delta T + P \Delta V$(iii)

From the ideal gas equation, $PV = RT$.

If the volume of the gas changes by ΔV and the temperature by ΔT ;

$$P(V + \Delta V) = R(T + \Delta T) \Rightarrow PV + P \Delta V = RT + R \Delta T \Rightarrow P \Delta V + R \Delta T \dots\dots (iv)$$

Substituting (iv) in (iii)

$$C_p \Delta T = C_v \Delta T + R \Delta T$$

$$C_p = C_v + R$$

Therefore, $(C_p - C_v) = R$

where R is the universal molar gas constant whose value is $8.31 \text{ Jmol}^{-1}\text{K}^{-1}$

Applications of first law of thermodynamics in particular gas changes

The first law of thermodynamics that we discussed relates the changes in internal energy of a system to transfers of energy by work or heat. In this case, we consider applications of the first law in processes through which a gas is taken as a model.

Isovolumetric process (Isochoric process)

Activity 6



- (i) Have you ever heard of an isovolumetric or isochoric process? Study the Figure and answer questions that follow;

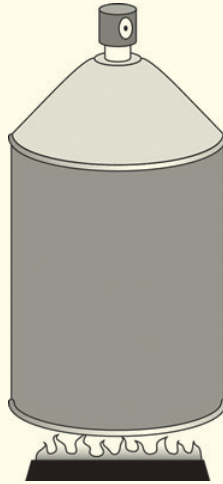

Fig 10.6: Heating a can

- (ii) What substance is likely to be getting cooked using the can on the left? Give a reason for your answer.
- (iii) Why is the can covered and not open?
- (iv) If one tried to open it while its on fire, what do you think would happen?

A process that takes place at constant volume is called an **isovolumetric** process.

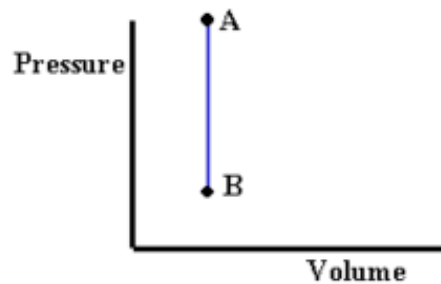

Fig 10.7: P-V graph showing isovolumetric process

From the figure 10.7, process AB takes place at a constant volume (volume doesn't change).

In such a process, the value of the work done is zero because the volume does not change. Hence, from the first law we see that in an isovolumetric process,

$$W = 0 \text{ and } \Delta U = Q \quad (\text{isovolumetric process})$$

Note:

- This expression specifies that if energy is added by heat to a system at constant volume, then all of the transferred energy remains in the system as an increase in its internal energy.
- For example, when a can of spray paint is thrown into a fire, energy enters the system (the gas in the can) by heat through the metal walls of the can. Consequently, the temperature, and thus the pressure in the can increases until the can possibly explodes.

Isobaric process



Activity 7

Study the Figure here showing a woman preparing sauce.

- (i) What name of the utensil is she using?
- (ii) Why is the utensil open?
- (iii) Do you think it is good to use an open utensil to boil liquids?



Fig 10.8: A woman preparing food

Boiling liquids in open containers is very safe for example if the container is closed, pressure may build up in the container and force it to burst. Boiling in open containers imply that the pressure of the substance is kept constant. This process is called an isobaric process. An isobaric process is the one that occurs at constant pressure.

Heating of water in an open vessel and the expansion of a gas in a cylinder with a freely moving piston are typical examples of isobaric processes. In both cases, the pressure is equal to atmospheric pressure. For example when water

is being heated, its volume increases and the pressure inside the container is constant since the number of collisions between water molecules and the walls of the container is constant.

The same process occurs when a gas enclosed in a cylinder with a frictionless piston is heated such that at any time, the gas pressure equals the external pressure.

Work done by the gas in the isobaric process

When the gas expands from volume V_1 to V_2 ,

$$\Delta W = P\Delta V = P(V_2 - V_1)$$

From a PV graph, the work equals the area under the graph.

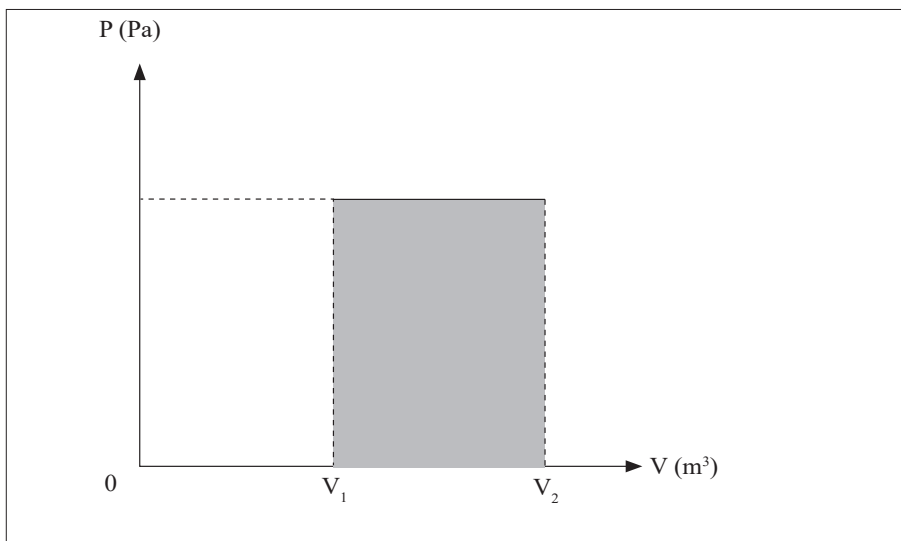

Fig 10.9: Pv graph

In this process, the energy supplied is used to increase the internal energy since the internal energy is independent of the volume.

$$\Delta Q = \Delta U + \Delta W$$

$$\Delta Q = C_V\Delta T + P(V_2 - V_1)$$

Isothermal change (constant temperature)



Activity 8

- (i) Get a polythene bag and fill it with air.
- (ii) Insert a thermometer in the bag and place it in the ice-water mixture.
- (iii) Note what happens.

Do you notice that the gas condenses and the volume decreases?
What happens to the temperature recorded by the thermometer?

You can notice that the temperature remains constant. This change is called Condensation and is an example of isothermal process.

Do you think this process is reversible?

An isothermal change can be reversible. An isothermal change is the change that occurs at constant temperature. It is either a compression or expansion of a gas at a constant temperature.

If the volume increases, the pressure must decrease and if the volume decreases, the pressure must increase

Since $PV = RT$;

It follows that $PV = \text{constant}$, since T is constant.

This equation clearly shows that for an isothermal change, Boyle's law is obeyed.

Considering states $A (P_1, V_1, T_1)$ and $B (P_2, V_2, T_2)$, represented in an isothermal expansion B- A is an isothermal compression.

$$\text{Since } \Delta Q = \Delta U + P\Delta V \Rightarrow \Delta Q = C_v\Delta T + P\Delta V$$

For an isothermal change, $\Delta Q = P\Delta V$, since $\Delta T = 0$, implying that all the heat supplied is used to do work in expanding or compressing the gas.

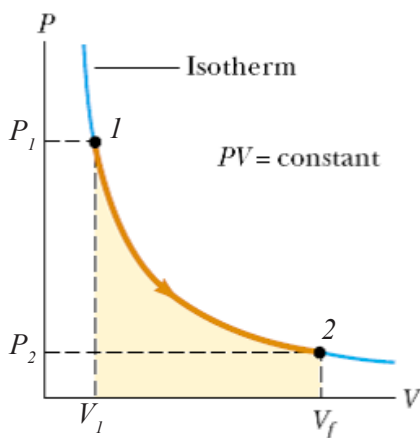

Fig 10.10: The PV diagram for an isothermal expansion (1→2) of an ideal gas from an initial state to a final state. The curve is a hyperbola

Conditions necessary for an isothermal process to occur

Activity 9: Discover



- (i) On a cold day, how do you keep yourself warm?
- (ii) In groups of five, describe how you can keep the temperature of the system constant.

For an isothermal process to take place, the gas must be contained in a thin-walled heat conducting vessel/container in good thermal contact with a constant temperature.

The process must be carried out slowly to allow time for heat exchange to take place.

Work done in Isothermal Change

Activity 10: Science at work



- (i) Have you ever tried to boil water in a closed sauce pan?
- (ii) What happens to the cover when the vapour starts to come off the water?
- (iii) Notice that this vapour pushes the cover off the pan.

We say that the vapour does work on the cover.

From the first law of thermodynamics, $\Delta Q = \Delta U + \Delta W$.

When the volume of gas changes by ΔV at constant temperature then the pressure has also to change so that the ideal gas equation is satisfied.

The work done, W is then given by $W = \int PdV$ but $PV = RT$ (For 1 mole of gas)

It follows that $P = \frac{RT}{V}$

$$\text{Thus, } W = RT \int_{V_1}^{V_2} \frac{RT}{V} dV = RT \ln [V]_{V_1}^{V_2}$$

$$W = RT (\ln V_2 - \ln V_1) = RT \ln \frac{V_2}{V_1}$$

$$W = RT \ln \left(\frac{V_2}{V_1} \right)$$

$$\text{For } n \text{ moles, } W = nRT \ln \left(\frac{V_2}{V_1} \right)$$

From the above equation, the following can be drawn;

- (i) When the gas expands (i.e $V_2 > V_1$), then W is positive.
- (ii) When the gas is compressed (i.e $V_1 > V_2$), thus W is negative, meaning that work is done on the gas in compressing it.

Example

A vessel containing $1.5 \times 10^{-3} \text{ m}^3$ of an ideal gas at a pressure of $8.7 \times 10^2 \text{ Pa}$ and at a temperature 25°C is compressed isothermally to halve its original volume.

Calculate the work done during this process. Comment on the sign of the answer ($R = 8.314 \text{ J / mol.K}$)

Solution

Given that $V_i = 1.5 \times 10^{-3} \text{ m}^3$, $V_f = 0.75 \times 10^{-3} \text{ m}^3$ after compression, $P = 8.7 \times 10^2 \text{ Pa}$, $T = 298 \text{ K}$ (25°C) and $R = 8.314 \text{ J / mol.K}$

$$\text{From } W = RT \ln\left(\frac{V_f}{V_i}\right)$$

$$W = 8.314 \times 298 \ln\left(\frac{0.75 \times 10^{-3}}{1.5 \times 10^{-3}}\right) = -1717.3 \text{ J}$$

Comment.

The answer has a negative value. This shows that the work is done on to the gas (compressed).

Adiabatic change**Activity 11**

- (i) Pump a bicycle tyre using a pump until it is full.
- (ii) Open the tube slowly while placing your other hand in its path.
- (iii) Do you notice that the the air coming out of the tyre is hotter than the surrounding air?

As one pumps, the air molecules are compressed into a smaller space. They also collide more often with the wall of the pump, so they transfer more energy to one another and become hot. No heat has been supplied to the system. It is called an adiabatic compression.

**Activity:12**

- (i) Now pump the tyre and leave it standing for sometime.
- (ii) Make sure you don't expose it to sun shine.
- (iii) Open the valve after two hours while your hand is placed in the path of air from it.

Do you notice that the air is colder than its surrounding?

Heat has been lost but not to the surroundings. When the air is left standing, expansion occurs. This is associated with a decrease in temperature. It is called an adiabatic expansion.

An adiabatic change is process in which no heat enters or leaves the gas system. It is either an expansion or a compression.

Since $\Delta Q = \Delta U + P\Delta V$ and $\Delta Q = 0$

$$\Delta Q = C_v \Delta T + P\Delta V \text{ Or } \Delta U = P\Delta V$$

If the gas expands, it does work, its internal energy is reduced and hence the temperature is lowered.

If the gas is compressed, work is done on the gas, its internal energy will increase and therefore its temperature rises.

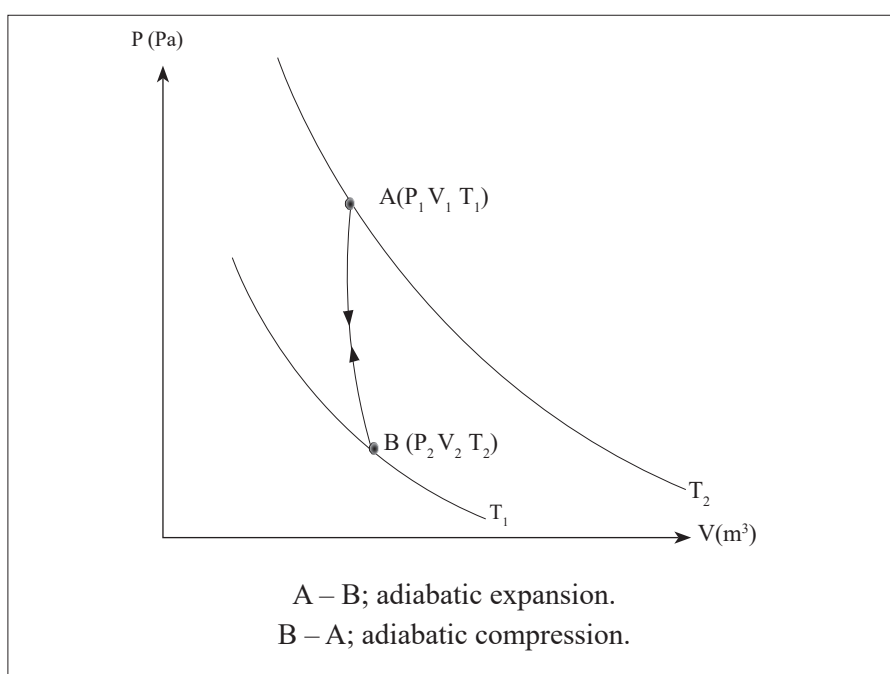

Figure 10.11: PV – diagram for an adiabatic expansion or compression

Conditions that are necessary for an adiabatic change to occur

Activity 13



How do you always protect yourself from a bad weather?

On a cold day, we always wear woolen jackets to protect ourselves from coldness. Therefore no heat is either lost to the surrounding and or gained. In this case, an adiabatic process is achieved.

For an adiabatic process to be achieved, the gas must be contained in a thick –walled and perfectly insulated isolated container.

The process must be carried out rapidly to avoid any possible heat exchanges between the gas system and the surroundings.

Equations for an adiabatic change

From the first law of thermodynamics, $\Delta Q = \Delta U + P\Delta V$

For an adiabatic process, $\Delta Q = 0$, and for 1 mole, $\Delta U = C_v\Delta T$;

$$C_v\Delta T + P\Delta V = 0 \quad (i)$$

For infinitesimal small changes, but from the ideal gas equation, for one mole,

$$PV = RT, \text{ so } , P = \frac{RT}{V} \quad (ii)$$

$$\text{Substitute (ii) in (i) } C_v\Delta T + \frac{RT}{V} \Delta V = 0$$

$$\text{Dividing throughout by } T, C_v \frac{\Delta T}{T} + R \frac{\Delta V}{V} = 0 \quad (iii)$$

But $C_p - C_v = R$;

$$C_v \frac{\Delta T}{T} + (C_p - C_v) \frac{\Delta V}{V} = 0$$

Dividing throughout by C_v ;

$$\frac{\Delta T}{T} + \left(\frac{C_p}{C_v} - 1 \right) \frac{\Delta V}{V} = 0$$

Let $\gamma = \frac{C_p}{C_v}$ (the ratio of the principal heat capacities)

$$\frac{\Delta T}{T} = (1 - \gamma) \frac{\Delta V}{V}$$

$$\text{It follows that, } \frac{\Delta T}{T} = (1 - \gamma) \frac{dV}{V} \quad (iv)$$

Integrating both sides for (iv)

$$\int \frac{dT}{T} = \int (1 - \gamma) \frac{dV}{V}$$

$$\ln T = (1 - \gamma) \ln V + \ln A$$

$$\ln T = \ln V^{(1-\gamma)} + \ln A$$

It follows that $T(A V^{1-\gamma})$

$$T = (A V^{1-\gamma})$$

Hence $TV^{\gamma-1} = \text{a constant (v)}$

From $PV = RT$, $T = \frac{PV}{R}$ (vi)

Substitute (vi) in (v)

$$\frac{PV}{R} \times V^{\gamma-1} = \text{a constant}$$

Therefore, $PV^\gamma = \text{a constant}$

Work done during adiabatic process

Since all quantities may change during adiabatic, work is always done and it is calculated from the equation below

$$W = \frac{1}{1-\gamma} (P_f V_f - P_i V_i)$$

Where

- W is the work done during adiabatic
- where $\gamma = \frac{C_p}{C_v}$, the ratio of heat capacities
- P is the pressure of the gas
- V is the volume occupied by the gas.

Activity 14



Derive the expression for temperature and pressure for adiabatic change i.e

$$T^\gamma P^{1-\gamma} = \text{a constant}$$

Example 1

A gas has a volume of 0.02 m^3 at a pressure of $2 \times 10^5 \text{ Pa}$ and a temperature of 27°C . It is heated at constant pressure until its volume increases to 0.03 m^3 . **Calculate the:**

- (i) External work done.
- (ii) New temperature of the gas.
- (iii) Increase in internal energy of the gas if its mass is 16g , its molar heat capacity at constant volume is $0.8 \text{ J mol}^{-1} \text{ K}^{-1}$ and the molar mass is 32g .

Solution

$$V_1 = 0.02 \text{ m}^3$$

$$V_2 = 0.03 \text{ m}^3$$

$$P_1 = 2 \times 10^5 \text{ Pa}$$

$$P_2 = 2 \times 10^5 \text{ Pa}$$

$$T_1 = 300 \text{ K}$$

$$T_2 = ?$$

$$C_v = 0.8 \text{ J mol}^{-1} \text{ K}^{-1}$$

$$m = 16\text{g}$$

$$M = 32\text{g}$$

- (i) External work done, $\Delta W = P\Delta V = 2 \times 10^5 (0.03 - 0.02) = 2 \times 10^3 \text{ J}$

- (ii) From $\frac{V_1}{T_1} = \frac{V_2}{T_2}$
It follows that $\frac{0.02}{300} = \frac{0.03}{T_2}$

$$\text{Hence } T_2 = 450 \text{ K}$$

- (iii) Increase in internal energy, $\Delta U = nC_v\Delta T$

$$\text{But } n = \frac{m}{M} = \frac{16}{32}$$

$$\text{Thus } \Delta U = 0.5 \times 0.8 (450 - 300) = 0.4 \times 150 = 60 \text{ J}$$

Example 2

An ideal gas at 17°C has a pressure of 760 mm Hg is compressed (i) isothermally (ii) a diabatically, until its volume is halved.

Calculate in each case the final temperature and pressure of the gas. Assume that $C_p = 2100 \text{ J mol}^{-1} \text{ K}^{-1}$ and $C_v = 1500 \text{ J mol}^{-1} \text{ K}^{-1}$.

Solution

$$P_1 = 760 \text{ mm Hg}$$

$$P_1 = \frac{1}{2} V$$

$$V_1 = V$$

$$T_1 = 290 \text{ K}$$

For isothermal change,

$$P_1 V_1 = P_2 V_2 \Rightarrow P_1 V_1 = P_2 = \frac{V_1}{2} \Rightarrow P_2 = 760 \times 2 = 1520 \text{ mm Hg}$$

$$T_1 = 290 \text{ K}$$

For adiabatic change

$$P_1 V_1^\gamma = P_2 V_2^\gamma$$

$$\text{But } \gamma = \frac{C_p}{C_v} = \frac{2100}{1500} = 1.4$$

$$P_2 = P_1 \left(\frac{V_1}{V_2} \right)^\gamma = 760 \times 2^{1.4} = 2005.56 \text{ mm Hg}$$

Using

$$TV^{\gamma-1} = \text{constant}$$

$$T_1 V_1^{\gamma-1} = T_2 V_2^{\gamma-1} \Rightarrow T_2 = T_1 \left(\frac{V_1}{V_2} \right)^{\gamma-1} = 290(2)^{0.4} = 328.7 \text{ K} = 109.7^\circ \text{C}$$

Application activity 10.2

1. A total of 135 J of work is done on a gaseous refrigerant as it undergoes compression. If the internal energy of the gas increases by 114 J during the process, what is the total amount of energy transferred by heat? Has energy been added or removed from the refrigerant by heat?
2. The internal energy of a system is initially 27 J. A total of 33 J of energy is added to the system by heat while the system does 26 J of work. What is the system's final internal energy?
3. Heat of 90 cal is supplied to a system and it is observed that no work is done. Calculate the change in internal energy of this system.
4. One mole of an ideal gas at 25°C is allowed to expand reversibly at constant temperature from a volume of 10 L to 20 L; calculate the work done by the gas in joules.

5. A certain volume of dry air at N.T.P is expanded reversibly to three times its volume

a) isothermally,

b) adiabatically.

Calculate the final temperature in each case, assuming ideal behaviour.

$$\gamma = 1.40$$

Second Law of thermodynamics

Since the first law of thermodynamics states that energy is conserved. There are, however, many processes we can imagine that conserve energy but are not observed to occur in nature. Lets consider an example below of the first law to introduce the second law.

For example, when a hot object is placed in contact with a cold object, heat flows from the hotter one to the colder one, never spontaneously the reverse. If heat were to leave the colder object and pass to the hotter one, energy could still be conserved. Yet it doesn't happen spontaneously the reverse.

There are many other examples of processes that occur in nature but whose reverse does not. To explain this lack of reversibility, scientists in the latter half of the nineteenth century formulated a new principle known as **the second law of thermodynamics**.

The second law of thermodynamics is a statement about which processes occur in nature and which do not. It can be stated in a variety of ways, all of which are equivalent. One statement is that: **“Heat can flow spontaneously from a hot object to cold object; heat will not flow spontaneously from a cold object to a hot object.”**

The development of a general statement of the second law of thermodynamics was based partly on the study of heat engines. A **heat engine** is any device that changes thermal energy into mechanical work, such as steam engines and automobile engines.

Applications of the second law of thermodynamics

Heat engines



Activity 15

- * Have you ever heard of an engine?
- * Where exactly do we find engines?
- * What do you think an engine is?
- * How do you think the engine operates?

Any device that transforms heat into work or mechanical energy is called **heat engine**. All heat engines absorb heat from a source at high temperature, perform some mechanical work, and discard heat at a lower temperature.

The process in heat engine is **cyclic** and therefore there is no change in **internal energy**. This implies $\Delta U = 0$. Thus, from first law of thermodynamics, $\Delta Q = \Delta U + \Delta W$ and $\Delta U = 0$

Thus $\Delta Q = \Delta W$. This implies that all heat supplied into the system/engine is used to do work.

Note: A **cyclic process** is one which comes back to its initial state. The graph of a cyclic process is always a closed graph.

Structure of heat engine

A heat engine has a hot reservoir at temperature T_H and a cold reservoir at temperature T_C ; Q_H flows in from the hot reservoir and Q_C flows out to the cold reservoir.

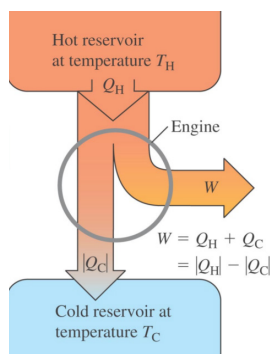

Figure 10.12: Structure of heat engine

Note: The net heat absorbed per cycle is $\theta = \theta_H + \theta_C$ and it is also the work done: $W = \theta_H + \theta_C$

Efficiency of heat engines

The efficiency of the engine as the fraction of the heat input that is converted to work. Ideally, we would like to convert all θ_H to work. Then $W = \theta_H$ and $\theta_C = 0$

Therefore efficiency e is calculated from $e = \frac{W}{\theta_H} = \frac{\theta_H + \theta_C}{\theta_H}$

This equation can also be expressed in terms of temperatures **T** (Must be in Kelvin)

$$e = \frac{T_H - T_C}{T_H}$$

Example

A steam engine operates between 500 °C and 270 °C. What is the minimum possible efficiency of this engine?

Solution

$$\text{From } e = \frac{T_H - T_C}{T_H}$$

Converting Temperatures into Kelvins $T_H = (500+273) \text{K}$, $T_H = 773 \text{K}$ and $T_L = (270+273) \text{K}$, $T_L = 543 \text{K}$.

$$e = \frac{773 - 543}{773} = 0.298 = 29.8\%$$

Impact of heat engines on climate

Most of air pollution is caused by the burning of fuels such as oil, natural gas etc. The air pollution has an adverse effect on the climate. Climate change is the greatest environmental threat of our time endangering our health. When a heat engine is running, several different types of gases and particles are emitted that can have detrimental effects on the environment.

Of concern to the environment are carbon dioxide, a greenhouse gas; and hydrocarbons. Engines emit greenhouse gases, such as carbon dioxide, which

contribute to **global warming**. Fuels used in heat engines contain carbon. The carbon burns in air to form carbon dioxide.

The Carbon dioxide and other global warming pollutants collect in the atmosphere and act like a thickening blanket and destroy the **ozone layer**. Therefore, the sun's heat from the sun is received direct on the earth surface and causes the planet to warm up.

As a result of global warming, the vegetation is destroyed, ice melts and water tables are reduced. Heat engines especially diesel engines produce Soot which contributes to global warming and its influence on climate.

The findings show that soot, also called black carbon, has a warming effect. It contains black carbon particles which affect atmospheric temperatures in a variety of ways. The dark particles absorb incoming and scattered heat from the sun; they can promote the formation of clouds that can have either cooling or warming impact. Therefore soot emissions have significant impact on climate change.

Similarly, some engines leak, for example, old car engines and oil spills all over. When it rains, this oil is transported by rain water to lakes and rivers. The oils then create a layer on top of the water and prevent free evaporation of the water.

Carnot cycle and Carnot engine

In 1824 a French engineer named **Sadi Carnot** described a theoretical engine, now called a **Carnot engine**, which is of great importance from both practical and theoretical viewpoints. He showed that a heat engine operating in an ideal, reversible cycle—called a **Carnot cycle**—between two energy reservoirs is the most efficient engine possible.

An ideal engine establishes an upper limit on the efficiencies of all other engines. That is, the net work done by a working substance taken through the Carnot cycle is the greatest amount of work possible for a given amount of energy supplied to the substance at the higher temperature.

Carnot's theorem can be stated that **no real heat engine operating between two energy reservoirs can be more efficient than a Carnot engine operating between the same two reservoirs.**

Note: No Carnot engine actually exists, but as a theoretical idea it played an important role in the development of thermodynamics.

The idealized Carnot engine consisted of four processes done in a cycle, two of which are adiabatic ($Q = 0$) and two are isothermal ($\Delta T = 0$). This idealized cycle is shown in figure 1.8.

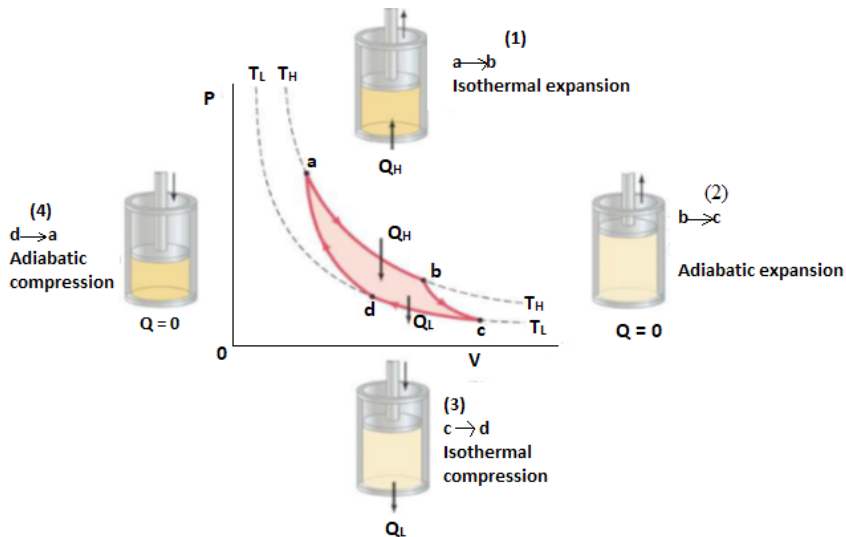

Figure 10.13: Carnot Cycle

Each of the processes was considered to be done *reversibly*. That is, each of the processes (say, during expansion of the gases against a piston) was done so slowly that the process could be considered a series of equilibrium states, and the whole process could be done in reverse with no change in the magnitude of work done or heat exchanged.

A real process, on the other hand, would occur more quickly; there would be turbulence in the gas, friction would be present, and so on. Because of these factors, a real process cannot be done precisely in reverse, the turbulence would be different, and the heat lost to friction would not reverse itself. Thus real processes are *irreversible*.

In the Carnot cycle, heat engines work in a cycle, and the cycle for the Carnot engine begins at point a on the PV diagram.

Note:

- The gas is first expanded isothermally, with addition of heat Q_H , along the path ab at temperature T_H .

- Next the gas expands adiabatically from b to c, no heat exchanged, but the temperature drops to T_L .
- The gas is then compressed at constant temperature T_L , path cd, and let Q_L flows out.
- Finally, the gas is compressed adiabatically, path da, back to its original state.

Carnot showed that for an ideal reversible engine, the heats Q_H and Q_L are proportional to the operating temperatures T_H and T_L (in Kelvin), so the efficiency can be written as:

$$e_{\text{ideal}} = \frac{T_H - T_L}{T_H} \Rightarrow e = 1 - \frac{T_L}{T_H}$$

The equation above gives a Carnot (ideal) efficiency. It expresses the fundamental upper limit to the efficiency. Real engines always have an efficiency lower than this because of losses due to friction. Real engines that are well designed reach 60 to 80% of the Carnot efficiency.

Otto Cycle and Diesel Cycle

Otto Cycle

An Otto cycle is an idealized thermodynamic cycle which describes the functioning of a typical spark ignition reciprocating piston engine, the thermodynamic cycle most commonly found in automobile engine.

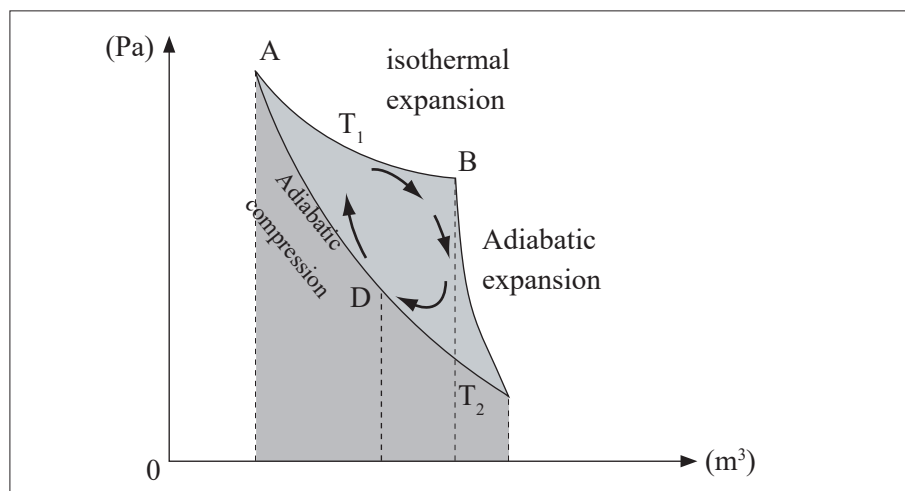

Fig 10.14: *pv graph of otto cycle*

The Pressure Volume diagram above represents the Otto cycle which has the following strokes; the intake (A) stroke is performed by an isobaric expansion,

followed by an adiabatic compression (B) stroke (along 1-2). Through the combustion of fuel, heat is added in an isovolumetric process (2-3), followed by an adiabatic expansion process (3-4), characterising the power (C) stroke. The cycle is closed by the exhaust (D) stroke, characterized by isovolumetric cooling and isobaric compression processes.

The processes are described by:

Process 1-2 is an isentropic compression of the air as the piston moves from bottom dead centre (BDC) to top dead centre (TDC).

Process 2-3 is a constant –volume heat transfer to the air from an external source while the piston is at top dead centre. This process is intended to represent the ignition of the fuel –air mixture and the subsequent rapid burning.

Process 3-4 is an isentropic expansion (power stroke).

Process 4-1 completes the cycle by a constant-volume process in which heat is rejected from the air while the piston is a bottom dead centre.

The Otto cycle consists of adiabatic compression, heat addition at constant volume, adiabatic expansion, and rejection of heat at constant volume. In the case of a four-stroke Otto cycle, technically there are two additional processes; one for the exhaust of waste heat and combustion products (by isobaric compression), and one for the intake of cool oxygen –rich) air (by isobaric expansion); however, these are often omitted in a simplified analysis. Even though these two processes are critical to the functioning of a real engine, wherein the details of heat transfer and combustion chemistry are relevant, for the simplified analysis of the thermodynamic cycle, it is simpler and more convenient to assume that all of the waste-heat is removed during a single volume change.

Diesel Cycle

The **diesel cycle** is the thermodynamic cycle, which approximates the pressure and volume of the combustion chamber of the Diesel engine, invented by Rudolph Diesel in 1897. It is assumed to have constant pressure during the first part of the “combustion” phase V_2 to V_2 in the diagram, below). This is an idealised mathematical model; real physical diesels do have an increase in pressure during this period, but it is less pronounced than in the Otto cycle. The idealized Otto cycle of a gasoline engine approximates constant volume during that phase, generating more of a spike in a P-V diagram.

The Idealised Diesel Cycle

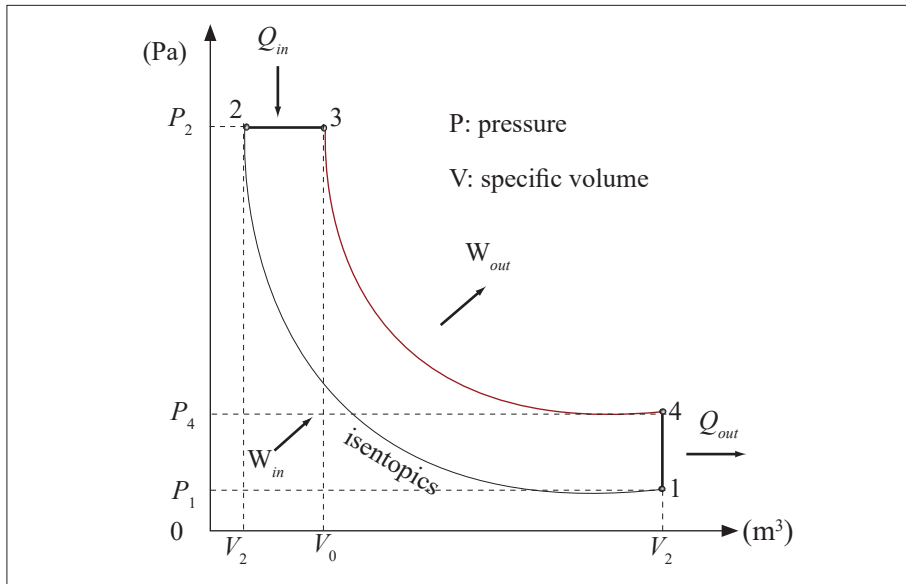

Fig 10.15: pv graph of ideal diesel cycle

From P - V diagram for the Ideal Diesel cycle, the cycle follows the numbers 1-4 in clockwise direction.

The image on the top shows a P - V diagram for the ideal Diesel cycle; where P is pressure and V is specific volume. The ideal Diesel cycle follows the following four distinct processes (the colour references refers to the colour of the line on the diagram):

Process 1-2 is isentropic (adiabatic) compression of the fluid (blue colour).

Process 2-3 is reversible (isobaric constant pressure heating (red).

Process 3-4 is isentropic (adiabatic) expansion (yellow).

Process 4-1 is reversible constant volume cooling (green).

The Diesel is a heat engine; it converts heat into work. The isentropic processes are impermeable to heat; heat flows into the loop through the left expanding isobaric process and some of it flows back out through the right depressurising process, and the heat that remains does the work.

Work in (W_{in}) is done by the piston compressing the working fluid.

Heat in (Q_{in}) is done by the combustion of the fuel.

Work out (W_{out}) is done by the working fluid expanding on to the piston (this produces usable torque).

Heat out (V_{out}) is done by venting the air.

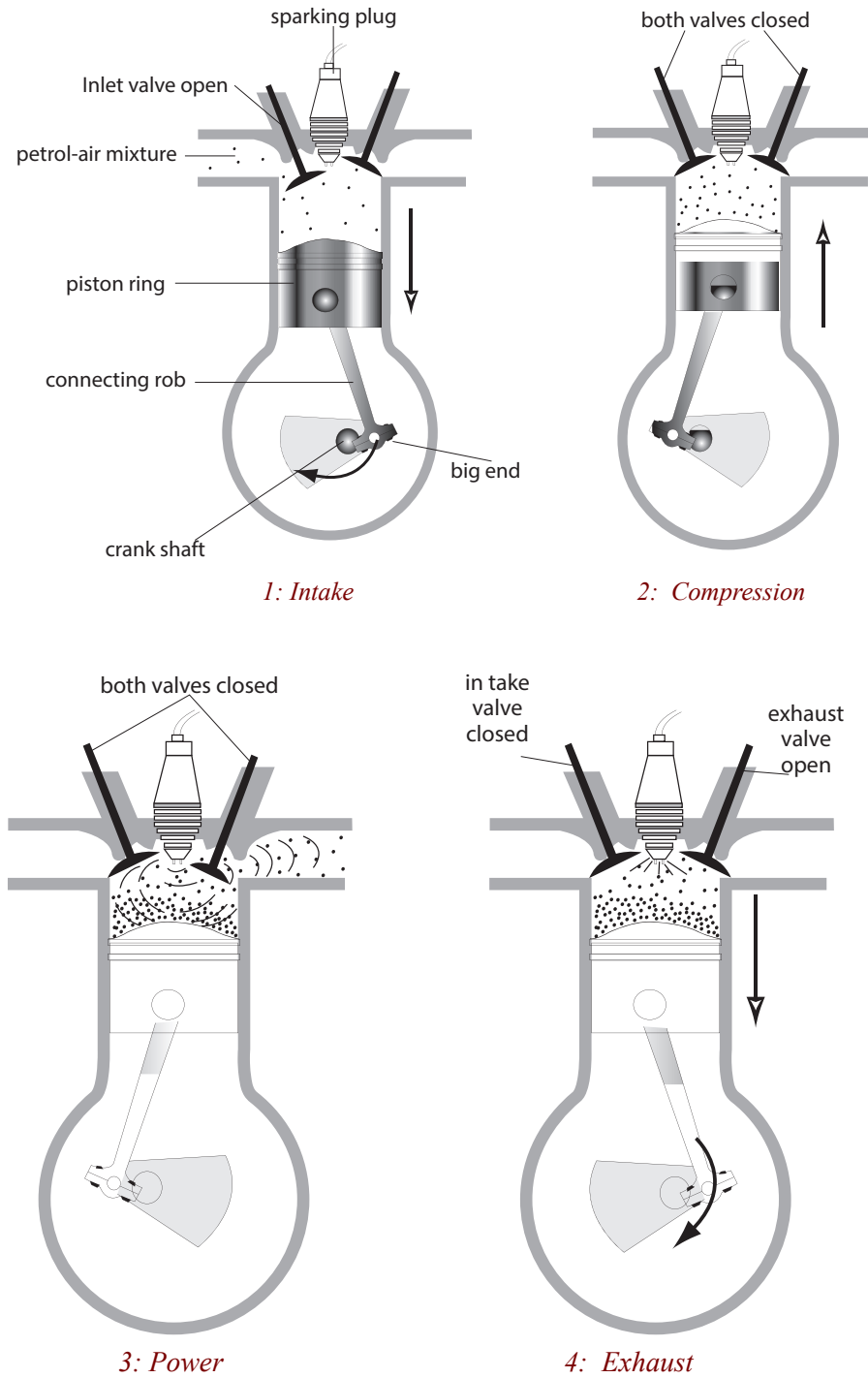

Fig 10.16: For stroke-cycle interval combustion

A heat engine is a machine, which changes heat energy, obtained by burning a fuel, to kinetic energy. In an internal combustion engine, e.g petrol, diesel, jet engine, the fuel is burnt in the cylinder of chamber where the energy change occurs. This is not so in other engines e.g steam turbine.

Petrol engine



Activity 16

- (i) How many types of fuels do vehicles use to operate?
- (ii) Have you ever heard of vehicles which use petrol in order to operate?
- (iii) List down four vehicles which use petrol.
- (iv) What type of engine do they have?

Many vehicles use petrol in order to move. Such vehicles are small cars and motorcycles. The engine they have is called a petrol engine since it uses petrol to operate. It operates by moving the piston. The upward and downward movement of the piston is called a stroke.

- a) **Four – stroke engine:** On the intake stroke, the piston moves down (due to the starter motor in a car or the kick start in a motor cycle turning the crankshaft) so reducing the pressure inside the cylinder. The inlet valve opens and the petrol – air mixture from the carburetor is forced into the cylinder by atmospheric pressure.

On the compression stroke, both valves are closed and the piston moves up, compressing the mixture.

On the power stroke, a spark jumps across the points of the sparking plug and explodes the mixture, forcing the piston down.

On the exhaust stroke, the outlet valve opens and the piston rises, pushing the exhaust gases out of the cylinder.

The crankshaft turns a flywheel (a heavy wheel) whose momentum keeps the piston moving between power strokes.

Most cars have atleast four cylinders on the same crankshaft. Each cylinder fires in turn in the order 1-3-4-2, giving a power stroke every half revolution of the crankshaft. Smoother running results.

- b) **Two-stroke engine:** This is used in mopeds, lawnmowers and small boats. Valves are replaced by ports on the side of the cylinder which are opened and closed by the piston as it moves.

Diesel engine

Activity 17



- (i) Have you ever heard of vehicles which use diesel in order to move?
- (ii) What kind of vehicles are they?
- (iii) What is the name of the engine in such vehicles?

The engine which uses diesel is called a diesel engine. A diesel engine can operate by making two or more strokes.

The operation of two and four stroke diesel engines is similar to that of the petrol varieties. However, fuel oils is used instead of petrol, there is no sparking plug and the carburetor is replaced by a fuel injector.

Air is drawn into the cylinder on the down stroke of the piston and on the upstroke it is compressed to about one-sixteenth of its original volume (which is twice the compression in a petrol engine). This very high compression increases the temperature of the air considerably and when, at the end of the compression stroke, fuel is pumped into the cylinder by the fuel injector, it ignites automatically. The resulting explosion drives the piston down on its power stroke. (You may have noticed that the air in a bicycle pump gets hot when it is squeezed. The same applies here.)

Activity: 18



State the advantages of a diesel engine over a petrol engine.

Diesel engines, sometimes called compression ignition (C.I) engines, though heavier than petrol engines, are reliable and economical. Their efficiency of about 40% is higher than that of any other heat engine. A disadvantage of the diesel engine is that its higher compression ratio means that it needs to be more robust, and is therefore more massive.

The Refrigerator



Activity: 19

- * How many of you have seen a refrigerator?
- * With the help of a teacher visit any place where there is a refrigeration and observe it carefully.
- * How useful is it to our daily lives?
- * Who can describe how it works?
- * Write your suggestions in the notebook.



Fig 10.17: Fruits and beverages in a refrigerator

A refrigerator is a device used to cool substances. It cools things by evaporation of a volatile liquid called **Freon**. The coiled pipe around the freezer at the top contains Freon which evaporates and takes latent heat from the surroundings so causing cooling. The electrically driven pump removes the vapor and forces it into the heat exchanger (pipes with cooling fins outside the rear of the refrigerator).

Here the vapor is compressed and liquefies (condenses) giving out latent heat of vaporization to the surrounding air. The liquid returns to the coils around the freezer and the cycle is repeated. An adjustable **thermostat** switches the pump on and off, controlling the rate of evaporation and so the temperature of the refrigerator.

The operating principle of refrigerators is just the reverse of a heat engine. Each operates to transfer heat out of a cool environment into warm environment.

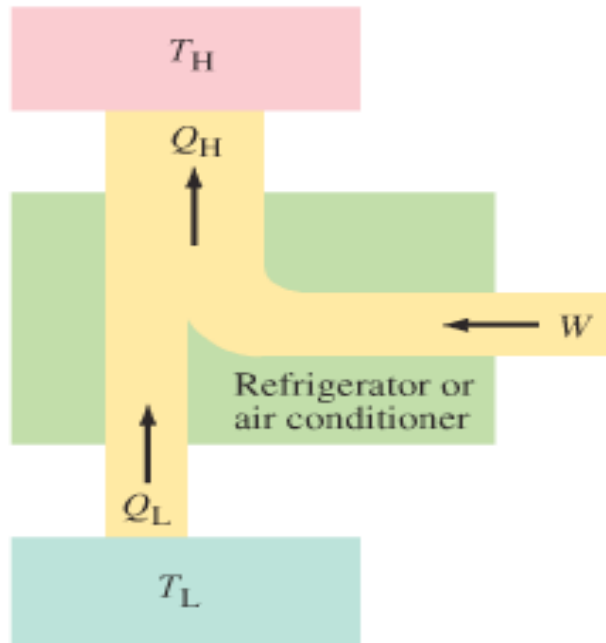

Fig. 10.18: Schematic diagram of energy transfers for a refrigerator

By doing work W , heat is taken from a low-temperature region, Q_L (such as inside a refrigerator), and a greater amount of heat is exhausted at a high temperature, Q_H (the room). You can often feel this heat blowing out beneath a refrigerator.

A perfect *refrigerator* is the one in which no work is required to take heat from the low-temperature region to the high temperature region is not possible. This is **Clausius statement of the second law of thermodynamics**, already mentioned can be stated formally as:

“No device is possible whose sole effect is to transfer heat from one system at a temperature T_L into a second system at a higher temperature T_H ”.

To make heat flow from a low-temperature object (or system) to one at a higher temperature, work must be done. Thus, **there can be no perfect refrigerator.**

The **coefficient of performance (COP)** of a refrigerator is defined as the heat Q_L removed from the low-temperature area (inside the generator) divided by the work W done to remove the heat:

$$\text{COP} = \frac{Q_L}{W}$$

This makes sense since the more heat, Q_L , that can be removed from inside the refrigerator for a given amount of work, the better (more efficient) the refrigerator is. Energy is conserved, so from the first law of thermodynamics we can write

$$Q_L + W = Q_H \text{ or } W = Q_H - Q_L.$$

Then we have:
$$\text{COP} = \frac{Q_L}{W} = \frac{Q_L}{Q_H - Q_L}$$

For an ideal refrigerator (not a perfect one, which is impossible), the best one could be:

$$\text{COP}_{\text{ideal}} = \frac{T_L}{T_H - T_L}$$

Example

An ideal refrigerator-freezer operates with a COP = 7.0 in a 24 °C room. What is the temperature inside the freezer?

Solution

From the equation of COP,

$$\text{COP}_{\text{ideal}} = \frac{T_L}{T_H - T_L}$$

Changing temperatures into Kelvins $24^\circ\text{C} + 273 = 297 \text{ K}$

$$7 = \frac{T_L}{297 - T_L}$$

Solving the Equation $T_L = 259.875 \text{ K}$, Therefore, $T_L = -13.125 \text{ }^\circ\text{C}$

END UNIT ASSESSMENT

1. What is the heat capacity at constant volume considered to be more important than at constant pressure?
2. Define: **isothermal; isobaric; isovolumic and adiabatic processes**
3. What is the relationship between the specific heat (or heat capacities) at constant pressure and at constant volume?
4. One mole of helium gas, initially at STP ($p_1 = 1 \text{ atm} = 1.03 \text{ kpa}$, $T_1 = 0^\circ \text{C} = 273.15 \text{ K}$) undergoes an isovolumetric process in which its pressure falls to half its initial value.
 - a) What is the work done by the gas?
 - b) What is the final temperature of the gas?
 - c) The helium gas then expands isobarically to twice its volume, what is the work done by the gas?
5. Find out the internal energy of a system which has constant volume and the heat around the system is increased by 50 J?
6. In a certain process 8.0 kcal of heat is furnished to the system while the system does 6.00 KJ of work. By how much does the internal energy of the system change during the process?
7. The specific heat of water is 4184 J/kg.k. By how many joules does the internal energy of 50g of water change as it is heated from 21°C to 37°C .
8. How much does the internal energy of 5.0g of ice at precisely 0°C increase as it is changed to water at 0°C ? Neglect the change in volume.
9. Find the change in work and the change in internal energy for a 6.0cm cube of iron as it is heated from 20°C to 300°C at atmospheric pressure. For iron $c = .011 \text{ cal/g}^\circ \text{C}$ and the volume efficiency of thermal expansion is $3.6 \times 10^{-5} \text{ }^\circ \text{C}^{-1}$, the mass of the cube is 1700g.
10. In each of the following situations, find the change in internal energy of the system:
 - a) A system absorbs 500cal of heat and at the same time does 400J of work.
 - b) A system absorbs 300cal and at the same time 420 J of work is done on it.
 - c) 200 Cal is removed from a gas held at a constant volume. Give your answer in KJ.