

# **Science and Elementary Technology**

**For Rwanda Schools**

**Teacher's Guide**

**Primary 6**

**Joseph Mwesigye  
Caritas Kanizio  
Millicent Omusikoyo**

  
**LONGHORN**  
PUBLISHERS LIMITED  
expanding minds

Published by

Longhorn Publishers (Rwanda) Ltd.,  
Remera opposite COGE Bank  
P.O. Box 5910  
Kigali, Rwanda

Longhorn Publishers Ltd.  
Funzi Road, Industrial Area  
P.O. Box 18033 – 00500  
Nairobi, Kenya

Longhorn Publishers (Uganda) Ltd.,  
Plot 4 Vubyabirenge, Ntinda  
P. O. Box 24745  
Kampala, Uganda

Longhorn Publishers (T) Ltd.  
New Bagamoyo/Garden Road  
Mikocheni B, Plot No. MKC/MCB/81  
P. O Box 1237  
Dar es Salaam, Tanzania

© J. Mwesigye, C. Kanizio, M. Omusikoyo, 2017

The moral rights of the authors have been asserted.  
All rights reserved. No part of this publication may be reproduced, stored in a retrieval system or transmitted in any form or by any means, electronic, mechanical, photocopying, recording or otherwise without the prior written permission of the publisher.

First published 2017

**ISBN 978 9997 74 793 8**

Printed by Ramco Printing Works Ltd,  
Unit 2, Ramco Industrial Complex,  
Before Imara Daima Turn off, Mombasa Road,  
P. O. Box 27750 - 00506,  
Nairobi, Kenya.

## Table of Content

### Part I:

<b>Introduction</b> .....	<b>1</b>
<b>Section 1: General introduction</b> .....	<b>2</b>
1.1 Structure of the book .....	2
1.2 Rationale of teaching and learning Science and elementary technology.....	4
1.3 Special needs education and inclusivity.....	5
1.4 Classroom organisation .....	7
1.5 Assessment and evaluation methods .....	9
1.6 Record keeping.....	11
1.7 Reporting to parents.....	11
<b>Section 2: Content map</b> .....	<b>12</b>
<b>Section 3: Lesson plan</b> .....	<b>31</b>
3.1 Important sub-headings of a lesson plan.....	31
3.2 Sample competence-based lesson plan.....	33
3.3 Conclusion .....	37

### Part II: Unit section

<b>Unit 1: Mechanics and Blacksmith tools</b> .....	<b>38</b>
<b>Unit 2: Simple machines</b> .....	<b>59</b>
<b>Unit 3: Objects production</b> .....	<b>75</b>
<b>Unit 4: Writing skills</b> .....	<b>89</b>
<b>Unit 5: Computer Research</b> .....	<b>120</b>
<b>Unit 6: Programming for Children</b> .....	<b>138</b>
<b>Unit 7: Air Pollution</b> .....	<b>164</b>
<b>Unit 8: Animals</b> .....	<b>179</b>
<b>Unit 9: Plant Reproduction</b> .....	<b>197</b>
<b>Unit 10: Sustainable Waste Management</b> .....	<b>218</b>
<b>Unit 11: Circulatory System</b> .....	<b>230</b>
<b>Unit 12: Respiratory System</b> .....	<b>254</b>
<b>Unit 13: Reproductive System</b> .....	<b>275</b>

<b>Unit 14: Energy Management</b> .....	<b>311</b>
<b>Unit 15: Magnetism</b> .....	<b>344</b>
<b>Unit 16: States of Matter</b> .....	<b>370</b>
<b>BIBLIOGRAPHY</b> .....	<b>392</b>

**PART 1**  
**INTRODUCTION**

## 1.1 Structure of the book

This teacher's guide is presented in **four** sections.

- **Section 1** - is the general introduction section detailing pedagogical issues.
- **Section 2** - is the content map,
- **Section 3** - gives guidelines on how to develop a lesson plan and parts that constitute a competence-based lesson plan.
- **Section 4** - which is main topics area. It gives the details of the expected learning **units** as presented in the learner's book.

### Structure of a unit

The main elements of each unit are:

- **Unit heading** – this is accompanied by some text in the pupil's book to motivate the learners. Also, the total number of lessons per unit is given.
- **Key Unit Competence:** This is the competence, which will be achieved once pupils have met all the learning objectives in the unit.
- **Pre-requisite of the unit:**  
This section details what is required to ensure success of the unit i.e what should be done for the key unit competence to be met.
- **Learning Objectives:** The content in this area is broken down into three categories, that is, knowledge and

understanding; skills; attitudes and values.

- **Knowledge and understanding:** As in the existing curriculum, knowledge and understanding is very important.
- **Skills:** It is through the skills that pupils apply their learning and engage in higher order thinking. These skills relate to the upper levels of Bloom's taxonomy and they lead to deep rather than surface learning.
- **Attitudes and values:** Truly engaging with learning requires appropriate attitudes and values that relate to the unit.
- **Links to other subjects:** It is important for learners to gain an understanding of the interconnections between different subjects so that learning in each subject is reinforced across the curriculum. This platform does exactly that. It prepares the teacher to pass this information to the learners so that they are aware!
- **Background information:** This is the introduction part of the unit. It aims at giving insights to the teacher on the subject matter.

- **Cross cutting issues** to be tackled in the unit and how to address them.
  - **Generic competences** to be attained by learners and how to develop them.
  - **Key words in the unit** – a list of new words or vocabularies and their meanings.
  - **Guidance on the problem statement:** This is given as a picture in the pupil's book requiring learner interpretation. It highlights how the teacher should introduce the unit and create a problem situation for learners to brainstorm and predict what the unit is about.
  - **Attention to special needs education:** This section gives guidance on how to cater for multi-ability learning and how to support learners with special needs.
  - **List of lessons:** This section gives lesson number, title and number of periods expected to cover the lesson. Immediately after the list are the lessons themselves covered in detail per sub-topic.
- Summary of the unit** – This section details how the teacher will go about winding up the unit. It also details the values and key competencies that the learner needs to have achieved.

### **Additional information for the teacher**

This is a platform where text related to the content areas being taught but not expressly within the syllabus requirements are presented. The content here is intended to help the teacher understand the concepts more deeply and to be in a position to answer questions from more proactive learners.

### **Answers to test your competence**

This section provides answers to revision questions at end of the unit.

- **Additional activities for slow and gifted learners.**

These are further exercises and their answers intended for remedial learning for slow learners and extended exercises for gifted learners.

- **Lessons development**

All the lessons have these main features:

- *Lesson number and title*
- *Pre-requisite of the lesson – guidance on how to begin the lesson.*
- *Teaching aids or resources in line with the teaching objectives.*
- *Suggested learning activities*

- **Lesson synthesis** – which is an indication to the teacher on how

to go about in order to meet the lesson objective(s).

**Assesment** – A suggestion on how to assess whether lesson objectives have been met or not.

## 1.2 Rationale of teaching and learning Science & elementary technology

Teaching elementary science to young children is critical for establishing a foundation for further success in science and for coping with the demands of the 21st century. Furthermore, technology education constitutes an unequalled important added value. Not only in developed countries but also in developing countries such as Rwanda, the love and interest in science and technology begins in primary school where young children tend to be more curious and motivated to learn. The inclusion of Science and Elementary Technology and ICT in the Primary School reflects the importance of science and technology in many aspects of our daily lives, at work, at school and at home. As integrated Science and ICT, it provides a very good foundation for the study of science subjects in the post-primary setting. Most importantly, it cultivates a positive attitude towards science and provides pupils with opportunities to experience the excitement of working as a scientist.

Above all, the rationale of teaching and learning of SET & ICT is embedded in the need for learners to have a greater awareness of the role of Science and

Technology in everyday life. SET & ICT at primary school enables the learner to develop competencies, which have great impact on the society in general. Teaching SET&ICT at primary school is further justified in that it helps to develop cultural and democratic notions of scientific literacy.

Learners have to be prepared from an early age for active and responsible citizenship. With this regard, SET & ICT strives to equip learners to understand and situate scientific and technological developments in their cultural, environmental, economic, political and social contexts. At the centre of teaching and learning of SET & ICT, hands on activities will play a key role, which in turn, should contribute significantly towards improving learner's achievement, motivation, technological literacy and test scores.

### ***SET&ICT as a subject and developing the competences***

The national policy documents based on national aspirations identify some 'basic Competencies' alongside the 'Generic Competencies' that will develop **higher order critical thinking skills** and help the pupil learn Science, Elementary technology and Information Communication technology for application in real life. The nature of learning activities which are mainly inquiry-oriented contribute to the achievement of those competencies. Through observations, experimentation, and presentation of information during



the learning process, the learner will not only develop deductive and inductive skills but also acquire cooperation and communication, critical thinking and problem-solving skills. This will be realised when learners make presentations leading to inferences and conclusions at the end of learning unit. This will be achieved through learner group work and cooperative learning of SET–ICT, which in turn will promote interpersonal relations and teamwork.

The manipulation of apparatus and data during class experiments and undertaking of project work by learners will involve analytical and problem-solving skills directed towards innovation, creativity and research activities by learners.

The acquired knowledge in learning SET–ICT should develop a responsible citizen who adapts to scientific reasoning and attitudes and develops confidence in reasoning independently. The learner should show concern of individual attitudes, environmental protection and comply with the scientific method of reasoning. The scientific method should be applied with the necessary rigor, intellectual honesty to promote critical thinking while systematically pursuing the line of thought.

### **1.3 Special needs education and inclusivity**

All Rwandans have the right to access education regardless of their different needs. The underpinnings of this provision would naturally hold that all citizens

benefit from the same menu of educational programs. The possibility of this assumption is the focus of special needs education. The critical issue is that we have persons/learners who are totally different in their ways of living and learning as opposed to the majority. The difference can either be emotional, physical, sensory and intellectual learning challenges traditionally known as mental retardation. These learners equally have the right to benefit from the free and compulsory basic education in the nearby ordinary/mainstream schools. Therefore, the schools' role is to enrol them and also set strategies to provide relevant education to them. The teacher therefore is requested to consider each learner's needs during teaching and learning process. Assessment strategies and conditions should also be standardised to the needs of these learners. Also, ensure that you include learners with special educational needs in classroom activities as much as possible.

The special needs children can fall in any of the following common categories:

- Physical difficulties
- Visual difficulties
- Hearing difficulties
- Mental difficulties

The teacher should identify such cases and help facilitate the affected learners learning. For example, learner's with visual and hearing difficulties should sit near the teacher's table for easy supervision and assistance. The following are some suggestions on how to support special needs children in your class.

### **(a) Learners with physical difficulties**

In this group of learners, the affected areas are normally some body parts, especially the limbs. There may be partial or total loss of use of the limbs. In case the legs are affected, the learners will need assistance during activities that involve movement. This could be during a nature walk and other activities that learners have to stand for some reason. The teacher should organize for the learner's ease of movement around. The learner should also be given time to catch up with the others.

In case the hands are affected, the learners should be given more time to finish their work. In both cases, the learners should not be pressurized to do things that can cause injury or ridicule.

### **(b) Learners with visual difficulties**

These learners normally have problems with their eyesight. They should sit in a position where they are able to see the chalkboard without straining. Such learners could be longsighted or short sighted.

The material to be observed should be brought closer to the learner and a magnifying lens used where necessary. The teacher should use large diagrams, charts and labels. In some cases, the learners can be allowed to touch and feel whatever they are looking at. Other learners can assist by reading aloud. The lighting system in the classroom can also be improved.

The teacher should read aloud most of the things he/she writes on the chalkboard.

### **(c) Learners with hearing difficulties**

The affected part in this case is the ear. The learner should have **hearing aids**. The teacher should use as many visual aids as possible. They should also project their voice and always talk while facing the learners. Use of gestures and signs while talking helps the learner figure out what the teacher is saying as well.

### **(d) Learners with speech difficulties**

A common example in a normal class is the **stammerer**. They always speak with a lot of difficulties. The teacher should be patient with them and encourage such learners to express themselves in their own way. Such learners should be given more written exercises.

### **(e) Learners with mental difficulties**

The teacher should try to identify the nature and level of the mental difficulty. Learners with mental difficulties should then be given special assistance and attention at an individual level. They can be given special tests or assessments. In general, all the learners with difficulties should be reinforced promptly. This encourages and motivates them. The teacher and the rest of

the class should never ridicule learners with any of the difficulties. Note that generally, people with any kind of disability can be very sensitive to any kind of negative comments or criticism.

**Remind them that ‘Disability is not inability’.**

The teacher should avoid giving privileges where the learners do not deserve them. Treat them fairly but not with undue favours. In extreme cases it can be recommended for the learners to join a special school.

### 1.4 Classroom organisation

A well organised classroom is an asset to good Science teaching but there is no one correct style to suit all classrooms and situations. However, the teacher should consider the following factors when organising the classroom:

- (a) Furniture should be well arranged so as to allow free movement of learners and the teacher.
- (b) Set a corner for storing materials so as not to obstruct learners or distract them.
- (c) The number of learners in the class and their ages.
- (d) Learners should be reasonably spread out so that they do not interfere with one another’s activities.
- (e) The series of lessons or activities going on for a number of days or weeks such as individual or group work or whole class.

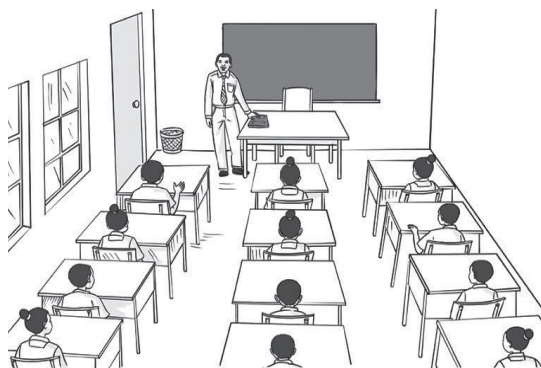

Fig. 1.1 Sample classroom arrangement

- (f) Classroom itself, that is, positions of windows, doors such that learners face the lighted areas of the room.
- (g) Personal preferences. But these should be in the interest of the learners especially where the teacher normally stand, the teacher should be able to communicate with all learners, and also have a general view of all learners in the class.

### Grouping learners for learning

Most of the science activities are carried out in groups and therefore the teacher should place 2 or 3 desks against each other and then have a group of learners sitting around those desks.

In certain activities, the teacher may wish to carry out a demonstration. In this case, the learners should be sitting or standing in a semicircle, or arranged around an empty shape of letter “U” such that each learner can see what the teacher is doing clearly and without obstruction or pushing. If the learners are involved in individual work, each learner can work on the floor or on the desk or a portion of the desk if they

are sharing. In this case, they need not face each other.

Grouping learners for learning has increasingly become popular in recent years. In fact, the shift from knowledge-based to competence-based curriculum will make grouping the norm in the teaching process. Grouping learners can be informed by one or all of the following:

- (a) Similar ability grouping.
- (b) Mixed ability grouping.
- (c) Similar interests grouping.
- (d) Needs grouping.
- (e) Friendship grouping.
- (f) Sex grouping.

In Science, groupings are commonly those of types (a), (b), (c) and (d). Grouping learners has several advantages such as:

- (a) The individual learner's progress and needs can easily be observed.
- (b) The teacher-learner relationship is enhanced.
- (c) A teacher can easily attend to the needs and problems of a small group.
- (d) Materials that were inadequate for individual work can now easily be shared.
- (e) Learners can learn from one another.
- (f) Cooperation among learners can easily be developed.
- (g) Many learners accept correction from the teacher more readily and without feeling humiliated when they are in a small group rather than the whole class.

(h) Learners' creativity, responsibility and leadership skills can easily be developed.

(i) Learners can work at their own pace.

The type of "grouping" that a teacher may choose depends on:

- (a) The topic or task to be tackled.
- (b) The materials available.
- (c) Ability of learners in the class.

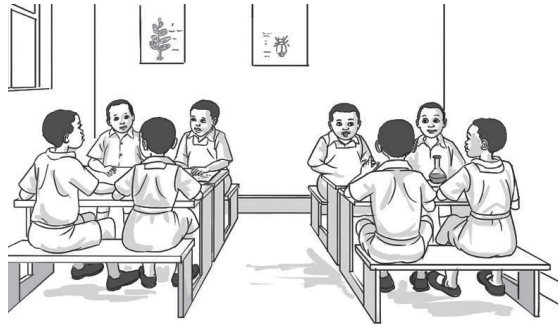

*Fig. 1.2 Sample classroom grouping*

However, the teacher must be flexible enough to adjust or change his/her type of grouping to cope with new situations.

There is no fixed number of learners that a group must have. This again will be dictated by such factors as the task to be done, the material available, characteristics of learners in your class, size and the space available. However, groups should on average have between **four to seven learners**. You can also resort to pairwork depending on the nature of the content being taught at the time.

**Note:**

There is no one method or approach to teaching that is appropriate to all lessons. A teacher should, therefore, choose wisely the method to use or a

combination of methods depending on the nature of the topic or subtopic at hand.

### **Safety in the classroom**

Pupils in primary school are extremely active and curious. As such, they are inclined to getting harmed and injured. They should therefore be constantly protected from sources of injury and harm. The teacher is therefore advised to take strict safety precautions whenever learners are in class or outside the classroom. Some areas that need consideration as far as safety is concerned include:

- During tasting and smelling things.
- When using tools and equipment.
- During experiments, demonstrations involving use of fire or harmful chemicals.
- When handling glass apparatus.
- When handling sharp or pointed objects like machete, pair of scissors, razor-blade, knife, etc.
- During nature walks and field visits. Learners should avoid handling poisonous plants and harmful animals, etc.

Remember, according to Rwanda laws, the teacher is responsible for the safety of the learners during the period he or she is handling them.

### **1.5 Assessment and evaluation methods**

Assessment is the process of evaluating the teaching and learning processes through collecting and interpreting evidence of individual learner's progress in learning and to make a judgment about a learner's achievements measured against defined standards. Assessment is an integral part

of the teaching and learning processes. In the new competence-based curriculum assessment must also be competence-based; whereby a learner is given a complex situation related to his/her everyday life and asked to try to overcome the situation by applying what he/she learned.

### **Types of assessment**

The two types of assessment that will be employed in the new curriculum is **formative** and **summative** assessment.

#### **(a) Formative or continuous assessment (assessment for learning)**

Formative or continuous assessment involves formal and informal methods used by schools to check whether learning is taking place. When the teacher is planning his/her lesson, he/she should establish criteria for performance and behaviour changes at the beginning of the unit. Then at the end of every unit, the teacher should ensure that all the learners have mastered the stated key unit competencies basing on the criteria stated, before going to the next unit. The teacher will assess how well each learner masters both the subject matter and the generic competencies described in the syllabus and from this, the teacher will gain a picture of the all-round progress of the learner. The teacher will use one or a combination of the following:

- Observations - to judge the extend of skills acquisition
- Written tests
- Practical work/activities
- Oral questions or interviews
- Project works

- Attitude change – this can be done by asking probing questions and checking body language as learners respond to the questions.

### **(i) Written tests**

Under this, learners are given questions or tasks and are required to respond in writing. Examples of written tests are: short answer type questions, structured type questions, filling blanks, multiple choice questions, true-false questions and matching items.

### **(ii) Practical work activity**

In this category, learners are required to perform a task or solve a problem practically. The teacher then assesses the finished work by looking at the materials used, procedures followed, whether it works or not or whether it is finished. He or she then awards marks accordingly.

### **(iii) Observation**

This involves the teacher observing learners as they perform a practical task to assess acquisition of skills and attitude change. The teacher checks ability of the learner to measure, classify, communicate findings, etc. He or she also assesses the learner's curiosity, patience, team and co-operation spirit among others.

### **(iv) Oral questions or interviews**

Asking learners questions which require a verbal response such as naming parts of human body, a system or short explanations of a process such as digestion can also be used to assess learner's level of competence.

### **(v) Project work**

In a project, the teacher will give a task to a learner or group of learners and monitor progress of work until completion. He/she then awards marks depending on how effective the task was accomplished.

A teacher can use one or several of these assessment methods depending on the subtopic being studied or the purpose for which assessment is required.

### **When should the teacher assess learning progress?**

The teacher should decide whether to assess learners at the end of the lesson or at any other appropriate time when enough content has been covered.

### **(b) Summative assessment (assessment of learning)**

When assessment is used to record a judgment of a competence or performance of the learner, it serves a summative purpose. Summative assessment gives a picture of a learner's competence or progress at any specific moment. The main purpose of summative assessment is to evaluate whether learning objectives have been achieved and to use the results for the ranking or grading of learners, for deciding on progression, for selection into the next level of education and for certification. This assessment should have an integrative aspect whereby a student must be able to show mastery of all competencies.

It can be internal school-based assessment or external assessment in the form of national examinations. School-based summative assessment should take place once at the end of each term and once at the end of the year. School summative assessment average scores for each subject will be weighted and included in the final national examinations grade. Districts will be supported to continue their initiative to organise a common test per class for all the schools to evaluate the performance and the achievement level of learners in

individual schools. External summative assessment will be done at the end of P6.

### **Item writing in summative assessment**

Before developing a question paper, a plan or specification of what is to be tested or examined must be elaborated to show the units or topics to be tested on, the number of questions in each level of Bloom's taxonomy and the marks allocation for each question. In a competency-based curriculum, questions from higher levels of Bloom's taxonomy should be given more weight than those from knowledge and comprehension level.

Before developing a question paper, the item writer must ensure that the test or examination questions are tailored towards competence based assessment by doing the following:

- Identify topic areas to be tested on from the subject syllabus.
- Outline subject matter content to be considered as the basis for the test.
- Identify learning outcomes to be measured by the test.
- Prepare a table of specifications.
- Ensure that the verbs used in the formulation of questions do not require memorisation or recall answers only but testing broad competencies as stated in the syllabus.

### **1.6 Record Keeping**

This is gathering facts and evidence from assessment instruments and using them to judge the student's performance by

assigning an indicator against the set criteria or standard. Whatever assessment procedures used shall generate data in the form of scores which will be carefully be recorded and stored in a portfolio because they will contribute for remedial actions, for alternative instructional strategy and feed back to the learner and to the parents to check the learning progress and to advice accordingly or to the final assessment of the students.

This portfolio is a folder (or binder or even a digital collection) containing the student's work as well as the student's evaluation of the strengths and weaknesses of the work. Portfolios reflect not only work produced (such as papers and assignments), but also it is a record of the activities undertaken over time as part of student learning. The portfolio output (formative assessment) will be considered only as enough for three years of Advanced level. Besides, it will serve as a verification tool for each learner that he/she attended the whole learning before he/she undergoes the summative assessment for the subject. The results from the portfolio will contribute 50% on summative assessment of each year.

### **1.7 Reporting to parents**

The wider range of learning in the new curriculum means that it is necessary to think again about how to share learners' progress with parents. A single mark is not sufficient to convey the different expectations of learning, which are in the learning objectives. The most helpful reporting is to share what students are doing well and where they need to improve.

	Unit 1	Unit 2	Unit 3	Unit 4
<b>Unit title</b>	Mechanics and blacksmith tools	Simple Machines	Objects production	Writing skills
<b>Number of periods</b>	6	12	8	17
<b>Key Unit Competence</b>	After studying this unit, learners should be able to use and maintain mechanics and blacksmith tools safely.	After studying this unit, learners should be able to classify simple machines and levers.	After studying this unit learners should be able to make utility objects, toys and learning materials.	After studying this unit, learners should be able to use common ICT terms and differentiate Sugar and Gnome user interfaces.
<b>Number of Lessons</b>	6	5	5	11
<b>Equipment / Learning / Teaching materials required</b>	<ul style="list-style-type: none"> <li>• Hammer, screw-driver, open-ended spanner, pliers, hand drill, bench vice, bellows, anvil, blacksmith hammer, blacksmith's pliers or pair of tongs.</li> </ul>	Axle, inclined planes, screws, pulleys, wedges, wheel and levers (crow-bars, scissors, see-saws, wheel barrow, nut-cracker, hoe, fishing rad, spade, pair of tong, broom)	Clay, wires, threads, needle or lancelet, papers, manila paper and scissors	<ul style="list-style-type: none"> <li>• XO Laptops or any other computer</li> <li>• Shopping lists</li> <li>• Internet connectivity</li> <li>• Video link</li> </ul>



<p><b>Activities / Techniques</b></p>	<ul style="list-style-type: none"> <li>• Tool box</li> <li>• Grease or oil</li> <li>• File</li> <li>• Video link</li> <li>• Case studies</li> <li>• Guided discovery</li> <li>• Observation</li> <li>• Practical work</li> <li>• Group discussions</li> <li>• Pair work</li> <li>• Question and answer</li> <li>• Demonstrations</li> </ul>	<ul style="list-style-type: none"> <li>• Group discussions</li> <li>• Practical work</li> <li>• Role play</li> <li>• Guided discovery</li> <li>• Demonstration</li> </ul>	<ul style="list-style-type: none"> <li>• Practical work</li> <li>• Guided discussion</li> <li>• Guided discovery</li> <li>• Group work</li> <li>• Question and answers</li> <li>• Discussions and presentation</li> <li>• Demonstration</li> </ul>	<ul style="list-style-type: none"> <li>• Class practice and discussions</li> <li>• Question and answer sessions</li> <li>• Teacher demonstrations</li> <li>• Guided discovery</li> <li>• Individual practice</li> </ul>
---------------------------------------	---	---	--	---

<p><b>Generic Competences Practiced</b></p>	<ul style="list-style-type: none"> <li>• Co-operation and interpersonal management and life skills</li> <li>• Research skills</li> </ul>	<ul style="list-style-type: none"> <li>• Co-operation and interpersonal management and life skills</li> <li>• Research skills</li> </ul>	<ul style="list-style-type: none"> <li>• Co-operation and interpersonal management and life skills</li> <li>• Research skills</li> </ul>	<ul style="list-style-type: none"> <li>• Co-operation and interpersonal management and life skills</li> <li>• Research skills</li> </ul>
	<ul style="list-style-type: none"> <li>• Communication in English</li> <li>• Critical thinking and problem solving skills</li> <li>• Lifelong skills</li> <li>• Creativity and innovation</li> </ul>	<ul style="list-style-type: none"> <li>• Communication in English</li> <li>• Critical thinking and problem solving skills</li> <li>• Lifelong skills</li> <li>• Creativity and innovation</li> </ul>	<ul style="list-style-type: none"> <li>• Communication in English</li> <li>• Critical thinking and problem solving skills</li> <li>• Lifelong skills</li> <li>• Creativity and innovation</li> </ul>	<ul style="list-style-type: none"> <li>• Communication in English</li> <li>• Critical thinking and problem solving skills</li> <li>• Lifelong skills</li> <li>• Creativity and innovation</li> </ul>
<p><b>Cross-cutting issues to be addressed</b></p>	<ul style="list-style-type: none"> <li>• Environment, climate change and sustainability</li> <li>• Gender education</li> </ul>	<ul style="list-style-type: none"> <li>• Environment, climate change and sustainability</li> </ul>	<ul style="list-style-type: none"> <li>• Environment, climate change and sustainability</li> </ul>	<ul style="list-style-type: none"> <li>• Gender education</li> <li>• Peace and values education.</li> <li>• Financial education</li> </ul>

	<ul style="list-style-type: none"> <li>Peace and values education.</li> <li>Financial education</li> <li>Standardization culture</li> <li>Inclusive learning</li> </ul>	<ul style="list-style-type: none"> <li>Gender education</li> <li>Peace and values education:</li> <li>Financial education</li> <li>Standardization culture</li> <li>Inclusive learning</li> </ul>	<ul style="list-style-type: none"> <li>Gender education</li> <li>Peace and values education:</li> <li>Financial education</li> <li>Standardization culture</li> <li>Inclusive learning</li> </ul>	<ul style="list-style-type: none"> <li>Standardisation culture</li> <li>Inclusive learning</li> </ul>
<b>Assessment Strategies of key unit competence</b>	<p>Assess achievement of the key unit competency using:</p> <ul style="list-style-type: none"> <li>Gauge learner understanding of concepts using the self-test exercises, unit tests, remedial &amp; extended activities and the lesson assessment questions.</li> </ul>	<p>Assess achievement of the key unit competency using:</p> <ul style="list-style-type: none"> <li>Gauge learner understanding of concepts using the self-test exercises, unit tests, remedial &amp; extended activities and the lesson assessment questions.</li> </ul>	<p>Assess achievement of the key unit competency using:</p> <ul style="list-style-type: none"> <li>Gauge learner understanding of concepts using the self-test exercises, unit tests, remedial &amp; extended activities and the lesson assessment questions.</li> </ul>	<p>Assess achievement of the key unit competency using:</p> <ul style="list-style-type: none"> <li>Gauge learner understanding of concepts using the self-test exercises, unit tests, remedial &amp; extended activities and the lesson assessment questions.</li> </ul>

	<ul style="list-style-type: none"> <li>• Measure extent of skills acquisition through observing learners as they perform various activities.</li> <li>• Gauge attitude change and values acquisition by asking learners about their opinions on various issues affecting the society and through body language as they perform various tasks.</li> <li>• In all the above cases, allocate marks and grade learners accordingly.</li> </ul>	<ul style="list-style-type: none"> <li>• Measure extent of skills acquisition through observing learners as they perform various activities.</li> <li>• Gauge attitude change and values acquisition by asking learners about their opinions on various issues affecting the society and through body language as they perform various tasks.</li> <li>• In all the above cases, allocate marks and grade learners accordingly.</li> </ul>	<ul style="list-style-type: none"> <li>• Measure extent of skills acquisition through observing learners as they perform various activities.</li> <li>• Gauge attitude change and values acquisition by asking learners about their opinions on various issues affecting the society and through body language as they perform various tasks.</li> <li>• In all the above cases, allocate marks and grade learners accordingly.</li> </ul>	<ul style="list-style-type: none"> <li>• Measure extent of skills acquisition through observing learners as they perform various activities.</li> <li>• Gauge attitude change and values acquisition by asking learners about their opinions on various issues affecting the society and through body language as they perform various tasks.</li> <li>• In all the above cases, allocate marks and grade learners accordingly.</li> </ul>
--	--	--	--	--

	<b>Unit 5</b>	<b>Unit 6</b>	<b>Unit 7</b>	<b>Unit 8</b>
<b>Unit title</b>	Computer Research	Programming for children	Air pollution	Animals
<b>Number of periods</b>	10	12	12	17
<b>Key Unit Competence</b>	After studying this unit, you should be able to explore and use Search engines.	After studying this unit, you should be able to design and construct geometric shapes using Turtle Art activity and design different projects in Scratch and use Etoys activities.	After studying this unit, learners should be able to explain the phenomenon of air pollution, its consequences and its management.	After studying this unit, learners should be able to explain and practice effective management of goats and cows.
<b>Number of Lessons</b>	6	9	4	11
<b>Equipment / Learning /Teaching materials required</b>	<ul style="list-style-type: none"> <li>• XO Laptops or any other computer</li> <li>• Internet connectivity</li> </ul>	<ul style="list-style-type: none"> <li>• XO Laptops or any other computer</li> <li>• Internet connectivity</li> <li>• Video link</li> </ul>	<ul style="list-style-type: none"> <li>• Charts on pollution</li> <li>• Local environment</li> <li>• Factories or industries around</li> </ul>	<ul style="list-style-type: none"> <li>• Cows or goats, cattle or goat houses, pictures/drawings, pots, water</li> </ul>

<p><b>Activities / Techniques</b></p>	<ul style="list-style-type: none"> <li>• Class practice and discussions</li> <li>• Question and answer sessions</li> <li>• Teacher demonstrations</li> <li>• Guided discovery</li> <li>• Individual practice</li> </ul>	<ul style="list-style-type: none"> <li>• Class practice and discussions</li> <li>• Question and answer sessions</li> <li>• Teacher demonstrations</li> <li>• Guided discovery</li> <li>• Individual practice</li> </ul>	<ul style="list-style-type: none"> <li>• Guided discovery</li> <li>• Group work</li> <li>• Question and answers</li> <li>• Discussions and presentations</li> </ul>	<ul style="list-style-type: none"> <li>• Practical work</li> <li>• Field visits</li> <li>• Guided discovery</li> <li>• Resource person</li> <li>• Discussions and presentation</li> </ul>
<p><b>Generic Competences Practiced</b></p>	<ul style="list-style-type: none"> <li>• Co-operation and interpersonal management and life skills</li> <li>• Research skills</li> <li>• Communication in English</li> <li>• Critical thinking and problem solving skills</li> <li>• Lifelong skills</li> <li>• Creativity and innovation</li> </ul>	<ul style="list-style-type: none"> <li>• Co-operation and interpersonal management and life skills</li> <li>• Research skills</li> <li>• Communication in English</li> <li>• Critical thinking and problem solving skills</li> <li>• Lifelong skills</li> <li>• Creativity and innovation</li> </ul>	<ul style="list-style-type: none"> <li>• Co-operation and interpersonal management and life skills</li> <li>• Research skills</li> <li>• Communication in English</li> <li>• Critical thinking and problem solving skills</li> <li>• Lifelong skills</li> <li>• Creativity and innovation</li> </ul>	<ul style="list-style-type: none"> <li>• Co-operation and interpersonal management and life skills</li> <li>• Research skills</li> <li>• Communication in English</li> <li>• Critical thinking and problem solving skills</li> <li>• Lifelong skills</li> <li>• Creativity and innovation</li> </ul>

<p><b>Cross-cutting issues addressed</b></p>	<ul style="list-style-type: none"> <li>• Gender education</li> <li>• Peace and values education:</li> <li>• Financial education</li> <li>• Standardization culture</li> <li>• Inclusive learning</li> </ul>	<ul style="list-style-type: none"> <li>• Gender education</li> <li>• Peace and values education:</li> <li>• Financial education</li> <li>• Standardization culture</li> <li>• Inclusive learning</li> </ul>	<ul style="list-style-type: none"> <li>• Environment, climate change and sustainability</li> <li>• Gender education</li> <li>• Peace and values education:</li> <li>• Financial education</li> <li>• Standardization culture</li> <li>• Inclusive learning</li> </ul>	<ul style="list-style-type: none"> <li>• Gender education</li> <li>• Peace and values education:</li> <li>• Financial education</li> <li>• Standardization culture</li> <li>• Inclusive learning</li> <li>• Environment, climate change and sustainability</li> </ul>
<p><b>Assessment Strategies of key unit competence</b></p>	<p>Assess achievement of the key unit competency using:</p> <ul style="list-style-type: none"> <li>• Gauge learner understanding of concepts using the self-test exercises, remedial unit tests, remedial &amp; extended activities and the lesson assessment questions.</li> </ul>	<p>Assess achievement of the key unit competency using:</p> <ul style="list-style-type: none"> <li>• Gauge learner understanding of concepts using the self-test exercises, remedial unit tests, remedial and extended</li> </ul>	<p>Assess achievement of the key Assess achievement of the key unit competency using:</p> <ul style="list-style-type: none"> <li>• Gauge learner understanding of concepts using the self-test exercises, remedial unit tests, remedial and extended</li> </ul>	<p>Assess achievement of the key Assess achievement of the key unit competency using:</p> <ul style="list-style-type: none"> <li>• Gauge learner understanding of concepts using the self-test exercises, remedial unit tests, remedial and extended</li> </ul>

	<ul style="list-style-type: none"> <li>• Measure extent of skills acquisition through observing learners as they perform various activities.</li> <li>• Gauge attitude change and values acquisition by asking learners about their opinions on various issues affecting the society and through body language as they perform various tasks.</li> <li>• In all the above cases, allocate marks and grade learners accordingly.</li> </ul>	<p>activities and the lesson assessment questions.</p> <ul style="list-style-type: none"> <li>• Measure extent of skills acquisition through observing learners as they perform various activities.</li> <li>• Gauge attitude change and values acquisition by asking learners about their opinions on various issues affecting the society and through body language as they perform various tasks.</li> <li>• In all the above cases, allocate marks and grade learners accordingly.</li> </ul>	<p>activities and the lesson assessment questions.</p> <ul style="list-style-type: none"> <li>• Measure extent of skills acquisition through observing learners as they perform various activities.</li> <li>• Gauge attitude change and values acquisition by asking learners about their opinions on various issues affecting the society and through body language as they perform various tasks.</li> <li>• In all the above cases, allocate marks and grade learners accordingly.</li> </ul>	<p>activities and the lesson assessment questions.</p> <ul style="list-style-type: none"> <li>• Measure extent of skills acquisition through observing learners as they perform various activities.</li> <li>• Gauge attitude change and values acquisition by asking learners about their opinions on various issues affecting the society and through body language as they perform various tasks.</li> <li>• In all the above cases, allocate marks and grade learners accordingly.</li> </ul>
--	--	---	---	---



	<b>Unit 9</b>	<b>Unit 10</b>	<b>Unit 11</b>	<b>Unit 12</b>
<b>Unit title</b>	Plant reproduction	Sustainable waste management	Circulatory system	Respiratory system
<b>Number of periods</b>	10	10	8	8
<b>Key Unit Competence</b>	After studying this unit, learners should be able to describe the parts of a flower and explain the process of sexual and asexual reproduction in plants.	After studying this unit, learners should be able to apply garbage collection techniques and separate hazardous, organic and recyclable waste.	After studying this unit, learners should be able to describe and explain the functioning of the circulatory system, its hygiene and maintenance.	After studying this unit, the learner should be able to explain the mechanism of respiration.
<b>Number of Lessons</b>	5	3	8	5
<b>Equipment / Learning / Teaching materials required</b>	<ul style="list-style-type: none"> <li>• Various flowers seeds and parts of plants like leaves, stems and roots.</li> <li>• Scalpel, razorblade, hand lens, hoe, machete, strings, etc.</li> </ul>	<ul style="list-style-type: none"> <li>• Computers connected to the Internet.</li> <li>• Textbooks, pamphlets, handouts and charts on waste management.</li> </ul>	<ul style="list-style-type: none"> <li>• Charts on parts of the human circulatory system, textbooks, pamphlets and hand outs on circulatory system.</li> </ul>	<ul style="list-style-type: none"> <li>• Rabbit or mouse and dissecting kit.</li> <li>• Charts on parts of the human respiratory system, textbooks, pamphlets and hand outs.</li> </ul>

			<ul style="list-style-type: none"> <li>Video link: <a href="https://www.youtube.com/watch?v=hwAATsMBBA&amp;t=128s">https://www.youtube.com/watch?v=hwAATsMBBA&amp;t=128s</a></li> </ul>
			<ul style="list-style-type: none"> <li>Video link: <a href="https://www.youtube.com/watch?v=_qmNCJxpsr0">https://www.youtube.com/watch?v=_qmNCJxpsr0</a></li> </ul>
		<ul style="list-style-type: none"> <li>Guided discussion</li> <li>Research</li> <li>Guided discovery</li> <li>Questions and answers</li> </ul>	<ul style="list-style-type: none"> <li>Guide discovery</li> <li>Question and answer</li> <li>Research Activity</li> <li>Discussion</li> <li>Demonstration (dissection)</li> </ul>
<b>Activities / Techniques</b>	<ul style="list-style-type: none"> <li>Individual research work and group discussions.</li> <li>Question and answer sessions</li> <li>Teacher demonstrations</li> <li>Guided discovery</li> <li>Project work</li> </ul>		<ul style="list-style-type: none"> <li>Guide discovery</li> <li>Question and answer</li> <li>Research Activity</li> <li>Discussion</li> <li>Demonstration (dissection)</li> </ul>
<b>Generic Competences Practiced</b>	<ul style="list-style-type: none"> <li>Co-operation and interpersonal management and life skills</li> <li>Research skills</li> </ul>	<ul style="list-style-type: none"> <li>Co-operation and interpersonal management and life skills</li> <li>Research skills</li> </ul>	<ul style="list-style-type: none"> <li>Co-operation and interpersonal management and life skills</li> <li>Research skills</li> </ul>

	<ul style="list-style-type: none"> <li>• Communication in English</li> <li>• Critical thinking and problem solving skills</li> </ul>	<ul style="list-style-type: none"> <li>• Communication in English</li> <li>• Critical thinking and problem solving skills</li> <li>• Lifelong skills</li> <li>• Creativity and innovation</li> </ul>	<ul style="list-style-type: none"> <li>• Communication in English</li> <li>• Critical thinking and problem solving skills</li> <li>• Lifelong skills</li> </ul>	<ul style="list-style-type: none"> <li>• Communication in English</li> <li>• Critical thinking and problem solving skills</li> <li>• Lifelong skills</li> </ul>
<b>Cross-cutting issues addressed</b>	<ul style="list-style-type: none"> <li>• Gender education</li> <li>• Environment, climate change and sustainability</li> <li>• Financial education</li> <li>• Inclusive learning</li> </ul>	<ul style="list-style-type: none"> <li>• Gender education</li> <li>• Peace and values education:</li> <li>• Financial education</li> <li>• Standardization culture</li> <li>• Inclusive learning</li> <li>• Environment, climate change and sustainability</li> </ul>	<ul style="list-style-type: none"> <li>• Gender education</li> <li>• Peace and values education:</li> <li>• Financial education</li> <li>• Standardization culture</li> <li>• Inclusive learning</li> </ul>	<ul style="list-style-type: none"> <li>• Gender education</li> <li>• Financial education</li> <li>• Standardization culture</li> <li>• Inclusive learning</li> </ul>

<p><b>Assessment Strategies of key unit competence</b></p>	<p>Assess achievement of the key unit competence using:</p> <ul style="list-style-type: none"> <li>• Gauge learner understanding of concepts using the self-test exercises, unit tests, remedial &amp; extended activities and the lesson assessment questions.</li> <li>• Measure extent of skills acquisition through observing learners as they perform various activities.</li> <li>• Gauge attitude change and values acquisition by asking learners about their opinions on various issues affecting the society and through</li> </ul>	<p>Assess achievement of the key unit competency using:</p> <ul style="list-style-type: none"> <li>• Gauge learner understanding of concepts using the self-test exercises, unit tests, remedial &amp; extended activities and the lesson assessment questions.</li> <li>• Measure extent of skills acquisition through observing learners as they perform various activities.</li> </ul>	<p>Assess achievement of the key unit competency using:</p> <ul style="list-style-type: none"> <li>• Gauge learner understanding of concepts using the self-test exercises, unit tests, remedial &amp; extended activities and the lesson assessment questions.</li> <li>• Measure extent of skills acquisition through observing learners as they perform various activities.</li> </ul>	<p>Assess achievement of the key unit competence using:</p> <ul style="list-style-type: none"> <li>• Gauge learner understanding of concepts using the self-test exercises, unit tests, remedial &amp; extended activities and the lesson assessment questions.</li> <li>• Measure extent of skills acquisition by asking learners about their opinions on</li> </ul>
--	---	---	---	---

	<p>body language as they perform various tasks. In all the above cases, allocate marks and grade learners accordingly.</p>	<ul style="list-style-type: none"> <li>• Gauge attitude change and values acquisition by asking learners about their opinions on various issues affecting the society and through body language as they perform various tasks.</li> <li>• In all the above cases, allocate marks and grade learners accordingly.</li> </ul>	<ul style="list-style-type: none"> <li>• Gauge attitude change and values acquisition by asking learners about their opinions on various issues affecting the society and through body language as they perform various tasks.</li> <li>• In all the above cases, allocate marks and grade learners accordingly.</li> </ul>	<p>various issues affecting the society and through body language as they perform various tasks.</p> <ul style="list-style-type: none"> <li>• In all the above cases, allocate marks and grade learners accordingly.</li> </ul>
--	--	---	---	---

	<b>Unit 13</b>	<b>Unit 14</b>	<b>Unit 15</b>	<b>Unit 16</b>
<b>Unit title</b>	Reproductive system	Energy management	Magnetism	States of matter
<b>Number of periods</b>	14	12	8	10
<b>Key Unit Competence</b>	After studying this unit, the learners should be able to explain the function of male and female genital organs, the prevention, transmission and treatment of STIs and HIV and AIDS and state ways of preventing unplanned pregnancy.	After studying this unit, learners should be able to understand the use of energy and its transformations from one form to another.	After studying this unit, learners should be able to explain and demonstrate the existence of magnetic forces and magnetic field.	After studying this unit the learner should be able to demonstrate and explain changes of state of matter.
<b>Number of Lessons</b>	10	6	6	5

<p><b>Equipment / Learning / Teaching materials required</b></p>	<ul style="list-style-type: none"> <li>• Electric heater, matches and match boxes, kerosene/charcoal stove, sources of fuels such as firewood, charcoal, kerosene, etc; pen or comb, pieces of paper, file, iron bar, rubber bands, etc.</li> <li>• Textbooks, handouts and pamphlets on forms of energy</li> <li>• Computers connected to the Internet.</li> </ul>	<ul style="list-style-type: none"> <li>• Computers connected to the Internet.</li> <li>• Textbooks, pamphlets, handouts and charts on waste management</li> </ul>	<ul style="list-style-type: none"> <li>• Bar magnets, pins, paper clips rubber, pencils or pieces of wood, coin, string, etc.</li> <li>• Charts, textbooks, handouts and other materials on magnetism.</li> <li>• Computers connected to the internet</li> </ul>	<ul style="list-style-type: none"> <li>• Items for use during practicals such as balloons, stick, Eureka can, measuring cylinder, stone, bottle of water, among others</li> <li>• Computers connected to the internet</li> </ul>
<p><b>Activities / Techniques</b></p>	<ul style="list-style-type: none"> <li>• Individual research work and group discussions.</li> <li>• Question and answer sessions</li> <li>• Teacher demonstrations</li> <li>• Guided discovery</li> </ul>	<ul style="list-style-type: none"> <li>• Guided discussion</li> <li>• Research Activity</li> <li>• Guided discovery</li> <li>• Questions and answers</li> </ul>	<ul style="list-style-type: none"> <li>• Case studies</li> <li>• Guided discovery</li> <li>• Observation</li> <li>• Practical work</li> <li>• Group discussions</li> <li>• Pair work</li> <li>• Question and answer</li> <li>• Demonstrations</li> </ul>	<ul style="list-style-type: none"> <li>• Guide discovery</li> <li>• Question and answer</li> <li>• Research Activity</li> <li>• Teacher demonstration</li> </ul>

<b>Generic Competences Practiced</b>	<ul style="list-style-type: none"> <li>• Comprehensive sexuality education</li> <li>• Co-operation and interpersonal management and life skills</li> <li>• Research skills</li> <li>• Communication in English</li> <li>• Critical thinking and problem solving skills</li> </ul>	<ul style="list-style-type: none"> <li>• Co-operation and interpersonal management and life skills</li> <li>• Research skills</li> <li>• Communication in English</li> <li>• Critical thinking and problem solving skills</li> <li>• Lifelong skills</li> <li>• Creativity and innovation</li> </ul>	<ul style="list-style-type: none"> <li>• Co-operation and interpersonal management and life skills</li> <li>• Research skills</li> <li>• Communication in English</li> <li>• Critical thinking and problem solving skills</li> <li>• Lifelong skills</li> </ul>	<ul style="list-style-type: none"> <li>• Co-operation and interpersonal management and life skills</li> <li>• Research skills</li> <li>• Communication in English</li> <li>• Critical thinking and problem solving skills</li> <li>• Lifelong skills</li> </ul>
<b>Cross-cutting issues to be addressed</b>	<ul style="list-style-type: none"> <li>• Gender education</li> <li>• Environment, climate change and sustainability</li> </ul>	<ul style="list-style-type: none"> <li>• Gender education</li> <li>• Peace and values education.</li> </ul>	<ul style="list-style-type: none"> <li>• Environment, climate change and sustainability</li> <li>• Gender education</li> </ul>	<ul style="list-style-type: none"> <li>• Gender education</li> <li>• Financial education</li> </ul>



	<ul style="list-style-type: none"> <li>Financial education</li> <li>Inclusive learning</li> </ul>	<ul style="list-style-type: none"> <li>Financial education</li> <li>Standardization culture</li> <li>Inclusive learning</li> <li>Environment, climate change and sustainability</li> </ul>	<ul style="list-style-type: none"> <li>Peace and values education.</li> <li>Financial education</li> <li>Standardization culture</li> <li>Inclusive learning</li> </ul>	<ul style="list-style-type: none"> <li>Standardization culture</li> <li>Inclusive learning</li> </ul>
<b>Assessment Strategies of key unit competence</b>	<p>Assess achievement of the key unit competency using:</p> <ul style="list-style-type: none"> <li>Gauge learner understanding of concepts using the self-test exercises, unit tests, remedial &amp; extended activities and the lesson assessment questions.</li> <li>Measure extent of skills acquisition through observing learners as they perform various activities.</li> </ul>	<p>Assess achievement of the key unit competency using:</p> <ul style="list-style-type: none"> <li>Gauge learner understanding of concepts using the self-test exercises, unit tests, remedial &amp; extended activities and the lesson assessment questions.</li> </ul>	<p>Assess achievement of the key unit competency using:</p> <ul style="list-style-type: none"> <li>Gauge learner understanding of concepts using the self-test exercises, unit tests, remedial &amp; extended activities and the lesson assessment questions.</li> </ul>	<p>Assess achievement of the key unit competency using:</p> <ul style="list-style-type: none"> <li>Gauge learner understanding of concepts using the self-test exercises, unit tests, remedial &amp; extended activities and the lesson assessment questions.</li> </ul>

	<ul style="list-style-type: none"> <li>Gauge attitude change and values acquisition by asking learners about their opinions on various issues affecting the society and through body language as they perform various tasks.</li> </ul> <p>In all the above cases, allocate marks and grade learners accordingly.</p>	<ul style="list-style-type: none"> <li>Measure extent of skills acquisition through observing learners as they perform various activities.</li> <li>Gauge attitude change and values acquisition by asking learners about their opinions on various issues affecting the society and through body language as they perform various tasks.</li> </ul> <ul style="list-style-type: none"> <li>In all the above cases, allocate marks and grade learners accordingly.</li> </ul>	<ul style="list-style-type: none"> <li>Measure extent of skills acquisition through observing learners as they perform various activities.</li> <li>Gauge attitude change and values acquisition by asking learners about their opinions on various issues affecting the society and through body language as they perform various tasks.</li> </ul> <ul style="list-style-type: none"> <li>In all the above cases, allocate marks and grade learners accordingly.</li> </ul>	<ul style="list-style-type: none"> <li>Measure extent of skills acquisition through observing learners as they perform various activities.</li> <li>Gauge attitude change and values acquisition by asking learners about their opinions on various issues affecting the society and through body language as they perform various tasks.</li> </ul> <ul style="list-style-type: none"> <li>In all the above cases, allocate marks and grade learners accordingly.</li> </ul>
--	---	---	---	---

### 3.1 Important sub-headings of a Lesson plan

The most important document when planning to teach is the lesson plan.

A lesson plan is a detailed outline of how the teacher intends to carry out a specific lesson.

Some important subheadings in a lesson plan are given below.

#### (a) Administrative details

These include: Term.....  
Date..... Subject.....  
Class..... Duration.....  
Class size.....

#### b) Special Educational needs

A list of types of special educational needs to be catered for during the lesson and the number of learners in each category.

#### (c) Unit title

This refers to the broad area that is to be studied – taken from the syllabus.

#### (d) Key unit competence

This is/are the competence(s) that the learner is expected to achieve at the end of the unit.

#### (e) Title of the lesson

This is the lesson title extracted from the learning objective(s).

#### (f) Instructional objectives

This represents what the teacher anticipates pupils to achieve by the end of the lesson. A good instructional objective have five element, that is conditions, who, action/

behaviour, content and standard or criteria for acceptable performance.

#### (g) Plan for the class

This refers to location of the lesson i.e where the lesson will be taught.

#### (h) Learning materials/teaching resources

These refer to any materials and apparatus that the pupils and the teacher will use during the lesson.

#### (i) References

These are resources consulted or used by the teacher to prepare the lesson as well as any books that the pupils will use during the lesson.

#### (j) Description of the teaching and learning activities

These are divided into two: teacher activities and learner activities. They describe what the teacher and the learner should do during the teaching/learning process. Further, the teacher should be cognizant of the fact that the various generic competences and the cross cutting issues should be brought out during the teaching/learning activities. Highlight these as the activities are on-going.

#### (k) Timing for each step

This section is divided into three:

- Introduction to the lesson
- Lesson development
- Conclusion of the lesson

*(i) Introduction of the lesson*

This is the beginning of the lesson. It is allocated 10 minutes in a double lesson. The teacher should motivate the pupils by creating problem situations that interest pupils e.g. posing a question, telling an amusing but relevant story or episode, showing an object, picture or video that arouse their interest. The introduction should also if possible link what the pupils have already learnt with what they are going to learn.

*(ii) Lesson development*

This is the main part of the lesson. It is allocated 50 minutes in a double lesson. Lesson development should mainly include the activities that pupils and the teacher will perform in order to achieve the stated objectives; as well as the genetic

competence and the cross-cutting issues to be addressed. It is more convenient to distinguish between the pupils' and teacher's activities under two columns as shown in the lesson plan below.

*(iii) Conclusion of the lesson*

This is the step in which the lesson activities are tied up or consolidated to emphasise the main points i.e summarize the lesson. It is followed by assessing whether the learning objectives have been met. It is allocated the last 20 minutes of the lesson; 10 minutes for summary and 10 minutes for assessment.

*(iv) Teacher self-evaluation*

Here, the teacher states what went well or wrong with the delivery of the lesson and gives what he/she plans to do moving forward.

## 3.2 Sample lesson plan

School Name: Fawe Primary School

Teacher's name: Angela Iribagiza

Term	Date	Subject	Class	Unit N°	Lesson N°	Duration	Class size
I	30 /4/17	Science	P6	1	1 of 6	80 minutes	35
<b>Type of Special Educational Needs to be catered for in this lesson and number of learners in each category</b>				<ul style="list-style-type: none"> <li>• Learners with low vision (2)</li> <li>• Learners with hearing problems (3)</li> <li>• Learners with language difficulties (4)</li> <li>• Intellectually challenged learners (5)</li> <li>• Bright learners (3)</li> </ul>			
<b>Unit title</b>		Mechanics and blacksmith tools					
<b>Key Unit Competence:</b>		To be able to use and maintain mechanics and blacksmith tools safely.					
<b>Title of the lesson</b>		Common mechanics tools and their uses.					
<b>Instructional Objective</b>		Through a garage visit to observe mechanics at work and by practising using mechanics tools such as spanners, pliers, screw drivers, mechanics hammer among others and further, by watching the video through the video link provided, learners should accurately discover the role of various mechanics tools and the role mechanics play in the society and properly use and maintain the tools.					
<b>Plan for this Class (location: in / outside)</b>		<ul style="list-style-type: none"> <li>• Individual research work on who a mechanic is.</li> <li>• Academic trip to a garage to witness use of mechanics tools.</li> <li>• Group work (group size should depend on the number of learners in the class and their abilities).</li> <li>• Watching a video in class.</li> </ul>					
<b>Learning Materials (for ALL learners)</b>		<ul style="list-style-type: none"> <li>• Common mechanics tools such as spanner, pliers, screw driver, hack saw, mechanics hammer, etc.</li> <li>• Charts showing mechanics tools and their uses</li> <li>• Videos on mechanics tools and their uses or video link: <a href="https://www.youtube.com/watch?v=NF9dQt74O3g">https://www.youtube.com/watch?v=NF9dQt74O3g</a></li> <li>• VCDs or DVDs and player and TV Screen ( For showing the video)</li> <li>• Computers connected to the internet</li> <li>• Projector (for projecting the video)</li> </ul>					
<b>References</b>		Pupil's book for Science Elementary Technology and ICT for Primary 6, computer with internet connection and any other relevant reference textbook.					

Timing for each step	Description of teaching and learning activity		Generic competences and cross cutting issues to be addressed plus a short explanation
	Teacher activities	Learner activities	
<b>Introduction (10 minutes)</b>	<p>Learners observe mechanics at work and watch the video and discover the various mechanics tools and their uses as the teacher guides them.</p> <p>Asks learners to study the picture on page 1 of their books and to state what is going on.</p> <p>Asks learners to suggest a solution to the problem situation in the picture.</p>	<p>Study the picture and states what is happening which is:  <i>The picture shows a public service vehicle with a flat tyre. The driver is trying to replace the tyre but he cannot do it. The passengers inside the vehicle are complaining of getting late. The driver is stranded as he is not a mechanic. He is using a wrong tool (hammer) to remove the wheel.</i></p> <p>Gives a solution to the problem situation as - the driver should be trained on the basics of mechanics and mechanics tools and their uses.</p>	<p><b>a) Generic competences</b></p> <p><b>1. Critical thinking and problem solving skills</b>  This competence will be developed as learners study the picture and give solutions to the problem situation.</p> <p><b>2. Co-operation and interpersonal management and life skills</b>  This competence will be developed as learners freely participate in the discussions regarding the problem situation.</p> <p><b>b) Cross-cutting issues</b></p> <p><b>1. Peace and values education</b>  As learners discuss why the driver has to accommodate the passenger views.</p> <p><b>2. Standardisation culture</b>  The problem situation may have come about as a result of counterfeit tyre. Stress the need to always buy original products.</p>

<b>Development of the lesson (50 minutes)</b>	Guides learners to carry out research on who a mechanic is and the tools he/she uses and asks them to write a report.	Carry out research and writes a report. Sample report A mechanic is a person who repairs, assembles, maintains or fixes spoilt vehicles. He/she uses tools such as pliers, hammer, spanner, screw driver, hack saw and screw jack. Mechanics work in a garage where they name a special room for storing their tools. They are important in our society because they help to repair spoilt and worn out vehicles and make us able to use them safely again.	<b>a) Generic competences</b> <b>1. Co-operation and interpersonal management and life skills</b> As learners engage one another during group discussions. <b>2. Research skills</b> As learners find out the meaning of the word mechanic and the various mechanics tools and their uses. <b>3. Communication in official language</b> As learners do presentations in English and as they share during group discussions. <b>4. Lifelong skills</b> By practicing using mechanics tools, learners gain pre-requisite skills that will come in handy in their lives if they were to become mechanics.
	Takes learners to a nearby garage to observe mechanics at work. They should note down how each tool is being used and draw it in their notebooks.	Visits a nearby garage, observes mechanics at work and note down the tools the mechanics are using and their uses.	<b>b) Cross-cutting issues</b> <b>1. Environment, climate change and sustainability</b> The oils and other chemicals that come from machines when not disposed of well, cause pollution. Caution learners against disposing of these wastes anyhow. <b>2. Gender education</b> Emphasize to learners the fact that both men as well as women can earn a living by becoming either a mechanic. <b>3. Peace and values education</b> Caution learners against using tools as weapons to hurt others. <b>4. Standardization culture</b> Warn learners against use of counterfeit materials and products. <b>5. Inclusive learning</b> Allow all learners to participate equally irrespective of their gender, physical disability or mental challenges.
	Shows learners a video of mechanics at work.	Practice using the various mechanics tools.	
	Assists learners to form groups depending on the class size and ability of learners.	Watch the video, listen and comment about the video.  Form groups according to teacher instructions	
	Asks learners to discuss, write a report and present what they saw during the garage visit or in the video.	Discuss and write a report and does a presentation to the rest of the class.	

<p><b>Conclusion:</b> <b>(20 minutes)</b></p> <p><b>a) Summary</b></p>	<p>Asks a volunteer to come and summarise what they have learnt in this lesson.</p>	<p>Listens to the fellow learner and takes short notes.</p> <p><b>Summary notes</b> <i>A mechanic is a person who assembles, repairs or fixes vehicles. He or she uses tools such as spanner, pliers, screw driver among others to repair the vehicle. Common mechanics tools and their uses are given in the table below.</i></p> <table border="1" data-bbox="599 533 908 825"> <thead> <tr> <th>Tool</th> <th>Use</th> </tr> </thead> <tbody> <tr> <td>Spanner</td> <td>Fastening nuts and bolts</td> </tr> <tr> <td>Hack saw</td> <td>Cutting metals</td> </tr> <tr> <td>screw driver</td> <td>Driving screws</td> </tr> <tr> <td>Screw jack</td> <td>Lifting vehicles</td> </tr> <tr> <td>Pliers</td> <td>Holding objects</td> </tr> </tbody> </table>	Tool	Use	Spanner	Fastening nuts and bolts	Hack saw	Cutting metals	screw driver	Driving screws	Screw jack	Lifting vehicles	Pliers	Holding objects	<p><b>a) Generic competences</b></p> <p><b>1. Communication in official language</b> As the volunteer learner does presentation in English to the rest of the class.</p> <p><b>2. Peace and values education</b> Emphasise to learners the importance of accommodating other people's views. They should not overly criticise the presenter even if he/she makes mistakes.</p> <p><b>b) Cross-cutting issues</b></p> <p><b>1. Inclusive learning</b> Any learner should be chosen to do the presentation irrespective of their abilities.</p> <p><b>2. Gender education</b> Both boys and girls should be given equal opportunity to present to the rest of the class</p>
Tool	Use														
Spanner	Fastening nuts and bolts														
Hack saw	Cutting metals														
screw driver	Driving screws														
Screw jack	Lifting vehicles														
Pliers	Holding objects														
<p><b>b) Assessment</b></p>	<p>Recaps by highlighting the main points on who a mechanic is and the tools they use and correcting the learner who volunteered. (Refer to pupils book pages 2-7 for the facts).</p> <p>Gives oral questions to assess achievement of lesson objectives. The questions may include:</p> <p><b>Sample questions:</b></p> <ol style="list-style-type: none"> <li>Who are mechanics?</li> <li>Which tools do mechanics use?</li> <li>What role do mechanics play in our lives?</li> </ol>	<p>Listens to the teacher and corrects the wrong notes taken during fellow learner presentation</p> <p>Learners answer oral questions:</p> <p><b>Answers to sample question</b></p> <ol style="list-style-type: none"> <li>People who repair/assemble/fix spoilt vehicles.</li> <li>Spanners, hammer, pliers, screw driver, etc.</li> <li>They repair broken down vehicles making transportation from one place to another possible.</li> </ol>													



<b>Teacher self-evaluation</b>	Some learners had problems using the mechanics tools. Further garage visits will be arranged for them to improve on their skills of using the tools.
--------------------------------	--

### 3.3 Conclusion

This teacher's book has been written to help you guide pupils to learn science in the most enjoyable and captivating manner. You are reminded to always arouse the curiosity of learners as you teach. Some things that you may do before you go for a lesson include:

- Go through the expected learning outcomes – this should help guide the manner of teaching.
- Read through the unit for the lesson in advance to get an overview of the content required.
- Form a mental picture of the teaching situation and the ways in

which you will interact with pupils when dealing with the suggested activities.

- Collect the materials that will be needed during the lesson in advance.
- In some cases, try out the suggested activities/experiments in advance to avoid embarrassments like the experiment failing to work during the lesson.

**Remember:** The suggested teaching activities in this book are just a guide. You may not need to follow them to the letter! Feel free to incorporate other innovative teaching methods that will help in delivering the intended content optimally.

*Refer to Learner's Book pages 1-18*

### Key Unit Competency

After studying this unit, learners should be able to use and maintain mechanics and blacksmiths tools safely.

### Learning objectives

Competency based curriculum embraces three categories of learning objectives, that is, knowledge and understanding,

skills acquisition and attitude and values. At the end of the unit, learners should have knowledge and understanding of mechanics and blacksmith tools and have the right attitude towards applications and use of mechanics and blacksmith tools.

**Table 1.1: Knowledge, skills and values to be attained**

Knowledge and understanding	Skills	Attitudes and values
<p>By the end of this unit, the learner should be able to:</p> <ul style="list-style-type: none"> <li><input type="checkbox"/> Identify and explain the use of mechanics and black smith tools.</li> <li><input type="checkbox"/> Explain the maintenance of both mechanics and blacksmith tools.</li> </ul>	<p>By the end of this unit, the learner should be able to:</p> <ul style="list-style-type: none"> <li><input type="checkbox"/> Find out every least detail in observing mechanics and blacksmith tools.</li> <li><input type="checkbox"/> Match mechanics and blacksmith tools with their respective uses.</li> </ul>	<p>By the end of this unit, the learner should be able to:</p> <ul style="list-style-type: none"> <li><input type="checkbox"/> Show concern for the importance of blacksmith tools.</li> <li><input type="checkbox"/> Show responsibility and caring for the safety of him and her and others.</li> </ul>

<ul style="list-style-type: none"> <li><input type="checkbox"/> Identify potential dangers of using mechanics and blacksmith tools and ways of preventing them.</li> </ul>	<ul style="list-style-type: none"> <li><input type="checkbox"/> Handle mechanics tools and blacksmith tools safely.</li> <li><input type="checkbox"/> Maintain adequately mechanics and blacksmith tools.</li> <li><input type="checkbox"/> Use of cleaning materials, tools and cleaning products safely.</li> </ul>	<ul style="list-style-type: none"> <li><input type="checkbox"/> Develop positive attitudes towards the environment, mechanics and blacksmith tools production.</li> <li><input type="checkbox"/> Use mechanics and blacksmith tools safely.</li> </ul>
--	---	--

### Pre-requisite of the unit

This unit is about mechanics and blacksmiths tools. Remember that learners at this level have already interacted with tools before. For example, in Primary 4, they learnt about agricultural tools, their safe use and maintenance. While in Primary 5, they learnt about carpentry and masonry tools. Take advantage of this and link what they learn here with their past experiences about these tools.

Further, inform learners that the concepts in this unit can be applied in woodwork and metalwork. Let learners understand that when they continue and further their education in this area, they may become mechanical or civil engineers.

### Background information

In the history of Rwandans, there have been blacksmiths known locally as (**abacuzi**) meaning that they fabricate

different tools. For example, abacuzis were known to make hunting and agricultural tools like hoes, spears, arrows and many others.

In Rwanda now there are many machines and vehicles, such machines need repair and maintenance time and again. The mechanics are important people as well. They do works such as assembling, repairing and maintaining machines. Our children should be made to like such activities by being taken to such places like garages to observe and practice these activities.

Most of the tools used by mechanics and blacksmith have sharp edges therefore they have to be handled with care. Tools that have sharp edges or those that are pointed should not be carelessly handled that is, they should not be thrown anyhow and should not be used for playing with friends. Further, emphasize the fact that while

in a workshop or garage, workers or any other workshop visitor or user should wear protective clothes.

### **Cross-cutting issues**

#### **1. Environment, climate change and sustainability**

The oils and other chemicals that come from machines when not disposed of well cause pollution. By causing pollution our environment gets spoilt. This may bring problems. Caution the learners against disposing of these wastes anyhow.

#### **2. Gender education**

Emphasize to learners the fact that both men as well as women can earn a living by becoming either a mechanic or blacksmith. Both are not a preserve of men or women only.

#### **3. Peace and values education**

Caution learners against using tools as weapons to hurt others, people should live in peace and harmony in order to develop. Inform them that they should be willing all the time to accommodate views of others. Also in case a child gets hurt accidentally others should provide first aid before taking him or her to the hospital.

#### **4. Financial education**

Let the learners understand that well maintained tools last for long thereby reducing maintenance and replacement costs. Also, not buying

counterfeits helps in saving money as the tools last for long. Further, stress the fact that when learners grow up, they can earn a living from being mechanics and/or blacksmiths.

#### **5. Standardization culture**

Warn learners against use of counterfeit materials and products and encourage them to always buy and use original products/tools.

#### **6. Inclusive learning**

During practical activities, allow all learners to participate equally irrespective of their gender, physical disability or mental challenges. Also during pairing, bright learners should be mixed with slow learners.

### **Generic competences to be addressed**

#### **1. Co-operation and interpersonal management and life skills**

During group discussions and pair works, let learners engage one another by giving a chance for all to participate. Also, during group presentations, you can allow rotational presentations within the group members. Gifted learners should help in coming up with write-ups of presentation content as slow learners contribute. REMEMBER you should allow slow learners to do presentations as well and correct them where they go wrong. Advise learners to appreciate the different

abilities of their group members and accommodate each other's views.

## 2. **Research skills**

Guide learners on how to find information regarding various topics such as the meaning of the word 'mechanic' and 'blacksmith'. Guide learners on how to come up with summarized notes from a large body of text. You should also guide learners on how to do Internet searches for the various content areas they are looking for.

## 3. **Communication in English**

Communication in English will be improved when learners freely participate in the discussions and presentations. Encourage all learners irrespective of their abilities to participate in group discussions, during presentations by asking questions and during question and answer sessions to either introduce or wrap up the lessons.

## 4. **Critical thinking and problem solving skills**

This competence will be developed by learners as they answer the probing questions such as those on page 1 at the beginning of this unit and as they discuss the results of the various practical activities. Guide learners to discover for themselves

the various uses of tools and the maintenance practices on them. This competence will also come about as learners think about their findings in the activities and as they give out their suggestions on why this is the case.

## 5. **Lifelong skills**

By practicing using mechanics and blacksmith tools and maintaining them, learners gain pre-requisite skills that will come in handy in their lives if they were to become blacksmiths or mechanics.. Also, make learners aware that they can become mechanics or blacksmiths and earn a living from that.

## 6. **Creativity and innovation - As learners think of ways of using blacksmith and mechanics tools to create innovative products.**

### **Key words in this unit and their meanings**

- **Assembling** – To fit together separate parts of a machine.
- **Blacksmith** – A person who makes various objects by heating then shaping iron metal or its alloys.
- **Burns and scalds** – A burn is damage to the skin caused by dry heat such as hot metals or fire, while a scald is damage to the skin caused by wet heat such as hot water or steam.

- **Garage** – Building or house where vehicles are serviced or repaired.
- **Mechanic** – A worker with skills in making, using or repairing machines, vehicles and tools.
- **Repair** – To restore something that is damaged, faulty or worn out in order to restore its good working condition.
- **Rust** – Reddish or yellowish-brown coating that forms on iron or steel metals in the presence of moisture.
- **Tool box** – A box or container used for keeping tools safely.
- **Tools** – These are implements especially ones held in the hands and are used to carry out

particular functions.

- **Workshop** – A room or building in which goods are made or repaired.

### Guidance on the problem statement

This topic is about mechanics and blacksmith tools, their uses and maintenance. As a way of introducing the concepts, refer learners to the picture on page 1 of pupil's book.

It shows a passenger vehicle with a flat tyre. The driver is trying to repair it but he is stranded and does not know what to do. He is using a wrong tool (hammer) to remove the tyre. The passengers on the other hand are becoming impatient with him. Guide the learners to discover that it is important to learn mechanics as a way of getting out of such situations.

### Attention to special educational needs

Support for Multi-ability learning	Support for special needs learning
<ul style="list-style-type: none"> <li>▪ <b>Peer-teaching</b> – engage high achievers to help weak pupils in understanding of concepts.</li> <li>▪ Plan remedial teaching for slow learners.</li> <li>▪ Allow enough time to slow learners to complete their work.</li> <li>▪ Gifted learners to be given heavy tasks requiring more critical thinking while slow learners are given tasks, which they can manage such as collecting materials for use during practicals among others.</li> </ul>	<ul style="list-style-type: none"> <li>▪ Identify the learners with hearing and visual impairment and have them sit in front of the class so that proper attention can be given to them. Also, large print texts should be given to visually impaired learners and hearing aids provided for those with hearing impairment.</li> <li>▪ Arrange the room such that it will enable easy movement for the physically challenged learners.</li> </ul>

<ul style="list-style-type: none"> <li>▪ Both gifted and slow learners to be given equal opportunity to lead in group discussions and to do presentations of group findings to the rest of the class.</li> <li>▪ Ensure all learners respect other's views irrespective of their shortcomings or talents.</li> </ul>	<ul style="list-style-type: none"> <li>▪ Assign some students to be in charge of the physically and visually impaired learners. For example, carrying their equipment, showing them around during the field trips, etc.</li> <li>▪ Organize Braille for blind learners.</li> <li>▪ Encourage special needs learners by reminding them that 'disability is not inability'!</li> </ul>
--	--

### List of lessons

Lesson No.	Lesson title	No. of Periods
1.	Identification and use of mechanics tools	1
2.	Storage and maintenance of mechanics tools	1
3.	Dangers and precautions when using mechanics tools	1
4.	Identification and use of blacksmith tools	1
5.	Storage and maintenance of blacksmith tools	1
6.	Dangers of blacksmith tools and their prevention	1

#### Lesson 1: Identification of mechanics tools and their uses (Period 1)

Refer to learner's book pages 2-5

#### Specific objectives

By the end of the lesson, learners should be able to use mechanics tools safely.

#### Preparation for the lesson

- Collect mechanics materials and tools available in the area to show learners.

- Obtain permission to visit nearby garage from the owners.
- Ensure the internet is working for research purposes.
- Search for a video link of mechanics at work in a garage in Rwanda. Use the link: [www.youtube.com/watch?V=nFtbf4prm78](http://www.youtube.com/watch?V=nFtbf4prm78)

#### Teaching aids

- Common mechanics tools such as spanner, pliers, screw driver, hack saw, etc

- Photographs showing mechanics tools and their uses.
- Videos on mechanics tools and their uses.
- VCD or DVD player.

### Improvisation

Draw charts of common mechanics tools on manila papers to be in case you do not have charts on the mechanics tools.

### Pre-requisite of the lesson

Introduce the unit as explained under guidance on the problem statement then narrow down to this lesson.

### Teaching / learning activities

#### Find out (Refer to Pupil's book page 1)

- Allow learners to carry out research in groups on who a mechanic is and his/her role in the society. Let them write a report on their findings and share with the rest of the class.

#### Activity 1.1 (Refer to Pupil's book page 2)

- Next, lead the learners to visit a mechanics workshop or garage

nearby. When in the garage, the learners should identify the various mechanics tools and practice using them.

- Let learners ask probing questions such as:
  - *Who is a mechanic?*
  - *What do mechanics use to do their work?*
  - *What do we call places where mechanics work from?*
- Let learners observe how the various tools are being used. They can come up with a table like this:

Name	Tool (Drawing)	Use

- Let them practice using the different tools. Let one of the mechanics at the workshop guide them. You should be in hand to guide them too in order to reduce chances of injuries. In case there is no garage nearby, show learners a video on mechanics at work. Let them watch the video carefully and list down the various tools



being used and their uses.

### **Synthesis**

The lesson introduces learners to the mechanics tools and mechanics activities in daily life. The practical activities carried out during the lesson should help learners develop skills on safe use of mechanics tools.

Wind up the lesson by inviting one learner to give a summary of the lesson.

Highlight common mechanics tools and their uses as learners write short notes.

Take the opportunity to emphasise the fact that concepts learnt in this lesson are crucial in mechanical engineering as a career. Further, motivate all learners irrespective of gender to develop interest in mechanics, as it is not a preserve of a particular gender.

### **Lesson assessment**

Assess whether the learning objectives of the lesson were met by:

- (a) Giving learners a task of using mechanics tools and assessing how they use the tools.
- (b) Ask learners to answer these questions:

1. Who are mechanics?

*(Ans: Mechanics are trained people who repair or mend machines that have broken down).*

2. What is the importance of mechanics in our society?

*(Ans: Mechanics repair or give service to machines that have broken down, mechanics save our money to avoid buying new machines all the times).*

3. What are the main tools used by mechanics?

*(Ans: Mechanics commonly use spanners, pliers, hammers, screw drivers, metal saws, drills and many others).*

4. Suppose we didn't have mechanics, what would happen?

*(Ans: Life would be very difficult because machines need servicing periodically. Secondly, machines wear out when working due to friction, therefore the worn out parts need replacements. Also, a vehicle or any other machine can break down any time, then without mechanics life would be very difficult because we cannot afford to have new machines all the time).*

## Lesson 2: Maintenance and storage of mechanics tools

Refer to learner's book page 6-7

### Lesson objective

By the end of the lesson, learners should be able to store mechanics tools properly and practice maintaining them.

### Preparation for the lesson

- Obtain things such as grease, oil and sand paper used to maintain tools.
- Borrow a tool box to show learners how to mechanics tools.
- Seek permission from a nearby garage for an academic visit.
- Ensure the internet is working for research purposes.

### Teaching aids

- Common mechanics tools such as spanner, pliers, screw driver, hack saw, etc
- Tool box
- Grease and oil
- Sand paper

- Photographs showing mechanics tools and their maintenance

### Pre-requisite of the lesson

You may introduce the lesson by reminding learners what they learnt in the previous lesson. Ask them to name some mechanics tools that they know.

### Synthesis

This lesson introduces learners to maintenance of mechanics tools and their safe storage. The activities carried out during the lesson should give learners enough practices on how to maintain mechanics tools. It should also motivate learners to develop a habit of keeping tools safely and not misusing them. Further, learners should be motivated to maintain any valuable tools that they use in their daily lives. Correct learners as is appropriate and guide them to come up with short notes on safe storage and maintenance of tools.

### Lesson assessment

Assess whether the learning objectives of the lesson were met by:

(a) Giving learners a task on:

1. Safe storage

2. Maintenance of mechanics tools.

(b) Ask learners to answer these questions:

1. Mention different methods used to maintain mechanics tools?

*Ans: The tools can be maintained by oiling, greasing and cleaning and wiping.*

2. What would happen to tools if they were not properly maintained?

*Ans: If the tools are not properly maintained, they rust and get damaged.*

### **Lesson 3: Dangers and precautions when using mechanic tools**

*Refer to learner's book pages 8*

#### **Lesson objective**

By the end of the lesson learners should be able to use mechanic tools safely.

#### **Preparation for the lesson**

- Borrow a tool box to show learners how to keep tools safely.
- Seek permission from a nearby garage for an academic visit.

- Ensure the internet is working for research purposes.
- Obtain protective clothing for classroom demonstration.
- Obtain a first aid kit.

#### **Teaching aids**

- Tool box
- Protective clothing such as gloves, mouth masks, goggles, overall, etc
- First aid kit.

#### **Improvisation**

- Learners can tie a piece of cloth around nose and mouth to avoid dust or metal particles getting into the nose or mouth.

#### **Pre-requisite of the lesson**

- Introduce the lesson by reminding learners what the various types of tools are used for. They can come up with a table on the type of tool and its use.

## Teaching / learning activities

- Bring the various protective clothings in class and ask learners what they are used for. (Refer to Pupil's book page 9)
- This is a case study involving learners comparing risks mechanics encounter when they do NOT use protective clothings. Let them look at the pictures and state what is going on.
- Let the learners recall the visit they made to the mechanics workshop/ garage in Activity 1.1. Let them say what they observed the mechanics putting on and why.
- You can then demonstrate the importance of protective clothing by carrying out an activity with and without the protective clothing on.
- Summarise the lesson by highlighting the '**dos**' and '**don'ts**' while in a mechanic workshop. Some of them are:
  - Do not play with mechanics tools.
  - Avoid monkey plays while in a workshop.
  - Do not eat while in a workshop.
- Work to do (Refer to pupils book page 9)
- Wrap up by giving learners the exercise on "work to do" on page 9 of pupil's book.

## Synthesis

This lesson intends to caution learners about dangers and precautions when

using mechanics tools. You should use the case study and the demonstration activity to show learners the importance of wearing protective clothing while working in a garage. Emphasize the fact that prevention is better than cure therefore; learners should always take precautions in their daily lives.

## Lesson assessment

Assess whether the learning objectives of the lesson were met by:

- (a) Asking learners to use mechanics tools. Assess whether they are using them safely.
- (b) Ask learners to answer these questions:

1. Mention different dangers that we face while working in a mechanics workshop?

*Answer: These include:*

- *Being hit by a moving object.*
- *Cuts or burns on our skin while using the tools.*
- *Dangerous chemicals getting into our eyes, nose or mouth.*

2. What should happen in the garage to safe guard the lives of people working in the garage?

*(Ans: Such measures include:)*

- *Getting protective gear for every one working in the garage like overalls,*

*goggles, boots, helmets and others.*

- Using the tools carefully to avoid injury.
- Dispose of dangerous chemicals safely so they cannot affect the lives of people.

#### **Lesson 4: Identification and use of common blacksmith tools**

Refer to learner's book pages 10-12

#### **Specific objectives**

By the end of the lesson, learners should be able to identify, name and explain uses of blacksmith tools.

#### **Preparation for the lesson**

- Collect blacksmith materials and tools available in the area to show learners.
- Obtain permission to visit nearby blacksmith workshop from the owners.
- Ensure the internet is working for research purposes.
- Ensure that the video link: <https://www.youtube.com/watch?v=ZToka1-80QA> or any other link of your choice is working.

#### **Teaching aids**

- Common blacksmith tools such as hammer, anvil, bellows, pincers, tong, etc.
- Photographs showing blacksmith tools and their uses.

- Videos on blacksmith tools and their uses.
- VCD or DVD player.

#### **Improvisation**

Draw charts of common blacksmith tools on manila papers for use in case you do not have charts on the same.

#### **Pre-requisite of the lesson**

- Let learners know that in this lesson, they will learn about blacksmith tools and their uses.
- Guide them in understanding the role of a blacksmith in the society.

#### **Teaching / learning activities**

##### **Find out (Refer to Pupil's book page 10)**

- Allow learners to carry out the research in groups on who a blacksmith is and his/her role in the society. Let them write a report on their findings and share with the rest of the class.
- At this point, you can clarify who a blacksmith is and his/her role in the society.

##### **Activity 1.7 & 1.8 (Refer to Pupil's book pages 10- 12)**

- Next, lead the learners to visit a blacksmith workshop nearby. While in the workshop, the learners should identify the various blacksmith tools and practice using them.
- Let learners ask probing questions such as:

- (i) Who is a blacksmith?
- (ii) What is the importance of blacksmiths in our society?
- (iii) What do blacksmiths use to do their work?
- (iv) What do we call places where blacksmiths work from?

- Let the learners observe how the various tools are being used. They can come up with a table like this:

Name	Tool (Drawing)	Use

- Let them practice using the different tools. Let one of the blacksmiths at the workshop guide them. You should be at hand to guide them too in order to reduce chances of injuries.

### Activity 1.7 (Refer to Pupil's book page 10)

- If there is no blacksmith workshop nearby, show learners a video on blacksmiths at work. You may use the site: <https://www.youtube.com/watch?v=ZToka1-80QA>. or any other of your choice Let them watch the video carefully and down the various tools being used and their uses.

- Wind up the lesson by inviting one learner to give a summary of the lesson then highlight common blacksmith tools and their uses as learners take short notes.

### Synthesis

The lesson introduces learners to the blacksmith tools and blacksmiths activities in daily life. The practical activities carried out during the lesson should help learners skills on safe use of blacksmith tools. Take the opportunity to emphasise the fact that concepts learnt in this lesson are crucial in blacksmiths career. Further, motivate all learners irrespective of gender to develop interest in blacksmiths, as it is not a preserve of a particular gender.

### Lesson assessment

Assess whether the learning objectives of the lesson were met by:

- (a) Giving learners a task on using blacksmith tools and assessing how they use the tools.
- (b) Ask learners to answer these questions:
  1. Who are blacksmiths?  
(Ans: Blacksmiths are people who make or fabricate tools from hitting hot metals).
  2. What is the importance of blacksmiths in our society?

*(Ans: They make important tools that we use in Agriculture and in our homes).*

3. What are the main tools used by blacksmiths?

*(Ans: Blacksmith commonly use anvils, bellows, borerer and hammers).*

4. Suppose we didn't have blacksmiths, what would happen?

*(Ans: Life would be very difficult because blacksmiths make tools that we locally use in our daily lives which are cheap and not commonly available elsewhere).*

### **Lesson 5: Maintenance and storage of blacksmith tools**

Refer to learner's book pages 14

#### **Lesson objective**

By the end of the lesson, learners should be able to store blacksmith tools properly and practice maintaining them.

#### **Preparation for the lesson**

- Obtain things such as grease, oil and sand paper used to maintain tools.
- Borrow a tool box to show learners how to keep tools.
- Seek permission from a nearby blacksmiths for an academic visit.
- Ensure the internet is working for

research purposes.

#### **Teaching aids**

- Common blacksmith tools such as anvil, bellows, pincers, tongs, etc
- Tool box
- Grease
- Oil
- Sand paper
- Photographs showing blacksmith tools and their maintenance.

#### **Pre-requisite of the lesson**

You may introduce the lesson by reminding learners what they learnt in the previous lesson about common blacksmith tools. Ask them to name some blacksmith tools that they know.

#### **Teaching / learning activities**

##### **Activity 1.9 (Refer to Pupil's book page 14)**

- This is an activity involving learners comparing a situation where an hammer or machete is left outside overnight and the other is stored safely in the house. Let them observe the two tools and compare what has happened and why.

*Ans: The hammer / machete left outside develops*

*rust while the other one is NOT affected. This is because the hammer /machete left outside had water on it which made it possible for rusting to occur.*

- Let the learners recall the visit they made to the blacksmiths workshop in Activity 1.7. Let them say the methods they observed being used to maintain the tools.
- Demonstrate how to maintain some of the tools. Give the learners a task to practice maintenance of practices on tools.
- Guide the learners to form groups and answer the following questions:
  - (i) *Which of the tools should be maintained by oiling or greasing?*
  - (ii) *Name the tools that are supposed to be wiped and kept in a dry place.*
  - (iii) *Which of the tools are supposed to be sharpened, wiped and kept in a dry place?*
  - (iv) *Why do you think that we are not supposed to throw or drop the tools?*
- Wind up by highlighting the main points as learners write short notes. Refer to pupil's book page 14.

## **Synthesis**

This lesson introduces learners to maintenance of the blacksmith tools and their safe storage. The activities carried out during the lesson should help learners identify the importance of maintaining blacksmith tools and any other tools that we use in our society. It should also motivate the learners to develop a habit of keeping tools safely and not misusing them. Further, learners should be motivated to maintain any valuable tools that they use in their daily lives.

## **Lesson assessment**

Assess whether the learning objectives of the lesson were met by:

- (a) Giving learners a task on:
  1. Safe storage
  2. Maintenance of blacksmith tools.
- (b) Ask learners to answer these questions:
  1. What will happen to blacksmith tools when they are left to stay outside at night?

*Ans: The tools will develop rust, and hence get destroyed).*
  2. What various methods are used to maintain blacksmith tools?



(Ans: Such methods include wiping and keeping them in a dry place, oiling or greasing them and keeping the skin of the bellows moist).

### **Lesson 6: Dangers and precautions when using blacksmith tools**

Refer to learner's book pages 15

#### **Lesson objective**

By the end of the lesson learners should be able to use blacksmith tools safely.

#### **Preparation for the lesson**

- Borrow a tool box to show learners how to keep tools safely.
- Seek permission from a nearby blacksmith workshop for an academic visit.
- Ensure the internet is working for research purposes.
- Obtain protective clothing for class demonstration.
- Obtain a first aid kit.

#### **Teaching aids**

- Tool box
- Protective clothing such as gloves, mouth masks, goggles, overall, etc.
- First aid kit

#### **Improvisation**

- Advise learners to cover their mouth and nose using a clean piece of cloth to avoid dust and metal particles getting into their nose.

#### **Pre-requisite of the lesson**

- Introduce the lesson by reminding learners what the various types of blacksmith tools are used for. They can come up with a table on the type of tool and its use.
- Learners can then brainstorm on what they think are the dangers associated with the tools above. Let them come up with a list in their notebooks.

#### **Teaching / learning activities**

- Bring the various protective clothings in class and ask learners what they are used for.
- summarise the lesson by highlighting the 'dos' and 'don'ts' while in a blacksmith workshop. Some of them are:

(i) *Do not play with blacksmith tools.*

(ii) *Avoid monkey plays while in the workshop.*

(iii) *Do not eat while in the workshop.*

- Work to do (Refer to pupils book page 16)

- Wrap up by giving learners the 'work to do' on page 14 of pupil's book as home work. They should write down their findings and bring to you for evaluation.

### Synthesis

This lesson intends to caution learners about dangers and precautions when using blacksmith tools. You should use the case study and the demonstration activity to show learners the importance of wearing protective clothing while working in a blacksmith workshop. Emphasize the fact that prevention is better than cure therefore; learners should always take precautions in their daily lives.

### Lesson assessment

Assess whether the learning objectives of the lesson were met by:

- (a) Giving learners a task on:
1. Safe storage
  2. Maintenance of blacksmith tools.
- (a) Ask learners to answer these questions:
- (i) Mention different dangers that we face while working in a blacksmith workshop?

*(Ans: These include:*

- (i) Being hit by a moving object.*
- (ii) Cuts or burns on our skin while using the tools.*

- (iii) Dangerous chemicals getting into our eyes, nose or mouth.*
- (ii) What should happen in a blacksmith workshop to safeguard the lives of people working in the workshop?

*Ans: Such measures include:*

- (i) Getting protective gear for every one working in the garage like overalls, goggles, boots, helmets and others.*
- (ii) Using the tools carefully to avoid injury.*
- (iii) Dispose of dangerous chemicals safely so they cannot affect the lives of people.*

### Answers to Self-Test 1.1 (Pupil's book Page 10)

1. If there were no mechanics to repair or fix the broken down machines, life would be very difficult because everything that is used need maintenance and repair.
2. (a) Spanner and screw jack  
(b) Spanners  
(c) Natural
3. (a) Bench vice  
(b) A drill  
(c) Wheel spanner
4. The dangers that we face in a mechanics workshop include:
  - Being hit by a moving object.

- Cuts or burns on our skin while using the tools
  - Dangerous chemicals getting into our eyes, nose or mouth.
5. Mechanics protective clothes include: overalls, gloves, boots and helmets.

**Answers to Self-Test 1.2 (Pupil's book Page 16)**

1. Blacksmiths hammer, bellows, anvil, pincers or tongs and the borerer.
2. Blacksmiths are important in the following ways:
  - They help to make agricultural tools that help people in farming.
  - They help to recycle some metals into usable tools, such metals would be useless.
  - Blacksmith help to make cheap utensils that we use in our families.
  - Blacksmith help to fabricate weapons and hunting tools like spears, allows etc
3. We use, rat traps, billhooks, machetes, knives.
4. We wear goggles when dealing with blacksmith activities for protection against dangerous objects that can get into our eyes, also seeing in fire directly with our eyes may destroy our eye lenses.

**Summary of the unit**

This unit deals with mechanics and blacksmith tools, their uses and the

various maintenance practices carried out on them. You therefore should effectively use the practical activities, demonstrations and the suggested teaching approaches in the teacher's book to guide learners acquire the requisite knowledge and desired competences in these areas.

At the end of the lessons, you should assess the extent to which the competencies have been achieved and attitude change towards responsible use of tools and their maintenance. Plan remedial activities where necessary for slow learners and give extra activities for gifted ones as well. Also, emphasize the fact that taking this unit seriously may lead to careers such as mechanical or civil engineering.

**Additional information for the teacher**

**Types of mechanics tools**

There are quite a number of mechanics tools. What is covered at this level are the most basic tools. In fact, every area of specialisation in mechanics has its own set of tools. For example we have

- Engine specialists tools.
- Autobody repair tools.
- Diagnostic tools.
- Lifting equipments and jacks.
- Tyre repair tools.

Details of these tools will be covered by learners when they specialise or take a course in Mechanics.

## Blacksmith techniques

Learners already have an idea of the tools blacksmiths use. However, they have no idea about the techniques blacksmiths use.

Here are some:

- **Drawing** - this refers to hammering a piece of metal to make it longer and thinner.
- **Tapering** - this is making the end of an iron metal pointed.
- **Bending** - this refers to bending a metal in a particular way to serve a particular purpose.
- **Upsetting** - this means pounding the end of an iron metal onto itself to make it thinner; thereby increasing its cross-section.
- **Spreading** - this refers to hammering iron bar to make it wider and thinner.
- **Punching** - this is the act of creating a hole in a piece of iron metal. A tool called punch with pointed end is used.
- **Slitting** - this refers to creating a slit in a piece of a metal.
- **Twisting** - this is meant to create aesthetic value. The iron bar is twisted when still hot to make it look attractive.

### Answers to the Unit Test 1 (Pupil's book Page 17)

1. (a) Mechanics repair, assemble and maintain machines also mechanics help to repair broken down tools and

machines, this may make life less expensive.

- (b) Blacksmith hit hot metals to give them desired shapes thus making tools that we use in agriculture for farming and other utensils that we use at home. Blacksmiths make traps that are used to control pests like rats, monkeys and mice. They also make tools such as hoes, billhooks, scatters that are used in farming.

2.

Tools	Use
Bellows	Blowing air into the fire
Drill	Making holes into metals
Bench vice	Holding metals when being cut
Spanner	Fastening and loosening nuts
Blacksmith hammer	Hitting metals to them desired shapes

3. Mutoni should be advised not to undermine any type of job as all jobs act as sources of income for families and the society as whole.
4. To avoid dangers like accidents and pollution that can affect their health.
5. The mechanic in the picture is not putting on protective clothing which puts him at a risk of getting

7. Ensure that each learner brings the tools and exercises maintenance practices on them such as keeping them safely, cleaning, oiling/greasing moving parts

### Additional activities to cater for intellectually challenged and gifted learners

Remedial activities for intellectually challenged learners	Extended activities for gifted and talented learners
<ol style="list-style-type: none"> <li>1. Cleaning mechanic or blacksmith tools after use.</li> <li>2. Drawing blacksmith or mechanics tools on manila paper then hanging on classroom wall.</li> <li>3. Playing a game of naming mechanics/blacksmith tools.</li> </ol>	<ol style="list-style-type: none"> <li>1. Making blacksmith items such as hoes, knives, cooking pans, etc.</li> <li>2. Coming up with innovative ways of decorating the tools above.</li> <li>3. Doing research on other types of tools other than blacksmiths and mechanics and writing a report.</li> <li>4. Coming up with a poem on dangers of misuse of tools and how to use tools safely.</li> </ol>
Remedial questions for intellectually challenged learners	Extended questions for gifted and talented learners
<ol style="list-style-type: none"> <li>1. A blacksmith uses _____ to soften metals.</li> <li>2. Some mechanics tools that I know are _____, _____ and _____.</li> <li>3. Which blacksmith tools do you know?</li> <li>4. We should _____ all tools after use.</li> <li>5. Who is a mechanic?</li> </ol>	<ol style="list-style-type: none"> <li>1. Given a chance between a mechanic and a blacksmith, which one would you become? Why?</li> <li>2. Explain how mechanics interfere with the environment.</li> <li>3. Discuss the advantages of blacksmiths in the society.</li> </ol>

Answers to remedial questions	Answers to extended questions
<ol style="list-style-type: none"> <li>1. Fire</li> <li>2. Spanner, screw driver, pliers, hack saw, bench vice, etc.</li> <li>3. Hammer, anvil, bellow, pincers, tongs, etc.</li> <li>4. Wash</li> <li>5. Somebody who repairs or maintains tools/machines.</li> </ol>	<ol style="list-style-type: none"> <li>1. The answer can be either of the two. Assess reasons given by the learner to see if the advantages/benefits of each are well captured. Some include: Blacksmiths produce hand tools that are useful in Agriculture, for domestic use, etc. Mechanics is well paying, is a service that humanity cannot do without due to breakdown nature of machines, etc.</li> <li>2. Oil and grease from garages pollute the environment. Also, if not recycled, vehicle parts are an eyesore to the environment in general.</li> <li>3. Produce hand tools that are useful in Agriculture, for domestic use, etc. They also help in recycling metals which would cause environmental pollution.</li> </ol>

**UNIT**  
**2**

**Simple machines**  
(No. of periods: 12)

*Refer to Learner's Book pages 19 - 35*

**Key Unit Competency**

After studying this unit, learners should be able to classify simple machines and levers.

**Learning objectives**

Competency based curriculum embraces three categories of learning objectives,

that is, knowledge and understanding, skills acquisition and attitude and values. At the end of the unit, learners should have knowledge and understanding of simple machines and levers and have the right attitude towards applications and use of simple machines and levers.

**Table 2.1: Knowledge, skills and values to be attained**

<b>Knowledge and understanding</b>	<b>Skills</b>	<b>Attitudes and values</b>
<p>By the end of this unit, learners should be able to:</p> <ul style="list-style-type: none"> <li><input type="checkbox"/> Define simple machines.</li> <li><input type="checkbox"/> Identify different types of simple machines.</li> <li><input type="checkbox"/> Outline different classes of levers.</li> <li><input type="checkbox"/> Categorise simple machines according to their classes.</li> <li><input type="checkbox"/> Explain the potential dangers of using simple machines and how to prevent them.</li> </ul>	<p>By the end of this unit, learners should be able to:</p> <ul style="list-style-type: none"> <li><input type="checkbox"/> Draw and label the different simple machines.</li> <li><input type="checkbox"/> Make patterns of simple machines and levers based on their characteristics.</li> <li><input type="checkbox"/> Safe handling of simple machines and levers.</li> <li><input type="checkbox"/> Communicate and use appropriate terminology related to simple machines.</li> </ul>	<p>By the end of this unit, learners should be able to:</p> <ul style="list-style-type: none"> <li><input type="checkbox"/> Show curiosity on the use of simple machines and their importance.</li> <li><input type="checkbox"/> Be aware of possible dangers of using simple machines.</li> <li><input type="checkbox"/> Display sense of responsibility when using simple machines.</li> <li><input type="checkbox"/> Appreciate the usage of simple machines as a way to simplify the daily work.</li> </ul>

## Pre-requisites of this unit

The content in this unit is about types of simple machines, their categories and safety precautions to take while using simple machines. It may help to remind learners what they learnt in previous unit on mechanics and blacksmith tools. Also, remind them about what they learnt under agricultural, carpentry and masonry tools in Primary 4 and 5. Let them understand that these are tools majority of which are examples of simple machines. It may also help to differentiate between these simple machines and complex or heavy machinery used in agriculture and industry.

Finally let learners understand the fact that concepts learnt in this unit concept in this unit can be applied in physics and other areas such as woodwork and metalwork. Let learners know that when they continue and further their education in this area, they may become mechanical or civil engineers.

### Background information

Simple machines are devices that can make a tough job easier by enabling a person to apply less force or to apply force in the direction that is easier to manipulate. Each machine affects the direction or the amount of effort needed

to do work. Most mechanical machines such as automobiles or power tools are made up of hundreds of parts. However, no matter how complex a machine is it is composed of some combination of the six simple machines. In this unit, you will teach about simple machines and the various classes of levers.

### Cross cutting issues

#### 1. Environment, climate change and sustainability

Most of the simple machines can be made by cutting down trees; learners should be cautioned not to practice deforestation. Also the oils and other chemicals that come from machines when not disposed of well, cause pollution. By causing pollution our environment gets spoilt. This may bring problems. Caution the learners against disposing of these wastes anyhow.

#### 2. Gender education

Inform learners that both men as well as women can earn a living by making and using simple machines.

#### 3. Peace and values education

Make learners aware that simple machines should not be used to hurt others. People should live in peace and harmony in order to develop. Inform them that they should be willing all the time to accommodate views of others. Also in case a child gets hurt accidentally others should provide first aid before taking him or her to the hospital.



#### 4. Financial education

When we make and use our local simple machines, our work becomes easy and cheap. Encourage learners to develop a habit of making their own simple machines where possible. Also, let the learners understand that, well maintained tools last for long hence reduces costs of replacement. Also, let learners know that when they grow up, they can earn a living from making and fabricating simple machines.

#### 5. Standardization culture

Warn learners against using counterfeit materials as this may lead to frequent breakdowns which end up being very costly. Also encourage learners to always buy and use original products/tools.

#### 6. Inclusive learning

Allow all learners to participate during activities irrespective of their gender, physical disability or mental challenges. Also during pairing, bright learners should be mixed with slow learners.

### Generic competences to be covered

#### 1. Co-operation and interpersonal management and life skills

During group discussions and pair works - let learners engage one another by giving a chance for all to participate. Also, during group presentations you can allow

rotational presentations within the group members. Gifted learners should help in coming up with write-ups of presentation content as slow learners contribute.

**REMEMBER:** You should allow slow learners to do presentations as well and correct them where they go wrong. Advise learners to appreciate the different abilities of their group members and accommodate each other's views.

#### 2. Research skills

Guide learners on how to find information regarding various topics such as the meaning of lever among others. Guide learners on how to come up with summarized notes from a large body of text. You should also guide learners on how to do Internet searches for the various content areas they are looking for.

#### 3. Communication in English

Communication in English will be improved when learners freely participate in the discussions and presentations. Encourage all learners irrespective of their abilities to participate in group discussions, during presentations by asking questions and during question and answer sessions to either introduce or wrap up the lessons.

#### 4. Critical thinking and problem solving skills

This competence will be developed by learners as they answer the probing questions such as those on

page 19 at the beginning of this unit and as they discuss the results of the various practical activities. Guide learners to discover for themselves the various uses of tools and the maintenance practices on them. This competence will also come about as learners think about their findings in the activities and as they give out their suggestions on why this is the case.

### 5. Lifelong skills

By practicing using various simple machines and tools and maintaining them, learners gain pre-requisite skills that will come in handy in their lives. Also, make learners aware that they can become mechanical engineers and earn a living from that.

### 6. Creativity and innovation

Encourage learners to come up with innovative ways and make simple machines for use at home. For example, they can use bearing and pieces of wood to make a home made wheelbarrow, etc.

### Key words in this unit and their meanings

- **Baseball bat** – a smooth wooden or metal club used in the sport of baseball to hit the ball after it is thrown by the pitcher.
- **Device** – A machine or tool that does a special job.
- **Groove** – A long, narrow cut or depression in a hard material.

- **Lever** – A simple machine with effort, load and fulcrum used to make work easier.
- **Machine** – A system or device for doing work.
- **Meandering** – A road that is not straight i.e. with many corners.
- **Prick** – making a small hole or holes in the surface of something or body.
- **Ramp** – Is a sloping surface between two places that are at different levels.
- **Scoop** – to pick up and move something with using a spade.
- **Steep** – this is a sharply angled, rising or falling ground level or object.
- **Steering wheel** – this is a wheel used by a driver, pilot when he or she wishes to change direction.
- **Stiff** – something that can't be easily bent.
- **Tennis racket** – a bat with a long handle attached to a round frame with a network of tight strings over it; used to hit the ball in tennis.
- **Tweezers** – these are small tools used for picking up objects too small to be handled by human hands.

### Guidance on the problem statement

This topic is about simple machines and types of levers and their uses. As a

way of introducing the concepts, refer learners to the diagram on page 17 of their book. The picture shows many workers doing tiresome work at a construction site. The job can however be done more easily using simple machines yet the people are doing it

manually due to ignorance. Guide the learners to discover and suggest some of the simple machines that can be used there instead. They should compare situations when simple machines are used and when they are not used and make conclusions on which is better.

### Attention to special educational needs

Support for Multi-ability learning	Support for special needs learning
<ul style="list-style-type: none"> <li>▪ <b>Peer-teaching</b> – engage high achievers to help weak pupils in understanding of concepts.</li> <li>▪ Plan remedial teaching for slow learners.</li> <li>▪ Allow enough time to slow learners to complete their work.</li> <li>▪ Gifted learners to be given heavy tasks requiring more critical thinking while slow learners are given tasks, which they can manage such as collecting materials for use during practicals among others.</li> <li>▪ Both gifted and slow learners to be given equal opportunity to lead in group discussions and to do presentations of group findings to the rest of the class.</li> <li>▪ Ensure all learners respect other’s views irrespective of their shortcomings or talents.</li> </ul>	<ul style="list-style-type: none"> <li>▪ Identify the learners with hearing and visual impairment and have them sit in front of the class so that proper attention can be given to them. Also, large print texts should be given to visually impaired learners and hearing aids provided for those with hearing impairment.</li> <li>▪ Arrange the room such that it will enable easy movement for the physically challenged learners.</li> <li>▪ Assign some students to be in charge of the physically and visually impaired learners. For example, carrying their equipment, showing them around during the field trips, etc. Organize Braille for blind learners.</li> <li>▪ Encourage special needs learners by reminding them that ‘disability is not inability’!</li> </ul>

## List of lessons

Lesson No.	Lesson title	No. of Periods
1.	Meaning of simple machine	2
2.	Types of simple machines	3
3.	introduction to Levers	4
4.	Safety in using simple machines	2

### Lesson 1: Meaning of a simple machine

Refer to learner's book page 20

#### Specific objectives

By the end of the lesson, learners should be able to define simple machine.

#### Preparation for the lesson

- Prepare the lesson by organizing the objects you may need for the practical activities. The items include a closed bottle, a pulley, spade, wheelbarrow, hammer, etc.
- Ensure the internet is working for research purposes.

#### Teaching aids

- Common simple machines such as saw, hammer, bottle opener, wheelbarrow, pulleys, etc
- Photographs or charts showing simple machines.

#### Pre-requisite of the lesson

Introduce the unit as explained under guidance on the problem statement above then narrow down to this lesson.

#### Teaching / learning activities

##### Activity 2.1 (Refer to Pupil's book page 20)

- By now, learners have a rough idea of what simple machines are from the demonstration in introduction of the unit. Build on this and put learners in pairs. Let the learners carry out the activities in turns this case study.
- Guide them to discuss in groups how easy work becomes when someone uses a simple machine compared to using bare hands as demonstrated in the illustrations.
- Guide them to discover what a simple machine is based on their discussions which is 'anything that enables people to do work easily and with little effort'.

- With your guidance let the learners identify the simple machines they use in their daily lives.

(Ans: They include: A spade, a hoe, an axe, a ladder and a machette.)

## Synthesis

The lesson introduces learners to simple machines and their uses in our in daily lives. From our grandparents' generations to ours we have always used simple machines to make work easier. The practical activities carried out during the lesson should help learners identify the importance of simple machines in society in general. Take the opportunity to emphasise the fact that concepts learnt in this lesson are crucial in mechanical engineering. Further, motivate all learners irrespective of gender to develop interest in mechanics, as it is not a preserve of a particular gender.

## Lesson assessment

Assess whether the learning objectives of the lesson were met by asking questions such as:

1. What is a simple machine?  
(Ans: A simple machine is defined as a device that makes work easier and faster. Simple machines enable people to do work with less muscle effort and with greater speed.)
2. Mention at least five simple machines that are used at home.

## Lesson 2: Types of a simple machine.

Refer to learner's book page 20

## Specific objectives

By the end of the lesson, learners should be able to identify the different types of simple machines.

## Preparation for the lesson

- Obtain some simple machines such as saw, hammer, bottle opener, wheelbarrow, pulleys, etc. You can also ask learners to bring some from home.
- Seek permission from a nearby workshop for an academic visit.

## Teaching aids

- Common simple machines such as saw, hammer, bottle opener, wheelbarrow, pulleys, etc
- Photographs/ charts showing simple machines

## Pre-requisite of the lesson

- Remember, there are various types of simple machines which you will cover in this lesson in three periods. You may arrange such that you cover wheels & axles in one period,

pulleys and inclined planes in the next period and finally wedges and screws in the last period.

- You may introduce this lesson by reminding learners what they learnt in the previous lesson. Ask them to name some simple machines that they saw and their uses.

### Teaching / learning activities

#### Activity 2.2 (Refer to Pupil's book page 21)

- Guide learners to carry out this activity in groups. Give them sample simple machines above to observe. Let them try using them. They should then discuss whether they used the machines in the same way? You may also take learners for a tour of a nearby workshop to see the various machines in use.
- Build on their findings and introduce the six types of simple machines i.e. levers, wheel & axle, pulleys inclined planes, wedges and screws.
- Narrow down to each type of simple machine and demonstrate how it is used. Let learners try using the machines as well.
- You may then put learners into groups to discuss how each simple machine is used, write a report and present to the rest of the class (Talking point on page 22 of Pupil's book).

### Synthesis

This lesson introduces learners to the different types of simple machines. The activities carried out during the lesson and the workshop visit should help learners identify the various types of simple machines and their uses. It should also motivate the learners to develop curiosity in using simple machines and appreciate their importance. Wrap up this lesson by inviting one learner to summarise the lesson on behalf of the rest. Finally highlight key points as learners take summary notes.

### Lesson assessment

Assess whether the learning objectives of the lesson were met by:

- (a) Bringing a variety of simple machines in class, let learners group them either as a lever, wheel and axle, pulley, inclined plane, wedge or screw.

- (b) Ask learners to answer the following questions:

1. What is a wheel and axle?

*(Ans: The wheel and axle is a simple machine that has two wheels, a large wheel and a smaller wheel fixed together).*

2. Mention at least three simple machines that use wheel and axle principle?

*(Ans: Examples include: a door handle, a steering wheel, and a Windlass).*

3. Name the three types of pulleys.

*(Ans: Single fixed, movable and block and tackle).*

4. How would you distinguish a wedge from a screw?

(Ans: a wedge has a sharp edge, a screw has threads).

5. Give three examples of inclined planes.

(Ans: Stairs, ramp, road winding uphill).

### Lesson 3: Introduction to levers

Refer to learner's book page 21

#### Specific objective

By the end of this lesson, learners should be able to define what a lever is and give examples.

#### Preparation for the lesson

- Prepare the lesson by organising the objects you may need for the practical activities for example, crowbar, sea saw, etc.

#### Teaching aids

- Sea-saw
- Crow bar
- Two stones (one large, another small)

#### Pre-requisite of the lesson

- Introduce the lesson by reminding learners the various categories of simple machines. Ask them to list them down in their notebooks.

- Build on this and introduce the term lever.

#### Teaching / learning activities

##### Activity 2.4 (Refer to Pupil's book page 22)

- Let learners play on a see saw as directed in this activity. Let them say why one person goes down and another up.
- Guide them to assemble the crow bar and the stones as shown. Let them try using the crowbar to lift the big stone.
- At this point, you can bring out the concept of fulcrum, load and effort. Guide them to understand what each means and how they interrelate.
- Let learners answer questions 4 in this activity. You can then guide them into discovering what a lever is and show them the Figure 2.2 on page 23. Let them draw it in their exercise books and label the various parts.

#### Synthesis

The lesson introduces learners to the concept of levers and the parts that make up a lever. The practical activities carried out during the lesson should help learners appreciate what a lever is and its various parts. Take

the opportunity to emphasize the fact that concepts learnt in this lesson are crucial in engineering as well.

Further, motivate all learners irrespective of gender to develop interest in levers, as it is not a preserve of a particular gender.

### Lesson assessment

Assess whether the learning objectives of the lesson were met by asking questions such as:

1. What is a lever?

*(Ans: A lever is a rigid bar which balances on a fixed point called a **pivot (Fulcrum)**, the force applied to the lever is called **effort**, the resistance to which the force is applied is called the **load**).*

2. Draw and label parts of a lever.

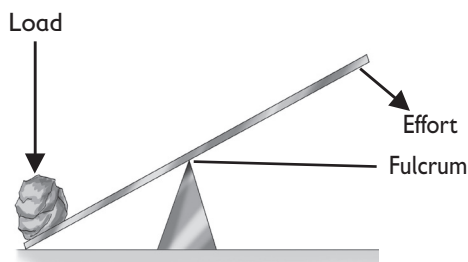

## Classes of levers

Refer to learner's book page 23

### Specific objectives

By the end of the lesson, learners should be able to categorise simple machines according to classes of levers.

### Preparation for the lesson

- Obtain some simple machines such as crowbar, hammer, bottle opener, wheelbarrow, fishing rod, scissors, pliers, etc. You can also ask learners to bring some from home.

### Teaching aids

- Common simple machines such as crowbar, hammer, bottle opener, wheelbarrow, fishing rod, scissors, pliers, etc.
- Photographs or charts showing various levers and their parts.

### Pre-requisite of the lesson

- Remember, there are various types of levers which you will cover in this lesson in three periods. You may arrange such that you cover first class levers in the first period, second class levers in the next period and finally third class levers in the last period.



## Teaching / learning activities

- You may introduce this lesson by reminding learners what they learnt in the previous lesson. Ask them to draw parts of a lever in their exercise books.

## Activity 2.5 (Refer to Pupil's book pages 23 - 24)

- Guide learners to carry out this activity in pairs. Give them a hammer, a tin opener and a spade. Let them try using them. They should then discuss the questions after the activities.
- Guide them to draw a diagram indicating the positions of effort, fulcrum and the load.
- Build on their diagrams and introduce the concept of the classes of lever i.e. first class, second class and third class levers.
- Narrow down to each class and demonstrate how using the various machines. Let learners try using the machines as well.
- You should then guide learners into discovering which class of lever the machine belongs to. Let learners find out other examples of machines in that class.
- Wrap up this lesson by bringing the simple machines to class and learners practising using them and grouping them.

- Highlight key points as learners take summary notes. Refer to pupil's book pages 24-27.

## Synthesis

This lesson introduces learners to the different classes of levers. The activities carried out during the lessons and the case study should help learners identify the various types of simple machines and their uses. It should also motivate the learners to develop curiosity in using simple machines and appreciate their importance. Wind up this content area by letting learners collect a variety of simple machines, use them and identify positions of load, effort and fulcrum. Let them group the various machines based on their findings.

## Lesson assessment

Assess whether the learning objectives of the lesson were met by:

- (a) Giving learners the simple machines above and letting them use them to put them in various groups.
- (b) Asking learners to answer the following questions:
  1. How would you determine whether a machine belongs to first, second or third class?

*(Ans: By determining the position of fulcrum, effort or load. In the first class levers, the fulcrum is between the load and effort. In second class levers, the load is between the effort and the fulcrum and in third class levers, the*

effort is between the fulcrum and the load).

2. Give the examples of levers in

**(a) First class**

(Ans: Examples include a claw hammer, tin opener, scissors, pincers, a see saw, pliers, beam balance, crow bar, shears).

**(b) Second class**

(Ans: Examples in this class include; a paper cutter, a nut cracker, a wheel barrow and a bottle opener.

**(c) Third class**

(Ans: Examples in this class include a tennis racket, fishing rod, baseball bat, the human arm, a broom, tweezers, a spade).

**Answers to Self-Test 2.1 (Pupil's book Page 32 )**

1. A lever is a rigid bar which balances on a fixed point called a **pivot** (fulcrum), the force applied to the lever is called **effort** and the resistance to which the force is applied is called the **load**.
2. X – EFFORT  
Y – LOAD  
Z – FULCRUM

3. (a) When the fulcrum is in between the load and the effort.  
(b) When the load is in between the fulcrum and the effort.  
(c) When the effort is in between the fulcrum and the load.
4. Inclined plane

**Summary of the unit**

This unit deals with simple machines and levers and the various classes of levers. You therefore should effectively use the practical activities, demonstrations and the suggested teaching approaches in the teacher's book to guide learners acquire the requisite knowledge and desired competences in these areas. At the end of the lessons, you should assess the extent to which the competencies have been achieved and attitude change towards responsible use of simple machines and their maintenance. Plan remedial activities where necessary for slow learners and give extra activities for gifted ones as well. Also, emphasize the fact that taking this unit seriously may lead to careers such as mechanical engineering.

**Additional information for the teacher**

Throughout history, human beings have developed a number of devices

that help them make-work easier. The notable of these are known as the “six simple machines” which are the wheel and axle, the lever, the pulley, the screw and the wedge. Most simple machines work under the principle of mechanical advantage.

Archimedes discovered the principle of mechanical advantage (MA) which is given by the formula:

$$\text{MA} = \text{Force(out)} / \text{Force(in)}$$

It is therefore a ratio of the force produced by a machine to the force applied to it.

Simple machines are devices that can make a tough job easier by enabling a person to apply less force or to apply force in the direction that is easier to manipulate. Each machine affects the direction or the amount of effort needed to do work.

Most mechanical machines such as automobiles or power tools are made up of hundreds of parts. However, no matter how complex a machine is it is composed of some combination of the six simple machines above.

## Lesson 4 : Safety in the use of simple machines

Refer to learner's book page 31

### Specific objective

By the end of this lesson, learners should be to explain the potential dangers of using simple machines and avoid them.

### Preparation for the lesson

- Seek permission from a nearby workshop for an academic visit.
- Ensure the internet is working for research purposes.
- Obtain protective clothing for class demonstration.
- Obtain a first aid kit.

### Teaching aids

- Protective clothing such as gloves, mouth masks, goggles, overall, etc.
- First aid kit.

### Improvisation

- Ask learners to use a clean piece of cloth to cover mouth and nose when using simple machines.

### Pre-requisite of the lesson

- Introduce the lesson by reminding learners the various types of simple machines and their uses. They can come up with a table on the same.

- Learners can then brainstorm on what they think are the dangers associated with the machines above. Let them come up with a list in their notebooks.
- Summarise the lesson by highlighting the **do's** and **dont's** while handling simple machines. Some of them are:
  - (i) Do not play with machines
  - (ii) Avoid monkey plays while in a workshop
  - (iii) Do not eat while using simple machines, etc.

### Synthesis

This lesson intends to caution learners about dangers and precautions to take when using simple tools. You should use the discussion activity and the workshop visit to demonstrate the dangers and measures to take when using simple tools. Emphasise the fact that prevention is better than cure therefore; learners should always take precautions in their daily lives.

### Lesson assessment

Assess whether the learning objectives of the lesson were met by:

- (a) Giving a task to learners of using simple machines. Observe as they use to ascertain that appropriate precautions are being taken during use:
- (b) Ask learners to answer the following questions:

1. Explain how simple machines can be harmful to us.

*(Ans: Some of the simple machines like wedges have sharp edges which can cut and damage the skin).*

2. How can we prevent ourselves from accidents caused by simple machines?

*(Ans: Wear protective clothings like gloves, goggles, aprons and gumboots).*

### Answers to Unit Test 2 (Pupil's book Page 33-35)

1. The invention of simple machines by early human beings helped us to become civilized and live a simpler life than before. People are now able to do work more easily.
2. Open bottles of soda or beer, fishing with fishing rods, opening doors, pulling water from well and moving on stairs.
3. Door handle, a steering wheel, and a windlass.
4. True
5. Wheel and axle

1st class levers	2nd class levers	3rd class levers
Pliers	Wheel barrow	Tongs
Pair of scissors	Nut cracker	Tweezers

6. Parts of the body which act as

- levers are the human arms and the legs.
7. The roads are meandering; this is to create an inclined plane on the hill so that it can be easy to go up hill. Otherwise, it would be very difficult to go up the hill if the road is to be constructed straight upwards.
  8. Screws and bolts are used to hold and join pieces of metals or wood together. Screws are also used in carjacks.
  9. Simple machines, especially those with sharp edges should be used carefully because they can cause injury and cuts to our bodies.
  10. First class
  11. (a) True                      (b) True  
(c) False                      (d) False  
(e) True
  12. D
  13. Third class lever
  14. Simple objects which we use to make work easier. They reduce force required to do the work, change direction of force and increase efficiency.
  15. Spade, hoe, wheelbarrow, hammer, saw, crowbar, etc
  16. To create an inclined plane of sorts. This helps to reduce amount of energy required to climb uphill.
  17. A lever is a rigid bar which balances on a fixed point called a pivot(fulcrum), the force applied to the lever is called effort and the resistance to which the force is applied is called the load.
  18. X – Effort  
Y – Load  
Z – Fulcrum
  19. Inclined/plane

**Additional activities to cater for intellectually challenged and gifted learners**

Remedial activities for intellectually challenged learners	Extended activities for gifted / talented learners
<ol style="list-style-type: none"> <li>1. Cleaning simple machines after use.</li> <li>2. Drawing different types of levers on manila paper then hanging on wall as a reminder.</li> <li>3. Playing a game of naming parts of a lever and identifying various simple machines and classifying them.</li> </ol>	<ol style="list-style-type: none"> <li>1. Making simple machines for use at home using locally available materials. For example, they can make a 'wheelbarrow' made of wheel bearing and wood, etc.</li> <li>2. Doing research on other types of machines and how they work.</li> <li>3. Coming up with a poem on dangers of misuse of simple machines and how to use machines safely.</li> </ol>

Remedial questions for intellectually challenged learners	Remedial questions for gifted learners
<ol style="list-style-type: none"> <li>1. A _____ makes work easier.</li> <li>2. Some examples of simple machines include _____, _____ and _____.</li> <li>3. Which are the six classes of simple machines?</li> <li>4. A lever belongs to either _____, _____ or _____ class.</li> <li>5. A windlass is an example of a _____ machine.</li> </ol>	<ol style="list-style-type: none"> <li>1. Why is it not recommended for you to open a bottle using your teeth?</li> <li>2. Compare and contrast a windlass and a satir case.</li> <li>3. What is the difference between block and tackle pulley and a movable pulley?</li> </ol>

Answers to remedial questions	Answers to extended questions
<ol style="list-style-type: none"> <li>1. Machine.</li> <li>2. Wheelbarrow, tin opener, bottle opener, nut cracker, pair of scissors, fishing rod, etc.</li> <li>3. Levers, wheel &amp; axle, pulley, screw, wedge, inclined plane.</li> <li>4. First, second or third class.</li> <li>5. Wheel and axle.</li> </ol>	<ol style="list-style-type: none"> <li>1. We may break our teeth.</li> <li>2. A windlass is an example of a wheel and axle; a stair case has steps and is an inclined plane.</li> <li>3. Movable moves; block and tackle is fixed.</li> </ol>

*Refer to Learner's Book pages 36 -49*

**Key Unit Competency**

After studying this unit you should be able to make utility objects, toys and learning materials.

**Learning objectives**

Competency based curriculum embraces three categories of learning objectives,

that is, knowledge and understanding, skills acquisition and attitude and values. At the end of the unit, learners should have knowledge and understanding of utility objects and toys and have the right attitude towards applications and use of utility objects and toys.

**Table 3.1: Knowledge, skills and values to be attained**

<b>Knowledge and understanding</b>	<b>Skills</b>	<b>Attitudes and values</b>
<p>By the end of this unit, learners should be able to:</p> <ul style="list-style-type: none"> <li><input type="checkbox"/> Explain how to make different toys, utility and learning objects.</li> <li><input type="checkbox"/> Identify the ways of maintaining utility and learning objects produced.</li> </ul>	<p>By the end of this unit, learners should be able to:</p> <ul style="list-style-type: none"> <li><input type="checkbox"/> To handle manipulate properly various materials to make toys, utility and learning objects.</li> <li><input type="checkbox"/> Use efficiently clay sticks or paper to make different tools.</li> <li><input type="checkbox"/> Maintain efficiently utility and learning objects.</li> </ul>	<p>By the end of this unit, learners should be able to:</p> <ul style="list-style-type: none"> <li><input type="checkbox"/> Show dexterity to make and safely maintain toys, utility and learning objects.</li> <li><input type="checkbox"/> Be ware of learning from mistakes - trial and error.</li> <li><input type="checkbox"/> Appreciate well made toys, utility and learning objects.</li> </ul>

## Pre-requisite for this unit

This topic is about production of toys, various utility items and learning aids. Specifically, learners will be required to model animal toys and make motorcycle toy using wires. Already, learners have an idea of how these are done given in Primary 4 they modeled a doll using clay and made a bicycle using wires. Capitalise on the knowledge and skills they acquired during these lessons to advance the acquisition of skills in this area. Also, make learners understand that the concepts in this unit are closely related to Knitting in Home Science and Pottery in Arts and crafts. Let learners understand that when they continue and further their education in this area, they may become porters or craftsmen.

### Background information

In Rwanda and other countries, children use local materials available in their area to make play objects like toys and dolls and utility objects and learning materials. In this unit, learners will use local materials to make utility and play objects.

#### Cross cutting issues

##### 1. Environment, climate change and sustainability

Bring to the attention of learners the fact that mining of clay, cutting of

trees and/or grass when looking for materials to use to make utilities may cause environmental degradation. This may bring problems like destroying the swamps which may also affect the rainfall formation and patterns.

##### 2. Gender education

Tell learners that both men as well as women can earn a living by becoming craftsmen and producing handcrafts on large scale for sale.

##### 3. Peace and values education

Caution learners against hurting each other using the tool and that they should live in harmony in order to develop. Inform them that they should be willing all the time to accommodate views of others. Also in case a child gets hurt accidentally others should provide first aid before taking him or her to the hospital.

##### 4. Financial education

Let the learners understand that, well maintained learning materials and utilities last for long hence reduce on costs. Also, when they grow up, they can earn a living from making such crafts and utilities.

##### 5. Standardization culture

Warn learners against use of counterfeit materials and encourage them to always buy and use original products/tools.



## 6. Inclusive learning

Allows all learners to participate during activities irrespective of their gender, physical disability or mental challenges. Also during pairing, bright learners should be mixed with slow learners.

### Generic competences to be covered

#### 1. Co-operation and interpersonal management and life skills

During group discussions and pair works - let learners engage one another by giving a chance for all to participate. Also, during group presentations you can allow rotational presentations within the group members. Gifted learners should help in coming up with write-ups of presentation content as slow learners contribute.

**REMEMBER** You should allow slow learners to do presentations as well and correct them where they go wrong. Advise learners to appreciate the different abilities of their group members and accommodate each other's views.

#### 2. Research skills

Guide learners on how to find information regarding various topics such as the meaning of utility objects

among others. Guide learners on how to come up with summarized notes from a large body of text. You should also guide learners on how to do Internet searches for the various content areas they are looking for.

#### 3. Communication in English

Communication in English will be improved when learners freely participate in the discussions and presentations. Encourage all learners irrespective of their abilities to participate in group discussions, during presentations by asking questions and during question and answer sessions to either introduce or wrap up the lessons.

#### 4. Critical thinking and problem solving skills

This competence will be developed by learners as they answer the probing questions such as those on page 36 at the beginning of this unit and as they discuss the results of the various practical activities. Guide learners to discover for themselves the various uses of tools and the maintenance practices on them. This competence will also come about as learners think about their findings in the activities and as they give out their suggestions on why this is the case.

## 5. Lifelong skills

By practicing making various utility objects and maintaining them, learners gain pre-requisite skills that will come in handy in their lives. Also, make learners aware that they can become porters or handcraft makers and earn a living if they take this topic seriously.

## 6. Creativity and innovation

Encourage learners to come up with innovative ways and make various utility objects and toys for use at home or even for sale. For example, they can make hats, scarfs, caps, gloves, etc.

### Key words in this unit and their meanings

- **Plasticine** – Synthetic material which is a substitute for clay used in modeling.
- **Wire** – A flexible strand or rod of metal.

- **Scarf** – A long broad strip of wool, cotton or other materials worn round the neck, shoulder or head.
- **Knitting** – This is a method of creating fabric cloth from a single strand of cloth/yarn using two needles.
- **Weaving** – weaving is a method of fabric production in which two distinct sets of threads are interlaced at right angles to form a cloth.

### Guidance on the problem statement

This topic is about making toys and utility objects. As a way of introducing the concepts, refer learners to the picture on page 36 of their book. The picture shows school children admiring expensive toys outside a toyshop. They cannot afford them! Help learners to discover that they can easily make simple affordable and good-looking toys for themselves using locally available materials.

## Attention to special needs education

Support for Multi-ability learning	Support for special needs learning
<ul style="list-style-type: none"> <li>▪ <b>Peer-teaching</b> – engage high achievers to help weak pupils in understanding of concepts.</li> <li>▪ Plan remedial teaching for slow learners.</li> <li>▪ Allow enough time to slow learners to complete their work.</li> <li>▪ Gifted learners to be given heavy tasks requiring more critical thinking while slow learners are given tasks, which they can manage such as collecting materials for use during practicals among others</li> <li>▪ Both gifted and slow learners to be given equal opportunity to lead in group discussions and to do presentations of group findings to the rest of the class.</li> <li>▪ Ensure all learners respect other's views irrespective of their shortcomings or talents.</li> </ul>	<ul style="list-style-type: none"> <li>▪ Identify the learners with hearing and visual impairment and have them sit in front of the class so that proper attention can be given to them. Also, large print texts should be given to visually impaired learners and hearing aids provided for those with hearing impairment.</li> <li>▪ Arrange the room such that it will enable easy movement for the physically challenged learners.</li> <li>▪ Assign some students to be in charge of the physically and visually impaired learners. For example, carrying their equipment, showing them around during the field trips, etc.</li> <li>▪ Organize <b>Braille</b> for blind learners.</li> <li>▪ Encourage special needs learners by reminding them that 'disability is not inability'!</li> </ul>

### List of lessons

Lesson No.	Lesson title	No. of Periods
1.	Making toys using clay	2
2.	Making toys using wires	2
3.	Making utility objects in threads	2
4.	Making learning materials in paper	1
5.	Maintenance of utility learning objects	1

## Lesson 1: Making toys using clay

Refer to learner's book page 36-39

### Specific objectives

By the end of the lesson, learners should be able to make toys such as dolls and various animals using clay.

### Preparation for the lesson

Obtain the materials to use during the lesson such as clay

### Teaching aids

- Clay or placticine
- Water

### Pre-requisite of the lesson

Introduce the unit as explained under guidance on the problem statement above then narrow down to this lesson.

### Teaching / learning activities

- You may introduce this lesson through a brainstorming session on what toys learners made in primary 4 and 5. Let them come up with a list. Build on this and let learners know that they will learn about modeling in this lesson.

### Activity 3.1 (Refer to Pupil's book page 37)

- Guide learners to form groups depending on class size and their abilities. Let them carry out the activity in their groups. In these groups, the learners should

consider the following questions:

1. *What do we need when modeling?*
2. *What steps should we go through?*
3. *How can we make our toy more beautiful?*
4. *How can we make our toy stronger?*
5. *What design can we give our toy to look different from others?*

- Let the learners model the toys with these questions in mind. They should write down the steps they followed to model in their notebooks.
- Summarise by highlighting the main points in modeling using clay.
- Organise for learners to carry out further activity on page 39 of their book.
- Learners can then use the toys for playing after which, they should keep them safely at the science corner of their classroom.

### Synthesis

The lesson introduces learners to modeling toys using clay. The learners should be able to model different toys like doll, cow, dog, among others using

clay. Also, motivate all learners to participate actively in modeling irrespective of gender.

### **Lesson assessment**

Assess whether the learning objectives of the lesson were met by:

(a) Giving learners a task to model a domestic animal of their choice then assessing their work.

(b) Asking learners to answer the following questions:

1. Why is it that we should leave our toy to dry in the shade and not directly on the sun rays?

*(Ans: When toys dry in the shade they do not develop cracks).*

2. Which other material can be used for modeling apart from clay?

*(Ans: Plasticine can be used as an alternative for clay).*

3. How can a toys made from clay be made strong so that it cannot break easily.

*(Ans: The toys can be made stronger by burning them with dry grass).*

## **Lesson 2: Making motorcycle using wires.**

Refer to learner's book page 40-41

### **Specific objectives**

By the end of the lesson, learners should be able to make a motorcycle using wires.

### **Preparation for the lesson**

- Obtain materials to be used for making toys such as wires, old slippers, rubber bands, used vehicle/bicycle tubes, bottle tops, scissors, pliers, etc.

### **Teaching aids**

- Materials for making toys such as wires, old slippers, rubber bands, used vehicle/bicycle tubes, bottle tops, scissors, pliers, etc.
- Photographs or charts showing simple toys.

### **Pre-requisite of the lesson**

- You may introduce this lesson by reminding learners what they learnt in the previous lesson that is modeling using clay. Ask them to name some things that they modeled.
- You can then ask whether the

learners think only clay can be used for modeling. At this point, introduce activity 3.2.

### Teaching / learning activities

#### Activity 3.2 (Refer to Pupil's book page 38-39)

- Guide learners to form groups depending on class size and their abilities. Let them carry out the activity in their groups. In these groups the learners can consider the following questions:
  1. *What do we need when making toy using wires?*
  2. *What steps should we go through?*
  3. *How can we make our toy more beautiful?*
  4. *How can we make our toy stronger?*
  5. *What design can we give our toy to look different from others?*
- Let the learners make the toys with the above questions in mind. They should write down the steps they followed to make the toy in their notebooks. Activity 3.3 (Refer to pupil's book page 40). Ask learners to follow the steps on pages 41-44 in their books to make their own motorcycle. They should make as strong and as attractive as possible.
- Summarise by highlighting the main steps in making motorcycle using wires. Refer to Pupil's book pages 40-41.

- Learners can then use the toys for playing after which, they should keep them safely at the science corner of their classroom.

### Synthesis

The lesson introduces learners to making motorcycle using wires. Guide learners to make a motorcycle like. Advise learners to be as creative as possible as they come up with this toy. You can wrap up the lesson by letting learners carry out the case study on page 41 of their books. Let them compare the two toys and say which is stronger and give suggestions how they can make the weak one more stronger.

### Lesson assessment

Assess whether the learning objectives of the lesson were met by:

- (a) Giving learners a task of making a motorcycle. Assess their work and award marks accordingly.
- (b) Asking learners to answer the following questions:
  1. How can we make our toys proportional?  
*(Ans: By measuring with a tape measure)*
  2. How can we determine the shapes of our toys?  
*(Ans: First make a sketch and then make the frames)*
  3. How can we make our toys look more beautiful?  
*(Ans: We may try to cover the wires with painted pieces of hard paper, this will give our toy a new look).*

### Lesson 3: Making utility objects in threads

Refer to learner's book page 41-45

#### Specific objectives

By the end of the lesson, learners should be able to make utility objects such as socks, hat and gloves using threads.

#### Preparation for the lesson

- Obtain materials to be used for making utility objects such as threads weaving hooks or needle and pieces of clothes.

#### Teaching aids

- Materials such as threads, weaving hooks or needle, pieces of clothes, pair of scissors, razor – blade or lancelet.
- Photographs or charts showing various utility objects.

#### Pre-requisite of the lesson

- You may introduce this lesson by asking learners whether they know what utility objects are. Let them name some which they use at home.

#### Teaching / learning activities

##### Activity 3.4 & 3.5 (Refer to Pupil's book page 41 - 45)

- Guide learners to form groups depending on class size and their abilities. Let them identify one utility object out of the ones shown. In their groups, let them consider

the following questions:

1. *What do we need?*
2. *How can we make socks and scarf?*
3. *How can we make it look good?*
4. *Which colours can we use to make it look different from others?*

- Let the learners make the utility objects with the above questions in mind. They should write down the steps they followed to make the utility object in their notebooks.
- Summarise by highlighting the main steps in making utility objects. Refer to Pupil's book pages 41 - 45.
- Learners can then use the utility objects for playing after which, they should keep them safely at the science corner of their classroom.
- You can wrap the lesson by giving learners a project of making either a hat or a pair of gloves.

#### Synthesis

The lesson introduces learners to making utility objects from thread. Learners should be able to make these objects i.e scarfs, socks, hats and gloves among others from scratch. Advise learners to be as creative as possible

as they come up with their objects. Wrap up the lesson by giving learners project work of making a sweater and presenting the finished product to you for assessment.

### Lesson assessment

Assess whether the learning objectives of the lesson were met by:

- (a) Giving learners a task of making a utility object (scarf, gloves, socks, hat) of their choice. Assess their work and award marks accordingly.
- (b) Asking learners to answer the following questions:
  1. Describe the process of making a pair of socks.

*(Ans: Obtain a thread and fix it through the hole on the needle. Use two needles to knit the socks and give a desired shape. Continue knitting until you reach full socks. Wrap the end of the end of the socks using a piece of cloth to make it strong (hemming).*

## Lesson 4: Making learning materials using a paper

Refer to learner's book page 45 -48

### Specific objectives

By the end of the lesson, learners should be able to make learning aids using manila paper.

### Preparation for the lesson

- Obtain materials to be used for making learning materials such as ruler, pencil, pair of compass, manila paper, razor blade (lancelet) or pair of scissors.

### Teaching aids

- Materials such as ruler, pencil, pair of compass, manila paper, razor blade (lancelet) or pair of scissors, photographs or charts showing various utility objects.

### Pre-requisite of the lesson

- You may introduce this lesson by asking learners whether they can recall the learning aids they made in primary 4 and 5. Let them name some of them and say how they made them.

### Teaching / learning activities

#### Activity 3.6 & 3.7 (Refer to Pupil's book page 46-48)

- Guide learners to form two groups. Let them identify one learning aid to make out of the two given (cylinder and cube). In their groups, let them consider the following questions:

1. What do we need?
2. What steps should we go through?
3. How can we cut out the nets and join them to form solids?

- Let learners make the learning aids following the steps given.



- Summarise by highlighting the main steps in making learning aids.

### Synthesis

The lesson introduces learners to making learning aids (regular polygons and solids) using manila paper. Guide learners and correct them accordingly as they make the objects. Advise learners to be as creative as possible as they come up with their objects. You can wrap up this lesson by giving learners additional work of making other polygons and present the finished product for assessment.

### Lesson assessment

Assess whether the learning objectives of the lesson were met by:

- (a) Giving learners a task to make learning aids of their own. Assess their work and award marks accordingly.
- (b) Asking learners to answer the following questions:
  1. What are regular polygons and how can we make them?  
*(Ans: Regular polygons are figures that have more than 2 equal sides. Examples are pentagon, hexagon, nonagon and many others. Polygons can be made by making cut-outs after constructing the polygons on paper or manila).*
  2. Describe the process of making solids.  
*(Ans: The solids can be easily made by first of all making their nets first).*

## Lesson 5: Maintenance of utility and learning objects

**Refer to Learner's book page 48**

### Specific objectives

By the end of the lesson, learners should be able to identify the ways of maintaining utility and learning objects produced.

### Preparation for the lesson

- Obtain utility and learning objects like caps, scarfs, solids such as cubes, cylinders, etc.

### Teaching aids

- Materials such as wrapping papers and utility and learning objects like caps, scarfs, solids such as cubes, cylinders, among others.

### Pre-requisite of the lesson

- You may introduce this lesson by asking learners whether they can recall the learning aids and utility objects they made in previous lessons. Let them name some of them.

### Teaching / learning activities

#### Find out (Refer to Pupil's book page 48)

- Allow learners to carry out a research activity on how to maintain utility objects and learning aids. Let them write summary notes and share with other class members.

- Let learners choose group leaders to do a presentation on their behalf. Help them summarise main points in their notebooks.

### Synthesis

The lesson introduces learners to maintenance of utility and learning objects. Guide learners to come up with innovative ways of protecting their materials from being damaged.

### Lesson assessment

Assess whether the learning objectives of the lesson were met by:

- (a) Giving learners a task to maintain utility objects then assessing their work.
- (b) Asking learners to answer the following questions:
  1. Why do materials that we make require maintenance?  
*(Ans: If anything is not properly maintained it gets spoilt, and it loses value).*
  2. Give at least three ways we can maintain our utility and learning objects. *Ans:*
    - (i) *They should be stored in a clean and dry place.*
    - (ii) *They should be covered or wrapped to avoid dust.*
    - (iii) *They should be kept in a clean environment.*

### Summary of the unit

This unit deals with toys, utility objects and learning aids and their maintenance. You therefore should effectively use the practical activities, demonstrations and the suggested teaching approaches in the teacher's book to guide learners acquire the requisite knowledge and desired competences in these areas. At the end of the lessons, you should assess the extent to which the competencies have been achieved and attitude change towards responsible use of utility objects and their maintenance. Plan remedial activities where necessary for slow learners and give extra activities for gifted ones as well. Also, emphasize the fact that taking this unit seriously may lead to careers such as pottery and craftsmanship.

### Additional information

A toy is an item that can be used for playing. Toys are generally used for playing by children. Playing with toys is an enjoyable means of training young children for life in a society. Playing with toys is important when it comes to growing up and learning about the world around us. In addition, young children use toys to discover their identity, help their bodies to grow strong and practice skills they will need as adults. It also helps to improve their

dexterity. Utility objects on the other hand are objects that help us during our day-to-day life activities. Examples of utility objects include scarfs, sweaters, caps, flower vessels, water pots among others.

### **Answers to Unit Test 3**

#### **(Pupil's book Page 49)**

1. We use clay or plasticine and wires to make toys.
2. We may burn the models with dry grass to make them very strong. We may also include a frame made of wires.
3. Flower vessels, lamp holders, pots , cups ,kettles ,plates and monuments.
4. When making a toy car from wires, the following steps are followed: The materials to use include: wires, cut out car tubes, old slippers and bottle tops.
  - (a) Make the frames and connectors with wires.
  - (b) Connect the frames with the connectors.
  - (c) Complete the car and connect to the steering wheel.
  - (d) We can make the toy look more beautiful by covering the frame work with coloured papers.
5.
  - (a) She is making a floor mat.
  - (b) She is using papyrus remains.
  - (c) They can make the mat durable by applying a hem at the edges.
6.
  - (a) Utility objects such as scarf, socks, hat and sweater are knitted.
  - (b) Weaving, plaiting, coiling.
7. Storing in a cool dry place in a clean environment and keeping covered to avoid dust.
8.
  - (a) Wires.
  - (b) Keeping in a safe place.
9. Assess pupil work and award marks accordingly. Refer to activity 3.4 for more details.
10. He should be encouraged to continue modeling as he is likely to develop good skills that will help him in life in future.

## Additional activities to cater for intellectually challenged and gifted learners

<b>Remedial activities for intellectually challenged learners</b>	<b>Extended activities for gifted and talented learners</b>
<ol style="list-style-type: none"> <li>1. Collecting materials for use in making utility objects.</li> <li>2. Drawing different types of utility objects on manila paper then hanging on wall as a reminder.</li> </ol>	<ol style="list-style-type: none"> <li>1. Making more advanced utility items such as sweater or jacket.</li> <li>2. Doing research on other types of utility objects and their functions.</li> </ol>
<b>Remedial questions for intellectually challenged learners</b>	<b>Extended questions for gifted/ talented learners</b>
<ol style="list-style-type: none"> <li>1. A toy can be made of _____ and _____.</li> <li>2. Which utility objects do you use at home?</li> <li>3. Name three types of polygons that you know.</li> </ol>	<ol style="list-style-type: none"> <li>1. Distinguish between knitting and weaving.</li> <li>2. Explain how the content in this unit can affect the environment.</li> </ol>
<b>Answers to remedial questions</b>	<b>Answers to extended questions</b>
<ol style="list-style-type: none"> <li>1. Clay, wires</li> <li>2. Baskets, mats, scarf, hat.</li> <li>3. Cuboid, cylinder, cube.</li> </ol>	<ol style="list-style-type: none"> <li>1. Knitting – This is a method of creating fabric cloth from a single strand of cloth/yarn using two needles. Weaving – weaving is a method of fabric production in which two distinct sets of threads are interlaced at right angles to form a cloth.</li> <li>2. When collecting clay, we may destroy the environment. This therefore must be done with care. Also, throwing pieces of paper threads and other clothings dirty the environment.</li> </ol>

**Refer to Learner's Book pages 50 - 99**

## Key Unit Competency

After studying this unit, you be able to use common ICT terms and differentiate Sugar and Gnome user interfaces.

## Learning objectives

Competency based curriculum embraces three categories of learning objectives,

that is, knowledge and understanding, skills acquisition and attitude and values. At the end of the unit, learners should have knowledge and understanding of using the computer and have the right attitude towards taking care of it.

**Table 4.1: Knowledge, skills and values to be attained**

Knowledge and understanding	Skills	Attitudes and values
<p>By the end of this unit, the learner should be able to:</p> <ul style="list-style-type: none"> <li><input type="checkbox"/> State the different elements of Gnome environment.</li> <li><input type="checkbox"/> Explain the process of creating a folder</li> <li><input type="checkbox"/> Recall different operations done on folders</li> <li><input type="checkbox"/> Identify the elements of Abiword environment.</li> </ul>	<p>By the end of this unit, the learner should be able to:</p> <ul style="list-style-type: none"> <li><input type="checkbox"/> Manipulate the elements of Gnome window.</li> <li><input type="checkbox"/> Create folders</li> <li><input type="checkbox"/> Differentiate between the files and the folders.</li> <li><input type="checkbox"/> Practice to create, rename, delete, move, copy and paste a file or folder.</li> </ul>	<p>By the end of this unit, the learner should be able to:</p> <ul style="list-style-type: none"> <li><input type="checkbox"/> Appreciate the ignore user environment</li> <li><input type="checkbox"/> Show concern for keeping files in the correct folders.</li> <li><input type="checkbox"/> Show concern of Abiword environment design.</li> <li><input type="checkbox"/> Appreciate text formatting using different colours.</li> </ul>

<ul style="list-style-type: none"> <li><input type="checkbox"/> Recognize different ways of editing and formatting text</li> <li><input type="checkbox"/> Access and open files in different locations of a computer.</li> <li><input type="checkbox"/> Explain the process of saving a document</li> <li><input type="checkbox"/> Explain the role of spread sheet applications.</li> <li><input type="checkbox"/> Identify the basic features of spreadsheet environment</li> <li><input type="checkbox"/> Identify how to manipulate cell contents.</li> <li><input type="checkbox"/> State how to use, manage and understand a worksheet.</li> </ul>	<ul style="list-style-type: none"> <li><input type="checkbox"/> Classify and use Abiword window to produce smart text well formatted.</li> <li><input type="checkbox"/> Practice the process of saving and opening a file saved in a given location.</li> <li><input type="checkbox"/> Create and save a document in a worksheet.</li> <li><input type="checkbox"/> Organise and manage entering data in a cell.</li> <li><input type="checkbox"/> Organise and use various methods to move, delete and fill data from/into cells</li> <li><input type="checkbox"/> Manipulate a worksheet and manage columns and rows.</li> <li><input type="checkbox"/> Use basics arithmetic operations to manipulate cells data.</li> </ul>	<ul style="list-style-type: none"> <li><input type="checkbox"/> Be familiar with spreadsheet environment.</li> <li><input type="checkbox"/> Be satisfied by moving through the spread sheet.</li> <li><input type="checkbox"/> Pay attention to the characteristics and use of sheets and cells.</li> </ul>
--	---	---

### Pre-requisites of this unit

In primary four, learners were introduced to writing skills where they learnt about basic keyboard features and text formatting. They further learnt about tables, pictures and images in primary five and how to manipulate columns and rows of a table and inserting text. In this class, learners will further their skills in these areas by learning more

about word processing using Abiword and Gnumeric spreadsheets. Further make learners understand that what they will learn here links with English and Mathematics. Through this, they will understand how to create a table in Write, also how to insert data and typing numbers in maths and writing an article or a report using words in English, then typing in write.

## Background information

Writing skills is the key part of using a computer. This unit will enable pupils to use a computer keyboard and mouse to write and edit text written. The Abiword in XO Laptop serves as the document creation platform in Gnome interface. This is what this unit is about.

### Cross-cutting issues to be addressed

#### 1. Peace values and gender education

As learners perform the activities in the learner's book, encourage them to be careful not to hurt each other or themselves with the computers.

#### 2. Standardization culture

Encourage learners to always ensure they use authentic external and internal devices on computers. Also, encourage them to always buy original computers, their parts or accessories.

#### 3. Financial education

Learners must ensure that they handle Laptops with care. Repairing or buying a new Laptop can be very expensive.

#### 4. Gender education

Emphasize to learners that anybody irrespective of their gender can pursue a career in computer science. Give examples of role models who are successful IT experts/technicians

in the area where the learners come from.

#### 5. Inclusive education

All learners should be encouraged to participate during lessons and practicals. Special arrangement should be done to take care of learners with special needs. For example, provide brail for blind learners, large print text for those with sight problems and allocate physically challenged learners to others to assist them during field trips and practical activities. Further, this category should be given tasks that they can manage during the practical sessions.

### Generic competences

#### 1. Co-operation and interpersonal management and life skills

As learners interact in pairs and as they engage in group work and as they observe the parts of Gnome interface.

#### 2. Research skills

Learners make practice in abiword by doing discovery questions regarding how to type in abiword.

#### 3. Communication in English

As learners participate in group work and as they carry out presentation tasks to the rest of the class.

#### 4. Critical thinking

Guide learners to discover for themselves different parts of Gnome interface and their use. Also this will

come when learners think how to perform some activities like creating a folder, renaming and deleting a folder, etc.

## 5. Lifelong skills

Knowledgeable on using computers in typing (Abiword) may be used in future career of learners.

### Key words in this unit and their meanings

- **GNOME** (GNU Network Object Model Environment) - is a graphical user interface (GUI) and a set of computer desktop applications for users of the Linux computer operating system.
- **Sugar** - is a learning platform that reinvents how computers are used for education. Collaboration, reflection, and discovery are integrated directly into the user interface. It is a free and open source computer desktop environment designed for interactive learning by children.
- **A desktop environment** - is a collection of software running on top of an operating system that makes up the desktop Graphical User Interface. It usually includes everything from how the windows look and feel, to the style of the icons, files, folders and the mouse pointers. A desktop environment also dictates what file manager to use, default text editor, image viewer, wallpapers and the interface used to log in and log out of the local system.
- **A folder** - is a storage space that many files can be placed into to group them together and organize the computer.
- **A file** - is an object on a computer that stores data, information, settings, or commands used with a computer program. In a graphical user interface (GUI) such as Microsoft Windows, files display as icons that relate to the program that opens the file.
- **Dialogue box** - is a small area on screen in which the user is prompted to provide information or select commands.
- **AbiWord** - is a free word processing program similar to Microsoft Word.
- **A keyboard** - is a panel of keys that operate a computer or typewriter.
- **Undo** - is a command included in most software programs. It is typically located at the top of the Edit menu and has the standard shortcut "Control+Z" in Windows. The Undo command allows you to undo the last action you performed in the program.
- **Redo** - is a function performed on a computer that does any undo function again.
- **Copy** - is to make a copy of a file, folder or selected text in another location.



- **Cut and Paste** - To move files, folders and selected text to another location. Cut removes the item from its current location and places it into the clipboard. Paste inserts the current clipboard contents into the new location.
- **Gnumeric spreadsheet** - is part of the GNOME desktop environment. It is an open-source spreadsheet program.
- **A workbook** - is the MS Excel file in which you enter and store related data. A worksheet (also known as a spreadsheet) is a collection of cells on a single “sheet” where you actually keep and manipulate the data. Each workbook can contain many worksheets.
- **A column** - is a vertical series of cells in a chart, table, or spreadsheet
- **A row** - is the range of cells

that go across (horizontal) the spreadsheet/worksheet.

- **A cell** - is the intersection between a row and a column on a spreadsheet that starts with cell A1.
- **A function** - is a predefined formula that helps save you time. For example, use the SUM function to add lots of numbers or cells, and the PRODUCT function to multiply them.

### **Guidance on the problem statement**

This topic is about Write activity. As a way of introducing the concept of typing in word processing (AbiWord in gnome interface) refer learners to the picture on page 50 of their book. Let them summarise what is going on in the picture using short notes in their exercise books. they should then type their work in Abiword using XO - Lpatop and make it as attractive as possible using the various formatting tools.

## Attention to special educational needs

Support for Multi-ability learning	Support for special needs learning
<ul style="list-style-type: none"> <li>▪ Peer-teaching - engage high achievers to help weak pupils in understanding concepts..</li> <li>▪ Plan remedial teaching for slow learners.</li> <li>▪ Allow enough time to slow learners to complete their work.</li> <li>▪ Gifted learners to be given heavy tasks requiring more critical thinking while slow learners are given tasks, which they can manage such as collecting materials for use during practicals among others.</li> <li>▪ Both gifted and slow learners to be given equal opportunity to lead in group discussions and to do presentations of group findings to the rest of the class.</li> <li>▪ Ensure all learners respects other's views irrespective of their shortcomings or talents.</li> </ul>	<ul style="list-style-type: none"> <li>▪ Identify the learners with hearing and visual impairment and have them sit in front of the class so that proper attention can be given to them. Also, large print texts should be given to visually impaired learners and hearing aids provided for those with hearing impairment.</li> <li>▪ Arrange the room such that it will enable easy movement for the physically challenged learners.</li> <li>▪ Assign some students to be in charge of the physically and visually impaired learners. For example carrying their equipment, showing them around during their field trips etc</li> <li>▪ Organize braille for blind learners.</li> <li>▪ Encourage special needs learners by reminding them that 'disability is not inability'!</li> </ul>

## List of lessons

Lesson No.	Lesson title	No. of Periods
1.	Identification of elements of Gnome environment	1
2.	Working with a document	2
3.	Folder management	1
4.	Identification of elements of Abiword window	1
5.	Text formatting	2
6.	Spreadsheet environment	1
7.	How to create, save and open workbook	2

8.	Columns, Rows and Cells	2
9.	Formatting a cell	1
10.	Worksheet basics	2
11.	Mathematics operators'	2

**LESSON 1: Identification of elements of Gnome interface and abiword window** (To be covered in one period)

Refer to learner's book pages 50 - 58.

**Specific objectives**

By the end of the lesson, learners should be able to:

- Manipulate the elements of Gnome window
- State the different elements of Gnome environment

**Preparation for the lesson**

- This lesson will involve individual practical work, research work and group activities. You will therefore organize the class as need arises during the lesson. **REMEMBER:** When grouping learners, you should consider the different abilities of learners and the special needs for various individuals.
- Bring laptops (computers), pamphlets, handouts and textbooks for reference in class.

- Obtain any other material needed during the class like power strips, chargers/batteries and a projector.

**Teaching Aids**

- XO laptops, laptops or desktops
- Charts with a short text to practice.

**Pre-requisite of the lesson**

- Introduce the unit as explained under guidance on the problem statement above then narrow down to the lesson.
- Ask probing questions to introduce the lesson. Such questions may include: *(How many interfaces does XO laptops have? (Ans: Sugar and Gnome)*
- Identify the steps on how to switch from sugar to gnome (at the home page click on Xo-my settings-switch desktop-switch to gnome-restart now). Refer to steps shown on page 51-52 of pupil's book.
- Summarize by highlighting the key points, which should include the role of each interface and when to use one interface and why?

## Teaching / Learning activities

### Activity 4.2 (Refer to Pupil's book pages 52-53)

- This activity is meant to introduce the Gnome environment to learners.
- Let the learners observe carefully this window and from the Top panel they should click on each item and write down the drop down menu list that appears. Activity 4.3 (Refer to pupils book page 54)
- Guide learners to understand the use and the role of each item and drop down list, they should identify the parts from the top panel to bottom panel list.
- At this point, you can guide learners to open AbiWord program.

### Activity 4.7 (Refer to Pupil's book page 58)

- Guide learners to follow the steps in this activity to open AbiWord window. They should then go ahead and type words of their choice or those specified in Activity 4.5 page 55 of pupil's book.
- Let learners compare their screen with that on page 53 of their book.
- Summarise the lesson by highlighting the key points on the AbiWord window. Allow learners to write summary notes as you do your presentation. You can also make this more interactive by inviting gifted learners to do lesson summary as you guide them.

### Activity 4.8 (Refer to Pupil's book page 59)

- By now, learners have a grasp of what AbiWord window is. Go ahead and show them how to set time and date.
- Put learners in pairs and allow them to set time and date as directed in this activity. At the end of the exercise, they can share their work and see if the times and dates are the same. Let them repeat these until they become familiar.

## Synthesis

- This lesson introduces learners to the Identification of Gnome environment. The activities carried out during the lesson should help learners identify the various panels that make up the Gnome widow and appreciate the function of each panel and use of each drop down list on the panel. Also, use the suggested activities to introduce AbiWord environment to learners.

## Lesson assessment

Assess whether the learning objectives of the lesson were met by:

- (a) Giving learners a task on
  - (i) Opening a write activity and typing words of their choice.
  - (ii) Adjusting date and time on their XO laptops.

(b) Asking learners to answer the following questions:

1. What did you learn in this lesson?

(Ans: *The elements of Gnome interface*)

2. What are the steps of switching to Gnome interface?

(Ans: *Click on `xo-my settings-switch desktop-switch to gnome-restart now`*).

3. What makes up the Gnome interface?

(Ans: *Top panel and Bottom panel*)

4. State different parts found in Top panel and their roles. (Ans:

- *Places: Shows different places like documents, computers, pictures, etc.*
- *Date: Indicates the calendar and current date and time on the laptop.*
- *Battery status: Shows the battery status.*
- *Network: Helps to connect or disconnect the Internet and shows the status of your network.*
- *OLPC user: Helps to switch off or log out while in Gnome.*

## Lesson 2: Working with a document

Refer to learner's book pages 59-62

### Specific objectives

By the end of the lesson, learners should be able to create, save, open and rename a document.

### Preparation for the lesson

- This lesson will involve individual practical work and group activities. You will therefore organise the class as need arises during the lesson. **REMEMBER:** When grouping learners, you should consider the different abilities of learners and the special needs for various individuals.
- Bring laptops and textbooks to class. Also, if you have a computer laboratory make sure the computers are set properly and that the internet is working.

### Teaching Aids

- Laptops and their accessories

### Pre-requisite of the lesson

- Ask probing questions to introduce the lesson. Such questions may include: how do you open a new document? (Ans: *go to application-Office-AbiWord*)

### Teaching / learning activities

#### Activity 4.8 (Refer to Pupil's book page 59)

- Ask learners to practice opening a new AbiWord document. Refer learners to the Activity 4.7 on page 58 that they did earlier on.
- Guide learners to follow the steps of opening a new document individually. Let Learners follow the instructions in the Learners' book and type text of their choice.
- Guide learners to discover how to save a new abiword document.

Guide learners while doing this activity and follow the steps of saving a new document individually.

- Assist learners to follow the steps of choosing where to save their document and the format of saving i.e. 'word.doc'.

#### **Activity 4.8 & 4.9 (Refer to Pupil's book pages 59-60)**

- Ask learners to discover how to open existing abiword document. Guide learners while doing this activity and follow the steps of opening an existing document individually.
- Assist learners to follow the steps on how to open an existing document make changes in the document and save again.
- They should then re-open the document where they saved and confirm the changes made.

#### **Activity 4.11 (Refer to Pupil's book pages 61)**

- At this point, bring to the attention of learners the fact that they should close a document after working on it. Ask learners how they think this can be done.
- Again, put learners in pairs and let them follow the steps given in this activity. Did they successfully close the document? Did they save the changes as prompted by the computer or not? Activity 4.13 (Refer to pupils book page 62)
- You can then bring the attention of learners the fact that there

may be need to rename the existing documents or file. Let them practise doing this using a document in their XO laptop.

#### **Synthesis**

- This lesson introduces learners to use a word document. Use laptops and the suggested activities to guide learners to accurately open a word document and practice saving, renaming, opening an existing document and closing it.

#### **Lesson assessment**

Assess whether the learning objectives of the lesson were met by asking questions such as:

1. Open a new AbiWord document, individually practice saving the document on the desktop.(i) Write the steps of saving a document in abiword. (*Ans: Refer to content in Activity 4.10 page 60 of pupil's book*)
2. How do you open an existing document? (*Ans: Click the File tab and select Open option. This will display Open dialog box, which lets you navigate through different file folders and also lets you select a file, which you want to open*).
3. Describe the steps of renaming a document. (*Ans: Right click on the document name with the mouse and select 'Rename' from the shortcut Menu that appears.Type a new name for the File and then press Enter*).

## Lesson 3: Folder management

Refer to learner's book pages 63

### Specific objectives

By the end of the lesson, learners should be able to:

- Explain the process of creating a folder.
- Recall different operations done on folders.
- Create folders.
- Differentiate between files and folders.

### Preparation for the lesson

- This lesson will involve creating a folder and storing documents in the folder.
  - Bring pamphlets, handouts, and textbooks for reference in class.
  - Prepare laptops to be used or a computer lab if available.
- REMEMBER:** When grouping learners, you should consider the different abilities and the special needs for various individuals.

### Teaching Aids

- XO Laptops or computer laboratory

### Pre-requisite of the lesson

- Ask probing questions to introduce the lesson. Such questions may include: What is a folder? (*Ans: A folder is a storage space that many files can be placed into to group them together and organise the computer.*)
- Identify the steps to create a folder on the desktop? (*Ans: Right-click on the empty space-click on New folder*)

- Let learners follow the steps and individually create a folder on the desktop.

### Teaching / learning activities

#### Activity 4.14 (Refer to Pupil's book page 62)

- Put learners in pairs considering their abilities. Let them carry out this activity.
- Guide learners to answer the questions in this activity and compare their work to other groups.

#### Activity 4.14 (Refer to Pupil's book page 64)

- Learners will move and delete a folder in this activity. Let them work in pairs as in earlier activity. They should then follow the instructions given in this activity.

#### Activity 4.16 (Refer to Pupil's book page 64)

- You may begin this activity by asking learners to tell the difference between a folder and a file. Guide them to discover the difference between these two.
- Pair learners as done earlier, then guide them to practice the steps in this activity.
- Assist learners to type the text given in their laptops and save it on the desktop.
- They should then reopen the file and save it in the folder 'MY CLASS', access the file again and save it in the second folder 'EXERCISE1' Let them repeat this several times until they become familiar.

### Activity 4.18 (Refer to Pupil's book page 66)

- Guide the learners to check the folder properties by following the steps in this activity. Let them write the properties in their exercise books.

#### Synthesis

This lesson introduces learners to the folder management and its role in the computer system. Use the suggested activities to let learners carry out various functions on a folder. At the end, learners should be able to accurately say the difference between an folder and a file.

#### Lesson assessment

Assess whether the learning objectives of the lesson were met by asking questions such as:

1. How can you view the folder properties?

*(Ans: right click on the folder and view the properties in the dialogue box)*

2. What are the steps to create a folder?

*(Ans: Right click on the empty space on the desktop. Click on the create folder, after it will be renamed 'untitled folder.'*

3. Identify the steps to delete a folder.

*(Ans: Right click on the folder, Click on move to trash)*

### Lesson 4: Identification of elements of AbiWord window

*Refer to learner's book pages 66-73*

#### Specific objectives

By the end of the lesson, learners should be able to:

- Identify the elements of the AbiWord environment
- Classify and use AbiWord window to produce smart text that is well-formatted.

#### Preparation for the lesson

- This lesson will introduce the Abiword window in the Gnome interface. Therefore, ensure that the XO laptops are in proper working conditions.
- Bring pamphlets, handouts, and textbooks for reference in class.
- Prepare laptops to be used or a computer lab if available.

#### Teaching Aids

- XO laptops or computer laboratory with functional computers.
- The diagram on page 69 of pupil's book.
- Textbooks for reference or the internet.

#### Pre-requisite of the lesson

- By now, learners have a rough idea of the AbiWord environment. Give them a small activity to practice opening a new abiword window.



## Teaching / learning activities

AbiWord is a free and open source word processor program that resembles other modern word processors. It is easy to use and can be modified to provide an interruption-free writing experience. AbiWord includes many of the same features and is capable of saving and opening documents created in Microsoft Word. We can write a document and make formatting, insert tables; insert bullets, pictures, numbers or letters etc using AbiWord.

### Talking point (Refer to Pupil's book page 66)

- This is a discussion activity to be done in a group. Put learners into various groups depending on class size and their abilities.
- Let them look at the diagram and do research about the features of AbiWord window and their uses.
- Ask learners to label the parts shown on the AbiWord window.
- Let them compare their work to the Fig. 4.8 on page 67 of pupil's book.
- At this point, highlight the main features of AbiWord as learners write brief notes. Refer to content on pages 68
- On the uses of AbiWord features, guide learners to carry out Activities 4.18, 4.19, 4.20, 4.21, 4.22 and 4.23.

- Summarise the lesson by highlighting the key points about using abiword window. Better still, you can appoint a gifted learner to give summary points as you guide them.

## Synthesis

This lesson intends to introduce the features of AbiWord window. Learners through practising using their computer should be guided to use AbiWord toolbars correctly. They should then be able to type in AbiWord and be able to save their work.

### Lesson assessment

Assess whether the learning objective of the lesson was met by asking questions such as:

1. Describe three tools found on the formatting toolbars.

*(Ans: Font style, font size, bold italics and underline)*

2. What are the toolbars found in the AbiWord window?

*(Ans: Menu bar, Title bar, Formatting toolbars and Status bar)*

3. Identify the uses of formatting toolbars.

*(Ans: The Formatting toolbar provides many of the most common options for formatting selected text, such as font, font size, font weight, alignment, and colour).*

## Lesson 5: Text formatting

Refer to learner's book pages 71

### Specific objectives

By the end of the lesson, learners should be able to:

- Recognise different ways of editing and formatting text.
- Classify and use AbiWord window to produce smart text that is well-formatted.

### Preparation for the lesson

- This lesson will involve a practical activity either using the computers in class or in the computer laboratory.
- Bring laptops and their accessories, handouts and textbooks for reference in class.

### Teaching Aids

- XO laptops and computer laboratory.

### Pre-requisite of the lesson

- You may begin this lesson by asking learners to observe carefully the AbiWord window and identify formatting toolbars on the window.

### Teaching / Learning activities

#### Activity 4.24 (Refer to Pupil's book page 71)

- Let learners have their laptops

each and start typing the text given in the learners book.

- Guide learners to practise selecting a word, a phrase, a sentence or a paragraph. They should also practise bolding text, moving or cutting text, copy-pasting text and how to undo and/or redo.
- Summarise the lesson by highlighting key points as learners take short notes. Refer to pupil's book pages 73.

### Synthesis

This lesson introduces text formatting in AbiWord to the learners. Guide learners through the practical activities, demonstration and discussion to discover the various toolbars used to format and edit text and how to do it.

### Lesson assessment

Assess whether the learning objective of the lesson was met by asking questions such as:

1. Which tools are used to format and/or edit a body of text?

*(Ans: Bold, Italics, Underline, font type, font size, alignment, capital letters, colours)*

2. What are the steps to selecting text?

- *Double click: To select the current word, double-click it. Word will select to the left and right of the cursor, until it encounters a space character.*

- *Triple-click: A triple-click selects the current paragraph.*
  - *Margin+click: To select an entire line, move the cursor into the left margin. When you see the insertion pointer turn into an arrow pointer, click. Doing so will select the current line.*
  - *[Ctrl]+a: Pressing [Ctrl] +a selects the entire document.*
  - *[Ctrl]+click: To select a sentence (not just a line), hold down [Ctrl] and click any place within the sentence.*
3. Open abiword document, type a text of your choice, practice copy, cut and paste options till you muster them. (Ans: Assess learner work and award marks accordingly)

### **Lesson 6: Spreadsheet**

**environment** (To be covered in one period)

Refer to learner's book pages 74-81

#### **Specific objectives**

By the end of the lesson, learners should be able to:

- Explain the role of spreadsheet applications.
- Identify the basic features of spreadsheet environment.

#### **Preparation for the lesson**

- This lesson will involve a practical activity either in the computer laboratory or in the classroom and group discussions.

- If in class bring pamphlets, handouts, and textbooks for reference in class
- Prepare the laptops to be used, or the computer laboratory if available.

#### **Teaching Aids**

- XO laptops or any other computer.

#### **Pre-requisite of the lesson**

You may begin this lesson by asking learners what AbiWord is. Build on their responses and explain that Gnumeric Spreadsheet is another type of computer application just like AbiWord.

#### **Teaching / Learning activities**

##### **Activity 4.29 (Refer to Pupil's book page 74)**

- Let learners study the table given, assist learners to open AbiWord and start typing the contents in the table.
- Ask the learners to first try working out the total amounts first by calculation and then using AbiWord.
- Let them brainstorm and say whether there is a better way of manipulating the data.

##### **Activity 4.30 (Refer to Pupil's book page 75)**

- At this point, guide learners to open a Gnumeric spreadsheet and try working out the totals. Let them compare this and the first attempt where they did it manually.

- Guide learners to harmonise their tables. Let them choose a group leader to do a presentation on their behalf.

**Talking point (Refer to Pupil's book page 76)**

- Put learners in groups depending on the size of the class and their abilities. Guide them to carry out research and discuss the features of a Gnumeric spreadsheet window.
- They can draw a diagram in their notebooks then compare with Fig. 4.14 on page 76 of pupil's book.
- Wrap up the lesson by highlighting the main features of a gnumeric spreadsheet with their uses. Let learners write short notes as you summarise.

*(Ans: A computer program used to manipulate and analyze numeric data)*

2. Write the steps to open the gnumeric spreadsheet.

*(Ans: Go to application-office-gnumeric spreadsheet)*

3. Label the key features of the spreadsheet window.

*(Ans: Refer to Figure 4.14 page 76 of pupil's book)*

4. Describe the roles of the spreadsheet?

*(Ans: Help keep track of information in lists, organize numeric values in columns and rows, perform and update calculations)*

**Synthesis**

- This lesson introduces the concept of spreadsheets, the spreadsheet environment, its roles and its definition. Use the suggested practical activities and the discussion group to guide the learners to discover what spreadsheet is.

**Lesson assessment**

Assess whether the learning objective of the lesson was met by asking questions such as:

1. What is Gnumeric spreadsheet?

**Lesson 7: How to create, save and open a workbook**

*Refer to learner's book pages 82-97*

**Specific objectives**

By the end of the lesson, learners should be able to:

- Create and save a document in a worksheet.
- Explain the process of saving a document in spreadsheet.

**Preparation for the lesson**

- This lesson will involve practical activities in using spreadsheet.

- Prepare laptops to be used or ensure that the computers in the computer laboratory are working.
- Bring pamphlets, handouts, and textbooks for reference in class. Also, ensure that all laptops are in a good status ready to use. Make sure the classroom is arranged in a way to facilitate moving around, while learners are practicing.

### Teaching Aids

- XO laptop or any other computer or computer laboratory.
- Pamphlets, handouts, and textbooks for reference in class.

### Pre-requisite of the lesson

Introduce the topic by asking learners and reminding themselves about spreadsheet. Ask probing questions such as: What is spreadsheet? What are the main features of the spreadsheet screen? Then, you can ask them to switch on their laptops and open a new spreadsheet window and start exploring spreadsheet.

### Teaching / learning activities

#### Activity 4.35 (Refer to Pupil's book page 82)

- Let learners using their laptops go to spreadsheet and open a workbook.

- Guide learners to practice the exercises of opening and closing a workbook.

#### Activity 4.36 (Refer to Pupil's book page 83)

- Let learners understand that once they have worked on a workbook, it will need to be saved just like in Abiword. Take them through the activities of saving a workbook as described here. Let them repeat this several times until they get used.

#### Activity 4.37 (Refer to Pupil's book page 84)

- Let learners understand that in this activity, they will open a spreadsheet file, which they saved earlier on. Let them carry out this activity in pairs. They should also practice several times for them to get used to.

### Synthesis

Learners at this stage should open a workbook, save it, close the computer and re-open the earlier saved file. Guide learners to perform more exercises on this in order to perfect their skills.

### Lesson assessment

Assess whether the learning objective of the lesson was met by asking questions such as:

1. Create a workbook and save it on the desktop as 'My work'.

(Ans: Assess learner work and ensure they are able to do this)

2. What is a work book?

(Ans: A workbook is the MS Excel file in which you enter and store related data. Each workbook can contain many worksheets).

3. State the process of opening an existing workbook.

(Ans: Select the FILE tab in the toolbar at the top of the screen. Then click on Open in the left menu. You will see your “Recent Workbooks” listed on the right. To quickly open one of these workbooks, click on the workbook name under “Recent Workbooks”).

4. State the process of opening an existing workbook. (Ans: Select the FILE tab in the toolbar at the top of the screen. Then click on Open in the left menu. You will see your “Recent Workbooks” listed on the right. To quickly open one of these workbooks, click on the workbook name under “Recent Workbooks”).

**Lesson 8: Columns, Rows and Cells** (To be covered in two periods)

Refer to learner’s book pages 87

**Specific objectives**

By the end of the lesson, learners should be able to manipulate a worksheet and manage columns and rows.

**Preparation for the lesson**

- This lesson will involve practical activities in the computer

laboratory involving manipulating columns, rows and cells.

- If in class bring pamphlets, handouts, and textbooks for reference.
- Prepare the laptops to be used, or the computer laboratory if available.

**Teaching Aids**

- XO laptops or any other computers.
- Textbooks and other reference materials.

**Pre-requisite of the lesson**

- Introduce the topic by asking learners to define columns, rows and cells. They can do research in the internet or textbooks.
- Help learners to correctly define these terms in spreadsheet then ask learners to switch on their laptops and open spreadsheet
- Let learners differentiate between rows, columns and cells.

**Teaching / learning activities**

**Activity 4.40 (Refer to Pupil’s book page 87)**

- Let learners observe the table on activity 4.40 and discuss in pairs to come up with a correct answer on the position of the active cell.
- Ask learners to practice entering and deleting text in the active cell.
- Guide learners to experiment adding columns, rows and cells, deleting columns, rows and cells and also resizing columns and

rows in spreadsheet. Refer to content on pages 87-95 of the pupil's book

- Wrap up the lesson by asking learners to practice activity 4.41 in pupils' book page 88

### Synthesis

- The concept of understanding rows, columns and cells in spreadsheet is very essential for learners. Use the practical activities suggested and demonstrations to help learners understand these concepts.

### Lesson assessment

Assess whether the learning objective of the lesson was met by asking questions such as:

1. Define rows, columns, and cells?  
(Ans: A column: is a vertical series of cells in a chart, table, or spreadsheet.

*A row - is the range of cells that go across (horizontal) the spreadsheet/ worksheet*

*A cell - A cell is the intersection between a row and a column on a spreadsheet that starts with cell A1).*

2. In your spreadsheet, practise the steps of deleting and resising a column.

*(Ans: Assess learner work during the practical and award marks accordingly*

## Lesson 9: Formatting a cell

Refer to learner's book pages 89

### Specific objectives

By the end of the lesson, learners should be able to:

- Understand how to manipulate cell contents.
- Organise and use various methods to move, delete and fill data from/ into cells.

### Preparation for the lesson

- This lesson will involve a practical activity either in the computer laboratory or in the classroom.
- If in class bring pamphlets, handouts, and textbooks for reference in class
- Prepare the laptops to be used, or the computer laboratory if available.

### Teaching Aids

- XO laptops or any other computers.

### Pre-requisite of the lesson

- Introduce the topic by asking learners to define a cell in spreadsheet. Let learners switch on their laptops and open spreadsheet.
- In this lesson, learners will learn how to change font type and size, insert or remove cell borders, apply colors and align texts in a document.

## Teaching / learning activities

You are advised to handle each of the items above one at a time.

### Activity 4.44 (Refer to Pupil's book page 89)

- Guide learners to practice this activity in the pupils book. Let them practice how to change font type/size, insert and remove cell borders, apply colour in text and align text.
- Highlight key points when doing this as learners take short notes. Refer to pupil's book pages 93

## Synthesis

The concept of formatting cells in spreadsheet is new to learners; help them to make more practice from the pupils' book. Cells are the basic building blocks of a worksheet. Cells can contain a variety of content such as text formatting attributes, formulas and functions. Guide learners to manipulate and use cells effectively.

## Lesson assessment

Assess whether the learning objective of the lesson was met by asking questions such as:

1. Open a workbook, apply all borders to the sheet.

2. Type the data in the cells and practise changing font size and type.
3. Practise applying background colour and text color to your sheet.

*(Ans: In all the cases above, assess learner work during the practical and award marks accordingly).*

## Lesson 10: Worksheet basics

Refer to learner's book page 89

### Specific objectives

By the end of the lesson, learners should be able to manipulate a worksheet and manage columns and rows.

### Preparation for the lesson

- This lesson is on using a worksheet; it will involve practical exercises to master how to use worksheets.
- Prepare the laptops and make sure the classroom is well arranged.

### Teaching Aids

- XO laptops or any other computers.

### Pre-requisite of the lesson

- Introduce the topic by asking learners to identify what a worksheet is.



- Ask learners to switch on their laptops and open spreadsheet.

### Teaching / learning activities

- Guide learners to practice selecting, deleting, inserting and renaming a worksheet,
- Highlight key points learners write down short notes.
- Wrap up the lesson by explaining what a worksheet is. Refer to Pupil's book pages 93

### Synthesis

The concept of worksheet is fundamental in using workbooks. Assist learners to practice more on inserting, renaming, deleting and removing worksheets from a workbook. Guide learners to differentiate between a workbook and a worksheet.

### Lesson assessment

Assess whether the learning objective of the lesson was met by asking questions such as:

1. What is a worksheet?

*(Ans: A worksheet is a collection of cells on a single "sheet" where you actually keep and manipulate the data).*

2. Open spreadsheet, rename sheet 1 as P6A, sheet 2 as P6B, sheet 3 as Spreadsheet

3. Delete the spreadsheet sheet.

*(Ans: In questions 2 and 3 above, assess learner work during the practical and award marks accordingly).*

## Lesson 11: Mathematical operators in spreadsheet

Refer to learner's book page 93

### Specific objectives

By the end of the lesson, learners should be able to use basic arithmetical operations to manipulate cells data.

### Preparation for the lesson

- This lesson will involve practical lessons being carried either in class or in the computer laboratory.
- Test for the laptops to be used and make sure they are in good working condition.
- Obtain wall charts on different calculations to practice in spreadsheet.

### Teaching Aids

- XO laptops, or any other computers.

### Pre-requisite of the lesson

- You may begin this lesson by asking learners to calculate simple mathematics, either by adding two numbers on the chalkboard.
- Ask learners to discuss how they got the sum of these two numbers. Let them know that it is much easier to use spreadsheet to calculate.
- Ask learners to switch on their laptops and open spreadsheet.

### Teaching / learning activities

#### Activity 4.45 (Refer to Pupil's book page 93)

- Guide learners to discuss and practise the activity above.
- Help learners to understand how to perform calculations in spreadsheet.
- Provide learners with an activity to perform how to make sum by using a formula. See Activity 4.46 on page 96 of pupils book.
- Summarise the lesson by highlighting the key points about mathematical operators as learners take summary notes. Better still, you can appoint a gifted learner to give summary points as you guide them. Refer to the notes in Pupil's book pages 94 – 96.

### Synthesis

This lesson intends to help learners understand and use mathematical operators in spreadsheet. Use the various practical activities suggested to bring out the intended concepts. You should also be able to use a formula in calculation like the autosum.

### Lesson assessment

Assess whether the learning objectives of the lesson were met by asking questions such as:

1. Write the examples of basic math formulas in spreadsheet:  
*(Ans: =A1+A6 - this Excel formula adds the contents of cell A1 and A6*  
*= A1+A2+A3 - this Excel formula adds the contents of the three cells specified. (See the SUM function for adding multiple numbers).*  
*= A3-A1 - this Excel formula subtracts the contents of cell A1 from the contents of cell A3.*  
*= B2\*B3 - this Excel formula multiplies the numbers in cells B2 and B3.*  
*= G5/A5 this Excel formula divides G5 by A5).*
2. What is the sum function in spreadsheet?

*(Ans: The SUM function adds together a supplied set of numbers and returns the sum of these values)*

3. Why do we need to begin with equal sign in excel formula?

*(Ans: This is because the cell contains or is equal to the formula and the value it calculates)*

### **Answers to Self-Test 4.1 (Pupil's book Page 73)**

- Assess learners' work and award marks accordingly.

### **Answers to Self-Test 4.2 (Pupil's book Page 97)**

- Assess learners' work and award marks accordingly.

### **Summary of the unit**

This unit is about learners gaining knowledge and understanding of the writing skills in abiword and spreadsheet. You should have effectively used the suggested activities and the teaching approaches in the teacher's book to help learners acquire this competence. At the end of the lessons, you should assess the extent to which the competency was achieved and plan remedial activities where necessary. Remember, one of the attitudes and values intended at the end of the

topic are for learners to appreciate the Gnome user environment. Guide learners to acquire the competencies desired in this area.

### **Additional Information for the teacher**

#### **▪ Workbooks and Worksheets**

When Excel is opened, a workbook appears with three worksheets. Each worksheet contains columns and rows. There are 1,048,575 rows and 16,384 columns. The combination of a column coordinate and a row coordinate make up a cell address. For example, the cell located in the upper left corner of the worksheet is cell A1, meaning column A, row 1. The cell address is visible in the Name Box.

- Place your cursor in the first cell, A1. The formula bar will display the cell address in the Name Box on the left side of the Formula bar. Notice that the address changes as you move around the sheet. You can easily move from cell to cell by pressing tab or using the arrow keys.
- A cell can contain any of the following:
  - A number (and any associated punctuation, such as decimal points, commas, and currency symbols).

- Text (including any combination of letters, numbers, and symbols that aren't number-related).
- A formula, which is a math equation.
- A function, which is a named equation that shortcuts an otherwise complex operation

### Creating a New Workbook

- It is easy to create a new workbook! Simply, click on File – New or Office Button – New and click on Blank Workbook to create a new workbook.

### Creating a New Worksheet

- Creating a new worksheet is just as easy. By default, each Excel workbook contains three worksheets. Three tabs displaying Sheet 1, Sheet 2, and Sheet 3 will be displayed at the bottom of the workbook to indicate the separate sheets. To add a new worksheet, simply click on the tab after the tab that says Sheet

### Navigating and Selecting

- Moving around a worksheet is easy! You can easily move from cell to cell by using the arrow keys or pressing tab (will move the cursor to the right) or shift-tab (shift-tab will move you to the left). You

can also use your mouse to click within a cell which will select that cell. Sometimes you will want to select a range of cells.

- A range is a group of one or more cells. If you select more than one cell at a time, you can then perform actions on the group of them at once, such as applying formatting or clearing the contents. A range can even be an entire worksheet.
- A range is referenced by the upper left and lower right cells. For example, the range of cells B1, B2, C1, and C2 would be referred to as B1:C2.

### To select a range:

- With the mouse: Drag across the desired cells with the left mouse button held down. Be careful when you're positioning the mouse over the first cell (before pressing the mouse button). Position the pointer over the center of the cell, and not over an edge.
- If you drag while the pointer is on the edge of the cell, Excel interprets the selection as a move operation and whatever is in the cell(s) is dragged to a different spot.
- With the keyboard: Select the first cell, and then hold down the Shift key while you press the arrow keys to expand the selection area.

- To select a nonrectangular or noncontiguous range, select the first portion of the range (that is, the first rectangular piece), and then hold down the Ctrl key while you select additional cells/ranges with the mouse.
- To select an entire column, click the column header (where the letter is). To select an entire row, click the row header (where the number is). You can click one row or column and then drag to select additional columns, or hold down Ctrl as you click on the headers for noncontiguous rows and/or columns.

### Entering and Editing Data

- Let's learn how to enter data into your worksheet. First, you place the cursor in the cell in which you would like to enter data. Then you type the data and press Enter.

### Inserting Columns and Rows

- If you don't plan your worksheet layout correctly, you might end up with too many or too few rows or columns in a certain area. You can always move data around in the sheet to help with this, but

sometimes it's easier to simply insert or remove columns or rows.

#### To insert a column or row:

- Click on the cell on the right of the two columns between which you wish to insert. To insert rows, click on the lower row of the two between which you wish to insert.
- Go to "Insert" and select "Columns". To insert a row, go to "Insert" and select "Rows".
- Appearing to the left of your highlighted column or above your highlighted row will be a new row or column. Insert a row to the left of Column I and a row under Row 1.

### Formatting Columns and Rows

- Often you will need to change your columns and rows in order for text to fit or for the text to fit on the page correctly. There are a number of different methods one can use to do this. Let's start with columns.
- **Column Width:** The formatting that is unique to columns is Column Width. Column Width is measured in characters. A column's width can be from 0 to 255 characters, which is a really wide column! Decimal values are allowed. In fact, the default size is 8.43 characters.

- A width of 12, for example, means the column is wide enough for 12 average characters, using whatever you chose as the Standard font. The default is Calibri 11 pts. To change the font from the default, go to Tools-Options-General-Standard font.
- Be careful when you set a column's width with AutoFit. The column may wind up wider than you expected. Any text will be on a single line in its cell. No matter how long the text is! If you accidentally find you've widened a cell out of sight to the right, use Undo. (my favorite button!) Then resize the column with another method.
- AutoFit will leave a little white space, called the cell padding, between the text in the cell and the cell edges. When Arial 10 pt. is the Standard Font, the Row Height is 12.75 points. You may find that this looks a bit crowded when the gridlines are shown. If you don't print the gridlines, your paper version will look OK.

### Formatting Text and Data

- Once information has been entered into a cell, you might want to change or enhance the way the information is displayed. Text can be formatted in the same way that one uses in Microsoft Word or PowerPoint. Most of the formatting choices can be found in the Font grouping under the Home tab. First remember to always make sure that the cell you want to format is selected.

### Column Width – Drag method

- Dragging is a natural method of adjusting column width. But since you can't see the change until you release the mouse button, it may take you several attempts to get a satisfactory width.

### Row Height

- The only unique formatting for rows is Row Height. Row Height is measured in points, like font size, from 0 to 409 points. A row height of zero hides the row.
- The default setting for Row Height is AutoFit. The row height adjusts to the largest font size in the row.

### Deleting versus Clearing a Cell

- Many beginners get confused about clearing versus deleting in Excel, so let's look at this concept briefly. When you clear the content from a cell, the formatting for that cell is still there. It may be helpful to think of an Excel worksheet as a stack of empty cardboard boxes,

each one with its open side facing you. You can put something into a cell or take something out. When you take something out of a cell, it's called clearing its content. The cell itself remains in the "stack," but it's now empty.

#### **To clear the content from a cell:**

- Press Delete on the keyboard.
- Right-click the cell and then select Clear Contents.
- On the Home tab, in the Editing group, select Clear>Clear Contents.

Unfortunately, clearing a cell's content doesn't clear its formatting.

#### **To clear formatting:**

- On the Home tab, in the Editing group, select Clear > Clear Formats
- To clear both contents and formats at once, select Clear All.

In contrast, deleting the cell removes the cell itself from the stack and makes the surrounding cells shift. Think about what happens when you pull a box out of a stack of boxes -- the boxes above it fall down one position, right? It's the same thing with Excel cells, except it's reverse-gravity (cells fall up rather than down), and you have the choice of making the remaining cells shift up or to the left.

## **Alignment Options**

**Wrapping Text** When you enter text that is too long to fit in a cell into a cell, it overlaps the next cell. If you do not want it to overlap the next cell you can wrap the text.

### **Exercise 13**

1. Open another new sheet.
2. Move to cell A1.
3. Type Text too long to fit. (After typing, click out of the cell and back in again.)
4. From the Ribbon, choose Home >Cells > Format. This will open a dropdown menu.
5. Click on Format Cells at the bottom of the dropdown menu.
6. Choose the Alignment tab.
7. Click Wrap Text.
8. Click OK. The text wraps.

## **Merging Cells**

Sometimes, rather than having text wrap in a cell, you will actually want the text to run across the width of the data. Usually when making a spreadsheet, you need to create a heading for the sheet. This heading should run across the width of your data. To do this, one must merge the cells across the width of the data. To do that:

- Select the range of cells that you want to merge e.g. A1:B1.
- Click the Merge and Center button. The heading is now centered over the data.

## Performing Mathematical Calculations

What's a formula?

- A formula is an equation that performs some type of operation and issues a result. In Excel, formulas always begin with an equal sign. Here are some formula examples:
- =2+6: This formula is strictly math. If you place this formula in a cell, the cell displays 8.
- =A1+6: Same as the preceding, but this time you're adding 6 to whichever value is in cell A1 and displaying the result in the cell into which you enter this formula. This formula does not change A1's contents.
- =A1+A2: Same thing again, but you're adding the contents of cell A1 to the contents of cell A2.
- =A1+A2-A3: In this example, multiple cells are referenced.
- Here are the symbols you can use in formulas to indicate mathematical operations:
- +: Addition
- -: Subtraction

- \*: Multiplication
- /: Division
- More Formula Examples
- The math operators in Excel have an order of operation, just like in regular math. The order of operation is the order in which they're processed when multiple operators appear in the same formula. Here are the rules that determine the order:
- Any operations that are in parentheses, from left to right.
- Multiplication (\*) and division (/)
- Addition (+) and subtraction (-)

Parentheses override everything and go first. So, if you need to execute an operation out of the normal order, you place it in parentheses.

## Common formula errors

- Here are some of the most common mistakes people make when entering formulas and functions:
- Not putting in all the required arguments: If a function is expecting more arguments than you have entered, and you get a dialog box, be sure you've placed commas between the arguments and that you haven't overlooked any.
- Circular references: If you refer to the cell's own address in a function, you create a circular error, which



is like an endless loop. Suppose that you enter `=A1+1` into cell A1. You'll get an error message like the one below. If you click OK at this message, a Help window appears to help you find the problem.

- **Text in an argument:** Most functions require numeric arguments. If you enter text as an argument, for example, `=SUM(text)`, the word `#NAME?` appears in the cell. This happens because Excel allows you to name ranges of cells using text, so technically `=SUM(text)` isn't an invalid function. It is invalid only if there's no range that has been assigned the name "text."
- **Hash marks (####) in a cell:** This happens when the cell isn't wide enough to display its value. Widen the column to fix this.
- **If you receive an error when copying a formula, don't panic;** it happens to everyone. Use the skills you learned earlier in this chapter to display the formulas and then check them for the common errors discussed here.

## Printing

- **Let's prepare to print!** If your worksheet is more than one printed page, it is possible to have the heading on each page by going

to the Page Layout tab, in the Page Setup group and click Print Titles. On the Sheet tab, under Print Titles, do one or both of the following:

- (a) In the Rows to repeat at top box, type the reference of the rows that contain the column labels if you want the heading repeated on each page.
- (b) In the Columns to repeat at left box, type the reference of the columns that contain the row labels if you want those to show.

## Recognizing Cursor Styles

- There are four common cursor styles used in Excel. These cursor styles are shown in the table below.
- Click and drag to highlight multiple cells with this cursor, or click in a cell to select the single cell. Click and drag with this cursor to fill cell contents into cells below or to the right.
- Click and drag the contents of the selected cell to any other cell. Click to place the cursor into the Formula bar so that you can edit an equation or function.

**Answers for Unit Test 4** (Refer to Pupil's book pages 98 -99)

Let learners attempt the various questions practically then assess their work and award marks accordingly.

**Additional activities to cater for intellectually challenged and gifted learners**

You may need to assess the questions in the self tests and the unit test and see which ones can be used for remedial teaching and which ones to be given to gifted learners. Examples are given in the table below.

Remedial activities for intellectually challenged learners	Extended activities for gifted and talented learners
<ol style="list-style-type: none"> <li>1. Open a New AbiWord document and type the title as 'Pampered Pets' in capital letters.               <ol style="list-style-type: none"> <li>(a) Press "enter" two more times and then type:</li> <li>(b) Can your pet sing?</li> <li>(c) Can your pet dance?</li> <li>(d) Can your pet tell jokes or do tricks?</li> <li>(e) Bring them along! Winners and consolation prizes.</li> <li>(f) Save on the Desktop as Pet Talent Contest.</li> </ol> </li> <li>2. Open spreadsheet; name the sheet 1 as 'P6 Term III', Save the file to your Documents folder.</li> <li>3. Enter the information below in the cell indicated as B10:Averages</li> <li>4. Do the following calculations               <ul style="list-style-type: none"> <li>• <math>= (5+6)*9</math></li> <li>• <math>= 9+10+6</math></li> <li>• <math>= 96/2</math></li> </ul> </li> </ol>	<ol style="list-style-type: none"> <li>1. Open AbiWord blank page, Write a 5 paragraph essay about 'A good friend'. Bold and underline the title, save your work in the folder called 'Essay'.</li> <li>2. Open Gnumeric spreadsheet, on sheet 1, type your First term report marks as written on your report. Calculate the total of your marks per subject and the percentage using spreadsheet formula. Name sheet 1 as 'Term I', save your work in the folder called 'My Report' in my Document.</li> <li>3. Enter a formula that calculates the Average, Total marks and percentage for each subject. Format the subject titles in bold and in blue colour.</li> </ol>

**Refer to Learner's Book pages 100 - 115**

## Key Unit Competency

After studying this unit, you will be able to explore and use Search engines.

## Learning objectives

Competency based curriculum embraces three categories of learning objectives,

that is, knowledge and understanding, skills acquisition and attitude and values. At the end of the unit, learners should have knowledge and understanding of using search engines and make research using different techniques.

**Table 5.1: Knowledge, skills and values to be attained**

Knowledge and understanding	Skills	Attitudes and values
<p>By the end of this unit, learners should be able to:</p> <ul style="list-style-type: none"> <li><input type="checkbox"/> Explain the role of search engines.</li> <li><input type="checkbox"/> Give examples of search engines by their types.</li> <li><input type="checkbox"/> Name and compare different search engines using keyword and phrases and searching techniques.</li> </ul>	<p>By the end of this unit, learners should be able to:</p> <ul style="list-style-type: none"> <li><input type="checkbox"/> Explore and use search engines.</li> <li><input type="checkbox"/> Categorise different search engine.</li> <li><input type="checkbox"/> Filter information found using a search engine.</li> <li><input type="checkbox"/> Evaluate information and edit and enrich the information by copying and using a word processing program.</li> </ul>	<p>By the end of this unit, learners should be able to:</p> <ul style="list-style-type: none"> <li><input type="checkbox"/> Show curiosity on the use of simple machines and their importance.</li> <li><input type="checkbox"/> Be aware of possible dangers of using simple machines.</li> </ul>

## Pre-requisite of this unit

Learners first heard about computer research in primary 5 where they carried out simple tasks like accessing the world map and the dictionary. They also learnt about emails - how to create an account, how to log into the account and how to write and send mail. At this level, learners are expected to venture more into search engines and how to effectively search for information using the internet. Make them understand this fact and let them know that learning the basics of using a search engine, as well as some techniques used to search on the web has some level of association with English and to some extent social studies.

### Background information

In this unit you will teach how to use Search engines, search engine techniques and browsers. A web search engine is a software system that is designed to search for information on the World Wide Web, (www). Therefore, it is very important for learners to understand how to make searches through different browsers.

### Cross-cutting issues to be addressed

#### 1. Peace values and gender education

As learners perform the activities in the learner's book, encourage them to be careful not to hurt each other or themselves with the computers.

#### 2. Standardization culture

Encourage learners to always ensure they use authentic external and internal devices on computers.

#### 3. Financial education

Advise learners ensure that they always handle laptops or computers with care. Repairing or buying new laptop or computer can be very expensive.

#### 4. Gender education

Emphasize to learners that anybody irrespective of their gender can pursue a career in computer science. Give examples of role models who are successful IT/technicians in the area where the learners come from.

#### 5. Inclusive education

All learners should be encouraged to participate during lessons and practicals. Special arrangement should be done to take care of learners with special needs. For example, provide brail for blind learners, large print text for those with sight problems and allocate physically challenged learners to others to assist them during field trips and practical activities. Further, this category should be given tasks that they can manage during the practical sessions.

### Generic Competences

#### 1. Co-operation and interpersonal management and life skills

During group discussions and group interactions - let learners engage one another by giving a chance for all to participate. Also, during

group presentations - you can allow rotational presentations within the group members. Gifted learners should help in coming up with presentation content as slow learners contribute. **REMEMBER** You should allow slow learners to do presentations as well and correct them where they go wrong. Advise learners to appreciate the different abilities of their group members and accommodate each other's views.

## 2. Research skills

Guide learners to make successful internet searches using the various search engines. Further, guide learners on how to come up with summarized notes from a large body of text.

## 3. Communication in English

Communication in English will be improved when learners freely participate in the discussions and presentations. Encourage all learners irrespective of their abilities to participate in group discussions, during presentations by asking questions and during question and answer sessions to either introduce or wrap up the lessons.

## 4. Critical thinking

Guide learners to discover for themselves the differences between search engines and their uses. This competence will also come about as learners think about their research findings and as they give out their suggestions on why certain things are the way they are.

## 5. Lifelong skills

The skills acquired in research can be used in future while at work or when doing job related Internet searches. This topic area can also lead to careers such as IT specialists and technicians therefore learners should be encouraged to take it seriously.

### Key words in this unit and their meanings

- **Search engine** - Specialized websites that help you find what you're looking for on the Web. Examples are google, bing, yahoo and ask.
- **Browser** - is a program that lets you locate and view web pages. The most widely used browser is Internet explorer. Others are mozilla, safari, opera mini, chrome among others.
- **www** - world wide web
- **Keyword** – the word that you input in a computer to search its meaning through the Internet.
- **Synonyms** – words or phrases that have the same meaning.

### Guidance on the problem statement

This topic is about Computer Research. Let learners study the picture on page 100 and say what it is about. The picture shows pupils searching for the meaning of the phrase 'search engine' and the various types of search engines in a pile of books without success. They seem to be stranded. Let learners brainstorm and suggest a solution to this problem situation which is - to search for the

words in the internet. This the learners can only do if they have knowledge on how to do effective internet search.

### Attention to special educational needs

Support for Multi-ability learning	Support for special needs learning
<ul style="list-style-type: none"> <li>▪ <b>Peer-teaching</b> – engage high achievers to help weak pupils in understanding of concepts.</li> <li>▪ Plan remedial teaching for slow learners.</li> <li>▪ Allow enough time to slow learners to complete their work.</li> <li>▪ Gifted learners to be given heavy tasks requiring more critical thinking while slow learners are given tasks, which they can manage such as collecting materials for use during practicals among others.</li> <li>▪ Both gifted and slow learners to be given equal opportunity to lead in group discussions and to do presentations of group findings to the rest of the class.</li> </ul>	<ul style="list-style-type: none"> <li>▪ Identify the learners with hearing and visual impairment and have them sit in front of the class so that proper attention can be given to them. Also, large print texts should be given to visually impaired learners and hearing aids provided for those with hearing impairment.</li> <li>▪ Arrange the room such that it will enable easy movement for the physically challenged learners.</li> <li>▪ Assign some students to be in charge of the physically and visually impaired learners. For example, carrying their equipment, showing them around during the field trips, etc.</li> </ul>

### List of lessons

Lesson No.	Lesson title	No. of Periods
1.	Introduction to search engines	2
2.	Search engine techniques	3
3.	Types of search engines	4
4.	How to conduct an effective internet search	1

## **LESSON 1: Introduction to Search engines.**

*Refer to learner's book pages 101*

### **Specific objectives**

By the end of the lesson, learners should be able to:

- Explain the role of search engines
- Give examples of search engines by their types
- Explore and use search engines

### **Preparation for the lesson**

- This lesson will involve individual practical work, research work and group activities. You will therefore organize the class as need arises during the lesson. **REMEMBER:** When grouping learners, you should consider the different abilities of learners and the special needs for various individuals.
- Prepare the laptops to be used and arrange a classroom to facilitate learning and moving around.
- Bring pamphlets, handouts, and textbooks for reference in class. Also, ensure that the Internet is working if you have a computer laboratory or any other form of internet connectivity such as WIFI or modem.

### **Teaching Aids**

- XO laptops or any other computers.

- The diagram on page 88 of pupil's book.

### **Pre-requisite of the lesson**

- Introduce the unit as explained under guidance on the problem statement above then narrow down to the lesson.
- Introduce the lesson to learners by asking probing questions such as what do you understand by the word Internet? What are roles of the Internet?

### **Teaching / learning activities**

#### **Activity 5.1 (Refer to Pupil's book page 101)**

- Guide learners to carry out the activity. Let them discuss their findings in pairs and compare their answers.
- They can then have a class discussion on the various types of search engines (Talking point page 101)
- Let one learner lead the class on recapping the main points and give examples. Explain what search engine is as learners take summary notes.

#### **Talking point (Refer to Pupil's book page 101)**

At this point, you can introduce the concept of web browser by letting learners carry out this discussion.

- Help learners to distinguish between the browsers and where they can be used. You can then



give a small activity on using the browsers to search for information and the learners comparing the results of the different browsers.

**Activity 5.2 page 103 of pupil's book)**

- Summarise the lesson by highlighting the key points about search engines as learners take summary notes. Better still, you can appoint a gifted learner to give summary points as you guide them.

**Synthesis**

- The lesson introduces learners to search engines. The activities carried out during this lesson should help learners identify the search engine types, categorise them and determine the roles of each search engine.

**Lesson assessment**

Assess whether the learning objectives of the lesson were met by asking questions such as:

- What did you learn in this lesson? (*Ans: Search engines and their roles in research*)
- What is a search engine? (*Ans: A software system designed to search for information on the world wide web*)
- Identify different types of search engines. (*Ans: Google, Yahoo, bing, ask*)

**Lesson 2: Search engine Techniques**

*Refer to learner's book pages 102*

**Specific objectives**

By the end of the lesson, learners should be able to name and compare different search engines using keywords and phrases in searching techniques.

**Preparation for the lesson**

- This lesson will involve individual practical work and group activities. You will therefore organize the class as need arises during the lesson. **REMEMBER:** When grouping learners, you should consider the different abilities of learners and the special needs for various individuals.
- Bring reference textbooks to class. Also, ensure that the Internet is working if you have a computer laboratory or any other form of Internet connectivity such as WIFI or modem.
- Bring and prepare laptops to be used.

**Teaching aids**

- XO laptops and any other available computers and textbooks.

### Pre-requisite of the lesson

- Let learners understand that in this lesson, they will learn about techniques that would give good results when doing internet searches.
- Ask probing questions to introduce the lesson. For example, how do you connect to the Internet? How best can you search for information in the Internet?
- Build on the answers to these questions to introduce the concept of keyword and phrase searching.

### Teaching / learning activities

#### Case study (Refer to Pupil's book page 102)

- Guide learners to search for a keyword of their choice using the various search engines then compare the results.
- Let them repeat this activity by this time round using a phrase instead of a keyword. Again, they should compare the results from the different search engines.
- Stress the need to be careful when choosing phrases for the searches to be successful.

#### Activity 5.3 & 5.4 (Refer to Pupil's book page 104 - 105)

- Guide learners to carry out these activities in groups of four. Let them compare the search results that they obtain.
- Re-inforce the need to choose

search phrases properly by letting learners carry out the case study on page 105 and activity 5.4 on pages 105 of pupil's book.

- Summarise the lesson by highlighting the key points on the phrase and keyword techniques of searching. Refer to the notes in Pupil's book page 106. Allow learners to write summary notes as you do your presentation. You can also make this more interactive by inviting gifted learners to do lesson summary as you guide them.

### Synthesis

This lesson introduces learners to the search engine techniques. Use the suggested practical activities and the case studies to show learners how to do successful internet searches.

### Lesson assessment

Assess whether the learning objectives of the lesson were met by asking questions such as:

- Identify the two search engine techniques. (*Ans: Keyword search and phrase search*)
- Explain the roles of search engines. (*Ans: They act as a bridge between the world wide web and the computer*)
- Differentiate the keyword and phrase types of search engine techniques. (*Ans: Keyword uses just one word while phrase searching uses a group of words*)

### Lesson 3: Types of search engines

Refer to learner's book pages 106

#### Specific objectives

By the end of the lesson, learners should be able to name and compare different types of search engines.

#### Preparation for the lesson

- This lesson will involve individual practical work and group activities together with case studies. You will therefore organize the class as need arises during the lesson.  
**REMEMBER:** When grouping learners, you should consider the different abilities of learners and the special needs for various individuals.
- Prepare and bring computers to be used. Ensure that the computers are working properly.
- Ensure that the Internet is working if you have a computer laboratory or any other form of Internet connectivity such as WIFI or modem.

#### Teaching Aids

- XO laptops or any other available computers
- Textbooks

#### Pre-requisite of the lesson

- Remind learners about the types of search engines they learnt about earlier on. Let volunteers give the names as you write on the blackboard.
- At this point you can clarify that search engines can further be broken down depending on the information one is looking for. You can give the list on pages 106 of pupil's book.
- Let learners know that they are going to explore each of these search engines individually.

#### Teaching / learning activities

##### (a) Primary search engines

##### Activity 5.5 (Refer to Pupil's book page 106)

- Introduce learners to the three primary search engines, which are: Google, bing and yahoo.
- Put learners in small groups according to their abilities. Ask them to log onto their computers and input each of these search engines. Let them carry out the activity above.
- Guide learners to compare the results of their searches. Let them answer these questions: Which search engine gave more convincing outcomes? Based on

this, which search engine would you prefer for carrying out your research?

- Summarise the lesson by highlighting the key points about searching a phrase 'one laptop per child' as learners write short notes.

### **(b) Secondary search engines - Activity 5.6 (Refer to Pupil's book page 107)**

- Put learners in groups of five and allow them to log on to their computers.
- Guide them to go to ask.com and search who the president of Rwanda is. They should then compare their search results.
- Wind up this section by clarifying what secondary search engines are giving examples.
- Let learners search the same question using the other search engines (lycos, looksmart, miva and spotting) and compare their results.

### **(c) Targeted search engines**

#### **Activity 5.7 (Refer to Pupil's book page 107)**

- Put learners in groups and allow them to log on to their computers.
- Guide them to go to Citysearch, YahooTravel or Musicsearch and search for the various items listed.

- Allow the learners to discuss and share their search results.

- Clarify what targeted search engines are as learners write summary notes.

### **(d) Meta search engines**

*Case study (Refer to Pupil's book page 108)*

- Put learners in groups and allow them to log on to their computers.
- Guide them to go to metacrawler and Dogpile and search for the process of digestion.
- Allow the learners to discuss and compare their search results.
- Clarify what meta search engines are as learners write summary notes.

### **(e) Science-specific search engines – Case study (Refer to Pupil's book page 108)**

- Put learners in groups of four and allow them to log on to their computers.
- Guide them to go to google scholar, sciencedirect and GetCITED and search for climate change.
- Allow the learners to discuss and compare their search results.
- Clarify what science - specific search engines are as learners write summary notes.

**(f) Social Science** - specific search engines – Case study **(Refer to Pupil's book page 109)**

- Put learners in groups and allow them to log on to their computers.
- Guide them to go to behavioral brain science archive, social science research network, socioSite and The SocioWeb and search for populations of sub-saharan Africa countries.
- Allow the learners to discuss and compare their search results.
- Clarify what Social science specific search engines are as learners write summary notes.

**(g) Art and humanities - specific search engines – Activity 5.8**  
**(Refer to Pupil's book page 109)**

- Put learners in groups and allow them to log on to their computers.
- Guide them to go to VADS visual art images and Arts Search and search for the origin of Kinyarwanda language.
- They should also find out more about Kinyarwanda language from their parents and guardians.
- Allow the learners to discuss and compare their search results.

- Clarify what arts and humanities specific search engines are as learners write summary notes.

**(h) Format-specific search engines – Activity 5.9**

- Finalise by informing learners that the last search engine is the format - specific one which focuses on searching for web pages in a certain subject area.
- Summarise by giving learners a task of doing research on an area of their interest then reporting their findings back to class.

**Lesson 4: How to conduct an effective Internet search**

*Refer to pupils book pages 110-113*

**Specific objectives**

By the end of the lesson, learners should be able to use various search engines to conduct an effective search.

**Preparation for the lesson**

- Ensure that the internet is working properly.

**Teaching Aids**

- XO laptops or computer desktop.
- Internet connectivity

### Pre-requisite of the lesson

- Let learners understand that in this lesson, they will use the search engines they have learnt about to do an effective search of information on various topics.

### Using search engines

Guide learners to carry out this activity. They should then compare the results of the various search engines.

Allow learners to share their findings then help them harmonise their points as they write short notes.

### Synthesis

The lesson intends to make learners be able to categorise and use different types of search engines. The activities carried out during the lesson should help learners identify and use different categories of search engines appropriately in doing research on different theme areas.

### Lesson assessment

Assess whether the learning objectives of the lesson were met by asking questions such as:

1. Go to [www.google.com](http://www.google.com). Search for the question 'what is a browser? Repeat this with different search engines. Compare and write down your research findings. (Ans: Assess student work and award marks accordingly)

2. Identify the different types of search engine. (Ans: Primary, secondary, targeted, meta search engine, science specific search engine, social science specific search engine, art and humanities specific search engine, format specific search engine)
3. Give examples of most popular primary search engine. (Ans: Google, bing, yahoo)
4. Give 3 examples of targeted search engines (Ans: Yahoo travel, music search, city search)

### Answers to Self-Test 5.1

Refer to pupil's book page 105

1. World Wide Web
2. (a) Access to information  
(b) Ability to find resources quickly  
(c) Online communication through chat and social networking  
(d) Ability to shop online
3. Search engines are the foundation of the Internet; it is the quickest way of finding the information, or product that you want.
4. Key word search involves searching for one word or more words and are punctuation

sensitive, while phrase search, you search for exact sentence or phrase. For example: search for 'milk cow'. Google gives you the answer and websites to search for more information while ask directs you to another websites to search for information.

### **Answers to Self-Test 5.2**

*Refer to learner's book page 114*

1. Primary search engine (Example: Google, msn, yahoo, bing, ask)  
Secondary search engine (Example: Lycos, miva, look smart, ask.com). Targeted search engine (Example: city search, yahoo Travel, music search) Etc – refer to Pupil's book pages 106
2. Assess student work and award marks accordingly.
3. Assess student work and award marks accordingly.

### **Summary of the unit**

This unit is about learners gaining knowledge and understanding of how to do computer research. You should have effectively used the suggested activities and the teaching approaches in the teacher's book to help learners acquire this competence. At the end of the lessons, you should assess the

extent to which the competency was achieved and plan remedial activities where necessary. Remember, one of the attitudes and values intended at the end of the topic was for learners to appreciate search engine utilisation to find data and information on the internet and have desire to. Do more research via internet and highlight. Also be aware of the risks of the internet. Guide learners to do these accordingly.

### **Additional information for the teacher**

- Some information that may be relevant with regards to the search engine are given below.

### **Definition of Search Engine and browser**

- A web search engine is a software system that is designed to search for information on the World Wide Web. The search results are generally presented in a line of results often referred to as search engine results pages (SERPs). The information may be a mix of web pages, images, and other types of files.
- An internet browser, also known as a browser or a web browser, is a software program that you use to access the internet and view web pages on your computer. You can think of your browser as your gateway to the internet. Without

browsers, the internet as we know it today cannot work. Common web browsers include Microsoft Internet Explorer, Google, Chrome, Mozilla Firefox, and Apple Safari.

### **Basic Internet search techniques**

- Before starting your search it's a good idea to have a basic understanding of the tools used to retrieve information. They include:
- Internet
- World Wide Web
- Search engine

### **Defining Search Tools**

- The terms Internet and World Wide Web (Web) are often used interchangeably, but they are not the same thing.
- The Internet provides the electronic communication structure.
- The Web uses the structure to find and display information from a variety of sources.
- You can search for information on the Web using any number of different search engines. Search engines are large databases of web page files. Search engines use programs called “spiders” or “robots” to “crawl” through Web pages, index the information and add it to the search engine. Most of the information is free, though there may be links to sites that are not free

- When you use a search engine (such as Google, Yahoo, Ask, AltaVista) you are asking it to scan its index of sites and match your keyword(s) and phrase(s) with those in the texts of documents within its database. Due to the sheer number of words indexed by search engines you may get many responses to simple search requests.
- You may get lengthy documents in which your keyword appears only once. Many may not be relevant to your topic though. Web pages found by search engines do not go through a review process. Anyone can publish their ideas. You must evaluate the site and information carefully before trusting the information. No two search engines are exactly alike in terms of:
  - Size
  - Speed and content
  - Ranking schemes
  - Search options

### **Remember** – a search engine

- Cannot think for you
- Cannot understand what you mean by your concepts or terms
- Can only match the word(s) you choose



- No single search engine can access the entire Web. The information you retrieve will depend on: The search engine(s) and the search term(s) you use. Check your search engine's home page or initial screen to find out its default or basic settings. Look for "help", "tips", "FAQs"
- Know the default settings as this may explain why your search results are not what you expected. Searching for information can be frustrating and the results overwhelming. Analyzing your topic, and then using search techniques effectively, will help you obtain the information you need for school or personal use. First take time to think about exactly what you are looking for – be specific. It may be useful to write out your topic in the form of a sentence or question to help clarify exactly what type of information you need (a) Example: If I want to research dyslexia. What about this topic are you interested in?
- Do you want to know the extent of the problem (statistics), signs/symptoms, effect on learning, how to help someone with dyslexia, what age group, etc? (b) Example: I want to research driving in the elderly population. What about this topic are you interested in? Do you want to know physical changes that affect the elderly, how many elderly still drive (statistics), any laws that limit driving based on age, pros and cons of driving after a certain age?
- Once you identify your topic break it into key concepts or points. Write down all the keywords and phrases that best describes your topic. Think of synonyms or related terms for each concept or point. Consider spelling variations as well as the singular and plural of words.
- Example: If writing about dyslexia in the adult population consider terms such as:
  - Dyslexia: reading disorder, developmental reading disorder, learning disability.
  - Adult: adults, mature individual(s)  
Example: If you are researching driving and the elderly consider these related terms:
  - Driving: drive, automobile driving, car driving, auto driving.
  - Elderly: old, aged, geriatric(s), elder, older adult, aging.
- The word(s) you use will determine the information you find. Using different words in your search may give you additional information.
- To do a basic search on most search engines type in a keyword

you have identified For example: dyslexia. This will produce the greatest number of results, though often not what you want. A multiple keyword search retrieves more specific or focused results. Example: elderly driving laws. When using a multiple keyword search, put the most important keywords first.

- Use “ ” marks around phrases to make sure they are searched exactly as is otherwise most search engines will look for each word separately. Example: “nursing care plans” vs. nursing care plans. Example: “world health organization” vs. world health organization.
- You can refine and improve your search by using different techniques to broaden or narrow your search results:

### **Search tips to refine your results**

- Use a plus sign + in front of a word to require its inclusion (no space between the sign and the word)
- A word or phrase preceded by a + must be present in the search results. Example: +newborn
- Use a minus sign – in front of a word to require its exclusion (no space between the sign and the word)

- A word or phrase preceded by a ‘-’ will exclude that word in the search results. Example: – infant
- Use lower case to find both upper and lower case versions of a word.
- Use of upper case results in only exact upper case matches.

### **Refine Search Results**

- Search tips to refine your results
- A way of connecting keywords using the “operators” AND, OR, NOT. Here’s how they work
- Use of the “operator” AND narrows your search because the results must contain all of the search terms connected by the word AND, not just one of the words. Example: heart AND lung. Example: newborn AND infant. Example: dyslexia AND adults
- Use of the “operator”OR broadens your search because the results must contain at least one of the search terms connected by the word ‘OR’. Example: heart OR lung.Example: adolescent OR teenager
- Use of the “operator” NOT excludes terms so that your results do not contain any of the terms that follow it.
- Use of NOT excludes unwanted concepts or words. Example: lung disease NOT smoking.

Here are some additional search techniques you may find useful:

- Truncation
- Wild cards

Use truncation and wildcards to search for variations in spelling and the form of a word. Examples of spelling variations can be seen in the difference between American and British spellings. Examples: pediatric vs. paediatric, orthopedic vs. orthopaedic.

- Truncation - Typing the stem, or root of a word, plus a \*, ? or \$ symbol at the end of the word will retrieve all forms of the word. Example: allerg\$ will yield allergy, allergic, allergen. Example: gastro will yield gastroenteritis, gastrointestinal, gastroenterologist
- Wildcards - Wildcard symbols such as a '?' may be inserted in place of a letter(s) in a keyword. It is useful when you are not sure of a spelling or when there are different forms of the root word. Example: women will yield both woman and women.
- The symbols used may vary depending on the database or search engine you are using
- Your search approach - **Remember:** There is no right or wrong approach. It depends on:
  - The topic you choose.
  - The time you have - but NEVER wait until the last minute!

- How exhaustive your search needs to be.

### Answers to Unit Test 5

Refer to Pupil's book page 115.

1. [www.amazon.in/Books/b?ie=UTF8&node=976389031](http://www.amazon.in/Books/b?ie=UTF8&node=976389031)
2. [www.igihe.rw/](http://www.igihe.rw/)
3. (a) Check for correct prediction  
(b) the weather will be a little bit cold, so dressing and having things like umbrella will be according to the weather.
4. (a) [http://www.answers.com/Q/What\\_is\\_the\\_solution\\_to\\_climate\\_change#slide=2](http://www.answers.com/Q/What_is_the_solution_to_climate_change#slide=2)  
(b) Move immediately to renewable energy (solar, wind, water, hydro, tidal and wave, geothermal, ocean thermal, biomass, biofuel and hydrogen)  
(c) Stop burning fossil fuels (coal, oil and natural gas) in industry, transport and the generation of electricity, which releases carbon dioxide, reforestation.  
(d) Plant billions of trees to replace our lost forests.
5. (a) Observe learner's work  
(b) Observe learner's work

(c) A chart showing division for the 2017 school year

School year periods	Dates	Duration
Second term	17/04/2017 29/07/2017	15 weeks
Second holidays	30/07/2017 13/08/2017	Vacancies 2
Third term	14/08/2017 18/11/2017	14 weeks
Primary leavers' examination	15/11/2017 17/11/2017	3 days

6. A new report predicts that sub-Saharan Africa will record the world's largest population growth between now and 2050. According to the Population Reference Bureau, the world's poorest region will more than double in population, from 1.1 billion to 2.4 billion.

### Additional activities to cater for intellectually challenged and gifted learners

You may need to assess the questions in the self-tests and the unit test and see which ones can be used for remedial teaching and which ones to be given to gifted learners. Examples are given in the table below.

Remedial activities for intellectually challenged learners	Extended activities for gifted/ talented learners
1. What is a web search engine?	1. What are the major differences between a browser and a search engine? How can they be useful to you?

<p>2. Give 4 examples of search engines.</p>	<p>2. Imagine that you have to write a paper on Zoos. Choose Yahoo and type the key word Zoos and Wildlife conservation in the search box. Then click Search. What is the search result? How many site matches did Yahoo! find?</p>
<p>3. (a) Type keywords in the search box to find an image of a lion.  (b) Click the Google Search button. Click on any images of interest. Right-click the image and choose Save Picture so as to save the image to your laptop.</p>	<p>3. Practice doing search using the Google and Lycos Search Engines. Are their results different? Write the results.</p>
<p>4. Find a website with news in your first language. What is the website address?</p>	

**Refer to Learner's Book pages 116 - 168**

### Key Unit Competency

After studying this unit, you should be able to design and construct geometric shapes using Turtle Art activity and design different projects in Scratch and use Etoys activities

that is, knowledge and understanding, skills acquisition and attitude change and values. At the end of the unit, learners should have knowledge and understanding of using programming languages and make use of turtle blocks, scratch and etoys activities.

### Learning objectives

Competency based curriculum embraces three categories of learning objectives,

**Table 6.1: Knowledge, skills and values to be attained**

Knowledge and understanding	Skills	Attitudes and values
<p>By the end of this unit, the learner should be able to:</p> <ul style="list-style-type: none"> <li><input type="checkbox"/> Identify turtle art instructions to draw cylinder, cube, cuboids and circle.</li> <li><input type="checkbox"/> Outline and use different turtle art instructions to display sound, video and text.</li> </ul>	<p>By the end of this unit, the learner should be able to:</p> <ul style="list-style-type: none"> <li><input type="checkbox"/> Construct and produce different geometric shapes using turtle art instructions.</li> <li><input type="checkbox"/> Describe instructions used to display things such as text, image or video and sound.</li> </ul>	<p>By the end of this unit, the learner should be able to:</p> <ul style="list-style-type: none"> <li><input type="checkbox"/> Conceptualise the ICT contribution in the real life.</li> <li><input type="checkbox"/> Express the desire to draw more colourful drawings using turtle arts commands.</li> </ul>

<ul style="list-style-type: none"> <li><input type="checkbox"/> State the steps followed to produce a project.</li> <li><input type="checkbox"/> Summarize a given story using animations.</li> <li><input type="checkbox"/> Recall examples to compute the area, perimeter of geometric shapes.</li> <li><input type="checkbox"/> State how to compute the sum, difference, product, quotient or average.</li> <li><input type="checkbox"/> Identify the components of Etoys environment</li> <li><input type="checkbox"/> Identify the steps and instructions of creating animations.</li> <li><input type="checkbox"/> Explain the steps to save, open, delete and rename a project.</li> </ul>	<ul style="list-style-type: none"> <li><input type="checkbox"/> Select a sprite that fit with the idea to develop a project.</li> <li><input type="checkbox"/> Organise background and sprites for a suitable project.</li> <li><input type="checkbox"/> Design and create cartoon animations according to the given topic.</li> <li><input type="checkbox"/> Compute and perform different calculations in scratch.</li> <li><input type="checkbox"/> Practice and use the components of Etoys window.</li> <li><input type="checkbox"/> Create Etoys book containing text, images and animations.</li> <li><input type="checkbox"/> Create and design animations.</li> <li><input type="checkbox"/> Perform saving, opening, deleting and renaming of Etoys projects.</li> <li><input type="checkbox"/> Analyse the different projects and develop criticism spirit.</li> </ul>	<ul style="list-style-type: none"> <li><input type="checkbox"/> Develop positive attitudes towards the environment, mechanics and blacksmith tools production.</li> <li><input type="checkbox"/> Use mechanics and blacksmith tools safely.</li> <li><input type="checkbox"/> Show creativity for designing and creating more projects reflecting the real life experiences.</li> <li><input type="checkbox"/> Support the idea by developing a convincing project.</li> <li><input type="checkbox"/> Appreciate the way of expressing the ideas through projects, animations and Etoys book.</li> <li><input type="checkbox"/> Appreciate the importance of using Etoys book.</li> <li><input type="checkbox"/> Show concern of keeping projects.</li> <li><input type="checkbox"/> Be proud to arrange commands and produce animations.</li> </ul>
--	---	--

## Pre-requisites of this unit

In primary 4, learners practised turtle art and scratch activities. They learnt about the various features of turtle art and scratch windows and practised drawing using turtle art and creating simple animations using scratch. At this level learners are expected to further their knowledge in these areas by practising using turtle art to display various things including images and videos and carrying out slightly more advanced animations using scratch and etoys programs. Further let learners understand the fact that this unit has connections with creative writing in English as learners need to think about stories to animate and geometric shapes in mathematics.

### Background information

A program is a set of instructions that tells a computer or other electronic devices what to do. These instructions or commands are written in an artificial (i.e. non-speaking) language. The script used is often referred to as *code* or *computer code*. *Computer programming* or *coding* is the process of writing codes. In this unit you will teach how to use different programming languages in Turtle art, Scratch and Etoys. It is very important for the learners to understand how

to use them in different ways as this may form their careers in computer programming in future.

## Cross-cutting issues to be addressed

### 1. Peace values and gender education

As learners perform the activities in the learner's book, encourage them to be careful not to hurt each other or themselves with the computers.

### 2. Standardization culture

Encourage learners to always ensure they use authentic external and internal devices on computers. Also, encourage them to always buy original computers, their parts or accessories.

### 3. Financial education

Learners must ensure that they handle Laptops with care. Repairing or buying a new Laptop can be very expensive.

### 4. Gender education

Emphasize to learners that anybody irrespective of their gender can pursue a career in computer science. Give examples of role models who are successful IT experts/technicians in the area where the learners come from.

### 5. Inclusive education

All learners should be encouraged to participate during lessons and



practicals. Special arrangement should be done to take care of learners with special needs. For example, provide brail for blind learners, large print text for those with sight problems and allocate physically challenged learners to others to assist them during field trips and practical activities. Further, this category should be given tasks that they can manage during the practical sessions.

### **Generic Competences**

#### **1. Co-operation and interpersonal management and life skills**

During group discussions and group interactions - let learners engage one another by giving a chance for all to participate. Also, during group presentations - you can allow rotational presentations within the group members. Gifted learners should help in coming up with presentation content as slow learners contribute. **REMEMBER** You should allow slow learners to do presentations as well and correct them where they go wrong. Advise learners to appreciate the different abilities of their group members and accommodate each other's views.

#### **2. Research skills**

Guide learners to make successful internet searches using the various search engines. Further, guide

learners on how to come up with summarized notes from a large body of text.

#### **3. Communication in English**

Communication in English will be improved when learners freely participate in the discussions and presentations. Encourage all learners irrespective of their abilities to participate in group discussions, during presentations by asking questions and during question and answer sessions to either introduce or wrap up the lessons.

#### **4. Critical thinking**

Guide learners to discover for themselves the differences between search engines and their uses. This competence will also come about as learners think about their research findings and as they give out their suggestions on why certain things are the way they are.

#### **5. Lifelong skills**

The skills acquired in programming can be used in future while at work or when doing job related programming or networking. This topic area can also lead to careers such as IT specialists and technicians, graphic designers or computer programmers therefore learners should be encouraged to take it seriously.

## Key words in this unit and their meanings

- **Program** - A program is a set of instructions that tells a computer or other electronic devices what to do.
- **Project** - is a series of activities that allows the students to study, do research and act by themselves using their abilities, interests, personal experience and aptitudes.
- **Sprite** - is an animated character or object in scratch programme.
- **Costume** - A costume is one out of possibly many “frames” or alternate appearances of a sprite. They can be named, edited, created and deleted, but every sprite must have at least one costume.
- **Background** - The Stage is the term for the background of the project, but can have scripts, backdrops (costumes), and sounds, similar to a sprite.
- **Animation** - the state of being full of life or vigour, liveliness. An animation project is a project that is an animation, short movie (often humorous), or music video. Animation can involve programming sprites that talk and interact.

## Guidance on the problem statement

This topic is about Programming for children. Computer programming is the art of writing computer programs, which are a sequence of instructions written using a Computer Programming Language to perform a specified task by the computer. Computer Programming is fun and easy to learn provided you adopt a proper approach.

This topic attempts to cover the basics of computer programming using a simple and practical approach for the benefit of new learners. You will build from turtle arts, which pupils learnt in Primary 4 and 5 to introduce this unit. Refer learners to the picture on page 116 of their books and the conversations going on. It shows pupils watching a cartoon programme with their father. The pupils seem to be amazed. One of them is interested in making his own cartoons when he grows up. The father intervenes and tells him that it is possible for him to make some even now at his age. Let the learners brainstorm about how the kid can make his dream come true - the answer lies in learning computer programming!

## Attention to special educational needs

Support for Multi-ability learning	Support for special needs learning
<ul style="list-style-type: none"> <li>▪ <b>Peer-teaching</b> – engage high achievers to help weak pupils in understanding of concepts.</li> <li>▪ Plan remedial teaching for slow learners.</li> <li>▪ Allow enough time to slow learners to complete their work.</li> <li>▪ Gifted learners to be given heavy tasks requiring more critical thinking while slow learners are given tasks, which they can manage such as collecting materials for use during practicals among others.</li> <li>▪ Both gifted and slow learners to be given equal opportunity to lead in group discussions and to do presentations of group findings to the rest of the class.</li> <li>▪ Ensure all learners respect other's views irrespective of their shortcomings or talents.</li> </ul>	<ul style="list-style-type: none"> <li>▪ Identify the learners with hearing and visual impairment and have them sit in front of the class so that proper attention can be given to them. Also, large print texts should be given to visually impaired learners and hearing aids provided for those with hearing impairment.</li> <li>▪ Arrange the room such that it will enable easy movement for the physically challenged learners.</li> <li>▪ Assign some students to be in charge of the physically and visually impaired learners. For example, carrying their equipment, showing them around during the field trips, etc.</li> <li>▪ Organize Braille for blind learners.</li> <li>▪ Encourage special needs learners by reminding them that 'disability is not inability'!</li> </ul>

### List of lessons

Lesson No.	Lesson title	No. of Periods
1.	Turtle art for displaying things	2
2.	Drawing irregular polygons in turtle art	3
3.	Creating a scratch project	3
4.	Working with stage in Scratch	3
5.	Creating animated stories in Scratch	3
6.	Computing in mathematics using Scratch	3
7.	Identification of elements of Etoys window	2
8.	Etoys book	3
9.	Etoys projects and animation	3

## LESSON 1: Turtle art for displaying things

Refer to learner's book pages 117-120.

### Specific objectives

By the end of the Lesson, learners should be able to:

- Describe instructions used to display things such as text, images or video and sound.
- Outline and use different turtle art instructions to display sound, video and text.

### Preparation for the lesson

- This lesson will involve a number of practical activities and discussion work, you will therefore organize the class as need arises during the lesson. **REMEMBER:** When grouping learners, you should consider the different abilities of learners and the special needs for various individuals.
- Prepare the laptops to be used and arrange the classroom to facilitate learning and moving around.
- Collect pamphlets, handouts and textbooks for reference in class.

### Teaching aids

- XO laptops or any other computers

- Pamphlets, handouts and textbooks

### Pre-requisites of this unit

- Introduce the unit as explained under guidance on the problem statement above then narrow down to the lesson.
- Ask learners to switch on their laptops and open Turtle blocks activity.

### Teaching / learning activities

- You may begin the lesson by letting learners know that turtle blocks can also be used for displaying text, numbers, sounds and videos. Inform them that they are going to experience this by carrying out a number of activities.

### Activity 6.2 (Refer to Pupil's book pages 118 - 119)

- Guide learners to perform this activity individually with their computers.
- They should then run the program and see what happens.
- Next, learners should practice displaying images and capturing images using the webcam camera.

### Activity 6.3 (Refer to Pupil's book pages 119 -120)

- Guide learners try the commands given in their XO – laptops. Allow

them to run the program and see the outcome. Did they listen to the sound produced?

- At this point, introduce the other command 'print' that can as well be used to display things. Let learners know that it is possible to use both 'print' and 'show' to display things together.
- Let learners practice with the commands Activity 6.4 in pupil's book page 120.
- Summarize the lesson by highlighting the key points, which should include the way of arranging commands in drawing shapes and allowing learners to write short notes.

### Synthesis

The lesson introduces learners to the turtle art for displaying things. The activities carried out during the lesson should help learners identify the various ways of using different blocks to display text, images, sounds or videos.

### Lesson assessment

Assess whether the learning objectives of the lesson were met by asking questions such as:

1. What did you learn in this lesson? (Ans: *How to use turtle art for displaying things*).
2. (a) What are the commands that can be used in displaying images or text? (Ans: 'show', 'print')

- (b) Practise displaying images and text using these commands in your XO laptop.

## Lesson 2: Drawing Regular polygons

Refer to learner's book pages 121-122

### Specific objectives

By the end of the lesson, learners should be able to:

- Identify turtle art instruction to draw cylinders and cuboids.
- Construct and produce different geometric shapes using turtle art instructions.

### Preparation for the lesson

- This lesson will involve a number of practical activities and discussion work, you will therefore organize the class as need arises during the lesson. **REMEMBER:** When grouping learners, you should consider the different abilities of learners and the special needs for various individuals.
- Prepare the laptops to be used and arrange the classroom to facilitate learning and moving around.
- Collect pamphlets, handouts and textbooks for reference in class.

### Teaching Aids

- XO laptops or any other computers
- Pamphlets, handouts and textbooks

## Pre-requisite of the lesson

- Ask probing questions to introduce the lesson. Such questions may include:

(i) *What is a polygon?*

(Ans: *is a plane figure with at least three straight sides and angles*)

(ii) *Give examples of polygons.*

(Ans: *Examples are cube, cylinder, cuboid among others*)

(iii) *Differentiate between regular and irregular polygon?*

(a) *Regular polygon is a polygon that is equiangular*

*(all angles are equal in measure) and equilateral (all sides have the same length)*

(b) *An irregular polygon is any polygon that is not a regular polygon. It can have sides of any length and each interior angle can be any measure.*

- Build on this then introduce this lesson which is about using turtle arts blocks to construct regular polygons.

## Teaching / learning activities

### Activity 6.5 (Refer to Pupil's book page 121)

- Allow learners to study the polygon. Let them say what it is and come up with commands to draw it in pairs. Guide them accordingly. Let them write the commands down in their notebooks.
- Further, guide learners to practice

and run the commands on page 122 in their laptops. What shape did the commands give? Let them discuss.

- Ask learners how they can arrange commands and draw a parallelogram. Let them write the commands down and try it using their XO laptops.
- Summarise the lesson by highlighting the key points on how better they can draw different regular polygon in turtle art. Refer to the notes in Pupil's book pages 121-124.

## Synthesis

This lesson introduces learners to drawing irregular polygons in turtle art. Guide learners to come up with and use the commands to draw different polygons.

## Lesson assessment

Assess whether the learning objectives of the lesson were met by asking questions such as:

1. Draw the following shapes in turtle art/blocks.
  - (a) A cube
  - (b) A circle
  - (c) A cylinder

(Ans: *Assess learner work as lesson progresses and award marks accordingly*)
2. Give examples of irregular polygons. (Ans: *cuboids and cylinders*)

## Lesson 3: Creating a scratch project

Refer to learner's book pages 124

### Specific objectives

- By the end of the lesson, learners should be able to select a sprite that fit with the idea to develop a project, and identify any sprite and scene with each step of project

### Preparation for the lesson

- This lesson will involve a number of practical activities and discussion work, you will therefore organize the class as need arises during the lesson. **REMEMBER:** When grouping learners, you should consider the different abilities of learners and the special needs for various individuals.
- Prepare the laptops to be used and arrange the classroom to facilitate learning and moving around.
- Collect pamphlets, handouts and textbooks for reference in class.

### Teaching Aids

- XO laptops or any other computers
- Pamphlets, handouts and textbooks

### Introduction to the lesson

- Learners already came across scratch program in Primary 4 & 5. Ask probing questions such as:

(i) What is scratch program?

(Ans. One of the programs in XO laptop used for animation).

(ii) What is a sprite?

(Ans: Is an animated character or object in your programme).

(iii) How do you get the sprite?

(Ans. By choosing from the file, by drawing, by taking photos)

### Teaching / learning activities

#### Activity 6.9 (Refer to Pupil's book page 124)

- Ask learners to switch on their laptops, open scratch activity and practice the the commands in this activity.
- Let them run the program and see what happens.
- Guide learners to understand that in scratch, it is possible to use existing sprites or create your own, make them move and create a scene.
- Demonstrate the above by guiding learners to create a scratch project as shown in Activity 6.10. page 125 of pupils book.

#### Activity 6.10 (Refer to Pupil's book pages 125)

- Ask learners to open a scratch program in their XO laptop. Guide them to use the commands provided to create a cat animation. They should then test the program if it is working.

- Guide learners on how to create their own project by going through the steps highlighted in pages 128

### Activity 6.12 (Refer to Pupil's book pages 126)

- Guide learners to carry out this activity in groups depending on the size of the class and learner abilities. Let learners share their work with other members. Correct their work as is appropriate.
- Summarize the lesson by highlighting the key points on the different ways of choosing a sprite and how we give movement to a sprite and create animations. Allow learners to write summary notes as you do your presentation.

### Synthesis

- This lesson introduces learners to programming animation. Use the suggested practical activities and examples given to guide learners to come up with beautiful animations of their own in scratch.

### Lesson assessment

- Assess whether the learning objectives of the lesson were met by asking questions such as:
  1. (a) What are the steps to follow when you want to make a dog run?  
(b) Write a program to make a

dog run.

*Ans:(a) – choose a sprite from the file (a dog) after choosing a sprite, go to script area and start find in the commands to make the dog run.*

(b) Sample program is as follows:

- When clicked
- Move 9 steps
- Next costume
- Wait 0.2 secs
- If on edge bounce
- Forever

2. Write the steps to save a project in scratch? (*Ans: Go to file-save as-give a name and click on save*)

### Lesson 4: Working with stage in scratch

*Refer to learner's book pages 130*

#### Specific objectives

By the end of the lesson, learners should be able to organise background and sprites for suitable projects.

#### Preparation for the lesson

- This lesson will involve a number of practical activities and discussion work, you will therefore organize the class as need arises during the lesson. **REMEMBER:** When grouping learners, you should consider the different abilities of



learners and the special needs for various individuals.

- Prepare the laptops to be used and arrange the classroom to facilitate learning and moving around.
- Collect pamphlets, handouts and textbooks for reference in class.

### Teaching Aids

- XO laptops or any other computers
- Pamphlets, handouts and textbooks

### Pre-requisite of the lesson

- You may begin this lesson by reminding learners what they learnt in the previous lesson. Let them recall the procedure they used to animate the cat.
- At this point, you can ask them how the background of their animation was and whether they think it can be made better. Also, ask them whether the cat or sprite was moving or not and whether the movement can be improved.
- Build on learner responses to above questions to introduce this lesson.

### Teaching / learning activities

X,Y Co-ordinates (Refer to Pupil's book page 133 - 135)

- You may then inform learners that this lesson is about manipulating the stage. Let learners know that for them to manipulate the stage

better, they must know the x,y – co-ordinates of the stage.

- Put learners in pairs considering their abilities. Let them carry out this activity.
- Guide them to move the sprite about and place a cursor at a point as they write the x and y co-ordinates of that point.
- Explain the fact that the x and y co-ordinates are used to locate or specify the position of the sprite. Refer to the content in learner's book page 135. Re-inforce these by way of a demonstration. Give a further activity on determining the position of a sprite.

### Activity 6.15 (Refer to Pupil's book pages 130)

- Next, let learners know that there is need to bring some life to the background of a sprite. This will make the stage beautiful and more attractive.
- Guide learners to carry out this activity. They should at the end run the program and see what happens.

### Activity 6.16 (Refer to Pupil's book pages 133)

- By the end of previous activity, the cat was stationary. It is important to make the cat move in order to bring some life to the whole animation.

- Learners should make the cat jump up and down as opposed to the previous scenario where it was stationary. Let learners carry out this activity in groups depending on size and learners ability.
- Input the commands shown in your XO - laptop then run it. What can you see?
- Save your program file with the name 'cat jumps'. The file will be saved in the scratch default folder present in the XO - laptop.
- Wrap up this lesson by giving learners additional activities, for example the further activity on page 135 of pupil's book.

### Synthesis

This lesson introduces learners to the movement of sprites and changing background. Use the suggested activities and the demonstrations to explain these concepts to learners. Also, encourage learners' to take this topic seriously as it can lead to careers such as graphic design and programming.

### Lesson assessment

Assess whether the learning objectives of the lesson were met by asking questions such as:

1. In scratch make a cat animation and make the cat change colour while moving.
2. By choosing a sprite from file, make an animation of boys in parade at the national stadium, put the sound of the drum in their parade.
3. Write the commands which made animations in question 2. (Ans: Assess learner answers and award marks accordingly).

### Lesson 5: Creating animated Stories in scratch (To be covered in three periods)

Refer to learner's book pages 135 -145

### Specific objectives

By the end of the lesson, learners should be able to:

- Identify the steps and instructions of creating animations.
- Summarise a given story using animations.

### Preparation for the lesson

- This lesson will involve a number of practical activities and discussion work, you will therefore organize the class as need arises during the lesson. **REMEMBER:** When grouping learners, you should consider the different abilities of learners and the special needs for various individuals.

- Prepare the laptops to be used and arrange the classroom to facilitate learning and moving around.
- Collect pamphlets, handouts and textbooks for reference in class.

### Teaching Aids

- XO laptops or any other computers
- The diagrams on table 6.1 page 138 of pupil's book.

### Introduction to the lesson

- By now, learners' have a rough idea of how to choose a background and various sprites.
- Let learners know that in this lesson, they will create a storyline and animate it. The way to go is to first create their own sprites using paint editor.
- Give them a small activity to draw in their notebooks a donut, a house and a boy.
- Let them try drawing these figures using paint editor in their XO- laptops. Guide them as is appropriate. Then after, ask learners to switch on their laptops and open scratch activity.

### Teaching / learning activities

The learning here will involve going through steps 1–7 of creating an animated story and carrying out activity 6.18 pupils book pages 135-143

- Guide learners to read and understand the story line on page 139 of their book. You can then go through the steps of creating animations as described in pupil's book pages 135– 143.
- In paint editor assist learners to draw Mr Meow, Donut man and Dounut.
- Assist learners to create the scripts from the story line and choose a suitable background for it. You will also need to add scripts for movement.
- Do a demonstration, then let learners follow the steps to create, save and test their scratch project.
- You can then let learners carry out. Further activity page 143 in their books. Assess learner work and guide them in doing corrections as is appropriate.
- Summarise the lesson by highlighting key points about creating stories and animating them. Let learners take summary notes. Better still, you can appoint a gifted learner to give summary points as you guide them. Refer to the notes in Pupil's book pages 135-143
- **Synthesis**

This lesson involves how to make animations by creating a story line. Learners through the guidance in the pupils' book, they should be able to use paint editor correctly, be able

to select different and appropriate backgrounds and also be able to use the scripts and make animation.

### Lesson assessment

Assess whether the learning objective of the lesson was met by asking questions such as:

1. What is a paint editor?  
(Ans: The Paint Editor in Scratch allows you to design and or edit the costumes of sprites and backgrounds of the Stage)
2. Draw a girl skipping the rope and make the script to make a movement and animation.  
(Ans: Assess learner work and award marks accordingly)
3. What is a script area?  
(Ans: The Scripts Area is where scripts can be assembled. The Scripts Area is the area on the right side of the project editor where scripts are assembled. It can be accessed from both the Stage and from sprites, although the Stage and each sprite all have separate scripts areas and scripts)

**Lesson 6: Computing in Mathematics using Scratch**  
(To be covered in three periods)

Refer to learner's book pages 147-155

### Specific objectives

By the end of the lesson, learners should be able to:

- Recall examples to compute the area, perimeter of geometric shapes.
- State how to compute the sum, difference, product quotient or average.
- Compute and perform different calculations in scratch.

### Preparation for the lesson

- This lesson will involve a number of practical activities and discussion work, you will therefore organize the class as need arises during the lesson. **REMEMBER:** When grouping learners, you should consider the different abilities of learners and the special needs for various individuals.
- Prepare the laptops to be used and arrange the classroom to facilitate learning and moving around.
- Collect pamphlets, handouts and textbooks for reference in class.

### Teaching Aids

- XO laptops or any other computers

### Pre-requisite of the lesson

- You may begin this lesson by asking probing questions on

mathematical operations like: How do you calculate the area of a rectangle? Write the formula of calculating the perimeter of a rectangle etc.

- You can then let learners know that in this lesson, they are going to learn about determining angles and shapes, calculating areas and perimeters and calculating averages using scratch.

### Teaching / learning activities

#### (a) Using scratch to draw shapes and angles

#### Activity 6.19 (Refer to Pupil's book pages 144)

- Put learners in pairs considering their abilities. Let them carry out this activity by following the instructions given in the pupils' book. Let them identify the shape and angles. They should also find out how to draw this shape in scratch activity.
- Ask learners to switch on their computers and switch on scratch activity. Guide them to input the commands in this activity.
- Let them run the program and see the shape that comes out. At this point, you can tell learners that it is possible to come up with a simpler command using the repeat loop that can do the same thing as the one above. Let them run this program in their computers and see the shape that comes out.
- Allow learners to try out different

commands and see the shape that comes out. They should compare their work to those of other learners.

- Summarise this section by highlighting key points about as learners take summary notes. Better still, you can appoint a gifted learner to give summary points as you guide them.

#### (b) Using scratch in calculations

Let learners know that scratch can also be used to carry out calculations. Such calculations include performing subtractions, additions, multiplications and calculating areas and averages.

#### Activity 6.20 (Refer to Pupil's book pages 147)

- In order to calculate area of a rectangle, you need to create two variables i.e. length (L) and width (W). You can then guide learners how to make variables and set length and width. Guide learners on how to do this then guide them to input this data in scratch.
- Let them repeat this several times till they master. They should come up with the area of the rectangle by running the program.
- Give them additional activity of calculating the perimeter of the rectangle. They should use the formula:  $P = 2(L+W)$

### (c) Using scratch to compute

#### average

- Guide learners to calculate the average by following the guidelines in the learners' book page 148. Ask if they are aware the average can be done in scratch.
- Let them aware that just like in area, there is need to create variables before computing average. This is the first step. Refer to page 148 of pupil's book for an explanation of the variables.
- Refer to content on page 155 on how to create the variables. Let learners create all the variables and input them in scratch.
- The next step is to create the program. The program has three parts namely:
  - *the part that allows you to insert values (N).*
  - *the part that prompts inputting of numbers.*
  - *the part that computes the average.*
- Guide learners to identify these parts in Fig. 6.7 on page 149. They should then open a scratch activity and input the instructions to determine the average of 14,15 and 16. Let them run the program and see the average obtained.
- Let learners compare their work with that of the rest of the class

members.

- Wind up the lesson by giving learners a task to calculate average of a set of numbers. Refer to further activity on page 156 of pupil's book.
- Summarise the lesson by highlighting the key points about calculating the area, perimeter, average and drawing different shapes in scratch as learners write short notes. Refer to the notes in Pupil's book pages 154 – 156.

### Synthesis

This lesson introduces learners to computing using scratch. Through demonstrations and practical activities, guide learners to draw different shapes using scratch programming language, and also to calculate area, perimeter and average of a set of data.

### Lesson assessment

Assess whether the learning objectives of the lesson were met by asking questions such as:

1. Identify the formula for calculating the area of a rectangle.  
(Ans:  $area = length \times width$ )
2. Which scripts would you use to draw a square?

(Ans: When clicked, Clear, Pen down, Repeat 4, Move 100, Turn right 90)

## Lesson 7: Identification of elements of Etoys environment

Refer to learner's book pages 151

### Specific objectives

By the end of the lesson, learners should be able to:

- Identify the components of Etoys environment
- Practice and use the components of Etoys window

### Preparation for the lesson

- This lesson will involve a number of practical activities and discussion work, you will therefore organize the class as need arises during the lesson. **REMEMBER:** When grouping learners, you should consider the different abilities of learners and the special needs for various individuals.
- Prepare the laptops to be used and arrange the classroom to facilitate learning and moving around.
- Collect pamphlets, handouts and textbooks for reference in class.

### Teaching Aids

- XO laptops

- Textbooks, pamphlets and hand outs.

### Introduction to the lesson

- Remind learners about what they have learned in previous lessons about programming languages. i.e. Turtle art/blocks and Scratch activities. Let them understand that in this lesson, they will learn about another programming language called **Etoys**.

### Teaching / learning activities

#### Activity 6.21 (Refer to Pupil's book page 151)

- Begin this lesson by letting learners input the commands in this activity in their XO laptops. Let them run the program and say what shape is produced. Ask them whether they think the shape can be produced in a better way. The answer is: yes – using Etoys program.
- At this point, you can define what etoys is i.e. a kind of program that allows joining together of code snippets that have been written to create interesting motions, games, videos, etc.

**(Refer to Pupil's book page 158-159)**

- Begin this lesson by letting learners observe carefully the Etoys window and try to identify different tools. Let them draw the window in their notebooks and label the various parts.
- At this point, let learners log onto their computers and open Etoys program. Ask them to study the window that pops up and compare it to what they saw in activity 6.17.
- Guide learners to describe what they have seen. Ask probing questions such as: What toolbars can you see, give their names? (*Ans: navigator bar, automobile, three colored clouds and the script*). How is etoys screen called? (*Ans: The world*)
- Ask learners to describe the etoys window using their own words.
- Summarise the lesson by highlighting the key points about Etoys window as learners write short notes. Refer to the notes in Pupil's book pages 151 - 152.

**Synthesis**

This lesson is about creating awareness and understanding the etoys programming and its use. Learners through demonstration and through manipulating different activities should appreciate the use

of etoys. They should also be able to navigate and understand the use of etoys environment. Further, this is a very interesting area involving careers such as graphic design, animations and computer programming therefore learners should take the lesson seriously.

**Lesson assessment**

Assess whether the learning objective of the lesson was met by asking questions such as:

1. Name some important elements in etoys window.  
(*Ans: navigator bar, clouds, automobile, script*)
2. What general name do we give to etoys window? (*Ans: the world*)
3. How can we use etoys?  
(*Ans: Etoys can be used in making your own games, multimedia presentation, computer art, animated story books, computer simulations and many others*)

**Lesson 8: Etoys book**

Refer to learner's book pages 156 - 161

**Specific objectives**

By the end of the lesson, learners should be able to create etoys book containing text, images and animations.

**Preparation for the lesson**

- This lesson will involve individual work, video watching, and group



activities.

- Prepare the laptops to be used and arrange a classroom to facilitate learning and moving around.
- Collect pamphlets, handouts, and textbooks for reference in class. Also, ensure that the Internet is working if you have a computer laboratory or any other form of Internet connectivity such as WIFI or modem.

### Teaching Aids

- XO laptops or any other computers

### Pre-requisite of the lesson

- You may begin this lesson by asking learners to describe the etoys environment and tools. Let them open supplies option and observe carefully the tools.
- Inform learners that the book is the most important and useful object in etoys. The book can be used to do slide shows, organise class diaries, develop albums, register observations or even create animations.

### Teaching / learning activities

#### Activity 6.22 (Refer to Pupil's book page 153)

- Let learners open etoys activity, and open etoys book. Assist learners to view and describe the tools available in 'Supplies option' and their uses.
- Guide learners to do activity 6.24 on page 155 of pupils book by practicing creating etoys book

and add a text.

- Through your guidance, let learners practice adding text, a drawing to the book, and paint a background using paint toolbar.
- Test the link: <https://www.youtube.com/watch?v=Zbem3iKl5NE>. This link has a video on creating a book and adding some images. Let learners study it and practice what they see.
- Guide learners to carry out activities 6.23 and 6.24 pages 155-156 in the pupil's book. Did their work look like the picture After the presentations, guide learners to write short notes in their created book and write the main points in their notebooks. Refer to Pupil's book pages 155 – 159.
- Summarise the lesson by giving learners a task of coming up with a created diary and adding an image in etoys book.

### Synthesis

- This lesson introduces the use of a book in etoys. Learners would understand the various components in supplies option, and be able to create a book, add a text and also add a drawing. Learners can create class diaries, albums or slide shows in etoys book.

### Lesson assessment

Assess whether the learning objective of the lesson was met by asking questions such as:

1. What is an etoys book?

(Ans: A book is a multi-page structure for creating texts, presentations, and the like by dropping in other objects, with controls for adding or removing pages and for navigating).

2. Identify two ways of getting image for the book.  
(Ans: By drawing in paint editor and by importing from the laptop)
3. What is 'halo' in etoys?  
(Ans: A halo is a set of controls that let you make changes to objects in etoys)
4. Identify the tools found in supplies option.  
(Ans: Sound recorder, rectangle, eclipse, star, book and holder)
5. Using paint toolbars, draw a star in etoys.  
(Ans: Assess student work and award marks accordingly)

## Lesson 9: Etoys Projects and Animation

Refer to learner's book pages 158 - 167

### Specific objectives

By the end of the lesson, learners should be able to:

- Identify the steps and instructions of creating animations in etoys.
- Explain the steps to save, open, delete and rename a project.
- Perform saving, Opening, deleting

and renaming of Etoys project.

- Analyze the different projects and develop criticism spirit.

### Preparation for the lesson

- This lesson will involve individual work, video watching, and group activities. You will therefore organize the class as need arises during the lesson. **REMEMBER:** When grouping learners, you should consider the different abilities of learners and the special needs for various individuals.
- Prepare laptops or computer lab if available.
- Bring reference textbooks to class. Also, ensure that the Internet is working if you have a computer laboratory or any other form of Internet connectivity such as WIFI or modem.
- Test the link: [https://www.youtube.com/watch?v=xMDYf3\\_uovk](https://www.youtube.com/watch?v=xMDYf3_uovk) in advance to see if it is working. This link has a video on creating animation projects in etoys.

### Teaching Aids

- XO laptops or any other computers.
- Video link: [https://www.youtube.com/watch?v=xMDYf3\\_uovk](https://www.youtube.com/watch?v=xMDYf3_uovk).

### Pre-requisite of the lesson

Ask probing questions to introduce the lesson. Such questions may include:

- What is the etoys book? (Ans: is a multi-page structure for creating texts, presentations)

- How do you add an image in the book? (*Ans: just drag it and drop over the book*)
- How do you add a text in a book? (*Ans: open supplies box and look for the Text object*)
- Build on the answers to the questions to inform learners that in the lesson, they will create animation projects in etoys.

### Teaching / learning activities

- Let the learners watch the video above carefully. They should describe what is happening in the video.
- After watching the video, learners now have a rough idea of how to go about creating an etoys animation project.
- Take learners through the steps of creating the animation project as explained in pupil's book pages 157 – 166.

### Activity 6.26 (Refer to Pupil's book pages 158)

Guide learners to practice drawing a car, let them follow the steps as highlighted in the pupils' book.

### Activity 6.27 (Refer to Pupil's book page 159-160)

- Assist the learners to view the properties of the car using the handles as explained here.

### Activity 6.28 & 6.29 (Refer to Pupil's book page 160- 162)

- Assist learners to experiment on moving a car fast or slow. Follow the steps from the pupils book page 158-163

### Activity 6.30 (Refer to Pupil's book page 163-164)

- In this activity help learners to continue building their project by creating a steering wheel then fixing it onto the car and using it.

### Activity 6.31 (Refer to Pupil's book page 164)

- Guide learners to try different effects on their project, they should also perform saving their projects and opening it.

### Activity 6.32 (Refer to Pupil's book page 165)

- Guide learners to perform this activity and see the effect of changing the specifications on the performance of the car.
- You can then let learners know that after finishing the project, they need to publish it. this is same as saving the project.
- Summarise the lesson by highlighting the key points on how to draw the car step by step. Refer to the notes in Pupil's Book pages 151 – 166 Allow learners to write summary notes as you do your presentation. You can also make

this more interactive by inviting gifted learners to do lesson summary as you guide them.

### Synthesis

- This lesson introduces learners to create projects and animations in etoys. Use the video and the practical activities highlighted help learners practice coming up with beautiful etoys animations and projects. Learners should be able to make the animations, open existing projects, save and/or delete a project in etoys.

### Lesson assessment

- Assess whether the learning objectives of the lesson were met by asking questions such as:
1. How do you add an image to the book?  
(Ans: Drag it and drop over the book).
  2. Create a human head in etoys with eyes and mouth that moves.  
(Ans: Assess learner work and award marks accordingly)

### Answers to Self-Test 6.1

Refer to learner's book page 123

1. Text, numbers, sound, images, videos.
2. Regular polygons have equal angles and lengths of sides,

irregular polygons do not.

3. Cube, cuboid, rectangle, square.
4. Practical activity – assess learner work then award marks accordingly.
5. Practical activity – assess learner work then award marks accordingly.
6. Practical activity – assess learner work then award marks accordingly.

### Answers to Self-Test 6.2

Refer to learner's book page 151

1. An object in Scratch which performs functions controlled by scripts.
2. Because every program is made of sprites and the scripts (instructions) that control them.
3. Practical activity – assess learner work then award marks accordingly.
4. (a) The “X position” value determines the horizontal location of the sprite and the “Y position” value determines the vertical location or height.  
(b) i. moves sprite horizontally

- left
- (ii) moves sprite vertically up
5. (a) Create a story line,  
(b) Create sprites  
(c) Create scripts  
(d) Create a simple scene  
(e) Add movements  
(f) Save your projects  
(g) Test
  6. Area, perimeter and average.

### **Answers to Self-Test 6.3**

*Refer to learner's book page 167*

1. World
2. Navigator bar, three colored clouds, an automobile that travels around and the script that controls the car's movement.
3. Halo is a set of tools provided for each object. Right-clicking the object brings up a halo like this one.
4. Right click your mouse over the object then click on viewer handle to see a set of script tiles.
5. Size ,color, location, and direction.
6. Script is a sequence of

instructions, which is interpreted by another program.

7. The heading indicates at what angle the object is rotating. It will turn right.

### **Summary of the unit**

This unit is about learners gaining knowledge, understanding and skills of programming languages. You should have effectively used the suggested activities and the teaching approaches in the teacher's book to help learners acquire this competence. At the end of the lessons, you should assess the extent to which the competency was achieved and plan remedial activities where necessary. Remember, one of the attitudes and values intended at the end of the topic are for learners to conceptualise the ICT contribution in the real life. Guide learners to acquire the intended skills as is appropriate.

### **Additional Information for the teacher**

**Turtle Art/Blocks** is a fun activity in which you learn how to command a little turtle to draw shapes, pictures and designs. It is an off shoot of the Logo programming language and

is intended for children as young as from 6 years old to learn about programming and debugging.

They can play with Turtle Art to draw colourful art patterns using the turtle that accepts instructions for movement. You program with Turtle Art by snapping together blocks. Each block is a command for the turtle, e.g., there is a block to tell the turtle to go forward, to turn right, etc. The blocks are organized on palettes: one for the turtle, one for the pen, etc. Start by clicking on the turtle to show the turtle palette. Try dragging blocks from the palette onto the turtle canvas. Click on them to see what they do.

**Scratch** is a programming language and an online community where children can program and share interactive media such as stories, games and animation with people from all over the world. As children create with Scratch, they learn to think creatively, work collaboratively and reason systematically. Scratch is designed to be fun, educational, and easy to learn. It has the tools for creating interactive stories, games, art, simulations, and more, using block-based programming. Scratch even has its own built-in paint editor and sound editor.

Users program in Scratch by dragging blocks from the block palette and attaching them to other blocks like a jigsaw puzzle. Structures of multiple blocks are called scripts. This method of programming (building code with blocks) is referred to as “*drag-and-drop programming*”.

**Etoys** on the other hand is;

- An educational tool for teaching children powerful ideas in compelling ways.
- A media-rich authorising environment and visual programming system.
- A free software program that works on almost all personal computers.
- Etoys makes children active participants, gives immediate feedback and rewards, and allows students to pursue their own interests in building projects. Young children learn best by experimentation and play. In etoys, kids are trained to grasp, drop, stack, and smash the world around them, often without adult encouragement. Etoys makes abstractions more palpable, allowing children to visualize and explore new ideas.

### ***Answers to Unit Test 6 (Pupil's book pages 168)***

Assess learners work and award marks as is appropriate. The learner should have shown high level of creativity in order to earn maximum marks.

## Additional activities to cater for intellectually challenged and gifted learners

- You may need to assess the questions in the self-tests and the unit test and see which ones can be used for remedial teaching and which ones to be given to gifted learners. Examples are given in the table below.

<b>Remedial activities for intellectually challenged learners</b>	<b>Extended activities for gifted/ talented learners</b>
1. Self Test 6.1 Questions 1, 2 and 3	1. Self Test 6.1 Questions 4, 5 and 6
2. Self Test 6.2 Question 1, 2, 4 and 6	2. Self Test 5.2 Question 3 and 5
3. Unit Test 6 Questions 1, 2 ,3, 5 and 8.1	3. Unit Test 6 Questions 4, 5 and 7

**Refer to Learner's Book pages 169 - 175**

## Key Unit Competency

After studying this unit, learners should be able to explain the phenomenon of air pollution, its consequences and management.

## Learning objectives

Competency based curriculum embraces three categories of learning objectives,

that is, knowledge and understanding, skills acquisition and attitude and values.

At the end of the unit, learners should have knowledge and understanding of air pollution and have the right attitude towards air pollution management.

**Table 7.1: Knowledge, skills and values to be attained**

Knowledge and understanding	Skills	Attitudes and values
<p>By the end of this unit, the learner should be able to:</p> <ul style="list-style-type: none"> <li><input type="checkbox"/> Identify air pollutants</li> <li><input type="checkbox"/> Identify causes and dangers associated with air pollution.</li> <li><input type="checkbox"/> Explain how to protect air against air pollutants.</li> </ul>	<p>By the end of this unit, the learner should be able to:</p> <ul style="list-style-type: none"> <li><input type="checkbox"/> Recognise polluted air.</li> <li><input type="checkbox"/> Apply the knowledge of recognising air pollution.</li> <li><input type="checkbox"/> Practice ways to avoid air pollution.</li> </ul>	<p>By the end of this unit, the learner should be able to:</p> <ul style="list-style-type: none"> <li><input type="checkbox"/> Be aware of the importance of pure air.</li> <li><input type="checkbox"/> Develop positive attitude towards avoiding air pollution.</li> <li><input type="checkbox"/> To advocate against the air pollution.</li> </ul>



## Pre-requisite of this unit

Learners were already introduced to the concept of air and its components in primary four. They also learnt about the uses of the main components of air i.e nitrogen, oxygen and carbon dioxide. In this class, they are supposed to learn about air pollution, its causes, consequences and how it can be controlled. Further, it is also important to highlight the fact that the concepts in this unit can be applied in environmental management in social studies. Also, learners should be made aware when they continue with their education in this area, they may become environmentalists.

### Background information

Due to increased human activities that include industrialisation, transportation, use of fuel for power generation, cooking, cigarette smoking and many others; such activities lead to air pollution. When air is polluted it becomes harmful to human beings, other animals and plants. Air pollution also causes global warming which has led to changes in the climate and unpredictable seasons. Therefore, this unit is about creating awareness on air pollution and its consequences.

## Cross cutting issues

### 1. Gender education

Both boys and girls should participate in conserving our environment. It is not a preserve of the boy or girl gender. Also, emphasize to learners that anybody irrespective of their

gender can pursue a career in environmental conservation. Give examples of role models who are successful in the area where the learners come from.

### 2. Standardization culture

Emphasize the need to use certified equipment and machines which do not pollute the environment. Caution learners against using counterfeits which may lead to accidents or injury of users or frequent breakdowns

### 3. Inclusive education

All learners should be encouraged to participate during lessons and practicals. Special arrangement should be made to take care of learners with special needs. For example, provide brail for blind learners, large print text for those with sight problems and allocate physically challenged learners to others to assist them during field trips and practical activities. Further, this category should be given tasks that they can manage during the practical sessions.

### 4. Financial education

Learners should be made aware of the fact that a clean environment ensures healthy living devoid of diseases hence helps to reduce health related costs. Also, buying quality equipment will lead to saving money in the long run as they stay for long and costs on repairs are reduced.

## 5. Environment and sustainability education

This is a topic that directly affects the environment. Emphasize the need to reduce air pollution and other forms of pollution in general. Caution the learners against activities that cause air pollution like cigarette smoking, bush burning among others.

## 6. Peace and values education

People should learn to live in harmony and they should be ready to help other people, especially those who are affected by natural disasters like floods or landslides.

### Generic competences to be covered

#### 1. Co-operation and interpersonal management and life skills

During group discussions and pair-work let learners engage one another by giving a chance for all to participate. Also, during group presentations, you can allow rotational presentations within the group members. Gifted learners should help in coming up with presentation content as slow learners contribute. **REMEMBER** You should allow slow learners to do presentations as well and correct them where they go wrong. Advise learners to appreciate the different abilities of their group members and accommodate each other's views.

#### 2. Research skills

Guide learners on how to find information regarding various topics such as the meaning of air pollution and its consequences. Guide learners on how to come up with summarized notes from a large body of text. You should also guide learners on doing Internet searches for the various content areas they are looking for.

#### 3. Communication in English

Communication in English will be improved when learners freely participate in the discussions and presentations. Encourage all learners irrespective of their abilities to participate in-group discussions, during presentations by asking questions and during question and answer sessions to either introduce or wrap up the lessons.

#### 4. Critical thinking and problem solving skills

This competence will be developed by learners as they answer the probing questions such as those on page 169 at the beginning of this unit and as they discuss the results of the various practical activities. Guide learners to discover for themselves the various sources of air pollution and their consequences. This competence will also come

about as learners think about their findings in the activities and as they give out their suggestions on why this is the case.

## 5. Lifelong skills

Knowing how to prevent air pollution is a lifelong skill that will ensure healthy living for all in the society.

## 6. Creativity and innovation

Encourage learners to come up with innovative ways of reducing air pollution and maintaining the environment.

### Key words in this unit and their meanings

- **Atmosphere** – this is a thin layer of gases that surrounds and protects the Earth.
- **Catalytic converters** - these are devices, which help to protect the environment by cleaning up and reducing vehicle emissions.
- **Chemical reactions** – this is a process when one or more substances react to form other substances.
- **Chimneys** - a part of a building through which smoke rises into the outside air especially; the structure extending above the roof.
- **Contamination** – this is the adding of dangerous substances in air, water, soil or food that can cause harm to living organisms.
- **Drought** – this is a long period of time without rainfall or with little rainfall that is not enough to support the lives of people, animals and plants.
- **Fossil fuels** – these are forms of energy sources obtained from organic materials such as oil, coal and natural gas. They are formed in the earth from plant and animal remains over many years ago.
- **Fumes** – these refer to vapors, dust and / or smoke given off by substances as a result of chemical reactions.
- **Global warming** – this is the current increase in temperature of the earth's surface both land and water as well its atmosphere.
- **Smog** – this is fog, which contains smoke or soot in it, smoke occurs mainly due to air pollution.

### Guidance on the problem statement

In this topic, you will teach about air pollution, its causes, effects and control/prevention measures. Use the pictures in pupil's book on page 169 to guide the learners on what they are going to discover in this topic. The learners should observe the picture carefully. It shows a mother and her daughter lighting a charcoal burner inside a closed room. This is very dangerous

because of the possibility of carbon monoxide poisoning. Assist learners to discover this and relate it to air pollution which is the concern of this topic.

### Attention to special educational needs

Support for Multi-ability learning	Support for special needs learning
<ul style="list-style-type: none"> <li>▪ <b>Peer-teaching</b> – engage high achievers to help weak pupils in understanding of concepts.</li> <li>▪ Plan remedial teaching for slow learners.</li> <li>▪ Allow enough time to slow learners to complete their work.</li> <li>▪ Gifted learners to be given heavy tasks requiring more critical thinking while slow learners are given tasks, which they can manage such as collecting materials for use during practicals among others.</li> <li>▪ Both gifted and slow learners to be given equal opportunity to lead in group discussions and to do presentations of group findings to the rest of the class.</li> <li>▪ Ensure all learners respect other’s views irrespective of their shortcomings or talents.</li> </ul>	<ul style="list-style-type: none"> <li>▪ Identify the learners with hearing and visual impairment and have them sit in front of the class so that proper attention can be given to them. Also, large print texts should be given to visually impaired learners and hearing aids provided for those with hearing impairment.</li> <li>▪ Arrange the room such that it will enable easy movement for the physically challenged learners.</li> <li>▪ Assign some students to be in charge of the physically and visually impaired learners. For example, carrying their equipment, showing them around during the field trips, etc.</li> <li>▪ Organize Braille for blind learners.</li> <li>▪ Encourage special needs learners by reminding them that ‘disability is not inability’!</li> </ul>

## List of lessons

Lesson No.	Lesson title	No. of periods
1.	Definition of air pollution	2
2.	Common air pollutants and their sources	4
3.	Consequences of polluted air	3
4.	Control of air pollution	3

### LESSON 1: Definition of air pollution

Refer to learner's book pages 169

#### Specific objectives

By the end of the lesson, learners should be able to define the term air pollution.

#### Preparation for the lesson

- This lesson will involve individual research work and group discussions. You will therefore organize the class as need arises during the lesson. **REMEMBER:** When grouping learners, you should consider the different abilities of learners and the special needs for various individuals.
- Ensure the internet is working properly before the lesson for learners to use to do research.

#### Teaching Aids

- Computers connected to the Internet.

- Textbooks, pamphlets, handouts and charts on air pollution.
- Pictures on page 173 of pupil's book.

#### Improvisation

Photographs of polluted cities or towns.

#### Pre-requisite of the lesson

Introduce the unit as explained under guidance on the problem statement above then narrow down to this lesson.

#### Teaching / learning activities

- You may begin the lesson by asking learners probing questions such as: have you ever heard of the word 'pollution? What does it mean?

#### Find out (Refer to Pupil's book page 169)

- This is a research activity to be done by individual learners. Let learners go to the library to read textbooks on the meaning of air pollution, its various causes and consequences. They can also visit sites where they can get this

information. For example: <http://www.scholar.google.com> or by simply searching the phrase 'air pollution using google search engine.

- Guide learners to discover the definition of air pollution, which is 'contamination of air with harmful chemicals. (You may need to stress the fact that).
- Emphasise the fact that we should avoid polluting air at all times.

### Synthesis

The lesson introduces learners to knowledge about air pollution and the effects of air pollution on our environment. They may also hold group discussions and agree on the meaning of air pollution. Let them write their findings down and correct them as is appropriate.

### Lesson assessment

Assess whether the learning objectives of the lesson were met by asking questions such as:

1. What did you learn in this lesson? (*Ans: Air pollution*)
2. What is air pollution?  
(*Ans: Air pollution is the adding of dangerous substances or contamination of the atmosphere*)

## LESSON 2: Common air pollutants and their sources

Refer to learner's book pages 170

### Specific objectives

By the end of the lesson, learners should be able to identify causes of air pollution and their sources.

### Preparation for the lesson

- This lesson will involve group activities and pair work. You will therefore organize the class as need arises during the lesson. **REMEMBER:** When grouping learners, you should consider the different abilities of learners and the special needs for various individuals.
- Ensure the internet is working properly before the lesson for learners to use to do research.

### Teaching aids

- Computers connected to the Internet.
- Textbooks, pamphlets, handouts and charts on air pollution.
- Charts on sources of air pollution

### Improvisation

Photographs of polluted cities or towns or drawings of sources of air pollution in manila papers.

### Pre-requisite of the lesson

You may introduce the lesson by reminding learners what they learnt under meaning of air pollution. Let volunteers define what air pollution is. Build on this and ask whether the learners know what causes air pollution. Have a brainstorming session.

### Teaching / learning activities

#### Activity 7.1 and 7.2 (Refer to Pupil's book page 170)

- Let learners look at the pictures and say what is going on in the pictures. Let them suggest how the activity in the picture is going to affect the air.
- Guide the learners to make a field study and observe physically the possible causes of air pollution and their sources. Ask them questions such as:
  1. Which causes of air pollution are natural?
  2. Identify examples of artificial causes of air pollution in the environment.
- Back in class, let learners write a summary of what causes air pollution and their sources. They can group them as shown in the table below.

Cause of air pollution	Artificial source	Natural source

- Some substances that cause air pollution include smoke from industries, smoke from people smoking cigarettes, burning tyres and other pieces of trash in open places, fumes from old vehicles, burning charcoal and fire wood to prepare food among others.
- Summarise the lesson by highlighting main points as learners write summary notes. Refer to Pupil's book pages 171.

### Synthesis

The lesson introduces learners to causes of air pollutants and their sources. Observe learners as they carry practical activities suggested to discover the various air pollutants and their sources.

### Lesson assessment

Assess whether the learning objectives of the lesson were met by asking questions such as:

1. Define air pollutant? (*Ans: Air pollutants are substances that cause air pollution*).
2. List four examples of gases that cause air pollution.

(Ans: The bad gases that cause air pollution to the atmosphere include: carbon dioxide, carbon monoxide, methane, nitrous oxide and ammonia gas).

### **LESSON 3: Consequences of polluted air**

Refer to learner's book pages 171

#### **Specific objectives**

By the end of the lesson, learners should be able to identify the consequences of air pollution.

#### **Preparation for the lesson**

- This lesson will involve individual research work and group discussions. You will therefore organize the class as need arises during the lesson. **REMEMBER:** When grouping learners, you should consider the different abilities of learners and the special needs for various individuals.
- Ensure the internet is working properly before the lesson for learners to use to do research.

#### **Teaching Aids**

- Computers connected to the Internet.
- Textbooks, pamphlets, handouts and charts on air pollution.
- Charts on sources of consequences of pollution.

#### **Improvisation**

Photographs of polluted cities or towns or drawings of consequences of air pollution in manila papers.

#### **Pre-requisite of the lesson**

You may introduce the lesson using probing questions such as 'what do you think are the consequences of polluted air? Let them have a brainstorming session.

#### **Teaching / learning activities**

##### **Research activity 7.3 (Refer to Pupil's book page 171)**

- This is a research activity to be done by individual learners. Let learners go to the library to read textbooks on the consequences of air pollution. They can also visit sites where they can get this information. For example: <http://www.scholar.google.com> or by simply searching the phrase 'air pollution' using google search engine.



- You may also organise for learners to visit a local environment management office. While there, let them find out from the officers concerned some of the consequences of air pollution.
- Guide learners to discover the consequences of air pollution, during the research activity or the academic visit. Some consequences that they may mention include:
  - *Damage to living organisms (food crops, or natural environment).*
  - *Global warming, acid rain.*
  - *Destruction of atmosphere.*

**Effects on human beings include:**

- *It makes the lungs not to function well*
- *It causes irritation of eyes nose mouth and throat*
- *It may cause asthma attacks*
- *It causes respiratory symptoms such as coughing and wheezing*
- *It may cause bronchitis*
- *It causes headaches and dizziness*
- *It may cause cardiovascular problems*
- *It may cause cancer*

- Emphasize the fact that we should avoid polluting air at all times.
- Summarise the lesson by highlighting main points as

learners write summary notes. Refer to Pupil's book pages 172.

**Synthesis**

The lesson introduces learners to consequences or effects of air pollution. You should effectively use the two activities and the academic visit to help learners discover some of these consequences. Learners should then use the information as a learning experience to help them take seriously issues to do with prevention of air pollution.

**Lesson assessment**

Assess whether the learning objectives of the lesson were met by asking questions such as:

1. Give two effects of air pollutants to the environment.  
*(Ans: Acid rains, destruction of atmosphere, global warming)*
2. Mention any 4 consequences of air pollution on humans?  
*(Ans: It causes respiratory symptoms such as coughing and wheezing, it causes bronchitis, it causes irritation of eyes nose mouth and throat. It brings on asthma attacks)*

## LESSON 4: Control of polluted air

Refer to learner's book pages 173

### Specific objectives

By the end of the lesson, learners should be able to explain how to protect air against air pollutants and apply them in their lives.

### Preparation for the lesson

- This lesson will involve individual research work and group discussions. You will therefore organize the class as need arises during the lesson. **REMEMBER:** When grouping learners, you should consider the different abilities of learners and the special needs for various individuals.
- Ensure the internet is working properly before the lesson for learners to use to do research.

### Teaching aids

- Computers connected to the Internet.
- Textbooks, pamphlets, handouts and charts on air pollution.
- Charts on control measures of pollution

### Improvisation

Photographs of clean and well-kept environment with many trees or

drawings of such an environment in manila papers.

### Pre-requisite of the lesson

You may introduce the lesson using probing questions such as 'how do you think we can reduce air pollutants in the atmosphere? Let them have a brainstorming session.

### Teaching / learning activities

#### Research Activity 7.5 (Refer to Pupil's book page 173)

- This is a research activity to be done by individual learners. Let learners go to the library to read textbooks on the control measures of air pollution. They can also visit sites where they can get this information in the internet. Let them search for the phrase 'air pollution' using google search engine.
- You may also organise for learners to visit a local environment management office. While there, let them find out from the officers concerned some of the control measures of air pollution.
- Guide learners to discover how to control/prevent air pollution from the research activity or the academic visit. Some of these ways include:

- *Putting industrial sites far from residential places.*
  - *Proper disposal of wastes.*
  - *Use of air pollution control devices in industries and vehicles.*
  - *Planting plenty of trees.*
- Emphasise the fact that 'PLANTING OF TREES' is the best way of ensuring clean air. Bring to their attention the fact that this is why the Rwanda government emphasizes on planting two trees everytime one is cut.
  - Summarise the lesson by highlighting main points as learners write summary notes. Refer to Pupil's book pages 173

### **Synthesis**

The lesson introduces learners to control measures of air pollution. You should effectively use the research activity and the academic visit to help learners discover some of these ways of controlling air pollution. Learners should then use the information in their daily lives to prevent/control air pollution.

### **Lesson assessment**

Assess whether the learning objectives of the lesson were met by asking

questions such as:

1. Suggest different ways of safeguarding air against pollutants.  
(Ans:
  - *Using sources of fuel which do not produce so much air pollutants.*
  - *Cars should be fitted with catalytic converters which remove dangerous exhaust gases.*
  - *We should find alternative sources of energy that are clean, like using solar energy or wind mills.*
  - *Encouraging people to use public transport other than buying their own cars, also walking, cycling, sharing cars all reduce the rate of pollution from vehicles.*
  - *Consider going green by planting more trees and garden plants.*
  - *Use natural gas instead of charcoal.*
  - *Quit smoking and encourage those around you to do the same, smoking is terrible for you and for the quality of air around us.*

### **Additional information to the teacher**

Some information that may be relevant in this topic include:

#### **(a) Examples of greenhouse gases are:**

Dangerous gases to the atmosphere

are called greenhouse gases. Greenhouse gases are both produced naturally and through human activities. Such gases include carbon dioxide, methane, nitrous oxide and fluorinated gases including chlorofluorocarbons (CFCs).

**(b) Effects of global warming include:**

- Desertification
- Increased melting of ice bergs which increases ocean levels
- Drought
- Changed weather patterns
- Violent winds and hurricanes

**(c) Ways of reducing global warming include:**

- Use of energy saving bulbs
- Switch off electric appliances
- Use of solar energy
- Planting many trees
- Reduce rubbish at home
- Reduce use fossil fuels

**Answers to Unit Test 7 (Refer to pupils book pages 174-175)**

1. Air pollution is the adding of dangerous substances into the atmosphere.
2. Carbon monoxide, methane, nitrous oxide and

chlorofluorocarbons.

3.
  - It causes diseases that affect animal lives e.g. respiratory diseases.
  - It causes global warming which has caused climate change in the world, those results into natural disasters.
  - Air pollution causes acid rain which damages crops and erodes buildings and vehicles.
4. Burning charcoal produces carbon monoxide in a closed room due to limited supply of air. This can cause carbon monoxide poisoning.
5. The term 'go green' means reducing pollution by all possible ways. When you reduce pollution you help to conserve our environment.
6. Smoking cigarettes in public places is disastrous because it causes respiratory diseases to the passive smokers (non-smokers) and it also contributes to air pollution.
7. (a) Wrong - causes air pollution  
(b) Wrong - Causes air pollution

(c) Right - Planting trees improves forest cover which in the long run helps in cleaning up the surrounding air by using carbon dioxide during photosynthesis.

8. (a) Global warming refers to the increase of the average atmospheric temperature due to effects of green house gases such as carbon dioxide.

(b) Planting many trees and avoiding quarrying, mining, smoking, etc to avoid accumulation of green house gases in the atmosphere.

9. Due to smog formed by air

pollution, it is always difficult for drivers to drive well due to poor visibility.

10. People who use fossil fuels should change to clean energy like using natural gas, solar biogas and other forms of energy to avoid pollution.

11. Air pollution is severe in cities because this is where most industries are located, also there are always very many vehicles in the cities.

12. B

## Additional activities to cater for intellectually challenged and gifted learners

Remedial activities for Intellectually challenged learners	Extended activities for gifted and talented learners
<ol style="list-style-type: none"> <li>1. Enter a room with smoke and see how it feels.</li> <li>2. Observe the back of cooking pots and appreciate the effects of smoke/air pollution.</li> </ol>	<ol style="list-style-type: none"> <li>1. Make air filters using locally available materials and use it to filter smoke.</li> <li>2. Build a greenhouse using polythene bags, strings and sticks and use it to feel what happens when global warming occurs.</li> </ol>
Remedial questions for Intellectually challenged learners	Extended questions for gifted learners
<ol style="list-style-type: none"> <li>1. Air pollution is _____</li> <li>2. _____, _____, _____ gases are examples of air pollutants.</li> <li>3. State how air pollution affects plants.</li> <li>4. Name one natural and one artificial source of air pollution.</li> <li>5. One method of controlling air pollution is to plant _____.</li> </ol>	<ol style="list-style-type: none"> <li>1. What differentiates a polluted and a non polluted environment?</li> <li>2. The consequences of not taking care of our environment is grave. Discuss.</li> <li>3. The Rwanda government insists on planting TWO trees for every one cut down. Explain why.</li> </ol>
Answers to remedial questions	Answers to extended questions
<ol style="list-style-type: none"> <li>1. Contaminating air with air pollutants.</li> <li>2. Carbon dioxide, carbon monoxide, sulphur dioxide, methane.</li> <li>3. Brings about acid rain which burns plants. Also smoke or dust particles clog leaves which interferes with their normal processes.</li> <li>4. Natural – dust from volcanic eruptions and that created by wind. Artificial – smoke from industries, fumes from vehicles, etc.</li> <li>5. Trees</li> </ol>	<ol style="list-style-type: none"> <li>1. Polluted is contaminated with air pollutants, the other one is not.</li> <li>2. Refer to consequences of air pollution as explained in pupil's book pages 178 - 180.</li> <li>3. To conserve the environment as trees help in cleaning or refreshing the air. They also act as catchment areas of rain.</li> </ol>

*Refer to Learner's Book pages 175-195*

## Key unit competence

After studying this unit, learners should be able to explain and practice effective management of goats and cows.

skills acquisition and attitude and values. At the end of the unit, learners should have knowledge and understanding of how to rear goats and cows and be able to achieve a living from such enterprises in future.

## Learning objectives

Competency based curriculum embraces three categories of learning objectives, that is, knowledge and understanding,

**Table 8.1: Knowledge, skills and values to be attained**

Knowledge and understanding	Skills	Attitudes and values
<p>By the end of this unit, the learner should be able to:</p> <ul style="list-style-type: none"> <li><input type="checkbox"/> List the characteristics of a good cowshed/ goat shelter</li> <li><input type="checkbox"/> Identify the types of goat or cow breeds.</li> <li><input type="checkbox"/> Identify the good elements of cattle diet.</li> <li><input type="checkbox"/> Explain conditions of cattle health.</li> <li><input type="checkbox"/> Explain the most common cattle diseases, their prevention and treatment.</li> <li><input type="checkbox"/> Explain the importance of cattle/goat farming.</li> </ul>	<p>By the end of this unit, the learner should be able to:</p> <ul style="list-style-type: none"> <li><input type="checkbox"/> Choose good types of cows/goats for breeding.</li> <li><input type="checkbox"/> Apply techniques of cows/goat breeding.</li> <li><input type="checkbox"/> Use appropriate cow/goat breeding terminology.</li> </ul>	<p>By the end of this unit, the learner should be able to:</p> <ul style="list-style-type: none"> <li><input type="checkbox"/> Show interest in cow or goat breeding.</li> <li><input type="checkbox"/> Develop awareness about the socio-economic value of cows and goats.</li> <li><input type="checkbox"/> Be aware of the nutritive value from livestock products.</li> </ul>

## Pre-requisites of this unit

Under this unit, learners have already been introduced to the various classes of animals that is mammals, birds, fishes, reptiles and amphibians in primary 4. Further, in primary 5, learners were taught about chicken rearing and good practices that should be carried out in chicken farming. In this class, learners will further be taught and practice goat and cattle farming. They will learn about proper housing for goats and cattle, goat and cattle breeds, how to feed goats and cattle and how to prevent goat and cattle diseases. There is also need to sensitize learners about the fact that the concepts in this unit can be applied in Agriculture under animal management. Let them know that when they continue and further their education in this area, they may become Agricultural officers, veterinary doctors or professional farmers.

### Background information

Cattle keeping in Rwanda is a development strategy by the Rwandan Government whereby the government is planning for each family to have at least one grade cow for milk production. Cattle, goats or other farm animals help families in very many ways. For example, families will solve nutritional problems as well as financial issues through this initiative. At the same time, farm animals help to provide manure for the crops as well. That informed the need to include this topic as part of the curriculum. Ensure that you highlight the importance of farm animals as you take learners through this unit.

## Cross cutting issues

### 1. Environment, climate change and sustainability

As farming or keeping of animals is being started, there are a lot of trees cut down to construct the animal houses or sheds. While cutting down trees and clearing the farm area we should be conscious not to destroy the environment. In fact, we should plant two trees for every one tree cut down.

### 2. Gender education

Inform learners that both men as well as women can earn a living by becoming professional farmers or practicing commercial farming. Farming is NOT a preserve of one gender!

### 3. Peace and values education

Caution learners against using farm tools as weapons to hurt others. Stress the fact that people should live in peace and harmony in order to develop. Inform them that they should be willing all the time to accommodate views of others. Also, in case a child gets hurt accidentally others should provide first aid before taking him or her to the hospital. Also, inform them that as they share animals according to the government policy it should be peacefully and harmoniously done.

### 4. Financial education

Let the learners understand that farming or keeping of farm animals is highly beneficial to the people and government of Rwanda. They



can comfortably ache a living from farming in future therefore they should not look at it in a negative way.

### **5. Standardization culture**

Encourage learners to learn about new innovations in modern farming. They should migrate from traditional farming to modern farming methods. Also, caution them against using counterfeit materials and feeds when doing farming.

### **6. Inclusive learning**

Allow all learners to participate during class/group activities irrespective of their gender, physical disability or mental challenges. Also during pairing, bright learners should be mixed with disadvantaged learners.

### **Generic competences to be covered**

#### **1. Co-operation and interpersonal management and life skills**

During class/group discussions and pair works - let learners engage one another by giving a chance for all to participate. Also, during group presentations - you can allow rotational presentations within the group members. Gifted learners should help in coming up with write-ups of presentation content as slow learners contribute. **REMEMBER** – You should allow slow learners to do presentations as well and correct them where they go wrong. Advise learners to appreciate the different abilities of their group members and accommodate each other's views.

#### **2. Research skills**

Guide learners on how to find information regarding various topics such as characteristics of a good cow/goat breed. Guide learners on how to come up with summarized notes from a large body of text. You should also guide learners on how to do Internet searches for the various content areas they are looking for.

#### **3. Communication in English**

Communication in English will be improved when learners freely participate in the discussions and presentations. Encourage all learners irrespective of their abilities to participate in group discussions, during presentations by asking questions and during question and answer sessions to either introduce or wrap up the lessons.

#### **4. Critical thinking and problem solving skills**

This competence will be developed by learners as they answer the probing questions such as those on page 177 at the beginning of this unit and as they discuss the results of the various practical activities. Guide learners to discover for themselves the various uses of tools and the maintenance practices on them. This competence will also come about as learners think about their findings in the activities and as they give out their suggestions on why this is the case.

#### **5. Lifelong skills**

By practicing and understanding how to take care of goats and

cattle, learners gain pre-requisite knowledge and skills that will come in handy in their lives were they to become livestock farmers.

## 6. Creativity and innovation

Encourage learners to come up with innovative ways of taking care of goats and cattle. For example, they can use cattle dung as a source of biogas in the farm and goat pellets as fish feeds, etc.

### Key words in this unit and their meanings

- **Ventilation** – this is to provide fresh air to a room or building and getting out bad air
- **Concrete** – a very hard building material made by mixing together cement, sand, small stones and water.
- **Crash** – is a strongly built stall or cage for holding cattle safely when they are being examined or given treatment. It minimizes injury to the animal or the person working on it.
- **Predators** – this is an animal that eats other animals
- **Bucks** – these are male goats.
- **Does** – these are female goats.
- **Kids** – the young ones of goats.
- **Resistant** – this means being immune or to be able to resist or fight off.
- **Humps** – this is a mixture of muscle and fat on the back of some cows.
- **Ticks** – these are parasites that remain on the animal's body to suck blood, carry a number of diseases that affect animals.
- **Growth rate** – this is the time an animal takes to mature or to become an adult.
- **Drought** – long period of prolonged shortages in water supply in an area
- **Suckle** – allow taking milk at the breast or teat.
- **Antibodies** - Antigens, which help to fight viruses and bacteria that cause diseases.
- **Hay** - grass, legumes or other herbs that have been cut, dried and stored for use in future.
- **Pasture** – perennial grasses for grazing animals.
- **Supplements** – any product taken by animals containing minerals.
- **Quarantine** – this is when animals and their products movements are restricted from one region to others in order to control disease outbreaks.
- **Vaccine** - a biological preparation that improves immunity to prevent a particular disease.
- **Isolation** – the state of being in a place that is separate from others.
- **Dipping** – to put down into a liquid quickly or partially and lift out again. Cows and goats are dipped into pesticides that kill pests like ticks.
- **Antibiotics** – these are powerful medicines that fight certain infections or diseases caused by germs.
- **Sterile insect techniques** – or STI is a method of biological insect control whereby overwhelming numbers of sterile insects are released into the wild. The sterile males compete with wild males to

mate with females; females that mate with sterile males do not produce offspring.

- **Oxen** – are any breed of cattle that are at least four and are taught to work.
- **Leather** – a durable and flexible material created by tanning animal hides and skins. People use leather to make: shoes, bags, hats, trousers, skirts, sofa seats and belts.

### Guidance on the problem statement

This topic is about cattle and goat

rearing. As a way of introducing the concepts, refer learners to Fig. 8.1 on page 176 of their book. The picture is associated with traditional cattle keeping whereby many cattle are kept within a very small piece of land. The cattle are less productive and are generally weak and unhealthy. This practice goes against the modern way of farming which entails practices like zero grazing and intensive farming. Learners should identify this as the problem situation in the picture.

### Attention to special educational needs

Support for Multi-ability learning	Support for special needs learning
<ul style="list-style-type: none"> <li>– <b>Peer-teaching</b> – engage high achievers to help weak pupils in understanding of concepts.</li> <li>– Plan remedial teaching for slow learners.</li> <li>– Allow enough time to slow learners to complete their work.</li> <li>– Gifted learners to be given heavy tasks requiring more critical thinking while slow learners are given tasks, which they can manage such as collecting materials for use during practicals among others.</li> <li>– Both gifted and slow learners to be given equal opportunity to lead in group discussions and to do presentations of group findings to the rest of the class.</li> <li>– Ensure all learners respect other's views irrespective of their shortcomings or talents.</li> </ul>	<ul style="list-style-type: none"> <li>– Identify the learners with hearing and visual impairment and have them sit in front of the class so that proper attention can be given to them. Also, large print texts should be given to visually impaired learners and hearing aids provided for those with hearing impairment.</li> <li>– Arrange the room such that it will enable easy movement for the physically challenged learners.</li> <li>– Assign some students to be in charge of the physically and visually impaired learners. For example, carrying their equipment, showing them around during the field trips, etc.</li> <li>– Organize Braille for blind learners.</li> <li>– Encourage special needs learners by reminding them that 'disability is not inability'!</li> </ul>

## List of lessons

Lesson No.	Lesson title	No. of periods
1.	Characteristics of a good cow/goat shelter	2
2.	Types of cattle/goat breeds	2
3.	Characteristics of cattle/goat breeds to rear	2
4.	Feeding of cows/goats	2
5.	Common diseases that affect cows and goats	3
6.	Importance of cattle/goat farming	1

### Lesson 1: Characteristics of good cow/goat shelter (To be covered in two periods)

Refer to learner's book pages 176-177

#### Specific objectives

By the end of the lesson, learners should be able to list the characteristics of a good cowshed/goat shelter.

#### Preparation for the lesson

- Seek permission from a nearby livestock farm for an educational visit.
- Learners to observe animal houses at home in preparation for the lesson.

#### Teaching aids

- Animal structures at school at home or in a farm.
- Photographs/ charts showing animal structures

#### Improvisation

You may improvise by making sketch drawings of animal houses and using them instead of charts.

#### Pre-requisite of the lesson

Introduce the unit as explained under

guidance on the problem statement above then narrow down to this lesson.

#### Teaching / learning activities

- This lessons will be divided into two parts: cowshed and goat shelter. You will teach about the characteristics of either in two separate sections.
- Ask learners if they keep some animals at home. Ask them the kind of shelter the animals live in.

#### Activity 8.1 (Refer to Pupil's book page 177)

- Let learners write down the characteristics of the type of shelter where the animals live as per the questions in this activity.
- You can then organise for learners to visit a nearby livestock farm. While in the farm let them observe the characteristics of the animal houses.
- Let them ask questions regarding the type of shelter as the farmer answers. The questions may include:
  1. Where is the shed located? Why?
  2. What is the shed made of?

3. *Do young ones share the same shelter as the old ones?*
4. *How and where do animals feed and take water from?*
5. *How is the floor of the shed made and why?*

They should come up with summary notes then compare with what they wrote down earlier.

- Back in class, wrap up by highlighting the characteristics of a good cow shed and goat shelter as learners write summary notes. Refer to pupil's book page 177.

### **Synthesis**

The lesson should help learners to gain knowledge about the structure of a good cow shed / goat shelter. Use the suggested activities and the educational visit to help learners discover the characteristics of a good cowshed. In general, it should be constructed in a way that is favourable to the health of the animals.

### **Lesson assessment**

Assess whether the learning objectives of the lesson were met by asking questions such as:

1. Outline the qualities of a good cow shed/goat shelter.  
(Ans - *Should be roofed.*)
  - *Should have proper sanitation.*
  - *Should be fenced.*
  - *Should have concrete rough floors that are easy to clean and not so hard.*
  - *Should have both clean feeding and watering troughs.*
  - *There should be another part reserved for calves.*

- *Should have an isolation box to accommodate the animals that are on treatment not mix and infect the normal ones.*
- *Should have a bull box as bulls shouldn't be mixed with the cows.*
- *There should also be a crash.*

## **Lesson 2: Types of good cattle/ goat breeds**

Refer to learner's book pages 178-184

### **Specific objectives**

By the end of the lesson, learners should be able to identify the types of cattle/ goat breeds.

### **Preparation for the lesson**

- Seek permission from a nearby livestock farm for an educational visit.
- Learners to observe livestock at home and in school in preparation for the lesson.
- Ensure the internet is working for doing research on livestock breeds.

### **Teaching aids**

- Animal structures at school at home or in a farm.
- Photographs / charts showing various types of animals.
- Textbooks and the internet.

### **Improvisation**

You may improvise by making colourful

drawings of cattle/goat breeds on manila paper and using them instead of charts.

### **Pre-requisite of the lesson**

Introduce the lesson by reminding learners about the previous lesson. Ask them whether they remember the animals they saw. Let them name some of them.

### **Teaching / learning activities**

- This lessons will be taught in two separate sessions (1) cattle breeds and (2) goat breeds.
- Ask learners if they keep some animals at home. Ask them the kind of shelter the

### **Find out (Refer to Pupil's book page 176)**

- This is a research activity involving learners finding out what the word 'breed' means and the various types of breeds of cattle and goats. Let them write summary short notes and share with other members of the class.
- At this point you can explain the meaning of the word breed – a group of animals with similar characteristics. You can then specify that breeds of animals can be indigenous or exotic. Explain the difference between the two: indigenous – local; exotic – foreign. You can then narrow down to cattle breeds.

### **(a) Cattle breeds**

- Organise learners to go for a visit to a cattle farm to observe the various breeds of cattle.

### **Activity 8.2 (Refer to Pupil's book page 178)**

- During the trip, let learners observe the various types of cattle ( both dairy and beef). Let them write down the characteristics of cattle that they see. They may consider things like colour, weight, presence/absence of horns, among others.
- Back in class, give learners the charts of cattle to observe. They should compare the characteristics of the cattle in the chart with what they wrote during the trip. Based on this, guide them to identify the cattle that they saw.
- Summarise by highlighting the main characteristics of the various breeds of cattle. Refer to pupil's book pages 178 – 184. Do this for dairy and beef cattle separately. They should write summary notes for each breed and draw and colour the animal against the respective characteristics.

### **(b) Goat breeds**

- Organise learners to go for a visit to a goat farm to observe the various breeds of goat.

### **Lesson assessment**

Assess whether the learning objectives of the lesson were met by asking questions such as:

1. What are indigenous cattle breeds?

*(Ans: Indigenous cattle (native) breeds: These are breeds of cattle that have been in Rwanda for a long period of time. These cattle can withstand hostile climatic conditions and they are resistant to tropical diseases. They have long legs and they can walk long distances looking for food and pasture. Their maturity is low and they are small in size.)*

2. Briefly discuss the different types of indigenous types of cattle.

*(Ans:*

- *Zebu cattle: these were kept by Rwandans; they are small in size and have short humps. They are mainly dairy cattle. They have ability to resist tick-borne diseases.*

- *The long horned cattle (Inyambo) These are fairly large in size and have well developed horns*

- *The boran cattle: these have short horns and big humps. They produce good quality beef. They are large in size than Zebu.)*

3. What are exotic cattle breeds?

*(Ans: The exotic cattle breeds: these are breeds which were introduced to Rwanda from overseas countries.)*

4. Briefly discuss the different types of exotic cattle.

- *Dairy cattle: These are mainly kept for the production of milk. Examples of dairy cows include Friesians, Guernsey, jersey, Ayrshire and Brown Swiss.*

- *The beef cattle breeds: these breeds are purposely kept for the production of beef. Examples of beef breeds cattle include: Aberdeen angus, Hereford, charolais, shorthorns, Galloway and beef master.*

5. Briefly discuss the different types of goat breeds.

*(Ans: goat breeds can be indigenous or exotic)*

- *Local or indigenous breeds of goats - These are goats, which have been reared in Rwanda for many years. They are resistant to tropical diseases. They are kept mainly for meat and for skin production. Local breeds include the east African small goats, Nubian and Alpine.*

- *The exotic goats – these are imported and they include: the Boer goat, Galla goat.*

### **Lesson 3: Characteristics of cattle and goats to rear**

Refer to learner's book pages 184

#### **Specific objectives**

By the end of the lesson, learners should

be able to select proper goats and cattle to rear based on their characteristics.

### **Preparation for the lesson**

- Ensure the internet is working for doing reasearch on livestock breeds.

### **Teaching aids**

- Photographs / charts showing good animals for rearing
- Textbooks and the internet

### **Pre-requisite of the lesson**

Introduce the lesson by reminding learners about the previous lesson. Ask them whether they remember the various breeds of animals. Let them name some of them.

### **Teaching / learning activities**

- Ask learners if they keep some animals at home. Ask them the kind of animals they keep. What characteristics do they have?

### **Activity 8.3 (Refer to Pupil's book page 185)**

- This is a research activity involving learners finding out what the word 'characteristics of a good breed to rear are'. Let them write summary

short notes on these.

- Back in class, put learners in groups depending on class sizes and their abilities. Let them summarise their findings.

They should then choose a group leader to do a presentation on behalf of the rest.

- At this point you can explain the various features to look for when choosing cattle and goats to rear.
- Emphasise the need to identify high productivity breeds, both drought and diseases resistant breeds and those with good feeding habits.

### **Synthesis**

After this lesson, learners should be able to appropriately choose cattle and goat for breeding. Use the suggested research activity and the discussion groups to help learners discover this skill.

### **Lesson assessment**

Assess whether the learning objectives of the lesson were met by asking questions such as:

1. Briefly discuss about different characteristic of goat breeds or cows to be reared.



(**Ans:** Factors or criteria to follow when selecting a suitable breed of cows or goats to rear include:)

(a) Growth rate: the breed should that type that grows faster.

(b) Resistance to diseases: the breed should that one that resists the common diseases found in our area. For example tropical diseases in Rwanda.

(c) Feeding: they should be breeds that can survive on local foods available.

(d) Productivity: they should be breeds that produce a lot of milk or high quality meat.

(e) Suitability to climatic conditions: they should be breeds that survive in the range of climatic conditions available in our area.

#### **Lesson 4: Feeding cows/goats**

*Refer to learner's book pages 184*

#### **Specific objectives**

By the end of the lesson, learners should be able to explain the elements of a good diet of cattle and goat and feed them appropriately.

#### **Preparation for the lesson**

- Seek permission from a nearby livestock farm for an educational visit.
- Learners to observe livestock at home and in school feeding in preparation for the lesson.
- Ensure the internet is working for doing reasearch on livestock breeds.
- Collect sample animal feeds such as napier, lucern and a variety of concentrates for demonstrations in class.

#### **Teaching aids**

- Sample animal feeds such as napier, lucern and a variety of concentrates
- Photographs/charts showing various types of livestock feeds
- Textbooks and the internet

#### **Improvisation**

You may improvise by making colourful drawings of cattle/goat feeds on manila paper and using them instead of charts.

#### **Pre-requisite of the lesson**

Introduce the lesson by asking learners probing questions such as: What do animals feed on? What are the importance of these feeds?

Take advantage of their answers and introduce this lesson.

## Teaching / learning activities

### Activity 8.4 (Refer to Pupil's book page 186)

- Take learners for an academic visit to a goat/cattle farm. Let them observe the types of feeds that the animals are feeding on.
- Let them find out from the farmer why he/she prefers those feeds. Let them write summary notes.
- Back in class, put learners in groups depending on their abilities and class size. Let them discuss their findings.
- Guide learners to categorise the feeds that they saw. Let them come up with a table on the same. They should then compare their work to other group members by way of presentations.
- Emphasize the fact that cattle are fed depending on their type and the age. Also their status, for example, whether pregnant or not matters.
- Also, emphasize the need to give balanced ration to cattle/goats. Balanced ration contains all body nutrients necessary for healthy growth of the animals.
- At this point, you can introduce the concept of classification of animal feeds.

### Find out (Refer to Pupil's book page 186)

- Give learners a research activity to find out what roughages, concentrates and succulents are.

They should also find out their importance and advantages and disadvantages.

- Summarise the lesson by highlighting the main classes of animal feeds and the main nutrient they contain.
  - **NB** – Bring to the attention of learners the fact that apart from the foods above, animals also **MUST** be given plenty of water and roughages.
- Wind up the lesson by giving learners project work on establishing a farm.

## Synthesis

The lesson should help learners to gain knowledge about how to feed animals and to know the characteristics of the various types of livestock feeds.

## Lesson assessment

Assess whether the learning objectives of the lesson were met by asking questions such as:

1. What are indigenous cattle breeds?  
*(Ans: Indigenous cattle (native) breeds: these are breeds of cattle that have been in Rwanda for a long period of time. These cattle can withstand hostile climatic conditions and they are resistant to tropical diseases. They have long legs and they can walk long distances looking for food and pasture. Their maturity is low and they are small in size.)*

## **Lesson 4: Common diseases that affect cattle and goats**

*Refer to learner's book pages 187*

### **Specific objectives**

By the end of the lesson, learners should be able to:

- Explain health sanitation conditions of cattle and goats.
- Identify the most common cattle and goat diseases and treat or prevent them.

### **Preparation for the lesson**

1. This lesson will involve a research activity and a academic trip to a livestock farm. Therefore seek permission in advance from the farm managers/owners.
2. Bring pamphlets, handouts, and textbooks for reference in class. Also, ensure that the Internet is working if you have a computer laboratory or any other form of Internet connectivity such as WIFI or modem.

### **Teaching aids**

- Reference materials on diseases that affect cattle and goats.
- Livestock farm
- Computers and Internet

### **Pre-requisite of the lesson**

- Introduce the lesson by reminding learners about common diseases that they know or might have come across. They may name some diseases that affect human beings.
- You can then ask them if they think the same diseases affect animals. The answer may be yes or no.
- Take advantage and build on this by asking them to do research about this.

### **Teaching / learning activities**

#### **Find out (Refer to Pupil's book page 187)**

- Let learners go to the library and search in textbooks, the meaning of the word 'sanitation' and the sanitation conditions necessary for cattle and goats.
- At this point, you can come in and explain the meaning of sanitation and the various sanitation conditions which are good for cattle and goats.

#### **Activity 8.5 (Refer to Pupil's book page 187)**

- You can then take learners for an academic trip to a livestock farm. While at the farm, let them look out for any sick animals. They should identify an animal, say 'animal X' and write down its characteristics.

- Back in class, put learners in groups depending on the size of the class and the abilities of class members to harmonise their findings. Give them a chart showing various diseases that affect cattle and goats. Alternatively, they can look at table 8.1 pupils' book pages 188 - 191 on the various diseases that affect livestock. Let them go through the signs and symptoms column and the animals affected.
- They should then compare the characteristics they wrote down during the academic trip with these information. Let them use it to identify the disease the animal was suffering from.
- Let them compare their work and see if they all got it right.
- Wrap up by highlighting the main points as learners take notes.
- You may give learners a further activity on finding out about the common diseases that affect livestock in their community. They should write a report then present it for assessment.

## Synthesis

Guide learners to research and through academic visits, to discover the diseases that affect goats and cattle. Ensure that at the end they appreciate the need to prevent/control these diseases as a way of helping animals live healthy lives.

## Lesson assessment

Assess whether the learning objective of the lesson was met by asking questions such as:

1. What is sanitation? (*Ans: Keeping the environment around us clean*)
2. Give two conditions that must be maintained to ensure healthy livestock.  
(*Ans: Refer to pupil's book page 186*)
3. Name two:
  - (a) Bacterial disease  
(*Ans: Anthrax, Pneumonia, Brucellosis, Mastitis*)
  - (b) Viral diseases  
(*Ans: Foot and mouth fever, Rinderpest*)
  - (c) Protozoon diseases that affect livestock?  
(*Ans: Trypanosomiasis, Anaplasmosis, Heart water*)

## **Lesson 6: Control and prevention of cattle / goat diseases.**

*Refer to learner's book page 188*

### **Specific objective**

By the end of this lesson, learners should be able to explain, prevent and control common cattle and goat diseases

### **Preparation for the lesson**

- Seeking permission to visit a cattle/ goat farm.
- Inviting a resource person to give a talk to learners.

### **Pre-requisite of the lesson**

- Introduce the lesson by reminding learners what they learnt under cattle/goat diseases.
- Ask them whether they think it is possible to control and prevent the diseases.

### **Teaching / learning activities**

- Build the lesson from the learner responses above.

### **Activity 8.5 (Refer to Pupil's book page187)**

- During the visit, let learners ask the farmer which diseases affect his/her

animals and how he/she controls them.

- Let learners write short notes and share with other class members once in class. Give a chance for a learner to recap what they learnt during the visit.
- Correct the learners as they write short notes.
- Wind up the lesson by giving learners a further activity to find out common diseases that affect cattle/ goats in their community and how they control them.

## **Lesson 7: Importance of cattle/ goat farming**

*Refer to learner's book pages 192*

### **Specific objective**

By the end of this lesson, learners should be able to explain the importance of cattle/ goat farming.

### **Preparation for the lesson**

- Collection of some products from cows or goats.
- Obtain charts on cow or goat products.

## Teaching aids

- Cow or goat products such as milk, hides, belts and handbags, meat, etc.
- Charts on the products above.

## Improvisation

- You may make your own chart on cow or goat products by drawing them on manila paper.

## Pre-requisite of the lesson

- Introduce the lesson by whether they think cattle and goats are important or harmful to us. Allow them to give reasons for their choice of answer.

## Teaching / learning activities

- Build on the learner responses above to introduce the discussion below.

## Synthesis

This lesson intends to make learners appreciate cattle and goats. Ensure that the learners use the research activity suggested and the discussion groups to help learners understand the benefits we derive from livestock and more particularly goats and cattle. Emphasise the fact that livestock farming can be a source of income in future if learners take it seriously.

## Lesson assessment

Assess whether the learning objectives of the lesson were met by asking questions such as:

1. Say why cattle and goat farming is important.

*(Ans: Refer to pupil's book pages 193-194)*

## Answers to the Unit Test 8 (Pupil's book Pages 194-195)

1. Refer to pupil's book pages 159 -161.
2. (a) A group of organisms having common ancestors and sharing certain traits that are not shared with other members of the same species. Breeds are usually produced by mating selected parents.  
(b) Indigenous – local; exotic, imported or foreign breeds
3. (a) To avoid predators.  
(b) To prevent spread of diseases/ parasites.
4. That she is very wrong. Tell her that farming is the backbone of our country and that many families rely on farming as a source of income. As such, she should embrace it by all means.

5. (a) Good milk producer  
(b) Good feeder and quality meat.
6. Refer to table 8.1 pages 178 of pupil's book.
7. It reduces chances of the animals becoming sick thereby ensuring healthy stock.
8. (a) Fresian cow (b) Hereford bull  
(c) Jersy cow  
(a) and (c) are dairy cows;  
(b) is beef cattle
9. Animal wastes can be used to

produce manure which is the used to enrich soil for increased cro yields.

10. To reduce cases of malnutrition in the country and to provide some sorce of family income.
11. Unboiled milk may transmit tuberculosis to human beings.
12. (a) False (b) False  
(c) False (d) False
13. To improve nutrition of the populace.

## Additional activities to cater for intellectually challenged and gifted learners

<b>Remedial activities for intellectually challenged learners</b>	<b>Extended activities for gifted and talented learners</b>
<ol style="list-style-type: none"> <li>1. Drawing and painting various breeds of goats and cattle on manila papers and hanging them on the wall.</li> <li>2. Collecting various products of animals.</li> </ol>	<ol style="list-style-type: none"> <li>1. Collecting locally materials, coming up with innovative ways of constructing goat shelter, going ahead and constructing one.</li> <li>2. Coming up with research questions fo academic visits.</li> </ol>
<b>Remedial questions for intellectually challenged learners</b>	<b>Extended questions for gifted learners</b>
<ol style="list-style-type: none"> <li>1. Examples of animal products are _____, _____ and _____.</li> <li>2. Name three things that can be used to make a cattle house.</li> <li>3. Which local breeds of cattle do you know in Rwanda?</li> <li>4. The three major classes of animal feeds are _____, _____ and _____.</li> </ol>	<ol style="list-style-type: none"> <li>1. Comment about exotic and indegenous cattle.Which one would you prefer?</li> <li>2. Which factors would you consider when choosing a heifer for breeding?</li> <li>3. Why are concentrates important in animal diet?</li> </ol>
<b>Answers to remedial questions</b>	<b>Answers to extended questions</b>
<ol style="list-style-type: none"> <li>1. Hides &amp; skins, milk, meat, eggs, etc</li> <li>2. Timber, bricks, iron sheets, cement, sand, etc</li> <li>3. Inyabo, zebu, boran.</li> <li>4. Roupages, Succulents, concentrates</li> </ol>	<ol style="list-style-type: none"> <li>1. The preference would depend on what the farmer wants: if quantity and quality of product – exotic; if resistance to drought and diseases - indeginous.</li> <li>2. Growth rate, resistance to diseases, feeding habits, productivity among others.</li> <li>3. They are a major source of proteins.</li> </ol>



**UNIT  
9****Plant reproduction**  
(No. of periods: 10)

**Refer to the Learner's Book pages 196 -210**

**Key Unit Competency**

After studying this unit, learners should be able to describe the parts of a flower and explain the process of sexual and asexual reproduction in plants.

that is, knowledge and understanding, skills acquisition and attitude and values. At the end of the unit, learners should have knowledge and understanding of reproduction in plants.

**Learning objectives**

Competency based curriculum embraces three categories of learning objectives,

**Table 9.1: Knowledge, skills and values to be attained**

<b>Knowledge and understanding</b>	<b>Skills</b>	<b>Attitudes and values</b>
By the end of this unit, the learner should be able to: <input type="checkbox"/> Identify the reproductive parts of a flower. <input type="checkbox"/> Explain the process of sexual production of flowering plants.	By the end of this unit, the learner should be able to: <input type="checkbox"/> Draw and label a flower. <input type="checkbox"/> Recognize just by looking at plants and flowers those reproducing either sexually or asexually.	By the end of this unit, the learner should be able to: <input type="checkbox"/> Show curiosity in exploring the surrounding plants and be inquisitive. <input type="checkbox"/> Show interest in growing different plants both at home.

<input type="checkbox"/> Explain the process of asexual reproduction of flowering plants. <input type="checkbox"/> Explain reasons of plant reproduction.		<input type="checkbox"/> Value individual effort and teamwork in protecting flora.
--	--	--

### Pre-requisite of this unit

This unit is about reproduction in plants. Remember, learners have come across plants before. For example, in primary 4, they learnt about types of plants and the process of germination. In primary 5, they were introduced to importance of plants and trees in particular. Therefore, link what the learners already know with what they will learn here. Also, it will help if you bring to the awareness of learners the fact that this topic is related to reproduction in plants in biology and vegetative reproduction in Agriculture. When learners pursue this and further they can become botanists or plant specialists.

### Background information

This topic is about reproduction in plants and reasons for reproduction. Therefore, the difference between sexual and asexual reproduction should be emphasized then narrow down to the specifics of reproduction processes in plants. This topic will therefore in a nutshell enable learners understand how reproduction occurs in plants.

### Cross cutting issues to be addressed

#### 1. Financial education

Bring to the attention of learners the fact that they should practice crop production so that they improve food security in the country.

#### 2. Environmental conservation and sustainability

Caution learners on the practice of picking up flowers from plants everywhere. This will make them interfere with plant reproduction.

#### 3. Gender education

Let learners know that people of all gender can take care of plants and pursue a career in plant management.

#### 4. Inclusive education

All learners should be encouraged to participate during lessons and practicals. Special arrangement should be made to take care of learners with special needs. For example, provide brail for blind

learners, large print text for those with sight problems and allocate physically challenged learners to others to assist them during field trips and practical activities. Further, this category should be given tasks that they can manage during the practical sessions.

### **Generic Competences**

#### **1. Co-operation and interpersonal management and life skills**

During group discussions and pair-work let learners engage one another by giving a chance for all to participate. Also, during group presentations, you can allow rotational presentations within the group members. Gifted learners should help in coming up with presentation content as slow learners contribute. **REMEMBER** You should allow slow learners to do presentations as well and correct them where they go wrong. Advise learners to appreciate the different abilities of their group members and accommodate each other's views.

#### **2. Research skills**

Guide learners on how to find out information regarding various topics such as the different parts that make up the flower, its role in plant reproduction, etc. Guide learners on how to come up with summarized notes from a large body of text. You should also guide learners on doing

Internet searches for the various content areas they are looking for.

#### **3. Communication in English**

Communication in English will be improved when learners freely participate in the discussions and presentations. Encourage all learners irrespective of their abilities to participate in group discussions, during presentations by asking questions and during question and answer sessions to either introduce or wrap up the lessons.

#### **4. Critical thinking and problem solving skills**

This competence will be developed by learners as they answer the probing questions such as those on page 197 at the beginning of this unit and as they discuss the results of the various practical activities. Guide learners to discover for themselves how reproduction takes place in plants. This competence will also come about as learners think about their findings in the activities and as they give out their suggestions on why this is the case.

#### **Key words in this unit and their meanings**

- **Calyx** – many sepals put together.
- **Corolla** – many petals put together in a flower.

- **Dicotyledonous seed** – Seed with two cotyledons.
- **Fertilisation** – Fusion of male and female gametes to form a zygote. The zygote later develops into embryo, foetus then finally baby.
- **Monocotyledonous seed** – Seed with only one cotyledon.
- **Nectar** – The sweet smelling substance found at the base of a flower that often attracts insects and birds.
- **Pistil** – Female parts of a flower.
- **Plumule** – Part of embryo of a seed that develops into a shoot.
- **Pollination** – the process by which pollen grains are transferred from the anther to the stigma of a flower.
- **Radicle** – Part of embryo of a seed that develops into a root.
- **Stamen** – Male parts of a flower.

**Guidance on the problem statement**

As a way of introducing the unit, refer learners to the picture on page 196 of their book. The picture is about creating awareness about how to maximize land usage by creating container gardens using recycled bottles and bags. Let learners comment on how they can help the family in picture B whose crops have failed. They most likely used wrong planting materials and did not take good care of their crops. Let learners understand that for good crop yields, there is need to choose good planting materials and take good care of them.

**Attention to special educational needs**

Support for Multi-ability learning	Support for special needs learning
<ul style="list-style-type: none"> <li>▪ <b>Peer-teaching</b> – engage high achievers to help weak pupils in understanding of concepts.</li> <li>▪ Plan remedial teaching for slow learners.</li> <li>▪ Allow enough time to slow learners to complete their work.</li> </ul>	<ul style="list-style-type: none"> <li>▪ Identify the learners with hearing and visual impairment and have them sit in front of the class so that proper attention can be given to them. Also, large print texts should be given to visually impaired learners and hearing aids provided for those with hearing impairment.</li> </ul>

<ul style="list-style-type: none"> <li>▪ Gifted learners to be given heavy tasks requiring more critical thinking while slow learners are given tasks, which they can manage such as collecting materials for use during practicals among others.</li> <li>▪ Both gifted and slow learners to be given equal opportunity to lead in group discussions and to do presentations of group findings to the rest of the class.</li> <li>▪ Ensure all learners respect other's views irrespective of their shortcomings or talents.</li> </ul>	<ul style="list-style-type: none"> <li>▪ Arrange the room such that it will enable easy movement for the physically challenged learners.</li> <li>▪ Assign some students to be in charge of the physically and visually impaired learners. For example, carrying their equipment, showing them around during the field trips, etc.</li> <li>▪ Organize Braille for blind learners.</li> <li>▪ Encourage special needs learners by reminding them that 'disability is not inability'!</li> </ul>
--	---

### List of lessons

Lesson No.	Lesson title	No. of Periods
1.	Meaning of plant reproduction	1
2.	Identification of parts of a flowers	2
3.	Sexual reproduction in plants	3
4.	Asexual reproduction in plants	3
5.	Reasons for plant reproduction	1

### 9.1 Definition of plant reproduction

Refer to learner's book pages 196 -197

#### Lesson 1: Meaning of plant reproduction

##### Specific objectives

By the end of this lesson, learners should be able to explain plant reproduction and show an understanding the two

types of reproduction in plants.

##### Preparation for the lesson

- This lesson will involve a practical activity and group discussions. You will therefore organize the class as need arises during the lesson.

**REMEMBER:** When grouping learners, you should consider the different abilities of learners and the special needs for various individuals.

- Look for textbooks, handouts, pamphlets and other materials on plant reproduction.
- Ensure the internet is working properly before the lesson for learners to use to do research.

### Teaching aids

- Textbooks, handouts and pamphlets.
- Computers connected to the Internet.
- Plant parts such as sugar cane cuttings, seeds and root tubers.

### Pre-requisite of the lesson

- Introduce the unit as explained under guidance on the problem statement above then narrow down to this lesson.
- You may then introduce this lesson by asking probing questions such as: How do plants reproduce?
- Leverage on the responses to the probing questions and introduce activity 9.1.

### Teaching / learning activities

#### Activity 9.1 (Refer to Pupil's book page 196-197)

- Guide learners to plant some

sugarcane cuttings and seeds and water them until they sprout. Let learners note their observations after two weeks. **Note:** This activity should be done two weeks in advance.

- Put the learners into groups depending on the class size and their abilities. Let them discuss their findings in the activity.
- Guide learners to discover the meaning of reproduction through their observations, which is to create new individuals for continuity of species. (You may need to stress the fact that without reproduction, species will become extinct).
- At this point, you may inform learners that reproduction can be sexual or asexual.
- Ask learners how they plant sugarcane or sweet potatoes, then what happens. Emphasize the fact that this is a form of asexual reproduction where gametes are not involved.
- You can then narrow down to human beings and ask learners how they think babies come into being. Let them know that this is a form of sexual reproduction and that it

involves reproductive systems. It is the process that leads to formation of seeds in plants.

- Wrap up the lesson by highlighting the main points and allowing learners to write short notes. You may also appoint a gifted learner to summarise the lesson on behalf of the rest as you correct him or her as is appropriate.

### Synthesis

This lesson introduces learners to the reproduction in plants. Learners should through the activities suggested and the group discussions, discover what the term reproduction means and how reproduction occurs in plants.

### Lesson assessment

Assess whether the learning objectives of the lesson was met by asking questions such as:

1. What did you learn in this lesson?

*(Ans: Meaning of reproduction and function of reproductive system in human body)*

2. Reproduction is \_\_\_\_\_. It can be \_\_\_\_\_ or \_\_\_\_\_.

*(Ans: Giving rise to new ones of own kind. Sexual, asexual)*

3. Which form of reproduction involves gametes? \_\_\_\_\_

*(Ans: sexual)*

## Lesson 2: Identification of parts of a flower

Refer to learner's book pages 197

### Specific objectives

By the end of the lesson, learners should be able to identify the reproductive parts of a flower and state their functions.

### Preparation for the lesson

- This lesson will involve a practical activity and group discussions. You will therefore organize the class as need arises during the lesson. **REMEMBER:** When grouping learners, you should consider the different abilities of learners and the special needs for various individuals.
- Look for textbooks, handouts, pamphlets and other materials on plant reproduction.
- Ensure the internet is working properly before the lesson for

learners to use to do research.

### Teaching aids

- Charts, textbooks, handouts and pamphlets on parts of a flower.
- Computers connected to the Internet.
- Different flowers collected from the field.
- Razor-blade or scalpel, hand lens

### Improvisation

You may come up with a well-painted diagram on parts of a flower on manila paper for use if you lack charts.

### Pre-requisite of the lesson

- You may begin this lesson by asking learners whether they recall the parts of a plant they learnt about in primary 3.
- Let them come up with a table on the name of the part and its function.
- Obviously, one of the parts that learners will mention is the flower. Build on this and introduce Activity 9.2.

### Teaching / learning activities

#### Activity 9.2 (Refer to Pupil's book page 197)

- Take learners for a field visit to collect flowers. Let them come back to class with them and dissect them.
- Let the learners observe the dissected flowers using naked eyes, then hand lens. Ask them what they can see.
- Provide learners with charts showing parts of a flower. Let them compare what they saw to these charts.
- Guide learners to draw the parts of a flower in their notebooks then label them.
- In their groups, they can play a game of pointing and naming the various parts. Let one member point at a part as others name the part.
- At this point, you can highlight the main points emphasising parts of a flower and their functions. Remember to caution learners against destroying plants as they collect flowers. This is not good for the environment.
- Let learners know that the parts of the flower can be put into two distinct groups that is, male and female parts.
- Put learners in groups and let them find out what these parts are made



of. Let them draw the figures in their notebooks. They can refer to Fig. 9.2 page 198 in their books.

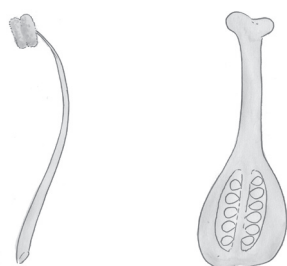

(a) Male (b) Female

Fig. 9.1 Male and female parts of a flower

- Wind up the lesson by giving learners a task of collecting flowers and identifying the male and female parts and drawing them in their notebooks as a further activity.
- Summarise the lesson by highlighting the key points as learners write down short notes.

### Synthesis

From the previous lesson, learners already have an idea what reproduction in plants is. Therefore, guide learners to use the activities suggested in this lesson to help them discover the various organs that make up the flower and their functions in general.

### Lesson assessment

Assess whether the learning objectives of the lesson were met by asking questions such as:

1. \_\_\_\_\_ is the reproductive organ of a flower. (Ans: Flower)
2. External parts of a flower are \_\_\_\_\_, \_\_\_\_\_ and \_\_\_\_\_? (Ans: stalk, sepals and petals)
3. What organs make up:
  - (a) pistil? \_\_\_\_\_ (Ans: stigma, style, ovary and ovules)
  - (b) Stamen? \_\_\_\_\_ (Ans: Anther, and filament)

### Lesson 3: Sexual reproduction in flowering plants

Refer to learner's book pages 200 - 203

### Specific objectives

By the end of the lesson, learners should be able to explain the process of sexual reproduction in flowering plants.

## Preparation for the lesson

- Charts, textbooks, handouts and pamphlets on sexual reproduction in flowering plants.
- Computers connected to the Internet.
- Different flowers collected from the field.

## Improvisation

You may come up with well-painted diagrams of processes such as fertilisation and pollination and parts of a seed on manila papers for use if you lack charts.

## Pre-requisite of the lesson

- You may begin the lesson by informing learners that sexual reproduction in flowering plants occur through various processes. These include pollination, fertilisation, dispersal of seeds and eventually germination. Therefore, this lesson will be taught in these four distinct parts.

## Teaching / learning activities

### (a) Pollination

#### Activity 9.3 (Refer to Pupil's book pages 200)

- Take learners for a nature walk in the field. Let them look out for

various flowers and observe what goes on inside them.

- Guide the learners to discuss the questions in this activity.

**CAUTION:** Learners against destroying flowers or plants during this activity.

- Some of the observations that learners may record include insects and birds visiting flowers.
- Take advantage of this and explain what pollination is and the two types of pollinations: self and cross pollination.
- Guide learners to discover the difference between the two. Show them diagrams in Pupil's book pages 200 -201 or the figures in charts.
- At this point you can introduce the concept of agents of pollination. Find out (Refer to Pupil's book page 201)
- Let learners go to the library to research about agents of pollination and write a report. They can also do internet searches.
- Allow learners to share their findings in a discussion forum in class. Let them choose a group leader to do presentations on their behalf.

- At this point, you can introduce the three agents of pollination, that is animals (birds and insects), wind and water. Explain how each of these occurs.
- Wrap up by giving the main parts as learners write summary notes.

### **(b) Fertilisation**

You may begin this lesson by asking learners what they think happens after pollination has taken place.

### **(c) Seed dispersal**

Ask learners where they think seeds go to after maturity in plants. Build on their answers to explain what is seed dispersal?

- Advise learners to take a nature walk when they go back at home. They should then observe their clothes there after. Let them share their experiences.
- Further, guide them to carry out the rest of the activities in this practical.

Guide them to discover the fact that their findings are what is known as seed dispersal. Go through the various agents of seed dispersal as they write summary notes. Refer to pages 202-203 for details.

### **(d) Seed germination**

Ask learners to say what they think happens to seeds after dispersal. Take advantage and introduce activity 9.6.

#### **Activity 9.4 (Refer to Pupil's book page 204)**

- Guide learners to carry out this activity in groups. The composition of the groups should be informed by size and ability of learners. **Note:** This activity should be done 3 - 5 days earlier.
- At the end of the experiment, learners should observe that germination has occurred. Let them say or find out what it is and share with other class members.
- You can then clarify that seeds germinate into new plants after dispersal.
- At this point, you can introduce the fact that certain conditions are necessary for germination to occur.
- Guide learners to carry out this activity in groups. Again, plan and do this activity 3-5 days in advance. The composition of the groups should be informed by size and ability of learners.
- Let them do research in the library

or the internet to find out why the results of this experiment are the way they are.

- Back in class, they should share ideas by choosing group leaders to do presentations on behalf of the rest.
- Wrap up the lesson by highlighting the main conditions necessary for germination as learners take summary notes.

### Synthesis

This is a very long lesson sub-divided into the four sections i.e. pollination, fertilization, seed dispersal and germination. Using the suggested activities and teaching approaches, allow learners to discover the process of sexual reproduction in flowering plants. Guide them through each step mentioned above. Let them know that they occur in that order and that none can happen before the preceding one occurs. As they have seen, the process ends with germination which gives rise to a new plant. This new plant is subjected to a growth process, develops into a mature plant which later produces seeds and the process begins afresh. This goes on and on and it forms what is called the life cycle of a plant.

### Lesson assessment

Assess whether the learning objectives of the lesson were met by asking questions such as:

1. Which processes are involved in sexual reproduction in flowering plants?  
*(Ans: Pollination, fertilisation, seed dispersal, germination)*
2. Give three conditions necessary for germination to occur.  
*(Ans: Water (moisture), warmth, presence of air (oxygen))*
3. What is seed dispersal?  
*(Ans: scattering away of seeds in order to germinate)*
4. Draw and label parts of a flower.  
*(Ans: Refer to Fig. 9.2 page 198 of Pupil's book)*

## Lesson 4: Asexual reproduction in plants

Refer to learner's book pages 205

### Specific objectives

- By the end of the lesson, learners should be able to explain the process of asexual reproduction of flowering plants.

### Preparation for the lesson

- Charts, textbooks, handouts and pamphlets on asexual reproduction in flowering plants.
- Computers connected to the Internet.
- Different vegetative parts collected from the field.

### Improvisation

You may come up with well-painted diagrams of processes such as grafting, cuttings, budding, layering among others on manila papers for use if you lack charts.

### Pre-requisite of the lesson

- You may begin this lesson by letting learners carry out Activity 9.5 on page 205 of pupils book.

- You may then inform learners that asexual reproduction in flowering plants occur through various processes. These include use of cuttings, grafting, layering, budding and use of suckers. Therefore, this lesson will be taught in these five distinct parts.

### Teaching / learning activities

**Note:** The activities in this lesson should be done over a period of time with constant monitoring for learners to make and record observations.

#### (a) Use of Cuttings

#### Activity 9.6 (Refer to Pupil's book page 206)

- Ask learners to say what they think happens in cuttings as a vegetative propagation method. Take advantage and introduce activity 9.6.
- Guide learners to carry out this activity in groups. The composition of the groups should be informed by size and ability of learners.
- At the end of the experiment, learners should observe that the stem cuttings sprouted into young plants. Let them say or find out why this is so and share with other class members.

- You can then examples of plants that can be planted using stem cuttings such as sweet potatoes, cassava, sugarcane, yams, etc.

### **(b) Grafting**

#### **Activity 9.7 (Refer to Pupil's book page 206)**

- Put learners into groups depending on their abilities and class size. Let them study the diagram in this activity. They should do research and say what is happening.
- Let them find out why the activities in the picture are important.
- You can then inform them that the diagram is about grafting. Clarify that this is one of the methods of vegetative propagation just like use of stem cuttings.
- Summarise by explaining what happens during grafting and giving examples of plants that can be grafted such as oranges, lemons, mangoes and avocados.
- Wrap up this section by giving learners a project on grafting (See page 209 of pupil's book)

### **(c) Layering or marcotting**

Ask learners to say what they think happens in during layering as a vegetative propagation method. Take

advantage and introduce activity 9.8

#### **Activity 9.8 (Refer to Pupil's book page 207)**

- Guide learners to carry out this activity in groups. The composition of the groups should be informed by size and ability of learners.
- At the end of the experiment, learners should observe that the layered plant sprouted into a young plant. Let them say or find out why this is so and share with other class members.
- You can then summarise by highlighting key points as learners take summary notes. Refer to pupil's book page 207.

### **(d) Budding**

You can inform learners that budding is similar to grafting only that a bud is used.

- Summarise by explaining what happens during budding and giving examples of plants that can be budded.
- Wrap up this section by giving learners an activity to practice budding at home.

### (e) Use of suckers

Ask learners to say what they think happens when we use suckers as a vegetative propagation method. Take advantage and introduce activity 9.10.

#### **Activity 9.9(Refer to Pupil's book page 208)**

- Guide learners to carry out this activity in groups. The composition of the groups should be informed by size and ability of learners.
- At the end of the experiment, learners should separate the plantlets and grow them in separate field. They should take care of them until they become mature.
- You can then summarize by highlighting key points as learners take summary notes.
- **Synthesis**

This is a very long lesson as well sub divided into the five sections i.e. use of cuttings, grafting, layering, budding and use of suckers. Using the suggested activities and teaching approaches, allow learners to discover what goes on during these processes. Let them understand that this is alternative way of producing plants without seeds. It involves using parts of plants( leaves, stems, roots and branches) that sprout into a new plant. This new

plant is subjected to a growth process, develops into a mature plant which later produces seeds and / or can be vegetatively propagated.

#### **Lesson assessment**

Assess whether the learning objectives of the lesson were met by asking questions such as:

1. What is vegetative propagation?  
(Ans: Growing new plants from existing plant parts)
2. Give four methods of vegetative propagation.  
(Ans: Use of cuttings, grafting, budding, layering, use of suckers)
3. What is the other name for layering? (Ans: Marcotting)

#### **Lesson 5: Reasons for plant reproduction**

Refer to learner's book pages 208

#### **Specific objectives**

By the end of the lesson, learners should be able to explain reasons why plant reproduction is important.

### Preparation for the lesson

- Charts, textbooks, handouts and pamphlets on reproduction in flowering plants.
- Computers connected to the Internet.

### Pre-requisite of the lesson

- You may begin the lesson by asking learners what they think is the importance of plant reproduction.
- Build on their answers to introduce activity 9.10.

### Teaching / learning activities

#### Activity 9.10 (Refer to Pupil's book page 208)

- This is a research activity for individual learners. Let them go to the library and do research or search the Internet.
- They should write a report then share with the rest of the class.
- Back in class, let learners do presentations as you correct them. Guide them to discover the importance of plant reproduction as listed in their books on page 208.

### Lesson assessment

Assess whether the learning objectives of the lesson were met by asking questions such as:

1. State the importance of plant reproduction.

*(Ans: Refer to learner's book page 208)*

### Answers to Self-Test 9.1

*Refer to learner's book page 205*

1. Reproductive organ
2. Refer to Fig. 9.6 pupil's book page 201.
3. Anther and filament
4. Wind – cotton, Jacaranda;  
Water – coconut, water lily.
5. Corolla, calyx
6. Transfer of pollen grains from anther to stigma of a flower.
7. Self, wind.



## Summary of the unit

This unit deals with two major areas: sexual and asexual reproduction in plants. You should effectively use the suggested activities and the teaching approaches in the teacher's book to help learners acquire the competence about sexual reproduction process in plants and methods of asexual reproduction.

Emphasise the need for learners to behave responsibly in order to avoid destruction of environment as they collect samples for use during the experiments. At the end of the lessons, you should assess the extent to which the competencies have been achieved and attitude change towards environmental conservation. Plan remedial activities where necessary.

## Additional information for the teacher

Some information that may be relevant with regards to the reproductive system are given below.

- **Crop propagation** - Crop propagation involves the formation and development of new individual plants. This can happen sexually through seeds or asexually through vegetative planting materials.
- These are parts of plants, other than seeds, which can be used to produce new individual plants. Vegetative parts have the ability to grow into a whole new individual plant. The use of vegetative materials for plant propagation is known as **asexual reproduction**.
- This system of reproduction perpetuates crops as individual units. Below is a table showing various types of vegetative planting materials and a few examples of crops that are propagated by the respective planting materials.

**Table 9.1:Vegetative planting materials with examples**

Vegetative planting materials	Examples of crops
(a) Stems-cutting	Tea,sugarcane
(b) Leaves	Bryophyllum
(c) Suckers	Banana, pineapples
(d) Tubers	Irish potatoes
(e) Bulbs	Onions
(f) Corms	Cocoyams
(g) Rhizomes	Kikuyu grass
(h) Runners	Strawberry

**(a)Stems** - These are cuttings that can be developed from stems of plants. Stem cuttings can be raised in nurseries as in tea or planted directly in the field, as in sugarcane. Most cuttings for perennial crops are obtained from the hard sections of the plant parts.



Fig. 9.1 (a) Single leaf stem cuttings of a tea plant



Fig. 9.1 (b) Sugarcane sett

**(b) Leaves** - Bryophyllum pinnatum (Air plant, life plant, miracle leaf or goethe plant, is a succulent plant.

It is propagatted vegetatively by growing small plantlets on the fringes of the leaves. These eventually drop off and begin to root.



Fig.9.2 Leaf vegetative planting materials

**(c) Suckers** - These are lateral branches of a stem with terminal buds at the tips. They grow from the base of the underground stem; just beneath the soil surface. New shoots grow along the sucker with adventitious roots developing below the stem.



Fig. 9.3: A banana sucker

**(d) Tuber** - This is a swollen tip on an underground stem bearing a number of reduced scale leaves. Each scale leaf surrounds the 'eye' of the tuber. The eye is actually the bud. The buds produce aerial shoots and adventitious roots grow at the base.

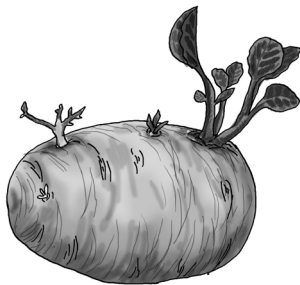

Fig. 9.4: Irish potato tuber

**(e) Bulb** - This is a flattened stem with nodes bearing fleshy scale leaves surrounded by some dry scale leaves. Buds arise in the axils of the fleshy scale leaves. The food is stored in the fleshy scale leaves and not in the stem. Adventitious roots are found at the base of the stem.



Fig. 9.5 Onion bulb

**(f) Corms** - These are short, thick, underground stems protected by dry scale leaves. A corm has one or more buds located on the underside of the leaf with adventitious roots at the base. The corm shrivels when the food reserves are used up as the buds grow into aerial shoots.



Fig. 9.6 A corm

**(g) Rhizomes** - These are horizontal underground stems which possess scale leaves and buds. The leaves are reduced to thin scales. In some plants, adventitious roots are present.



Fig. 9.7 A rhizome

### Advantages of vegetative propagation

- Crops originating from vegetable materials mature faster than those from seeds
- Vegetatively propagated plants exhibit uniformity in disease resistance, size, colour etc
- It is possible to produce many varieties of compatible crops on the same root stock.
- They germinate much faster compared to seeds because they cant go dormant.
- The resulting plant does not grow very tall hence making carrying out cultural practices like spraying practices like spraying, harvesting much easier
- Facilitates the propagation of seedlers or plants with low viability.

### Disadvantages of vegetative propagation

- It is difficult to control diseases hence an infected plant may easily transmit diseases to other plants.

- Materials are bulky hence difficult to store and transport.
- Vegetative propagation does not result in new crop varieties.
- Materials cannot be stored for long since they get spoilt.

### Answers to Unit Test 9 (Pupil's book Page 209

1. Pollination – transfer of pollen grains from anther to stigma of a flower; fertilization – fusion of male and female gametes to form a zygote.
2. Wind, water and animals
3. Stigma, anthers
4. Refer to Fig 9.3 and 9.4 pages 200-204 of pupil's book.
5. Root
6. Ovules, ovary
7. (a) Use of suckers  
(b) Use of cuttings
8. Wind
9. Refer to Fig. on page 206 (grafting) and page 207 (layering).
10. Water, warmth and air
11. Bees help in pollination
12. Refer to Fig 9.2 page 200 of pupil's book.
13. (a) - (vi)    (b) – (v)    (c) – (ii)  
(d) – (iii)    (e) - (i)    (f) – (iv)
14. (a) Fruit    (b) seeds
15. To attract insects or birds for pollination to occur.

### Additional activities to cater for slow and gifted learners

<b>Remedial activities for slow learners</b>	<b>Extended activities for gifted and talented learners</b>
<ol style="list-style-type: none"> <li>1. Drawing of charts on parts of a flower and seed on manila paper and hanging them on the wall for reference.</li> <li>2. Playing a game of naming parts of flower or seed. One points at a part and the other names.</li> </ol>	<ol style="list-style-type: none"> <li>1. Carrying out a project on grafting and budding and taking care of the plant until maturity.</li> <li>2. Helping the teacher to come up with improvised charts with various painted drawings on parts of</li> <li>3. Researching about other forms of vegetative propagation, writing a report and sharing in class.</li> </ol>
<b>Remedial questions for slow learners</b>	<b>Extended questions for gifted learners</b>
<ol style="list-style-type: none"> <li>1. _____ is transferring pollen from the anther to the stigma of a plant.</li> <li>2. Name three processes involved in sexual reproduction in plants.</li> <li>3. Draw and label parts of a monocot seed.</li> <li>4. Which agents of pollination do you know?</li> </ol>	<ol style="list-style-type: none"> <li>1. Discuss the risks of vegetative propagation.</li> <li>2. Why would you prefer asexual reproduction to sexual reproduction and vice versa?</li> <li>3. Describe an experiment that you would use to show the conditions necessary for germination.</li> </ol>
<b>Answers to remedial questions</b>	<b>Answers to extended questions</b>
<ol style="list-style-type: none"> <li>1. Pollination</li> <li>2. Pollination, fertilization, seed dispersal, germination.</li> <li>3. Refer to Fig. 9.9 page 190 pupil's book.</li> </ol>	<ol style="list-style-type: none"> <li>1. May transfer diseases and bad characteristics to the new plant.</li> <li>2. Refer to the content under advantages of vegetative reproduction above.</li> <li>3. Refer to Activity 9.3 pupil's book page 201.</li> </ol>

**UNIT  
10**

**Sustainable waste management**  
(No. of periods: 10)

*Refer to the Learner's Book pages 211 - 220*

**Key Unit Competency**

After studying this unit, learners should be able to apply garbage collection techniques and separate hazardous, organic and recyclable waste.

**Learning objectives**

Competency based curriculum embraces three categories of learning objectives,

that is, knowledge and understanding, skills acquisition and attitude and values. At the end of the unit, learners should have knowledge and understanding of sustainable waste management systems and have the right attitude towards conserving the environment.

**Table 10.1: Knowledge, skills and values to be attained**

<b>Knowledge and understanding</b>	<b>Skills</b>	<b>Attitudes and values</b>
<p>By the end of this unit, the learner should be able to:</p> <ul style="list-style-type: none"> <li><input type="checkbox"/> Differentiate biodegradable from non-biodegradable types of waste.</li> <li><input type="checkbox"/> Identify different sources of waste.</li> <li><input type="checkbox"/> Cite and explain the waste management techniques.</li> </ul>	<p>By the end of this unit, the learner should be able to:</p> <ul style="list-style-type: none"> <li><input type="checkbox"/> Apply knowledge to recognize biodegradable and non-biodegradable waste in our environment</li> <li><input type="checkbox"/> Carry out an investigation to discover different waste management techniques.</li> </ul>	<p>By the end of this unit, the learner should be able to:</p> <ul style="list-style-type: none"> <li><input type="checkbox"/> Be aware of existence of inflammable / explosive / corrosive / toxic waste materials in the environment</li> <li><input type="checkbox"/> Show concern to separate hazardous, organic and recyclable waste as away of saving the environment.</li> </ul>

	<input type="checkbox"/> Apply basic waste management technique	<input type="checkbox"/> Develop positive attitude to perform professional garbage collection techniques.
--	---	---

### Pre-requisite of this unit

This is a relatively new topic to learners. However it is closely related to what pupils learnt in primary 4 about the environment and in primary 5 under water and water pollution. You may take advantage of that and introduce the concept of proper waste management as a way of keeping our environment clean. You may also bring to the attention of learners the fact that the concepts in this unit can be applied in environmental management in social studies, environmental chemistry and Agriculture. Further, learners should be made aware of the fact that when they continue with their education in this area, they may become environmentalists.

### Background information

This unit is about sources of wastes and how to manage wastes in our environment. If we do not manage wastes, it becomes a problem in our environment. You are therefore expected to show learners how to manage wastes and how to ensure that we stay in a clean environment in general.

### Cross cutting issues

#### 1. Standardization culture

Emphasize the need to use certified equipment and machines which do not pollute the environment when dealing with wastes. Caution learners against using counterfeits which may lead to accidents or injury of users or frequent breakdowns.

#### 2. Inclusive learning

All learners should be encouraged to participate during lessons and practicals. Special arrangement should be made to take care of learners with special needs. For example, provide brail for blind learners, large print text for those with sight problems and allocate physically challenged learners to others to assist them during field trips and practical activities. Further, this category should be given tasks that they can manage during the practical sessions.

#### 3. Financial education

Learners should be made aware of the fact that a clean environment ensures healthy living devoid of

diseases hence helps to reduce health related costs. Also, buying quality equipment will lead to saving money in the long run as they stay for long and costs on repairs are reduced.

#### **4. Environment, climate change and sustainability**

This is a topic that directly affects the environment. Emphasize the need to reduce wastes in our environment and other forms of pollution in general. Caution learners against activities that may cause environmental pollution in general.

#### **5. Peace and values education**

People should learn to live in harmony and they should be ready to help other people, especially those who are affected by natural disasters like floods or landslides.

#### **6. Gender education**

Both boys and girls should participate in conserving our environment. It is not a preserve of the boy or girl gender. Also, emphasize to learners that anybody irrespective of their gender can pursue a carrier in environmental health. Give examples of role models who are successful in the area where the learners come from.

### **Generic Competences**

#### **1. Co-operation and interpersonal management and life skills**

During group discussions and pair-work let learners engage one another by giving a chance for all to participate. Also, during group presentations, you can allow rotational presentations within the group members. Gifted learners should help in coming up with presentation content as slow learners contribute. **REMEMBER** You should allow slow learners to do presentations as well and correct them where they go wrong. Advise learners to appreciate the different abilities of their group members and accommodate each other's views.

#### **2. Research skills**

Guide learners on how to find information regarding various topics such as the meaning of air pollution and its consequences. Guide learners on how to come up with summarized notes from a large body of text. You should also guide learners on doing Internet searches for the various content areas they are looking for.

#### **3. Communication in English**

Communication in English will be improved when learners freely participate in the discussions and presentations. Encourage all learners irrespective of their abilities to participate in-group discussions,



during presentations by asking questions and during question and answer sessions to either introduce or wrap up the lessons.

#### 4. **Critical thinking and problem solving skills**

This competence will be developed by learners as they answer the probing questions such as those on page 212 at the beginning of this unit and as they discuss the results of the various practical activities. Guide learners to discover for themselves the various sources of wastes in the environment and their consequences. This competence will also come about as learners think about their findings in the activities and as they give out their suggestions on why this is the case.

#### 5. **Lifelong skills**

Knowing how to prevent environmental pollution by wastes is a lifelong skill that will ensure healthy living for all in the society.

#### 6. **Creativity and innovation**

Encourage learners to come up with innovative ways of managing wastes and maintaining a clean environment.

#### **Key words in this unit and their meanings**

- **Waste** – An unusable or unwanted substance or material in the environment.

- **Biodegradable**- wastes that can be decomposed by natural methods.
- **Hazard** – substance or chemical that can cause harm.
- **Non-biodegradable**- wastes that cannot be decomposed by natural methods.
- **Recycle** – To recondition and adapt to a new use or function.
- **Re-use** – to use again, especially after salvaging or special treatment or processing.
- **E-waste** – wastes from electronic materials or equipment.
- **Landfill** – A site for the disposal of solid waste in which refuse is buried between layers of dirt.
- **Incinerator** – a furnace or other container for burning rubbish without polluting the environment.

#### **Guidance on the problem statement**

In this topic, you will teach about sustainable wastes management and sources of wastes. To introduce the unit, let learners study what is going on on page 211 of their books. It is about improperly disposed of wastes. Children are playing nearby and one of them have gotten hurt. Let learners brainstorm and give solutions to the problem in the picture.

## Attention to special educational needs

Support for Multi-ability learning	Support for special needs learning
<ul style="list-style-type: none"> <li>▪ <b>Peer-teaching</b> – engage high achievers to help weak pupils in understanding of concepts.</li> <li>▪ Plan remedial teaching for slow learners.</li> <li>▪ Allow enough time to slow learners to complete their work.</li> <li>▪ Gifted learners to be given heavy tasks requiring more critical thinking while slow learners are given tasks, which they can manage such as collecting materials for use during practicals among others.</li> <li>▪ Both gifted and slow learners to be given equal opportunity to lead in group discussions and to do presentations of group findings to the rest of the class.</li> <li>▪ Ensure all learners respect other's views irrespective of their shortcomings or talents.</li> </ul>	<ul style="list-style-type: none"> <li>▪ Identify the learners with hearing and visual impairment and have them sit in front of the class so that proper attention can be given to them. Also, large print texts should be given to visually impaired learners and hearing aids provided for those with hearing impairment.</li> <li>▪ Arrange the room such that it will enable easy movement for the physically challenged learners.</li> <li>▪ Assign some students to be in charge of the physically and visually impaired learners. For example, carrying their equipment, showing them around during the field trips, etc.</li> <li>▪ Organize Braille for blind learners.</li> <li>▪ Encourage special needs learners by reminding them that 'disability is not inability'!</li> </ul>

## List of lessons

Lesson No.	Lesson title	No. of Periods
1.	Classification of wastes	2
2.	Sources of wastes	3
3.	Wastes management techniques	5

## LESSON 1: Classification of wastes

Refer to learner's book pages 211 –213

### Specific objectives

By the end of the lesson, learners should be able to differentiate between biodegradable and non-biodegradable wastes.

### Preparation for the lesson

- This lesson will involve individual research work and group discussions. You will therefore organize the class as need arises during the lesson. **REMEMBER:** When grouping learners, you should consider the different abilities of learners and the special needs for various individuals.
- Ensure the internet is working properly before the lesson for learners to use to do research.

### Teaching Aids

- Computers connected to the Internet.
- Textbooks, pamphlets, handouts and charts on waste management.

### Pre-requisite of the lesson

Introduce the unit as explained under guidance on the problem statement above then narrow down to this lesson.

### Teaching / learning activities

- You may begin the lesson by asking learners probing questions such as: Have you ever heard of the word 'waste? What does it mean?

### Activity 10.1 (Refer to Pupil's book page 212)

- This is a research activity to be done by individual learners followed by discussion with other class members. Let learners go to the library to read textbooks on the meaning of waste and the various types of wastes They can also visit web pages where they can get this information. For example: <http://www.scholar.google.com> or by simply searching the phrase 'air pollution using google search engine.
- Guide learners to discover the definition of waste, which is 'any unwanted material in the environment.
- Emphasise the fact that we should avoid polluting the environment at all times.

- At this point, guide learners to go through the chart on page 212 then answer the questions associated with the chart.
- Let learners give the answers to the questions as you correct them. Examples of categories of wastes are: biodegradable and non-biodegradable wastes. You can also mention that wastes are further divided into hazardous, toxic, radioactive and flammable wastes.
- Explain the above kinds of wastes as learners write summary notes. Refer to learners book pages 212
- Remind learners that it is important to always separate wastes into biodegradable/non-biodegradable, hazardous, recyclable, etc.
- Let learners take a walk around the school compound. Let them identify the types of wastes that they can see.
- Guide learners to group the wastes as shown in the table. Let them compare their work to those of other class members.
- Guide learners to find out the advantages and disadvantages of the various types of wastes.
- Remind learners of the golden rule which is 'the 3Rs – recycle, re-use and reduce. Encourage them to always practice this when they come across wastes!

## Synthesis

The lesson introduces learners to knowledge about wastes and their management. Let learners use the research activity and the discussion session to discover the definition of waste and the various categories of wastes. Guide them to appreciate the importance of proper waste management by observing the 3r rule.

## Lesson assessment

Assess whether the learning objectives of the lesson were met by asking questions such as:

1. What is waste?  
(Ans: any unwanted material in the environment)
2. (a) Mention the two main categories of wastes.  
(Ans: Biodegradable and non biodegradable wastes)  
(b) What is the difference between them?  
(Ans: Biodegradable – can decompose naturally, non biodegradable wastes – cannot decompose naturally)
3. (a) Which other categories of wastes do you know?  
(Ans: Hazardous, toxic, radioactive and flammable wastes)

## LESSON 2: Sources of wastes

Refer to learner's book pages 213

### Specific objectives

By the end of the lesson, learners should be able to identify different sources of wastes.

### Preparation for the lesson

1. This lesson will involve a group discussion and individual research work. You will therefore organize the class as need arises during the lesson.

**REMEMBER:** When grouping learners, you should consider the different abilities of learners and the special needs for various individuals.

2. Ensure the internet is working properly before the lesson for learners to use to do research.

### Teaching aids

- Computers connected to the Internet.
- Textbooks, pamphlets, handouts and charts on air pollution.

### Pre-requisite of the lesson

You may introduce the lesson by reminding learners what they learnt under meaning of wastes. Let volunteers define what it is. Build on this and ask whether the learners know where wastes come from. Let them have a brainstorming session.

### Teaching / learning activities

Let learners think about the activities that take place in various places where they stay. They should then say which ones create wastes based on the hints given in this activity.

- You may also guide the learners to make a field study and observe physically the sources of wastes.
- Let them come up with a report and share with the other members of the class.
- Some of wastes include urban/municipal wastes, industrial wastes, agricultural wastes, construction and biomedical wastes, electronic wastes and wastes from automobiles.
- Summarise by highlighting main points as learners write summary notes.

## Synthesis

The lesson is about sources of wastes. Learners should be able to use the discussion and research activities suggested to discover the various sources of wastes.

## Lesson assessment

Assess whether the learning objectives of the lesson were met by asking questions such as:

1. What sources of wastes do you know of?

*(Ans: Municipal, industrial construction, agricultural, biomedical, electronic and automobile wastes)*

2. What is the difference between biomedical wastes and electronic wastes?

*(Ans: Biomedical – from hospitals and health centres; electronic – from electronic equipment).*

## LESSON 3: Wastes management techniques

Refer to learner's book pages 217

## Specific objectives

By the end of the lesson, learners should be able to cite, explain and practice waste management techniques.

## Preparation for the lesson

- This lesson will involve an academic visit and group discussions. You will therefore organize the class as need arises during the lesson. **REMEMBER:** When grouping learners, you should consider the different abilities of learners and the special needs for various individuals.
- Ensure the internet is working properly before the lesson for learners to use to do research.

## Teaching aids

- Computers connected to the Internet.
- Textbooks, pamphlets, handouts and charts on air pollution.

## Improvisation

Recycle waste bottles or buckets for use to store wastes.

### Pre-requisite of the lesson

You may introduce the lesson using probing questions such as ‘what are some of the techniques that can be used to manage wastes? Let them have a brainstorming session.

### Teaching / learning activities

#### Activity 10.3 (Refer to Pupil’s book page 217)

- Take learners for a visit to a nearby local authority. While there, let learners find out how they manage wastes.
- They should also do individual research work on how wastes can be managed. Let them come up with a report and share with other members of the class.
- At this point, you may let learners know that waste management begins with collection, processing (whereby wastes are separated into those that are biodegradable and those that are not, hazardous, toxic, radioactive etc), this is followed by safe transportation to disposal site or a landfill.
- Summarise the lesson by highlighting main points as learners

write summary notes. Wind up by giving learners a task of cleaning their school compound.

### Synthesis

This lesson should help learners understand the various methods of waste disposal. Learners should then use the knowledge gained during the academic visit and the discussion activities to identify the various methods of safe waste disposal.

### Lesson assessment

Assess whether the learning objectives of the lesson were met by asking questions such as:

1. Give four ways of disposing of wastes safely.

*(Ans: safe collection, processing, transportation and finally disposal)*

### Answers to Unit Test 10 (Page 220)

1. Taking care of wastes to reduce its impact on the environment.
2. Non - biodegradable – cannot be

decomposed naturally for example polythene and plastics; degradable, can be decomposed for example, kitchen wastes.

3. (a) Wastes that can cause harm  
(b) Biomedical wastes – can transmit diseases.
4. To recycle is to change to something else then use again; re-use is to use for a different purpose.
5. By putting in place strict legislations that hinder environmental degradation and educating the masses on the importance of environmental conservation.
6. Recycle, Re-use, Reduce.
- 7.

Type of waste	Example	How to manage
Industrial	Smoke	Fitting chimneys and catalytic converters
Medical	Syringes and needles	Incineration
Electronic	Old computer parts	Recycling
Agricultural	Chemical containers	Re-using

8. Professional way of managing garbage which involves collection, processing, transportation and finally disposal.
9. This was very wrong as it will

cause environmental pollution.

10. Gamka should desist from this habit as a dirty environment harbors disease-causing germs.
11. A place where wastes are dumped in the city. It helps to avoid disposal of waste everywhere in the locally. This ensures that the environment remains clean and attractive.
12. They should be incinerated.
13. We use various items in our lives which are very essential and we cannot do without.



### Additional activities to cater for slow and gifted learners

Remedial activities for slow learners	Extended activities for gifted and talented learners
<ol style="list-style-type: none"> <li>1. Cleaning the environment around home.</li> <li>2. Collecting rubbish around school compound.</li> </ol>	<ol style="list-style-type: none"> <li>1. Making makeshift dust bins using banana fibres.</li> <li>2. Researching more about wastes management, writing notes and sharing with other class members.</li> </ol>
Remedial questions for slow learners	Extended questions for gifted learners
<ol style="list-style-type: none"> <li>1. Waste is _____.</li> <li>2. _____, _____, _____ are examples of non biodegradable wastes.</li> <li>3. How would you manage hazardous wastes?</li> </ol>	<ol style="list-style-type: none"> <li>1. What are radioactive wastes.</li> <li>2. What is the other name of biodegradable wastes?</li> <li>3. Describe the process of managing wastes professionally.</li> </ol>
Answers to remedial questions	Answers to extended questions
<ol style="list-style-type: none"> <li>1. Unwanted materials in the environment.</li> <li>2. Polythene, pipes and plastics.</li> <li>3. Burning in an incinerator.</li> </ol>	<ol style="list-style-type: none"> <li>1. Wastes that emit radiations.</li> <li>2. Organic wastes</li> <li>3. Collecting, processing, transporting and finally disposing in a landfill.</li> </ol>

*Refer to the Learner's Book pages 221 - 235*

**Key unit competency**

After studying this unit, learners should be able to describe and explain the functioning of the circulatory system, its hygiene and maintenance.

that is, knowledge and understanding, skills acquisition and attitude and values. At the end of the unit, learners should have knowledge and understanding of the circulatory system and have the right attitude towards taking care of it.

**Learning objectives**

Competency based curriculum embraces three categories of learning objectives,

**Table 11.1 Knowledge, skills and values to be attained**

<b>Knowledge and understanding</b>	<b>Skills</b>	<b>Attitudes and values</b>
<p>By the end of this unit, learners should be able to:</p> <ul style="list-style-type: none"> <li><input type="checkbox"/> Explain the main function of circulatory system.</li> <li><input type="checkbox"/> Describe the human circulatory system.</li> <li><input type="checkbox"/> Explain the process of blood circulation.</li> <li><input type="checkbox"/> Explain the composition of blood.</li> <li><input type="checkbox"/> Explain the hygiene of the human circulatory.</li> <li><input type="checkbox"/> Interpret the blood pressure measurement for different persons.</li> </ul>	<p>By the end of this unit, learners should be able to:</p> <ul style="list-style-type: none"> <li><input type="checkbox"/> Draw and label the human circulatory system.</li> <li><input type="checkbox"/> Observe the components of the circulatory system and predict the functions of each of them.</li> <li><input type="checkbox"/> Practice hygiene of human circulatory system.</li> <li><input type="checkbox"/> Count and compare the heart beats for different persons.</li> </ul>	<p>By the end of this unit, learners should be able to:</p> <ul style="list-style-type: none"> <li><input type="checkbox"/> Show concern about the hygiene of the circulatory system.</li> <li><input type="checkbox"/> Show awareness of circulatory system diseases.</li> <li><input type="checkbox"/> Take care of his/her circulatory system.</li> <li><input type="checkbox"/> Develop a habit of regular blood pressure check up.</li> </ul>

### **Pre-requisite of this unit**

Learners have already been introduced to human body since lower primary. They however started learning more advanced concept at primary four. For example, they learnt about the various sense organs and human skeleton in this class. In primary 5, they learnt about the digestive and reproductive systems. In this class, they will further on their knowledge in this area by learning about the circulatory and respiratory systems. During the lessons, strive to bring to the awareness of learners the fact that this topic is related to circulatory system in biology that they will study at higher levels of learning. Let them understand that at this level, they may only need the basic information otherwise, details of functioning of the circulatory system will be learnt in high school and even better, when later in life, they specialize in the area of medicine and particularly cardiology.

### **Background information**

Circulatory system is very important in the life of human beings and animals in general. As you are already aware, human body is made up of many systems that work together. This particular system helps in the transportation of oxygen and other substances required in different parts of the body. It also helps in the transportation of waste products of metabolism in the body. This topic will therefore enable learners realize the need for a circulatory system in the body. They will also know the various conditions that affect the circulatory system and how to maintain proper hygiene of the heart and other circulatory system organs in general.

### **Cross-cutting issues to be addressed**

#### **1. Standardization culture**

Bring to the attention of learners the need to seek medical healthcare in standard and quality hospitals whenever they have problems with their circulatory system.

#### **2. Financial education**

Emphasize the fact that learners should practice good hygiene to avoid conditions and disease of the circulatory system in order to avoid spending money on treatment.

#### **3. Gender education**

Emphasize to learners that anybody irrespective of their gender can pursue a career in medicine. Give examples of role models who are successful cardiologists or specialist doctors in the area where the learners come from.

#### **4. Inclusive education**

All learners should be encouraged to participate during lessons and practicals. Special arrangement should be done to take care of learners with special needs. For example, provide brail for blind learners, large print text for those with sight problems and allocate physically challenged learners to others to assist them during field trips and practical activities. Further, this category should be given tasks that they can manage during the practical sessions.

## Generic Competences

### 1. Co-operation and interpersonal management and life skills

During group discussions and pair-work let learners engage one another by giving a chance for all to participate. Also, during group presentations, you can allow rotational presentations within the group members. Gifted learners should help in coming up with presentation content as slow learners contribute. **REMEMBER** You should allow slow learners to do presentations as well and correct them where they go wrong. Further, advise learners to appreciate the different abilities of their group members and accommodate each other's views.

### 2. Research skills

Guide learners on how to find out information regarding circulatory system and diseases that affect it. Guide learners on how to come up with summarized notes from a large body of text. This they should do by first identifying major points and listing them down. You should also guide learners on doing Internet searches for the various content areas they are looking for. Learners can use 'single word searches or well crafted 'phrases' in order to get the relevant information they are looking for.

### 3. Communication in English

Communication in English will be improved when learners freely

participate in the discussions and presentations. Encourage all learners irrespective of their abilities to participate in group discussions, during presentations by asking questions and during question and answer sessions to either introduce or wrap up the lessons.

### 4. Critical thinking

Guide learners to discover for themselves various aspects of the human circulatory system through the various practical activities, probing questions and the videos that they will be watching during the lessons. This competence will also come about as learners think about their findings in the activities and as give out their suggestions.

### 5. Lifelong skills

Practicing hygiene of the heart and the circulatory system in general creates a habit of taking care of oneself. Learners can also pass this habit to others through training. Also, make learners aware that they can become doctors and particularly cardiologists if they take this topic seriously.

### Key words in this unit and their meanings

- **Antherosclerosis** – This is a condition that refers to hardening of arteries and/or veins. This causes the narrowing of the lumen or blocking of the affected artery/vein due to formation of a clot.

- **Antibodies** – These are special proteins that are produced in the body as a result of introduction of an antigen (which is a foreign body) in the body. Antibodies help to fight diseases in the body.
- **Arteries** – blood vessels which are usually narrower than veins and which carry blood away from the heart to other body parts.
- **Auricles** – the upper chambers of the heart where blood is received from the rest of the body. They have thinner walls than ventricles.
- **Blood** - the red fluid consisting of plasma, blood cells and platelets the nourishes and supplies oxygen to tissues.
- **Blood vessels** – these are the tubes through which blood is transported throughout the body. They are of three types: arteries, veins and capillaries.
- **Capillaries** – these are the smallest blood vessels which form a network at tissue level. They have thin walls and tiny pores which allow for exchange of materials between blood and body tissues.
- **Heart** – the muscular organ located in the chest between the lungs that pumps blood throughout the body.
- **Heart attack** – one of the diseases of the circulatory system that is as a result of blocked arteries or high blood pressure.
- **High blood pressure** – a disease of the circulatory system associated with increased blood pressure as a result of faster pumping action of the heart.
- **Hormones** – chemical messengers which are protein in nature and are produced by the endocrine glands that help in controlling body functions.
- **Plasma** – the liquid part of blood which is mostly water but which contains digested food materials, mineral salts, dissolved metabolic waste products and hormones.
- **Platelets** – one of the many components of blood which are responsible for the clotting process.
- **Sphygmomanometer** – the instrument used to measure blood pressure.
- **Stroke** – a disease of the circulatory system which causes parts of the body not to move due to damage of sections of the brain.
- **Thrombosis** – this refers to the condition whereby an artery or a vein is obstructed by a blood clot. It may lead to heart attack.
- **Valves** – flaps of flesh found either in the heart or veins that ensure that blood flows only in one direction.
- **Veins** - blood vessels which are usually broader than arteries and which carry blood towards the heart from the rest of the body.
- **Ventricles** - the lower chambers of the heart where blood is received from auricles and pumped away

from the heart. They have thicker walls than auricles.

**Guidance on the problem statement**

This unit is about the circulatory system and its importance in the body. As a way of introducing the concepts, refer learners to the diagrams on page 221

of their book. The diagrams are about an overweight man having problems walking and the children laughing at him (A). The man later goes to hospital and the nurse realises that his blood pressure is very high (B). He needs to do something about his weight as it may affect the functioning of his circulatory system.

**Attention to special educational needs**

Support for Multi-ability learning	Support for special needs learning
<ul style="list-style-type: none"> <li>– Slow learners can point at the various parts on the charts as gifted learners name the parts and explain their functions.</li> <li>– When watching videos, you may repeat or pause for the benefit of slow learners.</li> <li>– Both gifted and slow learners to be given equal opportunity to lead in group discussions and to do presentations of group findings to the rest of the class.</li> <li>– Ensure all learners respect other’s views irrespective of their shortcomings or talents.</li> </ul>	<ul style="list-style-type: none"> <li>– Allocate roles like holding charts and dismantling models like the heart model to learners with physical disabilities.</li> <li>– Provide brail for blind learners and large print text to learners with seeing difficulties. Provide sign language alphabet symbols for the deaf and sign language interpreters.</li> <li>– Also, arrange learners such that shortsighted ones are at the front and long-sighted ones are at the back. Spectacles can as well be provided if available.</li> </ul>

## List of lessons

Lesson No.	Lesson title	No. of periods
1.	Main organs of the human circulatory system and its function	1
2.	Structure of the heart and its functions	1
3.	Blood vessels and their functions	1
4.	The process of blood circulation	1
5.	Components of blood	1
6.	Hygiene of the circulatory system	1
7.	Circulatory system diseases	1
8.	Blood pressure and its measurement	1

### Lesson 1: Main organs of the human circulatory system and its function

Refer to learner's book pages 222-223

#### Specific objectives

By the end of the lesson, learners should be able to:

- Explain the main function of human circulatory system
- Name and identify the organs that make up the human circulatory system.

#### Preparation for the lesson

1. This lesson will involve individual work, video watching, research work and group activities. You will therefore organize the class as need arises during the lesson.  
**REMEMBER:** When grouping

learners, you should consider the different abilities of learners and the special needs for various individuals.

2. Bring pamphlets, handouts, and textbooks for reference in class. Also, ensure that the Internet is working if you have a computer laboratory or any other form of internet connectivity such as WIFI or modem.
3. Test the link: [https://www.youtube.com/watch?v=\\_qmNCJxpsr0](https://www.youtube.com/watch?v=_qmNCJxpsr0) in advance to see if it is working. This link has a video on circulation of blood, which is part of one of the activities in this lesson.
4. Obtain wall charts on circulatory system and other materials in advance.

#### Teaching aids

- Charts on parts of the human circulatory system, textbooks, pamphlets and hand outs on circulatory system.

- Video link: <https://www.youtube.com/watch?v=qmNCJxpsr0>

**IMPROVISATION:** You may come up with your own charts drawn on manila papers in case your school does not have the circulatory system charts.

### Pre-requisite of the lesson

- Introduce the unit as explained under guidance on the problem statement above then narrow down to this lesson.
- Ask probing questions to introduce the lesson. Such questions may include:
  - (i) Which body processes do you know? (*Ans: excretion, respiration, circulation, reproduction*)
  - (ii) What is their role in human body? (*Ans: Removal of wastes, production of energy, transportation, procreation*)
- From the probing questions, learners may mention circulatory system. Take advantage and introduce it.

### Teaching / learning activities

*Find out (Refer to Pupil's book page 221)*

- This is a research activity. Provide learners with handouts, pamphlets and textbooks and ask them to find out what circulatory system is and what its function in the body is. They can also refer to the internet.
- Let learners have a brief discussion

session on their findings then write summary notes. Correct them as is appropriate. Refer to notes on page 222 of pupil's book on importance of the circulatory system.

### Activity 11.1 (Refer to Pupil's book page 221)

- This activity is meant to introduce the organs that make up the circulatory system.
- Let the learners watch the video carefully. They should note how the blood flows and the organs that are involved.
- Show learners the charts on the circulatory system. Using the charts, they should identify the organs they observed in the video.
- Let them write the names of the organs that make up the circulatory system and briefly explain their roles. The organs are:
  - (i) Heart – pump blood throughout the body
  - (ii) Blood vessels – tubes through which blood flows
  - (iii) Blood – circulates throughout the body
- Summarise the lesson by highlighting the key points, which should include the role of circulatory system in human body and the various organs that make up the circulatory system.



## Synthesis

The lesson introduces learners to the human circulatory system. The activities carried out during the lesson above should help learners identify the various organs that make up the circulatory system and appreciate its function in the body.

## Lesson assessment

Assess whether the learning objectives of the lesson were met by asking questions such as:

1. What did you learn in this lesson?  
*(Ans: The function of the circulatory system in human body and the organs that make up the circulatory system.)*
2. What are some of the processes that take place in human body?  
*(Ans: Respiration, excretion, digestion, circulation of blood, reproduction among others.)*
3. What makes up the circulatory system?  
*(Ans: The heart, blood and blood vessels)*
4. Suppose we lacked a circulatory system, what will happen? *Ans: We will not survive because our body tissues will lack oxygen, will not have digested nutrients, will not remove waste products and hormones will not be distributed throughout the body for their action. Also, antibodies and white blood cells will not go to sites where they are needed to fight diseases. This will lead to death of cells and tissues hence death of the individual.)*

## Lesson 2: Structure of the heart

Refer to learner's book pages 222-223

### Specific objectives

By the end of the lesson, learners should be able to:

- Explain the structure of the heart.
- Draw and label the heart.
- Describe the functions of the various parts of the heart.

### Preparation for the lesson

1. This lesson will involve individual work, video watching, and group activities. You will therefore organize the class as need arises during the lesson. **REMEMBER:** When grouping learners, you should consider the different abilities of learners and the special needs for various individuals.
2. Bring reference textbooks to class. Also, ensure that the Internet is working if you have a computer laboratory or any other form of Internet connectivity such as WIFI or modem.
3. Test the link: [https://www.youtube.com/watch?v=\\_qmNCJxpsr0](https://www.youtube.com/watch?v=_qmNCJxpsr0) in advance to see if it is working. This link has a video on circulation of blood, which is part of one of the activities in this lesson.

4. Obtain wall charts on structure of the heart and other materials in advance.

### Teaching aids

- Charts on parts structure of the heart and textbooks, on circulatory system.
- Video link: [https://www.youtube.com/watch?v=\\_qmNCJxpsr0](https://www.youtube.com/watch?v=_qmNCJxpsr0)
- Heart model

### Improvisation

You may come up with your own chart of structure of the heart drawn on manila papers in case your school does not have one. You can also organize for learners to model a heart using clay or plasticine.

### Pre-requisite of the lesson

- Ask probing questions to introduce the lesson. Such questions may include:
  - (i) What do you think is the function of the heart in human body? (Ans: *Pumping of blood*)
  - (ii) Based on that, how should the heart look like? (Ans: *should generate enough power to pump*)
- Lead a brainstorming session on the structure of the heart giving comparisons to other types of pumps and their features then narrow down to the content of this lesson as explained below.

### Teaching / learning activities

#### Activity 11.2 (Refer to Pupil's book page 222)

- Let the learners watch the video carefully. They should describe what is happening to the heart in the video. (The pumping action)
- Ask learners where they think the heart gets the energy it uses to pump the blood. (Its muscles as they contract and expand)
- Guide learners to dismantle the model of the heart. Assist them to identify the various parts.
- At this point, you can show learners the chart on the structure of the heart. Using the charts, they should identify the parts that make up the heart.
- Let them draw the structure of the heart in their notebooks and label it.
- Summarise the lesson by highlighting the key points on the parts that make up the heart and their functions. Allow learners to write summary notes as you do your presentation. You can also make this more interactive by inviting gifted learners to do lesson summary as you guide them.

### Synthesis

This lesson introduces learners to the structure of the heart. Use the video, heart model and the charts to guide learners to accurately describe the structure of the heart and state its function.

## Lesson assessment

Assess whether the learning objectives of the lesson were met by asking questions such as:

1. Which parts make up the heart?
  - (a) Externally?  
(Ans: Auricles, ventricles, aorta, vena cava, pulmonary artery, pulmonary vein, coronary artery.)
  - (b) Internally?  
(Ans: Septum, bicuspid valve, tricuspid valve, semi-lunar valves.)
2. State the role of each part of the heart.  
(Ans: Refer to pupil's book page 238)
3. Why do ventricles have thicker walls than auricles?  
(Ans: Because they pump blood over a longer distance (to the rest of the body) compared to auricles which only push the blood to ventricles within the heart.)
4. Why is separation of the heart into two distinct parts important?  
(Ans: This helps to avoid mixing of oxygenated and deoxygenated blood)

## Lesson 3: Blood vessels and their functions

Refer to learner's book pages 224

### Specific objectives

By the end of the lesson, learners should be able to:

- Name the types of blood vessels.
- Describe the functions of the various types of blood vessels.

## Preparation for the lesson

1. This lesson will involve group work. **REMEMBER:** When grouping learners, you should consider the different abilities and the special needs for various individuals.
2. Test the link: [https://www.youtube.com/watch?v=\\_qmNCJxpsr0](https://www.youtube.com/watch?v=_qmNCJxpsr0) in advance to see if it is working. This link has a video on circulation of blood, which is part of one of the activities in this lesson.
3. Obtain wall charts on various blood vessels in advance.

## Teaching aids

- Charts on blood vessels.
- Video link: [https://www.youtube.com/watch?v=\\_qmNCJxpsr0](https://www.youtube.com/watch?v=_qmNCJxpsr0)

**IMPROVISATION:** You may come up with your own chart on various blood vessels drawn on manila papers in case your school does not have one.

## Pre-requisite of the lesson

Ask probing questions to introduce the lesson. Such questions may include:

1. What are blood vessels?  
(Ans. Pathways through which blood travels in the body).
2. How do you think they look like?  
(Ans. Tube-like)

Why? (Ans: Because they have to have space for movement of blood and this must be continuous). Let learners brainstorm about these questions then narrow down to the content of this lesson, which is types of blood vessels and their functions.

### Teaching / learning activities

#### Activity 11.4 (Refer to Pupil's book page 224)

- Put learners in pairs considering their abilities. Let them carry out this activity.
- Guide learners to answer question 4 in the activity - Ans: The water will not be supplied to the tap) and to summarize their points.
- Let the learners watch the video on the link: [https://www.youtube.com/watch?v=\\_qmNCJxpsr0](https://www.youtube.com/watch?v=_qmNCJxpsr0) carefully. They should identify the blue and the red coloured vessels. (Ans: Blue – Veins, Red - Arteries)
- Provide learners with the charts on the blood vessels. Help them identify the various vessels. (Its muscles as they contract and expand)
- At this point, you can introduce the three types of blood vessels i.e. arteries, veins and capillaries.
- Let learners draw the blood vessels in their notebooks and label them.
- You can then guide learners to feel the pulse at the wrist as shown in procedure 4. Let them repeat this several times and count the number of heartbeats. They should come up with an average (Ans: 72 beats per

minute)

- Summarise the lesson by highlighting the key points about blood vessels, pulse and heart beat.
- Finalise by giving learners a task of coming up with a table on differences between arteries and veins.

### Synthesis

This lesson introduces learners to blood vessels and their role in the circulatory system. Use the video and charts to guide learners to discover the various types of blood vessels, their functions and the differences between them.

### Lesson assessment

Assess whether the learning objectives of the lesson were met by asking questions such as:

1. The three types of blood vessels are \_\_\_\_\_, \_\_\_\_\_ and \_\_\_\_\_.  
(Ans: Arteries, veins and capillaries).
2. Which blood vessels:
  - (a) carry blood away from the heart? (Ans: Veins)
  - (b) carry blood towards the heart? (Ans: Arteries)
  - (c) form a network inside tissues? (Ans: Capillaries)
3. What is pulse?  
(Ans: Heart beat)
4. The heart beats \_\_\_\_\_ times per minute. (Ans: 72)

## Lesson 4: The process of circulation of blood

Refer to learner's book pages 224-227

### Specific objectives

By the end of the lesson, learners should be able to explain the process of circulation of blood in the body.

### Preparation for the lesson

1. This lesson will be a whole class lesson.
2. Test the link: [https://www.youtube.com/watch?v=\\_qmNCJxpsr0](https://www.youtube.com/watch?v=_qmNCJxpsr0) in advance to see if it is working. This link has a video on circulation of blood, which is one of the activities in this lesson.
3. Obtain wall charts on circulation of blood in advance.

### Teaching aids

- Charts on circulation of blood in human body.
- Video link: [https://www.youtube.com/watch?v=\\_qmNCJxpsr0](https://www.youtube.com/watch?v=_qmNCJxpsr0)

### Improvisation

You may come up with your own chart on blood circulation by drawing on manila paper in case your school does not have one.

### Pre-requisite of the lesson

By now, learners have a rough idea of how blood circulates in the body. Give them a small activity to draw in their

notebooks how they think blood flows in the body considering the position of the heart and the fact that blood vessels are tubes. Assess their work then narrow down to activity 11.4.

### Teaching / learning activities

#### Activity 11.4 (Refer to Pupil's book page 224)

- Let the learners watch the video on the link: [https://www.youtube.com/watch?v=\\_qmNCJxpsr0](https://www.youtube.com/watch?v=_qmNCJxpsr0) carefully. They should identify the path of blood in the vessels.
- Provide learners with the chart on circulation of blood. Using the knowledge about the video, guide them to trace the path of blood in the chart.
- Let them draw the path of blood in their notebooks and label it.
- Summarise the lesson by highlighting the key points about blood circulation as learners take summary notes. Better still, you can appoint a gifted learner to give summary points as you guide them.

### Synthesis

This lesson intends to create awareness of how blood flows in human body. Learners through watching the video should trace the path of flow of blood in the circulatory system. They should then be able to reproduce this in their notebooks and explain how blood flows from point A to the last point within the circulatory system.

## Lesson assessment

Assess whether the learning objective of the lesson was met by asking questions such as:

1. Which organ pumps blood to all body parts? (Ans: Heart)
2. From the heart, blood moves to the rest of the body through \_\_\_\_\_. (Ans: Aorta)
3. Oxygenated blood from the lungs comes back to the heart through \_\_\_\_\_ vessel. (Ans: Pulmonary vein)
4. \_\_\_\_\_ brings deoxygenated blood back to the heart. (Ans: Vena cava)
5. \_\_\_\_\_ takes deoxygenated blood to the lungs. (Ans: Pulmonary artery)

## Lesson 5: Components of blood

Refer to learner's book pages 227-228

### Specific objectives

By the end of the lesson, learners should be able to explain the composition of blood.

### Preparation for the lesson

1. This lesson will involve a research activity either in the library or using the Internet or group work.
2. Bring pamphlets, handouts, and textbooks for reference in class. Also, ensure that the Internet is working if you have a computer laboratory or any other form of internet connectivity such as WIFI or modem.

## Teaching Aids

- Charts on various components of blood.

### Improvisation

Teacher notes on components of blood.

### Pre-requisite of the lesson

You may begin this lesson by asking learners to name some things that are present in the classroom. They may name desks, tables, chairs, blackboard, books, pens and themselves among others. Inform them that what they have named can be referred to as 'components of the classroom'. Make them aware that in a similar way, blood is made up of different things. You can then narrow down to activity 11.5.

### Teaching / learning activities

Find out (Refer to Pupil's book page 227)

- Let learners go to the library and search in textbooks what blood is made of. They can also do Internet searches.
- They should also find out the functions of the various components of blood.
- Back in class, put learners in groups of five depending on the size of the class to harmonize their findings. Let them choose a group leader to do a presentation to the rest of the class.
- After the presentations, guide learners to write short notes and draw the various blood components in their note books. Refer to Pupil's book pages 227-228.

- Summarise the lesson by giving a task of coming up with a table on the differences between white and red blood cells.

### Synthesis

This lesson introduces the various components of blood to learners. Guide learners through research and discussion to discover the various components of blood and their roles in the circulatory system.

### Lesson assessment

Assess whether the learning objective of the lesson was met by asking questions such as:

1. Blood is made up of three types of cells. Name them.

*(Ans: White blood cells, red blood cells and platelets)*

2. Plasma is \_\_\_\_\_ of blood. It contains \_\_\_\_\_, \_\_\_\_\_ and \_\_\_\_\_ among other things.

*(Ans: liquid, digested food materials, mineral salts, hormones, antibodies among others)*

3. Platelets help in \_\_\_\_\_ of blood. This is important because it prevents excessive bleeding.

*(Ans: clotting)*

4. \_\_\_\_\_ help to carry oxygen from the lungs to body tissues.

*(Ans: Red blood cells)*

5. Which type of cells protect the body against diseases?

*(Ans: White blood cells)*

## Lesson 6: Hygiene of the circulatory system *(To be covered in one period)*

Refer to learner's book pages 229-230

### Specific objectives

By the end of the lesson, learners should be able to explain the hygiene of the human circulation system.

### Preparation for the lesson

1. This lesson will involve a research activity either in the library or using the Internet or group work.
2. Bring pamphlets, handouts, and textbooks for reference in class. Also, ensure that the Internet is working if you have a computer laboratory or any other form of internet connectivity such as WIFI or modem.

### Teaching aids

- Reference materials on hygiene of circulatory system.

### Pre-requisite of the lesson

Ask learners to list some practices they do in order to avoid diseases such as cholera outbreak and typhoid. They may mention practices such as washing hands before eating and after visiting the toilet and keeping the environment clean in general. Let them know that in a similar way, we should carry out practices that ensure healthy circulatory

system. At this point, narrow down to Activity 11.6.

### Teaching / learning activities

#### Activity 11.6 (Refer to Pupil's book page 229)

- Let learners go to the library and search in textbooks what hygiene of the circulatory system is and what should be done to keep the heart and associated organs healthy. They can also do Internet searches.
- They should then come up with a list of practices that enhance healthy heart, blood and blood vessels.
- Back in class, put learners in groups depending on the size of the class and the abilities of class members to harmonise their findings. Let them choose a group leader to do a presentation on their behalf.
- After the presentations, guide learners to write short notes and draw a table on how to take care of the heart, blood and blood vessels.

### Synthesis

This lesson introduces the concept of hygiene of the heart and circulatory system in general. Through research, learners should discover and practice activities that keep their circulatory systems healthy.

### Lesson assessment

Assess whether the learning objective of the lesson was met by asking questions such as:

1. What is hygiene of the heart?

*(Ans: Practices that keep the heart healthy)*

2. List three practices that will enhance a healthy heart.

*(Ans: Balanced diet, exercising, not smoking or taking alcohol, among others)*

3. Apart from the heart, which other organs should we take care of in the circulatory system?

*(Ans: Blood vessels, also blood should be taken good care of)*

### Lesson 7: Circulatory system diseases

Refer to learner's book pages 230

### Specific objectives

By the end of the lesson, learners should be able to identify main diseases of the circulatory system and state their causes, signs & symptoms and how to prevent them.

### Preparation for the lesson

1. This lesson will involve a research activity either in the library or using the Internet or group work.
2. Bring pamphlets, handouts, and textbooks for reference in class. Also, ensure that the internet is working if you have a computer



laboratory or any other form of Internet connectivity such as WIFI or modem.

### Teaching aids

- Reference materials on diseases of the circulatory system.

### Pre-requisite of the lesson

- Introduce the topic by reminding learners about common diseases that they know or might have come across. Ask probing questions such as:
  - (i) What causes the diseases?
  - (ii) How are they controlled?
- You can then ask them if they think diseases can affect circulatory system.

### Teaching / learning activities

*Find out (Refer to Pupil's book page 231)*

- Let learners go to the library and search in textbooks diseases that affect the circulatory system and their signs and symptoms. They can also do Internet searches and watch videos on the same.
- Back in class, put learners in groups depending on the size of the class and the abilities of class members to harmonize their findings. Let them choose a group leader to do a presentation on their behalf.
- After the presentations, guide learners to write short notes and draw a table on various heart diseases, their causes, signs & symptoms and control/prevention measures.

### Synthesis

Learners at this stage have come across various diseases. Take advantage of their past knowledge and guide them to do research on the various diseases and disorders of the circulatory system. They should at the end write summary notes and appreciate the need to prevent/control these diseases as a way of living healthy life.

### Lesson assessment

Assess whether the learning objective of the lesson was met by asking questions such as:

1. Give four diseases that affect the circulatory system. (*Ans: Heart attack, stroke, atherosclerosis, high blood pressure among others*)
2. Which signs would you look out for in order to know when someone is suffering from:
  - (a) Atherosclerosis?
  - (b) Stroke?

*(Ans: Refer to table 11.2 pages 231 in Pupil's book)*

## Lesson 8: Blood pressure and its measurement

*Refer to learner's book pages 232*

### Specific objectives

By the end of the lesson, learners should be able to interpret blood pressure measurement for different persons.

### Preparation for the lesson

1. This lesson will involve a visit to a

nearby health facility or hospital. Arrange in advance to get permission to visit the health facility.

2. Ask learners to prepare questions to ask during the visit in advance.

### Teaching aids

- A nearby health facility
- Sphygmomanometer

### Pre-requisite of the lesson

Introduce the topic by leading a brainstorming session on what blood pressure is and the need to regularly check blood pressure. You can then narrow down to activity 11.18.

### Teaching / learning activities

#### Activity 11.8 (Refer to Pupil's book page 233)

- Take learners to visit a nearby health facility to witness blood pressure being measured on patients by the health personnel.
- Let learners observe how the blood pressure is being taken as they take notes. At the end, ask them to come up with the steps followed when taking blood pressure.
- They should ask questions during the trip such as: (i) What is the

normal blood pressure? (Ans: Between 120/80 mmHg – 140/90 mm Hg).

(ii) How about abnormal blood pressure? (Ans: anything outside the bracket 120/80 mmHg – 140/90 mm Hg).

- Ask the nurse to take the blood pressure of a few pupils as they record. Let them work the average and compare it with the range given by the nurse as the normal blood pressure. Is it normal?
- Wrap up the lesson by explaining what blood pressure is and how it is taken.

### Synthesis

The concept of blood pressure is relatively new to learners. The hospital visit should be used to reinforce the importance of regularly checking blood pressure.

### Lesson assessment

Assess whether the learning objective of the lesson was met by asking questions such as:

1. What is sphygmomanometer? (Ans: Instrument used to measure blood pressure)
2. What blood pressure is considered normal? (Ans: Between 120/80 mmHg – 140/90 mm Hg)

## Answers to Self-Test 11.1

Refer to learner's book pages 229

1. Heart, blood and blood vessels.
2. Refer to Fig.11.6 Page 248 in student's book.
3. Prevents mixing of oxygenated and deoxygenated blood.
4. Vena cava – carries blood from the rest of the body to the heart.

Pulmonary artery - carries blood from the heart to the lungs.

Pulmonary vein - carries blood from the lungs to the heart.

Aorta - carries blood from the heart to the the rest of the body apart from lungs.

5.

Arteries	Veins
Have thick walls	Have thin walls
Have small lumen	Have large lumen
Lack valves	Have valves

6. White blood cells, red blood cells, platelets and blood plasma.

## Summary of the unit

This unit is about learners gaining knowledge and understanding of the circulatory system and its maintenance

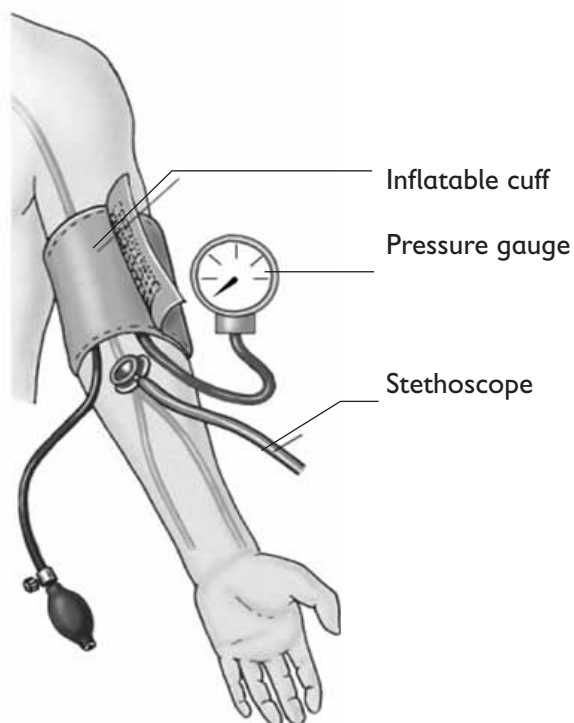

and hygiene. You should effectively use the suggested activities and the teaching approaches in the teacher's book to help learners acquire this competence. At the end of the lessons, you should assess the extent to which the competency is achieved and plan remedial activities where necessary. Remember, one of the attitudes and values intended at the end of the topic is for learners to develop the habit of taking good care

of their circulatory system, checking blood pressure regularly and avoiding respiratory diseases and disorders. Guide learners to observe these at all times.

### Additional Information for the teacher

Some information that may be relevant with regards to the circulatory system are given below.

### Circulatory systems in animals

There are two types of circulatory systems in animals:

- Open circulatory system
- Closed circulatory system

#### (a) Open circulatory system body

Here, blood is pumped by the heart into a body cavity. The body cavity is a series of body spaces collectively known as **haemocoel**. This means that blood does not flow in closed vessels but rather flows freely into spaces. This system is found in most arthropods such as insects.

#### (b) Closed circulatory system

Here, blood flows in closed vessels and does not come into direct contact with body tissues. Blood is pumped by the heart under high pressure to the tissue through closed blood vessels and flows back to the heart. An example is in human beings. There are two types of closed circulatory system:

- Single circulation
- Double circulation

#### (i) Single circulation

In single circulation, blood flows through the heart once to make a complete circuit. This is found in fish, reptiles and amphibians. For example in fish, blood flows from the heart to the gills to collect oxygen, then to all parts of the body before returning back to the heart.

#### (ii) Double circulation

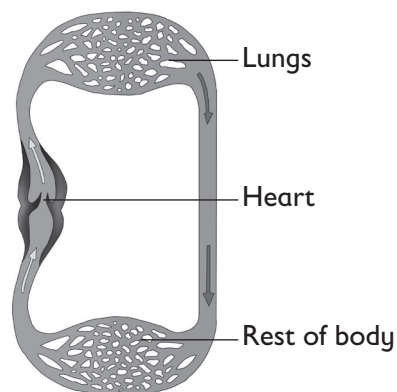

In double circulation, blood flows through the heart twice to make a complete circuit. This occurs in mammals for example, human beings and birds. The blood flows from the heart to lungs to collect oxygen and back to the heart. The blood is then pumped by the heart to all parts of the body and finally back to the heart the second time to complete the circuit.

Blood pressure is lost as blood flows through the capillaries in the lungs. The blood flows back to the heart where pressure is restored by the pumping of the blood by the heart to all part of the body. Double circulation is possible because the heart is divided into the

right and left side by septum. The right side of the heart contains deoxygenated blood. The left side of the heart contains oxygenated blood.

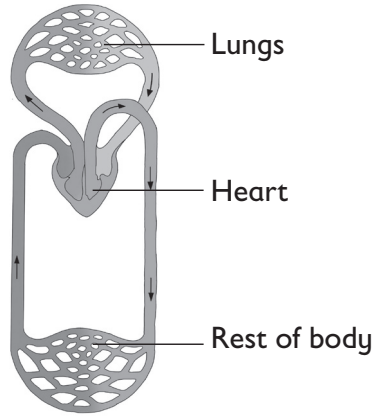

### Functioning of the heart

The heart pumps blood to the lungs and to all parts of the body. The pumping of the heart is as a result of contraction and relaxation of cardiac muscles. The contraction of heart muscles is known as **systole**. The relaxation of cardiac muscles is called **diastole**.

#### (a) Systole

These are two types of systole namely:

- Atrial systole
- Ventricular systole

Atrial systole refers to the contraction of the atria that pushes the blood in the atria into the ventricles. The ventricular systole is the contraction of the ventricles that pushes blood out of the ventricles. During systole, semi-lunar valves opens to allow blood to flow out of the artery and out of the left ventricle through the aorta. During this time, the

atrioventricular valves (cuspid valves) close to prevent backward flow of blood into the auricles.

#### (b) Diastole

There are two types of diastole:

- Atrial diastole
- Ventricular diastole

During atrial diastole the muscles of the atria (auricles) relax and blood from the lungs and body is received in the auricles. Oxygenated bloods from the lungs enter the left auricle through pulmonary vein. De-oxygenated blood from various parts of the body enter into the right auricle through the vena cava. During ventricular diastole, the semi-lunar valves close down to prevent backward flow of blood from the pulmonary artery and aorta. The atrio-ventricular valves open to allow blood to flow from the auricle to the ventricles.

#### The process of blood clotting

Blood clotting occurs when blood is exposed to air such as when the tissue is injured. Blood clotting is important in reducing further loss of blood in the event of a damaged blood vessel as well as preventing entry of bacteria that cause diseases. Platelets are involved in the clotting process. Platelets contain a chemical substance called **thromboplastin**, which is released, at the injured vessel. Thromboplastin activates prothrombin, an inactive protein compound in plasma, to **thrombin**. Thrombin is a protein-digesting enzyme

(protease). It stimulates the conversion of **fibrinogen**, a protein found in plasma, to **fibrin**. Fibrinogen is a soluble protein molecule but fibrin is insoluble. Fibrin forms a meshwork of fibres that trap blood cells forming a **clot**. This prevents further blood loss.

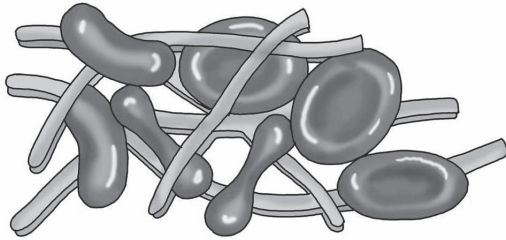

**NOTE:** Calcium ions play an important role in the blood clotting process. The calcium ions and vitamin K are required in the clotting process as enzyme co-factors. Enzyme co-factors activate the working of enzymes since the blood clotting process is controlled by enzymes.

Normally blood does not clot in undamaged blood vessels. There is a chemical substance found in plasma called **heparin** which prevents conversion of prothrombin to thrombin and fibrinogen to fibrin.

This chemical is used in hospitals as anticoagulant to prevent blood kept in blood bank from clotting.

### Blood groups

Human beings have different blood groups depending on the antigens found on the surfaces of red blood cells.

There are four main blood groups namely blood group A, Blood group B, Blood group AB and blood group O. The antigens contained in these blood groups are given below.

Blood group	Antigen
A	Have antigen A
B	Have antigen B
AB	Have both antigen A and antigen B
O	Lack both antigen A and antigen B

There are antibodies found in the blood plasma as well. These antibodies interact with the antigens on the red blood cells. They are named as:

- Antibody a
- Antibody b

Note that antigens are named in capital letters (A and B) while antibody are named in small letters (a and b).

Blood group	Antigens on red blood	Antibodies in plasma
A	A	b
B	B	a
AB	A and B	None
O	None	A and b

A person with a specific antigen does not possess the complimentary antibody. For example, a person with antigen A (Blood group A) does not have antibody a in the plasma. The table below shows the antigens and antibodies present in the different blood groups.

## Blood transfusion

Blood transfusion is the transfer of blood from one person to the blood stream of another person. The person who gives blood is called **donor** and the person who receives the blood is called the **recipient**. During blood transfusion, the blood groups of both the donor and recipient should be determined and matched.

- A person with blood group AB does not have antibodies in the blood plasma. Therefore such a person can receive blood from all other blood groups. Since there will be no antibody to agglutinate with the antigen. Blood group AB is hence said to be a **universal recipient**, that is, is able to receive blood from all donors.
- A person with blood group O lacks antigens. Such a person is referred to as **universal donor**, and is able to give blood to all other blood groups without agglutination.

The table below shows the blood transfusion options available. A tick (✓) indicates that safe blood transfusion is possible while a cross (x) shows agglutination and hence safe blood transfusion is not possible.

Blood Group	Recipient			
	A	B	AB	O
A	✓	x	✓	x
B	x	✓	✓	x
AB	x	x	✓	x
O	✓	✓	✓	✓

## Blood disorders

Examples of blood disorders include:

### (a) Leukemia

This is a disorder caused by uncontrolled production of white blood cells. Therefore, it is sometimes called **blood cancer**. It is characterised by abnormally high number of white blood cells per  $\text{mm}^3$  of blood. The high numbers of cells digest the tissues resulting in general body weakness and body wasting. The condition can be controlled through blood transfusion from time to time; or through chemotherapy and radiotherapy to kill the abnormal number of cells.

### (b) Sickle cell anaemia

This disorder arises when red blood cells lose their biconcave shape and assume sickle cell shapes that greatly reduce the surface area for transport of oxygen. Patients with sickle cell anaemia are characterised by difficulty in breathing especially after vigorous physical exercise, muscle fatigue, abdominal pain and general weakness of body. Sickle cell anaemia can be controlled by avoiding vigorous physical exercise and taking a diet rich in vitamins and mineral ions.

### (c) Haemophilia

This is caused by failure of blood to clot in the event of a damaged vessel. This results in excessive bleeding. The disorder is caused by lack of clotting factors such as calcium ions and vitamin K. It can be controlled by injecting clotting factor into the blood stream of the patient.

#### Answers to Unit Test II (Pupil's book Page 234)

1. Heart and blood vessels
2. Aorta, vena cava
3. Valves
4. Aorta, vena cava
5. Refer to Fig. 11.7 page 232 of pupil's book.
6. Arteries, veins, capillaries.
7. Because they transport blood under

high pressure hence blood cannot flow backwards.

8. During exercise, the heart beats faster than at rest.
9. By eating balanced diet, through regular exercises, drinking plenty of water and fluids, avoiding sex before marriage.
10. To avoid diseases like high blood pressure, heart attack and stroke.
11. High, low
12. Fighting disease causing germs, clotting.
13. Oxyhaemoglobin
14. A
15. Pulmonary artery
16. A
17. Vena cava

#### Extension Activities to cater for slow and gifted learners

Remedial activities for slow learners	Extended activities for gifted and talented learners
<ol style="list-style-type: none"><li>1. Modelling the heart.</li><li>2. Drawing and tracing the path of blood in the circulatory system (they should use red colouring for oxygenated blood and blue colouring for deoxygenated blood).</li><li>3. Coming up with a table on differences between arteries and veins, circulatory system diseases on manila papers and hanging them on classroom walls.</li></ol>	<ol style="list-style-type: none"><li>1. Preparing questions to ask during educational visits such as when they visit a health facility.</li><li>2. Leading group discussions and doing presentations on behalf of group members</li><li>3. Summarizing lessons following guidance from the teacher.</li><li>4. Carrying out additional research, for example on blood disorders and the clotting process.</li></ol>



<b>Remedial questions for slow learners</b>	<b>Extended questions for gifted learners</b>
<ol style="list-style-type: none"> <li>1. ____, ___ and ___ make up the circulatory system.</li> <li>2. The heart has ____ chambers, two on the right and two on the left. The lower chambers are called _____ while the upper chambers are called _____.</li> <li>3. Which diseases attack the heart?</li> <li>4. ____ and ___ is bad for the health of the heart.</li> <li>5. _____, _____ and _____ are the cells that make up blood.</li> <li>6. Which part forms the bulk of blood and is largely water?</li> </ol>	<ol style="list-style-type: none"> <li>1. Relate the structure of the heart to its functions.</li> <li>2. Why would you rather go swimming than sleeping?</li> <li>3. Assuming you cut your arm with a piece of glass which got into your bloodstream. Describe the path of the piece of glass to your leg.</li> <li>4. Amongst the things that make up the circulatory system, one is NOT an organ, which one? What is it?</li> </ol>
<b>Answers to remedial questions</b>	<b>Answers to extended questions</b>
<ol style="list-style-type: none"> <li>1. Heart, blood and blood vessels.</li> <li>2. Four, auricles(atria), ventricles.</li> <li>3. Heart attack, thrombosis.</li> <li>4. Smoking and excessive drinking of alcohol.</li> <li>5. White blood cells, red blood cells and platelets.</li> <li>6. Plasma.</li> </ol>	<ol style="list-style-type: none"> <li>1. - It is divided into two separate parts by septum – this ensures that oxygenated and deoxygenated blood do not mix. <ul style="list-style-type: none"> <li>– Has four chambers that receive and pump blood. Lower chambers (ventricles) have thicker walls than upper ones (auricles) – this enables them generate enough force to pump blood far away.</li> <li>– It is made up of cardiac muscles, which contract and expand to generate pumping force.</li> <li>– Has valves which control the direction of flow of blood.</li> </ul> </li> <li>2. Swimming exercises the organs of the circulatory system thereby keeping them healthy.</li> <li>3. Vein in the arm to vena cava to right auricle through the tricuspid valve to right ventricle to pulmonary artery to the lung to pulmonary vein to left auricle through bicuspid valve to the left ventricle to the aorta to the artery in the leg.</li> <li>4. Blood. It is a tissue.</li> </ol>

# Respiratory system

(No. of periods: 8)

*Refer to the Learner's Book pages 236- 250*

## Key unit competency

After studying this unit, the learner should be able to explain the mechanism of respiration.

## Learning objectives

Competency based curriculum embraces three categories of learning objectives,

that is, knowledge and understanding, skills acquisition and attitude and values.

At the end of the unit, learners should have knowledge and understanding of the respiratory system and have the right attitude towards taking care of it.

**Table 12.1 Knowledge, skills and values to be attained**

Knowledge and understanding	Skills	Attitudes and values
<p>By the end of this unit, learners should be able to:</p> <ul style="list-style-type: none"> <li><input type="checkbox"/> Explain the main function of the respiratory system.</li> <li><input type="checkbox"/> Describe the human respiratory system.</li> <li><input type="checkbox"/> Explain the process of respiration.</li> <li><input type="checkbox"/> Explain the care of the human respiratory system.</li> <li><input type="checkbox"/> Identify the main diseases of the human respiratory system.</li> </ul>	<p>By the end of this unit, learners should be able to:</p> <ul style="list-style-type: none"> <li><input type="checkbox"/> Observe wall charts or human respiratory system models and describe them.</li> <li><input type="checkbox"/> Draw and label the human respiratory system.</li> <li><input type="checkbox"/> Take care of their respiratory system.</li> </ul>	<p>By the end of this unit, learners should be able to:</p> <ul style="list-style-type: none"> <li><input type="checkbox"/> Show concern about the hygiene of the respiratory system.</li> <li><input type="checkbox"/> Show awareness of respiratory system diseases.</li> <li><input type="checkbox"/> Take care of his/her respiratory system.</li> <li><input type="checkbox"/> Develop habit of regular health check up.</li> <li><input type="checkbox"/> Advocate against smoking.</li> </ul>

## Pre-requisite of this unit

In the previous unit, pupils learnt about the circulatory system. They also learnt about the reproductive and digestive systems in primary 5. Build on their knowledge in these areas to introduce the respiratory system, its function, its hygiene and the diseases that affect it. Also, during the lessons, strive to bring to the awareness of learners the fact that this topic is related to respiratory system in biology that they will study at higher levels of learning. Let them understand that at this level, they may only need the basic information otherwise, details of functioning of the respiratory system will be learnt in high school and even better, when later in life, they study medicine and become chest specialists.

### Background information

In unit 11, learners were introduced to circulatory system. Let them understand that respiratory system is one of the many body systems just like the circulatory system. **REMEMBER:** Respiration system to be covered here is also known as breathing system) NOT respiration which is the breakdown of food substances to release energy. It is the system that helps in gaseous exchange, which simply means taking air in and out of the body and incorporating it into the bloodstream.

Circulatory system takes over after gaseous exchange in the lungs. This topic will therefore enable learners realize the need for a respiratory system in the body. They will also know the various conditions that affect the

respiratory system and how to maintain proper hygiene of the lungs and other respiratory system organs in general.

### Cross-cutting issues to be addressed

#### 1. Standardization culture

Bring to the attention of learners the need to seek medical healthcare in standard and quality hospitals whenever they have problems with their respiratory system.

#### 2. Financial education

Emphasize the fact that learners should practice good hygiene to avoid conditions and disease of the respiratory system in order to avoid spending money on treatment.

#### 3. Gender education

Emphasize to learners that anybody irrespective of their gender can pursue a career in medicine. Give examples of role models who are successful chest specialists in the area where the learners come from.

#### 4. Inclusive education

All learners should be encouraged to participate during lessons and practicals. Special arrangement should be made to take care of learners with special needs. For example, provide brail for blind learners, large print text for those with sight problems and allocate physically challenged learners to others to assist them during field trips and practical activities. Further, this category should be given tasks that they can manage during the practical sessions.

## Generic Competences

### 1. Co-operation and interpersonal management and life skills

During group discussions and pair-work let learners engage one another by giving a chance for all to participate. Also, during group presentations, you can allow rotational presentations within the group members. Gifted learners should help in coming up with presentation content as slow learners contribute. **REMEMBER** You should allow slow learners to do presentations as well and correct them where they go wrong. Further, advise learners to appreciate the different abilities of their group members and accommodate each other's views.

### 2. Research skills

Guide learners on how to find out information regarding respiratory system and the diseases that affect it. Guide learners on how to come up with summarized notes from a large body of text. This they should do by first identifying major points and listing them down. You should also guide learners on doing Internet searches for the various content areas they are looking for. Learners can use 'single word searches or well crafted 'phrases' in order to get the relevant information they are looking for.

### 3. Communication in English

Communication in English will be improved when learners freely participate in the discussions

and presentations. Encourage all learners irrespective of their abilities to participate in group discussions, during presentations by asking questions and during question and answer sessions to either introduce or wrap up the lessons.

### 4. Critical thinking

This competence will be developed by learners as they answer the probing questions such as those on page 253 at the beginning of this unit and as they discuss the results of the various practical activities. Guide learners to discover for themselves how teenage pregnancies can be avoided and how to stay free from respiratory diseases. This competence will also come about as learners think about their findings in the activities and as they give out their suggestions on why this is the case.

### 5. Lifelong skills

Practicing hygiene of the lungs and the respiratory system in general creates a habit of taking care of oneself. Learners can also pass this habit to others through training. Also, make learners aware that they can become doctors and particularly chest specialists if they take this topic seriously.

### Key words in this unit and their meanings

- **Alveoli (Singular – alveolus) –** These are tiny airspaces found in the lungs where gaseous exchange occurs.

- **Breathing** – this refers to the process of taking fresh air into the lungs and removing waste air out of the lungs. It involves breathing in and out.
- **Bronchi** (Singular – bronchus)– These refers to the two main branches of the trachea, which go into the lungs. They are divided into bronchioles in the lungs.
- **Bronchioles** – these are the final branches of bronchi, which communicate directly with alveoli in the lungs.
- **Diaphragm** – This is the muscular flap of flesh that separates the chest cavity and the abdominal cavity, which is involved during breathing process.
- **Exhalation** – The act of breathing out. It is also known as expiration.
- **First Aid** – Emergency care or treatment given to a patient or injured person before complete medical treatment is secured.
- **Immunization** – this refers to the act of vaccinating a person to make them immune to a particular disease.
- **Inhalation** – The act of breathing in. It is also known as inspiration.
- **Lungs** – the two organs of respiration located in the chest cavity.
- **Respiration** – the act of taking air into the lungs or removing waste air from the lungs. It is also known as breathing. However, in advanced biology, respiration refers to the process of burning food particles in the body to release energy.
- **Suffocation** – this is a term, which refers to the act of causing to dies by preventing access to oxygen or air.

#### **Guidance on the problem statement**

This topic is about the respiratory system and its importance in the body. As a way of introducing the unit, refer learners to the diagram on page 236 of their book. Let learners study the picture and say what is going on. Ask them whether it is right or wrong. ( The picture shows an adult smoking in front of children. This is very wrong as it affects children and other occupants in the house. Further, smoking in public places is prohibited by Rwanda laws). Bring to the attention of learners the fact that smoking affects the respiratory system and particularly the lungs. This interferes with its functioning and this can cause problems.

## Attention to special educational needs

Support for Multi-ability learning	Support for special needs learning
<ul style="list-style-type: none"><li>- Slow learners can point at the various parts on the charts as gifted learners name the parts and explain their functions.</li><li>- Gifted learners can be performing the actions during practical activities as slow ones make observations and take notes. For example, in activity 12.2, they can perform the dissection.</li><li>- Both gifted and slow learners to be given equal opportunity to lead in group discussions and to do presentations of group findings to the rest of the class.</li><li>- Ensure all learners respect other's views irrespective of their shortcomings or talents.</li></ul>	<ul style="list-style-type: none"><li>- Allocate roles like holding charts and dismantling models like the lung model to learners with physical disabilities.</li><li>- Provide brail for blind learners and large print text to learners with seeing difficulties. Provide sign language alphabet symbols and sign language interpreters for the deaf.</li><li>- Also, arrange learners such that shortsighted ones are at the front and long-sighted ones are at the back. Spectacles can as well be provided if available.</li></ul>

## List of lessons

Lesson No.	Lesson title	No. of periods
1.	Main organs of the human respiratory system and its function	2
2.	Mechanism of respiration	2
3.	Practices and behaviors that ensure healthy respiratory system	1
4.	Respiratory system diseases	2
5.	Suffocation	1

## Lesson 1: Main organs of the human respiratory system and its function

Refer to learner's book pages 236

### Specific objectives

By the end of the lesson, learners should be able to:

- Explain the main function of human respiratory system
- Describe the human respiratory system.

### Preparation for the lesson

1. This lesson will involve individual work and dissection activity. You will therefore organize the class as need arises during the lesson.  
**REMEMBER:** When grouping learners, you should consider the different abilities of learners and the special needs for various individuals.
2. Look for a rabbit or a mouse in advance and ensure that all the tools in the dissection kit are in good working condition.
3. Obtain wall charts on respiratory system and other materials such as lung model in advance.

### Teaching aids

- Rabbit or mouse and dissecting kit.
- Charts on parts of the human respiratory system, textbooks, pamphlets and hand outs.

- Video link: <https://www.youtube.com/watch?v=h-wATTsMBBA&t=128s>

**IMPROVISATION:** You may come up with your own painted diagrams on respiratory system drawn on manila papers in case your school does not have the charts.

### Pre-requisite of the lesson

1. Introduce the unit as explained under guidance on the problem statement above then narrow down to this lesson.
2. To introduce the lesson, you may remind learners about the circulatory system they learnt about in the previous unit. Ask questions such as:
  - (i) What is circulatory system?  
(Ans: System that transports blood throughout the body)
  - (ii) What is its importance?  
(Ans: Distributes oxygen, food nutrients and other materials throughout the body and also helps to remove body wastes).
  - (iii) Do you think the body has other systems apart from circulatory system?  
(Ans: Yes) Which ones? (Ans: Respiratory system, excretory system, reproductive system).
3. From the probing questions, learners may mention respiratory system. Take advantage and introduce it.

## Teaching / learning activities

### Activity 12.1 (Refer to Pupil's book page 237)

- This is individual learner's activity. Let them carry out the tasks highlighted in this activity then discuss their findings with friends.
- Guide learners to discover the role of respiratory system, which is to bring fresh air into the lungs and remove waste air out of the body. (You may need to stress that fresh air is mainly oxygen and waste air is mainly carbon dioxide and what their sources are i.e. from atmospheric air and by-product of respiration in living cells). **REMEMBER:** This topic is not about respiration, which is the process of breaking down food substances to release energy. It is respiration, which refers to breathing in and out followed by gaseous exchange in the lungs.

### Activity 12.2 (Refer to Pupil's book page 237)

- By now, learners have a rough idea what respiratory system and its function is hence you can now delve further into the components of the respiratory system.
- You can then do a class demonstration on dissecting either a rabbit or a mouse to show learners parts of the respiratory system. Later, depending on availability of resources, you may put learners into groups and

guide them to carry out a dissection practical on a rabbit or a mouse to observe the respiratory system. You may also use a model on the same if available.

- Let them use the charts to identify the parts that they see. They can also use Fig. 12.2 on page 238 of their book. Let them make a sketch of the respiratory system in their notebooks and share with the rest of the class.
- Finally, guide learners to come up with a table on the various parts of the respiratory system and their functions.
- Wind up by giving learners a task on describing the human respiratory system in their own words.

### Synthesis

This lesson introduces learners to the human respiratory system. The activities carried out during the lesson above should help learners identify the various organs that make up the respiratory system and appreciate its function in the body.

### Lesson assessment

Assess whether the learning objectives of the lesson were met by asking questions such as:

1. What did you learn in this lesson?  
(Ans: *The function of the respiratory system in human body and the organs that make up the respiratory system.*)



2. What is the difference between respiratory system and circulatory system?

*(Ans: Respiratory system helps in bringing fresh air into the lungs and removing stale air out of the body. Circulatory system on the other hand helps in transportation of substances in the body.)*

3. What makes up the respiratory system?

*(Ans: Lungs, trachea, bronchi, bronchioles, diaphragm, alveoli and ribs.)*

4. Suppose we lacked a respiratory system, what will happen?

*(Ans: We will not survive because our body tissues will lack oxygen, and also, carbon dioxide will not be removed from the body leading to poisoning of body cells.)*

## Lesson 2: Mechanism of respiration

Refer to learner's book pages 239

### Specific objectives

By the end of the lesson, learners should be able to

- Explain the process of respiration.
- Describe the mechanism of respiration.

### Preparation for the lesson

- This lesson will involve watching a video and a practical activity. You will therefore organize the class as need arises during the lesson. **REMEMBER:** When grouping learners, you should consider the different abilities of learners and the special needs for various individuals.
- Pre-test the video to confirm that it is working. Use video link: <https://www.youtube.com/watch?v=h-wATTsMBBA&t=128s>
- Obtain charts on breathing process and mechanism of breathing

### Teaching aids

- Items like bell jar, balloons, rubber sheet, stoppers and Y-shaped glass tube.
- Charts on breathing mechanism, textbooks, pamphlets and hand outs.
- Video link: <https://www.youtube.com/watch?v=h-wATTsMBBA&t=128s>

**IMPROVISATION:** You may come up with your own breathing model and use it during the practical activities.

### Pre-requisite of the lesson

Remind learners about what breathing process is i.e. breathing in and out. Let them understand that in this lesson, they will learn about what happens during breathing in and out through the various practicals under your guidance.

## Teaching / learning activities

### Activity 12.3 (Refer to Pupil's book page 239)

- Begin this activity by letting learners feel the breathing process as described in procedure no. 1 in this activity. They should repeat this several times and come up with a conclusion on what is happening.
- You can then play the video or let them visit the above website to watch the video in groups.
- Guide learners to describe what they have seen. Ask probing questions such as:
  1. What happened to the ribs?  
(Ans: They were moving up and down or inwards and outwards)
  2. How about the diaphragm?  
(Ans: Dome-shaped or flattens)
  3. What is the significance of these?  
(Ans: They cause change in volume of chest cavity which leads to breathing in or out)

### Activity 12.4 (Refer to Pupil's book page 240)

- At this point, you can introduce the activity on making a breathing model then demonstrating how it works. Learners should then compare this to the working of the breathing system in human beings.
- Let learners assemble the items in this activity as shown in the figure of their book page 240. Let them pull the strings tied on the rubber sheet

up and down. Let them observe and state what happens.

- Ask learners what the various items in the model above correspond to and the actions.
- Guide them to summarize what the various items and actions correspond to in the respiratory system.
- At this point, you can guide learners to discover the mechanism of breathing in and out. Refer to learner's book pages 240-242. Guide learners to come up with a table on what happens to every organ in the respiratory system during breathing in and out.
- Let learners come up with summary notes on breathing mechanism. Assess their work then correct them accordingly.

### Synthesis

This lesson should create awareness of how breathing takes place. Learners through watching the video and through manipulating the lung model, should be made to appreciate what happens during the breathing process. They should then be able to describe the mechanism of breathing and do presentations on the same.

### Lesson assessment

Assess whether the learning objective of the lesson was met by asking questions such as:

1. Which organ allows air to get into the breathing system?  
(Ans: Nose/nostril)

2. When the diaphragm flattens during breathing in chest cavity \_\_\_\_\_. (Ans: increases) in volume. This reduces the \_\_\_\_\_ (Ans: pressure) inside the chest cavity thereby leading to air rushing into the lungs.
3. What is the equivalent of these things in a breathing model?
  - (a) Y-shaped tube \_\_\_\_\_ (Ans: Trachea)
  - (b) Bell jar \_\_\_\_\_ (Ans: chest cavity)
4. What happens in the alveoli during breathing? (Ans: Gaseous exchange occurs i.e. oxygen is introduced into the bloodstream while carbon dioxide is released into the alveolus airspace)

### Lesson 3: Practices and behaviours that ensure healthy respiratory system

Refer to learner's book pages 242

#### Specific objectives

By the end of the lesson, learners should be able to explain the care of the human respiratory system.

#### Preparation for the lesson

1. This lesson will involve a practical activity and group work. You will therefore organize the class as need arises during the lesson.

**REMEMBER:** When grouping learners, you should consider the different abilities of learners and the special needs for various individuals.

2. Bring pamphlets, handouts, and textbooks for reference in class. Also, ensure that the Internet is working if you have a computer laboratory or any other form of internet connectivity such as WIFI or modem.

#### Teaching Aids

- Transparent plastic bottle with cap, cigarette, tissue paper, biro pen casing, matchbox.
- Reference materials or internet connectivity.

#### Pre-requisite of the lesson

You may begin this lesson by letting learners know that just like any other body system, respiratory system should also be well taken care of. Remind them about the care they learnt about under circulatory system. Give a chance to one student to list the various practices on the chalkboard as others give the points.

#### Teaching / learning activities

#### Activity 12.5 (Refer to Pupil's book pages 243-244)

- Guide learners to go through the procedures given on pages 243 - 244 in their textbooks. Ask probing questions along the way, for example: why should the bottle

be filled halfway with water? (Ans: to allow atmospheric pressure to push the smoke into the bottle). What is the use of the tissue paper? (Ans: To show the effect of smoking on the lungs)

- Let learners discuss the results of the experiment in their groups. They should write summary notes and nominate a group leader to do presentation on their behalf.
- Summarize by highlighting the main aim of the experiment which is to find out the effect of smoking on the lungs.
- Highlight other points about safety of respiratory system as listed in Pupil's book page 245. Let learners write summary points.

### Synthesis

This lesson is about hygiene of the respiratory system in general. Through the demonstration of the effects of smoke on the tissue paper in Activity 12.5, you should emphasize the fact that smoking is bad to the lungs. You should also highlight other bad habits such as alcoholism, not eating a balanced diet among others as other ways in which we expose our respiratory system to ill health. Advise learners to desist from such practices in order to live healthy lives.

### Lesson assessment

Assess whether the learning objective of the lesson was met by asking questions such as:

1. What is hygiene of the respiratory system?

(Ans: Practices that keep the respiratory system healthy)

2. List three practices that will enhance a healthy respiratory system.

(Ans: Balanced diet, exercising, not smoking or taking alcohol, among others)

3. How will washing hands before every meal help in keeping respiratory system healthy?

(Ans: Prevents infection of the lungs)

## Lesson 4: Respiratory system diseases

Refer to learner's book pages 245

### Specific objectives

By the end of the lesson, learners should be able to identify main diseases of the respiratory system and state their causes, signs & symptoms and how to prevent them.

### Preparation for the lesson

1. This lesson will involve a research activity either in the library or using the Internet and group work.
2. Bring pamphlets, handouts, and textbooks for reference in class. Also, ensure that the Internet is working if you have a computer laboratory or any other form of Internet connectivity such as WIFI or modem.

## Teaching aids

- Reference materials on diseases of the respiratory system.

## Pre-requisite of the lesson

- Introduce the lesson by reminding learners about common diseases that they know or might have come across. Ask probing questions such as: What causes the disease? How can the disease be controlled?
- You can then ask them if they think respiratory system can be affected by diseases. Let them do research on this.

## Teaching / learning activities

### Find out (Refer to Pupil's book page 245)

- Let learners go to the library and search in textbooks, diseases that affect the respiratory system and their signs and symptoms. They can also do Internet searches and watch videos on the same.
- Back in class, put learners in groups depending on the size of the class and the abilities of class members to harmonize their findings. Let them choose a group leader to do a presentation on their behalf.
- After the presentations, guide learners to write short notes and draw a table on various respiratory diseases, their causes, signs & symptoms and control/prevention measures. Refer to Pupil's book pages 246-247.

## Synthesis

Learners have already been taken through circulatory system diseases. Take advantage of their past knowledge and guide them to do research on the various respiratory diseases. They should at the end appreciate the need to prevent/control these diseases as a way of living healthy life.

## Lesson assessment

Assess whether the learning objective of the lesson was met by asking questions such as:

1. Give four diseases that affect the respiratory system.

*(Ans: Heart attack, stroke, atherosclerosis, high blood pressure among others)*

2. Which signs would you look out for in order to know when someone is suffering from:

- (a) Tuberculosis?
- (b) Asthma?
- (c) Bronchitis?

*(Ans: Refer to Table 12.3 pages 246 of Pupil's book)*

3. How would you prevent pneumonia in your locality? *(Ans: Refer to table 12.3 pages 246 of Pupil's book)*

## Lesson 5: Suffocation

Refer to learner's book pages 248

## Specific objectives

By the end of the lesson, learners should be able to define suffocation, state its

causes and do first aid to a suffocation victim.

### Preparation for the lesson

1. This lesson will involve a research activity and group work involving role play.
2. Pre-test the video to confirm that it is working. Use video link: <https://www.youtube.com/watch?v=NXnXAYceSqQ>
3. Bring pamphlets, handouts, and textbooks on first aid for suffocation for reference.

### Teaching aids

- Reference materials on diseases of the respiratory system.
- Video link: <https://www.youtube.com/watch?v=NXnXAYceSqQ>

### Pre-requisite of the lesson

Suffocation concept is introduced at this level due to the fact that it is a danger that young children as well as adults face in their daily lives. Ask learners to brainstorm about other risks that occur around them. Such risks involve fire accidents, getting cuts or bruises, electric shocks among others. Ask them what happens when such incidences occur. Ask them to say whether the same should happen when one suffocates.

### Teaching / learning activities

#### Find out (Refer to Pupil's book page 248)

- Let learners go to the library and search in textbooks the meaning of

suffocation, its causes, and how to give first aid to a suffocated person. They can also do Internet searches and watch videos using the above link.

- Back in class, put learners in groups depending on the size of the class and the abilities of class members to harmonize their findings. Let them choose a group leader to do a presentation on their behalf.

#### Activity 12.7 – Role play (Refer to Pupil's book page 248)

- Let learners watch the video using the link provided above.
- Put learners in pairs and let them act first aid for suffocation as they saw in the video. One learner should act a victim while the other gives first aid. They should then change roles.

### Synthesis

The concept of suffocation may be relatively new to learners in theory but in practice, they may have come across it. Emphasise the need to know what to do to both children and adults in case of suffocation. The video should provide enough guidance on this. Reinforce this competence by allowing learners to role-play first aid for suffocation. You should also stress the need to avoid activities that may cause suffocation such as eating too fast, inhaling poisonous fumes among others.

### Lesson assessment

Assess whether the learning objective of the lesson was met by asking questions such as:

1. To suffocate is to \_\_\_\_\_?  
(Ans: cause to die by depriving air or oxygen)

2. What causes suffocation?  
(Ans: Chocking, drowning, asthma, inhaling poisonous substances)

3. What should you do to help a suffocation victim?

(Ans: Refer to pupil's book page 15)

### Answers to Self-Test 12.1

Refer to learner's book page 249

1. Eating a balanced diet, avoiding smoking and excessive consumption of alcohol, not inhaling poisonous gases, exercising regularly among other practices.

2. Asthma, tuberculosis, pneumonia, bronchitis, pleurisy, whooping cough.

3. Choking, drowning, throat infection, inhaling poisonous substances, physical damage to the airways among others.

4. Refer to learners book page 249

### Summary of the unit

This unit is about learners gaining knowledge and understanding of the respiratory system and its maintenance and hygiene. You should effectively use the suggested activities and the teaching approaches in the teacher's book to help learners acquire this competence. At the end of the lessons, you should assess the extent to which the competency is

achieved and plan remedial activities where necessary. Remember, one of the attitudes and values intended at the end of the topic is for learners to develop the habit of taking good care of their respiratory system and avoiding respiratory system diseases and suffocation. Guide learners to observe these at all times.

### Additional Information for the teacher

Some information that may be relevant with regards to the respiratory system are given below.

### Types and characteristics of respiratory surfaces

Respiratory surfaces refer to places or sites where gaseous exchange occurs in organisms. Organisms have different respiratory surfaces depending on their complexity and their habitat. Examples of specialised structures for gaseous exchange in animals include:

- Cell membrane for example in amoeba
- Tracheal system in insects
- Buccal cavity in frogs
- Skin in frogs
- Gills in fish
- Lungs in mammals, birds, reptiles and amphibians.

Gaseous exchange takes place over these respiratory surfaces. A respiratory surface must have certain characteristics that make it efficient for gaseous exchange. They include:

- Thin walls for faster diffusion of gases across it.

- It should be moist to dissolve gases as they diffuse across it.
- It must have a large surface area to volume ratio for maximum gaseous exchange.
- In animals with a transport system, the respiratory surface has to have a rich supply of blood capillaries to quickly transport gases to and from the cells.

However, not all respiratory surfaces are in direct contact with the medium through which gaseous exchange occurs, such as the water or air around the organism. This presents two difficulties to the cells namely; not getting enough oxygen, and accumulation of carbon dioxide at the respiratory surface.

Therefore, there is need for a process that can ensure a continuous supply of fresh water or air to and from the respiratory surface. This is achieved by the process of ventilation which continuously brings water or air containing more oxygen to the respiratory surface and removes from it water or air containing a lot of carbon dioxide. Ventilation, therefore, is important because it maintains a high diffusion gradient at the respiratory surface to ensure a high rate of gaseous exchange. Breathing is an example of ventilation. Learners have already been taught about ventilation (breathing) in mammals. In the next section, we present to you additional information on breathing/ventilation mechanisms in other organisms.

### (a) Protozoa

Protozoa are single celled organisms. Examples of protozoa include Amoeba, Plasmodium and Trypanosoma. These are microscopic organisms. They are mainly found in water or in the body fluids of other organisms.

The respiratory surface of protozoa is the cell membrane. Gaseous exchange occurs across the cell membrane directly by diffusion. Due to respiration, the concentration of carbon dioxide inside the cell is higher than that in the surrounding water. Therefore, carbon dioxide diffuses out of the organism into the surrounding.

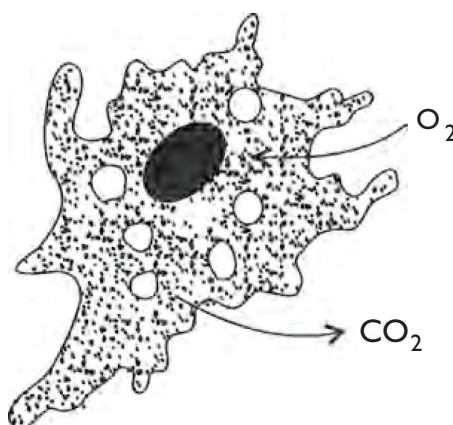

On the other hand, the concentration of oxygen is higher in the surrounding water than inside the organism. This gas is continuously used for respiration in the organism. Oxygen therefore diffuses from the surrounding water into the organism.



## (b) Insects

The respiratory system in insects is called the **tracheal system**. It consists of spiracles, trachea and tracheoles.

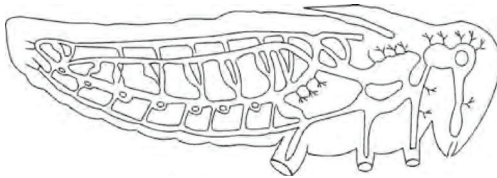

Each spiracle has a muscular valve, which can be opened or closed to regulate the flow of air. There are also hairs in the spiracles, which prevent excessive loss of water by evaporation from the tissues.

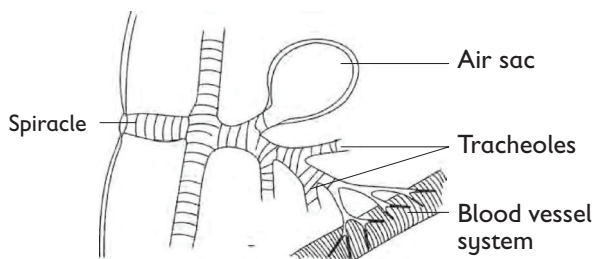

The spiracles open into large tracheal tubes called tracheae (singular trachea). These tubes are strengthened with spiral bands of chitin to keep them open at all times. There are several large air sacs, which are connected to the tracheal tubes. The tracheae are subdivided into microscopic tubes (with a diameter of about 0.1mm) called tracheoles. Tracheoles penetrate the body tissues and are in direct contact with all the living cells. They lack the spiral bands of chitin and their ends

are filled with a fluid. These ends act as respiratory surfaces between the cells and the tracheoles. In small insects, simple diffusion is enough to meet their gaseous exchange requirements. In large active insects, like grasshoppers, wasps, bees, and others breathing movements which ventilate the tracheal system are necessary to increase the efficiency of gaseous exchange.

## (c) Bony fish

In bony fish, the respiratory structures are the gills. The bony fish have four gills on each side of the body. The gills are located inside a cavity in the head region known as the **operculum cavity**. Each side of the fish has an operculum cavity which has an opening to the outside of the fish known as the opercular opening.

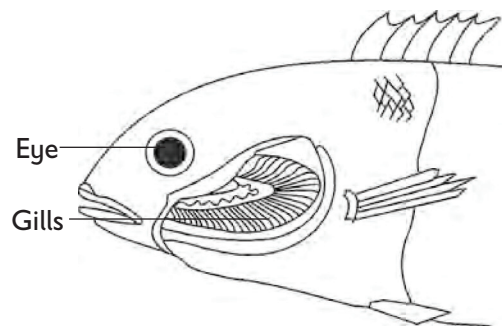

The gills are protected by a thick gill cover or **operculum** on both sides of the body near the head. This is a fold of skin made stiff by a bony plate. The gill of bony fish consists of a set of long, curved bony structures called **gill bars**, see Fig. 12.5. A large number of long thin-walled and moist **gill filaments** project from each gill bar. The curved shape of the

gill bar allows for more filaments to fit on it. The filaments are richly supplied with blood due to the presence of many capillaries. The respiratory surface of the gill on the gill filaments is a layer of cells, exposed to the surrounding water on one side and to blood vessels on the other. The thin surface allows rapid diffusion of carbon dioxide and oxygen between water and the blood.

The gill bar has bony teeth-like structures called **gill rakers** on the opposite side of the gill filaments. The gill rakers face the mouth and prevent food and other solid materials in water from reaching the delicate filaments.

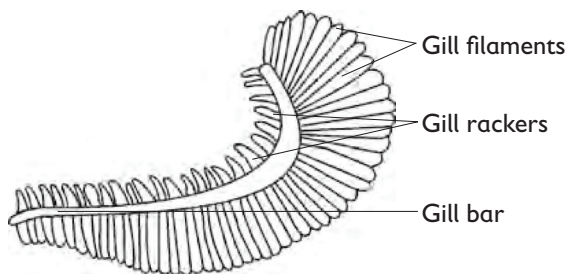

Gaseous exchange in the fish occurs between the gill filaments and water. This means that there has to be contact between water and the gill filaments. Such contact is brought about by ventilation processes of inspiration and expiration, which continuously bring in and remove water from the gills. This water gets into the mouth, passes over the gills and leaves through the opercular cavity.

#### (d) Amphibian

In an amphibian such as a frog, the respiratory structures are three i.e. the mouth cavity, the skin and the lungs.

##### (i) The mouth

The mouth or buccal cavity of a frog is the space just inside the mouth. The lining of the buccal cavity is thin and is also richly supplied with blood capillaries. It is kept moist by mucous membrane. Gaseous exchange takes place through the lining of the mouth cavity. When the frog lowers the floor of its mouth, the volume in it increases but the pressure decreases. Air is sucked into the mouth, through the nostrils.

Since the lining of the mouth is moist, oxygen dissolves in the moisture, and diffuses into the blood capillaries beneath. Carbon dioxide diffuses from the blood capillaries into the mouth cavity. When the floor of the mouth is raised, this reduces the volume in the mouth cavity, increases the pressure and air is expelled via the nostrils.

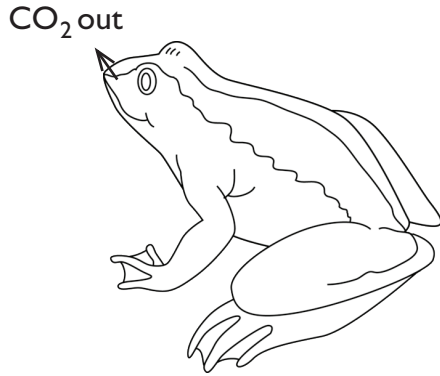

### (ii) Skin

In most land animals, the skin has a tough, waterproof epidermis for protection against injury and excessive water loss. It is not suitable for gaseous exchange. Therefore most organisms that live on land do not use the skin as a site for exchange of gases.

In the frog's skin, however, the amount of protective covering in the epidermis is small. The skin is thin and richly supplied with blood vessels kept moist by secretions from glands. The frog's skin is therefore suitable, for gaseous exchange.

### (iii) Lungs

The frog has two lungs, which are connected, to the buccal cavity through a small passage with a valve. The inner surface of the lungs is thin, moist and is richly supplied with blood capillaries. It also has tiny folds which increase the surface area for exchange of gases. Lungs in frogs work largely like those of human beings.

## Gaseous exchange across the alveoli in lungs of human beings

Gaseous exchange at the alveolus takes place between the phases of inhalation and exhalation. Figure 12.7 shows that the alveolus is a suitable point for gaseous exchange because:

- It is supplied with blood, which carries the gases being exchanged.
- It has a very thin wall across which gases diffuse between it and the blood.
- It is lined with a thin film of moisture to dissolve the diffusing gases.
- A ventilation process brings in and takes away air containing the gases being exchanged.
- The lungs has a very large number of alveoli to increase their surface area for gaseous exchange.

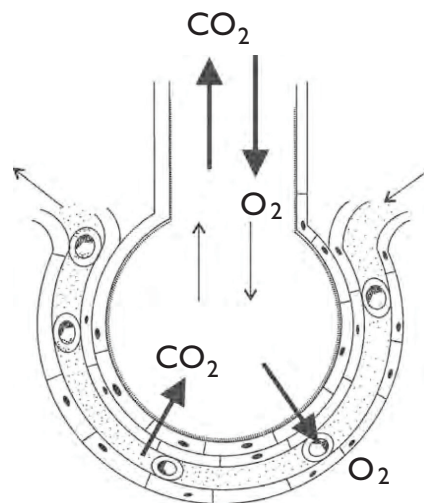

Oxygen in air in the alveolar space is at a higher concentration than that in the blood capillaries. It therefore first dissolves in the water layer in the alveolar lining then diffuses across the alveolus and then the capillary walls into the red blood cells. This becomes oxygenated blood, which is carried to the heart by the pulmonary vein. On the other hand, carbon dioxide in the blood diffuses across the capillary and alveolus walls into the alveolar space and is eventually expelled during exhalation.

**Answers to Unit Test 12** (*Pupil's book pages 250*)

1. Just like a car needs fuel, human beings require oxygen for respiration that provides the body with energy to occur.
2. (a) To increase the supply of oxygen to muscle tissues to meet increased demand.  
  
(b) Because our body tissues are starved of oxygen when we hold our breath.
3. (a) Chest – ribs move upwards and outwards thereby increasing the volume of the chest cavity. Lungs – expand allowing air in.  
  
(b) Chest – Ribs move downwards and inwards thereby reducing the volume of the chest cavity. Lungs - contract thereby expelling the air.
4. Hairs, mucus. It prevents entry of germs that can cause diseases into the body.
5. Diaphragm
6. Refer to Activity 12.4 page 246 pupil's book.
7. Carbon dioxide, oxygen.
8. Inhalation, exhalation
9. C
10. Refer to Activity 12.5 page 243 of the learners book.
11. Exercising, eating a balanced diet, avoiding smoking and excessive drinking of alcohol.

### Extension activities to cater for slow and gifted learners

<b>Remedial activities for slow learners</b>	<b>Extended activities for gifted and talented learners</b>
<ol style="list-style-type: none"> <li>1. Modelling the lungs.</li> <li>2. Drawing and tracing the path of air in the respiratory system (they should use red colouring for oxygen and blue colouring for carbon dioxide.</li> <li>3. Coming up with a table on differences between circulatory system and respiratory system on manila papers and hanging them on classroom walls.</li> </ol>	<ol style="list-style-type: none"> <li>1. Performing dissection of mouse or rabbit after demonstration by the teacher.</li> <li>2. Leading group discussions and doing presentations on behalf of group members.</li> <li>3. Summarizing lessons following guidance from the teacher.</li> <li>4. Carrying out additional research, for example on mechanism of gaseous exchange at the alveolar level and ventilation in other animals such as fish, frog and insects.</li> </ol>
<b>Remedial questions for slow learners</b>	<b>Extended questions for gifted learners</b>
<ol style="list-style-type: none"> <li>1. Name two gases involved in respiration _____ and _____</li> <li>2. The trachea is also called _____</li> <li>3. Gaseous exchange in the lungs takes place inside the _____</li> <li>4. (a) What is most likely to happen if the string is pulled down in the diagram below? _____  (b) What will happen if the rubber sheet is pushed upwards _____?</li> </ol>	<ol style="list-style-type: none"> <li>1. Relate the structure of the respiratory system to its functions.</li> <li>2. Account for darkened lungs in smokers?</li> <li>3. Using diagrams show the difference between breathing in and out.</li> <li>4. Would you rather eat apples and grapes or chew sugarcane? Why?</li> </ol>

Answers to remedial questions	Answers to extended questions
<ol style="list-style-type: none"> <li>1. Oxygen and carbon dioxide</li> <li>2. Wind pipe</li> <li>3. Air sacs or alveoli</li> <li>4. (a) Balloons will expand (b) Balloons will reduce in size</li> </ol>	<ol style="list-style-type: none"> <li>1. (a) Trachea, bronchi and bronchioles are lined with tough substance made of cartilage, which prevents them from collapsing. (b) The nose and nostril has hairs and mucous which filter dust particles and germs. (c) There are numerous alveoli, which increase surface area for gaseous exchange. (d) The walls of alveoli are very thin to reduce distance travelled by gases during gaseous exchange. (e) Alveoli are surrounded by a network of blood capillaries which supply them with blood.</li> <li>2. The smoke gets into the lungs, interfere with or stain lung tissues which makes them appear dark. This reduces efficiency of gaseous exchange.</li> <li>3. Eat apples and grapes. They are good for healthy lungs as opposed to sugar from sugar cane which affects the lungs.</li> </ol>

**UNIT**  
**13**

**Reproductive system**  
**(No. of Periods 14)**

**Refer to the Learner's Book pages 251 - 266**

**Key unit competency**

After studying this unit, the learners should be able to explain the function of male and female genital organs, the prevention, transmission and treatment of STIs and HIV and AIDS and state ways of preventing unplanned pregnancy.

**Learning objectives**

Competency based curriculum embraces

three categories of learning objectives, that is, knowledge and understanding, skills acquisition and attitude and values.

At the end of the unit, learners should have knowledge and understanding of the reproductive system and have the right attitude towards preventing STIs and taking good care of the reproductive system.

**Table 13.1 Knowledge, skills and values to be attained**

<b>Knowledge and understanding</b>	<b>Skills</b>	<b>Attitudes and values</b>
<p>By the end of this unit, learners should be able to:</p> <ul style="list-style-type: none"> <li><input type="checkbox"/> Explain the main function of reproductive system.</li> <li><input type="checkbox"/> Explain how boys and girls have different external and internal reproductive organs.</li> </ul>	<p>By the end of this unit, learners should be able to:</p> <ul style="list-style-type: none"> <li><input type="checkbox"/> Clean external genital organs regularly.</li> <li><input type="checkbox"/> Demonstrate how to use a condom to avoid pregnancy.</li> </ul>	<p>By the end of this unit, learners should be able to:</p> <ul style="list-style-type: none"> <li><input type="checkbox"/> Show concern for the care of genital organs in order to prevent diseases.</li> <li><input type="checkbox"/> Appreciate the importance of asking questions about the genital organs.</li> </ul>

<ul style="list-style-type: none"> <li><input type="checkbox"/> Explain the purpose/ function of human reproductive system.</li> <li><input type="checkbox"/> Describe how to prevent unplanned pregnancy.</li> <li><input type="checkbox"/> Explain the social and health consequences of unwanted or early pregnancy.</li> <li><input type="checkbox"/> Describe the danger of procuring an illegal or unsafe abortion.</li> <li><input type="checkbox"/> Describe common STIs.</li> <li><input type="checkbox"/> Explain the transmission prevention and treatment of common STIs.</li> <li><input type="checkbox"/> Explain the basic facts about HIV and AIDS.</li> <li><input type="checkbox"/> Analyze how to prevent and treat common STIs and HIV and AIDS.</li> <li><input type="checkbox"/> Explain available treatment for HIV and AIDS.</li> <li><input type="checkbox"/> State how to live positively with HIV and AIDS patients.</li> </ul>	<ul style="list-style-type: none"> <li><input type="checkbox"/> Be aware of signs and symptoms of common STIs and HIV and AIDS.</li> <li><input type="checkbox"/> Use condoms correctly and consistently</li> <li><input type="checkbox"/> Adhere to ARVs.</li> <li><input type="checkbox"/> Care for someone with HIV and AIDS</li> <li><input type="checkbox"/> Negotiating safer sex practices.</li> </ul>	<ul style="list-style-type: none"> <li><input type="checkbox"/> Be aware of the importance and need to abstain from sex.</li> <li><input type="checkbox"/> Use basic methods of contraception safely.</li> <li><input type="checkbox"/> Be non-judgmental of people who have STIs or HIV and AIDS.</li> <li><input type="checkbox"/> Be aware of confidentiality, avoiding stigmatization or adjudging people having STIs or HIV and AIDS.</li> <li><input type="checkbox"/> Show concern for personal responsibility as a way to protect oneself against STIs and HIV and AIDS.</li> <li><input type="checkbox"/> Show respect and compassion towards people living with HIV and AIDS.</li> <li><input type="checkbox"/> Show concern about voluntary counselling and testing and its benefits.</li> <li><input type="checkbox"/> Be aware of risk reduction strategies for STIs and HIV and AIDS.</li> </ul>
--	---	--



## Pre-requisite of this unit

Learners are already privy to many body system such as digestive, circulatory and respiratory systems. In this class learners will learn about the reproductive and respiratory systems. Take advantage of learners prior knowledge when teaching this unit. Further during the lessons, strive to bring to the awareness of learners the fact that this topic is related to reproductive health in biology. Let learners understand that at this level, they may only need the basic information otherwise, details of functioning of the reproductive system will be learnt in high school and later in life when they specialize in gynaecology branch of medicine.

### Background information

Just like the circulatory and reproductive systems, let learners understand that reproductive system is one of the many body systems. It is the system that helps in procreation. **REMEMBER** – the difference between sexual and asexual reproduction should be emphasized then narrow down to sexual reproduction of which this topic is about. Also, let learners understand that they will be covering diseases that affect the reproductive system (STIs), early pregnancy and how to deal with it. Finally, learners will learn about HIV and AIDS and how to live positively with

the infected. This topic will therefore in a nutshell enable learners realize the need for a reproductive system, what makes it up in both males and females and how to stay responsibly in general to avoid problems that are associated with the reproductive system such as early pregnancy and STIs.

## Cross-cutting issues to be addressed

### 1. Comprehensive sexuality education

Emphasize the need for learners to take good care of themselves in order to avoid early pregnancy, STIs and HIV and AIDS. Stress the fact that diseases such as HIV and AIDS have no cure hence they should avoid them at all costs. Emphasize abstinence until marriage. Also, this topic is about contraceptives. Let learners appreciate the need of using contraceptives later on when they form families.

### 2. Gender education

Bring to the attention of learners the fact that reproductive health affects people of all genders and that it is not a preserve of women only. Emphasize the fact that STIs and HIV and AIDS affects people of all gender therefore the need for all to play their part in preventing the diseases.

Also, emphasize to learners that anybody irrespective of their gender can pursue a carrier in medicine and specialize in Gynaecology. Give examples of role models who are successful gynaecologists in the area where the learners come from.

### **3. Standardization culture**

Emphasize the need to visit qualified personnel when seeking medical help with regard to the reproductive system. Also, they should always go for quality and approved medicine/ contraceptives.

### **4. Financial education**

Learners should be made aware of the fact that taking proper care of themselves will help them avoid STIs and other diseases such as HIV and AIDS. They will also avoid unwanted pregnancy and in the long run, save money by avoiding costs that are associated with treatment and taking care of pregnancy and delivery.

### **5. Inclusive education**

All learners should be encouraged to participate during lessons and practicals. Special arrangement

should be made to take care of learners with special needs. For example, provide brail for blind learners, large print text for those with sight problems and allocate physically challenged learners to others to assist them during field trips and practical activities. Further, this category should be given tasks that they can manage during the practical sessions.

### **6. Environment and sustainability education**

Bring to the attention of learners the fact that contraceptives such as condoms, coils and diaphragms can contaminate the environment hence there is need to dispose them of properly. They can be well wrapped in tissue paper then thrown in dustbins to await being dumped into garbage sites.

## **Generic Competences**

### **1. Co-operation and interpersonal management and life skills**

During group discussions and pair-work let learners engage

one another by giving a chance for all to participate. Also, during group presentations, you can allow rotational presentations within the group members. Gifted learners should help in coming up with presentation content as slow learners contribute. **REMEMBER** You should allow slow learners to do presentations as well and correct them where they go wrong. Advise learners to appreciate the different abilities of their group members and accommodate each other's views.

## 2. Research skills

Guide learners on how to find out information regarding various topics such as the different parts that make up the reproductive systems, STIs and HIV and AIDS and the consequences of early pregnancy. Guide learners on how to come up with summarized notes from a large body of text. You should also guide learners on doing Internet searches for the various content areas they are looking for.

## 3. Communication in English

Communication in English will be improved when learners freely participate in the discussions and presentations. Encourage all learners irrespective of their abilities to participate in-group discussions, during presentations by asking

questions and during question and answer sessions to either introduce or wrap up the lessons.

## 4. Critical thinking and problem solving skills

This competence will be developed by learners as they answer the probing questions such as those on page 270 at the beginning of this unit and as they discuss the results of the various practical activities. Guide learners to discover for themselves how teenage pregnancies can be avoided and how to stay free from STIs and HIV and AIDS.

This competence will also come about as learners think about their findings in the activities and as they give out their suggestions on why this is the case.

## 5. Lifelong skills

Behaving responsibly in general creates a habit of taking care of oneself. For example, when learners behave responsibly, they avoid problems such as early pregnancy and HIV and AIDS. Learners can also pass this habit to others through training or by being role-models or through mentorship. Also, make learners aware that they can become doctors and particularly gynaecologists if they take this topic seriously.

### Key words in this unit and their meanings

- **Abstinence (or to abstain)** – the act or practice of restraining oneself from indulging in something, for example sexual intercourse.
- **Contraceptive** – this term refers to a device, medicine or any other substance that prevents pregnancy.
- **Fertilization** – Fusion of male and female gametes to form a zygote. The zygote later develops into embryo, foetus then finally baby.
- **Opportunistic disease** – any infection caused by a microorganism that does not normally cause disease in human beings. It usually occurs in persons with abnormally functioning immune systems such as those with HIV and AIDS.
- **Pregnancy** – This is the term used to refer to the period from conception until childbirth.
- **Pre-marital sex** – This term refers to engaging in sexual intercourse before marriage.
- **Reproduction** – this is a term that refers to any of various processes, by which an animal or a plant produces one or more individuals similar to itself. It can be either sexual (involving male and female gametes) or asexual (no gametes are involved).
- **Sexual intercourse** – Sexual union between a male and a female organism involving insertion of the penis into the vagina.
- **Teenagers** – A boy or a girl at puberty, usually between the ages of 13 – 20 years.
- **Tubal ligation** – This is a method of female sterilization in which the fallopian tubes are usually surgically tied or cut.
- **Vasectomy** – This is a method of male sterilization in which the sperm ducts are usually surgically tied or cut to prevent passage of semen.
- **Zygote** – This is the cell resulting from the union of an ovum and a sperm.

### Guidance on the problem statement

In this topic, you will teach about the reproductive system in both males and females. You will teach about pregnancy and family planning. As a way of introducing reproduction, refer the learners to the picture on page 251 of their books and guide the learners to discuss the conversation of the family members in the picture. It is about a

family that cannot take care of itself well. Through it, learners should realise that bearing children requires proper family planning.

### Attention to special educational needs

Support for Multi-ability learning	Support for special needs learning
<ul style="list-style-type: none"> <li>– Slow learners can point at the various parts on the charts as gifted learners name the parts and explain their functions.</li> <li>– Gifted learners can be performing the actions during practical activities as slow ones make observations and take notes. For example, in activities 13.5 and 13.9.</li> <li>– Both gifted and slow learners to be given equal opportunity to lead in group discussions and to do presentations of group findings to the rest of the class.</li> <li>– Ensure all learners respect other's views irrespective of their shortcomings or talents.</li> </ul>	<ul style="list-style-type: none"> <li>– Allocate roles like holding charts and dismantling models like the reproductive system model to learners with physical disabilities.</li> <li>– Provide brail for blind learners and large print text to learners with seeing difficulties. Provide sign language alphabet symbols and sign language interpreters for the deaf.</li> <li>– Also, arrange learners such that shortsighted ones are at the front and long-sighted ones are at the back. Spectacles can as well be provided if available.</li> </ul>

## List of lessons

Lesson No.	Lesson title	No. of periods
1.	Function of the human reproductive system	1
2.	Parts of the male reproductive system and their functions	2
3.	Parts of the female reproductive system and their functions	2
4.	Differences between male and female genitalia	1
5.	Early (teenage) pregnancy and its consequences	2
6.	How to avoid unplanned (unwanted) pregnancies	1
7.	Dangers of illegal abortion	1
8.	Common STIs and their prevention	2
9.	Basic facts about HIV and AIDS	1
10.	Treatment and prevention of HIV and AIDS and living positively with HIV and AIDS patients	1

### Lesson 1: Function of the human reproductive system.

Refer to learner's book pages 251-252

#### Specific objectives

By the end of the lesson, learners should be able to explain the function of the human reproductive system.

#### Preparation for the lesson

1. This lesson will involve individual research work and group discussions. You will therefore organize the class as need arises during the lesson. **REMEMBER:** When grouping learners, you should consider the different abilities of learners and the special needs for various individuals.
2. Look for textbooks, handouts, pamphlets and other materials on reproductive system.
3. Ensure the internet is working properly before the lesson for learners to use to do research.

## Teaching aids

- Textbooks, handouts and pamphlets
- Computers connected to the Internet.
- 

## Pre-requisite of the lesson

1. Introduce the unit as explained under **guidance on the problem statement** above then narrow down to this lesson.
2. You may remind learners about the circulatory and respiratory systems they learnt about in the previous units. Ask questions such as:
  - (a) What is circulatory system?  
(Ans: *system that transports blood throughout the body*)
  - (b) How about respiratory system?  
(Ans: *System that takes fresh air into and stale air out of the lungs*)
  - (c) What is their importance?  
(Ans: *Circulatory system distributes oxygen, food nutrients and other materials throughout the body and also helps to remove body wastes; Respiratory system provides body tissues with oxygen which is required for respiration*).
  - (d) Do you think the body has other systems apart from circulatory and respiratory system? (Ans: Yes) Which ones?  
(Ans: *Excretory system, reproductive system*).

3. From the probing questions, learners may mention reproductive system. Take advantage and introduce it.

## Teaching / learning activities

### Activity 13.1 (Refer to Pupil's book page 251)

- This is a research activity to be done by individual learners. Let learners go to the library to read textbooks on what reproductive system is and its function and write summary notes. They can also use the textbooks and handouts or pamphlets, which you will provide. If the school has Internet connectivity, guide learners to visit sites where they can get this information. For example: <http://www.scholar.google.com> or by simply searching reproduction using google search engine.
- Guide learners to discover the role of reproductive system, which is to create new individuals for continuity of species. (You may need to stress the fact that without reproduction, species will become extinct).
- At this point, you may inform learners that reproduction can be sexual or asexual.
- Ask learners how they plant sugarcane or sweet potatoes, then what happens. Emphasise the fact that this is a form of asexual reproduction where gametes are not involved.

- You can then narrow down to human beings and ask learners how they think babies come into being. Let them know that this is a form of sexual reproduction and that it involves reproductive systems for both males and females.

### Synthesis

This lesson introduces learners to the human reproductive system. Learners should discover what the term reproduction means and the important role played by reproductive system in organisms which is to perpetuate a given species (ensure that it doesn't become extinct).

### Lesson assessment

Assess whether the learning objectives of the lesson was met by asking questions such as:

1. What did you learn in this lesson?  
(Ans: Meaning of reproduction and function of reproductive system in human body.)
2. Of what significance is reproductive system?  
(Ans: Ensures continuity of a given species.)

### Lesson 2: Parts of the male reproductive system and their functions

Refer to learner's book pages 252

### Specific objectives

By the end of the lesson, learners should be able to identify the different parts of the male genitalia and explain their functions.

### Preparation for the lesson

1. This lesson will involve individual research work and group activity. You will therefore organize the class as need arises during the lesson.  
**REMEMBER:** When grouping learners, you should consider the different abilities of learners and the special needs for various individuals.
2. Look for textbooks, handouts, pamphlets and other materials on reproductive system.
3. Ensure the Internet is working properly before the lesson for learners to use to do research.

### Teaching aids

- Textbooks, handouts and pamphlets.
- Computers connected to the Internet.

**IMPROVISATION:** You may come up with a well-painted diagram on male genitalia on a manila paper and use it instead of charts.



### Pre-requisite of the lesson

- You may remind learners about what they learnt in the previous lesson. Ask questions such as:

(i) What is reproduction?

*(Ans: The process of giving rise to young ones of own kind).*

(ii) What is the role of reproductive system in human body?

*(Ans: Helps with reproduction or bringing up new individuals).*

- By now, learners have a rough idea what reproductive system and its function is hence you can now delve further into the components of the reproductive system.
- Let learners know that we have male and female reproductive systems. Emphasize the fact that they will learn about the male reproductive system in this lesson.

### Teaching / learning activities

#### Activity 13.2 (Refer to Pupil's book page 252)

- Provide learners with charts showing both internal and external male genitalia. Let them study the charts in groups.
- In their groups, they can play a game of pointing and naming the various parts. Let one member point at a part as others name the part.

- Guide learners to draw and label the internal and external male genitalia in their notebooks. Correct them where appropriate.
- In the second period of the lesson, give learners a chance to do research on the functions of the various parts of the male genitalia. Let them write summary notes then share with other group members.
- Let the learners in each group choose a group leader to help them summarize their points on functions of the various parts of the male genitalia in a table format. He or she should then do a presentation to the rest of the class on behalf of the group.
- Summarise the lesson by describing the functions of the various parts as learners note down main points.

### Synthesis

From the previous lesson, learners already have an idea what reproductive system is. The activities carried out during this lesson should help learners discover the various organs that make up the male reproductive system both internally and externally and appreciate their functions in a reproductive process.

### Lesson assessment

Assess whether the learning objectives of the lesson were met by asking questions such as:

1. What makes up external male genitalia?  
(Ans: Penis, testicles and scrotum.)
2. What is the function of:
  - (a) Urethra?  
(Ans: Lets out semen during copulation)
  - (b) Sperm duct?  
(Ans: Passage for sperms from epididymis to urethra.)
  - (c) Seminal vesicles?  
(Ans: Produce semen together with prostate and cowper's glands. Semen helps in transporting sperms.)
3. Do you think male genitalia are same or different from female genitalia?  
(Ans: Different)

### Lesson 3: Parts of the female reproductive system and their functions

Refer to learner's book pages 253

#### Specific objectives

By the end of the lesson, learners should be able to identify the different parts of the female genitalia and explain their functions.

### Preparation for the lesson

1. This lesson will involve individual research work and group activity. You will therefore organize the class as need arises during the lesson.  
**REMEMBER:** When grouping learners, you should consider the different abilities of learners and the special needs for various individuals.
2. Look for textbooks, handouts, pamphlets and other materials on reproductive system.
3. Ensure the Internet is working properly before the lesson for learners to use to do research.

### Teaching aids

- Textbooks, handouts and pamphlets.
- Computers connected to the Internet.

**IMPROVISATION:** You may come up with a well painted diagram on female genitalia on a manila paper and use it instead of charts.

### Introduction to the lesson

- You may remind learners about what they learnt in the previous lesson. Ask questions such as:
1. What is male genitalia made of:
    - (a) externally? (Ans: Scrotum, penis, testicles).
    - (b) Internally? (Ans: Urethra, seminal vesicles, cowper's gland, sperm duct, and epididymis).
    - (c) Do you think in females, the internal genitalia are different from the external genitalia? (Ans: Yes)

- Let learners know that the male and female reproductive systems are different. Emphasize the fact that one is designed to produce ova (female) and the other to produce sperms and introduce them into the female genitalia during copulation (male).
- Summarise the lesson by describing the functions of the various parts of the female genitalia as learners note down main points.

### Synthesis

From the previous lesson, learners already have an idea what male reproductive system is made of. Borrow the same leaf and help learners discover the various organs that make up the female reproductive system both internally and externally and help them appreciate the functions of these parts in a reproductive process.

### Teaching / learning activities

#### Activity 13.3 (Refer to Pupil's book page 253)

- Provide learners with charts showing both internal and external female genitalia. Let them study the charts in groups.
- In their groups, they can play a game of pointing and naming the various parts. Let one member point at a part as others name the part.
- Guide learners to draw and label the internal and external female genitalia in their notebooks. Correct them where appropriate.
- In the second period of the lesson, give learners a chance to do research on the functions of the various parts of the female genitalia. Let them write summary notes then share with other group members.
- Let the learners in each group choose a group leader to help them summarize their points on functions of the various parts of the female genitalia in a table format. He or she should then do a presentation to the rest of the class on behalf of the group.

### Lesson assessment

Assess whether the learning objectives of the lesson were met by asking questions such as:

1. What makes up internal female genitalia?  
(Ans: Ovary, fallopian tube, uterus, vagina and cervix)
2. What is the other name of:
  - (a) Uterus? (Ans: Womb)
  - (b) Fallopian tube? (Ans: Oviduct)
  - (c) Vagina? (Ans: Birth canal)
3. Where does fertilization take place in female genitalia? (Ans: Fallopian tube)
4. Differentiate between Bartholin gland and clitoris? (Ans: Bartholin gland – produces chemical substances like hormones, Clitoris – flap of flesh in external female genitalia that is very sensitive to touch).

## Lesson 4: Differences between male and female genitalia

### Specific objectives

By the end of the lesson, learners should be able to differentiate between male and female parts of the human reproductive system.

### Preparation for the lesson

1. This lesson will involve review of the previous two lessons as a class and group activity. You will therefore organize the class as need arises during the lesson.

**REMEMBER:** When grouping learners, you should consider the different abilities of learners and the special needs for various individuals.

2. Look for male and female reproductive system charts.
3. Ensure the Internet is working properly before the lesson for learners to use to do research.

### Teaching aids

- Textbooks, handouts and pamphlets.
- Computers connected to the Internet.

**IMPROVISATION:** You may come up with your summary table on differences between male and female genitalia on a manila paper.

### Pre-requisite of the lesson

- You may remind learners about what they learnt in the previous lesson. Ask questions such as:
  1. What is male genitalia made of: externally? (*Ans: Scrotum, penis, testicles*).
  2. What is female genitalia made of externally? (*Ans: labia mijora and minora, vulva, clitoris and Bartholin gland*).
- At this point, you can introduce Activity 13.3.

### Teaching / learning activities

Provide learners with charts showing both internal and external female and male genitalia. Let them study the charts in groups.

Guide learners to draw and label the internal and external male and female genitalia in their notebooks.

Let them compare the external genitalia for males and female in pairs. Ask them to state any similarities or differences that they noted.

Let them repeat the step above but this time using the internal structure of male and female genitalia. They should come up with a list of similarities and differences as well.

Summarize the lesson by guiding the learners to come up with a table on similarities and differences between the male and female genitalia. A sample table is given below.

<b>(a) Similarities</b>	
<ol style="list-style-type: none"> <li>Both have urethra</li> <li>Both have internal and external parts which are different</li> </ol>	
<b>(b) Differences</b>	
<b>Male genitalia</b>	<b>Female genitalia</b>
<ol style="list-style-type: none"> <li>Externally is made up of scrotum, testicles and penis.</li> </ol>	<ol style="list-style-type: none"> <li>Externally is made up of labia mijora and minora, clitories and bartholin gland.</li> </ol>
<ol style="list-style-type: none"> <li>Internally is made of urethra, sperm duct, epididymis, seminal vesicles and prostate and Cowper's glands.</li> </ol>	<ol style="list-style-type: none"> <li>Internally is made of ovary, oviduct, uterus, vagina and cervix.</li> </ol>
<ol style="list-style-type: none"> <li>Produces and deposits sperms into the female reproductive system.</li> </ol>	<ol style="list-style-type: none"> <li>Produces ova and receives sperms from the male reproductive system.</li> </ol>

**REMEMBER:** Emphasize the need for learners to clean their genitals regularly in order to avoid diseases. This should particularly be done to girls especially when they are undergoing menstruation. Capture this as a cross cutting issue under Reproductive health and comprehensive sexuality education.

### Synthesis

This lesson is meant to consolidate what learners were taught in lessons 2 and 3 about the external and internal genitalia of males and females. Help learners discover the various similarities and

differences between the male and female genitalia and come up with a table on the same as shown above.

### Lesson assessment

Assess whether the learning objectives of the lesson were met by asking questions such as:

- What are the similarities between male and female genitalia?

*(Ans: Both have internal and external parts, which are different; both have urethra)*

2. What are the differences between:
- Female and male Internal genitalia? (*Ans: Refer to table above*)
  - Female and male external genitalia? (*Ans: Refer to table above*)

### Lesson 5: Early (teenage) pregnancy and its consequences

Refer to learner's book pages 256

#### Specific objectives

By the end of the lesson, learners should be able aware of what teenage pregnancy and its consequences

#### Preparation for the lesson

- This lesson will involve individual research work and group work. You will therefore organize the class as need arises during the lesson.  
**REMEMBER:** When grouping learners, you should consider the different abilities of learners and the special needs for various individuals.
- Look for textbooks, handouts, pamphlets and other materials on teenage pregnancy.
- Ensure the Internet is working properly before the lesson for learners to use to do research.

#### Teaching aids

- Textbooks, handouts and pamphlets.
- Computers connected to the Internet.
- Posters on consequences of teenage pregnancy and warning against irresponsible behaviour

#### Improvisation

You may come up with posters bearing warnings against irresponsible sexual behavior that may lead to teenage pregnancy.

#### Introduction to the lesson

- You may introduce the lesson by asking probing questions such as:
  - What is pregnancy? (*Ans: The period between conception and birth*).
  - Have you ever seen a pregnant mother? (*Ans: Yes*).
  - Is pregnancy good or bad? (*Ans: It may be good or bad depending on the person who has become pregnant*).
- You can then guide learners to the discussion activity on page 260 in order for them to discover what pregnancy is and the consequences of early pregnancy.

### Teaching / learning activities

- Refer learners to the pictures on page 257 of their book. Put them in groups based on their abilities and class size then let them talk about what is happening in the pictures. Their discussion should also include what will happen to both the boy and the girl.
  - Guide them to find out what the difference between early pregnancy and unplanned pregnancy is. **REMEMBER:** Early pregnancy is also known as **teenage pregnancy** whereas unplanned pregnancy is **unwanted pregnancy**, which occurs between couples by accident.
  - Emphasise the signs of pregnancy as highlighted in the pupil's book page 260 This will prepare girls to be in a position to know when they are pregnant by accident and take necessary precautions.
- Challenge learners to think about what they can do to prevent early pregnancy. Emphasise ABSTINENCE though later on under contraceptives, you may tell learners to develop a habit of using condoms as a way of preventing pregnancy and STIs in case they are tempted to have sexual intercourse!
  - Let the learners in each group choose a group leader to help them summarize their points on what pregnancy is, signs of pregnancy and consequences of early pregnancy. He or she should then do a presentation to the rest of the class on behalf of the group.
  - Summarise the lesson by highlighting key points.

**REMEMBER:** Emphasize the importance of ABSTINENCE as a cross cutting issue under Reproductive health and comprehensive sexuality education.

### Find out (Refer to Pupil's book page 256)

- Guide learners to do research as guided on page 256 of their book. Let them write short notes and share with their friends once they come back to class.
- Initiate a discussion on what the consequences of early pregnancy are. Let the learners contribute points as their group leader notes them down.

### Synthesis

This lesson is about early pregnancy and its consequences. Take your time to emphasize the side effects of early pregnancy and caution learners against irresponsible sexual behaviour.

### Lesson assessment

Assess whether the learning objectives of the lesson were met by asking questions such as:

1. What is early pregnancy? (*Ans: Getting pregnant before marriage*)
2. How is it different from unplanned pregnancy? (*Ans: Unplanned pregnancy is that that is not planned for. It mostly happens by accident.*)
3. Which signs would you look out for if you suspect your friend is pregnant?  
(*Ans: Refer to learner's book page 284*)
4. Give three consequences of early pregnancy.  
(*Ans: Refer to learner's book pages 284-285*)

### Lesson 6: How to avoid unplanned (unwanted) pregnancies

Refer to learner's book pages 257

#### Specific objectives

By the end of the lesson, learners should be aware of the methods to use in order to prevent unplanned (unwanted) pregnancy.

#### Preparation for the lesson

1. This lesson will involve individual research work, group work and

demonstrations. You will therefore organize the class as need arises during the lesson. **REMEMBER:** When grouping learners, you should consider the different abilities of learners and the special needs for various individuals.

2. Look for textbooks, handouts, pamphlets and contraceptives such as condoms, pills, diaphragms, coils among others.
3. Ensure the Internet is working properly before the lesson for learners to use to do research.

#### Teaching aids

- Contraceptives such as condoms, pills, diaphragms and coils, pipe, string, some water in a tin.
- Charts on vasectomy and tube ligation
- Textbooks, handouts and pamphlets.
- Computers connected to the Internet.

#### Pre-requisite of the lesson

- You may introduce the lesson by showing the learners the various contraceptives. Ask them what they think they are and their use.
- Most learners may have come across a condom. Take advantage of this and introduce the concept of use of condom as a contraceptive.



### Teaching / learning activities

- Refer learners to page 285 of their book. Let them find out more about the various methods used to prevent pregnancy individually. Let them find out how the methods work and their advantages and disadvantages.
- Back in class, put them in groups based on their abilities and class size then let them talk about what their findings were.
- Guide learners in each group to choose a group leader to do presentation to other class members on behalf of the group.
- Highlight the main points about each contraception method emphasizing their advantages and disadvantages
- For condoms, carry out a class demonstration on proper use of a condom.

### Activity 13.5 (Refer to Pupil's book page 258)

- Using a penis model or a ripe banana, demonstrate to learners how to put on a condom properly. **REMEMBER:** Emphasize to learners the importance of proper putting on of condom to avoid bursting or tearing.
- Let learners individually put on a condom on the model or ripe banana. They should repeat this several times until they become familiar.

**REMEMBER:** Emphasise the importance of using a condom during sexual intercourse as a cross cutting issue under Reproductive health and comprehensive sexuality education. This will help prevent unwanted pregnancies and STIs including HIV and AIDS.

- Narrow down to the permanent methods of family planning. i.e. vasectomy and tube ligation.
- Let learners do some research on what vasectomy and tube ligation are.
- Show learners the charts on vasectomy and tube ligation. Put them into groups. Let them recall the structure of internal genitalia both for males and females. They should draw them in their notebooks.
- Narrow down to the cut or folded areas in the diagrams. Let them identify what has been done to these parts.
- To hammer the point home, demonstrate using a tied pipe and open pipe and water. Pour some water in an open pipe. Let learners say what happens. Next, tie the pipe using a string. Let them say what happens.
- Relate the findings above to what happens in either vasectomy or tube ligation. Let learners write summary notes and draw the diagrams in their notebooks.

**REMEMBER:** Emphasise the advantages and disadvantages of tube ligation and the necessity to seek consent of your partner in a marriage relationship before carrying out tube ligation or vasectomy.

### Synthesis

This lesson is about creating awareness about unplanned pregnancies and how to avoid them. Take your time to emphasize the need to avoid getting children who are not planned for through use of contraceptives. Proper use of condoms in particular should be emphasized and the proper use of the various contraceptives. You should also emphasize the advantages and disadvantages of the various methods for the learners to make informed choices when they grow up.

**IMPORTANT:** Remember to emphasize the fact that the contraception methods are not necessarily meant for use by learners at this level. It is meant for educative purposes so the learners should know what to do when they get married. At this stage, emphasize ABSTINENCE!

### Lesson assessment

Assess whether the learning objectives of the lesson were met by asking questions such as:

1. Differentiate between early pregnancy and unplanned pregnancy.  
(Ans: *Early pregnancy - Getting pregnant before marriage; unplanned*

*pregnancy – getting pregnant accidentally).*

2. Name two contraceptives that you know.  
(Ans: *diaphragm, condoms, coils, norplant, spermicides, depo-provera*)
3. \_\_\_\_\_ (Vasectomy) is to men whereas \_\_\_\_\_ is to women.  
(Ans: *tube ligation*).
4. Write IUD in full.  
(Ans: *Intra-uterine device*)

## Lesson 7: Dangers of illegal abortion

Refer to learner's book page 259

### Specific objectives

By the end of the lesson, learners should be aware of the dangers of illegal abortion.

### Preparation for the lesson

1. This lesson will involve individual research work and group discussion. You will therefore organize the class as need arises during the lesson.  
**REMEMBER:** When grouping learners, you should consider the different abilities of learners and the special needs for various individuals.
2. Look for textbooks, handouts, pamphlets and other materials on abortion. You may also look for a video on consequences of abortion. Use the link: <https://www.youtube.com/watch?v=8GzjO14Yetc>. Test it before the lesson to ensure it is working.

3. Ensure the Internet is working properly before the lesson for learners to use to do research.

### Teaching aids

- Video link: <https://www.youtube.com/watch?v=8GzjO14Yetc>.
- Charts on consequences of abortion.
- Textbooks, handouts and pamphlets on abortion.
- Computers connected to the Internet.

### Introduction to the lesson

- You may introduce the lesson by asking learners what abortion is. Let them look for its meaning either in textbooks, handouts, pamphlets or the internet.

### Teaching / learning activities

- Let learners carry out research what abortion is and its dangers and risks. They can do this using textbooks in the library or the internet.
- Show learners the video on abortion. Let them watch as they note down summary notes regarding the risks and dangers of abortion.
- Using the information from the video and textbooks, let the learners summarize their findings and share with other class members.

- Highlight the main points about dangers of abortion as learners write summary notes.

**REMEMBER:** Emphasise the importance of not engaging in illegal abortion as a cross cutting issue under Reproductive health and comprehensive sexuality education. This will help prevent risks and dangers associated with illegal abortion.

### Synthesis

This lesson is about creating awareness about illegal abortion. Use the video to effectively pass across the message. Emphasize dangers of abortion and most importantly possibility of dying during abortion. Also, bring to the attention of learners the fact that ABSTINENCE is the surest way to avoid abortion and its effects.

### Lesson assessment

Assess whether the learning objectives of the lesson were met by asking questions such as:

1. What is abortion? (*Ans: Removing unborn child pre-maturely*)
2. What are the dangers of abortion? (*Ans: Refer to pupil's book page 259*)

## Lesson 8 : Common STIs and their prevention

(To be covered in two periods)

Refer to learner's book pages 260

### Specific objectives

By the end of the lesson, learners should be able to:

- Describe common STIs.
- Explain the transmission, prevention and treatment of common STIs.

### Preparation for the lesson

1. This lesson will involve a research activity either in the library or using the Internet and group work.
2. Bring pamphlets, handouts, and textbooks for reference in class. Also, ensure that the Internet is working if you have a computer laboratory or any other form of Internet connectivity such as WIFI or modem.
3. Test whether the video link - <https://www.youtube.com/watch?v=SyJwEUIUOzk> is working.

### Teaching aids

- Reference materials on sexually transmitted infections diseases, their causes, signs and symptoms and prevention/control.

- Video link on STIs i.e. <https://www.youtube.com/watch?v=SyJwEUIUOzk>

### Pre-requisite of the lesson

- Introduce the topic by reminding learners about common diseases that they know or might have come across. Ask probing questions such as: **What causes the diseases? How are they controlled?**
- You can then ask them if they think Reproductive system can be affected by diseases. Let them do research on this.

### Teaching / learning activities

#### Activity 13.6 (Refer to Pupil's book page 260)

- Let learners go to the library and search in textbooks or the internet, diseases that affect the reproductive system which are sexually transmitted and their signs and symptoms.
- Let them watch the video on sexually transmitted diseases through the link above. They should write short notes on:
  - Signs and symptoms of the diseases

- Their cause
  - Mode of transmission
  - Control and prevention
- Back in class, put learners in groups depending on the size of the class and the abilities of class members to harmonize their findings. Let them choose a group leader to do a presentation on their behalf.
  - After the presentations, guide learners to write short notes and draw a table on various STIs, their causes, signs & symptoms and control/prevention measures.

### Synthesis

This lesson is about creating awareness of STIs particularly gonorrhoea, syphilis, chancroid and candidiasis. Guide learners to discover by way of research and watching the video, the causes, signs and symptoms and prevention/control measures of the diseases. They should at the end appreciate the need to prevent/control these diseases as a way of living healthy life.

### Lesson assessment

Assess whether the learning objective of the lesson was met by asking questions such as:

1. Name common STIs that you know. (*Ans: Heart attack, stroke, antherosclerosis, high blood pressure among others*)
2. What causes
  - (a) Syphilis? (*Ans: bacteria*)
  - (b) AIDS? (*Ans: HIV (Virus)*)
  - (c) Vaginal candidiasis? (*Ans: Fungi*)
3. Give two symptoms each of
  - (a) Gonorrhoea?  
(*Ans: Refer to table 13.2 pages 260-261 Pupil's book*)
  - (b) Chancroid?  
(*Ans: Refer to table 13.2 page 298 Pupil's book*)
4. What is the most effective way of preventing STIs? (*Ans: Abstinence*)

### Lesson 9: Basic facts about HIV and AIDS

Refer to learner's book pages 262

### Specific objectives

By the end of the lesson, learners should be able to:

- State the meaning of HIV and AIDS.
- Explain the cause of HIV and AIDS.

- Describe how HIV and AIDS is transmitted.
- Describe the symptoms of HIV and AIDS.

### Preparation for the lesson

1. This lesson will involve a research activity either in the library or using the Internet and group work.
2. Bring pamphlets, handouts, and textbooks for reference in class. Also, ensure that the Internet is working if you have a computer laboratory or any other form of Internet connectivity such as WIFI or modem.
3. Test whether the video link <https://www.youtube.com/watch?v=17pfZUIAqow> is working or any other relevant video link.

### Teaching aids

- Reference materials on HIV and AIDS – may include textbooks, magazines, hand outs and pamphlets.
- Video link on HIV and AIDS such as: <https://www.youtube.com/watch?v=17pfZUIAqow>

### Pre-requisite of the lesson

- Introduce the lesson by reminding learners about the STIs they learnt about in the previous lesson. Ask probing questions such as:

1. What are STIs? (*Ans: Sexually transmitted infections*)
  2. Can you name some STIs that you know? (*Ans: Syphilis, gonorrhoea, chancroid, HIV and AIDS*)
- Amongst the STIs the learners are likely to name is HIV and AIDS. Take advantage of this and introduce the basic facts about HIV and AIDS.

### Teaching / learning activities

#### Activity 13.8 (Refer to Pupil's book page 262)

- Let learners go to the library and search in textbooks or the Internet, what HIV and AIDS is, its cause, how it is transmitted and its signs and symptoms.
- Let them watch the video on HIV and AIDS through the link provided above. They should write short notes on:
  - Signs and symptoms of the disease
  - Its cause
  - Mode of transmission
  - Its progression
  - Signs and symptoms
- Back in class, put learners in groups depending on the size of the class and the abilities of class members to harmonize their findings. Let them choose a group leader to do a presentation on their behalf.

- After the presentations, highlight the main points as learners come up with summary notes.

### Synthesis

This lesson is about creating awareness about HIV and AIDS and preventing its spread. As you may be aware, HIV and AIDS is a major concern by various governments in the world including Rwanda. As a result, measures have been put in place to prevent and control its spread. Guide learners to discover by way of research and watching the video, the causes, mode of transmission and signs and symptoms of the disease. They should at the end appreciate the need to prevent/control this disease as a way of living healthy life.

### Lesson assessment

Assess whether the learning objectives of the lesson were met by asking questions such as:

1. What do HIV and AIDS stand for?  
(Ans: H - human, I - Immunodeficiency, V - Virus; A - Acquired, I - Immune, D - Deficiency, S - Syndrome.)
2. What causes AIDS? (Ans: HIV)
3. What are opportunistic infections?  
(Ans: Diseases that take advantage of weakened immune system to attack the body)

## Lesson 10: Prevention and treatment of HIV and AIDS and living positively with HIV and AIDS patients

Refer to learner's book pages 263

### Specific objectives

By the end of the lesson, learners should be able to:

- Explain available treatment for HIV and AIDS and how to prevent it.
- State how to live positively with HIV and AIDS patients.

### Preparation for the lesson

1. This lesson will involve a research activity either in the library or using the Internet and group work.
2. Bring pamphlets, handouts, and textbooks for reference in class. Also, ensure that the Internet is working if you have a computer laboratory or any other form of Internet connectivity such as WIFI or modem.

## Teaching aids

Reference materials on HIV and AIDS – may include textbooks, magazines, handouts and pamphlets.

## Pre-requisite of the lesson

- Introduce the lesson by reminding learners about what they learnt on prevention and control of STIs. Let them list the methods in their notebooks.
- Remind learners that HIV and AIDS is an example of an STI. Seek their opinion about whether they think HIV and AIDS can be controlled in a similar way.

## Teaching / learning activities

*Find out (Refer to Pupil's book page 262)*

- Let learners go to the library and search in textbooks, magazines, pamphlets and handouts or the Internet, how HIV and AIDS can be controlled or prevented. They should also find out whether HIV and AIDS can be treated, if so, using which drugs?
- Highlight the main points as learners come up with summary notes. Refer to Pupil's book pages 262-263. Emphasize the fact that ARVs are

used to reduce SEVERITY of the disease by boosting immunity and reducing the viral load as opposed to treating the disease.

- Back in class, put learners in groups depending on the size of the class and the abilities of class members. Let them discuss how to live positively with people living with HIV and AIDS. They should also discuss the challenges that HIV positive people or their relatives go through. Let them choose a group member to harmonize their points and do a presentation to the rest of the class.
- Highlight the main points as learners come up with summary notes.
- This topic was mainly about good sexual behaviour and proper decision-making. Wrap up the topic by learners dramatizing on this as explained in this activity.

**REMEMBER:** Emphasize the necessity to avoid HIV and AIDS infection as a cross-cutting issue under reproductive health and comprehensive sexuality education. Also, bring to the attention of learners the fact that ARVs are



nowadays available to reduce the severity of the disease. Equally important is - discrimination of people living with HIV and AIDS should strongly be condemned.

### Synthesis

This lesson is about creating awareness about prevention of HIV and AIDS. As mentioned earlier, HIV and AIDS is a major concern by various governments in the world including Rwanda. As a result, measures have been put in place to prevent and control its spread. Guide learners to discover by way of research, the various methods to use to prevent the spread of HIV and AIDS. They should at the end appreciate the need to prevent/control this disease as a way of living healthy life.

### Lesson assessment

Assess whether the learning objectives of the lesson were met by asking questions such as:

1. Write ARV in full? (Ans: Anti-Retro-Virus)
2. How can you avoid HIV and AIDS? (Ans: Refer to pupil's book page 263)

3. Explain why drug abuse increases the chance of getting HIV and AIDS. (Ans: It compromises the persons' ability to think straight hence the person may engage in irresponsible sexual behaviour)
4. How would you handle a person living with HIV and AIDS? (Ans: Taking good care of them, helping them get medical attention if need be, showing them love, assisting them to take ARVs, etc)

### Answers to Self-Test 13.1

Refer to learner's book pages 256

1. Seminal vesicles

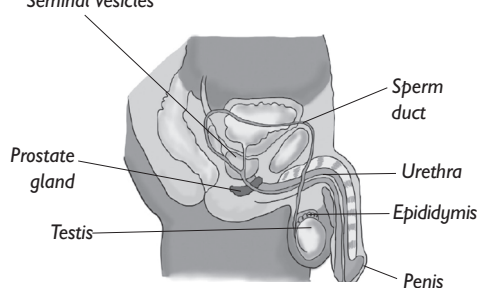

2. Labia mijora, labia minora, Bartholin's gland, clitoris and vulva.

- 3.

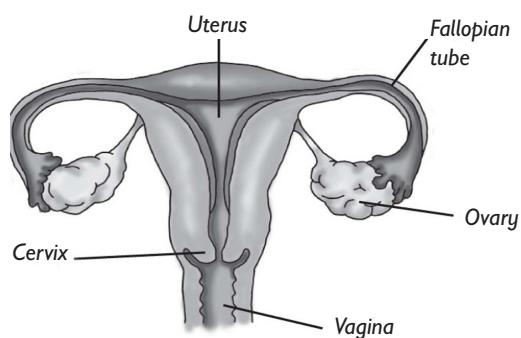

- 4.

## Summary of the unit

This unit deals with two major areas: the organs of the reproductive system and sexually transmitted infections and pregnancy. You should effectively use the suggested activities and the teaching approaches in the teacher's book to help learners acquire the competence on parts that make up male and female genitals and their functions.

Further, the suggested activities and videos should help you drive home the risks and dangers associated with early pregnancy and sexually transmitted diseases including HIV and AIDS and the necessity to stay safe. Emphasise the need for learners to behave responsibly in order to avoid these diseases and pregnancy in general. At the end of the lessons, you should assess the extent to which the competencies have been achieved and attitude change towards responsible behaviour. Plan remedial activities where necessary. **REMEMBER**, one of the attitudes and values intended at the end of the topic is for learners to develop the habit of taking good care of themselves and avoiding reckless and irresponsible behaviour.

## Additional information for the teacher

Some information that may be relevant

with regards to the reproductive system are given below.

## Importance of reproduction

- Reproduction ensures continuity of individual members of a species.
- It results in the perpetuation of life on earth and increase in populations of living organisms.
- Good and desirable traits are also maintained through reproduction.

## Reproduction in human beings

Human beings like all other mammals carry out internal fertilisation where the male and female gametes meet and fuse inside the body of the female to form a **zygote**, which then later develops into an **embryo**. The embryo further develops into **foetus**, which completes its development within the womb into a baby. The baby is then born in a process called **parturition**. After giving birth, the female parent nurtures the young one with milk produced from the mammary glands. Human beings have complex and elaborate reproductive system. The reproductive system involves the male and female genitals as have been taught. These organs are specialized to produce respective gametes, transfer and receive them for fertilization to occur.

## The sperm

This is the male reproductive cell (male gamete). The sperm has an oval head with large nucleus and a long whip-like tail for swimming. (See the figure below)

Fig. 13.1 A sperm cell

A sperm has a long whip-like tail used for propulsion (swimming). Sperms are produced in large numbers to increase their chances of survival. The large number of mitochondria located at the neck region provide enough energy needed for propulsion. The large

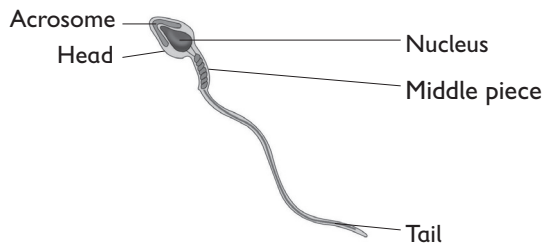

nucleus helps the sperm cell to carry a lot of genetic information. The lytic enzymes in the acrosome digest the egg membrane to facilitate fertilisation.

## The ovum

The human ovum is a large cell of about 0.1mm in diameter. The outer membrane known as vitelline membrane encloses the plasma membrane, which surrounds the yolk containing cytoplasm. Right at the centre of the ovum is a nucleus encircled by a nuclear membrane.

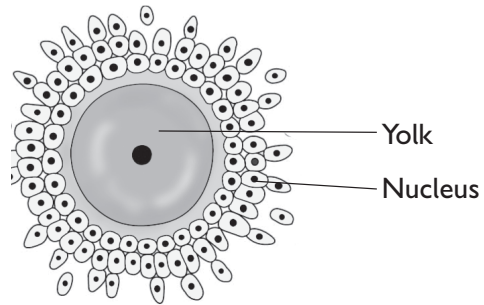

Fig.13.2 A mature ovum

## Role of hormones in reproduction in human beings

Hormones are chemicals secreted by special glands in the body called **endocrine glands**. These hormones are transported via the bloodstream to specific organs called target organs. The hormones cause specific effects in the target organs, which regulate or coordinate various body activities. Hormones that influence sexually related changes in the body are called **sex hormones**. Hormones control the entire process of reproduction from the development of the reproductive features at puberty to pregnancy and birth. Hormones also control the shedding of the (lining of the uterus) endometrium every month i.e. menstruation.

### (a) Females

In girls, follicle stimulating hormone (**FSH**) stimulates the ovaries to produce **oestrogen** and **progesterone**.

Oestrogen is responsible for the development of the female secondary sexual characteristics. The ovaries start producing ova and this leads to the first menstruation also known as **menarche**. At first, it is irregular and unpredictable. Within a year the hormone levels increase and monthly menstruation periods become more regular. In some people, pains may be experienced due to the progesterone hormone, which causes the uterine muscles to contract. These are commonly known as **muscle cramps**. Oestrogen hormone also triggers Graafian follicle to develop and mature. This brings about release of ovum under the influence of **Luteinising Hormone (LH)**, in a process called **ovulation**.

### **Menstruation**

Menstruation is the discharge of uterine tissue lining and blood through the vagina in females. Menstruation only takes place when fertilisation does not occur. All these events are under the influence of hormones. These events are cyclic which means that the whole sequence repeats itself once every month in what is called the **menstrual cycle**. During this cycle, the uterus is prepared for implantation. If fertilisation does not occur, the new uterus lining and the ovum are discharged from the uterus.

The average length of the menstrual cycle is 28 days. It can however be as short as 24 days or as long as 35 days. The first day of the menstrual period can be regarded as day 1 of the menstrual cycle. During this time, the endometrium is shed from the uterus through the cervix and vagina together with some blood.

### **(b) Males**

At puberty, the human male pituitary gland in the brain secretes follicle stimulating hormone (**FSH**) and luteinising hormone (**LH**), FSH stimulates the production of sperms from the germinal epithelium while LH brings about secretion of **testosterone** hormone by interstitial cells. In boys, the interstitial cell-stimulating hormone is taken to the interstitial cells in the testes. It stimulates these cells to secrete testosterone, which is responsible for the development of the male secondary sexual characteristics.

### **Fertilisation**

Fertilisation in human being takes place in the oviduct. Once the sperms are ejaculated from the penis into the vagina, they swim and are also propelled through the cervix, uterus and into the oviducts where they may meet an ovum. This normally occurs in the upper part

of the oviduct. There are about 50 to 200 million sperms in a single ejaculation, although only one sperm fertilises an ovum.

When the sperms and an ovum meet, the head of a sperm sticks onto the ovum. The action of the sperm causes the follicle cells surrounding the egg to disperse. Eventually, the nucleus of one sperm passes into the cytoplasm of the ovum along with the head and middle piece leaving the tail outside. The sperm nucleus **fuses** with the nucleus of the ovum. This fusion of the sperm and ovum nuclei is known as **fertilisation**. The egg membrane changes its structure after one sperm penetrates to prevent other sperms from entering the ovum. The fertilised ovum is called a **zygote**.

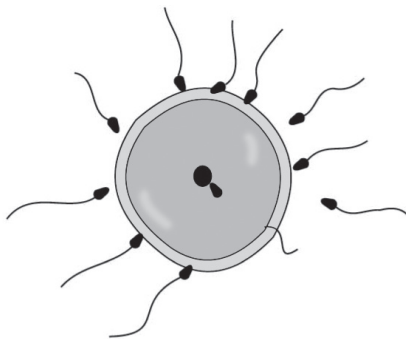

Fig. 13.3 The process of fertilisation

### Implantation

Implantation is the process by which the zygote becomes embedded onto the uterus walls. After fertilisation, a zygote is formed. The zygote moves down the

oviduct. Movement of the zygote is aided by the beating of cilia found on the oviduct. As it moves down the oviduct, it undergoes a series of cell divisions to form a hollow mass of cells known as the **blastocyst**. It develops fingerlike projections called **villi** which attach it to the endometrium of the uterus. It is then referred to as an **embryo**.

### Development of the embryo

The period within which the embryo grows and develops into a fully grown baby is known as **gestation period**. In humans, gestation period lasts for 38–40 weeks (9 months). The cells of the embryo continue to divide and grow, until they become organised into all the different body organs. When this is completed the embryo is known as **foetus**.

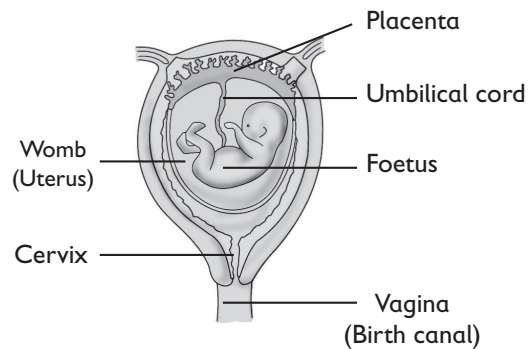

Fig. 13.4 Development of the embryo

The fetus further develops into a full-grown baby which is born at the end of the 9 months.

## Healthy pregnancy

For a baby to be healthy and be born safely, the mother has to take care of herself well during the period of pregnancy. The care given during gestation period is called **prenatal** or **antenatal care**. A pregnant woman should ensure that;

- She eats a well balanced diet and may incorporate more iron and folic acid foods to prevent anaemia. Poor nutrition affects development of the foetus.
- She does not take any drugs unless they are prescribed by a doctor and are necessary.
- She does light exercises but avoids doing heavy work and lifting heavy loads.
- She avoids taking harmful substances that could harm the baby. She should not drink or smoke since smoking may cause miscarriage and reduce the baby's birth weight. Heavy drinking could also damage the brain of the baby.
- She wears comfortable flat-heeled shoes to avoid falling.
- She attends antenatal clinics where she is given medical advice and gets vaccinated for example, an anti-tetanus vaccine and German measles if at risk of containing the infection.

The mother should ensure that she goes to a **health facility** to give birth for safe delivery and avoid complications that might harm the baby. If any complication arises during birth, it is easier for health practitioners like a nurse or doctor to identify and deal with them.

## Child Birth

In the last stages of pregnancy before a baby is born, it normally turns upside down with its head just above the cervix. Progesterone hormone levels in the mothers blood drops. This stimulates the pituitary gland to release another hormone called **oxytocin**. Oxytocin flows in the blood to the uterus where it stimulates the muscles of the uterine wall to contract. The waves of contraction of these muscles results to pain commonly called **labour pain**. The amnion ruptures and the amniotic fluid passes out through the vagina (also known as **birth canal**). The uterine contractions become stronger and more frequent and the cervix dilates to let the baby's head pass through. The foetus is pushed downwards through the cervix into the birth canal. The birth canal is elastic and it widens allowing the baby to be born as the mother pushes. After birth, the umbilical cord is cut followed release of the placenta.

**Answers to Unit Test 13** (Pupil's book page 265)

1. For procreation thereby guaranteeing continuity of species.
2. (a) Refer to Fig. 13.2 on page 255 of pupil's book.  
(b) Refer to Fig. 13.4 on page 259 of pupil's book.
3. Testicle, ovary.
4. Sperms, urine.
5. (a) Womb  
(b) Fallopian tube  
(c) Birth canal
6. Refer to pupil's book pages 299-300
7. (a) Seminal vesicle (b) prostate gland (c) sperm duct (d) urethra  
(e) Epididymis (f) Penis  
(g) Testis (h) Scrotum
8. C
9. C
10. Provide medical care when needed, show him or her love and affection, keep them clean all the time, ensure they take balanced diet, give them ARVs, comfort them.
11. Missing periods, mood swing, frequent urination, white discharge from vagina, spotting, nausea and frequent urination.
12. Refer to content on page 284-285 pupil's book.

13. Because it is risky and dangerous.

14.

Disease	Cause	Prevention
Candidiasis	Fungi	Avoiding sexual intercourse or using a condom
Syphilis	Bacteria	Avoiding sexual intercourse or using a condom
Chancroid	Bacteria	Avoiding sexual intercourse or using a condom

15. (i) – (c); (ii) – (d); (iii) – (b); (iv) – (a)
16. D
17. D
18. Assess learners as they dramatise a boy seducing a girl. The girl refuses, goes on with her education and excels in exams. The girl eventually goes to university, studies medicine (or any other profession) and is proud of what she is together with her family members.

### Additional activities to cater for slow and gifted learners

Remedial activities for slow learners	Extended activities for gifted and talented learners
<ol style="list-style-type: none"> <li>1. Helping the teacher to collect pamphlets, newspaper cuttings, magazines and handouts on various topics on reproductive system and reproduction in general.</li> <li>2. Help with labeling of parts of drawn charts.</li> <li>3. Acting during role-plays.</li> <li>4. Reading group reports to group/class members.</li> <li>5. To be given homework on content areas taught.</li> </ol>	<ol style="list-style-type: none"> <li>1. Reading the pamphlets, newspaper cuttings, magazines and handouts and summarizing the information.</li> <li>2. Helping the teacher to come up with improvised charts with various painted drawings on parts of male and female genitalia.</li> <li>3. Coming up with scripts to dramatize during role-play.</li> <li>4. Compiling group reports and doing presentations.</li> <li>5. To be given research work on the various content areas learnt. For example, the role of hormones in reproduction, how ova and sperms are manufactured, the process of fertilization and embryo development, etc.</li> </ol>
Remedial questions for slow learners	Extended questions for gifted learners
<ol style="list-style-type: none"> <li>1. Name the parts that make up external male genitalia.</li> <li>2. Why do we say early pregnancy is unwanted?</li> <li>3. Which of these parts act as a pathway for sperms? (sperm duct, epididymis)</li> <li>4. Name the parts shown in the diagram below.</li> </ol>	<ol style="list-style-type: none"> <li>1. Relate the structure of the male reproductive system to its functions.</li> <li>2. Compare and contrast vasectomy and tube ligation.</li> <li>3. Using diagrams show the difference between external male and female genitalia.</li> <li>4. Demonstrate how you would use a male condom.</li> </ol>



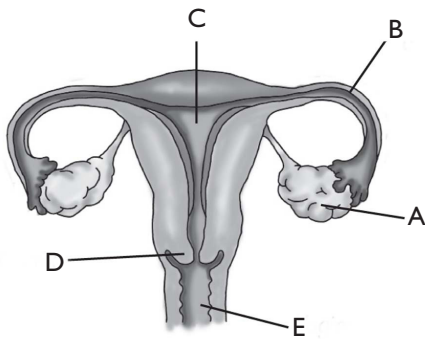

5. Which of these is not a contraceptive? (Vasectomy, coil, pill)
6. Is abortion bad or good? Why?
7. Name any three sexually transmitted diseases that you know.

5. Given a choice between use of a female condom and pill, which one would you go for? Why?
6. Taking care of HIV and AIDS patients is not a choice. Explain this statement.

#### Answers to remedial questions

1. Penis, scrotum, testicles.
2. Because it happens before recommended time and causes problems to the girl who in most cases is supposed to be going to school.
3. Sperm duct
4. (A) Ovary (B) Fallopian tube (C) Uterus (D) Cervix (E) Vagina
5. Vasectomy
6. Bad – it may lead to death or cause permanent health complications.
7. Gonorrhoea, syphilis, chancroid, candidiasis.

#### Answers to extended questions

1. Refer to the adaptations to functions of the various of the male genitalia as explained in pupil's book pages 255.
2. **Similarities** – they all work work by blocking the union between sperms and ova. In both cases, the tube involved is either tied or cut. **Differences** – vasectomy is done in males, tube ligation is done in females. Vasectomy is done on the sperm duct, tube ligation is done on the oviduct.
3. Let learners follow the steps as highlighted in Activity 13.8 pages 266 of pupil's book.

	<ol style="list-style-type: none"><li>5. Condoms. They are 98% effective compared to pills which are 92% effective.</li><li>6. In Rwanda it is a criminal offence to discriminate against HIV and AIDS patients. Everybody has a responsibility of taking good care of the patients and giving them support where required.</li></ol>
--	---

**Refer to the Learner's Book pages 267-292**

## Key unit competency

After studying this unit, learners should be able to understand the use of energy and its transformations from one form to another.

## Learning objectives

Competency based curriculum embraces three categories of learning objectives,

that is, knowledge and understanding, skills acquisition and attitude and values.

At the end of the unit, learners should have knowledge and understanding of energy management systems and have the right attitude towards conserving energy.

**Table 14.1 Knowledge, skills and values to be attained**

Knowledge and understanding	Skills	Attitudes and values
<p>By the end of this unit, learners should be able to:</p> <ul style="list-style-type: none"> <li><input type="checkbox"/> Define the concept of energy.</li> <li><input type="checkbox"/> List the forms of energy.</li> <li><input type="checkbox"/> Explain ways of energy transformations/ conversions.</li> <li><input type="checkbox"/> Explain the importance of energy.</li> </ul>	<p>By the end of this unit, learners should be able to:</p> <ul style="list-style-type: none"> <li><input type="checkbox"/> Make relevant choice of the best form of energy to use.</li> <li><input type="checkbox"/> Perform basic experiments related to energy transformations.</li> </ul>	<p>By the end of this unit, learners should be able to:</p> <ul style="list-style-type: none"> <li><input type="checkbox"/> To develop an awareness of the wise use of energy.</li> <li><input type="checkbox"/> To show concern about the consequences of the use of particular source of energy to the environment.</li> </ul>

<ul style="list-style-type: none"> <li><input type="checkbox"/> Identify the main sources of energies.</li> <li><input type="checkbox"/> Identify and explain renewable energies and state some examples.</li> <li><input type="checkbox"/> Describe the components of a biogas and solar power installations.</li> <li><input type="checkbox"/> Explain advantages of using renewable energy.</li> </ul>	<ul style="list-style-type: none"> <li><input type="checkbox"/> To represent in a diagram the transformation of energy in different forms.</li> <li><input type="checkbox"/> To maintain basic solar and biogas energy installations.</li> </ul>	<ul style="list-style-type: none"> <li><input type="checkbox"/> To do advocacy of the use of renewable energy.</li> <li><input type="checkbox"/> Be aware of the existence of renewable energy resources.</li> <li><input type="checkbox"/> Develop positive attitude towards solar power and biogas.</li> </ul>
---	--	--

### Pre-requisite of this unit

Under energy management learners will be taught about what energy is, the various forms of energy, its importance and the various energy transformations in our daily lives. Remember learners have already tackled some aspects of energy in primary 5. For example, they learnt about light, its properties and electricity as a form of energy. Borrow on the pupils' experiences in these areas to introduce the concepts in this topic. Also during the lessons, strive to bring to the awareness of learners the fact that this topic is related to forms of energy in Physics. Let learners understand that at this level, they may only need the basic information otherwise; details of energy generation and usage are taught in Physics in more details.

### Background information

This topic mainly deals with the various forms of energy, their sources and the various transformations that they undergo. Emphasize the fact that at this level, learners will be restricted to mechanical, chemical, thermal, electrical, electromagnetic and elastic forms of energy. Learners should be made aware of the sources of these forms of energy and how to convert from one form to another. Finally, the unit winds up by emphasizing the various renewable sources of energy and how to install and maintain solar and biogas plants.

### Cross-cutting issues to be addressed

#### 1. Gender education

Both boys and girls can assemble

biogas digester and a solar facility. It is not a preserve of the boy gender. Also, emphasize to learners that anybody irrespective of their gender can pursue a career in engineering and energy conservation specialist. Give examples of role models who are successful engineers in the area where the learners come from.

## 2. Standardization culture

Emphasize the need to use certified energy equipment. Caution learners against using counterfeits which may lead to accidents or injury of users.

## 3. Inclusive education

All learners should be encouraged to participate during lessons and practicals. Special arrangement should be made to take care of learners with special needs. For example, provide brail for blind learners, large print text for those with sight problems and allocate physically challenged learners to others to assist them during field trips and practical activities. Further, this category should be given tasks that they can manage during the practical sessions.

## 4. Financial education

Learners should be made aware of the fact that they need to save energy. This they can do by switching off energy utilizing equipment when not in use. Also, buying quality equipment will lead to saving money in the long run as they stay for long and costs on repair are reduced.

## 5. Environment and sustainability education

Bring to the attention of learners the fact that some of the devices in this unit such as broken bulbs, used dry cells, spoilt car batteries, solar panels and generators are environmental hazards. They should appropriately be disposed of including some being taken for recycling.

## Generic competences

### 1. Co-operation and interpersonal management and life skills

During group discussions and pair-work let learners engage one another by giving a chance for all to participate. Also, during group presentations, you can allow rotational presentations within the group members. Gifted learners should help in coming up with presentation content as slow learners contribute. **REMEMBER** You should allow slow learners to do presentations as well and correct them where they go wrong. Advise learners to appreciate the different abilities of their group members and accommodate each other's views.

### 2. Research skills

Guide learners on how to find information regarding various topics such as the meaning of energy transformation, renewable energy and non-renewable energy. Guide learners on how to come up with summarized notes from a large body of text. You should also guide learners on doing Internet searches

for the various content areas they are looking for.

### 3. Communication in English

Communication in English will be improved when learners freely participate in the discussions and presentations. Encourage all learners irrespective of their abilities to participate in-group discussions, during presentations by asking questions and during question and answer sessions to either introduce or wrap up the lessons.

### 4. Critical thinking and problem solving skills

This competence will be developed by learners as they answer the probing questions such as those on page 281 at the beginning of this unit and as they discuss the results of the various practical activities. Guide learners to discover for themselves the various energy transformations that occur in various instances, for example, when we eat food, when we fuel a vehicle and start the engine, when we connect an electric circuit, etc. This competence will also come about as learners think about their findings in the activities and as they give out their suggestions on why this is the case.

### 5. Lifelong skills

Knowing how to handle the various sources of energy without incurring energy losses will help in conserving energy and by extension,

reducing unnecessary expenses on maintenance and repair of the various energy equipment learners will be using throughout their lives. Further, knowledge of working and maintenance of biogas and solar panel plants will help in provision of energy in future. Also, make learners aware that they can become engineers of energy utilizing or generating devices if they take this topic seriously.

### Key words in this unit and their meanings

- **Biofuel** – a gaseous, liquid, or solid substance of biological origin that is used as a fuel.
- **Biogas** – a gas, mainly methane that is produced by the action of bacteria on organic waste matter often used as a fuel.
- **Conduction** – The process by which heat moves through solids.
- **Convection** – The process by which heat travels through liquids.
- **Crude oil** – A term often used to refer to unrefined petroleum. It is a mixture of diesel, petrol, kerosene, bitumen among others.
- **Current electricity** – Electricity in motion or a form of electricity found in things like dry cells, car batteries, hydro-power, generators among others.

- **Electrical appliance** – any device that uses current electricity.
- **Energy** – Capacity to do work.
- **Energy transformation** – Changing energy from one form to another.
- **Non-renewable energy** – these refer to sources of energy that can get exhausted.
- **Nuclear energy** – Form of energy which is as a result of nuclear reaction such as fission or fusion.
- **Photosynthesis** – The process by which green plants make their own food using energy from the sun.
- **Radiation** – The process by which heat travels through a vacuum.
- **Renewable energy** – these refer to sources of energy that cannot get finished or exhausted. They can either be recycled or re-used. Examples include solar energy biofuels, hydro-power or geothermal power.
- **Solar panel** – a piece of equipment, usually installed on a roof, that absorbs energy from the sun to heat water or turn it into electricity.
- **Static electricity** – an electrical

charge, often created by friction, consisting of stationary ions that do not move. It is the opposite of current electricity.

- **Windmill** – a piece of equipment that extracts usable energy from winds.

### **Guidance on the problem statement**

In this unit, you will teach about the various forms of energy, their sources, energy transformations and renewable and non-renewable energy sources. As a way of introducing these concepts, of pupil's book page 267. It shows children using a tin lamp to study. The light is not sufficient and it is producing a lot of smoke. The children are not aware that there are other sources of light like solar and biogas that give clean light and can easily be installed anywhere in the country. Let them brainstorm and give alternative energy as a solution to the problem situation in the picture.

## Attention to special educational needs

Support for Multi-ability learning	Support for special needs learning
<ul style="list-style-type: none"><li>– Gifted learners can assemble the various equipment during practical activities as slow ones make observations and take notes.</li><li>– Both gifted and slow learners to be given equal opportunity to lead in group discussions and to do presentations of group findings to the rest of the class.</li><li>– Ensure all learners respect other's views irrespective of their shortcomings or talents.</li></ul>	<ul style="list-style-type: none"><li>– Allocate gifted learners to help fellow learners with special needs.</li><li>– Provide brail for blind learners and large print text to learners with seeing difficulties. Provide sign language alphabet symbols and sign language interpreters for the deaf.</li><li>– Also, arrange learners such that shortsighted ones are at the front and long-sighted ones are at the back. Spectacles can as well be provided if available.</li></ul>

## List of lessons

Lesson No.	Lesson title	No. of periods
1.	Meaning and importance of energy	1
2.	Forms of energy	1
3.	Energy transformations	5
4.	Sources of energy	1
5.	Renewable sources of energy: Solar energy	2
6.	Renewable sources of energy: Biogas	2



## Lesson 1: Meaning and importance of energy

Refer to learner's book pages 267

### Specific objectives

By the end of the lesson, learners should be able to:

- Define the term energy.
- Explain the importance of energy.
- List the various forms of energy.

### Preparation for the lesson

- This lesson will involve individual research work and group discussions. You will therefore organize the class as need arises during the lesson. **REMEMBER:** When grouping learners, you should consider the different abilities of learners and the special needs for various individuals.
- Ensure the internet is working properly before the lesson for learners to use to do research.

### Teaching Aids

- Computers connected to the Internet.
- The diagram on page 267 of Pupil's Book.

### Pre-requisite of the lesson

Introduce the unit as explained under **guidance on the problem statement**

above then narrow down to this lesson.

### Teaching / learning activities

- You may begin the lesson by asking learners probing questions such as: have you ever heard of the word 'energy'? What does it mean?

### Find out (Refer to Pupil's book page 267)

- This is a research activity to be done by individual learners. Let learners go to the library to read textbooks on the meaning of energy, its various forms and its importance. (**Remember** – In this lesson, you will only concentrate on the meaning and importance of energy). They can also visit sites where they can get this information. For example: <http://www.scholar.google.com> or by simply searching the phrase 'meaning of energy' using google search engine.
- Guide learners to discover the definition of energy, which is 'the ability to do work. (You may need to stress the fact that without energy, nothing will go on the surface of the Earth).
- Emphasise the fact that for work to be done, effort must be applied. This effort is the energy that is required to do work.

This is a research activity to be done by individual learners as well. Let learners

go to the library to read textbooks on the importance of energy. Guide them to answer the questions in this activity.

### Answers to questions:

1. To gain energy to do work and to sustain body functions.
  2. The vehicle will not move.
  3. Plants will not be able to manufacture food.
  4. From various sources such as hydro, geothermal, generators, batteries (dry cells among others).
- Help learners to relate the answers to the above questions to uses or importance of energy in our lives.
  - Let them give examples where various forms of energy are used.
  - Wind the lesson by letting learners carry out a discussion activity on the importance of using energy to the economy of Rwanda.

### Synthesis

This lesson introduces learners to the concept of energy. Learners should discover what the term means and the important role energy plays in our lives.

### Lesson assessment

Assess whether the learning objectives of the lesson was met by asking questions

such as:

1. What is energy?  
(Ans: Ability to do work).
2. Of what significance is energy in our lives?  
(Ans: Refer to pupil's book page 319).

## Lesson 2: Forms of energy

Refer to learner's book pages 268

### Specific objectives

By the end of the lesson, learners should be able to list and describe the various forms of energy.

### Preparation for the lesson

1. This lesson will involve individual research work, pair work and group activities. You will therefore organise the class as need arises during the lesson. **REMEMBER:** When grouping learners, you should consider the different abilities of learners and the special needs for various individuals.
2. Look for textbooks, handouts, pamphlets and other materials on forms of energy.
3. Ensure the Internet is working properly before the lesson for

learners to use to do research.

### Teaching aids

- Electric heater, matches and match boxes, kerosene/charcoal stove, sources of fuels such as firewood, charcoal, kerosene, etc; pen or comb, pieces of paper, file, iron bar, rubber bands, etc.
- Textbooks, handouts and pamphlets on forms of energy.
- Computers connected to the Internet.

### Improvisations:

Old bicycle or car tubes can be cut to obtain rubber sheets for making catapult to demonstrate elastic energy.

### Pre-requisite of the lesson

- You may remind learners about the research that they conducted in lesson 1 above. From the research, let them come up with a list of forms of energies. Their list should include chemical, mechanical, thermal, electrical, magnetic and elastic energies.
- Let learners know that they are now going to conduct various activities to help them understand the various forms of energies further.

### Teaching / learning activities

#### (a) Chemical energy

#### Activity 14.1 (Refer to Pupil's book page 267)

- Guide learners to conduct the

activity above. At the end of the activity, they should compare the cooked and uncooked potatoes.

- Let learners answer the probing questions in this activity. Answers: Cooked potato is softer. The heat from the fire made the potato softer.
- Guide the learners to understand the relationship between energy in fuels ( kerosene, charcoal and firewood) and the cooking action i.e. the chemical energy stored in the fuels provides the energy used during cooking.
- Emphasise the fact that similar thing happens in our bodies where stored energy in foods is used to help us do various activities. The same applies to store energies in batteries and dry cells.
- Wrap up the section by asking learners to name other things that contain chemical energy.

#### (b) Heat energy

#### Activity 14.3 (Refer to Pupil's book page 269)

- Ask learners to name some sources of heat that they know. They can also say what the heat is used for.
- Guide learners to conduct the activity above. At the end of the

activity, they should feel the source of warmth in their hands and rubbed surfaces.

- Let learners understand that whenever two surfaces are rubbed, heat energy is produced. The heat energy causes the feeling of warmth.
- You may wrap up the section by explaining the difference between conduction, convection and radiation. Refer to pupil's book page 302.

### (c) *Electrical energy*

#### **Activity 14.4 (Refer to Pupil's book page 270)**

- Let learners observe the items in the pictures.
  - You may also bring some of these things to class. Ask learners to name the things and say what they are used for. Ask them to say the common denominator about the things – which is 'they all use electricity'.
  - You can then challenge learners to say what electricity is. Let them do simple research on this.
  - Tell them that electricity is actually electrical energy, which is as a result of movement of current.
  - At this point, you can mention static and current electricity and explain the difference between the two.
- Guide learners to conduct the activity above. At the end of the activity, they should conclude that the comb or the biro pen case are able to pick the pieces of paper due to static electricity that is induced during rubbing.
  - You may wrap up the section by asking learners to come up with a list of uses of electricity in our homes.

### (d) *Electromagnetic energy*

#### **Activity 14.5 (Refer to Pupil's book page 271)**

- Let learners observe the items in the picture.
- You may also bring some of the magnets to class. Ask learners whether they have seen those things. Some may say 'yes' while others 'no'. Take advantage of the yes group and ask what learners think they are used for.
- At this point, you can introduce the concept of magnetic force and magnetism as a form of energy. **REMEMBER** – This topic will exhaustively be covered in Unit 15 so do NOT delve into much details at this point.

### (e) *Mechanical energy*

- Begin this section by asking learners whether they think energy can be in motion. Ask them to say what happens when water is poured from a container.
- Take advantage of their discussions and introduce the concept of kinetic or mechanical energy in motion.

### Activity 14.6 (Refer to Pupil's book page 271)

- Guide learners to conduct the activity above. At the end of the activity, they should conclude that the heat is produced during rubbing because of mechanical energy (movement back and forth). The same thing happens when rubbing a matchstick on matchbox and this causes fire.

#### (f) Elastic energy

### Activity 14.7 (Refer to Pupil's book page 272)

- Ask learners whether they know the thing in the diagram (**Ans:** Catapult). Ask them to say what it is or it can be used for and why.
- You can then let them make their own catapult and play with it (use it to throw stones). Ask them to also throw stones using their hands.
- Learners should then compare which is more effecting at throwing a stone (catapult or bare hands?)
- Take advantage of their discussions and introduce the concept of elastic energy which is the energy stored in things that stretch such as rubber bands.
- You could also give learners other examples of elastic materials such as springs

- Summarise the lesson by highlighting the various forms of energy. 8. Let learners come up with a list.

### Synthesis

Using the various activities in the pupil's book, let learners discover the differences between the various forms of energy and come up with a list at the end of the lesson.

### Lesson assessment

Assess whether the learning objectives of the lesson were met by asking questions such as:

1. Which forms of energy do you know?  
(Ans: chemical, mechanical, thermal (heat), electrical, electromagnetic and elastic energies).
2. A catapult has \_\_\_\_\_ form of energy. (Ans: Elastic)
3. What causes heat when two objects are rubbed together?  
(Ans: Mechanical energy)
4. Distinguish between current and static electricity.  
(Ans: Current is electricity in motion, static is electricity caused by creation of charges)
5. Energy in motion apart from being mechanical, can also be known as \_\_\_\_\_.  
(Ans: Kinetic energy)

## Lesson 3: Energy transformations

(To be covered in five periods)

Refer to learner's book pages 273

### Specific objectives

By the end of the lesson, learners should be able to explain the various ways through which energy transformations can occur.

### Preparation for the lesson

1. This lesson will involve pair work or group activities. You will therefore organize the class as need arises during the lesson. **REMEMBER:** When grouping learners, you should consider the different abilities of learners and the special needs for various individuals.
2. Look for textbooks, handouts, pamphlets and other materials on energy transformations.
3. Ensure the Internet is working properly before the lesson for learners to use to do research.

### Teaching aids

- Torch, dry cells, matches and match boxes, pen or comb, pieces of paper, file, metal bar, rubber bands, bulb, switch, kettle, turbines, etc.

- Computers connected to the Internet.

### Improvisation

- Old bicycle or car tubes can be cut to obtain rubber sheets for making catapult to demonstrate elastic energy.
- Using a lemon instead of dry cells to demonstrate electric current generation (See figure in Question 2 Self-test 14.2 page 281 of pupils book)

### Pre-requisite of the lesson

- You may remind learners about what they learnt in the previous lesson on forms of energy. Ask Questions such as: (i) What forms of energy do you know? (Ans: Chemical, heat, mechanical, electrical, elastic, etc).
- Ask learners whether they think the various forms of energy are inter-convertible and give examples.
- At this point, you can introduce the concept of energy transformation as the conversion from one form of energy to another.

### Teaching / learning activities

#### Activity 14.8 (Refer to Pupil's book pages 273)

- Provide learners with the materials in these activity. Let them try the various activities out.
- Guide learners to give an explanation of what happened in every activity above. Emphasize the fact that

energy can NEVER be created but can only be transformed from one form to another.

### ***Conversion from mechanical to heat energy***

#### **Activity 14.9 (Refer to Pupil's book page 274)**

- Let learners carry out the various activities. In either case, they will feel some warmth.
- Guide learners to understand that the warmth is because of conversion of mechanical energy (rubbing) to heat (thermal) energy which causes the warmth feeling.
- Allow learners to brainstorm of other cases where this kind of transformation occurs. They should come up with a list and share with other class members.

### ***Conversion from mechanical to electrical energy***

#### **Activity 14.10 (Refer to Pupil's book 274 )**

Let learners carry out this activity individually.

- Guide learners to understand that the attraction is because of conversion of mechanical energy (rubbing) to static electricity which is a form of electrical energy.
- You can then take this opportunity to clarify the difference between static and current electricity. Give learners a chance to explain the difference based on previous lesson.

- Allow learners to brainstorm of other cases involving transformation from mechanical to current electricity.
- At this point, ask them whether they know how electricity that they use at home is generated.
- Inform them that in Rwanda, electricity mainly comes from hydro-power generation plants such as WASAC. Plan for a visit to this facility or any nearby power generation facility
- Let learners understand that in such plants, there is conversion of mechanical energy ( in the rotating turbines by water) to electrical energy.
- Allow learners to brainstorm of other cases where this kind of transformation occurs. They should come up with a list and share with other class members. The list should include windmills and geothermal power

### ***Conversion from chemical to heat energy***

- In this section, you will refer to Activity 14.11 on page 275 where potatoes were cooked using burning charcoal or kerosene.
- Ask learners where the heat that was used to cook the potatoes came from. The answer should be 'from chemical energy stored in the fuel'.

- Guide learners to understand that the energy transformation that takes place here is chemical to heat.
- Allow learners to brainstorm of other cases where this kind of transformation occurs. They should come up with a list and share with other class members. The list should include the food that we eat which is burnt down to release heat which maintains our body temperatures constant.
- Let learners study the figure. You can also take them to a nearby solar electricity installation.
- Let learners discuss the questions in this activity. It is a case where solar energy is used to provide electricity in a house.
- Guide learners to understand that the energy transformation that takes place here is solar to electrical.

### ***Conversion from chemical to electrical energy***

#### **Activity 14.12 (Refer to Pupil's book pages 276)**

- Let learners assemble the things as shown in this activity. They should then put on and off the switch then observe what happens.
- Guide learners to understand that the energy transformation that takes place here is chemical to electrical which causes the bulb to light. If switched off, the circuit breaks and the bulb goes off.
- Allow learners to brainstorm of other cases where this kind of transformation occurs. They should come up with a list and share with other class members. The list should include in a torch bulb, car headlights among others.

### ***Conversion from solar to electrical energy***

- In this section, you will refer to the picture in Activity 14.13 page 277 of pupils book. It shows a house installed with solar electricity.

### ***Conversion from electrical to mechanical energy***

#### **Activity 14.15 (Refer to Pupil's book page 279)**

- Let learners assemble the things as shown in this activity. They should then switch on the electric kettle then observe what happens.
- Let them direct the steam from the boiling water to the turbines. They should notice the turbines moving. Ask them to give an explanation on this.
- Guide learners to understand that the energy transformation that takes place here is electrical to mechanical which causes the turbines to turn.
- Allow learners to brainstorm of other cases where this kind of transformation occurs. They should come up with a list and share with



other class members. An example is ironing a piece of cloth using an electric iron.

### Synthesis

Using the various activities in the pupil's book, let learners discover the various transformations that occur between the various forms of energies. Emphasise the importance of these transformations (i.e. various uses like electricity generation among others). Learners should also be made aware of the fact that what they have learnt here can lead to careers such as electrical and mechanical engineering.

### Lesson assessment

Assess whether the learning objectives of the lesson were met by asking questions such as:

1. What is energy transformation?  
(Ans: Conversion of energy from one form to another)
2. What energy transformation is involved in:
  - (a). Lighted torch? (Ans: Chemical-light+heat)
  - (b). Hydro-power generation station? (Ans: Mechanical - electrical)

3. Ironing a piece of cloth involves \_\_\_\_\_ to \_\_\_\_\_ energy conversion. (Ans: Electrical - mechanical)

### Lesson 4: Sources of energy

Refer to learner's book page 282

### Specific objectives

By the end of the lesson, learners should be able to identify the main sources of energy.

### Preparation for the lesson

- This lesson will involve individual research work and class presentations. You will therefore organize the class as need arises during the lesson. **REMEMBER:** When grouping learners, you should consider the different abilities of learners and the special needs for various individuals.
- Look for locally available sources of energy for example solar panels, biogas installations, and generators, LPG etc.
- Ensure the Internet is working properly before the lesson for learners to use to do research.

### Teaching aids

- Biogas installations, solar panels, generators, LPG, windmills, etc.
- Charts on sources of energy and textbooks.

- Computers connected to the Internet.

### Improvisation

- You can assemble a temporary windmill to illustrate energy generation using wind.

### Pre-requisite of the lesson

- You may introduce the lesson by asking learners whether they know where energy comes from. They may say yes or no. Let them know that in this lesson, they will learn about the various sources of energy.

### Teaching / learning activities

#### Find out (Refer to Pupil's book page 281)

- Let learners go to the library and individually find out from text books the various sources of energy. They should also find out the differences between renewable and non-renewable sources of energy.
- Learners should come up with summary notes and back in class, share their findings with other class members during presentations.
- Guide learners to discover the various sources of energy which include the Sun, fuels, hydro, biomass, wind among others. Emphasize the fact that the Sun is the main source of energy on Earth.

### Synthesis

Using research activity learners should be helped to discover the various sources of energy and the differences between renewable and non-renewable sources of energy.

### Lesson assessment

Assess whether the learning objectives of the lesson were met by asking questions such as:

1. Where does energy come from?  
(Ans: From various sources such as Sun, wind, water, biomass, etc)
2. What is the main source of energy on Earth? (Ans: Sun)
3. How can we generate energy using wind? (Ans: By installing windmills)
4. Give two examples of:
  - (a). Renewable sources of energy  
(Ans: Solar, water, wind, biofuels such as trees (can be replanted))
  - (b). Non-renewable sources of energy  
(Ans: Coal, crude oil, nuclear, natural gas)

## Lesson 4: Renewable sources of energy – Solar energy

Refer to learner's book pages 283

### Specific objectives

By the end of the lesson, learners should be able to:

- Identify solar energy as a renewable source of energy.
- Describe the components of a solar power installation.
- Explain the advantages of solar power

### Preparation for the lesson

1. This lesson will involve a case study and a field visit to a solar power installation facility. You will therefore organize the class as need arises during the lesson. **REMEMBER:** When grouping learners, you should consider the different abilities of learners and the special needs for various individuals.
2. Look for solar panels and other solar power installation facility accessories such as solar battery, inverters, bulbs etc.
3. Identify a power installation plant for a field visit and seek permission from concerned authorities in advance.

### Teaching aids

- Solar panels, solar battery, inverters, bulbs etc.
- Chart on an installed solar power plant.
- Computers connected to the Internet.

### Improvisation

- You may come up with a drawing of a solar power installation plant on a manila paper to be used as a chart.

### Pre-requisite of the lesson

- Introduce this lesson through a brainstorming session on what learners know about sources of energy.
- Let them group the various sources either as renewable or non-renewable. Through group discussions, they should justify their groupings.
- Take advantage of the mention of solar energy as an example of a renewable source of energy and introduce this concept.

### Teaching / learning activities

- In order to further emphasize the differences between renewable and non renewable energy sources, let learners carry out the following case study.

### Case study (Refer to Pupil's book page 284)

- Let learners study the two pictures. Initiate a discussion on what happens in the second picture (B) when the charcoal gets finished YET THE FOOD IS NOT YET COOKED. The answer will be: 'more charcoal is added'. As for the second picture, the cooking process goes on uninterrupted.
- Guide learners to engage in more discussions about the advantages and disadvantages of each. For example, A is clean energy, B - can cause death if used in a room without enough ventilation due to carbon monoxide poisoning, etc. Based on these learners should feel free to choose which cooking method they prefer.
- Narrow down to solar energy as an example of renewable source of energy.

### Activity 14.18 (Refer to Pupil's book page 285)

- Arrange for learners to visit a house or a place with a solar power installation facility.
- During the above visit, guide learners to engage the officer in charge or the owner in a question and answer session using the

questions in this activity. Guide them to come up with summary notes and a sketch diagram of a solar power installation plant.

- Ask them to list down the various components of a power solar power installation facility.
- Wind up this lesson by highlighting the various uses of solar energy
- Let learners write summary notes as you do the explanation.

### Synthesis

Use the case study and the field trip to make learners understand what solar energy is and its importance. Guide learners during the field visit to seek answers to pertinent questions regarding solar installation plants, their functionality and maintenance. At the end of the lesson, learners should appreciate solar energy and be willing to apply it in their daily lives.

### Lesson assessment

Assess whether the learning objectives of the lesson were met by asking questions such as:

1. What is the difference between renewable and non-renewable energy sources? (*Ans: Renewable – cannot be exhausted, non-renewable – can be exhausted*)
2. Give two examples each of:
  - (a). Renewable energy sources

\_\_\_\_\_, \_\_\_\_\_  
(Ans: Sun, wind, water, geothermal, trees )

(b). Non-renewable energy sources

\_\_\_\_\_, \_\_\_\_\_  
(Ans: Coal, crude oil, nuclear, natural gas )

3. Name three main components of a solar installation facility. (Ans: Solar panel, inverter, battery)
4. Where can you use solar energy?  
(Ans: Cooking, drying things, water heater, etc)
5. Give one MAJOR advantage of solar energy?  
(Ans: Is the cleanest and the safest source of energy)

### Lesson 5: Renewable sources of energy – biogas

Refer to learner's book pages 287

#### Specific objectives

By the end of the lesson, learners should be able to:

- Identify biogas as a renewable source of energy.
- Describe the components of a biogas plant and build one.
- Explain the advantages of biogas as

a source of energy.

#### Preparation for the lesson

1. This lesson will involve a field visit to a biogas generation facility and a class project on biogas generation at school. You will therefore organize the class as need arises during the lesson.  
**REMEMBER:** When grouping learners, you should consider the different abilities of learners and the special needs for various individuals.
2. Identify a biogas plant for a field visit and seek permission from concerned authorities in advance.
3. Test whether the video link: <https://www.youtube.com/watch?v=mWefbc1spd0> is working.

#### Teaching aids

- Biogas digester.
- Chart on an installed biogas plant.
- Computers with internet connection.

#### Improvisation

- You may use cut plastic bottles, jerry cans or drums/tanks when making a simple biogas digester.

#### Pre-requisite of the lesson

- Introduce this lesson by reminding

learners what they learnt in the previous lesson about solar energy.

- Let them know that biogas which they will cover in this lesson is another example of renewable energy.

### Teaching / learning activities

#### Activity 14.19 (Refer to Pupil's book page 287)

- Arrange for learners to visit a place with a biogas facility. During the visit, guide learners to engage the officer in charge or the owner in a question and answer session using the questions in this activity. Guide them to come up with summary notes and a sketch diagram of a biogas digester.
- Ask them to list down the various components of a biogas facility. You may also refer learners to Fig. 14.19 on page 287 of pupil's book for reference.
- At this point, you may engage learners in a project of assembling a biogas digester in school. This should be done as a class project.

#### Activity 14.20 (Refer to Pupil's book page 288)

- Begin this exercise by showing learners a demonstration video of how biogas digester is made.

Use the link: <https://www.youtube.com/watch?v=mWefbc1spd0> or any other appropriate video of your choice.

- After watching the video, let learners assemble a biogas digester as highlighted in this activity. The learners should then monitor biogas production from this installation. **NOTE:** You may recommend use of this facility for cooking purposes in school as learners oversee the maintenance as per what they learnt during the field visit.
- Encourage learners to come up with a similar project at home under guidance of their guardians.
- Wind up this lesson by highlighting the various uses of biogas energy and the advantages of using biogas and renewable energy in general as listed on pages 288 of Pupil's book.

### Synthesis

Use the field visit and the biogas digester assembling project to make learners understand what biogas energy is and its importance. Guide learners during the field visit to seek answers to pertinent questions regarding biogas plants, their functionality and maintenance. At the end of the lesson, learners should appreciate biogas energy and be willing to apply it in their daily lives.

### Lesson assessment

Assess whether the learning objectives of the lesson were met by asking questions such as:

1. What is the raw material for producing biogas? (*Ans: Water + cow dung or other domestic wastes*)
2. Where do we produce biogas? (*Ans: In a biogas digester*)
3. Draw and label a biogas digester. (*Ans: Fig. 14.10 page 287 pupil's book*)
4. Where can you use biogas? (*Ans: cooking and source of lighting. Slurry from biogas digester can also be used as manure in farms*)

### Answers to Self-Test 14.1

Refer to learner's book page 273

1. Ability to do work.
2. Chemical, thermal (heat), electrical, mechanical, elastic, electromagnetic.
3. TV, DVD, refrigerator, electric cooker, electric iron, radio, etc.
4. By rubbing a biro pen case, comb or any object made of plastic on hair.

### Answers to Self-Test 14.2

Refer to learner's book page 281

1. Chemical, thermal (heat), electrical, mechanical, elastic, electromagnetic
2. (a) Heat (b) Electric (c) Mechanical

3. (a) chemical to electrical to sound.  
(b) Mechanical to electrical to heat or light.  
(c) Elastic to mechanical.
4. Elastic – found in materials that stretch like rubber; thermal – heat energy (causes increase in temperature of a body).
5. Chemical (in lemon) to electrical (in bulb).

### Answers to Self-Test 14.3

Refer to learner's book page 290

1. Water, wind, biofuels such as trees, coal, crude oil, nuclear, etc.
2. Renewable – cannot be exhausted, non-renewable – can be exhausted
3. Black colour absorbs maximum amount of heat.
4. Solar panel – Absorbs light energy from the Sun and converts it to electrical energy

Inverter – converts alternating current (AC) to direct current (DC) for storage.

Battery – stores electric current.

Wires – channels or transports current.

found in materials that stretch like rubber; thermal – heat energy (causes increase in temperature of a body).

5. Biogas, making charcoal balls, drying and burning directly.

6. Methane
7. Cheap, safe, readily available, conserves the environment, are convenient to use.

### **Summary of the unit**

This unit mainly deals with energy transformations and renewable sources of energy and particularly solar energy and biogas. You should effectively use the suggested activities and the teaching approaches in the teacher's book to help learners acquire the competence in these areas. Further, the suggested activities and videos should help you drive home the fact that renewable sources of energy are much better for use compared to non – renewable sources which require huge investments. Emphasize the need for learners to behave responsibly in order to avoid environmental destruction, which will eventually interfere with energy supplies. At the end of the lessons, you should assess the extent to which the competencies have been achieved and attitude change towards responsible use of energy sources. Plan remedial activities where necessary. Remember, one of the attitudes and values intended at the end of the topic is for learners to be able to adopt the proposed energy sources in their lives in future (biogas

and solar energy). Emphasize this point and the fact that taking this unit seriously may lead to careers such as electrical and mechanical engineering.

### **Additional Information for the teacher**

Some information that you may find relevant in this topic are given below.

#### **Forms of energy**

Energy exists in many different forms. Some of these forms include light, heat, chemical, sound, electrical, mechanical among others.

#### **Light energy**

This is a form of energy that enables the eye to see. It is usually produced by very hot

objects such as the sun, electric bulbs, fire, e.t.c. The Sun is the main source of energy on Earth.

#### **Heat energy**

This is the form of energy which causes changes in temperature when absorbed or lost by a body. It is usually released by burning fuels, the sun, electric heaters (when a current flows through it) among others. Heat is given off when thermal energy is transferred.

#### **Chemical energy**



This is a form of stored energy that exists in matter. It is released when matter is involved in a chemical reaction. Such a reaction may involve burning of the matter for example, burning of fuel such as kerosene in oxygen. Food is our main source of chemical energy. Fossil fuel like coal, petrol, oil and natural gas are other sources of chemical energy. The burning process releases the stored chemical energy in a substance.

### **Sound energy**

Sound refers to vibrations composed of frequencies, capable of being detected.

This is a form of energy that is produced by vibrating objects. The vibrating object causes disturbances in air which transmit the sound energy. Solids and liquids also transmit sound. In human beings, we hear sound using our ears.

### **Mechanical energy**

This type of energy exists in two different forms; the kinetic energy and potential energy.

#### *(i) Kinetic energy (K.E)*

This is a form of energy possessed by a body due to its motion. Any body in motion possesses kinetic energy, which reduces to zero when the object stops. To make a body move requires a force to

act on the body, giving it kinetic energy.

#### *(ii) Potential energy (P.E)*

This is the type of energy that is stored in a body and has the potential or ability to do work. There are three forms of Potential Energy:

- Gravitational and elastic potential energy - Is a form of energy that is possessed by a body due its position relative to another point at a lower level. A body raised above the ground to a height possesses potential energy whose magnitude depends on the height.
- Elastic potential energy - is a form of energy possessed by stretched or compressed objects e.g. rubber and springs.
- Chemical potential energy is the energy a body has because of what it's made off. This energy is present in an electrical cell, explosives, food and fossil fuels.

### **Nuclear energy**

This is a form of energy stored in the nuclei of atoms. The particles of the nucleus are held together by forces which when broken release enormous amounts of energy in form of radiations (**nuclear fission**). This energy can be converted to heat and light. The nuclear energy may also be released when

smaller nuclei combine to form larger ones (**nuclear fusion**).

### **Electrical energy**

This form of energy is obtained by conversion of energy from other forms. For example, the potential energy of water is converted to electrical energy in hydroelectric power stations; the chemical energy in batteries is converted into electrical energy in a closed circuit. This energy due to the flow of charges is electrical energy. They are of two types: static and current.

#### (i) *Current electricity*

**Electricity** is the flow of electrons. **Electrons** are negatively charged particles found in matter, specifically in the nucleus of atoms. Electrons are very light and move through a conductor to make an electric current.

Electricity (or simply moving electrons) is “pushed” by a power source such as a cell, a battery or any other source of electrical energy. And for electrons to travel or to flow they need a pathway; they travel in a **circuit** along a **conductor** (which is usually a metal bar – a wire) which allows electricity to flow through it. That is why **electric current** can be defined as a flow of electrons through a wire. In other words,

electrons through a conductor make an electric current. Electric current (commonly just referred to as **current**) is measured using an instrument called an **ammeter**. The ammeter is always connected in **series** - in the same line with the source of electricity, such as a battery. See figure below. The units of current are **amperes** (can be shortened to **amps** – or by using symbol **A**). It is the current that makes a bulb to light or a radio to play. Thus, for a current to light a bulb there must be a source of electricity, such as a battery. For an electric current to flow, there must be a complete **circuit**, - no gaps.

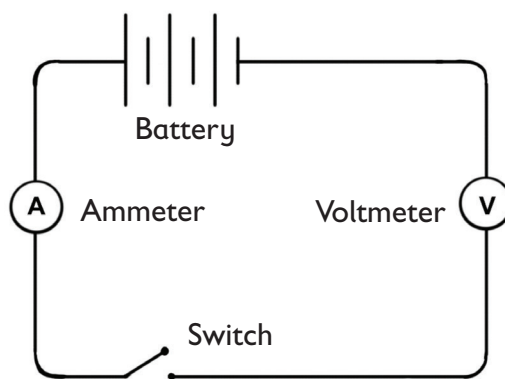

Fig. 14.1 Complete circuit

### **Voltage** (also called Potential difference)

In order to understand what voltage is, we first need to remind ourselves of what we discussed earlier about the push that electrons get in a circuit for them to flow. It was stated that a cell

or a battery pushes electrons round a circuit. It means that for an electric current to flow, there must be a force to drive or to push electricity around the circuit. Different cells can exert different electrical forces or pressures. This electrical force or pressure is called **electromotive force (e.m.f.)** and is provided by dry cells, batteries or generators. When a bulb is connected to a cell, the electron power or the e.m.f. of the cell is being resisted from flowing smoothly by the bulb (which we can call a **resistor**). The bulb or resistor opposes the smooth flow of an electric current in a circuit. This means that as current is flowing in a circuit, the e.m.f. across the bulb gradually decreases. For example, in figure 14.2 below, the e.m.f. at point **X** will be higher than at point **Y**. A difference in the e.m.f. will thus be observed between the two ends **X** and **Y**. This difference in e.m.f. between the two ends of a resistor (bulb) in a circuit

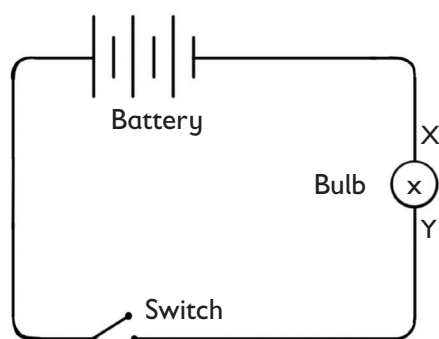

Fig. 14.2 Circuit showing voltage is what is referred to as **potential difference (p.d.)**, or **voltage**; thus,

there is a potential difference between points **X** and **Y**. Voltage or potential difference is therefore the total energy supplied by a source such as a battery to drive electricity **across a resistor**.

Voltage or potential difference is measured in a unit called the **volt** (symbol **V**). The instrument used to measure potential difference is the **voltmeter**. Since the voltmeter measures voltage across a resistor, it is therefore always connected in **parallel** to or **across** the resistor.

(ii) *Static electricity*

All physical objects are made up of atoms. Inside an atom are protons, electrons and neutrons. The protons are positively charged, the electrons are negatively charged, and the neutrons are neutral.

Therefore, all things are made up of charges. Opposite charges attract each other (negative to positive). Like charges repel each other (positive to positive or negative to negative). Most of the time positive and negative charges are balanced in an object, which makes that object neutral.

Static electricity is the **result of an imbalance between negative and positive charges in an object**. These

charges can build up on the surface of an object until they find a way to be released or discharged. One way to discharge them is through a circuit.

The rubbing of certain materials against one another can transfer negative charges, or electrons. This is what happens when you rub a case of biro pen or comb against your hair. And what about that “hair raising” experience? You may have realized that when you remove your hat from the head, you experience hair rising. As you remove your hat, electrons are transferred from hat to hair, creating that interesting hairdo! Remember, objects with the same charge repel each other. Because they have the same charge, your hair will stand on end. Your hairs are simply trying to get as far away from each other as possible!

When you rub a balloon against your clothes and it sticks to the wall, you are adding a surplus of electrons (negative charges) to the surface of the balloon. The wall is now more positively charged than the balloon. As the two come in contact, the balloon will stick because of the rule that opposites attract (positive to negative).

### **Law of conservation of energy**

When energy in one form is converted to another form(s), the energy obtained through this conversion is always equal to that in the original form. For example, when electric current flows through

a light bulb, the heat and light energy obtained is equal to the electrical energy drawn by the bulb i.e.

### **Electrical energy drawn by the bulb = heat energy + light energy produced by bulb**

In all cases of conversion, the total energy before conversion is equal to the total energy obtained after conversion. This is summarized in the law of conservation of energy which states:

*“Energy can never be created nor destroyed but can be changed from one form to another”*

### **Heat transfers**

The word heat refers to the state of having **thermal energy**. It is the thermal energy that is transferred from hot places to cold places. When we sit around a fire, we feel warm. This is because heat moves from the source (fire) to us. When we put a pot on fire, the water inside gets hot and boils because heat moves from the fire, through the pot, to the water. This makes the water hot. Heat transfer is the movement of heat from a hotter place to a colder place. Heat travels through all the three states of matter i.e. solids, liquids and gases. It can also move through a vacuum.

### **Types of heat transfer**

There are various ways through which heat travels. They are:

- Conduction

- Convection
- Radiation

(a) *Conduction*

When you hold the end of an object such as a metal rod over a fire, at first you do not feel the heat. After a while,

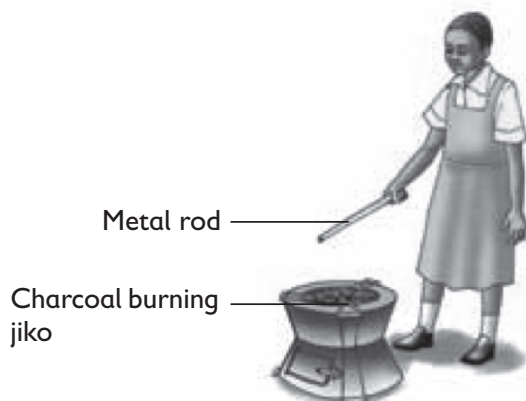

Fig. 14.3 Conduction

you begin to get burnt and you have to let go off the rod.

Look at the figure below. What will happen after a while? How did the heat reach the hand of the learner?

The heat must have travelled along the metal rod. The heat travelled from the hot end to the cooler end. Heat travels through solids by a method called **conduction**.

When a substance is heated, the molecules which are nearer to the source of heat gain kinetic energy and so move faster. Each molecule passes some of its extra energy to its neighbours

as it ‘bumps’ into them, making them move as well. The process is repeated and energy is transferred throughout the substance, from the hot region to colder regions. Hence in conduction, energy transfer takes place by vibration of the particles. **Note** that there is no actual movement of heated particles. Metals are particularly good conductors of heat because energy is transferred from the hotter regions to the colder ones by the ‘free’ electrons present in their structures. Materials which are poor conductors of heat are known as **insulators**. They lack free electrons that conduct heat. Examples include wood and plastic.

(b) *Convection*

Convection is the method of heat transfer in fluids (liquids) or air.

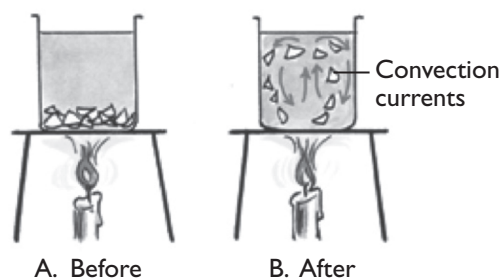

Fig. 14.4 Convection

It occurs due to the actual physical movement of molecules of the fluid due to temperature differences within the fluid. Convection cannot take place in solids because molecules in solids do not move. They only vibrate within their

fixed positions. Look at the figure below that demonstrates convection in liquids.



Fig. 14.5 Convection in air

The crystals dissolve and the hot water of less density starts rising, displacing the cold dense water down. As they do this, they move together with the crystals. The streams of physically moving warm liquid (as depicted by the path taken by the crystals) are called **convection currents**.

Now, hold your hand high above a fire, as shown in Fig. 14.5 below. Do you feel the heat?

Hot air rises carrying the heat along with it. This way, the heat reaches your hand.

This method of heat transfer is called convection. Because it involves air currents, it is **convection in air**. Similarly, smoke which is made up of hot air rises up because it is lighter. It has a lower density than cold air. The cold air comes down because it is heavier. This explains why smoke always moves up in a burning flame.

(c) Radiation

If you stand in front of a fireplace, Fig.



14.6 Radiation

you feel warmth. Heat energy cannot reach you by conduction as air is a poor conductor of heat. How about convection? The hot air molecules in and around the fireplace can only rise and cannot reach you by the movement of the air currents. How does the energy from the fireplace then reach you? Heat energy must be transferred by a different mode other than conduction and convection.

Look at the picture below. The people are warming themselves besides a charcoal stove.

They are separated from the charcoal stove by air. How do you think the heat or warmth reaches them? Heat reaches the girl by another method of heat transfer called **radiation**. Radiation takes place in form of waves. The waves do not require materials such as solids, liquids or air in order to travel.

## Energy conservation

Energy conservation means using the available energy resources carefully so that they do not get exhausted or depleted. There are many methods of conserving energy. Examples include:

- Using energy sparingly.
- Using energy-efficient devices or equipment.
- Using renewable energy resources such as wind, sun, biogas, planting trees.
- Geothermal energy, tidal and wave energy and nuclear energy.
- Use of 3Rs of conservation

### Using energy sparingly

The following examples show ways in which we can use energy sparingly.

- If we are cooking, we should use just enough fuel to complete the cooking. No fuel should be left burning wastefully after the cooking is completed.
- If we are using electricity to light our houses we should switch off lights in the rooms that are not being used. We should also use bulbs that do not consume much electricity; For example, use low energy saving bulbs.
- If we use firewood or charcoal after cooking the fire on the remaining pieces should be put out.

### Conserving energy by using energy-efficient devices

Most of the energy available is wasted because our machines, equipment or devices are not efficient. To be efficient means to be able to work well without wasting much energy. If the devices we use are efficient, then we minimize wastage of energy.

Some of these energy efficient devices/ways that people can use include:

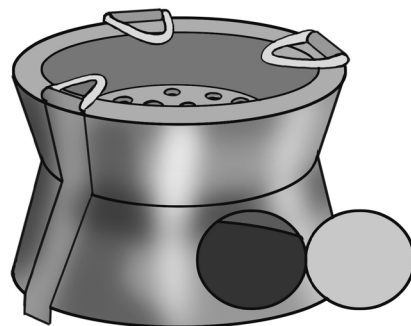

Fig. 14.7 Improved jiko

#### 1. Cooking using improved fireplaces and charcoal stove

A three-stone wood fire used for cooking is very wasteful. Firewood burns very fast. Heat energy is spread out in all directions and as a result, a lot of energy is wasted.

Similarly, the ordinary charcoal stove loses most of the heat to the surroundings. It has no insulation and therefore a lot of heat is lost sideways through conduction of heat by the metal walls or casing. Heat is also lost in all directions through radiation. An improved charcoal stove like the one shown below is preferred.

In the improved charcoal stove, the clay lining keeps most of the heat inside. Clay is a poor conductor of heat. It is an insulator. A few pieces of charcoal can effectively be used to cook food.

2. Other varieties of improved cookers are the clay cooker and pressure cooker.

### **Vacuum flask**

Other methods of conserving heat energy include the use of a vacuum flask to keep liquids and foods hot for a long time. The flask is designed to prevent heat loss by either conduction, radiation or convection. By preserving drinks or foods hot in a vacuum flask, it saves on fuel that would otherwise have been used to re-warm them later when we want to take them.

### **Conserving energy by using renewable energy**

Fuels formed from remains of plants and animals are called **fossil fuels**. They include coal, natural gases, oil and its products. These sources of energy are non-renewable. This means that once they have been used they cannot be replaced or restored. There are alternative sources of energy which are not exhaustible. We refer to these sources of energy as **renewable sources**. They include:

- Wind energy
- Sun or solar energy
- Biogas
- Planting trees.

### **The three R's of conservation**

The three **R**'s mean **Reduce**, **Reuse** and **Recycle**. Which by extension means. Practice what you preach, don't buy things you don't need or items that come in wasteful packaging or that cannot be recycled. **Reuse** and **Recycle** whatever you can.



Fig. 14.8 3 Rs of conservation

#### **a). Reduce**

Reducing the amount of waste you produce is the best way to help the environment. For example:

- Buying products that don't have a lot of packaging.
- Save energy by turning lights off when leaving a room.
- Save water by turning off taps.

#### **b). Reuse**

Instead of throwing things away, try to find ways of using them again. For

Example:

- Plastic containers can be reused for other activities.
- Cans can be used to store other things.
- Use all writing papers on both sides
- Use silverware and dishes instead of disposables plastics.



### c). Recycle

Recycled items are put through a process that makes it possible to create new products out of the materials from the old ones.

Buy materials made from recycled materials e.g. paper, towels, garbage bags, greeting cards and toilet paper among others.

#### Answers to Unit Test 14 (pupil's book page 291)

1. Energy is ability to work.
2. Chemical
3. Chemical energy stored in fuel is released during burning and converted to mechanical energy which is used to propel the vehicle.
4. Chemical → Electrical → Light/thermal (heat)

5. Trees are sources of renewable energy, they are sources of rain as well ( through transpiration), sources of timber used to make furniture, prevent soil erosion, are medicines, animals use some as sources of food ( fruits,seeds, stems, leaves and roots), etc.
6. D
7. D
8. Chemical
9. When you rub your hands against one another, you feel warm. This shows existence of thermal energy.
10. Static is caused by charged particles and is immobile, current is electricity in motion.
11. A

12.

B	C	E	L	E	C	T	R	I	C	A	L
R	H	V	M	Q	V	U	Y	Z	P	J	E
H	E	A	T	L	S	O	U	N	D	K	L
W	M	E	C	H	A	N	I	C	A	L	A
X	I	Z	L	G	E	G	F	J	I	Q	S
Y	C	Q	D	X	O	R	V	W	L	Z	T
O	A	X	O	V	M	N	M	S	F	T	I
W	L	I	G	H	T	S	U	A	L	D	C
D	M	N	K	Y	R	X	Q	W	L	P	H

13. B

14. B

15. (a) True  
 (b) True  
 (c) False  
 (d) False
16. Let learners plan and execute the project under the guidance of their parents/guardians at home. Ensure that the parent/guardian gives a report on the project progress. Evaluate and award marks to individual learners.
17. – Using energy sparingly.  
 – Using energy efficient devices  
 – Prioritizing using renewable sources of energy.  
 – Emphasizing on the 3Rs of conservation that is, Reduce, Recycle and Re-use.

### Additional activities to cater for slow and gifted learners

Remedial activities for slow learners	Extended activities for gifted and talented learners
1. Collecting materials for use during making of biogas digester. 2. Help with labeling of parts of drawn charts. 3. Reading group reports to group/class members.	1. Make a biogas digester at home and use it for cooking. What raw materials did you use? 2. Research and write short notes about magnetic energy. 3. Compiling group reports and doing presentations.
Remedial questions for slow learners	Extended questions for gifted learners
1. Name the common sources of fuel in your community. 2. Identify some domestic uses of heat energy. 3. Draw a simple chart to illustrate the energy transformation of fuels during burning. 4. What is potential energy? 5. Solar water heater uses energy from the _____.	1. Food is often referred to as fuel of the body. Explain the statement. 2. Name two things that are produced when fuels burn. 3. Compare and contrast solar energy and biogas.

<b>Answers to remedial questions</b>	<b>Answers to extended questions</b>
<ol style="list-style-type: none"><li>1. Firewood, paraffin, charcoal, LPG.</li><li>2. Cooking, warming, heating.</li><li>3. Chemical → heat + light</li><li>4. It is a stored energy</li><li>5. Sun</li></ol>	<ol style="list-style-type: none"><li>1. It is because food has stored energy which is produced when food is digested to make the body move and feel warmth.</li><li>2. Heat and light</li><li>3. Solar energy is from the Sun, biogas is from cow dung or kitchen wastes; solar energy is safe, biogas may be dangerous in case of leakages; both are clean sources of energy, both are cheap, both are convenient to use.</li></ol>

**Refer to the Learner's Book pages 293-307**

## Key unit competency

After studying this unit, learners should be able to explain and demonstrate the existence of magnetic forces and magnetic field.

### Unit Outline

## Learning objectives

Competency based curriculum embraces three categories of learning objectives,

that is, knowledge and understanding, skills acquisition and attitude and values. At the end of the unit, learners should have knowledge and understanding of magnetism and have the right attitude towards applications of magnets and magnetism.

**Table 15.1 Knowledge, skills and values to be attained**

Knowledge and understanding	Skills	Attitudes and values
<p>By the end of this unit, learners should be able to:</p> <ul style="list-style-type: none"> <li><input type="checkbox"/> Recognize that a magnet can exert a push or a pull.</li> <li><input type="checkbox"/> Explain the composition of magnets.</li> <li><input type="checkbox"/> Identify the characteristics of magnets.</li> </ul>	<p>By the end of this unit, learners should be able to:</p> <ul style="list-style-type: none"> <li><input type="checkbox"/> Observe different types of magnets.</li> <li><input type="checkbox"/> Compare and classify the types of magnets, non-magnets and magnets materials.</li> <li><input type="checkbox"/> Make a temporary magnet.</li> </ul>	<p>By the end of this unit, learners should be able to:</p> <ul style="list-style-type: none"> <li><input type="checkbox"/> Show curiosity in exploring uses of magnets in everyday life.</li> </ul>

<ul style="list-style-type: none"> <li><input type="checkbox"/> Classify materials according to magnetic force.</li> <li><input type="checkbox"/> Explain the types of magnets and magnetic field.</li> <li><input type="checkbox"/> List some uses of magnets in everyday objects.</li> </ul>		
--	--	--

### Pre-requisite of this unit

This is a completely new concept to the learners except for having been mentioned in the previous unit as a form of energy. Take cognisance of this as you introduce the topic. Here, you will guide the learning process on the definition of magnetism, types of magnets, definition of magnetic field and its effects, the magnetic compass and finally the uses of magnets. During the lessons, strive to bring to the awareness of learners the fact that this topic is related to magnetism in Physics. Let learners understand that at this level, they may only need the basic information otherwise; details of magnetism, its applications and usage will be taught in Physics at higher levels of education. Bring to the attention as well the fact that magnetism is heavily applied in engineering therefore taking this topic seriously is of essence.

### Background information

This topic deals with magnets and magnetic forces and their applications. Emphasize the various types of magnets, their characteristics, the forces that are exerted around a magnet ( magnetic field), the magnetic compass and its uses and the uses of magnets in our daily lives in general.

### Cross-cutting issues to be addressed

#### 1. Gender education

Both boys and girls should participate equally in the activities. Also, emphasize to learners that anybody irrespective of their gender can pursue a carrier in engineering. Give examples of role models who are successful engineers in the area where the learners come from.

#### 2. Standardization culture

Emphasize the need to use certified magnetic equipment. Caution learners against using counterfeits which may lead to accidents or injury of users.

### 3. Inclusive education

All learners should be encouraged to participate during lessons and practicals. Special arrangement should be made to take care of learners with special needs. For example, provide brail for blind learners, large print text for those with sight problems and allocate physically challenged learners to others to assist them during field trips and practical activities. Further, this category should be given tasks that they can manage during the practical sessions.

### 4. Financial education

Emphasize the need to buy quality equipment and devices made of magnets. By buying quality equipment, people save money in the long run as the equipment stay for long and costs on repair are reduced.

### 5. Environment and sustainability education

Bring to the attention of learners the fact that some of the devices made of magnets can be environmental hazards. They should appropriately be disposed of or should be recycled.

## Generic Competences

### 1. Co-operation and interpersonal management and life skills

During group discussions and pair-work let learners engage one another by giving a chance for all to participate. Also, during

group presentations, you can allow rotational presentations within the group members. Gifted learners should help in coming up with presentation content as slow learners contribute. **REMEMBER** You should allow slow learners to do presentations as well and correct them where they go wrong. Advise learners to appreciate the different abilities of their group members and accommodate each other's views.

### 2. Research skills

Guide learners on how to find information regarding various topics such as the meaning of magnetism, why magnets attract and repel among others. Guide learners on how to come up with summarized notes from a large body of text. You should also guide learners on how to do Internet searches for the various content areas they are looking for.

### 3. Communication in English

Communication in English will be improved when learners freely participate in the discussions and presentations. Encourage all learners irrespective of their abilities to participate in group discussions, during presentations by asking questions and during question and answer sessions to either introduce or wrap up the lessons.

### 4. Critical thinking and problem solving skills

This competence will be developed by learners as they answer the probing questions such as those on

page 309 at the beginning of this unit and as they discuss the results of the various practical activities. Guide learners to discover for themselves what causes magnets to attract or repel, the various characteristics of magnets, etc. This competence will also come about as learners think about their findings in the activities and as they give out their suggestions on why this is the case.

### 5. Lifelong skills

Make learners aware that they can become future engineers or device technicians if they take this topic seriously.

#### Key words in this unit and their meanings

- **Electromagnet** – A magnet consisting of a coil of insulated wire wrapped round a steel or iron core that is magnetized only when current flows through the wire. When current is switched off, it loses its magnetic properties.
- **Magnet** – A special type of object/item that produces a special type of force, which either attracts or repels other materials.
- **Magnetic compass** – An instrument or a device that uses magnetized steel bar to indicate direction relative to the Earth's magnetic poles.
- **Magnetic field** – This term refers to an area around a magnet where magnetic force is experienced. It is

usually represented using magnetic lines of force.

- **Magnetic material** – Any material that can be attracted by a magnet such as iron or steel and can be magnetized.
- **Magnetism** – This term refers to a property associated with magnets, which causes attraction or repulsion of substances that are magnetic.
- **Magnetite** – A type of mineral found in Earth's crust that is magnetic by nature.
- **Non - magnetic material** – Any material that cannot be attracted by a magnet such as plastic or wood. They can neither be magnetized.
- **Permanent magnet** – A type of magnet that retains its magnetism after it is removed from a magnetic field.
- **Temporary magnet** – A type of magnet that does not retain its magnetism after it is removed from a magnetic field. An example is the electromagnet.

#### Guidance on the problem statement

In this topic, you will teach about what magnetism is, the various types of magnets, their uses and magnetic field. As a way of introducing these concepts, refer learners to the diagram on page 293 of pupil's book. The picture is about

a child having accidentally spilled metallic pins into the flour (PictureA). The mother is trying to remove the pins from the flour and it is proving to be difficult (Picture B). She is stressed. Ask learners give a quick solution to the mother of the child which is - to use a magnet to attract the pins. Build on this to introduce the unit.

### Attention to special educational needs

Support for Multi-ability learning	Support for special needs learning
<ul style="list-style-type: none"> <li>– Gifted learners to be given heavy tasks requiring more critical thinking while slow learners are given tasks which they can manage such as collecting materials for use during practicals among others.</li> <li>– Both gifted and slow learners to be given equal opportunity to lead in group discussions and to do presentations of group findings to the rest of the class.</li> <li>– Ensure all learners respect other's views irrespective of their shortcomings or talents.</li> </ul>	<ul style="list-style-type: none"> <li>– Allocate gifted learners to help fellow learners with special needs.</li> <li>– Provide brail for blind learners and large print text to learners with seeing difficulties. Provide sign language alphabet symbols and sign language interpreters for the deaf.</li> <li>– Also, arrange learners such that shortsighted ones are at the front and long-sighted ones are at the back. Spectacles can as well be provided if available for learners with seeing difficulties.</li> </ul>

### List of lessons

Lesson No.	Lesson title	No. of periods
1.	Composition and types of magnets	2
2.	Characteristics of magnets	1
3.	Magnetic forces and magnetic materials	1
4.	Magnetic field	1
5.	Magnetic compass and its uses	2
6.	Uses of magnets	1



## Lesson 1: Composition and types of magnets.

### Lesson 1: Composition and types of magnets.

(To be covered in two periods)

Refer to learner's book pages 293

#### Specific objectives

By the end of the lesson, learners should be able to:

- Recognize that a magnet can exert a push or a pull.
- Explain the composition of a magnet.
- List the various types of magnets.

#### Preparation for the lesson

1. This lesson will involve individual research work and group activities or pair work. You will therefore organize the class as need arises during the lesson. **REMEMBER:** When grouping learners, you should consider the different abilities of learners and the special needs for various individuals.
2. Ensure the Internet is working properly before the lesson for learners to use to do research.

#### Teaching aids

- Bar magnets, pins, paper clips rubber, pencils or pieces of wood, coin, string, etc.
- Charts, textbooks, handouts and other materials on magnetism.
- Computers connected to the internet

#### Pre-requisite of the lesson

Introduce the unit as explained under **guidance on the problem statement** above then narrow down to this lesson. You may begin the lesson by asking learners probing questions such as: What is a magnet? What are they used for or where are they found? How can we differentiate magnets from other objects?

#### Teaching / learning activities

##### Activity 15.1 (Refer to Pupil's book page 293 )

- Put the learners in pairs and let them carry out the activities listed in this practical activity.
- Let them make their observations and record them in their note books.
- Guide the learners to discover the main property of magnets, which is 'attracting magnetic materials and unlike poles attracting and like ones repelling'.

- Emphasize the fact that a magnet is a special metal with the ability to pull or push other objects. Let them know that this is what magnetism is about.
- Wrap up this topic by highlighting the various types of magnets i.e. natural versus artificial and permanent versus temporary as learners write summary notes.

### Find out (Refer to Pupil's book page 293)

- This is a research activity to be done by individual learners. Let learners go to the library to read textbooks on what magnets are and the various types of magnets.
- They should come up with summary notes and share with the rest of their class members.

### Activity 15.2 (Refer to Pupil's book page 295-296)

- Put the learners in groups of five or any other number depending on class size and let them connect the items as shown in the figure in this activity.
- Let them try to pick up pins or paper clips when the switch is on and when off. Let them share their observations.
- Guide the learners to give explanations to their observations above – which is the concept of temporary magnets. Magnetism is lost when the current is switched off – this explains why the pins or clips are no longer attracted unlike in permanent magnets, which possess magnetism continuously.

### Synthesis

This lesson introduces learners to the concept of magnetism. Learners should discover what the term means and the various types of magnets by performing the suggested practical activities as you guide them.

### Lesson assessment

Assess whether the learning objectives of the lesson was met by asking questions such as:

1. What is a magnet?  
(Ans: A material that attracts or repels magnetic materials)
2. The two categories of magnets are \_\_\_\_\_ and \_\_\_\_\_?  
(Ans: Natural and artificial)
3. Give one example of each magnet named in question 2 above.  
(Ans: Natural – magnetite; Artificial – bar or horse shoe magnet)
4. Give the difference between temporary and permanent magnets  
(Ans: Temporary magnets lose magnetism when removed from a magnetic field, permanent magnets do not)

## Lesson 2: Characteristics of magnets

Refer to learner's book page 297

### Specific objectives

By the end of the lesson, learners should be able to identify the characteristics of magnets.

### Preparation for the lesson

1. This lesson will involve individual research work and group activities or pair work. You will therefore organize the class as need arises during the lesson. **REMEMBER:** When grouping learners, you should consider the different abilities of learners and the special needs for various individuals.
2. Ensure the Internet is working properly before the lesson for learners to use to do research.

### Teaching aids

- Bar magnets, pins, paper clips rubber, pencils or pieces of wood, coin, string, etc.
- Charts, textbooks, handouts and other materials on magnetism.
- Computers connected to the internet

### Pre-requisite of the lesson

You may begin the lesson by asking learners what they learnt in lesson 1

above.

Ask probing questions such as:

- (i) What is a magnetism?
- (ii) What types of magnets do you know?
- (iii) Based on your knowledge from the previous lesson, can you give some properties of magnets?

### Teaching / learning activities

#### Activity 15.4 (Refer to Pupil's book page 297)

- Put learners in groups and let them carry out the activities listed in this practical activity.
- Let them make their observations and record them in their notebooks.
- Guide the learners to discover the properties of magnets. Let them write short notes and share with their group members.
- Call upon one learner to give a summary on the characteristics of magnets as other learners take notes. Correct him/her where appropriate. Refer to pupil's book page 298 for a summary of characteristics of magnets.

### Synthesis

This lesson is more or less a review of the previous lesson. Using the practical activity, guide learners to discover other characteristics of magnets other than

what they already know.

### Lesson assessment

Assess whether the learning objectives of the lesson was met by asking questions such as:

1. Give atleast three properties of magnets.

*(Ans: Have two pole (north and south pole); unlike poles attract, like ones repel; attract magnetic materials but not non magnetic materials; always rest with north pole pointing south of Earth's magnetic pole)*

### Lesson 3: Magnetic forces and magnetic materials

Refer to learner's book pages 298

### Specific objectives

By the end of the lesson, learners should be able to:

- Classify materials either as magnetic or non magnetic.
- Make and use a temporary magnet.

### Preparation for the lesson

1. This lesson will involve individual pair work and group activities. You will therefore organize the class as need arises during the lesson.

**REMEMBER:** When grouping learners, you should consider the

different abilities of learners and the special needs for various individuals.

2. Collect materials required to perform the various practical activities given below under teaching aids.

### Teaching aids

- Bar magnets, safety pins, paper clips rubber, pencils or pieces of wood, coin, string, white sheet of paper, iron fillings, biro pen casing, pieces of glass, cork, sewing needle, etc.
- Charts, textbooks, handouts and other materials on magnetism.
- Computers connected to the internet for research.

### Pre-requisite of the lesson

- You may begin the lesson by asking learners probing questions such as: 'do you think all materials found on Earth can be attracted by a magnet?' 'Why is this the case?'
- Based on their answers to the above questions, introduce the concept of magnetic and non-magnetic materials.

### Teaching / learning activities

#### Activity 15.5 (Refer to Pupil's book pages 299)

- Put the learners in groups of four or any other number depending on the class size.
- Let them brainstorm about magnetic or non-magnetic materials that they know. They should then come up with a table like the one in procedure 1 of this activity.
- Provide each group with the materials in listed. Let them carry out the activities described.
- Let them make their observations and record them in a table like the one above. They should then compare the results in this table with the one they came up with before the practical activity.
- Guide the learners to discover the materials that are magnetic and the ones that are not. They should then come up with updated table with accurate information.
- Let them compare their table with table 15.1 on page 300 of their book. Did they get it right? If not, they should correct accordingly.
- Learners will make a temporary magnet and use it to pick magnetic materials like paper clips and pins in this activity.
- Put the learners in groups of five or any other number depending on class size and let them connect carry out the activities described.
- Let them try to pick up pins or paper clips using the magnetized nail.
- Guide the learners to give explanations to their observations above – which is the concept of temporary magnets. The nail became magnetized by passing it several times over the magnet. However, this magnetism is lost after some time – this explains why the pins or clips are no longer attracted.
- Wrap up this topic by highlighting the various magnetic and non-magnetic materials as learners write summary notes.

### Synthesis

This lesson is about magnetic and non magnetic materials and magnetization. Using the practical activities, guide learners to discover magnetic materials and how to make a temporary magnet. They should then use the temporary magnet they have made to pick magnetic materials.

### Lesson assessment

Assess whether the learning objectives of the lesson was met by asking questions such as:

1. Name some
  - (a) Magnetic (*Ans: Iron, steel, nails, pins, paper clips, etc*)
  - (b) Non – magnetic materials that

you know. (Ans: Wood, plastic, cork, rubber)

2. How can you make a temporary magnet using a permanent magnet?

(Ans: Moving the metal to be magnetized in the same direction, rather than back and forth. Using the same quick motion you would use to light a match and continue rubbing the material with the magnet about 50 times as quickly as you can)

#### Lesson 4: Magnetic field

Refer to learner's book pages 300

#### Specific objectives

By the end of the lesson, learners should be able to explain what a magnetic field is and draw the magnetic fields of various types of magnets.

#### Preparation for the lesson

1. This lesson will involve pair work or group activities. You will therefore organize the class as need arises during the lesson. **REMEMBER:** When grouping learners, you should consider the different abilities of learners and the special needs for various individuals.
2. Collect materials required to

perform the various practical activities given below under teaching aids.

#### Teaching aids

- Bar and horseshoe magnets, iron fillings, a piece of white paper.
- Charts, showing magnetic fields of different magnets.
- Computers connected to the internet for research.

#### Pre-requisite of the lesson

- You may begin the lesson by reminding learners why magnets are in fact said to be magnetic. Their answers may include – ‘because they exhibit magnetic forces’. Let them name the forces. They may say ‘forces of attraction or repulsion’.
- Based on their answers, introduce the concept of magnetic field are the area where these forces operate.

#### Teaching / learning activities

#### Activity 15.6 (Refer to Pupil's book page 301)

- Put the learners in pairs or groups depending on the size of the class.
- Provide each group with the materials listed. Let them carry

out the activities described under procedure 1 and 2.

- Let them make their observations and record them in their notebooks. They should draw the pattern obtained when the various magnets are used.
- Guide the learners to discover the magnetic field lines of bar and horse shoe magnets.
- Let them compare their drawings with those in Fig. 15.4 on page 301 of their book. Did they get it right? If not, they should correct accordingly.
- They should then proceed with procedures 3 and 4 by bringing like poles of same magnet and unlike poles together. They should observe the pattern formed by the iron filings and come up with a drawing.
- Let them compare their drawings to those in Fig. 15.6 and 15.7 for bar magnet. Guide them to correct their drawings accordingly.
- Wrap up this lesson by highlighting the meaning of magnetic field and clarifying the differences between the various magnetic fields formed

by different types of magnets and when like and unlike poles are brought close together.

### Synthesis

This lesson is about magnetic forces and magnetic lines of force. Using the practical activities, guide learners to discover what magnetic field lines are and how to draw accurate field lines for various magnets.

### Lesson assessment

Assess whether the learning objectives of the lesson were met by asking questions such as:

1. What is magnetic field?  
(Ans: The area around a magnet where magnetic force is experienced)
2. Draw magnetic field line of:  
(i) Bar magnet

Ans

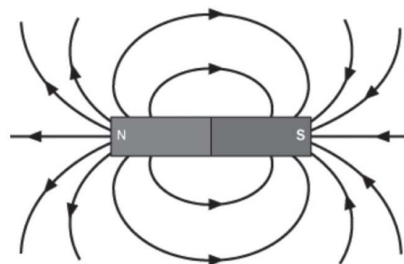

- (ii) Horse shoe magnet

Ans

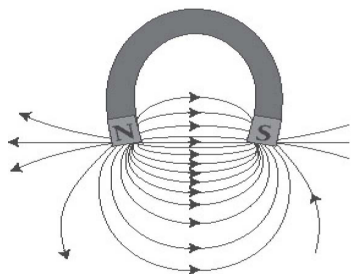

## Lesson 5: Magnetic compass and its uses

Refer to learner's book pages 303

### Specific objectives

By the end of the lesson, learners should be able to explain what a magnetic compass is and state its use.

### Preparation for the lesson

1. This lesson will involve pair work or group activities. You will therefore organize the class as need arises during the lesson. **REMEMBER:** When grouping learners, you should consider the different abilities of learners and the special needs for various individuals.
2. Collect materials required to perform the various practical activities given below under teaching aids.

### Teaching aids

- Bar or horseshoe magnet, clear plastic jar with water, three needles, thread, pencil, piece of manila paper, clay or plasticine, tape.
- Magnetic compass
- Computers connected to the internet for research

### Pre-requisite of the lesson

- You may begin the lesson by showing learners the sample magnetic compass that you have. Let them say whether they know what it is or not.
- Irrespective of their answers, introduce activity 15.7 straight away.

### Teaching / learning activities

#### Activity 15.7 (Refer to Pupil's book page 303)

- Put the learners in groups depending on the size of the class. Provide each group with the materials listed.
- Guide the learners to carry out the activities described under this activity. At the end of the activity they would have made a home-made magnetic compass and tested how it works. Let them make their observations and record them in their notebooks.



- At this point, you should show learners the magnetic compass again. Let them say what it is based on earlier discussions.
- Throw the magnetic compass next to the equipment that they made. Let them note the direction where the north pole points compared to their equipment.
- Guide the learners to discover the use of a magnetic compass in showing direction. Emphasise the fact that the Earth is a big magnet hence being a magnet, it has poles. Therefore, based on the rules of magnetism whereby like charges attract and unlike repel, when a magnet like the magnetic compass is placed on Earth's surface, it tends to obey this law. Therefore the North Pole will always point away from the Earth's magnetic North. This concept is what causes the pointer of the magnetic compass to settle in a direction that is always south of the Earth's magnetic North pole. As such, the magnetic compass can be used to tell the direction where one is going or coming from.
- Let learners write summary notes as you explain the concepts above.

### **Synthesis**

This lesson is about magnetic compass and its uses. Using the practical activity suggested, guide learners to make their own magnetic compass and compare its working with that of a manufactured magnetic compass. They should then predict the use of the magnetic compass based on the fact that the earth being a being a huge magnet, obeys the magnetic laws.

### **Lesson assessment**

Assess whether the learning objectives of the lesson were met by asking questions such as:

1. What is magnetic compass?  
(Ans: An instrument or a device that uses magnetized steel bar to indicate direction relative to the Earth's magnetic poles)
2. How is magnetic compass useful to us?  
(Ans: To tell direction)

## Lesson 6: Uses of magnets

Refer to learner's book pages 305

### Specific objectives

By the end of the lesson, learners should be able to list some uses of magnets in everyday objects.

### Preparation for the lesson

1. This lesson will involve discussion activity and a case study. You will therefore organize the class as need arises during the lesson.  
**REMEMBER:** When grouping learners, you should consider the different abilities of learners and the special needs for various individuals.
2. Collect materials required to perform the various practical case study.

### Teaching aids

- Bar or horseshoe magnet, a piece of needle or pin, sand, grass.
- Textbooks on uses of magnets.
- Computers with internet connection.

### Pre-requisite of the lesson

You may begin the lesson by asking learners to name some objects that they know where magnets are used. The most common one is usually the speaker of which they are likely to name.

### Synthesis

This lesson is about uses of magnets. Using the talking point and the case study suggested, guide learners to discover uses of magnets, among them use in finding lost items and separating substances. Also, show learners devices that we use in our daily lives such as speakers, microphones, Radios, DVDs and TVs that use magnets. Also emphasise the fact that electromagnets are very important in lifting heavy items especially at the port.

### Lesson assessment

Assess whether the learning objectives of the lesson were met by asking questions such as:

1. Why is it more appropriate to use a magnet to separate iron fillings from flour?

(Ans: Because it will attract all the iron fillings living behind pure flour)

2. Name some items that you know which use magnets.

(Ans: TV, Radio, speakers, microphones, etc)

3. Why are electromagnets more useful than permanent magnets when carrying heavy loads?

(Ans: They can pick and release the load as required – they are temporary magnets)

### Answers to Self-Test 15.1

Refer to learner's book page 300

1. Nail, pin, needle, spoon, metallic plates, hoe among others.
2. Using a magnet – to attract iron fillings leaving behind salt or sugar.
3. TV, DVD, refrigerator, electric cooker, electric iron, radio, etc.
4. By rubbing a biro pen case or comb on hair, it creates charges which attract pieces of paper.

### Answers to Self-Test 15.2

Refer to learner's book page 306

1. Area around a magnet where magnetic force is experienced.
2. To tell direction

3.

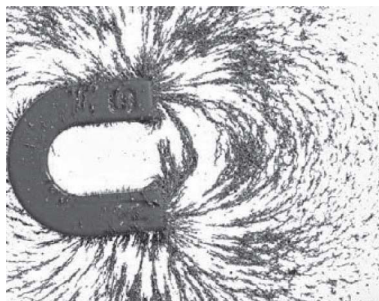

4. Fridge, TV, radio, hand bags, wallets, DVD, Microphone, etc

### Summary of the unit

This unit deals with magnets and their applications. You therefore should effectively use the practical activities and the suggested teaching approaches in the teacher's book to guide learners acquire the requisite knowledge and desired competences in these areas. At the end of the lessons, you should assess the extent to which the competencies have been achieved and attitude change towards responsible use and disposal of devices made of magnets as a way of conserving our environment. Plan remedial activities where necessary for slow learners and give extra activities for gifted ones as well. Also, emphasize the fact that taking this unit seriously may lead to careers such as engineering and becoming technicians of devices such as fridges, mobile phones, computers among others that use magnets.

### Additional information for the teacher

Some information that you may find relevant in this topic are given below.

### Origin of magnetism

The people of Magnesia in Asia Minor observed that certain kinds of naturally occurring ores possessed an iron-attracting property. The ore was discovered near the city of Magnesia and hence it was named Magnetite. Huge lumps of magnetite were often called lodestone meaning “leading” stone or natural magnet. Chemically lodestone consists of iron oxide. Dr. William Gilbert (1540-1603) did a lot of work with the natural magnets. He published a book called *De magnete* in 1600 in which he gave an account of his research into the magnets and their properties.

### Identification of the poles of a magnet

In order to identify the poles of a magnet, the ends are usually painted in different colours. For example, the N-pole is painted red while the S-pole is painted blue. In other cases the whole bar is painted red with a white dot or spot on one end to identify the north pole. Also, letters ‘N’ and ‘S’ are used to identify North and South poles respectively.

### Testing polarity of magnets

To do this, freely suspend a bar magnet.

Bring the two poles of the magnet in turn close to a nail placed on a table. Record your observations. Repeat the procedure, using a second bar magnet instead of the nail.

*Fig. 15.1 Magnet attracting nails*

We observe that there is attraction when the south and north pole of the suspended magnet is brought near the nail. When the second bar magnet is

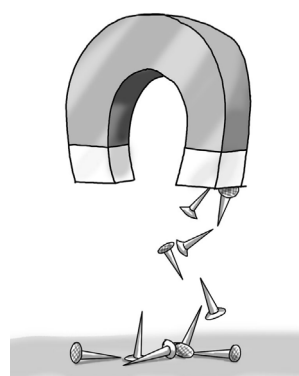

used, both attraction and repulsion are observed. We can conclude that there is always an attraction between a magnet and a magnetic material or between the unlike poles of different magnets. But there is always **repulsion** between two like poles of a magnet. Repulsion is therefore, the only sure way of testing for polarity of a magnet. However, the poles of the suspended magnet must be known first.

### Making magnets (Magnetisation)

In the second century A.D, Chinese found a method of making magnets by

rubbing pieces of common iron against lodestone. Nowadays, magnets are made using various methods. Some of these methods include:

- Stroking or touching method
- Electric method
- Hammering and
- Induction method

**(a) Stroking method**

This can be single or double stroking.

*(i) Single stroking*

Here, a piece of steel e.g. steel needle is placed near a magnet and it becomes magnetised. However, the magnetism acquired usually disappears quickly when the magnet is removed ( temporary magnet).

*Fig. 15.2 Single stroking*

Place the steel needle on the bench. Stroke the steel needle with the south pole of a bar magnet along the whole length of the steel needle. Once at the

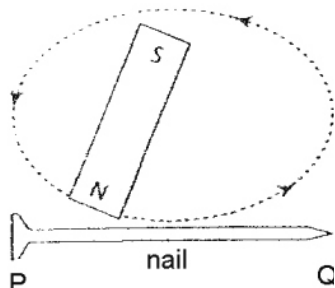

end, lift the magnet well away from the steel needle i.e. make a wide sweep as shown in Fig. above. Repeat the process several times (50 times). Test the polarity of the steel needle by the repulsion method. It is observed that the steel needle becomes magnetised with end B becoming a S-pole and end A becoming a N-pole. Note that the end of the magnetic material last touched by the magnet acquires a polarity opposite to the one touching it.

*(ii) Double stroking*

Stroke a steel needle using two magnets as shown in Fig. 15.3 below. The stroking should begin at the middle of the steel needle each time making sure that the two bar magnets are lifted far away from the steel needle once you reach the ends.

*Fig. 15.3 Double stroking*

Test for the polarity at the end of the needle. It is observed that end C

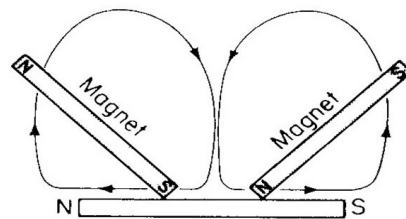

becomes a N-pole while end D becomes

a S-pole. The double stroke method is also called the divided stroke method.

### (b) **Electrical method**

Using a wire wind a number of turns round a hollow rod. This is called a **solenoid**. Place a steel knitting needle and pass a direct current (DC) through the turns of the solenoid as shown in Fig. 15.4. Switch off the current and remove the needle. Test for polarity of the needle. Repeat the experiment but with the electric current direction reversed. Test for polarity of the needle.

Fig. 15.4 Making a magnet by electrical method.

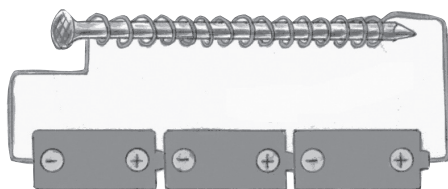

It is observed that the polarity of the magnet produced depends on the direction of the electric current.

### (c) **Hammering**

Hammer one end of a steel bar fixed in north-south direction several times.

Fig. 15.5 To make a magnet by hammering



The steel bar becomes a weak magnet. The lower end becomes a weak north pole for countries in the northern hemisphere and a south pole for countries in the southern hemisphere. In this method the influence of earth's magnetic field is used to magnetise the steel bar being hammered.

### (d) **Magnetisation by induction**

Place a magnet near an unmagnetised steel pin and note what happens. The pin is attracted by the bar magnet. Bring another pin next to the first pin and note what happens. The second pin is attracted to the first pin (Fig. 15.6 (a))

Fig. 15.6 To make a magnet by induction

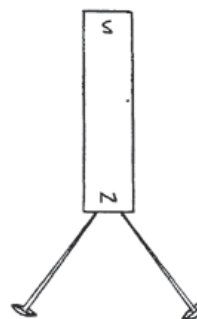

The first pin becomes magnetised by

the magnet through a process called induction and then gets attracted to the magnet. The second pin gets magnetised by the first pin through the same process. Separate the first pin from the magnet and note what happens to the second pin. It is observed that the second pin falls off. This shows that it is the presence of the bar magnet that sustains the magnetism between the first and second pin. Repeat the experiment using two pins placed side by side. Introduce a north pole between the two pins and observe what happens. The two pins separate further when a north pole is placed in between them (Fig. 1.14 (b)). This shows that the induced pole nearest to the magnet is of opposite polarity to that of the inducing magnet.

### Demagnetisation

Demagnetisation is the process through which magnets lose their magnetism. The process may be achieved through a number of methods. Some of the methods are discussed below.

### Hammering

Hammering a magnetised material placed in the East-West direction or dropping it violently on the hard floor several times makes it lose most of its magnetism.

### Heating

Heating a magnetised material until red hot and cooling it suddenly when resting in East-West direction makes it lose its magnetism.

### Electrical method

Placing a magnetised needle in a coil placed in East-West direction and passing an alternating current (A.C) demagnetises the needle.

### Domain theory of magnetism

The domain theory of magnetism developed by a scientist called Wilhelm Weber helps to explain the phenomenon of magnetism.

Magnetise a steel bar using any of the methods described earlier. Cut the magnetised bar into two halves. Test the polarities of the ends of each half.

Cut one of the halves into two halves and again test the polarities.



Fig. 15.7 Effects of cutting bar magnet into small pieces

Continue cutting one piece until you are not able to cut it any more. Each time test the polarity of the halves (Fig. 15.7). The polarity test for the first halves

shows that each piece is a magnet in its own right. Further cutting of the pieces still yields a smaller magnet. The smallest portion of any matter is a molecule. Thus if we were able to cut the magnet further we would see that the smallest magnet would be a molecule.

In ferromagnetic materials, these molecular magnets also called dipoles (because of the two poles) occupy tiny regions called **domains** within a magnet. The magnetism of each domain is aligned. However, different domains point in different and random directions as shown below.

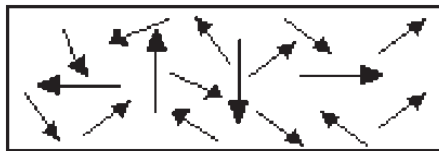

Fig. 15.8 Unmagnetised material

The domain theory may be used to explain the processes of magnetization and demagnetisation.

### **Magnetisation**

Since the domains are aligned in all possible directions in an unmagnetised material (Fig. 15.8), the net magnetism in the material is zero. In a partially magnetised material the domains align themselves as shown in Fig. 15.9 (a). Notice that the domains in Fig. 15.8 and

15.9 (a) are not all aligned in the same direction. When the material is fully magnetised the domain walls move and the molecular magnets align themselves in one particular direction as shown in Fig. 15.9 (b).

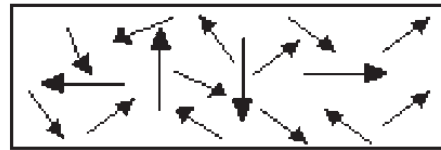

Fig. 15.9 (a) Unmagnetised material

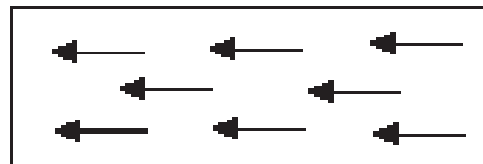

Fig. 15.9 (b) Magnetised material

A ferromagnetic material is said to be magnetically saturated when the walls are swept out and the molecular magnets point in the same direction.

A resultant north pole is produced at one end and a south pole at the other end as shown in Fig. 15.9 (b).

### **Demagnetisation**

The walls of the domain slowly return to their original state with time as this is a more stable state; hence the material becomes **demagnetised**. This kind of demagnetisation is called self-demagnetisation. This is due to the



poles at the end, which tend to reverse the direction of the molecular magnets. The demagnetisation process can also be influenced externally by giving the molecular magnets enough energy to overcome the forces holding them in a particular direction. The energy may be provided by heating, hammering or dropping on a hard surface or by using an alternating current.

### Storage and uses of magnets

A bar magnet loses its magnetism with time due to self-demagnetisation. The process of self-demagnetisation starts at the ends of a magnet in which the free like poles repel each other and slowly upsetting the alignment of the molecular magnet inside it. To minimise this, soft iron bars called keepers are placed across their ends as shown in Fig. 15.10

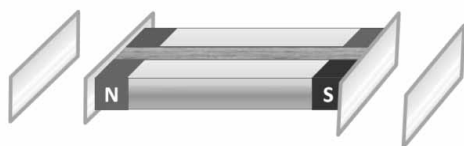

Fig. 15.10 Keepers for storing magnets

This way, the dipoles find themselves in a closed chain or loops round the magnet and the keepers, with no free poles, available to upset the domains.

The soft iron keepers are used since they are easily magnetised by induction.

### The earth's magnetic field

When a bar magnet is suspended freely, it comes to rest in N-S direction. This is as if it is trying to align itself with a certain magnetic field. It is believed that this alignment of the bar magnet is due to the magnetic field due to the earth. The earth is considered to behave as if it contains a bar magnet positioned at its centre.

### Answers to Unit Test 15 (pupil's book page 307)

1. A term used to refer to a property associated with magnets, which causes attraction or repulsion of substances that are magnetic.
- 2.

Magnetic materials	Non magnetic materials
Iron	Paper
Steel	Cork
Nails	Wood
Pins	Plastic
Needle	Ceramic
Paper clips	Pieces of cloth

3.

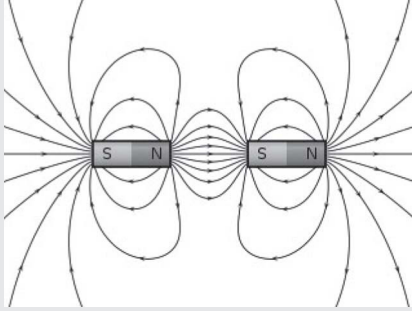

4. Temporary magnets lose magnetism when taken away from magnetic field or when power is disconnected in an electromagnet, permanent magnets do not lose their magnetic properties whatsoever unless the magnet is physically destroyed.
5. Magnetic materials or metals that that can be attracted by a magnet. Examples include iron, nickel, cobalt or naturally occurring magnetic materials such as magnetite or lodestone.
6. B
7. B
8. Ask learners to first write down how they will do it then go ahead

and make a magnet. The magnet is made by stroking a magnetic metal on a bar magnet several times (50 times) only in one direction. The speed should be that of striking a matchstick. The parent or guardian should be advised to follow up and ensure the learner has made the magnet.

9. Have two poles (North and South pole), like poles attract while unlike poles repel, attract magnetic materials but not non magnetic materials, when suspended, they rest with their south pole settling in the Earth's magnetic north pole direction,
10. Magnetite or lodestone
11. When separating mixtures of magnetic and non magnetic substances, in finding lost magnetic items, in telling direction (magnetic compass), etc.

## Additional activities to cater for intellectually challenged and gifted learners

Remedial activities for intellectually challenged learners	Extended activities for gifted and talented learners
<ol style="list-style-type: none"> <li>1. Collecting, observing and drawing the various types of magnets in their note books.</li> <li>2. Collect various materials/objects at home. Test for magnetism using a magnet. Classify the things either as magnetic or non-magnetic.</li> <li>3. Collect old speakers, microphones, bags, wallets. Search for magnets in them. Remove the magnets and test whether they are working using magnetic materials such as nail or pins.</li> </ol>	<ol style="list-style-type: none"> <li>1. Do further research in textbooks or the internet about why magnets behave the way they do. Write short notes then share with other class members.</li> <li>2. Break a magnet into smaller pieces with hammer by hitting hard. Test the pieces for magnetic properties. Research about the results of this experiment and come up with summary notes.</li> <li>3. Think of a project on making a device using magnets based on daily activities either at home or in school. Assemble locally available materials and make the item.</li> </ol>
Remedial questions for intellectually challenged learners	Extended questions for gifted learners
<ol style="list-style-type: none"> <li>1. How would you differentiate magnetic from non-magnetic substances?</li> <li>2. Look around you. List some magnetic materials that you can see.</li> <li>3. Like charges attract while unlike charges repel. True or false? ——— —————</li> <li>4. What is a magnet?</li> </ol>	<ol style="list-style-type: none"> <li>1. Explain why it is possible to tell direction using a magnetic compass.</li> <li>2. How are magnets used in a               <ol style="list-style-type: none"> <li>(a) Speaker?</li> <li>(b) Refrigerator?</li> </ol> </li> <li>3. Explain why electromagnets are used in lifting of heavy machinery at the port.</li> </ol>

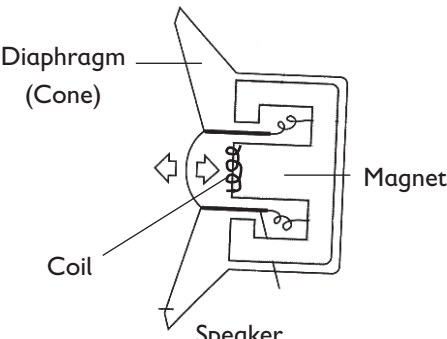
Answers to remedial questions	Answers to extended questions
<ol style="list-style-type: none"> <li>1. By bringing a magnet close to the item. If it attracts, it is magnetic; if it doesn't, it is not.</li> <li>2. Magnetic: Nail, pin, paper clip, door handle. Non magnetic – wooden chair/table, biro pen case, book, etc)</li> <li>3. False</li> <li>4. An object/item that produces a special type of force, which either attracts or repels certain materials.</li> </ol>	<ol style="list-style-type: none"> <li>1. The Earth has magnetic materials at its core. As such, it is kind of a huge magnet. Being a magnet, it has North and South poles. When a magnetic compass is placed on the Earth's surface. Its North pole is repelled by the Earth's magnetic North pole. Therefore, the north pole of the magnetic compass always settles southwards. Using this knowledge, we can drop a magnetic compass and look at the pointer. Where it points is the south of the earth hence we can use that information to tell the direction where we are going or coming from.</li> <li>2. (a) A speaker converts electrical signals into sound energy. By moving the cone back and forth, the speaker increases and decreases the air pressure in front of it thus creating sound waves. Below is a basic diagram of a speaker. <div style="text-align: center;">  </div> </li> </ol>

When a fluctuating electric current (from the sound system such as radio or TV) flows through the coil, it becomes a temporary electromagnet, attracted and repelled by the permanent magnet. As the coil moves, it moves the cone back and forth, pumping soundwaves into the air. That is how we get to hear the sound.

(b). In the doors to keep the doors locked.

3. Huge magnets are very powerful hence can be used to lift heavy loads. Additionally, electromagnets are made from magnetic cores and coilings, which use electricity. It is therefore possible to determine what amount of force is generated or even manipulate the amount of force generated, plus it can be switched on to lift the load and switched off to drop it once the point of offloading is reached.

**Refer to the Learner's Book pages 308 - 320**

### Key unit competency

After studying this unit the learner should be able to demonstrate and explain changes of state of matter.

### Learning objectives

Competency based curriculum embraces three categories of learning objectives, that is, knowledge and understanding,

skills acquisition and attitude and values. At the end of the unit, learners should have knowledge and understanding of states of matter and have the right attitude towards applications of states of matter.

**Table 16.1 Knowledge, skills and values to be attained**

Knowledge and understanding	Skills	Attitudes and values
<p>By the end of this unit, learners should be able to:</p> <ul style="list-style-type: none"> <li><input type="checkbox"/> By the end of this unit the learner should be able to define the matter.</li> <li><input type="checkbox"/> Identify the three states of matter (solid, liquid, gas) in terms of shape and volume.</li> <li><input type="checkbox"/> Identify three interchangeable states of water.</li> <li><input type="checkbox"/> State how water changes from one state to another.</li> <li><input type="checkbox"/> State the melting point of ice, the freezing point of water and boiling point of water.</li> <li><input type="checkbox"/> Explain the roles of evaporation and condensation in the water cycle.</li> </ul>	<p>By the end of this unit, learners should be able to:</p> <ul style="list-style-type: none"> <li><input type="checkbox"/> Observe and compare different objectives/matter in different states.</li> <li><input type="checkbox"/> To use apparatus and equipment properly.</li> <li><input type="checkbox"/> Predict the effect of heat/cooling water on its physical appearance.</li> <li><input type="checkbox"/> Investigate the effect of heat gain or loss on the temperature and state of water and communicate findings.</li> <li><input type="checkbox"/> Recognize the changes in the water cycle.</li> </ul>	<p>By the end of this unit, learners should be able to:</p> <ul style="list-style-type: none"> <li><input type="checkbox"/> Show curiosity in exploring matter in the surroundings and questions on what they show concern for water as a limited natural resources and the need for water conservation.</li> </ul>

## Pre-requisite of this unit

This is a new area although learners have already interacted with solids, liquids and gases in their lives. Let them understand that in this unit, they will be introduced to the definition of matter, the various forms of matter and the process that take place when matter is transformed from one state to another. During the lessons, strive to bring to the awareness of learners the fact that this topic is related to states of matter in Chemistry and Physics. Let learners understand that at this level, they may only need the basic information otherwise; details of states of matter, its applications and usage will be taught in Chemistry and Physics at higher levels of education.

### Background information

This topic deals with states of matter and the inter-conversions from one state of matter to the other. Emphasise the three states that is solids, liquids and gases and narrow down to water and state its three forms. You will also explain the various processes that are involved when matter changes from one state to another and the role of these processes in water cycle.

### Cross-cutting issues to be addressed

#### 1. Gender education

Both boys and girls should participate equally in the activities in this unit.

#### 2. Inclusive education

All learners should be encouraged to participate during lessons

and practical activities. Special arrangement should be made to take care of learners with special needs. For example, provide brail for blind learners, large print text for those with sight problems and allocate physically challenged learners to others to assist them during field trips and practical activities. Further, physically challenged learners should be given tasks that they can manage during the practical sessions.

#### 3. Financial education

Emphasize the need to conserve water by using it sparingly and only when absolutely necessary. This way, water bills will be reduced and the authorities will reduce expenses on treating large volumes of water for domestic consumption.

#### 4. Environment and sustainability education

Bring to the attention of learners the fact that they should **ALWAYS** avoid water pollution.

### Generic competences

#### 1. Co-operation and interpersonal management and life skills

During group discussions and group interactions - let learners engage one another by giving a chance for all to participate. Also, during group presentations - you can allow rotational presentations within the group members. Gifted learners should help in coming up

with presentation content as slow learners contribute.

**REMEMBER** – You should allow slow learners to do presentations as well and correct them where they go wrong. Advise learners to appreciate the different abilities of their group members and accommodate each other's views.

## 2. Research skills

Guide learners on how to find information regarding various topics such as the meaning of the word 'transformation' and the various processes involved in change of state. Guide learners on how to come up with summarized notes from a large body of text. You should also guide learners on how to do Internet searches for the various content areas they are looking for.

## 3. Communication in English

Communication in English will be improved when learners freely participate in the discussions and presentations. Encourage all learners irrespective of their abilities to participate in group discussions, during presentations by asking questions and during question and answer sessions to either introduce or wrap up the lessons.

## 4. Critical thinking and problem solving skills

This competence will be developed by learners as they answer the probing questions such as those on page 308 at the beginning of this

unit and as they discuss the results of the various practical activities. Guide learners to discover for themselves what causes things to flow and others not to flow, things to compress and others not to compress, among others. This competence will also come about as learners think about their findings in the activities and as they give out their suggestions on why this is the case.

### Key words in this unit and their meanings

- **Condensation** – Change of state from gas to liquid as a result of reduction in temperature.
- **Deposition** – Direct change from gaseous state to solid state. It is the opposite of sublimation.
- **Eureka can** – A container used to determine the volume of an irregular object such as a stone done by measuring the volume of liquid displaced.
- **Evaporation** – Change of state from solid to liquid as a result of increase in temperature.
- **Freezing** – Change of state from liquid to solid by reducing temperature.
- **Mass** – The amount of matter in a body.
- **Matter** – Anything that occupies space and has weight.
- **Melting** – Change of state from solid to liquid as a result of increase in temperature.



- **Transpiration** – The process by which plants lose water in form of water vapour to the atmosphere through the leaves.
- **Transformation** – this is a term that refers to changing something completely from one form into another.
- **Sublimation** – Direct change from solid to gaseous form without undergoing liquid state.
- **Surface run-off** – Water that flows on the Earth's surface after it has rained, often due to the fact that enough water has infiltrated the soil such that it cannot accommodate more.

- **Weight** – The force experienced by a body due to gravitational pull.

### Guidance on the problem statement

This topic is about states of matter and the various processes involved during change of state. As a way of introducing the concepts, It is about a father who has medicine from hospital and he is supposed to use pure water to dissolve the medicine before he gives his son. They are stranded on how to get pure water. Learners should brainstorm about how pure water can locally be made at home. An easy way of making pure water is shown below.

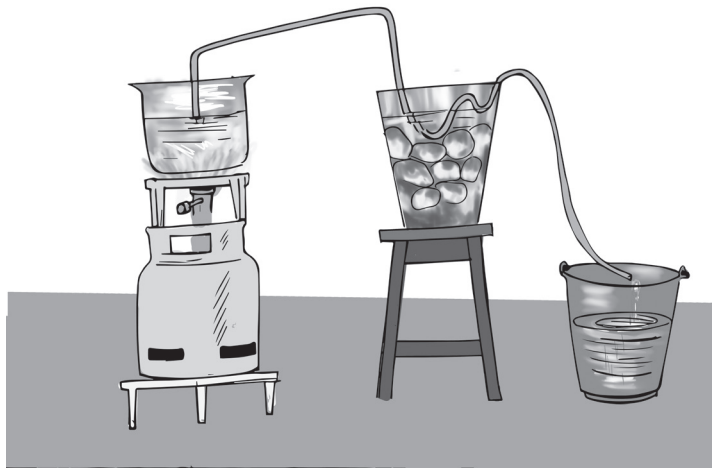

In the diagram, pure water is being obtained by heating water using gas then directing the vapour through a pipe to a bucket of ice. The ice helps to cool the vapour which is then collected in another clean bucket. This water is pure enough and can be used to dilute the medicine.

## Attention to special educational needs

Support for Multi-ability learning	Support for special needs learning
<ul style="list-style-type: none"><li>– Gifted learners to be given heavy tasks requiring more critical thinking while slow learners are given tasks, which they can manage such as collecting materials for use during practicals among others.</li><li>– Both gifted and slow learners to be given equal opportunity to lead in group discussions and to do presentations of group findings to the rest of the class.</li><li>– Ensure all learners respect other's views irrespective of their shortcomings or talents.</li></ul>	<ul style="list-style-type: none"><li>– Allocate gifted learners to help fellow learners with special needs.</li><li>– Provide brail for blind learners and large print text to learners with seeing difficulties. Provide sign language alphabet symbols and sign language interpreters for the deaf.</li><li>– Also, arrange learners such that shortsighted ones are at the front and long-sighted ones are at the back. Spectacles can as well be provided if available for learners with seeing difficulties.</li></ul>

### List of lessons

Lesson No.	Lesson title	No. of periods
1.	Definition of matter	2
2.	The three states of matter	2
3.	Change of state of water	2
4.	The water cycle verses change of state	2
5.	The transformation of states of matter	2

### Lesson 1: Definition of matter

Refer to learner's book pages 308

#### Specific objectives

By the end of the lesson, learners should be able to define matter.

### Preparation for the lesson

1. This lesson will involve individual research work and group activities. You will therefore organize the class as need arises during the lesson. **REMEMBER:** When grouping learners, you should consider the different abilities of learners and the special needs for various individuals.

2. Ensure the Internet is working properly before the lesson for learners to use to do research.
3. Collect or instruct learners to bring the various items to be used during the practical session i.e. balloons, stick, Eureka can, measuring cylinder, stone, bottle of water; among others.

### Teaching aids

- Items for use during practicals such as balloons, stick, eureka can, measuring cylinder, stone, bottle of water, among others
- Computers connected to the internet

### Pre-requisite of the lesson

Introduce the unit as explained under **guidance on the problem statement** above then narrow down to this lesson.

### Teaching / learning activities

- You may begin the lesson by asking learners probing questions such as: Have you ever heard of the word 'matter'? What does it mean?

### Activity 16.1 (Refer to Pupil's book pages 308)

- Put learners in groups of four or any other number depending on the class size. Let them carry out the activities listed in this practical activity.
- Let them make their observations and record them in their note books.
- Guide the learners to discover the meaning of the word matter by discussing the results of above

experiments.

- Emphasise the fact that matter is anything that occupies space and has volume. Prove the fact that this is the case by citing the results of the experiments in this activity.

### Synthesis

This lesson introduces learners to the concept of matter. Learners should discover what the term means and by performing the suggested practical activities as you guide them. Help them discover the fact that matter occupies space and has weight.

### Lesson assessment

Assess whether the learning objectives of the lesson was met by asking questions such as:

1. The fact that a stone has weight shows that is an example of \_\_\_\_\_?  
(Ans: matter)
2. Blowing air into a balloon makes it expand. This shows that air has \_\_\_\_\_  
(Ans: volume)
3. Based on your answers to Questions 1) and 2) above, define matter.  
(Ans: Anything that occupies space and has weight)

## 16.2 The three states of matter

Refer to learner's book pages 310

### Specific objectives

By the end of the lesson, learners should

be able to identify the three states matter.

### Preparation for the lesson

1. This lesson will involve individual research work and group activities, pair work and class presentations. You will therefore organize the class as need arises during the lesson.  
**REMEMBER:** When grouping learners, you should consider the different abilities of learners and the special needs for various individuals.
2. Ensure the Internet is working properly before the lesson for learners to use to do research.
3. Collect or instruct learners to bring the various items to be used during the practical session i.e. water, juice, stone, pieces of wood, cooking oil, book, milk, methylated spirit, inflated balloon, among others

### Teaching aids

- Water in a container, juice, stone, pieces of wood, cooking oil, book, milk, methylated spirit, inflated balloon, among others.
- Textbooks in the library and charts on states of matter.
- Computers connected to the internet

### Pre-requisite of the lesson

- You may begin the lesson by

reminding learners what they were taught in the previous lesson. Let volunteers give the meaning of matter. You can then ask learners whether they think matter exists in only one state or more than one state.

### Teaching / learning activities

#### Activity 16.2 (Refer to Pupil's book pages 310-311)

- Put learners in pairs then let them carry out the activities listed in this practical activity. You can also use groups of varied numbers depending on the size of the class. Let them pour, compress and feel the various items as they make observations.
- Let them record their findings in their notebooks. They can do it in a table format as shown in their books page 311.
- Guide the learners to discover the differences between the various states of matter. They should try to group them based on the characteristics that they have observed.
- Let them do research on the characteristics of the various states of matter. They should then compare their findings to the characteristics that they earlier wrote down.
- Guide them to make conclusions about the three states of matter i.e. solids, liquids and gases.
- Emphasise the fact that the particles in the three states of matter are

organised differently hence the observed characteristics. Show learners the pictures in Fig. 16.2 page 311-312 of their books to help them differentiate between the three states.

- Wind up the lesson by highlighting the characteristics of the three states of matter as they write summary notes.

### Synthesis

Guide learners to discover the characteristics of the three states of matter by performing the suggested practical activities and the pictures in charts or the pupil's book. Emphasise the fact that the way particles are arranged causes the difference in properties. You can demonstrate this using marbles placed in a closed container; full for solids,  $\frac{3}{4}$  for liquids and  $\frac{1}{4}$  for gases. Shake the container and let learners note the behavior of the marbles then compare with the characteristics of each state of matter.

### Lesson assessment

Assess whether the learning objectives of the lesson was met by asking questions such as:

1. Which of these have definite shape? Solids, liquids, gases? \_\_\_\_\_?  
(Ans: Solids)
2. Which of these can flow? Solids, liquids, gases? \_\_\_\_\_  
(Ans: Liquids and gases)
3. The particles in a gas are \_\_\_\_\_  
(near one another, far apart).

(Ans: Far apart)

4. Draw a diagram to illustrate arrangement of particles in a solid.

(Ans: Fig. 16.2 (a) page 311 of pupils book)

### Lesson 3: Change of state of water

Refer to learner's book pages 312

### Specific objectives

By the end of the lesson, learners should be able to:

- Identify the three interchangeable states of water.
- State how water changes from one state to another.
- State the melting point of ice (freezing point of water) and the boiling point of water.

### Preparation for the lesson

1. This lesson will involve an experiment to investigate the physical changes in water and coming up with melting and boiling point of water. You will therefore organize the class to enable demonstration on the same. **REMEMBER:** When grouping learners, you should consider the different abilities of learners and the special needs for various individuals.
2. Ensure the Internet is working properly before the lesson for learners to use to do research.

3. Collect or instruct learners to bring the various items to be used during the practical session i.e. water, freezer, bucket of ice, clock, source of heat, tin with lid, transparent beaker, thermometer, test tubes, among others

### Teaching aids

- Water in a container, freezer, bucket of ice, clock, source of heat, tin with lid, transparent beaker, thermometer, test tubes, among others
- Textbooks in the library and charts on states of matter
- Computers connected to the internet

### Pre-requisite of the lesson

- You may begin the lesson by reminding learners what they did in Activity 16.3. In this activity, learners discovered the fact that water occurs in three states. Let them name these three states.
- Build on this and ask learners to say whether they think it is possible to convert water from one state to another.
- At this point, introduce Activity 16.3 pages 312-313 of pupil's book.

### Teaching / learning activities

#### Activity 16.3 (Refer to Pupil's book pages 312)

- This can be a class demonstration or alternatively, if you have enough

equipment, put learners in groups of manageable sizes to carry out the activity. Let them carry out the activities listed in this experiment.

- They should heat some water and allow it to cool then observe the underside of the container on top with cold water in it or lid. Help learners to draw a conclusion about this.
- In the same manner, allow learners to heat some ice then observe and record what happens. Guide them to interpret the observations.
- Next, guide learners in finding out the melting point of ice and boiling point of water. Heat ice and water respectively with thermometer immersed in it. Let them record the temperature at which the ice melts and the water boils.
- Guide learners to answer the study questions in this activity.
- Summarise the lesson by guiding learners to discover the meaning of melting, evaporation, condensation and freezing. Stress the fact that melting point of ice is the same as freezing point of water. Help them come up with a chart like the one shown in Fig. 16.3 page 314 of pupils book.
- Emphasise the fact that pure water boils at 100°C and ice melts at 0°C

under standard conditions.

- Wrap up the topic by highlighting the main points as learners write summary notes.

### Synthesis

This lesson will involve a demonstration on heating and cooling water and ice. Using the demonstration or group activities, guide learners to discover what happens when water is heated or cooled and when ice is heated. Use the results of the experiment to guide learners in discovering the difference between melting and evaporation and freezing and condensation. Emphasise the fact that ice melts at a particular temperature and likewise, water boils at a particular temperature. These are the melting point and boiling point respectively. Reinforce this concept by asking learners the temperatures they noted during the activity.

### Lesson assessment

Assess whether the learning objectives of the lesson was met by asking questions such as:

1. When you heat ice it \_\_\_\_\_ into water and when you heat water, it \_\_\_\_\_ into water vapour. (Ans: melts, evaporates)
2. Choose the correct word for these descriptions: Freezing, condensation
  - (a) Change from steam to water \_\_\_\_\_ (Ans: condensation)

(b) Change from water to ice \_\_\_\_\_ (Ans: freezing)

3. What is the melting point of water? \_\_\_\_\_ (Ans: 0° C)
4. What is the boiling point of water? \_\_\_\_\_ (Ans: 100° C)

### Lesson 4: The water cycle and change of state of water

Refer to learner's book pages 315

#### Specific objectives

By the end of the lesson, learners should be able to explain the roles of evaporation and condensation in the water cycle.

#### Preparation for the lesson

1. This lesson will mainly involve group discussion on water cycle. You will therefore organize the class manageable groups based on the size of the class. **REMEMBER:** When grouping learners, you should consider the different abilities of learners and the special needs for various individuals.
2. Ensure the Internet is working properly before the lesson for learners to use to do research.
3. Prepare charts for use during the lesson

**IMPROVISATION** You may draw a chart on water cycle in manila paper for use in class in case you do not have a chart on water cycle.

### Teaching aids

- Chart on water cycle or the Fig. on page 315 of pupil's book
- Textbooks in the library
- Computers connected to the internet

### Pre-requisite of the lesson

- You may begin this lesson by asking learners whether they know how rain comes about. Let them have a brainstorming session on how rain is formed.
- Build on this and ask learners to carry out the discussion

### Teaching / learning activities

#### Talking point

- Put learners into groups depending on the class size and their abilities.
- Provide learners with a chart on the water cycle. Alternatively, let them study the picture on page 315 with their friends in the group.
- Guide learners to discover what is happening in the various processes in the diagram. You may remind them of the outcomes in Activity 16.3. You may also repeat this activity as well.
- Explain the processes A, B and C which are - evaporation, transpiration

and condensation respectively. Let learners understand that after condensation of water vapour in the sky, clouds are formed which later precipitate into drops of rain.

- Let learners understand that when it rains, some water goes to water bodies, others are absorbed into the soil while others form surface run-offs.
- You may then wind up the topic by highlighting the main points about water cycle as learners write summary notes.

### Synthesis

This lesson is about the various processes involved in change of states of water. Use previous knowledge learnt and link it up with the discussion results of the talking point on page 315 of the pupil's book to guide learners understand the concept of water cycle. Emphasize the main processes in the water cycle, that is, evaporation, transpiration and condensation. Further, reinforce the importance of conserving water as a cross-cutting issue.

### Lesson assessment

Assess whether the learning objectives of the lesson was met by asking questions such as:

1. Where does water come from? (Ans: condensation of water vapour in the atmosphere)
2. Name two process that lead to formation of water vapour in the atmosphere. (Ans: Evaporation from



*water bodies, transpiration)*

3. What is precipitation? \_\_\_\_\_  
(Ans: the process by which rain drops are formed from clouds)
4. \_\_\_\_\_ refers to water that runs on earth surface as a result of lack of infiltration of wrain water into the soil. (Ans: Surface runoff)

### Lesson 5: Change of state of water

Refer to learner's book pages 316

#### Specific objectives

By the end of the lesson, learners should be able to describe the transformation of the various states of matter

#### Preparation for the lesson

1. This lesson will involve both individual research activity and a classroom demonstration on what happens when naphthalene is heated. You will therefore organize the class to enable demonstration and individual research. REMEMBER: When grouping learners, you should consider the different abilities of learners and the special needs for various individuals.
2. Ensure the Internet is working properly before the lesson for leaners to use to do research.

3. Collect the various items necessary for this practical activity that is naphthalene solid, iodine, transparent tin with lid, bottle top and a source of heat.

#### Teaching aids

- Naphthalene solid, iodine, transparent tin with lid, bottle top and a source of heat
- Textbooks in the library
- Computers connected to the internet

#### Pre-requisite of the lesson

- You may begin by asking the learners if they know what the word transformation means. Let them brainstorm what it means.

#### Teaching / learning activities

##### Find out (Refer to Pupil's book page 316)

- Build on the brainstorming task above and ask learners to carry out the research activity.
- Let them write down a report and share with other members of the class.
- At this point, you can explain the meaning of the word transformation and relate it to what happened to the water in Activity 16.5.
- Let learners understand that other substances can undergo similar transformations.

### Activity 16.5 (Refer to Pupil's book page 316)

- Put learners in various groups depending on class size then demonstrate what happens when naphthalene and iodine solids are heated and cooled.
- Let learners observe and record what happens.
- You can then clarify the fact that some solids change directly to gaseous state when heated while when cooled, they also change directly to solid state. Give iodine and naphthalene in this experiment as examples.
- At this point, you can explain the difference between sublimation and deposition. Refer to pupil's book page 316.
- Remind learners about activity 16.3 where they heated water and ice. Let them say what they observed. You can also carry out this activity here again. Ask them the processes involved.
- From the activity above, learners should list evaporation and melting and condensation and freezing as some of the processes involved.
- Combine the content above and what has been learnt in this activity and summarize the various changes of state that occur in substances. Refer to Fig.16.4 in pupil's book page 361.

- Wrap up the topic by highlighting the main points as learners write summary notes.

### Synthesis

This lesson will involve a demonstration on heating and cooling iodine and naphthalene. Using the demonstration together with content learnt in Activity 16.3, guide learners to understand the various processes that are involved in change of state of substances. Emphasise what sublimation and deposition are in addition to melting, evaporation, condensation and freezing. Reinforce this concept by asking learners to think about substances that undergo the above process.

### Lesson assessment

Assess whether the learning objectives of the lesson was met by asking questions such as:

1. \_\_\_ is changing something completely from one state to another.  
(Ans: Transformation)
2. Distinguish between sublimation and deposition.  
(Ans: Sublimation – direct change from solid to gas on heating; deposition – direct change from gas to solid on cooling)
3. Describe what happens when iodine solid is heated.  
(Ans: Changes directly to purple vapour)

### **Answers to Self-Test 16.1**

*Refer to learner's book page 315*

1. Anything that occupies space and has weight.
  2. Solid, liquid, gas.
  3. Transformation of a substance from one form to another.
  4. Cooling happens when temperature is reduced while heating occurs when temperature is increased.
  5. B
  6. Ice, steam
  7.  $100^{\circ}\text{C}$ ,  $0^{\circ}\text{C}$
1. The process by which water is made available on the surface of the earth.
  2. (a) Bring about transpiration  
(b) leads to accumulation of water in water bodies  
(c) It is where evaporation occurs
  3. Evaporation, transpiration, condensation, precipitation, surface runoff.
  4. Permanent change in state of a substance.
  5. Refer to learners book page 317.

### **Answers to Self-Test 16.2**

*Refer to learner's book page 318*

5.

Word	Meaning
Sublimation	Change of state from solid to gas directly without undergoing liquid state as a result of heating.
Deposition	Change of state from gas to solid directly without undergoing liquid state as a result of cooling.
Evaporation	Change of state from liquid to gaseous state due to heating.
Condensation	Change of state from gaseous to liquid state due to cooling.
Melting	Change of state from solid to liquid state due to heating.
Freezing	Change of state from liquid to solid state due to cooling.

### Summary of the unit

This unit deals with states of matter and the various processes involved in the states of matter. You therefore should effectively use the practical activities and the suggested teaching approaches in the teacher's book to guide learners acquire the requisite knowledge and desired competences in these areas. At the end of the lessons, you should assess the extent to which the competencies have been achieved and attitude change towards responsible use of water and its various states. Plan remedial activities where necessary for slow learners and give extra activities for gifted ones as well. Also, emphasize the fact that taking this unit seriously may lead to careers such as water engineering and

### Additional information for the teacher

Some information that you may find relevant in this topic are given below.

#### Temperatures at which water changes state

Changes in temperature can cause a substance to change its physical state. We have seen that water can be a solid (ice), a liquid (water) or a gas (vapour or steam). Its state can be changed by heating or cooling. This is because heating or cooling affects the kinetic energy of the molecules.

- When ice is heated, its temperature rises steadily until it all melts. This change is called **melting** and the temperature at which it occurs is the

**melting point.** The melting point of pure water is  $0^{\circ}\text{C}$ .

- On further heating, the temperature of the water rises steadily, some of the water change to vapour (steam). This change is called evaporation. The hotter the water gets, the quicker it evaporates and soon bubbles appear. The water is now boiling and this is the boiling point of water. At sea level the boiling point of pure water is  $100^{\circ}\text{C}$ .

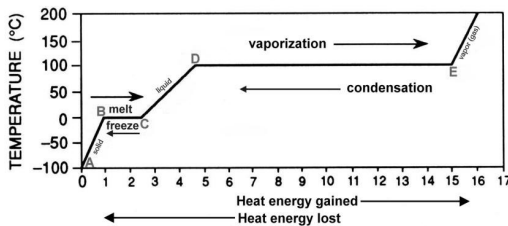

Fig. 16.1 Heating curve for water

The change of state from solid (ice) to liquid (water) and then from liquid to steam (water vapour) can be reversed by cooling. On cooling, the water vapour changes into water. This process is called *condensation*.

On further cooling (to below  $0^{\circ}\text{C}$ ), the liquid water changes into solid ice. The process is called *freezing*. The freezing point of water is the same as the melting

point of ice (i.e.  $0^{\circ}\text{C}$ ). All these changes can be represented as shown in the Fig. 16.2 below.

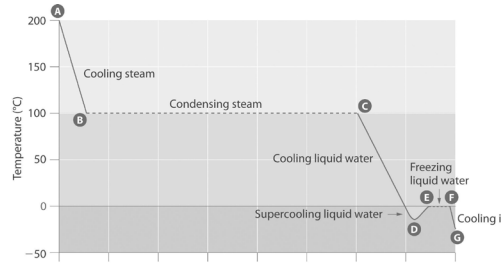

Fig. 16.2 Cooling curve for water

## Mass

We have seen that matter is anything that occupies space and has mass. Mass therefore is the amount of matter in a substance. Mass does not vary with temperature, pressure or any other physical change. It will have the same value on the earth, the moon or in free space. The SI unit for mass is the kilogram (kg). Other common units are grams (g) and tonnes (T).

Table 16.1 Shows the relationship between the SI unit of mass (kg) and other larger and smaller units of mass.

**Table: 16.1 Relationship between different units of mass**

Unit	Symbol	Comparison with kg
1 tonne	t	1000 kg
1 kilogram	kg	1 kg
1 gram	g	0.001 kg

1 milligram	mg	0.000 001 kg
----------------	----	--------------

## Weight

Weight unlike mass, is affected by the gravitational pull. While mass is the quantity of matter present in an object, weight is the measure of the pull of gravity on an object. The weight of an object varies according to the size of the gravitational pull acting on it. This pull of gravity is always directed towards the centre of the earth. Thus weight has both direction and size. The SI unit for weight is the Newton (N). Weight is measured using an instrument called *spring balance* or *Newton metre*. Spring balances Fig. 16.3 are made using spiral springs. When an object is suspended



from a spring balance, the pull of gravity on the object (weight) causes the spring to stretch as shown below.

Fig. 16.3 Weighing a fish using spring balance

## Calculating the weight of a substance given the mass

Weight per unit mass is called the gravitational field strength (g) i.e.

Weight (w)

Mass (m) = gravitational field strength(g)

$$wm = g$$

$$w = mg$$

## Worked Examples

- Calculate the weight of the following.  
(Take  $g = 10\text{N/kg}$ )
  - 300 g of ice

### Solution

$$w = mg$$

$$w = 300 \text{ kg}$$

$$1\ 000 \times 10 = 3\text{N}$$

- 800 kg of lead

### Solution

$$w = mg$$

$$800 \times 10 = 8\ 000 \text{ N}$$

## Differences between mass and weight

Table 16.2 gives a summary of the differences between mass and weight.

**Table 16.2** The main differences between mass and weight

Mass	Weight
1. Quantity of matter contained in a body.	1. Pull of gravity on a body.
2. SI unit is kilogram (kg) or gram (g).	2. SI unit is Newton (N)
3. Constant everywhere.	3. Changes from place to place depending on gravitational field strength.
4. Measured using a beam balance.	4. Measured using a spring balance or a Newton metre.
5. Mass can never be zero.	5. Weight can be zero if no gravity acts on an object e.g in space.

### Density

The density of a substance is defined as its mass per unit volume. Density is therefore a derived quantity of mass and volume. The unit of density is gram per cubic centimetre (g/cm<sup>3</sup>). The symbol (Rho) is used to denote density.

Therefore,

$$\text{Density} = \frac{\text{Mass}}{\text{Volume}} \text{ or } = \frac{M}{V}$$

#### Worked example

A block of lead metal weighing 2373 g is 7.0 cm long, 3.0 cm thick and 10 cm high.

### Calculate its density

#### Solution

$$\text{Density} = \frac{\text{Mass}}{\text{Volume}}$$

Volume

$$\text{Mass} = 2\,373 \text{ g}$$

$$\text{Volume} = 7 \times 3 \times 10 = 210 \text{ cm}^3$$

$$\text{Density} = \frac{2373}{210}$$

$$11.3 \text{ g/cm}^3$$

### Determining the densities of irregular objects

#### Worked example

A stone of mass 40 g was completely immersed in a liquid. The different levels of the liquid are as shown below and after immersing.

A block of lead metal weighing 2373 g is 7.0 cm long, 3.0 cm thick and 10 cm high.

**Calculate**

- (a) The volume of the stone in cubic centimetres.
- (b) The density of the stone in grams per cubic centimetre.

**Solution**

Volume of liquid displaced =  $60 - 40 = 20$  ml

(a) Note:  $1 \text{ ml} = 1 \text{ cm}^3$  hence,  $20 \text{ ml} = 20 \text{ cm}^3$ .

Volume of the stone = volume of the liquid displaced =  $20 \text{ cm}^3$

(b) Density = Mass

Volume = 40 g

$20 \text{ cm}^3 = 2 \text{ g/cm}^3$

**Answers to Unit Test 16 (Pupil's book page 319-320)**

- 1. Occupies space.
- 2. Liquids flow, solids do not flow  
liquids can be compressed, solids cannot.
- 3. Refer to Activity 16.3 pages 326 – 327 pupil's book
- 4. D
- 5. Total amount of matter in a substance.
- 6. (a) A – Transpiration, B – Evaporation  
(b) Water vapour  
(c) Precipitation
- 7. (a) Rain forms through water cycle. It is the main source of water which has a



wide variety of uses in our lives ranging from domestic to agricultural and industrial uses.

(b) Because trees are important catchment areas of rains. Trees undergo transpiration process which leads to availability of water vapour in the atmosphere. The water vapour is condensed to give us rain.

8. Use thermometer while heating then note the temperature at which (a) melting occurs and (b) boiling occurs.

9. C

10. (a) Melting

(b) Evaporation

(c) Condensation

(d) Freezing

11. B

12. Melts

## Additional activities to cater for intellectually challenged and gifted learners

Remedial activities for intellectually challenged learners	Extended activities for gifted and talented learners
<ol style="list-style-type: none"> <li>1. Practice boiling water and melting candle wax at home and observing what happens.</li> <li>2. Drawing water cycle in a manila paper and hanging on the wall of classroom for future reference.</li> <li>3. Playing a game of naming the various processes in the chart on page 331 Fig. 16.4 of pupil's book. They can also draw this figure in a manila paper and hang it on the wall of class room for reference.</li> </ol>	<ol style="list-style-type: none"> <li>1. Determining boiling points of other liquids such as spirit and melting points of solids such as salt and sugar and comparing to that of water and ice respectively.</li> <li>2. Finding out factors that affect boiling point and freezing point of various substances.</li> <li>3. Determining volumes of various irregular objects using eureka can, measuring their weights and using the masses obtained to calculate the densities of the objects using the formula:  Density = Mass/Volume</li> </ol>
Remedial questions for slow learners	Extended questions for gifted learners
<ol style="list-style-type: none"> <li>1. Matter is anything that occupies _____ and has _____.</li> <li>2. The three states of matter are _____, _____ and _____.</li> <li>3. Give the name of (a) water in solid state. _____ (b) Water in gaseous state. _____</li> <li>4. The boiling point of water is _____ °C while the melting point of ice is _____ °C</li> </ol>	<ol style="list-style-type: none"> <li>1. The fact that water is found both as ice and steam shows it exists in _____ states.</li> <li>2. Why would you be unable to compress a stone?</li> <li>3. Distinguish between deposition and sublimation.</li> <li>4. Describe water cycle.</li> </ol>

Answers to remedial questions	Answers to extended questions
<ol style="list-style-type: none"> <li>1. Space, mass</li> <li>2. Solid, liquid and gas</li> <li>3. (a) Ice                      (b) Steam</li> <li>4. 100, 0</li> </ol>	<ol style="list-style-type: none"> <li>1. Three</li> <li>2. Because its particles are arranged/ packed very closely together.</li> <li>3. Sublimation – change from solid to gaseous state directly. Deposition – change from gaseous to solid state directly.</li> <li>4. The process by which water is made available on Earth’s surface. It involves four processes namely evaporation, transpiration, condensation and precipitation. Evaporation and transpiration add water vapour into the atmosphere. The water vapour is then converted to clouds through condensation. Precipitation leads to rainfall. After it has rained, water gets into the water bodies through surface runoff, plants absorb water from soil and the processes are repeated over and over.</li> </ol>

## BIBLIOGRAPHY

- **A. Beinempaka., K. Kato and T. Obwol:** Principles and practices of Agriculture
- **Beryl Kendall:** Start finding out. Longhorn Primary Science, Pupil's book standard 6, 1999.
- **Karaka J., Nyangasi L.:** Githui. K: Understanding Science. Longhorn publishers Ltd. Pupil's Book standard 6, 2005
- Livestock technical handbook by Department of Veterinary services and animal husbandry. Ministry of animal industries and fisheries, Kmpala Uganda.
- **Nyapera W, Muchunku Z.:** Mentor KCPE science – 2013.
- **Ojwang' A nad K'opiyo F.:** Science matters Standard 6. East African Educational publishers - 2005
- **Omar T.S., Nyangasi L.,** (2014) Star Revision KCPE Science – 2014.
- Primary Science for standard 6 by Kenya literature Bureau, 2006.
- **Vashista S.K.' Patel N.M.** (1992): Learning Science and Agriculture. A complete textbook for revision. Malimu Publications - 1992.
- **Wanderi. J.** 2002.: Mean score booster for classes 4,5,6,7 & 8. Naship J. Publishers, 2002
- <http://etoysillinois.org/files/i3learning.pdf>
- <http://scratch.mit.edu>
- [http://shallwelearn.com/blog/stories/Scratch\\_Intro.pdf](http://shallwelearn.com/blog/stories/Scratch_Intro.pdf)
- <http://www.cse.msu.edu/~stockman/ITEC/Scratch/BGC2011Scratch-Rev1.pdf>
- [http://www.okbamboo.cn/index.php/product/Garden+Rake\(OK-T1205\).html](http://www.okbamboo.cn/index.php/product/Garden+Rake(OK-T1205).html)
- <http://www.rpbouret.com/scratch/Bouret-ScratchProgramming.pdf>
- <https://etoysillinois.org/files/Etoys%20tutorial%201.pdf>
- <https://resources.scratch.mit.edu/www/guides/en/Getting-Started-Guide-Scratch2.pdf>
- <https://www.mindofateacher.com/scratch-tutorial-for-beginners/>

