

Primary 6 Mathematics

For Rwanda Schools

Teacher's Guide





Copyright

© 2018 Rwanda Education Board

All rights reserved.

This document is the property of Rwanda Education Board.

Contents

Section 1: General Introduction

1.1 Competence Based Curriculum and Meaning of Competences.....	ix
1.2 Broad Mathematics Competences.....	x
1.3 Mathematics and Developing the Competences.....	xi
1.4 Key Mathematics Competences at the End of Primary 6.....	xi
1.5 Layout of the Teacher's Guide	xii
1.6 Preparation for Lesson.....	xii
1.7 Guidance for Assessment	xv

Section 2: Sample Lesson Plan

xvi

Section 3: Content Map.....

xix

Unit 1: Reading, Writing and Comparing Whole Numbers beyond 1,000,000

1.1 Reading and writing numbers beyond 1,000,000 in words	3
1.2 Reading and writing numbers beyond 1,000,000 in figures.....	5
1.3 Finding place values and values of numbers up to 7 digits	6
1.4 Comparing numbers using $<$, $>$ or $=$	8
1.5 Arranging numbers in ascending and descending order.....	9
1.6 Adding numbers beyond 1,000,000.....	10
1.7 Solving problems involving addition of numbers beyond 1,000,000...11	
1.8 Subtracting of numbers beyond 1,000,000.....	13
1.9 Solving problems involving subtraction of numbers beyond 1,000,000	14
1.10 Multiplying numbers beyond 1,000,000.....	16
1.11 Solving problems using calculation strategies on multiplication	17
1.12 Dividing numbers beyond 1,000,000.....	18
1.13 Solving problems using calculation strategies on division.....	19
1.14 Rounding off whole numbers to the nearest tens.....	20
1.15 Rounding off whole numbersd to the nearest hundreds and thousands	22
1.16 Rounding to the nearest ten thousand, hundred	

thousand and million (80 minutes).....	24
--	----

Unit 2: Multiplication and Division of Integers

2.1 Multiplying integers using a number line.....	35
2.2 Multiplying of integers without using a number line.....	36
2.3 Division of integers using a number line.....	37
2.4 Dividing integers without using a number line.....	39
2.5 Solving problem involving multiplication and division of integers	41

Unit 3: Powers and Indices, LCM and GCF

3.1 Indices.....	49
3.2 Defining bases and exponent.....	50
3.3 Multiplying and the law of multiplication of indices.....	51
3.4 Dividing and the law of indices.....	52
3.5 Multiplying and Dividing Indices.....	53
3.6 Finding the Unknown and the Law of Multiplying Indices.....	55
3.7 Finding the Unknown and the Law of Dividing Indices.....	56
3.8 Finding the Lowest Common Multiple (LCM) Of numbers.....	57
3.9 Solving problems involving LCM.....	58
3.10 Finding the Greatest Common Factor (GCF) of numbers.....	59
3.11 Solving Problems Involving GCF.....	60
3.12 Finding the Unknown Number Using LCM and GCF.....	62

Unit 4: Operations on Fractions

4.1 Multiplying a Whole Number by a Fraction.....	71
4.2 Multiplying a fraction by a whole number.....	72
4.3 Multiplying a Fraction by a Fraction.....	74
4.4 Solving Problems Involving Multiplying Fractions.....	75
4.5 Finding reciprocals.....	76
4.6 Dividing a Whole Number by a Fraction.....	77
4.7 Dividing a fraction by a whole number.....	79
4.8 Dividing a fraction by a fraction.....	80
4.9 Solving Problems Involving Dividing Fractions.....	81
4.10 Multiplying and Dividing Fractions.....	83

Unit 5: Rounding and Converting Decimals, Fractions/Numbers

5.1 Rounding off decimal numbers to the nearest tenth.....	89
5.2 Rounding off to the nearest hundredth	91
5.3 Rounding off Decimal Numbers to the Nearest Thousandth	92
5.4 Rounding off decimal numbers to the nearest ten thousandth	93
5.5 Rounding off decimal numbers to the nearest hundred thousandth.....	95
5.6 Rounding off decimal numbers to the nearest millionth.....	96
5.7 Solving Problems Involving Rounding off Decimal numbers	98
5.8 Converting of Fractions into Decimal Numbers.....	99
5.9 Converting of decimals into fraction.....	101
5.10 Solving Problems Involving Converting Decimals into Fractions and Fractions into Decimals.....	103

Unit 6: Ratios, Proportions, Percentages and Mixtures

6.1 Converting Percentages into Decimals.....	109
6.2 Converting decimals to percentages.....	110
6.3 Converting Percentages into Fractions.....	111
6.4 Converting fractions to percentages.....	112
6.5 Comparing Quantities as Percentages.....	113
6.6 Comparing Percentages as Quantities.....	115
6.7 Increasing a number by a percentage.....	117
6.8 Decreasing a Number by Percentage.....	119
6.9 More about Increasing and Decreasing Quantities by Percentage....	121
6.10 Finding Percentage Increase and Decrease.....	122
6.11 Finding Percentage profit and percentage loss.....	124
6.12 Solving Problems Involving Percentages.....	125
6.13 Finding ratios.....	127
6.14 Sharing Quantities in Ratios	129
6.15 Increasing and Decreasing Quantities in Ratios.....	130
6.16 Finding the Ratio of Increase and Decrease.....	132
6.17 Solving Problems Involving Ratios.....	134
6.16 Finding indirect proportions.....	135
6.19 Finding average price of the mixture.....	136
6.20 Finding the quantity of one type of the mixture.....	138

6.21 Finding the price of one type of the mixture.....	139
6.22 Finding both quantities or prices of the mixture.....	141
6.23 Solving Problems Involving Ratios, Percentages, Mixtures and Inverse Proportions.....	142

Unit 7: Relationship between Volume, Capacity and Mass

7.1 Revision on Mass Measurement.....	148
7.2 Revision on Capacity Measurement.....	149
7.3 Measurement of Volume.....	151
7.4 Finding the relationship between units of volume, capacity and mass.....	152
7.5 Converting between units of Volume, capacity and mass.....	151

Unit 8: Speed, Distance and Time

8.1 Comparing the 12-hr clock to 24-hr clock.....	159
8.2 Converting 12-hr to 24-hr Format.....	160
8.3 Converting 24-hr format to 12-hr format.....	161
8.4 The Concept of Time Zones.....	162
8.5 Solving Mathematical Problems Relating to Time Zones	163
8.6 Calculating Speed.....	164
8.7 Converting Speed from km/hr to m/sec.....	165
8.8 Converting Speed from m/sec to km/hr.....	166
8.9 Calculating Distance.....	167
8.10 Calculating Time.....	170
8.11 Moving Bodies Towards Each Other.....	171
8.12 Moving Bodies Following Each Other.....	173
8.13 Calculating Average Speed.....	175

Unit 9: Simple Interest and Problems Involving Saving

9.1 Calculating Simple Interest.....	181
9.2 More About Calculating Simple Interest.....	183
9.3 Solving Problems Involving Simple Interest.....	184
9.4 Calculating Rate.....	185
9.5 Solving Problems Involving Interest Rate.....	187
9.6 Calculating Principal.....	188
9.7 Solving Problems Involving Principle.....	189

9.8 Calculating Time.....	190
9.9 Solving Problems Involving Simple Time.....	192
9.10 Solving Problems Involving Principle	193
9.11 Solving Problems Involving Amount	194
9.12 Saving Money in the Bank or Putting it in Investments	195
9.13 Solving Problems Involving Savings and Simple Interest	196

Unit 10: Equivalent Expressions and Number Sequences

10.1 Solving Algebraic Expressions	203
10.2 Equivalent Expressions	204
10.3 Finding the Missing Number	205
10.4 Finding the missing Consecutive Fractions and Decimals	206
10.5 Finding the General Term/Rule of Linear Sequence	208
10.6 Finding the General Term/Rule of Linear Sequence for Fractions and Decimals.....	210
10.6 Finding the Missing or n^{th} Term of Linear Sequence.....	211
10.7 Finding the Missing Fraction or n^{th} Term in a Linear Sequence	213
10.8 Finding the Number Sequence Using the General Term/Rule	214

Unit 11: Solving Simple Algebraic Equations and Inequalities

11.1-2 Like and Unlike Terms of Algebraic Expressions	221
11.3 Substituting Algebraic Expressions with Addition and Subtraction ...	222
11.4 Substituting Algebraic Expressions with Multiplication	223
11.5 Substituting Algebraic Expressions Involving Division	225
11.6 Simple Algebraic Equations with One Unknown	226
11.7 Solving Fractional Algebraic Equations	228
11.8 Solving Problems Involving Equations	229
11.9 Solving Algebraic Inequations with One Unknown	231
11.10 Finding the Solution Set	233

Unit 12: Regular Polygons and Bearings

12.1 Definition of Polygons and their examples	241
12.2 Investigating the Interior Angle and Exterior Angle of a Regular Polygon	242
12.3 Investigating the Sum of Interior Angles and the Sum of Exterior ...	
12.4 Elements of regular polygons: Finding the Interior and exterior angles of a regular polygon	244

12.5 Finding the Sum of Interior Angles of a Regular Polygon	247
12.6 Exterior Angles of Regular Polygons and their Sum	247
12.7 Finding Sides and Apothem	249
12.8 Finding Perimeter of regular polygons	251
12.9 Finding Area of Regular Polygons	252
12.10 Finding Bearings and Compass Points.....	254
12.11 Finding Bearings	255
12.12 Tiling/Construction	256

Unit 13: Construction of Polygons and Nets for Cuboids and Prisms

13.1 Drawing Triangles Using a Protractor and Ruler	263
13.2 Drawing a Square Using a Protractor and Ruler	264
13.3 Drawing a Rectangle Using a Protractor and Ruler	265
13.4 Drawing Regular Pentagon Using a Protractor and Ruler	266
13.5 Drawing a Regular Hexagon	268
13.6 Constructing Triangles Using a Ruler and a Pair of Compasses	269
13.7 Constructing a Rectangle Using Compasses and Ruler Only	270
13.8 Constructing a Square Using Compasses and Ruler	271
13.9 Finding the Centre Angle of a Regular Polygon	273
13.10 Constructing a regular Pentagon and Hexagon	274
13.11 Constructing a Regular Septagon and Octagon	275
13.12 Constructing a regular Nonagon and Decagon	276
13.13 Designing Different Nets of Cuboids, Cubes and Prisms	277

Unit 14: Area Bounded by a Circle, Surface Area of Cuboid and Volume

of a Cylinder

14.1 Finding Area Bounded by a Circle	282
14.2 Finding Area of a Circle Using Radius	284
14.3 Calculating Area of a Circle Given Diameter	286
14.4 Calculating Area of a Circle Given Circumference	287
14.5 Finding Radius Given Area	289
14.6 Calculating the Surface Area of a Cuboid	290
14.7 Finding the Length of a Cuboid	292
14.8 Finding the Width of a Cuboid	293
14.9 Finding the Height of a Cuboid	295
14.10 Finding Volume of a Cylinder	296

Unit 15: Statistics

15.1 Collecting Data to Investigate Question (40 minutes)	300
15.2 Interpreting Data in Frequency Tables (40 minutes)	301
15.3 Representing Data in a Bar Chart (40 minutes)	303
15.4 Interpreting Data in a Bar Chart (40 minutes)	305
15.5 Representing Data in a Pie-chart (40 minutes)	306
15.6 Interpreting Data in Pie-chart to Draw Conclusion (40 minutes)	308

Unit 16: Probability

16.1 Vocabulary-impossible, certain, equally likely, events, chance, unlikely	316
16.2 Using data to decide how likely something is to happen	318

Glossary	320
----------------	-----

Bibliography	320
--------------------	-----



Section 1: General Introduction

1.1. Competence Based Curriculum and Meaning of Competences

Rwanda opted to adopt the competence based curriculum. In this curriculum, learners are exposed to a range of experiences that enable them to gain ability to apply learning with confidence in a range of situations.

The competence based curriculum organises competences into basic and generic competences. Basic competences are addressed in the stated broad subject competences, in the objectives highlighted on year by year basis and in each of the units of learning.

Basic Competences

- ◆ Literacy
- ◆ Numeracy
- ◆ ICT and digital competences
- ◆ Citizenship and national identity
- ◆ Entrepreneurship and business development
- ◆ Science and technology

Generic competences

- ◆ **Critical thinking and problem solving skills:** The acquisition of such skills will help learners think imaginatively, innovatively and broadly to evaluate and find solutions to problems encountered in our surroundings.
- ◆ **Creativity and innovation:** The acquisition of such skills will help learners take initiative and use imagination beyond knowledge provided in classroom to generate new ideas and construct new concepts.
- ◆ **Research:** This will help learners find answers to questions based on existing information and concepts and use it to explain phenomena from gathered information.
- ◆ **Communication in official languages:** Teachers, irrespective of being language teachers, will ensure the proper use of the language of instruction by learners. This will help learners communicate clearly

and confidently and convey ideas effectively through speaking and writing and use the correct language structure and relevant vocabulary.

- ◆ **Co-operation, inter personal management and life skills:** This will help learners to co-operate as a team in whatever tasks are assigned and to practise positive ethical moral values while respecting rights, feelings and views of others. Learners will perform practical activities related to environmental conservation and protection. They will also advocate for personal, family and community health, hygiene and nutrition and respond creatively to a variety of challenges encountered in life.
- ◆ **Lifelong learning:** The acquisition of such skills will help learners to update their knowledge and skills with minimum external support. The learners will be able to cope with the evolution of advances in knowledge for personal fulfillment in areas that are relevant to their improvement and development.

1.2. Broad Mathematics Competences

During the learning process, the learner should be able to:

- ◆ Demonstrate knowledge, understanding and skills of Mathematics subject matter that would enable him/her to access Mathematics and related subjects in higher levels.
- ◆ Analyse mathematical phenomena relating to real life experiences.
- ◆ Demonstrate curiosity, research skills, creativity and innovative skills.
- ◆ Develop attitudes relevant to Mathematics such as concern for accuracy and precision, objectivity, integrity, enquiry, initiative and inventiveness.
- ◆ Promote awareness that scientific theories and methods have developed, and continue to do so, as a result of the co-operative activities of groups and individuals.
- ◆ Develop attitudes on which scientific investigations depend, such as honesty, persistence, critical thinking and tolerance of uncertainty.

1.3. Mathematics and Developing the Competences

The national policy documents which are based on the national aspirations identify some “Basic Competences” alongside the “Generic Competences”. These competences aim to develop higher order thinking skills, help subject learning and promote the application of what has been learnt in real life situation.

Through experimentation, observation and presentation of information during the learning process, the learner develops not only deductive and inductive skills but also communication, critical thinking and problem solving skills as they try to make inferences and conclusions.

The manipulation of numerical and other data, performing practical experiments and undertaking project assignments involves not only analytical and problem solving skills but also innovation, creativity and research.

Group work and cooperative learning of Mathematics promotes interpersonal relations and teamwork. Learning Mathematics prepares responsible citizens who are aware of the power, impact and influence Mathematics has in a modern scientific world. The syllabus emphasises the development of values and positive attitudes so that what is learnt is used for the good of the society and for the preservation of the environment.

1.4. Key Mathematics Competences at the End of Primary 6

- ◆ Read, write, compare and calculate whole numbers beyond 1,000,000, multiply and divide integers, use powers and indices, LCM and GCF when solving problems.
- ◆ Convert between the units of volume, capacity and mass, work out simple interest and solve problems involving savings.
- ◆ Calculate speed, distance and time.
- ◆ Solve simple problems involving proportions, ratios, percentages, mixtures, fractions and decimals.
- ◆ Calculate area enclosed by a circle, surface area of cuboids and the volume of a cylinder.
- ◆ Extend methods for collecting data, representing and interpreting it in order to answer a question or explore a hypothesis.
- ◆ Form and solve simple algebraic equations and inequalities.
- ◆ Explain the concept of probability by ordering events in terms of likelihood (impossible, equally likely, certain).

- ◆ Use bearings and compass points and understand the relationship between them, use the angle sum of a triangle to determine the interior angles of regular polygons.
- ◆ Construct polygons using a protractor, a ruler and a pair of compasses and design nets to make cuboids and prisms.

1.5. Layout of the Teacher's Guide

The Teacher's guide is a simple one. It is divided into two broad parts: General introduction and detailed scheme of work:

General introduction contains important pieces of information like:

- ◆ Meaning of competence and competence based curriculum.
- ◆ Categories of competences: Basic and Generic competences.
- ◆ Broad Mathematics competences.
- ◆ Key Mathematics competences at the end of Primary Six.
- ◆ Layout of the teacher's guide.
- ◆ Sample lesson plan.
- ◆ Content maps.

The way all 16 units are developed in this Teacher's Guide is the same. It begins with the unit title and key unit competence. General objectives to be achieved by the end of the unit are stated. Study tips, cross-cutting issues addressed, and competences and values are identified as per sub-units.

In addition to the above, the detailed unit development suggests systematic treatment in terms of:

- ◆ List of lessons
- ◆ Number of periods and the time duration.
- ◆ The contents fitted into the periods.
- ◆ The possible learning objectives in terms of: knowledge and understanding, skills to be acquired and attitudes and values to be developed.
- ◆ Possible teaching and learning guidance and activities to enhance achievement of the objectives.
- ◆ Revision and additional exercises for further achievement of the suggested competences.

As mentioned above, these are suggestions. As a teacher, any efforts you put in to modify the content of the unit to suit your learners or the school is a

strong point and not a failure.

1.6. Preparation for Lesson

The Teacher's Guide holds clearly that effective teaching and learning involves three stages: before the lesson, during the lesson and after the lesson. As a teacher, one should prepare for all the three stages.

Before the lesson

The teacher needs to bear in mind the following:

◆ **Teaching aids and techniques needed for Inclusive education:**

The teacher needs to understand the class in terms of learners with special educational needs. Categories of learners with special educational needs include:

- ✎ The gifted or talented learners.
- ✎ Slow learners.
- ✎ The mentally challenged learners.
- ✎ Learners with visual impairment.
- ✎ Learners with hearing impairment.
- ✎ Learners with difficulty in communication.
- ✎ Learners with physical impairment.
- ✎ Any other, as you may identify.

Learners with learning difficulties should be provided with alternative ways of learning. This alternative should compensate for where they have been challenged. For example, an Activity involving a learner with hearing impairment, more demonstrations should be done to compensate for what the learner cannot hear. The gifted and the talented learners need more challenging tasks than an ordinary learner while slow learners need remedial activities.

- ◆ **Cross-cutting issues:** Put in simple terms, these are topical issues that have to be clearly communicated and inculcated in learners. They are inter-disciplinary and touch the core values for national development. As you prepare for your lessons, try to make sure you address at least one of the following cross-cutting issues:

- ✍ Genocide studies
 - ✍ Environment and sustainability
 - ✍ Gender
 - ✍ Comprehensive sexuality education.
 - ✍ Peace and Values education
 - ✍ Financial education
 - ✍ Standardization culture
 - ✍ Inclusive education.
- ◆ **Link of Mathematics to other subjects:** Mathematics is not an isolated subject. It is linked to various subjects. Try to understand the information needed from the various subjects which Mathematics is linked to. This is necessary when explaining certain concepts.
- ◆ **Activities in Learner's Book:** The activities in the Learner's Book are of three different categories: Practical Activity, Group Discussion and Research Work.
- ✍ **Group discussion:** These are simple questions or topics to be discussed by learners in their groups during the lesson. The questions or topic in these activities are selected such that they are familiar to learners for them to discuss without referring to books and other sources. Guide each group so as to make learners participate in the discussion.
 - ✍ **Practical activities:** Mathematics is one important subject which is best learnt through practicals. Several practical activities are given in the Learner's Book. The requirements for the activity and the procedures are clearly outlined.
- Questions pertaining to observations are given after every procedure which gives out a clear or distinct observation. During practical activities, the focus should be on developing the following skills: observation, manipulation, recording, report, writing, measurement, planning and designing. However, as a teacher, you should first try the practical activity before exposing it to learners. Modification of the activity to suit your learners and

or the available resources is creativity and not failure!

- ✎ **Research Works:** These are meant to train students for lifelong learning and to change their attitudes of thinking that teachers are the only source of information. The Research Works are to be given to learners in their groups in advance to allow them find out the information, organise it and present their findings.

During the lesson

The detailed unit development contains all a teacher needs during lessons. Therefore, a teacher here implements the suggestions in the unit development. However, one needs to study the suggestion as an activity before the lesson. Should there be any short-coming, then as a teacher, a step to solving the problem can be sought. Once again take these plans as suggestions, and not ultimate.

After the lesson

This sounds an activity completely away from the lesson. However, it is an integral part of the lesson and more so, a very important part of the lesson.

It refers to the Teaching–Learning Activities after lesson conclusion. This involves lesson evaluation in the form of: assignment, homework, holiday package, research work among others. These have to be tailor made to Activities and Contents in the Learner's Book.

1.7. Guidance for Assessment

As a professional teacher, you are recommended to conduct regular assessments either continuous (formative) or summative assessment.

In order to proceed with it, well refer to the objectives set, then prepare and provide assessment to your learners.

Make sure that you have checked the progress of learners via different tools of assessing. For better success of your lesson, provide more practical activities and exercises via, class-work, homework, quizzes, etc.

When preparing assessment, consider the assessment criteria from the syllabus then match it with key unit competence to be achieved.

Use of exercises and their answers

Even though answers for exercises and question were provided in this book, the teacher is requested to do every activity before marking learner's work.

Section 2: Sample Lesson Plan

School Name: Teacher's name:

Term	Date	Subject	Class	Unit No	Lesson No	Duration	Class size
.....	.../.../20...	Mathematics	P.6	1/16	2 of 18	40 min
Type of Special Educational Needs to be catered for in this lesson and number of learners in each category.				Eye defect - short sighted: The learner will be given the opportunity of sitting in front			
Unit title		Reading, Writing and Comparing Whole Numbers Beyond 1,000,000					
Key Unit Competence:		To be able to read, write and compare whole numbers beyond 1,000,000.					
Title of the lesson		Reading and writing numbers beyond 1,000,000 in words					
Instructional Objective		Using flash cards, learner will be able to write numbers beyond 1,000,000 in words correctly.					
Plan for this Class (location: in / outside)		Inside the classroom.					
Learning Materials (for all learners)		Manila cards or slips of paper, scissors to make cut outs of numbers, on flash cards.					
References		Learner's Book, page 1, Teacher's Book page 4 and Maths syllabus for upper primary.					
Timing for each step		Description of teaching and learning activity.				Competences and Cross-Cutting Issues to be addressed	
Steps and Timing		After forming the groups, with the help of the teacher learners will manipulate, observe the number cards. Helped by the teacher, they will be able to read and write numbers in words.					
		Teachers activities		Learners activities			
Introduction 5 mins		Teacher gives learners the number cards and asks them to match them through a matching game in activity 2 page 1.		Learners take the flash cards. Learners participate in the matching game.		Co-operation, interpersonal management developed through the interaction in groups.	

	<p>Teacher helps learners to understand the instructions.</p> <p>Teacher explains the reason for the matching game.</p> <p>Teacher gives feedback to the game.</p>	<p>Learners follow the number card and do as instructed in the Learner's Book, page 1.</p> <p>Learners present their working in front of the classroom.</p>	<p>Critical thinking developed through the analysis of the process of matching.</p> <p>Communication developed through discussions in groups.</p>
<p>Development of the lesson. (25 mins)</p>	<p>Teacher helps learners to understand well through working out the examples in the Learner's Book, pages 2.</p> <p>Writes down an example of numbers which are in figures to write in words.</p> <p>Write down numbers which are in figure in words.</p> <p>Teacher gives learners the first three questions Application 1.1 (page 3) in Learner's book.</p>	<p>Learners attempt to repeat the worked example with the help of the teacher.</p> <p>Write the flowing numbers in words:</p> <p>a) 5, 600,002 b) 6,412,500 c) 4,678,479 d) 63,455,205 e) 82,999,555</p> <p>Answer</p> <p>a) Five million, six hundred thousand two b) Six million, four hundred twelve thousand five hundred. c) Four million, six hundred seventy-eight thousand four hundred seventy-nine.</p>	<p>Co-operation , interpersonal management developed through the interaction in groups.</p> <p>Communication developed through class discussions.</p> <p>Problem solving through writing given numbers in words correctly.</p>

		<p>d) Sixty-three million four hundred fifty-five thousand two hundred five.</p> <p>e) Eighty two million, nine hundred ninety nine thousand five hundred fifty five.</p>	
<p>Conclusion 10 mins</p>	<p>Teacher helps learners to summarise the lesson.</p>	<p>When writing whole number in words you have to group digits in threes starting on the right of whole numbers.</p> <p>Learners do the rest of Application 1. 1 on Page 3 of the Learner's Book.</p>	<p>Communication through exchanging ideas.</p>
	<p>Teacher gives learners the remaining four questions of Application 1.1 page 3.</p>	<p>Learner will copy the given application as homework in their note-books and do the work at home.</p>	<p>Research problem solving through doing tasks given in homework when asking help.</p> <p>Critical thinking developed through the analysis of the questions.</p>
<p>Teacher self-evaluation</p>	<p>This teacher self-evaluation is done after teaching.</p>		

Section 2: Content Map

Unit 1	Reading, writing and comparing whole numbers beyond 1,000,000
Number of periods	18
Introduction	In this unit, there will be development of different skills respectively about reading, writing and comparing whole numbers beyond 1,000,000.
Classroom organisation	<ul style="list-style-type: none"> ◆ Whole class work ◆ Group work ◆ Pair work ◆ Individual work
Learning and teaching materials	Manila cards or slips of paper, scissors to make cut-outs of numbers, markers to write numbers that can be seen from the back of the room.
Activities	<ul style="list-style-type: none"> ◆ Matching game. ◆ Writing numbers in words and in figures.
Competences practised	<ul style="list-style-type: none"> ◆ Teamwork ◆ Effective communication ◆ Problem solving
Vocabulary acquisition	<ul style="list-style-type: none"> ◆ Writing numbers in words up to 1,000,000. ◆ Place values in written numerals
Study skills	<ul style="list-style-type: none"> ◆ Group activities/ discussion ◆ Demonstration ◆ Problem solving
Revision	Revision Activity

Assessment	<ul style="list-style-type: none"> ◆ Ability to read and write whole numbers up to 1,000,000. ◆ Ability to accurately compare whole numbers in terms of size. ◆ Ability to carry out the operations and solve problems involving them.
Learning outcomes	<ul style="list-style-type: none"> ◆ Ability to read and write whole numbers up to 1,000,000. ◆ Compare and calculate whole numbers up to 1,000,000. ◆ Ability to carry out operations using correct process and solve daily life problems.

Unit 2 Multiplication and division of integers

Number of periods	8
Introduction	In this unit, there will be development of different skills respectively about multiplication and division of integers.
Classroom organisation	<ul style="list-style-type: none"> ◆ Whole class work ◆ Group work ◆ Pair work ◆ Individual work
Learning and teaching materials	Learners should multiply and divide positive integers, negative integers, positive and negative integers.
Activities	<ul style="list-style-type: none"> ◆ Matching game. ◆ Mental activities
Competences practised	<ul style="list-style-type: none"> ◆ Teamwork ◆ Effective communication ◆ Problem solving
Vocabulary acquisition	Multiplying and dividing integers

Study skills	<ul style="list-style-type: none"> ◆ Group activities ◆ Class discussion ◆ Problem solving
Revision	Revision Activity
Assessment	Ability to correctly multiply and divide integers.
Learning outcomes	<ul style="list-style-type: none"> ◆ Getting skills about multiplication of integers ◆ Getting skills about division of integers

Unit 3

Powers and Indices, LCM and GCF

Number of periods	16
Introduction	In this unit, there will be development of different skills respectively about finding powers and indices, LCM and GCF/HCF.
Classroom organisation	<ul style="list-style-type: none"> ◆ Whole class work ◆ Group work ◆ Pair work ◆ Individual work
Learning and teaching materials	The flashing of lights at different intervals, when they light together at the same time.
Activities	<ul style="list-style-type: none"> ◆ Multiplying and dividing numbers using indices. ◆ Finding the lowest common multiples and the greatest common factors.
Competences practised	<ul style="list-style-type: none"> ◆ Teamwork ◆ Effective communication ◆ Problem solving
Vocabulary acquisition	<ul style="list-style-type: none"> ◆ Using of powers and indices to multiply numbers ◆ Finding LCM and GCF
Study skills	<ul style="list-style-type: none"> ◆ Group activities ◆ Class discussion ◆ Class demonstration ◆ Problem solving
Revision	Revision Activity

Assessment	<ul style="list-style-type: none"> ◆ Ability to find the lowest common multiple(LCM). ◆ Ability to find the Greatest Common Factor (GCF) of whole numbers. ◆ Continuously practise activities to test what learners have acquired.
Learning outcomes	<ul style="list-style-type: none"> ◆ Knowing how to multiply and divide number using indices. ◆ Knowing how to calculate the Least Common Multiple (LCM) and the Greatest Common Factor (GCF) of numbers. ◆ Solving problems involving LCM and GCF.

Unit 4

Operations on fractions

Number of periods	17
Introduction	In this unit, there will be development of different skills respectively about operations on fractions.
Classroom organisation	<ul style="list-style-type: none"> ◆ Whole class work ◆ Group work ◆ Pair work ◆ Individual work
Learning and teaching materials	Manila cards, scissors, markers and masking tape.
Activities	Carrying out operations on fractions
Competences practised	<ul style="list-style-type: none"> ◆ Team work ◆ Effective communication ◆ Problem solving ◆ Co-operation
Vocabulary acquisition	<ul style="list-style-type: none"> ◆ Numerator ◆ Denominator

Study skills	<ul style="list-style-type: none"> ◆ Group activities/ discussion ◆ Class demonstration ◆ Manipulation
Revision	Revision Activity
Assessment	Assessment on the ability to add, subtract and find equivalent fractions.
Learning outcomes	Ability to explain how to add and to subtract fractions with different denominators using equivalent fractions and the lowest common multiple(LCM).

Unit 5

Rounding and converting decimals, fractions/numbers

Number of periods	16
Introduction	In this unit, there will be development of different skills respectively about rounding and converting decimals, fractions/numbers
Classroom organisation	<ul style="list-style-type: none"> ◆ Whole class work ◆ Group work ◆ Pair work ◆ Individual work
Learning and teaching materials	Manila cards, scissors, markers and masking tape.
Activities	Rounding off numbers and converting decimals, fractions/numbers.
Competences practised	<ul style="list-style-type: none"> ◆ Co-operation ◆ Effective communication ◆ Creativity and innovation ◆ Critical thinking
Vocabulary acquisition	<ul style="list-style-type: none"> ◆ Rounding off decimal number. ◆ Converting decimals to fractions and vice versa. ◆ Converting fractions to percentages and vice versa.

Study skills	<ul style="list-style-type: none"> ◆ Practical activities ◆ Group activities ◆ Demonstration ◆ Manipulation ◆ Supervised activities
Revision	Revision Activity
Assessment	<ul style="list-style-type: none"> ◆ Ability to multiply and divide decimal numbers. ◆ Ability to convert fraction into decimals ◆ Ability to apply decimal concepts to solve daily life mathematical problems
Learning outcomes	<ul style="list-style-type: none"> ◆ Ability to multiply, divide decimal numbers ◆ Ability to convert fractions to decimals and vice versa.

Unit 6

Ratios, proportions, percentages and mixtures

Number of periods	35
Introduction	In this unit, there will be development of different skills respectively about ratios, proportions, percentages and mixtures.
Classroom organisation	<ul style="list-style-type: none"> ◆ Whole class work ◆ Group work ◆ Pair work ◆ Individual work
Learning and teaching materials	Manila cards, scissors, markers and masking tape.
Activities	Carrying out practical activities involving direct proportion, percentage and mixtures.
Competences practised	<ul style="list-style-type: none"> ◆ Co-operation ◆ Effective communication ◆ Creativity and innovation ◆ Critical thinking
Vocabulary acquisition	<ul style="list-style-type: none"> ◆ Ratio ◆ Inverse proportions ◆ Percentages ◆ Mixture

Study skills	<ul style="list-style-type: none"> ◆ Group activities ◆ Demonstration ◆ Multiplication ◆ Practical activities ◆ Supervised activities ◆ Question and answer
Revision	Revision Activity
Assessment	<ul style="list-style-type: none"> ◆ Ability to explain the concept of direct proportion. ◆ Ability to explain how to work out problems involving direct proportions. ◆ Ability to calculate numbers involving inverse proportions. ◆ Ability to solve mathematical problems involving direct proportions.
Learning outcomes	Ability to apply inverse proportion, mixture and percentages.

Unit 7

Relationship between volume, capacity and mass

Number of periods	7
Introduction	In this unit, there will be development of different skills respectively about relationship between volume, capacity and mass.
Classroom organisation	<ul style="list-style-type: none"> ◆ Whole class work ◆ Group work ◆ Pair work ◆ Individual work
Learning and teaching materials	Manila cards, scissors, glue and markers.
Activities	Carrying out the activities which are related to volume capacity and mass measurement.

Competences practised	<ul style="list-style-type: none"> ◆ Co-operation ◆ Effective communication ◆ Critical thinking ◆ Creativity and innovation
Vocabulary acquisition	Describe how to solve mathematical problems involving relationship between volume, capacity and mass measurements.
Study skills	<ul style="list-style-type: none"> ◆ Practical work ◆ Group activities ◆ Discussion ◆ Demonstration ◆ Supervised activities
Revision	Revision activity
Assessment	<ul style="list-style-type: none"> ◆ Ability to relate mass, capacity and volume measurement. ◆ Working out word problem involving mass, capacity and volume measurement.
Learning outcomes	<ul style="list-style-type: none"> ◆ Ability to calculate the number of intervals between objects. ◆ Ability to solve problems involving intervals. ◆ Ability to select appropriate measurement units when solving problems. ◆ Interpreting decimal representations up to 3 decimal places.

Unit 8

Speed, distance and time

Number of periods	20
Introduction	In this unit, there will be development of different skills respectively about speed, distance and time.
Classroom organisation	<ul style="list-style-type: none"> ◆ Whole class work ◆ Group work ◆ Pair work ◆ Individual work
Learning and teaching materials	Manila cards, masking tape, scissors and markers.

Activities	Solving word problems involving speed, time and distance.
Competences practised	<ul style="list-style-type: none"> ◆ Co-operation ◆ Effective communication ◆ Critical thinking ◆ Creativity and innovation
Vocabulary acquisition	<ul style="list-style-type: none"> ◆ Speed ◆ Time ◆ Distance
Study skills	<ul style="list-style-type: none"> ◆ Group activities ◆ Discussion ◆ Supervised activities
Revision	Revision activity
Assessment	Ability to describe how to solve mathematical problems involving time, speed and distance.
Learning outcomes	<ul style="list-style-type: none"> ◆ Ability to solve real life problems than involve finding time intervals. ◆ Ability to convert units of time.

Unit 9

Simple interest and problems involving saving

Number of periods	21
Introduction	In this unit, there will be development of different skills respectively about simple interest and problems involving saving.
Classroom organisation	<ul style="list-style-type: none"> ◆ Whole class work ◆ Group work ◆ Pair work ◆ Individual work
Learning and teaching materials	Manila cards, masking tape, scissors and markers.
Activities	Solving problems involving simple interest and saving.

Competences practised	<ul style="list-style-type: none"> ◆ Co-operation ◆ Effective communication ◆ Critical thinking ◆ Creativity and innovation
Vocabulary acquisition	<ul style="list-style-type: none"> ◆ Simple interest ◆ Rate ◆ Time ◆ Principle
Study skills	<ul style="list-style-type: none"> ◆ Group activities ◆ Discussion ◆ Demonstration by the teacher
Revision	Revision activity
Assessment	Ability of solving word problem involving simple interest, time, rate and principle.
Learning outcomes	Solving word problem involving simple interest, time, rate and principle.

Unit 10

Equivalent expressions and number sequences

Number of periods	20
Introduction	In this unit, there will be development of different skills respectively about equivalent expressions and number sequences.
Classroom organisation	<ul style="list-style-type: none"> ◆ Whole class work ◆ Group work ◆ Pair work ◆ Individual work
Learning and teaching materials	Charts, flash cards markers and scissors.
Activities	Simplify equivalent fractions like terms and unlike terms. Solving equations.

Competences practised	<ul style="list-style-type: none"> ◆ Communication ◆ Team work ◆ Problem solving
Vocabulary acquisition	Like terms and unlike terms.
Study skills	<ul style="list-style-type: none"> ◆ Group discussion ◆ Practical work to put learnt concepts into practice ◆ Class demonstrations
Revision	Revision activity
Assessment	Ability of simplifying like terms and unlike terms.
Learning outcomes	Ability of simplifying like terms and unlike terms.

Unit 11

Solving simple algebraic equations and inequalities

Number of periods	12
Introduction	In this unit, there will be development of different skills respectively about solving simple algebraic equations and inequalities.
Classroom organisation	<ul style="list-style-type: none"> ◆ Whole class work ◆ Group work ◆ Pair work ◆ Individual work
Learning and teaching materials	Simple arm balances and some standard masses or ones prepared by the teacher.
Activities	Class discussion. Solving simple algebraic equations and inequality
Competences practised	<ul style="list-style-type: none"> ◆ Team work ◆ Effective communication ◆ Creativity and innovation
Vocabulary acquisition	Simple algebraic expression
Study skills	<ul style="list-style-type: none"> ◆ Class demonstration ◆ Role play and dramatisation ◆ Group discussion
Revision	Revision activity

Assessment	Ability to solve simple algebraic expressions. Solving word problems involving simple algebraic expressions.
Learning outcomes	Ability to solve simple algebraic expressions. Solving word problems involving simple algebraic expressions.

Unit 12

Regular Polygons and Bearings

Number of periods	16
Introduction	In this unit, there will be development of different skills respectively about regular polygons and bearings.
Classroom organisation	<ul style="list-style-type: none"> ◆ Whole class work ◆ Group work ◆ Pair work ◆ Individual work
Learning and teaching materials	Maps of the local area (one between two), protractor, sheets of polygons (not necessarily regular), sheets of regular polygons, polygon cards, technology
Activities	<ul style="list-style-type: none"> ◆ Solving problems related to polygons and bearings ◆ Constructing polygons and conduct operations related to different polygons.
Competences practised	<ul style="list-style-type: none"> ◆ Effective communication ◆ Accuracy ◆ Problem solving ◆ Co-operation
Vocabulary acquisition	<ul style="list-style-type: none"> ◆ Square, rectangle ◆ trapezium, bearing, etc.
Study skills	<ul style="list-style-type: none"> ◆ Discussions ◆ Group work activities ◆ Demonstration
Revision	Revision activity

Assessment	<ul style="list-style-type: none"> ◆ Ability to calculate area and perimeter of square, rectangle, trapezium ◆ Ability to solve problems involving bearing.
Learning outcomes	<ul style="list-style-type: none"> ◆ Ability to calculate area and perimeter of square, rectangle, trapezium ◆ Ability to solve problems involving bearing.

Unit 13

Construction of polygons and nets for cuboids and prisms

Number of periods	18
Introduction	In this unit, there will be development of different skill respectively about construction of polygons and nets for cuboids and prisms.
Classroom organisation	<ul style="list-style-type: none"> ◆ Whole class work ◆ Group work ◆ Pair work ◆ Individual work
Learning and teaching materials	<ul style="list-style-type: none"> ◆ Geometric instruments, scissors, plain paper, manila cards, empty boxes, squares made from card (six per group), masking tape, and squared paper.
Activities	<ul style="list-style-type: none"> ◆ Constructing regular polygons ◆ Identifying nets of prisms, pyramids and cones. ◆ Solve problem related to different regular polygons
Competences practised	<ul style="list-style-type: none"> ◆ Problem solving ◆ Creativity and innovation ◆ Effective communication ◆ Co-operation ◆ Critical thinking
Vocabulary acquisition	<ul style="list-style-type: none"> ◆ Circumference ◆ Pie ◆ Diameter ◆ Volume ◆ Nets

Study skills	<ul style="list-style-type: none"> ◆ Group work activities ◆ Demonstration on round shapes ◆ Discussion
Revision	Revision activity
Assessment	<ul style="list-style-type: none"> ◆ Ability to calculate circumference ◆ Ability to explain Pi ◆ Ability to calculate volume
Learning outcomes	<ul style="list-style-type: none"> ◆ Be able to explain the concept of circumference. ◆ Describe the process of finding circumference ◆ Be able to establish relationship between cubes and cuboids. ◆ Be able to solve mathematical problems on volume of cubes and cuboids.

Unit 14

Area bounded by a circle, surface area of cuboids and volume of a cylinder.

Number of periods	15
Introduction	In this unit, there will be development of different skills respectively about area bounded by a circle, surface area of cuboids and volume of a cylinder.
Classroom organisation	<ul style="list-style-type: none"> ◆ Whole class work ◆ Group work ◆ Pair work ◆ Individual work
Learning and teaching materials	Pairs of compasses, scissors, squared paper, and boxes.
Activities	<ul style="list-style-type: none"> ◆ Finding area bounded by a circle ◆ Finding surface area of cuboids. ◆ Calculating volume of cylinders.
Competences practised	<ul style="list-style-type: none"> ◆ Problem solving ◆ Creativity and innovation ◆ Effective communication ◆ Co-operation ◆ Critical thinking

Vocabulary acquisition	<ul style="list-style-type: none"> ◆ Area bounded by a circle ◆ Volume of cylinder ◆ Surface area
Study skills	<ul style="list-style-type: none"> ◆ Observation ◆ Group discussion ◆ Problem solving ◆ Demonstration
Revision	Revision activity
Assessment	<ul style="list-style-type: none"> ◆ Ability to calculate area bounded by a circle ◆ Ability to calculate surface area ◆ Ability to calculate volume.
Learning outcomes	<ul style="list-style-type: none"> ◆ Ability to calculate area bounded by a circle ◆ Ability to calculate surface are ◆ Ability to calculate volume

Unit 15 Statistics

Number of periods	10
Introduction	In this unit, there will be development of different skills respectively about statistics.
Classroom organisation	<ul style="list-style-type: none"> ◆ Whole class work ◆ Group work ◆ Pair work ◆ Individual work
Learning and teaching materials	Coins, calculators, spreadsheets and data from other subjects.
Activities	<ul style="list-style-type: none"> ◆ Discuss ways of collecting data. ◆ Presenting data using bar-chart and pie-chart. ◆ Interpreting bar chart and pie chart.

Competences practised	<ul style="list-style-type: none"> ◆ Problem solving ◆ Creativity and innovation ◆ Effective communication ◆ Co-operation ◆ Critical thinking
Vocabulary acquisition	<ul style="list-style-type: none"> ◆ Presenting data ◆ Interpreting data
Study skills	<ul style="list-style-type: none"> ◆ Practical work. ◆ Group activities. ◆ Discussion. ◆ Demonstration. ◆ Data collection and presentation.
Revision	Revision activity
Assessment	<ul style="list-style-type: none"> ◆ Ability to explain that random events have different likelihood of occurring and recognize associated vocabulary. ◆ Ability to conduct experiments and record outcomes systematically. ◆ Ability to use the vocabulary of likelihood to compare events.
Learning outcomes	<ul style="list-style-type: none"> ◆ Ability to describe how to represent information using tables and bar-graph. ◆ Ability to explain the process of interpreting and extracting information from tables.

Unit 16 Probability

Number of periods	16
Introduction	In this unit, there will be development of different skills respectively about probability.
Classroom organisation	<ul style="list-style-type: none"> ◆ Whole class work ◆ Group work ◆ Pair work ◆ Individual work
Learning and teaching materials	Dice, coins, and cards with events.
Activities	<ul style="list-style-type: none"> ◆ Tossing a coin ◆ Tossing a dice ◆ Tossing a bottle top ◆ Having a debate activity
Competences practised	<ul style="list-style-type: none"> ◆ Problem solving ◆ Creativity and innovation ◆ Effective communication ◆ Co-operation
Vocabulary acquisition	Vocabulary of chance.
Study skills	<ul style="list-style-type: none"> ◆ Practical work ◆ Group activities ◆ Discussion ◆ Demonstration ◆ Supervised activities
Revision	Revision activity
Assessment	To be able to order events in terms of likelihood
Learning outcomes	To be able to order events in terms of likelihood

Unit 1

Reading, Writing and Comparing Whole Numbers beyond 1,000,000

Key unit competence: To be able to read, write and compare whole numbers beyond 1,000,000.

List of lessons

Lessons	Number of lessons	Number of periods
1.1 Reading and Writing Numbers Beyond 1,000,000 in words.	1	1
1.2 Reading and Writing Numbers Beyond 1,000,000 in Figures.	1	1
1.3 Finding Place Value and Values of Numbers up to 7 Digits.	1	1
1.4 Comparing Numbers Using $<$, $>$ or $=$	1	1
1.5 Arranging Numbers in Ascending and Descending Order.	1	1
1.6 Adding Numbers Beyond 1,000,000	1	1
1.7 Solving Problems Involving Addition of Numbers Beyond 1,000,000.	1	1
1.8 Subtracting Numbers Beyond 1,000,000	1	1
1.9 Solving Problems Involving Subtraction of Numbers Beyond 1,000,000.	1	1
1.10 Multiplying Numbers Beyond 1,000,000	1	1
1.11 Solving Problems Using Calculation Strategies on Multiplication.	1	1
1.12 Dividing Numbers Beyond 1,000,000	1	1
1.15 Solving Problems Using Calculation Strategies on Division.	1	1
1.14 Rounding off Whole Numbers to the Nearest Ten.	1	1
1.15 Rounding off Whole Numbers to the Nearest Hundred and Thousand.	1	1
1.16 Rounding off Whole Numbers to the Nearest Ten Thousand, Hundred Thousand and Million.	1	1
Assessment	1	2
Total	17	18

Guidance on problem statement

In this unit, we will be dealing with reading, writing and comparing whole numbers which are crucial in daily life.

Here you may predict what will be seen throughout this unit by providing challenging questions. Take learners through the introduction in the Learner's Book page 1. Help them to have open mind about the general idea of this unit through the following questions.

- (a) What do you think may be your challenge to answer the question?
- (b) As P6 learners, give the advise on how you may overcome it?

Cross cutting issues addressed

Throughout the teaching process of this unit, it will be crucial to help learners to master the content and it is better to address cross-cutting issues where possible. So, in this unit we will address the following cross-cutting issues as non-stand alone within classroom activities and throughout the development of the content.

- **Peace and value education:** First of all as a teacher, you have to be a peace maker in your class and role model so that learners will imitate how you behave. When there is any conflict, do not leave without helping to solve it within the lesson. Encourage learners to behave well ,being humble,honest,etc through peaceful group discussions, interaction among different groups, peaceful resolutions to come up with a general outcome, all address this cross cutting issue during a Mathematics lesson.
- **Gender Education:** This cross-cutting issue will be addressed through giving equal opportunities to both boys and girls during the lesson.
- **Financial Education:** This should be addressed via a problem that implies the way of using money that encourages learner to well handle money, save and invest.

Learning objectives

Knowledge and understanding

- Identify the place values of digits beyond 1,000,000.
- Read written numerals correctly in figures or in words.
- Explain the concept of adding a 7 digit number with a 7 digit number which involves carrying (re-grouping).
- Explain the concept of subtracting larger numbers with borrowing.
- Explain the concept of multiplying larger numbers.
- Explain the concept of dividing a 7-digit number by a 3-digit number.

- Describe the steps taken when rounding off numbers.

Skills

- Compare numbers using $>$, $<$, $=$.
- Calculate numbers involving addition, subtraction, multiplication and division.
- Explain how to round off numbers.
- Solve problems involving addition, subtraction, multiplication and division.

Attitudes and values

- Appreciate the importance of accuracy in reading and writing numbers and assessing how big they are.
- Learners should respect others when they are working in a group.

Number of lessons: 18

Guidance for classroom organisation

Before starting a lesson, use warm-ups or energizers in order to engage learners into the lesson. Do not focus on this only, try to be creative. The essence is to motivate learners and make them active throughout the teaching-learning process. Help learners to form groups before assigning them an activity.

While they are doing the activity, walk around monitoring their work and helping where they have challenges.

Learning and teaching materials for the unit

Manila cards or slips of paper, markers, flash cards, pencils, pens, chalk and other materials that a teacher may see as important to achieve his/her objective.

Lesson 1.1

Reading and writing numbers beyond 1,000,000 in words (40 minutes)

Learner's Book page 1

- Help the learners to form groups of a certain number according to classroom size and arrangement.
- Give mental work related to reading whole numbers.
- Review writing large numbers up to 1,000,000 in figures studied in P.5.
- Give each group cards where numbers are written in words and in figure.
- Take them through the activity in the Learner's Book, page 1 and 2.

Development

- Guide learners as they match number figures to their corresponding number words. Correct the errors in the use of English language.
- Ask learners who have the card with in the figure to raise them up.
- Ask learners who have the cards with number in words to join the correspondence.
- Ask them to explain to the class.
- Let the whole class match the corresponding numbers in figures to words in their books.
- Let them present their work.
- Applaud those who match the numbers correctly.
- Make sure that all learners are fully engaged in the lesson by using the methodology that involves all of them.
- Do not continue to another step without knowing the progress of the learners.
- Give learners opportunity to: discuss, present, write, make research and think critically through working together in groups, sharing roles in their groups.
- Ask learners to study the examples in the Learner's Book, page 2.
- Explain that, a table of place values is used for placing in the digits in their corresponding place value and that, periods are read out after every comma.
- Learners should be led to observe that each period has ones, tens and hundreds, and each period is read once.
- When placing digits in the place value table, digits are started from the right, that is from (ones) to the left (millions).
- Give learners opportunity to express their ideas about the working steps, and then manage them by giving positive and constructive feedback.
- Do not hesitate to provide your own examples. The essence is to help learners develop their mathematical skills.

Conclusion

- Refer to the study tip, and ask learners to read it aloud such that they internalise it.
- Ask learners to attempt application 1.1 on page 3.
- Correct their work.
- Give them feedback.
- Help them to make a summary, then make a conclusion.
- Ensure that learners do not confuse hundreds and tens of the periods with hundreds and tens of units.
- Confirm that the learners correctly translate numerals in Kinyarwanda and spoken English.
- Let them take some notes.

Remedial Exercise

Slow learners can read then write simple figures in words:

- | | | |
|-------------|-------------|------------|
| (1) 542 | (2) 2,340 | (3) 53,167 |
| (4) 863,427 | (5) 907,700 | |

Additional Exercise

Fast learners can try to read and write more large figures in words:

- | | | |
|----------------|-----------------|-----------------|
| (1) 13,007,507 | (2) 18,150,015 | (3) 36,063,363 |
| (4) 81,091,909 | (5) 100,000,000 | (6) 408,410,089 |

Lesson 1.2**Reading and writing numbers beyond 1,000,000 in figures
(40 minutes)**

Learner's Book page 3.

Introduction

- Review reading and writing numbers beyond 1,000,000 in words.
- Distribute the learners into groups.
- Take them for warm up.
- Distribute number cards and number word cards that you prepared among the learners.
- Guide learners as they match the number figures and number words on the flash cards.
- Ask learners who have the card with in figures to raise them up.
- Ask those who have the cards with number in words to join the correspondence.
- Ask them to explain to the class.
- Let the whole class match out in the classwork books.
- Lead the learners through the examples in the Learner's Book, page 4.
- Explain that periods tell the number of zeros, i.e, millions have 6 zeros, thousands have 3 zeros and that every period possesses three place values, i.e, hundreds, tens and ones.
- Number words without a period are under units, for example, seven hundred, five, twelve etc.
- Explain that number words are arranged from the biggest to the smallest and so are their corresponding figures. Then add the figures
- Ask learners to practise more by forming their own numbers then write them in words.

Conclusion

- Ask learners to read the study tip aloud to your and every one's satisfaction.
- Let them discuss it by adding their point of view.
- Let them attempt Application 1.2 in the Learner's Book page 4.
- Mark them and help them to find the answers.
- Let them take notes.
- Stress the importance of periods in determining figures.
- Remind learners about vertical arrangement of figures in their respective place values.
- Observe correct use of spoken and written English.

Remedial Exercise

Slow learners can write simple number words in figures:

1. Twelve thousand.
2. One hundred fifteen thousand.
3. Sixteen thousand five hundred eleven.
4. One hundred eighteen thousand, four hundred ten.

Additional Exercise

Fast learners can write more large number words in figures:

1. Three million three thousand three.
2. Thirteen million three.
3. Sixty-seven million, seventy six thousand, six hundred sixteen.
4. Ninety-nine million, ninety nine thousand nine hundred nine.
5. One hundred twelve million, six hundred fourteen thousand eight hundred forty-two.

Lesson 1.3**Finding place values and values of numbers up to 7 digits
(40 minutes)**

Learner's Book, page 5 and 6

Introduction

- Review describing place value and value.
- Revisit place values and values up to 7 digits done in primary 5.
- Let them brainstorm about it.
- Take learners through the activity in the Learner's Book, page 5
- Choose seven learners and call them in front.
- Ask them to each pick one number card from the table.

- Let them line with the number cards arranged according to the figure in the respective place value.
- Let the learners discuss the procedure as you guide them.

Development

- Use the abacus and let them use beads to represent the numbers.
- They will find work easy because part of it was experienced in the lower classes.
- Now ask learners to write their own numbers on slips of paper.
- Ask them to write down the place value of each digit on slips of paper, then their corresponding values.
- Now refer to the example on the prepared chart and guide learners as they follow the procedure by discussion.
- Refer to the examples in the Learner's Book page 5 and 6.
- Let learners continue studying and discussing the steps.
- Ask them to write down numbers of their choice again, then go through the procedure as explained in the examples.

Conclusion

- Let them discuss the study-tip.
- Then let them attempt Application 1.3 in Learner's Book, page 6.
- Help them to harmonise what they think should be added.
- Give them time to sum up. Answers and correct the work.
- Let them take notes.
- Emphasise that, in order to find the value of digits of given numerals, use a place value table.
- Then, to find the value, work out the product of the digit and its place value.
- Ensure every learner is actively involved.
- Let learners attempt the following exercises.

Remedial Exercise

Slow learners can find the place values of the underlined digits.

(1) 436 (2) 482 (3) 1,567

(4) 46,642 (5) 287,409

Additional Exercise

Fast learners can try to find the place value of a number given that;

- (1) its value is 80,000 (2) its value is 8,000,000
 (3) its value is 90,000,000 (4) its value is 300,000,000
 (7) What is the sum of the values of 6 and 9 in 9,604,050?
 (5) What is the product of the values of 8 and 2 in 1,848,212?

Lesson 1.4**Comparing numbers using $<$, $>$ or $=$
(40 minutes)****Learner's Book page 7****Introduction**

- Take learners through warm-up or a song.
- Give them time to recall the previous lesson.
- Help them to form groups of members according to the classroom size and arrangement.
- Give mental work as a review of the previous lesson.
- Distribute the learning materials in the respective groups.
- Take learners through the activity in the Learner's Book, page 7.

Development

- Provide two sacks one containing rice and the second any other thing you can compare. Ask learners to explain which one is heavier than the other.
- Ask them to estimate the mass for each item then write it down.
- Lead learners to remember that; the symbol $>$ means "greater than" $<$ means "less than" or smaller than.
- Most learners have the right hand stronger than the left hand. So, standing, demonstrate the right hand folded in a way that illustrates the symbol $>$ and the left hand symbolises $<$.
- Let learners continue comparing numbers of their own.
- Now refer the learners to the examples on the chart, then the examples in the Learner's Book page 7 and 8.
- Let the learners study and discuss the examples.

Conclusion

- Guide learners as they read aloud the Study tip.
- Let them write down their observation.
- Now ask learners to attempt Application 1.4 in the Learner's Book, page 9.
- Mark their work and give them feed back.
- Let them write notes in their note books.
- Some learners may be confused with the signs for comparing numbers. Improvise methods of making them remember.
- The use of a place value table is the best method for comparing numbers.
- Let learners attempt the following:

Remedial Exercise

Let slow learners compare the pairs of numbers below using the symbols $>$, $<$ or $=$.

(1) 617 413

(2) 218 281

(3) 451 432

(4) 804 082

Additional Exercise

Fast learners can try out the following;

1. 1 kg of stones one kg of cotton wool

2. 1 tonne 100 kg

3. 1,000 ml 1000 cc

4. 1.2 litres 2.1 millilitres

5. 10 grosses 10 dozens

6. 15 litre bottles 20 half litre bottles

Lesson 1.5**Arranging numbers in ascending and descending order
(40 minutes)**

Learner's Book, page 10.

Introduction

- Review comparing whole numbers which was handled in the previous lessons.
- Group the learners and carry out the activity in the Learner's Book, Page 10.
- Let them report their findings.

Development

- Lead learners to realise that in order to compare how bigger or smaller a number is than another, a place value table is used.
- Draw a place value table on the chalkboard and place in it the number on cards.
- Confirm that the order of ascending is arranging from the smallest to the biggest number.

That is: 942,407; 942,704; 1,496,066; 1,496,606

- In descending order, the arrangement is: from the biggest to the smallest, so it is 1,496,066; 942,704; 942,407.

Ask the learners to study the example in the Learner's Book page 10.

- Let them follow through as they discuss the procedure.
- In the previous lesson, they learnt about comparing two numbers using the place value table. So, it is a continuation only that in this lesson, more than two numbers are compared.

Conclusion

Guide learners through the study tip. Use it sum up the experience during the lesson.

- Let them attempt Application 1.5 in the Learner's Book, page 11.
- Mark their work and give feedback.
- Help them to make correction.
- Let them take notes.

Remedial Exercise

Slow learners can arrange the following numbers in:

(a) ascending order

(b) descending order

746;	652;	1072;	6,142
1,555;	1,632;	1,028;	1,606
4,404;	4,044;	4,444;	4,404
12,096;	12,960;	12,690;	12,069

Additional Exercise

Fast learners can arrange the following numbers in:

(a) Order the numbers in ascending order:

(b) Order the numbers in ascending order:

11,011,011;	11,101,011;	11,011,111	11,001,101;	11,111,111
15,150,015	15,015,015;	15,150,150	15,005,515;	15,155,105
99,099,999	99,990,099	99,990,009	99,909,009	99,009,009
101,101,101	101,100,011	111,111,111	100,111,111	101,110,011

Lesson 1.6

Adding numbers beyond 1,000,000 (40 minutes)

Learner's Book, page 11.

Introduction

- Take learners into respective group of 5 or 4 learners.
- Let them brain storm on previous lesson.
- Let learners present the key concept of the previous lesson.
- Distribute the prepared materials to the groups.

Development

- Take learners through the activity in Learner's Book page 11.
- Instruct them to arrange the card in vertical order by their place value.
- Request them to work out the sum of the numbers.
- Ask them to share with the class.

- Let them compare the answers from different groups.
- Take them through examples in Learner's Book page 12 and 13.
- Ask learners to share what they have experienced in pairs.

Conclusion

- Let learners write down the examples work on chalkboard in the note books.
- Take them through the study tip.
- Give them time for discussing it.
- Assign them Application 1.6 page 13.
- Mark their work.
- Help them to do corrections.
- Let them write notes in their note book.

Lesson 1.7

Solving problems involving addition of numbers beyond 1,000,000 (40 minutes)

Learner's Book, page 14.

Introduction

- Form manageable groups among the learners.
- Read for them the instruction of the activity page 14.
- Hand out the suggested instructional materials.
- Let the learners carry out the activity as shown in the Learner's Book, page 14.

Development

- Allow each group to present its results before class.
- Next, give two examples on the chalkboard, one should be for adding without carrying and the other with carrying.

Example 1: Add: $2,468,240 + 4,100,732 + 2,101,001$.

- Inform learners that adding is better done by arranging the numerals vertically according to their place values.

	M	HTh	TTh	Th	H	T	O
	2	4	6	8	2	4	0
	4	1	0	0	7	3	2
+	2	1	0	1	0	0	1
	8	6	6	9	9	7	3

Add digits in respective place value)

Ones $\rightarrow 0 + 2 + 1 = 3$

Tens $\rightarrow 4 + 3 + 0 = 7$

Hundreds $\rightarrow 2 + 7 + 0 = 9$

Thousands $\rightarrow 8 + 0 + 1 = 9$

Ten Thousands $\rightarrow 6 + 0 + 0 = 6$

Hundred thousands $\rightarrow 4 + 1 + 1 = 6$

- Lead learners to realise that the sums are single digits, so there is no re-grouping.

Example 2: Add: 3,642,598; 1,386,513; 1,809, 429 and 5,149,823

(Arrange vertically according to place values)

	M	HTh	TTh	Th	H	T	O
	3	6	4	2	5	9	8
	1	3	8	6	5	1	3
	1	8	0	9	4	2	9
+	5	1	4	9	8	2	3
1	1	9	8	8	3	6	3

Units

- Add ones: $8 + 3 + 9 + 3 = 23$, = 2 tens, 3 ones. Write 3 under ones, then carry 2 tens to the place value for tens.
- Add tens: $2 + 9 + 1 + 2 + 2 = 16$, = 1 hundred 6 tens. Write 6 tens under tens, then carry 1 to hundreds.
- Add hundreds: $1 + 5 + 5 + 4 + 8 = 23$, 2 thousands, 3 hundreds. Write 3 hundreds under hundreds, then carry 2 to thousands.

Thousands

- Add thousands: $2 + 2 + 6 + 9 + 9 = 28$, = 2 ten thousands, 8 thousands, write 8 under thousands and carry 2 ten thousands. Continue the method.
- Add ten thousands: $2 + 4 + 8 + 0 + 4 = 18 = 1$ hundred thousands, 8 ten thousands.
- Add hundred thousands: $1 + 6 + 3 + 8 + 1 = 19 = 1$ millions, 9 hundred thousands.

Millions

- Add Millions: $1 + 3 + 1 + 1 + 5 = 11$, 1 ten millions, 1 millions.
- Explain thoroughly that, when we get a total with 2 digits, it means there are two groups. So we do what is known as carrying or re-grouping by writing the digit to the right in that very place value and carrying the second digit to the left to the next place value.
- Refer the learners to the example in the Learner's Book, page 14.

Conclusion

- Let learners read and interpret the Study tip before attempting Application 1.7 that follows.
- Mark their work and give feed back.

- Let learners summarise the lesson.
- Let them highlight the measure process of the work.
- Explain the concept of addition of numbers exhaustively when re-grouping so that learners do not get confused.
- Lead learners to realise that though we add single digits, but they are values according to place values.
- Reading and interpreting in English language is paramount to understanding how to solve an addition problem.
- Addition is a prerequisite in trade.

Remedial Exercise

Slow learners can try out simple addition problems.

- (1) Add: $123 + 92 + 1$ (2) $15 + 110 + 3,125$ (3) $3 + 62 + 144 + 9,900$
 (5) In P.6, there are 14 boys and 26 girls. Find the total.
 (6) In a school library, there are 144 Mathematics textbooks, 162 English textbooks, 162 Social Studies textbooks and 202 Science textbooks. How many textbooks are there?

Additional Exercise

Fast learners can try out more complex numbers.

1. Add: 2 groups of 11,076,820 and 3 groups of 19,446,213.
2. There are 4 peace baskets in a store. Each contains 1,672,015 beads. In the kitchen there are 3 peace baskets each containing 1,205,110 beads. What is the sum of all the beads?
3. Eleven water bottles contain 650 ml each. 6 other water bottles contain 500 m// each. How many milliliters are in all the water bottles?

Lesson 1.8

Subtracting of numbers beyond 1,000,000 (40 minutes)

Learner's Book, page 15.

Introduction

- Give learners mental work about simple subtraction of numbers, for example, $47 - 40$, $60 - 45$, $100 - 99$ e.t.c.
- Review the previous lesson.
- Distribute the suggested instructional materials in the groups.

Development

- Let learners study the activity in the Learner's Book, page 15.
- Ask them to work it out.
- Request them to share their procedure and results with the class.
- Let them compare the answers from other groups.

- Refer the learners to the examples in the Learner's Book, page 16 and 17.
- Give some more examples for the learners to do more practice.

Example: Subtract: 1,467,342-984,607

- Emphasize proper vertical arrangement of the digits in their respective place values. Then, subtract the digits in their corresponding place values.

	M	HTh	TTh	Th	H	T	O
	1	134	16	67	13	34	12
-		9	8	4	6	0	7
		4	8	2	7	3	5

- Ask learners to share their experience.

Conclusion

- Let learners read and interpret the study tip.
- Learners then attempt Application 1.8 in the Learner's Book, page 17.
- Collect the work.
- Mark it and give feed back.
- Help them to do corrections.
- Let them write the notes in their note books.

Lesson 1.9

Solving problems involving subtraction of numbers beyond 1,000,000 (40 minutes)

Learner's Book page 18.

Introduction

- Take learners through warm-up of your choice.
- Help them to form groups.
- Group learners and give them learning materials..
- Group learners and distribute the instructional materials as suggested.
- Let the learners in their groups carry out the activity as laid out in the Learner's Book. Give them chance to report their findings.
- Refer them to the example in the prepared chart.
- Ask them to study it, then discuss the procedure as group.
- Tell learners that in subtraction sometimes there is borrowing or regrouping.
- Write some examples on the chalkboard. Include word problems too.

Example 1: Subtract: 8,712,013 – 3,258,609

(Arrange in vertical order by place values)

	M	HTh	TTh	Th	H	T	O
	8	57	101	112	10	01	13
-	3	2	5	8	6	0	9
	5	4	5	3	4	0	4

Units

- Subtract ones: $3 - 9$ (not possible) borrow 1 ten from 1 tens. $1 \text{ ten} + 3 \text{ ones} = 10 + 3 = 13$, $13 - 9 = 4$.
- Subtract tens: $0 - 0 = 0$.
- Subtract hundreds: $0 - 6$ (not possible, borrow 1 thousand from 2 thousands. $1 \text{ thousand} = 10 \text{ hundreds}$ $10 + 0 = 10$, $10 - 6 = 4$).

Thousands

- Subtract thousands: $1 - 8$ (not possible, borrow 1 ten thousand from 1 ten thousands. $1 \text{ ten thousand} = 10 \text{ thousands}$. $10 + 1 = 11$, $11 - 8 = 3$).
- Subtract ten thousands: $0 - 5$ (not possible, borrow 1 hundred thousands from 7 hundred thousands. $1 \text{ hundred thousands} = 10 \text{ ten thousands}$. $10 + 0 = 10$, $10 - 5 = 5$).
- Subtract hundred thousands: $6 - 2 = 4$.

Millions

- Subtract Millions: $8 - 3 = 5$.
- Explain the process such that all the learners get to understand better.
- Refer to the example in the Learner's Book, page 18.
- Answer any questions they ask to help them master the concept.

Conclusion

- Let the learners read loudly the Study tip and thereafter, attempt the Application in the Learner's Book, 19.
- Mark their work and give feed back.
- Let them summarise the lesson.
- Let them highlight the measure process of the work.
- Put emphasis on the steps involved in borrowing from the next place value.
- Emphasise the importance of vertical arrangement according place values.
- Units must be placed along side the answers.
- Difference, minus, reduce, decrease, take away mean subtraction.

Remedial Exercise

Slow learners can try out simple subtraction problems.

- (1) $554 - 217$ (2) $316 - 305$
 (3) $666 - 333$ (4) $23,268 - 12,048$
 (5) In a school of 900 learners, 493 are boy. How many are girls?

Additional Exercise

Fast learners may try out more challenging numbers:

4. $354,542,460 - 340,562,564$
 5. Ndikumana bought a plot of land at 345,687,000 FRW. He paid 250,000,000 FRW cash and promised to clear the remaining amount after one month. How much is he supposed to pay?

Lesson 1.10**Multiplying numbers beyond 1,000,000 (40 minutes)****Learner's Book page 20.****Introduction**

- Review the previous lesson.
- Distribute learners in manageable groups.
- Give out the learning aids to the groups.

Development

- Take the learners through the activity in the Learner's Book, page 20.
- Let them report their outcomes in groups.
- Let the learners share the outcomes with others.
- Ask learners to study the example on page 20.
- Guide them with the procedure. How do they compare it with the procedure of the activity?
- Let learners realise that the multiplicand is multiplied by ones, then tens then hundreds of the multiplier. Then the sum of the products is worked out to get the answer.
- Display the prepared chart.
- Ask learners to follow through as you guide them.
- Let them formulate their own subtraction problems.
- Let the learners try this one.

Example: Multiply: $46,307 \times 132$

$$\begin{array}{r}
 46307 \\
 \times 132 \\
 \hline
 92614 \quad (46,307 \times 2) \text{ ones} \\
 1389210 \quad (46,306 \times 30) \text{ tens} \\
 + 4630700 \quad (46,307 \times 100) \text{ hundreds} \\
 \hline
 6,112,524
 \end{array}$$

- Ask learners to mention their challenges in case there is any.

Conclusion

- Refer the learners to the study tip on page 20.
- Ask them to read it and make further discussion about it.
- Ask learner to attempt Application 1.10.
- Let them summarise the lesson.

Remedial Exercise

(a) 123×12

(b) 444×11

(c) 625×12

(d) 1052×20

Additional Exercise

Fast learners should try more brain challenging questions:

(1) $9,625,348 \times 422 =$

(2) $6,346,916 \times 199 =$

(3) $5,505,505 \times 455 =$

(4) $4,989,606 \times 394 =$

Lesson 1.11**Solving problems using calculation strategies on multiplication (40 minutes)**

Learner's Book, page 21.

Introduction

- Give mental work on previous lesson.
- Let learners exchange ideas
- Group learners and distribute the suggested instructional materials to each group.

Development

- Guide the learners through the procedure of the activity in the Learner's Book page 21.
- Take them through the instructions of the activity.
- Let learners report their findings of each group.
- Let other groups reflect on other groups.
- Now, write an example on the chalkboard.
- Take them through it.

Example: Multiply: $55,243 \times 160$

Inform learners that there are two methods which can be applied: multiplying the multiplicand by ones, tens and hundreds separately, then add. Another method is about using the long method. In the example below, one method has been used. Endeavor to take them through the second method.

$$\begin{array}{r}
 55243 \\
 \times 160 \\
 \hline
 00000 \quad (55,243 \times 0) \\
 3314580 \quad (55,243 \times 60) \\
 + 5524300 \quad (55,243 \times 100) \\
 \hline
 8,838,880
 \end{array}$$

- Learners have already been exposed to the progressive multiplication, that

is multiply place value by place value e.g 4 tens \times 1 hundred.

- Refer to the examples in the Learner's Book, page 21.
- Let the learners follow the procedure as you guide them.

Conclusion

- Let them read and internalise the Study tip related to multiplication.
- Ask learners to attempt Application 1.11.
- Make sure learners are aware of the order of multiplication, i.e one by one of units, one by tens, one by hundreds etc.
- Always give the learners a chance to try before you explain a concept.

Remedial Exercise

Let slow learners do the following question:

1000	50000	1520	2150
(a) $\begin{array}{r} \underline{} \\ \times 15 \\ \hline \end{array}$	(b) $\begin{array}{r} \underline{} \\ \times 8 \\ \hline \end{array}$	(c) $\begin{array}{r} \underline{} \\ \times 12 \\ \hline \end{array}$	(d) $\begin{array}{r} \underline{} \\ \times 15 \\ \hline \end{array}$

- (e) There are 125 oranges in a sack. How many oranges are there in 15 such sacks?

Additional Exercise

Fast learners should work out more challenging questions:

- (1) $3,567 \times 2,105$ (2) $47,798 \times 135$
 (3) $354,687 \times 90$ (4) $567,897 \times 952$
 (5) A train carries 6,500 passengers. How many people are carried by 450 such trains.

Lesson 1.12

Dividing numbers beyond 1,000,000 (40 minutes)

Learner's Book page 22.

Introduction

- Give mental work about simple division, e.g, $12 \div 6$; $32 \div 8$; $48 \div 6$; $100 \div 20$.
- Review the previous lesson.
- Group the learners and distribute the suggested instructional materials to each group.
- Let them carry out the activity as suggested in the Learner's Book page 22.

Development

- Individual groups should present their work to the class.
- Explain that when dividing, we get the number of times a dividend is divided by the divisor.
- Lead the learners through the examples in the Learner's Book, page 23.

- Explain in detail the procedure as displayed in the examples.
- Give some more examples for the learners to do more practice.

Conclusion

- Let learners formulate their own problems.

Remedial Exercise

Slow learners can attempt these:

- | | |
|------------------|-------------------|
| (a) $124 \div 4$ | (c) $200 \div 20$ |
| (b) $168 \div 4$ | (d) $960 \div 12$ |

Additional Exercise

Fast learners can attempt the following:

- | | |
|----------------------------------|-----------------------------------|
| (a) $(246,334 \times 12) \div 8$ | (b) $(200 \div 20) \times 10$ |
| (c) $(625,103 \times 24) \div 6$ | (d) $(19,0004 \div 12) \times 12$ |

Lesson 1.13

Solving problems using calculation strategies on division (40 minutes)

Learner's Book page 24.

Introduction

- Begin by giving some simple numbers on division
- Review multiplication of large numbers.
- Group the learners and hand out the suggested instructional materials.
- Let the learners carry out the activity in the Learner's Book, page 24.
- Guide them as they carry out the activity.
- Let each group present its results.

Development

- Explain to the learners that the activity they have been involved in is about dividing.
- Tell them that sharing, breaking into parts, distributing, rationing all mean dividing.
- Display the example you prepared on a chart. Allow them to ask questions where they have not understood.

Example: Divide: $1,164,150 \div 130$

- Ask them to copy the question on sheets of paper, then try to work it out.
- Encourage them to use the long division method.

$$\begin{array}{r}
 8955 \\
 130 \overline{) 1,164,150} \\
 \underline{- 1,040} \\
 1,241 \\
 \underline{- 1,170} \\
 715 \\
 \underline{- 650} \\
 650 \\
 \underline{- 650} \\
 000
 \end{array}$$

The divisor is a 3-digit number which is bigger than the first three digits in the dividend.

So we start with 4 digits from the left of the dividend).

$1,164 \div 130 = 8 \text{ rem } 124$, because $130 \times 8 = 1,040$.

$1,241 \div 130 = 9 \text{ rem } 71$, because $130 \times 9 = 1,170$

$715 \div 130 = 5 \text{ rem } 65$, because $130 \times 5 = 650$

$650 \div 130 = 5 \text{ rem } 0$

- Give learners more examples and follow the process as they calculate

Conclusion

- Give some examples involving dividing numbers beyond 1,000,000.
- Follow through the examples in the Learner's Book, page 24.
- Let learners read and internalise the Study tip before attempting Application 1.13, page 25.
- Division always tends to challenge most learners. Devise the simplest way they can carry it out efficiently.
- Ensure learners follow the method correctly.

Remedial Exercise

Slow learners can work out simple division questions:

- | | | |
|-----------------------|-----------------------|-----------------------|
| (1) $96 \div 12 = ?$ | (2) $169 \div 13 = ?$ | (3) $100 \div 25 = ?$ |
| (4) $540 \div 12 = ?$ | (5) $108 \div 9 = ?$ | (6) $960 \div 60 = ?$ |

Additional Exercise

Fast learners can work out more challenging questions:

- | | |
|---------------------------|---------------------------|
| (1) $76,708,236 \div 132$ | (2) $75,433,088 \div 128$ |
| (3) $54,768,450 \div 150$ | (4) $34,801,756 \div 148$ |

Lesson 1.14

Rounding off whole numbers to the nearest ten (40 minutes)

Learner's Book, page 25.

Introduction

- Distribute the learners in groups and provide each group with the materials you prepared.
- Refer the learners to the activity in the Learner's Book, page 25.
- Let learners carry out the activity as you guide them.

Development

- Let them make a discussion and there after, a class presentation.

- Explain that “rounding off” means giving an approximate value of a given number with regard to the digits in the required place value and that place value to the right.
- Tell them that a number can either be rounded up, or down.
- Draw a number line on the chalk board and indicate numbers from 0 to 10. Show them the numbers that are nearer to zero than to 10.

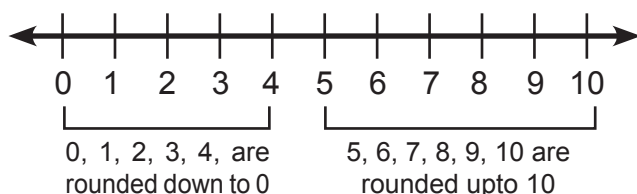

- Write an example on the chalkboard and let the learners copy it on slips of paper.

Example

Round off 3,426,673 to the nearest ten.

- Allow learners to identify the place value of tens and the digit in it.
- Tell them to indicate that digit as the “required place value.”
- Then look to the right and identify the digit nearer to the digit in the required place value.
- Explain that, since the digit to be rounded is in tens, we consider the digit in the ones place value. If the digit in the ones place value is either 0, 1, 2, 3 or 4, the whole number is rounded down. That is, it is expressed as zero (0) and added to the digit in the required place value.
- In this case it is 3. Since it is in the range 1 to 4, it rounded to 0.
- Tell the learners that zero (0) is now added to 7. The place where 3 was is replaced by a zero.

Working

3,426,673

3 is less than 5, it is nearer to 0.
7 is in the required place value.

$$\begin{array}{r}
 3,426,673 \\
 + \quad \quad 0 \\
 \hline
 3,4426,670
 \end{array}$$

So, 3,426,673 rounded to the nearest tens is 3,426,670.

- Give other examples and explain the concept thoroughly and exhaustively.
- Now refer to the examples in the Learner’s Book, page 25 and 26.
- Let them do the examples again.
- Guide them time through the process as they discuss.
- Let them present their working out to class.

Conclusion

- Let the learners read and internalise the Study tip before attempting Application 1.14 on page 27.
- Mark their work and give feedback.
- Help them do the corrections.
- Let them take notes
- Be more explicit when explaining rounding up and rounding down.
- Learners at first may seem confused with the procedure but devise methods of making them understand, more especially what we do to the digits on the right of the required place value.

Remedial Exercise

Slow learners should attempt these:

1. Which numbers are nearer to zero (0) and which are nearer 10?
 (a) 4 (b) 9 (3) 1 (c) 8 (d) 6
 (e) 2, (f) 3 (g) 3 (h) 5
2. Round off to the nearest tens
 ((a) 17 (b) 12 (c) 27 (d) 34 (e) 29

Additional Exercise

Let fast learners round off the following to the nearest tens.

- | | | |
|---------------|----------------|----------------|
| (a) 1,149,001 | (b) 2,214,100 | (c) 3,625,097 |
| (d) 2,000,201 | (e) 13,100,111 | (f) 21,210,002 |

Lesson 1.15

Rounding to the nearest hundred and thousand (80 minutes)

Learner's Book page 27.

Introduction

- Review rounding off to the nearest ten.
- Group the learners and distribute the learning aids.
- Guide the learners through the procedure of the activity in the Learner's Book, page 27.
- Let learners report their findings.

Development

- Basing on the learners' results and discussion, tell them that, when rounding off numbers to the nearest hundred, first consider the digit in the tens place

value. If it is less than 5, round it down to zero (0). And add it to the digit in the hundreds place value.

- If the digit is 5, 6, 7, 8 or 9, round it up to 10 tens or 1 hundred. Add 1 hundred to the digit in the hundreds place value. Then all the digits to the right should be expressed as (00) (tens and ones).
- Write or dictate an example as the learners write it down on slips of paper.
Example: Round off 4,042,589 to the nearest hundred.
Give learners a chance to locate and identify;
 - (i) the digit in the required place value.
 - (ii) the digit to the right of the required place value, and whether it is rounded down or up.
- Now let them try to work it out.
- Move around supervising them.
- Now explain to those who got challenges as you demonstrate.

4,042,589

4,042,500

Replace **89** with 100 = $\frac{\quad}{100}$

4,042,600

- Now introduce rounding off to the nearest thousand.
- Give an example and guide them through it.

Example: Round off 5,407,603 to the nearest thousand.

Learners should note that;

- (a) the required place value is thousands.
 - (b) 7 is the digit in the required place value.
 - (c) 6 is the nearest digit to the right.
 - (d) 6 is rounded up because it is in the upper limit. 6 is rounded to 1 and 1 is a value of thousands that is 1,000.
- (c) the digits **603** are replaced with 000.

5,407,603

5,407,603

Replace **603** with 1000 = $\frac{\quad}{1\ 000}$

5,408,000

- Now embark on the examples in the Learner's Book, page 27 and 28.
- Follow the learners as they explain the procedure and give remarks.

Conclusion

- Let learners formulate their own problems, work them out, discuss the methods and steps, then make a class presentation.
- If you are satisfied that the concept has been grasped, let them read loudly and internalise the Study tip. Thereafter, attempt Application 1.15.
- Note that the digit transferred to the required place value, is not a mere digit (0) or (1). It is either 0 hundred or 1 hundred.
- A lot of practice is required to grasp the concept thoroughly.

Remedial Exercise

Slow learners can try out the questions similar to the ones below.

Round off the following to the nearest hundred:

(1) 677 (2) 5,687 (3) 4,343 (4) 78,435 (5) 145,687

Round off the following to the nearest thousand:

(a) 45,685 (b) 23,452 (c) 67,465 (d) 23,576

Fast learners can be given more work as an extra-exercise especially word problems. For example;

1. Kayitesi bought a Laptop at 2,134,560 FRW. Round off the figure to the nearest thousands.
2. Nkundimana's monthly expenditure is 1,560,456 FRW. Round off the figure to the nearest hundreds.

Lesson 1.16

Rounding to the nearest ten thousand, hundred thousand and million (80 minutes)

Learner's Book, page 29

Introduction

- Review rounding off to the nearest hundred and thousand.
- Form groups and ask learners to collect the prepared materials.
- Let them carry out the activity in the Learner's Book, page 29.
- Moderate the discussion.
- Now refer to the example on the chart.

Development

- Let learners follow through the procedure, discuss it and make conclusions.
- Give other examples on the chalkboard and ask learners to copy them on sheets of paper.

- Basing on the procedure experienced so far, let the learners try to work them out.

Example: Round off 4,316,738 to the nearest ten thousand.

- 1 is in the required place value.
- 6 is the nearest digit to the right so it is rounded up to 1 ten thousand.
- 1 ten thousand is transferred to the digit in the required place value and that is 1.
- 6,738** are removed and replaced with 0,000.

Now the procedure on actual working is:

4, 3 1 6,7 3 8

$\begin{array}{l} \text{_____} \\ | \\ \text{_____} \\ | \\ \text{_____} \end{array}$
6 is rounded up because it is in the upper limit.
6 is rounded to 10 thousand.
10 thousand = 1 ten thousand
1 is in the required place value

So 1 ten thousand is transferred and added to 1 in the ten thousands place value.

$$\begin{array}{r} 4,310,000 \\ + 10,000 \\ \hline 4,320,000 \end{array}$$

- Introduce rounding off to the nearest hundred thousand with the example.

Example: Round off 8,075,249 to the nearest hundred thousands.

Help learners to realise the following.

- 0 is in the required place value.
- 7 is the nearest digit to the right.
7 is rounded up because it is in the upper limit.
7 is rounded to 10 ten thousands, 10 ten thousands = 1 hundred thousand.
75,249 are replaced with 00,000.

- 1 hundred thousand is transferred to 0 hundred thousand and added to it.

$\begin{array}{l} 8, 0 7 5 , 2 4 9 \\ | \\ \text{_____} \\ | \\ \text{_____} \end{array}$
7 is rounded up to 10
required place value

It becomes $\begin{array}{r} 8,000,000 \\ + 100,000 \\ \hline 8,100,000 \end{array}$

So, 8,075,249 rounded off to the nearest hundred thousand is 8,100,000.

- If time allows, cover rounding off to the nearest millions with the following example.

Example: Round off 4,904,872 to the nearest million.

- Learners are now familiar with the procedure, so they are expected to discuss effectively i.e.,
 - 4 is in the required place value.

9 is rounded up because it is in the upper limit.

9 is rounded to 10 hundred thousands,

10 hundred thousands = 1 million

Add 1 million to 4 million

904,872 is written as 000,000.

4, 9 0 4,8 7 2

$$\begin{array}{r}
 4,000,000 \\
 +1,000\ 000 \\
 \hline
 5,000,000
 \end{array}$$

- Give more examples to the learners to work out on sheets of paper.
- Refer to the examples in the Learner's Book page 24 and 30.
- Let the learners follow through as you guide them.
- Ask them to formulate their own, discuss then make a class presentation.
- Let the groups share the procedure used.

Conclusion

- Learners read the Study tip before attempting Application 1.16.
- Encourage all learners to participate in the activities for them to understand better.
- The digit transferred to the required place value is a ten thousand value, hundred thousand and million value.

Remedial Exercise

Let slow learners study the numbers given below and work out as instructed:
Round off the following to nearest hundred thousand:

Additional Exercise

Give the learners more brain teasing related work to do more practice.

Consolidation Activity

1. Write the following in number words or in figure
 - (a) 1,245,145
 - (b) 2,637,340
 - (c) Eleven million twenty-five thousand, one hundred eleven.
2. What is the place values of the underlined digits:
 - (a) 1,009,667
 - (b) 5,264,568
3. Work out:
 - (a) $9,876,444 + 1,776,000$
 - (b) $265,468 \times 456$
 - (c) $2,233,942 \div 225$

Extension Exercise

- Munyaneza bought 20 kg of beans at 550 FRW per kg and 50 kg of sweet potatoes for 280 FRW per kg. If he paid 5,000 FRW including 2,800 of sweet potatoes.
 - How many kg of sweet potatoes did he pay for?
 - If he bought only 5 kg of beans. Was the money paid enough? Explain
 - Write all the required money in words:
- For each month I save, 15,000 FRW from my salary.
 - How much money will I save for 10 years?
 - What is the value of 5 in the answer of (a)?

Answers to Application 1.1

- Twelve million four hundred fifty six thousand six hundred seventy-eight.
 - Nine million seven hundred thousand nine hundred fifty-six.
 - nine million six hundred forty eight thousand two hundred.
 - Seven hundred twenty one million five hundred sixty nine thousand two hundred sixteen.
- Four hundred fifty six thousand seven hundred.
- Five million four hundred seventeen thousand two hundred fifty seven.
- Four million five hundred sixty five thousand ninety.
- Twelve million four hundred sixty eight thousand two hundred fifty.
- Four million four hundred twelve thousand five hundred sixty seven.
- Nine million nine hundred ninety eight thousand eight hundred eighty eight.

Answers to application 1.2

- | | |
|-----------------|-----------------|
| (1) 15,356,413 | (2) 83,066,230 |
| (3) 800,018,717 | (4) 456,545,200 |
| (5) 512,549,000 | (6) 19,000,000 |

Answers to application 1.3

1. (a)
- | | |
|-----------------|-------------------|
| 2, 3 1 2, 9 8 3 | |
| | Ones |
| | Tens |
| | Hundreds |
| | Thousands |
| | Ten thousands |
| | Hundred thousands |
| | Millions |

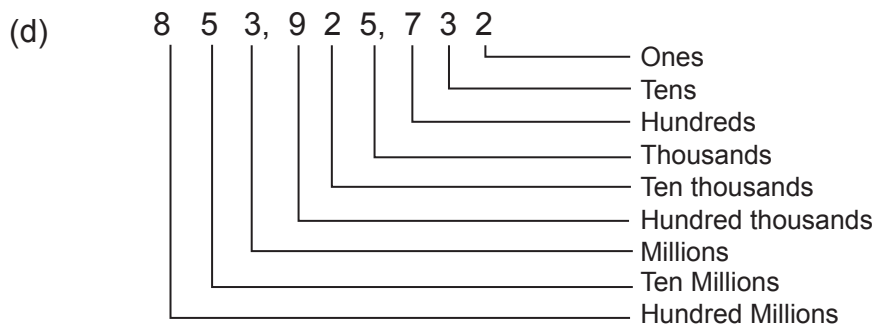
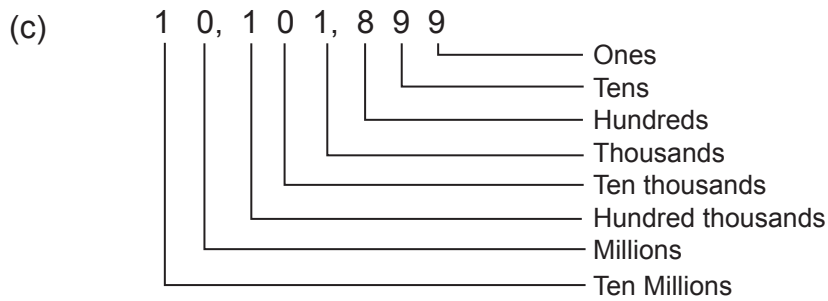
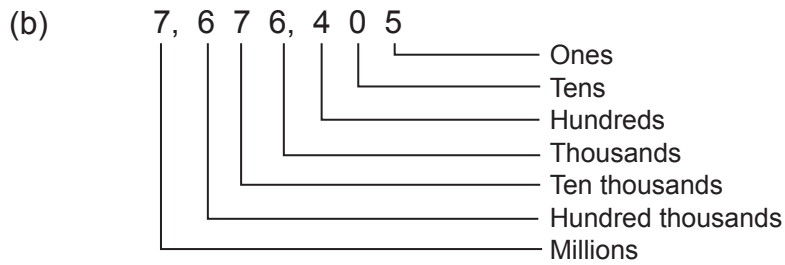

2. (a) 4 - Ones, 4 - Hundred thousand
 (b) 9 - Ten thousands, 3 - Hundred millions
 (c) 3 - Tens, 9 - Thousands
 (d) 5 - Ones, 8 - Ten thousands, 4 - Millions

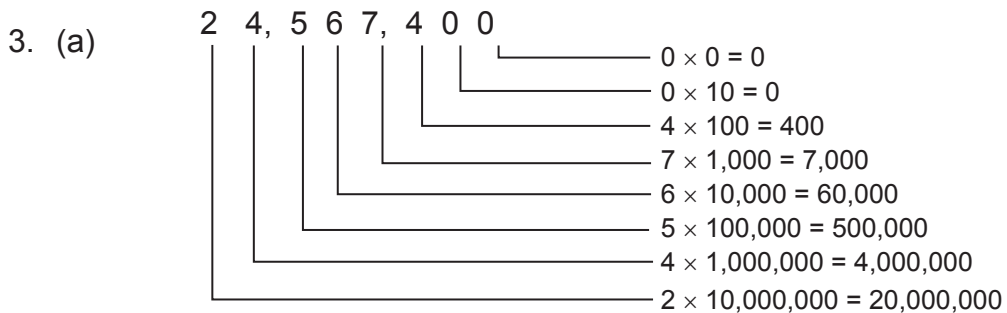

(b) 8 9 4, 5 0 0, 6 7 8

- 8 × 0 = 0
- 7 × 10 = 70
- 6 × 100 = 600
- 0 × 1,000 = 0
- 0 × 10,000 = 0
- 5 × 100,000 = 500,000
- 4 × 1,000,000 = 4,000,000
- 9 × 10,000,000 = 90,000,000
- 8 × 100,000,000 = 800,000,000

(c) 2 0 8, 5 6 7, 1 2 0

- 0 × 0 = 0
- 2 × 10 = 20
- 1 × 100 = 100
- 7 × 1,000 = 7,000
- 6 × 10,000 = 60,000
- 5 × 100,000 = 500,000
- 8 × 1,000,000 = 8,000,000
- 0 × 10,000,000 = 0
- 2 × 100,000,000 = 200,000,000

(d) 1 2 0, 3 9 4, 4 5 6

- 6 × 0 = 0
- 5 × 10 = 50
- 4 × 100 = 400
- 4 × 1,000 = 4,000
- 9 × 10,000 = 90,000
- 3 × 100,000 = 300,000
- 0 × 1,000,000 = 0
- 2 × 10,000,000 = 20,000,000
- 1 × 100,000,000 = 100,000,000

4 (a) $5 \times 100 = 500$
 $5 \times 1,000 = 5,000$
 $4 \times 100,000 = 400,000$

(b) $3 \times 10 = 30$
 $3 \times 10,000 = 30,000$
 $8 \times 10,000,000 = 80,000,000$

(c) $9 \times 10 = 90$
 $6 \times 100,000 = 600,000$
 $1 \times 100,000,000 = 100,000,000$

(d) $2 \times 10 = 20$
 $9 \times 10,000 = 90,000$
 $3 \times 1,000,000 = 3,000,000$

5. By multiplying 6 by its place value.

Answers to application 1.4

1. (a) < (b) > (c) > d) = 2. camille 3. Mukagasana
 4. 103,210frw 5. Hospital B 6. 1st district

Answers to application 1.5

1. (a) 1,065,234; 1,065,342; 1,671,241; 1,673,421
 (b) 2,033,874; 2,303,874; 2,330,874; 2,874,303
 (c) 6,827,623; 8,279,625; 9,623,827; 9,827,623
 (d) 4,116,305; 4,611,530; 11,046,305; 11,460,305
2. (a) 4,963,427; 4,724,963; 4,427,963; 4,369,427
 (b) 8,693,306; 8,369,306; 8,306,396; 8,063,963
 (c) 12,994,609; 12,499,906; 12,420,994; 12,042,994
 (d) 6,253,311; 3,625,113; 625,311; 625,113

Answers to application 1.6

- (a) 7,308,172 (b) 4,694,056 (c) 9,731,680 (d) 12,598,799
 (e) 18,088,079 (f) 10,014,864 (g) 16,067,812

Answers to application 1.7

- (1) 9,591,075 litres (2) 4,152,206 text books
 (3) 8,986,230 people (4) 4,893,705 kg

Answers to application 1.8

- (1) 1,001,090 (2) 1,604,306 (3) 1,892,220 (4) 2,669,037
 (5) 2,603,068 kg (6) 2,669,037 trees (7) 1,008,000 FRW
 (8) 1,713,821 books (9) 4,228,508

Answers to application 1.9

- (1) 53,008 pens (2) 1,973,743 (3) 5,600,100 kg
 (4) 803,050 litres (5) 5703285 (6) 8,576,750 kg

Answers to application 1.10

- (a) 74,961,992 (b) 123,434,775 (c) 111,90,432 (d) 108,444,314
 (e) 229,314,690 (f) 169,890,655

Answers to application 1.11

- (1) 12,512,500 FRW (2) 1,200,000 FRW
 (3) 95,581,000 mangoes (4) 96,800,000 litres
 (5) 18,000,000,000 metres (6) 6,170,000 FRW
 (7) 9,000,000 pairs

Answers to application 1.12

- (a) 77,948 (b) 238,927 (c) 35,041 (d) 130,986
(e) 65,846 saplings (f) 23,507 kg

Answers to application 1.13

- (1) 84,450 FRW (2) 11,002 FRW (3) 352,599 crates
(4) 211,555 FRW (5) 1,080,054 kg

Answers to application 1.14

- (1) (a) 4,856,800 (b) 6,789,740 (c) 2,234,590 (d) 3,654,870
 (e) 62,453,790 (f) 5,459,600
(2) 6,753,930 (3) 690,000 (4) 699,000 (5) 540 plates

Answers to application 1.15

1. (a) 3,654,600 (b) 22,987,700 (c) 564,324,000
 (d) 3,890,700 (e) 4,361,400 (f) 12,642,300
2. (a) 6,069,000 (b) 8,523,000 (c) 64,565,000
 (d) 70,310,000 (e) 4,236,000 (f) 17,100,000

Answers to application 1.16

1. (a) 4,550,000 (b) 2,560,000 (c) 1,560,000
2. 4,690,000 FRW
3. (a) 8,600,000 (b) 61,200,000 (c) 7,900,000
4. 1,500,000 FRW
5. (a) 3,000,000 (b) 9,000,000 (c) 7,000,000
6. 10,000,000 FRW

Answers to end of unit 1 assessment

1. (a) Ten thousand (b) ones (c) Tens
 Ten million Thousands Ten thousands
 Hundred thousands Hundred thousands
2. (a) > (b) > (c) >
3. (a) 8,765,420 (b) 6,545,700 (c) 98,776,000 (d) 45,370,000
 (e) 10,000,000 (f) 32,700,000
4. 1,000,000 5. 46,210,495 books 6. 502,920 eggs
7. 5,472,650 FRW 8. 9,796,817 textbooks
9. Five million six hundred seventy eight thousand nine hundred fifty.
10. Eight million four hundred thirty four thousand five hundred seventy nine.
- 11.

Quantity one	Sign	Quantity two	Total
1,456,776 kg	+	2,456,767 kg	3,913,543 kg
2,555,550 FRW	–	1,189,660	1,365,890 FRW
23,752 FRW	×	450	10,688,400 FRW
49,560,000 FRW	÷	7,080 FRW	7,000 FRW

12. (a) 47,350,184 bottles (b) 26,457,584 bottles

Unit 2

Multiplication and Division of Integers

Key unit competence: To be able to multiply and divide integers.

List of lessons

Lessons	Number of lessons	Number of periods
2.1 Multiplying integers using a number line.	1	2
2.2 Multiplying of integers without using a number line.	1	1
2.3 Division of integers using a number line	1	1
2.4 Division of integers using without a number line.	1	1
2.5 Solving problems involving multiplication and division of integers.	1	1
Assessment	1	2
Total	6	8

Guidance on problem statement

The concept of integers mostly appears especially when we are dealing with temperature, height, referring to the sea level e.t.c.

Let learner think of implication how it is applied in our daily life like multiplication and division. Give them time to go through the introductory activity in learner's book page 33. Let them know that activity should be their orientation of what they are going to study within the unit. Help learners have open mind about the general idea of this unit through the following questions.

- What do you think may be your challenge to answer the questions?
- As P6 learners, give the advice on how you may overcome it.

Cross-cutting issues addressed

Throughout the teaching process of this unit, it will be crucial to help learners to master the content and it is better to address cross-cutting issues where possible. In this unit, we will address the following cross-cutting issues as non-stand alone cross-cutting issues within classroom activities and through the development of the content.

- **Peace and value education:** First of all as a teacher you have to be a peace maker in your class and role model so that learners will imitate how you behave. When there is any conflict do not leave without helping to solve it within the lesson. Encourage learners to behave well, being humble, honest, etc.
- **Gender Education:** This cross-cutting issues will be addressed through giving equal opportunities to both boys and girls during the lesson.

Learning Objectives

Knowledge and understanding

- Describe the steps taken when multiplying and dividing integers.
- Show and explain the concept of integers to solve problems.

Skills

- Apply the concepts of multiplication and division to solve problems involving integers.
- Carry out multiplication and division of integers.
- Explain how integers change in multiplication and division.

Attitudes and values

- Appreciate the importance of accuracy in multiplication and division of integers.
- Respect each other's contribution when working in groups.
- Acknowledge the importance of co-operation.

Number of lessons: 8

Guidance for classroom organisation

Before you start the lesson, first use warm-ups or energizers in order to engage learners into the lesson. Do not focus on this only, try to be creative.

The essence is to motivate learners and make them active throughout the teaching- learning process.

Help learners to form groups before you assign them an activity. While they are doing the activity, walk around while monitoring their work and helping where they have difficulties.

Learning and teaching materials for the Unit

Manila paper or charts where integers are written, flash cards, pencils, pens, chalk and other materials that the teacher may see as important to achieve his/her objective.

Lesson 2.1**Multiplying integers using a number line (80 minutes)****Learner's Book page 33****Introduction**



- Ask learners to recite multiplication tables of 7, 8, 11.
- Ask learners to form groups and provide each group with the necessary materials.
- Guide learners as they carry out the activity in the Learner's Book page 33.
- Help learners to realise as they present their reports; that 5×7 means 5 intervals of 7 gaps each or 5 groups of 7 steps.

Development

- Write an example on the chalkboard and guide learners through it.

Examples; **(1)** 2×3 **(2)** 2×-3 .

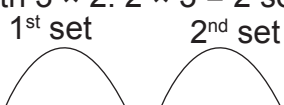
- Explain what 2×3 means so that learners do not confuse it with 3×2 . $2 \times 3 = 2$ sets of 3 gaps.

2 sets =  3 gaps = 

- Draw the number line and through question and answer, guide learners as they label.

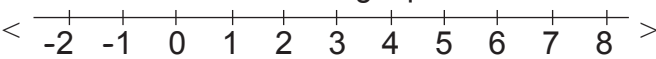

left are negatives | right are positives

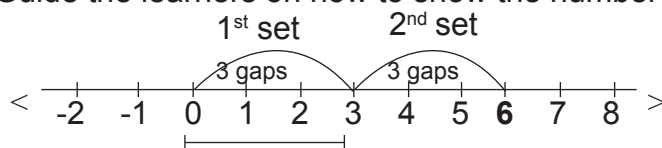
- Guide the learners on how to show the number $2 \times +3$ on a number line.

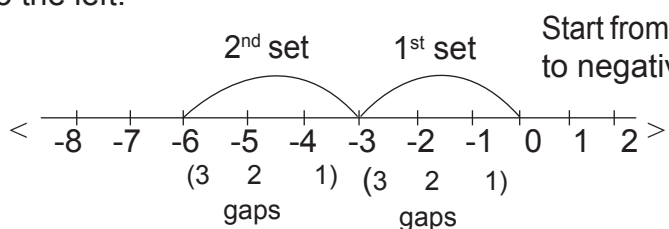

Write the final statement as: $2 \times +3 = +6$

- Guide learners on example 2, that is, 2×-3 . Since the example bears -3 , we move to the left.

Start from zero. Move to negative.

Write the final statement as $2 \times -3 = -6$

- Give some group work for the learners to discuss.
- Emphasise the meaning of multiplication statements by giving examples.
- For example, $5 \times -5 = 5$ sets of 5 steps each to the left.
- $5 \times +4 = 5$ sets of 4 steps each, to the right.

- Take more time to explain the statements. If learners understand the statements, they easily represent them on number lines.
- Guide learners as they study the examples in the Learner's Book page 33 and 34.

Conclusion

- Lead learners as they discuss the contents of the Studytip before attempting the Application 2.1 in the Learner's Book, page 35.
- Explain to the learners the meaning of brackets in multiplication with examples.
- Give more statements involving multiplication of integers.
- Use them to explain and emphasise their meanings since this makes it easy for learners to use number lines when multiplying integers.

Remedial Exercises

Help slow learners to master the concept by using number lines to multiply more integers.

(a) $4 \times +6$

(b) 3×-3

(c) $8 \times +2$

(d) 5×-6

(e) $2 \times +5$

(f) 7×-4

Additional Exercise

Prepare more work for the fast learners. Tell them to draw their own number lines as this helps them to perfect the skill.

(1) 8×-3

(2) 6×-7

(3) 4×-9

(4) $9 \times +6$

(5) $10 \times +4$

(6) -8×-8

Lesson 2.2

Multiplying of integers without using a number line

(40 minutes)

Learner's Book page 35

Introduction

- Organise learners into manageable groups and provide each group with the necessary materials.
- Use the flash cards to help learners understand that a positive times a positive gives a positive, a negative times a negative gives a positive, positive \times negative gives negative and negative \times positive gives a negative.
- Guide the learners as they carry out the activity in the Learner's Book, page 35.

Development

- Let the learners carry out the group presentation and finally come up with a general report.

- Help learners to harmonise their work.
- Guide learners through the examples on a displayed chart.

Example 1

$$6 \times + 3$$

$$\text{number: } 6 \times 3 = 18$$

$$\text{signs: } + \times + = +$$

$$\text{Therefore, } +6 \times + 3 \\ = +18$$

Example 2

$$-5 \times - 2$$

$$\text{number: } 5 \times 2 = 10$$

$$\text{signs: } - \times - = +$$

$$\text{Therefore } -5 \times - 2 \\ = + 10.$$

Example 3

$$+6 \times -8$$

$$\text{number: } 6 \times 8 = 48$$

$$\text{signs: } + \times - = -$$

$$\text{Therefore } +6 \times -8 \\ = -48.$$

- Give learners numbers to try out. They may answer many of them orally. e.g $+2 \times +4$, $-2 \times +9$, $-9 \times +8$, -8×-12 etc.
- Encourage them to ask questions where they get challenges.
- Refer to the Learner's Book page 35 and guide them through the examples.
- Discuss the Study tip. Later, tell them to attempt Application 2.2 in the Learner's Book, page 36.

Conclusion

- Mark their work and give them feed back
- The concept: negative \times negative = positive confuses most learners. Ensure learners get the concept very well.

Remedial Exercises

Prepare some simple numbers for slow learners;

$$(a) +5 \times +3, (b) +4 \times -2, (c) -7 \times +2 \quad (d) -5 \times -2$$

$$(e) +8 \times -9 \quad (f) -7 \times -9 \quad (g) +6 \times +7$$

Additional Exercise

You may have larger figures for fast learners to practise, for example;

$$(1) +23 \times +6 \quad (2) -25 \times -8 \quad (3) +55 \times +5$$

$$(4) -130 \times -7 \quad (5) +15 \times 234$$

Lesson 2.3**Division of integers using a number line (40 minutes)****Learner's Book page 36****Introduction**

- Review multiplying integers using a number line.
- Ask learners to form groups.
- Check if each group is made up of learners of both gender.
- Provide each group with materials to use.

Development.

- Guide learners as they discuss while carrying out the activity in the Learner's Book, page 36.
- Instruct them through the activity
- Give them time for group presentation and later come up with a general report. That is; there are 4 intervals. The division statement is $28 \div 7 = 4$.
- Share the main concept of the sub-unit.
- Remind them that division is the opposite of multiplication.
- Write an example on the chalkboard for class discussion. Example; $14 \div 2$
- Explain that this means subtracting 2 repeatedly from 14.
- Count the number of times you subtract 2 from 14 to get zero.

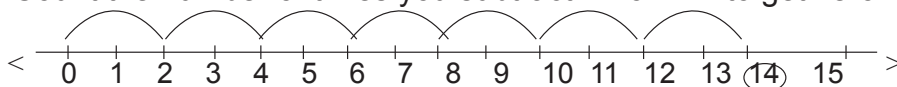

- Allow them to count the number of times subtracted.
- Explain to the learners that the number of times becomes the answer.
- Give more examples and each time guide the learners as they work out the answer.
- Give out some numbers for learners to share ideas in groups. For example; $+18 \div 3$, $-18 \div 3$, $+24 \div 6$, $-24 \div 6$.
- Ensure that you have number lines drawn and labeled already on sheets of paper.
- Guide learners as they read through and study the examples in Learner's Book page 36 and 37.

Conclusion

- Guide them through the Study tip.
- Dividing integers on number line may sometimes be confusing.
- Ensure that you give numerous examples.
- You may have practical lessons on the ground.
- Let them share their ideas about it.

- Give them time to attempt application 2.3.
- Mark their work accordingly and give feedback.
- Let them take the notes.

Remedial Exercises

Prepare simple numbers for slow learners to practise.

(a) $+8 \div 2$, (b) $-8 \div 2$, (c) $+12 \div 3$

(d) $-12 \div 3$ (e) $+24 \div 6$ (f) $-30 \div 3$

Additional Exercise

Prepare more work for fast learners.

Let the learners draw number lines by themselves.

(a) $+28 \div 7$ (b) $-32 \div 8$ (c) $+45 \div 9$

(d) $-60 \div 15$ (e) $+45 \div 5$ (f) $48 \div 4$

Lesson 2.4

Dividing integers without using a number line (40 minutes)

Learner's Book page 37

Introduction

- Review how to multiply numbers without using a number line.
- Provide each group with flash cards having the activity in the Learner's book page 37.
- Let them carry out the activity and later do the presentation.
- Harmonise their work.

Development

- Conclude that dividing integers of the same signs gives a positive integer and dividing integers with different signs gives a negative integer.
- Share the main competence, that is dividing integers.
- Guide learners on how to divide signs.
- Inform them that dividing integer signs is similar to multiplication. That is: positive \div positive = positive, negative \div negative = positive, positive \div negative = negative, negative \div positive = negative
- Guide learners through some examples on a displayed chart.

Example 1

$$+20 \div +5$$

$$\text{number: } 20 \div 5 = 4$$

$$\text{signs: } + \div + = +$$

$$\text{Therefore, } +20 \div +5$$

$$= +4$$

Example 2

$$-36 \div -9$$

$$\text{number: } (36 \div 9 = 4)$$

$$\text{signs: } - \div - = +$$

$$\text{Therefore } -36 \div -9$$

$$= +4.$$

- Assign some numbers for learners to discuss in groups.
(1) $+12 \div +4$ (2) $-12 \div -4$ (3) $-48 \div +6$ $-96 \div +12$
- Let them share the experience.
- Help them to internalise the concept.
- You may also give lots of oral work.
- $+9 \div -3$ $-14 \div +2$ $+18 \div +6$ $-120 \div -20$
- Guide learners through the examples in Learner's Book page 38.
- Guide learners through the Study tip.

Conclusion

- Take time to help learners to understand division of signs.
- Relate multiplication to division of integer signs.
- You may use the method of repeated subtraction to bring out the idea of division of integers.
- Give lots of practice especially through mental work.
- Let learners attempt Application 2.4
- Give them time to work out the questions of the application
- Mark their work and help in correction.
- Let learners take notes in their notebooks.

Remedial Exercises

Guide slow learners again using picture cards.

Allow them do work at their pace.

Prepare some simple numbers for them for further practice.

(a) $-8 \div -2$, (b) $+10 \div -5$ (c) $-12 \div -2$ (d) $+15 \div 5$ (e) $+24 \div -3$

Additional Exercise

Prepare more challenging work for fast learners by applying larger numbers.

Lesson 2.5**Solving problem involving multiplication and division of integers (40 minutes)****Learner's Book page 38****Introduction**

- Review multiplying and dividing integers with same and different signs.
- Ask learners to get into their groups.
- Provide each group with cards and markers.
- Guide them as they carry out the activity in the Learner's Book page 38.
- Let each group present its report.

Development

- Guide learners through some examples which require reading and working out.
- Give some numbers for group discussion.
- Ask learners to present their work.
- Guide learners as they discuss the examples in Learner's Book, pages 38 and 39.
- Let them work it out and compare their answers.
- Let learners share with whole class.

Conclusion

- Guide learners through the Study tip.
- Let them discuss and share what may be added to the Study tip given.
- Ask them to attempt Application 2.5 in the Learner's Book, page 39.
- Mark their work and give them feedback.
- Ensure that learners master how to multiply and divide the signs.
- Discuss and guide learners through situations which are positive or negative.
- Positive situations include; profits, goal scores, raise in temperatures and so on.
- Negative situations include; debts, fall in temperatures, loss, buying on credit and so on.
- Encourage learners to read, comprehend and interpret information correctly.

Remedial Exercises

Set simple questions for the slow learners to practise. Encourage and guide them to understand words like quotient, share, distribute.

- (1) Multiply: -4 by +3.
- (2) What is the product of +2 and -5?
- (3) What is the quotient of -9 and 3?
- (4) Find the product of +3, -6 and +5

Give slow learners time for redoing worked examples and some other exercises.

Work out:

- | | | |
|-------------------------|-------------------------|-----------------------|
| (a) $(+131) \times -78$ | (b) $(+200) \div (-25)$ | (c) $(+27) \div (+9)$ |
| (d) -42×-12 | (e) $7800 \div (-100)$ | |

Extension Activity

- (1) $(-123) + (+23) \times ((+100) + (-75))$
- (3) $(-807 \times 100) \div 20$
- (4) Kantengwa stands on -12, she moves 5 steps forward positive integer and one step backward. At which integer is she standing on now?

Answers to application 2.1

1 (a)

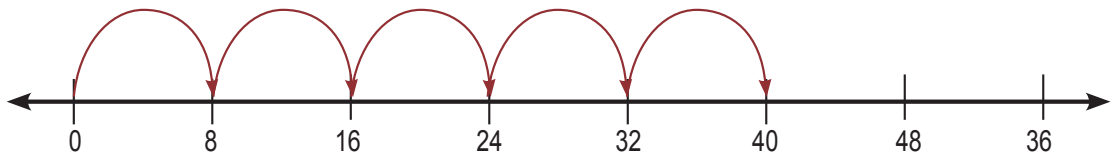

(b)

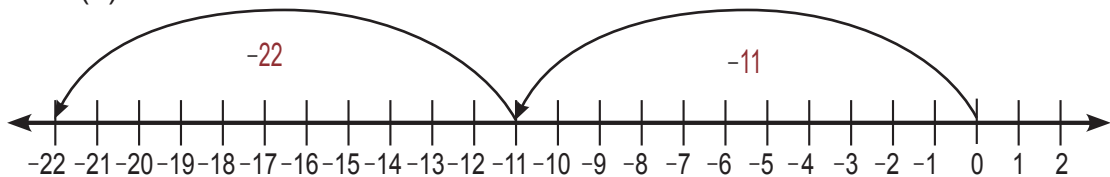

(c)

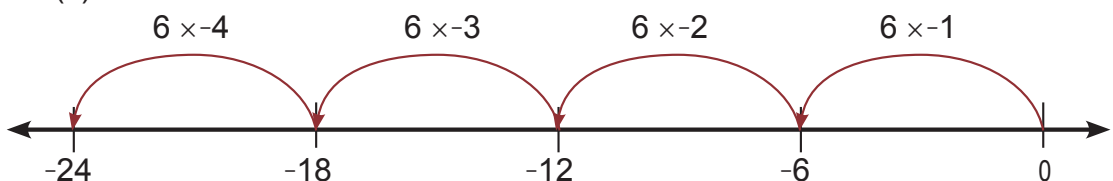

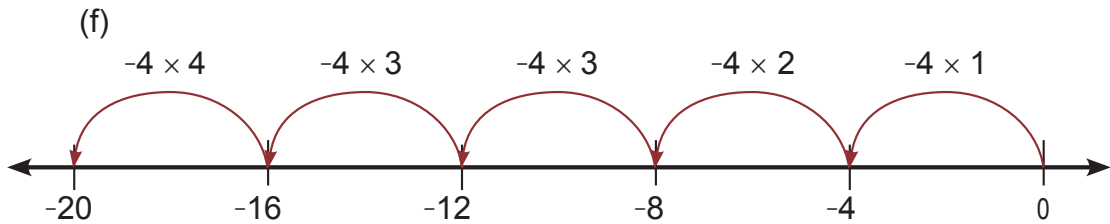
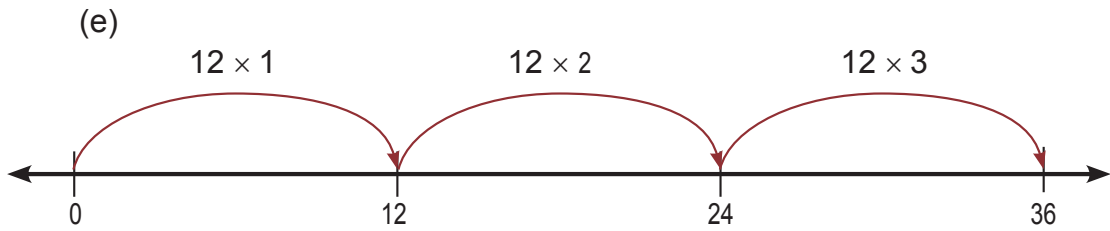
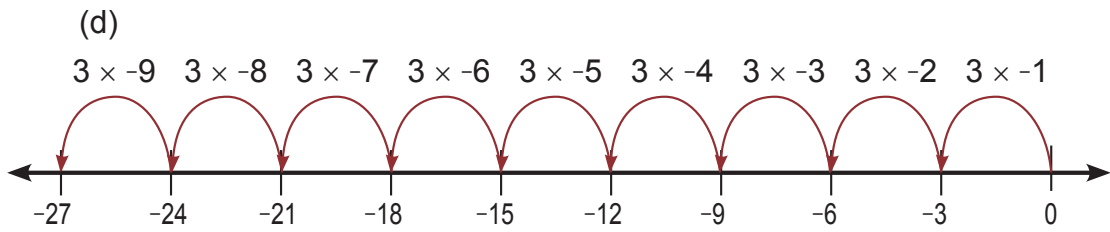

2.

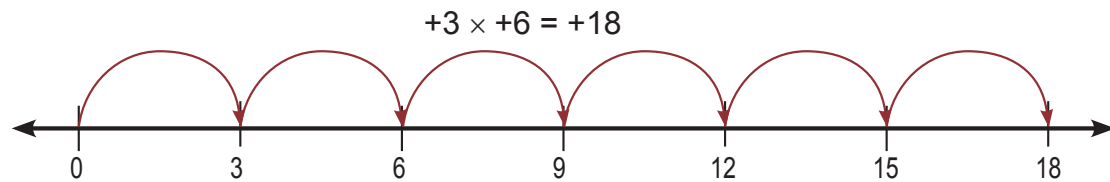

3.

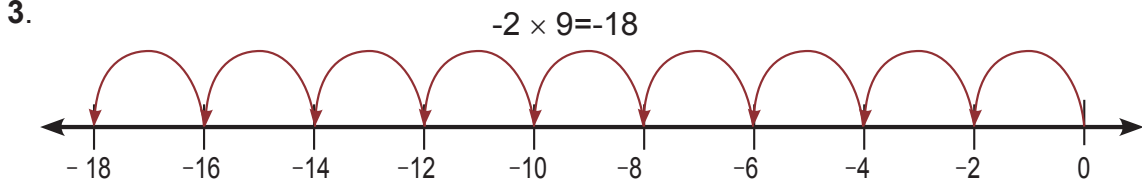

Answers to application 2.2

- | | | | |
|----------|----------|-----------|-------------|
| (a) +16 | (b) +40 | (c) -70 | (d) -54 |
| (e) -96 | (f) -12 | (g) +99 | (h) +42 |
| (i) +600 | (j) -600 | (k) -1500 | (l) +12,423 |

Answers to application 2.3

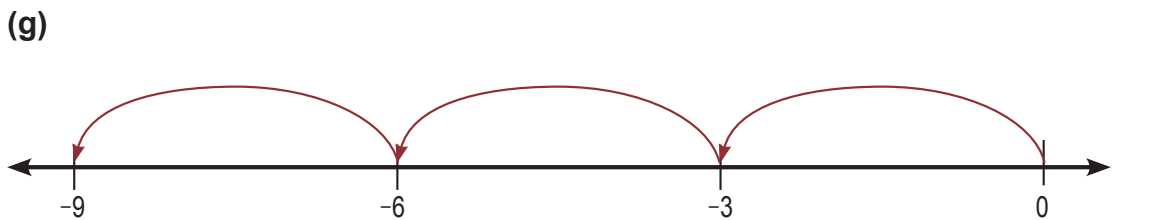
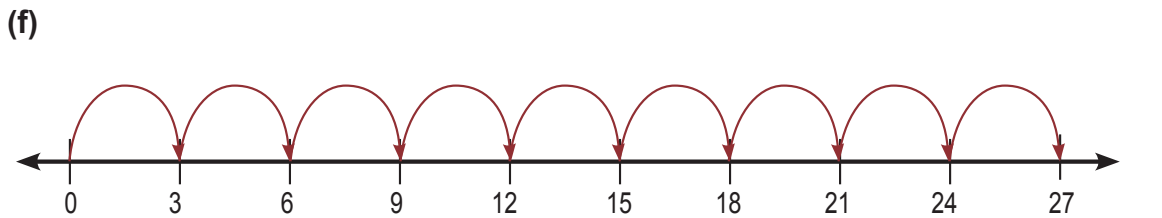
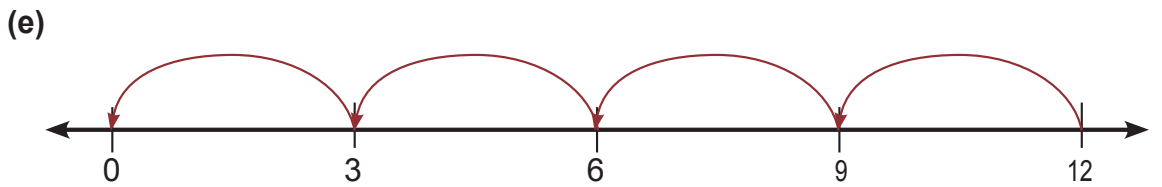
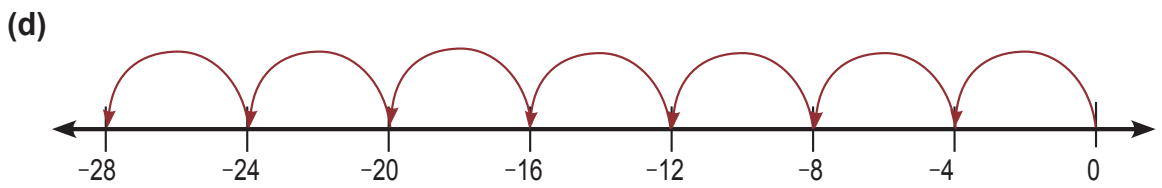
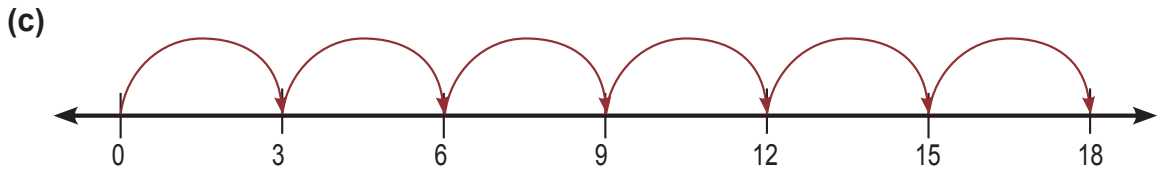
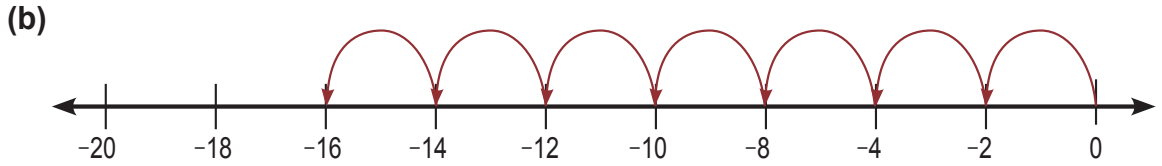
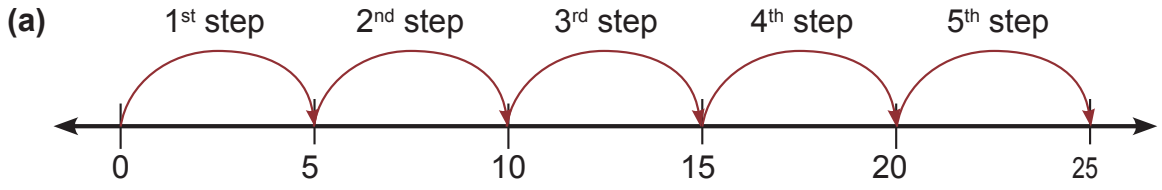

(h)

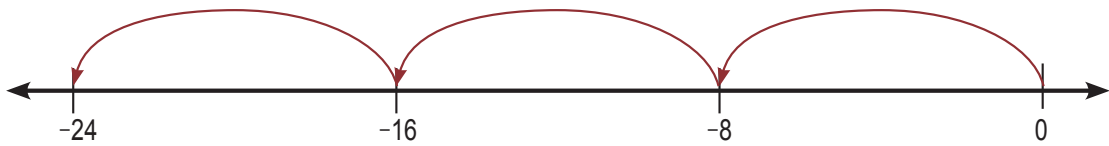

Answers to application 2.4

- | | | | |
|--------|--------|--------|---------|
| (a) -3 | (b) +3 | (c) -5 | (d) +4 |
| (e) +3 | (f) +3 | (g) +8 | (h) +12 |
| (i) +5 | (j) +5 | (k) -5 | (l) +24 |

Answers to application 2.5

- | | | | |
|---------------|-------------------|-------------|----------------|
| (1) 2,300 FRW | (2) 6 mangoes | (3) 500 FRW | (4) 500 FRW |
| (5) 27°C | (6) 1,440,000 FRW | (7) -15°C | (8) -15 points |

End of unit 2 Assessment

1. (a) +3 (b) -30 (c) +6 (d) 144
 (e) -27 (f) -5

2. (a)

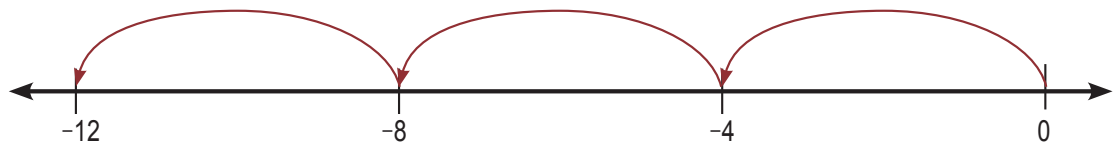

(b)

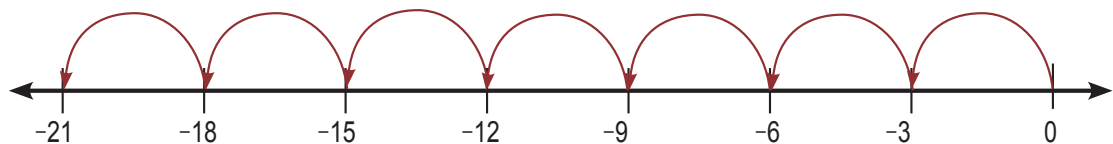

(c)

1 2 3 4 5

0 6 12 18 24 30 36

(d)

4×-12 4×-11 4×-10 4×-9 4×-8 4×-7 4×-6 4×-5 4×-4 4×-3 4×-2 4×-1

-48 -44 -40 -36 -32 -28 -24 -20 -16 -12 -8 -4 0

(e)

6×1 6×2 6×3 6×4 6×5 6×6 6×7 6×8 6×9

0 6 12 18 24 30 36 42 48 56

(f)

-12 -8 -4 0 4 8 12 16 20 24 28 32 36 40

3. 4,800 FRW

4. debt of 2,000 FRW

5. 600 books

6. the two integers are +30 and -10

7. 400 FRW

8. 1,500 FRW

9. 200 FRW

10. $20 \div -4$

Unit 3 Powers and Indices, LCM and GCF

Key unit competence: To be able to use powers and indices, and apply the Lowest Common Multiple (LCM) and the Greatest Common Factor (GCF) when solving problems.

List of lessons

Lessons	Number of lessons	Number of periods
3.1 Indices	1	1
3.2 Defining base and exponent.	1	1
3.3 Multiplying and the law of multiplying indices.	1	1
3.4 Dividing and the law of dividing indices.	1	1
3.5 Multiplying and dividing indices.	1	2
3.6 Finding unknown and the law of multiplication of indices.	1	1
3.7 Finding unknown and the law of division of indices.	1	1
3.8 Finding Lowest Common Multiple of numbers.	1	1
3.9 Solving problems involving LCM.	1	1
3.10 Finding Greatest Common Factor of numbers.	1	1
3.11 Solving problems involving GCF.	1	1
3.12 Finding unknown number using LCM and GCF.	1	2
Assessment	1	2
Total	13	16

Guidance on problem statement

Within unit, the idea of LCM and GCF as well as powers and indices will be taught. We mainly know that powers and indices refers to writing numbers in their short form and LCM and GCF help in mathematical calculations.

Let learners think that it is necessary and essential to know these through introduction in the Learner's Book, page 41.

Cross-cutting issues

Throughout the teaching process of this unit, it will be crucial to help learners to master the content and it is better to address cross-cutting issues where possible.

So, in this unit, we will address the following cross-cutting issues as non-stand alone within classroom activities and through the development of the content.

- **Peace and value education:** First of all as a teacher you have to be a peace maker in your class and role model so that learners will imitate how you behave. When there is any conflict do not leave without helping to solve it within the lesson. Encourage learners to behave well, being humble, honest, etc.
- **Gender Education:** This cross-cutting issue will be addressed through giving equal opportunities to both boys and girls during the lesson.

Learning Objectives

Knowledge and understanding

- State and explain the law of indices involving multiplication and division.
- Identify the ways of working out problems involving the LCM in a practical context.
- Explain the terms “base” and “exponent”.

Skills

- Apply the law of indices in multiplication and division.
- Apply LCM and GCF in solving problems.
- Calculate the LCM and the GCF of numbers.

Attitudes and values

- Learners should respect each other when they are working in groups.
- Acknowledge the importance of working together.
- Confidence and accuracy should be reflected among the learners.

Number of lessons: 16

Guidance for classroom organisation

Before you start the lesson, first use warm-ups or energizers in order to engage learners into the lesson. Do not focus on this only, try to be creative. The essence is to motivate the learners and make them active throughout the teaching-learning process.

Help learners to form group before you assign them an activity.

While they are doing the activity, walk around while monitoring their work and helping where they have difficulties.

Learning and teaching materials for the unit

Manila cards, scissors and masking tape and other materials that the teacher may see as important to achieve his/her objective.

Lesson 3.1 Indices (40 minutes)

Learner's Book, page 41

Introduction

- Start with mental work on squaring numbers for example, 2×2 , 4×4 , 5×5 and so on.
- Ask learners to form groups.
- Let them study the multiplications in the activity in the Learner's Book, page 41.
- Help them to go through the activity.
- Let them find out and record the number of times 2 has been multiplied and suggest another way such a sentence can be presented.

Development

- Through a discussion, help learners to realise that the sentence can be written in short by writing 2 once, then counting the number of times it has been multiplied to write above 2. Therefore, $2 \times 2 \times 2 \times 2 \times 2 \times 2 = 2^6$.
- Write a similar example on the chalkboard and guide learners through it.
Example: Write $8 \times 8 \times 8 \times 8 \times 8 \times 8$ in short.
- Explain to the learners that 8 has been multiplied by itself 6 times, so 8 must be written once and the number of times it has been multiplied written to the right above it; that is $8 \times 8 \times 8 \times 8 \times 8 \times 8 = 8^6$.
- Take the learners through the examples in the Learner's Book, page 41 as you emphasise the figure that must be written once and the one that should be written above it.
- Give them some examples involving finding the numbers that are missing to test whether they have understood.

For example: (a) $9 \times 9 \times 9 = \square^3$ (b) $11 \times 11 \times 11 \times 11 = 11\square$.

Conclusion

To ensure that learners have understood, they will quickly give the answers with reasons. That is, 9 has been multiplied 3 times, so we write 9 in the first box. Then 11 has been multiplied by itself 4 times, so we write 4 in the second box.

- Guide learners through the Study tip and tell them to attempt Application 3.1 in the Learner's Book, page 42.
- Mark their work and give them feedback.
- Help them with the corrections.
- Let them take notes.
- Emphasise to the learners that the number that has been multiplied several times by itself is the number that must be written once and the number of times it has been multiplied should be written to the right above it.

Remedial Exercise

Let slow learners try out the exercise below for more practice.

Fill in the missing numbers.

(a) $3 \times 3 \times 3 \times 3 = \square^4$

(b) $5 \times 5 \times 5 = \square^3$

(c) $21 \times 21 \times 21 \times 21 = \square^4$

(d) Which is right? Is $4 \times 4 \times 4 = 4^3$ or 3^4

(e) Given $16 \times 16 \times 16 \times 16$, what is it equal to in short?

Additional Exercise

Let fast learners try out the exercise below.

(1) Given; $24 \times 24 \times 24 \times 24 \times 24 \times 24$.

(a) Write it in short.

(b) Give a reason as to why you have written it that way.

(2) Given that; $100 \times 100 \times 100 \times 100 = \square^4$

(a) What number is missing?

(b) Give a reason why you think its the one that is missing.

Lesson 3.2**Defining bases and exponent (40 minutes)**

Learner's Book, page 42

Introduction

- Review the work taught in the previous lesson.
- Ask learners to form groups and guide them through the activity
- Help them to come up with the correct answers, i.e, 7 is supposed to be multiplied.
- 4 is the number that shows the number of times 7 has been multiplied.

Development

- Write an example on the chalkboard.
- Example: Given the notation 4^3 , which digit shows the; (a) exponent? (b) base?
- Explain to the learners that the number that represents the number of times a factor has been multiplied is the exponent or index. The number that should be multiplied by itself is the base.
- Guide learners as they study the examples.
- Let them do it again.
- Display a chart with different power notations and each time ask learners to pick a number card to show what represents the base and the index/exponent.

Conclusion

- Guide learners through the Study tip and tell them to attempt Application 3.2 in the Learner's Book, page 43.

- Ensure that learners learn how to read different notations/(powers). For example (3^7) is read as (three to the power of 7) or (three raised to the seventh power).
- Explain that the plural for index is indices, such that learners do not get confused.

Remedial Exercise

Ask slow learners to read and then write the following notations in figures.

- (1) six to the power of four. (2) four to the power of three.
 (3) eight to the power of six. (4) two raised to the seventh power.
 (5) nine raised to the second power.
 (6) (a) 4,856,800 (b) 6,789,740 (c) 2,234,590 (d) 3,654,870
 (e) 62,453,790 (f) 5,459,600

Fast learners can write the following notations in words:

- (1) 5^3 (2) 4^6 (3) 2^{12} (4) 12^3
 (5) 7^2 (6) 11^3 (7) 8^7 (8) 8^4
 (9) 10^4 (10) 15^{10}

Lesson 3.3

Multiplying and the law of multiplication of indices

(40 minutes)

Learner's Book, page 43

Introduction

- Begin the lesson with a review of the previous sub-unit. That is, display a card with a notation and ask learners to expand. For example 4^5 , let the learners tell that $4^6 = 4 \times 4 \times 4 \times 4 \times 4 \times 4$.
- Ask learners to form groups.
- Let them carry out the activity in their groups as you supervise them.
- Give them time to report what they have agreed upon.

Development

- Later make a general report, that is;
- To expand and work out $6^2 \times 6^5$ gives $(6 \times 6) \times (6 \times 6 \times 6 \times 6 \times 6) = 6^7$.
- Six has been multiplied seven times.
- To add indices in the notations gives $6^2 \times 6^5 = 6^{2+5} = 6^7$.
- When compared, the results are the same.
- Conclude that when multiplying powers of the same base, we simply add the indices and maintain the base.
- Write an example which requires simplifying multiplication problems involving indices.
- Example: work out: $8^3 \times 8^4$. Allow learners to expand, i.e $(8 \times 8 \times 8) \times (8 \times 8 \times 8 \times 8) = 8^7$
- Take learners through method 2 where they do not need to expand but to add the indices. For example, $7^2 \times 7^5 = 7^{(2+5)} = 7^7$
- Guide learners as they study the examples in the Learner's Book, page 43.

Conclusion

- Use the “Study tip” to emphasise that to multiply powers of the same base, add the indices or exponents.
- Let learners deal with it and come up with their own idea.
- Tell them to attempt Application 3.3 in the Learner’s Book, page 44.
- Mark the work and give feed back.
- Help them with the corrections.
- Let them take notes in their notebooks.
- Emphasise the law of indices in multiplication and explain to the learners its suitability. Tell them that even if the exponents may be big it saves us from expanding when working out and from making mistakes in the long run as one may leave out a digit.

Remedial Exercise

Let slow learners try out the exercise below. Fill in the missing numbers:

(1) $3^4 \times 3^6 = 3^{(\text{---} + \text{---})}$

(2) $3^5 \times 3^3 = 3^{(\text{---} + \text{---})}$

(3) $2^3 \times 2^4 = 2^{(\text{---} + \text{---})}$

(4) $6^2 \times 6^4 = \square^{(2 + 4)}$

Additional Exercise

Let fast learners try out the exercise below.

Use the law of indices in multiplication to work out.

(1) $a^8 \times a^2$

(2) $b^9 \times b^2$

(3) $c^7 \times c^5$

(4) $d^{10} \times d^6$

(5) $f^{12} \times f^4$

(6) $h^{15} \times h^5$

(7) $k^{18} \times k^{12}$

(8) $m^{20} \times m^{16}$

Lesson 3.4

Dividing and the law of division of indices (40 minutes)

Learner’s Book, page 44

Introduction

- Review the previous lesson.
- Organise learners in groups and ask them to discuss the contents in the activity.
- Discuss the results each group has got and later come up with one general result.

$$\text{That is } 6^5 \div 6^3 = \frac{\cancel{6} \times \cancel{6} \times \cancel{6} \times 6 \times 6}{\cancel{6} \times \cancel{6} \times \cancel{6}} = 6^2, \text{ then } 6^{5-3} = 6^2$$

When you compare, the results are the same.

Development

- Conclude that when you expand and divide numbers involving indices, you get the same result as when you subtract the index of the divisor from that of the dividend.
- Display a chart with worked out examples and guide learners as they study them.
- Take them through the examples in the Learner’s Book, page 44 . Ensure that both methods are practised.

Conclusion

- Ask them to read the Study tip aloud to every one's satisfaction.
- Then tell them to attempt Application 3.4, page 45.
- Remind learners about the vocabulary related to division such that they may understand the law of indices in division. "The number that is to be divided by another number is the dividend. The number by which another is divided is the divisor. The result is the quotient."

For example; $24 \div 8 = 3$

Remedial Exercise

Let slow learners try out the exercise below.

Copy and complete the following:

- (1) $3^6 \div 3^3 = 3(\square - \square)$ (2) $6^5 \div 6^2 = 6(\square - \square)$
 (3) $11^6 \div 11^4 = 11(\square - \square)$ (4) $7^4 \div 7^2 = 7(\square - \square)$
 (5) $13^6 \div 13^2 = 13(\square - \square)$

Additional Exercise

Let fast learners try out the exercise below.

Use the law of indices in division to work out.

- (1) $a^8 \div a^2$ (2) $b^9 \div b^2$ (3) $c^7 \div c^5$ (4) $d^{10} \div d^6$
 (5) $f^{12} \div f^4$ (6) $h^{15} \div h^5$ (7) $k^{18} \div k^{12}$ (8) $m^{20} \div m^{16}$

Lesson 3.5**Multiplying and Dividing Indices (80 minutes)**

Learner's Book, page 45

Introduction

- Review multiplying indices with and without the law of multiplying indices. Then review dividing indices with and without the law of dividing indices.
- Ask learners to form groups.
- Guide the learners through the activity in the Learner's Book, Page 45.
- Harmonise the activity by leading them to come up with a general report.

Development

- $32 = 2 \times 2 \times 2 \times 2 \times 2 = 2^5$, $8 = 2 \times 2 \times 2 = 2^3$, $16 = 2 \times 2 \times 2 \times 2 = 2^4$.
- Explain that they can work out with or without the laws of multiplying and dividing indices.

That is: $\frac{(\cancel{2} \times \cancel{2} \times \cancel{2} \times \cancel{2} \times 2) \times (2 \times 2 \times 2)}{\cancel{2} \times \cancel{2} \times \cancel{2} \times \cancel{2}} = 2 \times 2 \times 2 \times 2 = 2^4$.

$$\text{OR } \frac{(2 \times 2 \times 2 \times 2 \times 2) \times (2 \times 2 \times 2)}{2 \times 2 \times 2 \times 2} = 2^{(5+3)-4} = 2^{(8-4)} = 2^4.$$

- Let the learners realise that both laws of multiplying and dividing indices have been combined in the working.
- Write an example on the chalkboard which requires both multiplying and dividing indices.
- Learners should give their views about how it should be worked out.
- Ask them to attempt it on slips of paper, then present their findings. Guide them where they get challenges.
- Then let them study the example in the Learner's Book and follow through. Guide them by elaborating the steps carried out.

Conclusion

- Satisfied that the learners have completely understood the concept, ask them to read the study tip.
- Tell them to attempt Application 3.5 in the Learner's Book, page 46.
- Mark their work and give feedback.
- Help them with the corrections.
- Ask them to write the notes.

Remedial Exercise

Let slow learners try out the exercise below.

(a) $\frac{(2 \times 2 \times 2) \times (2 \times 2)}{(2 \times 2)}$

(b) $\frac{(3 \times 3 \times 3) \times (3 \times 3)}{(3 \times 3 \times 3)}$

(c) $\frac{(4 \times 4) \times (4 \times 4)}{(4 \times 4)}$

(d) $\frac{(5 \times 5 \times 5) \times (5 \times 5)}{(5 \times 5 \times 5 \times 5)} = 5^{-+----}$

(e) $\frac{(10 \times 10 \times 10 \times 10) \times 10}{(10 \times 10)} = 10^{-+----}$

Additional Exercise

Let fast learners try out the exercise below.

1 (a) $(27 \times 81) \div 9$

(b) $(125 \times 25) \div 25$

(c) $(1296 \times 36) \div 216$

(d) $(42 \times 7) \div 7$

2 (a) $\frac{(9 \times 9 \times 9 \times 9) \times 9}{(9 \times 9 \times 9)}$

(b) $\frac{(12 \times 12 \times 12) \times 12}{(12 \times 12)}$

(c) $\frac{(20 \times 20 \times 20) \times 20}{(20 \times 20)}$

(d) $\frac{(22 \times 22 \times 22) \times 22}{(22 \times 22)}$

Lesson 3.6**Finding the Unknown and the Law of Multiplying Indices
(40 minutes)****Learner's Book, page 46****Introduction**

- Give mental work about multiplying indices.
For example, $2^3 \times 2^4 = ?$; $3^3 \times 3 = ?$; $4^5 \times 4^2 = ?$
- Review the previous lesson.
- Make a guided discussion as learners carry out the activity in the Learner's Book, page 46 in groups.

Development

- Guide learners to realise that, the missing or unknown index is worked out using a simple equation of addition.
- Likely, working out in the activity would be, for example, $125 \times 25 = 3,125$. Expressed in power form, it should be:

$$5^3 \times 5^2 = 5^{3+2} = 5^5.$$

$$5^3 \times 5^? = 5^5, \text{ finding the missing index, we state the indices as an equation.}$$

$$3 + ? = 5 \text{ (solve for the missing by subtracting 3 from both sides)}$$

$$3 - 3 + ? = 5 - 3$$

$$? = 2$$

So the missing or unknown index is 2.

- Write or dictate an example as learners write it down on slips of paper.
Example" $x^7 \times x^y = x^{10}$.

Working

- Let learners initiate writing an equation of the indices.
- Move around seeking the correct one.
- Write it on the chalkboard; $7 + y = 10$.
- Ask learners to solve it. Check for their working out as: $7 - 7 = 10 - 7$.
Therefore, $y = 3$.
- Therefore, the unknown index is 3.
- Give more examples for the learners to practise.
- Refer them to the examples in the Learner's Book, page 46.
- Guide them through the procedure, then they redo them again.
- Emphasize that, in order to find the unknown index, apply the law of multiplying indices. Then solve the equation formed.

Conclusion

- Ask learners to read the study tip in order to internalise the concept.
- Let them attempt Application 3.6 in the Learner's Book, page 47.
- Mark their work, then give feedback.
- Help with the corrections, then they take notes.

Remedial Exercise

Slow learners should re-do Application 3.6 then try this work.

Find the missing exponent.

(a) $2^2 \times 2^{\square} = 2^3$

(b) $3^{\square} \times 3^3 = 3^5$

(c) $4^4 \times 4^{\square} = 4^6$

(d) $5^1 \times 5^{\square} = 5^2$

(e) $6^2 \times 6^{\square} = 6^3$

(f) $7^2 \times 7^{\square} = 7^4$

Additional Exercise

Fast learners should attempt this exercise.

(a) $6^m \times 6^{2m} = 6^6$

(b) $7^y \times 7^{(y-1)} = 7^7$

(c) $3^3 \times 3^1 = 3^x$

(d) $10^8 \times 10^{y-2} = 10^{10}$

(e) $12^{(x+2)} \times 12^3 = 12^8$

(f) $n^{(y-4)} \times n^2 = n^6$

Lesson 3.7**Finding the Unknown and the Law of Dividing Indices
(40 minutes)**

Learner's Book, page 47

Introduction

- Start with mental work on division of indices.
For example: $2^3 \div 2^1 = 2^2$; $4^5 \div 4^4 = 4^2$; $6^{10} \div 6^5 = 6^5$ and so on.
- Distribute learners in groups.
- Provide each group with the suggested learning materials.
- Guide the learners through the activity in the Learner's Book, page 47.

Development

- Give them time to report their findings, then come up with a general report.
For example: $7^6 \div 7^2 = 7^4$.
- Learners should realise that an equation for finding the unknown is formed.
So in this case it should be: $6 - ? = 2$.
- Learners found missing numbers in Primary 4. They are expected to find it with ease.
 $? = 6 - 2$
 $? = 4$
- Now write a power notation with an unknown exponent.
For example, $5^x \div 5^7 = 5^4$.
- Let learners form an equation using exponents.
- Check that they correctly write $x - 7 = 4$.
- Follow their working out as follows:
 $x - 7 = 4$
 $x - 7 + 7 = 4 + 7$
 $x = 11$
Therefore, the unknown index is 11.
- Refer the learners to the examples in the Learner's Book, page 47.
- Ask them to study and follow through the procedure.
- Explain instances where they get challenges.

- Lead learners to realise that when finding the unknown exponent, they should first form an algebraic equation of indices, then solve for the unknown.

Conclusion

- Learners read the Study tip to summarise the lesson.
- Let them attempt Application 3.7 in their exercise books.
- Mark their work, then give feedback.
- In case of any numbers failed, help with the correct working and answers.
- Then learners take notes.

Remedial Exercise

Slow learners should re-do Application 3.7.

Let them also try these:

- | | | |
|-----------------------------|--------------------------|-----------------------------|
| (a) $3^n \div 2^x = 2^5$ | (b) $5^y \div 5^3 = 5^4$ | (c) $6^x \div 6^4 = 6^3$ |
| (d) $10^m \div 10^9 = 10^1$ | (e) $2^4 \div 2^3 = 2^?$ | (f) $8^d \div 8^6 = 8^{12}$ |

Additional Exercise

Fast learners should attempt this exercise.

- | | | |
|--------------------------------|-----------------------------|-----------------------------|
| (a) $2^4 \div 2^x = 2^5$ | (b) $4^7 \div 4^y = 4^2$ | (c) $7^9 \div 7^n = 7^{12}$ |
| (d) $12^{13} \div 12^m = 12^7$ | (e) $3^{2n} \div 3^4 = 3^4$ | (f) $5^{3x} \div 5^1 = 5^5$ |

Lesson 3.8

Finding the Lowest Common Multiple (LCM) Of numbers

(40 minutes)

Learner's Book, page 48

Introduction

- Start by asking learners to recite some of the multiplication tables: 4, 5, 6, 7, 8, 9, 11 and 12.
- Ask them to form groups and guide them as they carry out the activity in the Learner's Book, page 48.
- Ask learners to list the first 10 multiple of 8 and 12.

Development

- Allow each group to report its findings and later discuss as a class to come up with a general report.

First ten multiples of 8 are, 8, 16, 24, 32, 40, 48, 56, 64, 72, 80.

First ten multiples of 12 are 12, 24, 36, 48, 60, 72, 84, 96, 108, 120.

The multiples which are common are 24 and 48, 72.

The lowest of the common multiples is 24.

- Display a chart with an example involving finding the LCM and discuss the example with the learners.

- Refer to the examples in the Learner's Book, page 48.
- Guide the learners through as you explain where challenges arise.
- Take learners through method 1 step by step and later through method 2.
- Emphasise to the learners that in method 1, the LCM is equal to the product of all prime factors.
- Give learners more examples and encourage them to use the table method of prime factorising (method 1) so that they continue practising it.

Conclusion

- Lead learners through the Study tip and use it to emphasise what you have just taught.
- Let learners attempt Application 3.8 in the Learner's Book, page 49.
- Ensure that you make a review on prime numbers because some learners tend to mix up prime numbers with odd numbers. For example many learners confuse 9 to be a prime number.

Remedial Exercise

Let slow learners prime factorise the following numbers using both the prime factor tree or the table.

- (1) Prime factorise 24
- (2) Find the prime factors of 28
- (3) List the prime factors of 30
- (4) Prime factorise 36
- (5) What are the prime factors of 40

Additional Exercise

Fast learners can find LCM of more than 3 numbers. Find the LCM of the following:

- | | | |
|----------------------|-----------------------|----------------------|
| (1) 8, 12, 16 and 24 | (2) 5, 10, 15 and 20 | (3) 7, 14, 21 and 28 |
| (4) 6, 8, 9 and 12 | (5) 12, 15, 18 and 24 | |

Lesson 3.9

Solving problems involving LCM (40 minutes)

Learner's Book, page 49

Introduction

- Take learners through a quick review of the previous sub-unit in the Learner's Book, page 48.
- Ask to form groups and carry out the activity in the Learner's Book, page 49. Guide them as they work out.
- Let them report their findings and finally do it as class to come up with one conclusive answer.

Development

- Help them to realise that the activity they carried out was another way of finding the LCM of 10 and 15.
- Display a chart with an example and ask learners to read the example.
Example: A market vendor made 9 heaps of 5 oranges each and no orange remained. She later re-arranged the oranges and made 15 heaps of 3 oranges each and no oranges remained. What is the least number of oranges that she had?
- Let learners read the question and suggest what to do.
- Help them to realise that they have to find the LCM of 9 and 15.
- Guide them as they find the LCM by listing multiples and later by prime factorising to come up with 45 oranges.
- Take learners through the example in the Learner's Book, page 49.

Conclusion

- Allow learners to raise a few questions and later take them through the Study tip
- Guide learners as they attempt Application 3.9 in the Learner's Book, page 50.
- Encourage learners to read every detail of the questions because failure to do so may lead to answering wrongly.

Remedial Exercise

1. Uwacu had some bananas. She divided them into 4 groups of 6 bananas each and no banana remained. She again divided them into 2 groups each of 12 bananas. How many bananas did she have?
2. What is the least number of fruits that one needs to make 5 groups of 6 fruits each or 3 groups of 10 fruits each?

Additional Exercise

You can set more complex questions for fast learners and let them read and work out, for example;

1. The bell for the lower primary classes rings every after 30 minutes, that for the middle classes every after 40 minutes and that for the upper classes every after 60 minutes. After how many hours will they ring together?
2. The plane which goes to East African countries leaves the airport after every 60 minutes, that which goes to South Africa after every 80 minutes and that which goes to London after every $2\frac{1}{2}$ hours. After how many hours will the planes leave at the same time?

Lesson 3.10**Finding the Greatest Common Factor (GCF) of numbers
(40 minutes)****Learner's Book, page 50****Introduction**

- Start by asking learners what factors are, then list factors of numbers you dictate to them.
- Ask learners to form groups and guide them as they carry out the activity in the Learner's Book, page 50.
- Find the factors of 24, 36 and 48.
- List the factors that are common.
- What is the greatest common factor of all the common factors?

Development

- Ask each group to report its findings and later make one report out of the many.
That is: factors of 24 are: 1, 2, 3, 4, 6, 8, 12, 24.
factors of 36 are: 1, 2, 3, 4, 6, 9, 12, 18, 36.
factors of 48 are: 1, 2, 3, 4, 6, 8, 12, 16, 24, 48.
Listing the common factors gives 1, 2, 3, 4, 6 and 12. So the greatest of all the common factors is 12.
- Explain to the learners that some people refer to the greatest common factor as the highest common factor.
- Write an example involving finding the GCF on the chalkboard and explain to the learners thoroughly.
- Guide learners through the examples in the Learner's Book, page 51.

Conclusion

- Discuss the Study tip and use it to explain both methods further.
- Guide learners as they attempt Application 3.10 in Learner's Book, page 51.
- Emphasise that to find GCF, list down all the factors of the given numbers, pick out the common factors then the greatest common factor.

Remedial Exercise

Let slow learners find the GCF of simple numbers.

- (1) Find the GCF of 4 and 6? (2) Find the GCF of 6 and 8.
 (3) What is the GCF of 4 and 8? (4) Find the GCF of 9 and 12.
 (5) What is the GCF of 5 and 10?

Additional Exercise

Fast learners can find the GCF and LCM of the following numbers:

1. Find the GCF and LCM of 20 and 36.
2. Work out the GCF and LCM of 42 and 64.
3. Find the GCF and LCM of 50 and 75.

Lesson 3.11 Solving Problems Involving GCF (40 minutes)

Learner's Book, page 52.

Introduction

- Review finding the GCF of numbers which was learnt in the previous lesson.
- Ask learners to form groups and carry out the activity in the Learner's Book, page 52.
- Let them report what they found out.
- Write a general report on the chalkboard; for example;
Numbers that can divide 20 are 1, 2, 4, 5, 10, 20.
Numbers that can divide 45 are 1, 3, 5, 9, 15, 45.
Yes, there are numbers which are common to both lists and that is 1 and 5.
The greatest of those common numbers is 5.
- Help learners to realise that when they ask for numbers that divide others, they are asking for factors.

Development

- Display a chart and use it to guide learners through the example on it.
- Refer to the example in the Learner's Book, page 52.
- Ask learners to read the question and guide them through the working.
- You can provide another example on the chalkboard for more practice.
- For example: Find the mass of the largest paper bag which you can use pack rice from big sacks of 25 kg, 50 kg and 80 kg such that no rice remains in each of the sacks.
- Let learners read the question and discuss it. Help them to realise that they have to find the GCF of 25 and 50 which is 5.

Conclusion

- Guide learners through the Study tip and use it to emphasise the example that you have just used.
- Guide the learners as they attempt Application 3.11 in the Learner's Book, page 52.
- Mark their work and give feed back.
- Help them to make correction.
- Let them take notes in their exercise books.
- Encourage learners to always read and understand the question before working it out.

Remedial Exercise

Let slow learners work out simple word problems to practise for example;

1. What is the greatest number that can divide 4 and 6?
2. Find the greatest number that can divide 6 and 8.
3. Which is the largest number that can divide 12 and 15 without leaving a remainder?
4. Given the number 6, 8 and 12, what is the greatest number that can divide each of them?

Additional Exercise

Fast learners can work out more challenging problems similar to the ones below. Three friends harvested maize grain. The first harvested 950 kg, the second harvested 1050 kg and the third harvested 800 kg. They want to pack the maize grain into sacks such that non remains. What should be the mass of the sacks they must use?

Lesson 3.12**Finding the Unknown Number Using LCM and GCF (40 minutes)**

Learner's Book, page 53

Introduction

- Review finding the GCF.
- Distribute learners in groups.
- Let learners study, then discuss the steps to be carried out in working out the activity in the Learner's Book, page 53.
- Assess each group's report and help to harmonise the work and come up with a general report.

Development

- Learners should be led to discover that in the activity, two numbers whose LCM and GCF are given, one number is missing.
- In order to work out the missing number, the product of LCM and GCF is divided by the given number.
- Refer the learners to the examples in the Learner's Book, page 53.
- Guide them through the procedure step by step. Do not rush, otherwise some learners may become confused.
- Repeat going through the procedure several times for the benefit of slow learners.
- Write an example on the chalkboard and let learners attempt to work it out, as you supervise their working out.

Example: LCM of two numbers is 24. Their GCF is 4. One of the numbers is 12. Find the second number.

Tell learners that:

Product of 2 numbers = product of LCM and GCF

$$2^{\text{nd}} \text{ number } (x) \times 12 = 24 \times 4$$

$$2^{\text{nd}} \text{ number } (x) = \frac{24 \times 4}{12}$$

$$2^{\text{nd}} \text{ number} = 8$$

Therefore, the second number is 8.

- Ask learners to formulate other questions similar to the example.
- Let them work them out and share the outcomes.
- Harmonise the procedure.

Conclusion

- Learners read the study tip and use it as a summary of the lesson.
- Let them attempt Application 3.12 in the Learner's Book, page 54.
- Mark their work and give feedback.
- Help them to correct the numbers they failed, then take notes.

Remedial Exercise

- (a) The LCM of two numbers is 12. The GCF is 12. One of the number is 6. What is the other number?
- (b) The LCM of two numbers is 6. The GCF is 3. If one of the numbers is 3, what is the other number?
- (c) The GCF of two numbers is 3. The LCM is 18, One of the numbers is 9. Find the other number.
- (d) One of the two numbers is 10. Their LCM is 10 and GCF is 5. What is the second number?

Fast learners work out more challenging problems similar to the ones below.

- (a) The LCM of two numbers is 225. Their GCF is 15. One of the numbers is 75. Find the other number.
- (b) GCF of two numbers is 12. The numbers are 36 and y . If the LCM is 144, what is the value of y ?
- (c) The LCM of two numbers is 1,440. The GCF is 10. One of the numbers is 160. Find the second number.
- (d) The GCF of two numbers is 10. One of the numbers is 70. The LCM is 1,050. Find the other number.

Consolidation Activity

1. Find the LCM and GCF of the following number:
 - (a) 132 and 120
 - (b) 40 and 60
2. Work out

- (a) $34 \div 32$ (b) $72 \div 7$ (c) $24 \times 23 \times 22$

Remedial Activity

Let learner's go through the previous worked activities and examples

Extension Activity

- (1) At Twelve Years Basic Education school two bells ring at 8:00 o'clock. If one rings after 40 minutes to indicate primary lesson period and the second rings after 50 minutes to indicate secondary lesson period. At what time will they ring together again?
- (2) Two lines of electricity have different intervals with lengths of 40 m for the first line and 50m for the second line. If the first poles of both line are parallel, what shortest distance both poles will be parallel again? Explain your working out.

Answers to Application 3.1

1. (a) 7^5 (b) 6^7 (c) 10^5 (d) 8^3
 (e) 9^7 (f) 12^6
2. (a) 4^9 (b) 2^7 (c) 11^9 (d) 20^4
3. (a) $3 \times 3 \times 3 \times 3 \times 3 \times 3 \times 3$ (b) $5 \times 5 \times 5 \times 5 \times 5 \times 5 \times 5 \times 5 \times 5$
 (c) $2 \times 2 \times 2 \times 2 \times 2 \times 2 \times 2 \times 2 \times 2 \times 2 \times 2 \times 2$
 (d) $100 \times 100 \times 100 \times 100 \times 100 \times 100$

Answers to Application 3.2

1. (a) 5 (b) 6 (c) 10 (d) 8 (e) 2
2. (a) 5 (b) 9 (c) 4 (d) 7 (e) 6
3. 9^6 4. $11 \times 11 \times 11 \times 11 \times 11 \times 11 \times 11$ 5. 6^{13} (exponent 13, base 6)

Answers to Application 3.3

1. (a) 6^5 (b) 9^4 (c) 10^{11} (d) 12^9 (e) 4^8
 (f) 5^4 (g) 7^{10} (h) 20^7
2. (a) 128 (b) 100,000 (c) 4,096 (d) 3,125 (e) 161,051

Answers to Application 3.4

1. (a) $\frac{4 \times 14}{4_1} = 4$ (b) $\frac{6^1 \times 6^1 \times 6^1 \times 6 \times 6}{6_1 \times 6_1 \times 6_1} = 6^2$
 (c) $\frac{9^1 \times 9^1 \times 9^1 \times 9^1 \times 9 \times 9 \times 9}{9_1 \times 9_1 \times 9_1 \times 9_1} = 9^3$ (d) $\frac{11^1 \times 11^1 \times 11^1 \times 11^1 \times 11 \times 11}{11_1 \times 11_1 \times 11_1 \times 11_1} = 11^2$
2. (a) $5^{3-1} = 5^2$ (b) $8^{6-3} = 8^3$
 (c) $10^{8-6} = 10^2$ (c) $12^{6-4} = 12^2$

3. (a) $\frac{9^1 \times 9^1 \times 9^1 \times 9^1 \times 9 \times 9 \times 9}{9_1 \times 9_1 \times 9_1} = 9^{7-3} = 9^4$
- (b) $\frac{11^1 \times 11^1 \times 11^1 \times 11^1 \times 11 \times 11 \times 11 \times 11 \times 11 \times 11}{11_1 \times 11_1 \times 11_1 \times 11_1} = 11^{10-4} = 11^6$
- (c) $\frac{12^1 \times 12^1 \times 12^1 \times 12^1 \times 12 \times 12}{12_1 \times 12_1 \times 12_1 \times 12_1} = 12^{6-4} = 12^2$
- (d) $\frac{4^1 \times 4^1 \times 4^1 \times 4^1 \times 4 \times 4 \times 4 \times 4 \times 4 \times 4}{4_1 \times 4_1 \times 4_1 \times 4_1} = 4^{10-4} = 4^6$
4. (a) $\frac{4^1 \times 4^1 \times 4^1 \times 4^1 \times 4}{4_1 \times 4_1 \times 4_1 \times 4_1} = 4^{5-4} = 4$
- (b) $\frac{10^1 \times 10^1 \times 10^1 \times 10^1 \times 10}{10_1 \times 10_1} = 10^{5-2} = 10^3 = 1,000$
- (c) $\frac{12^1 \times 12^1 \times 12^1 \times 12^1 \times 12^1 \times 12^1 \times 12 \times 12}{12_1 \times 12_1 \times 12_1 \times 12_1 \times 12_1 \times 12_1} = 12^{8-6} = 12^2 = 144$

Answers to Application 3.5

1. (a) $\frac{(a^1 \times a) \times (a^1 \times a \times a)}{(a_1 \times a_1 \times a)}$
- (b) $\frac{(e^1 \times e^1 \times e^1 \times e^1 \times e) \times (e^1 \times c \times c \times c)}{(e_1 \times e_1 \times e_1 \times e_1 \times e_1 \times e)}$
- (c) $\frac{(10^1 \times 10^1 \times 10 \times 10 \times 10) \times (10 \times 10 \times 10 \times 10 \times 10 \times 10)}{(10_1 \times 10)}$
2. (a) $q^{(4+5)-6} = q^3$ (b) $m^{(4+-2)-1} = m^1 = m$
- (c) $8^{(-5+4)-2} = 8^{-3}$
3. (a) 5 (b) 16,807 (c) 121

Answers to Application 3.6

- (a) $y = 1$ (b) $x = 4$ (c) $n = 4$ (d) $k = 3$ (e) $n = 16$
- (f) $f = 1$ (g) $y = 12$ (h) $y = 8$ (i) $r = 0$ (j) $x = -3$
- (k) $k = 9$ (l) $y = 1$

Answers to Application 3.7

- (a) $x = 2$ (b) $y = 3$ (c) $m = 6$ (d) $n = 3$ (e) $k = 6$
- (f) $x = 2$ (g) $y = 2$ (h) $n = 4$ (i) $y = 4$ (j) $a = 12$

(k) $q = 8$ (l) $x = 2$

Answers to Application 3.8

(a) 24 (b) 144 (c) 77 (d) 96 (e) 60
(f) 300 (g) 450 (h) 1,260

Answers to Application 3.9

(1) 300 min or 5 hrs (2) 45 books (3) 90 (4) 360
(5) 60 (6) 150

Answers to application 3.10**Factors**

1. (a) $30 = 1, 2, 3, 5, 6, 10, 15, 30$;
 $40 = 1, 2, 4, 5, 8, 10, 20, 40$ The G.C.F=10
- (b) $120 = 1, 2, 3, 4, 5, 6, 8, 10, 12, 15, 20, 24, 30, 40, 60, 120$
 $180 = 1, 2, 3, 4, 5, 6, 9, 12, 15, 18, 20, 30, 36, 45, 60, 90, 180$
The G.C.F=60
- (c) $180 = 1, 2, 3, 4, 5, 6, 9, 10, 12, 15, 18, 20, 30, 36, 45, 60, 90, 180$
 $240 = 1, 2, 3, 4, 5, 6, 8, 10, 12, 15, 16, 20, 24, 30, 40, 48, 60, 80, 120, 240$
The G.C.F=60
- (d) $60 = 1, 2, 3, 4, 5, 6, 10, 12, 15, 30, 60$
 $120 = 1, 2, 3, 4, 5, 6, 8, 10, 12, 15, 20, 24, 30, 40, 60, 120$
 $180 = 1, 2, 3, 4, 5, 6, 9, 10, 12, 15, 18, 20, 30, 36, 45, 60, 90, 180, 120$
The G.C.F=60
- (e) $60 = 1, 2, 3, 4, 5, 6, 10, 12, 15, 20, 30, 60$
 $120 = 1, 2, 3, 4, 5, 6, 8, 10, 12, 15, 20, 24, 30, 40, 60, 120$
The G.C.F=60
- (f) $45 = 1, 3, 5, 9, 15, 45$
 $60 = 1, 2, 3, 4, 5, 6, 10, 12, 15, 20, 30, 60$
 $75 = 1, 3, 5, 15, 25, 75$

2. (a)

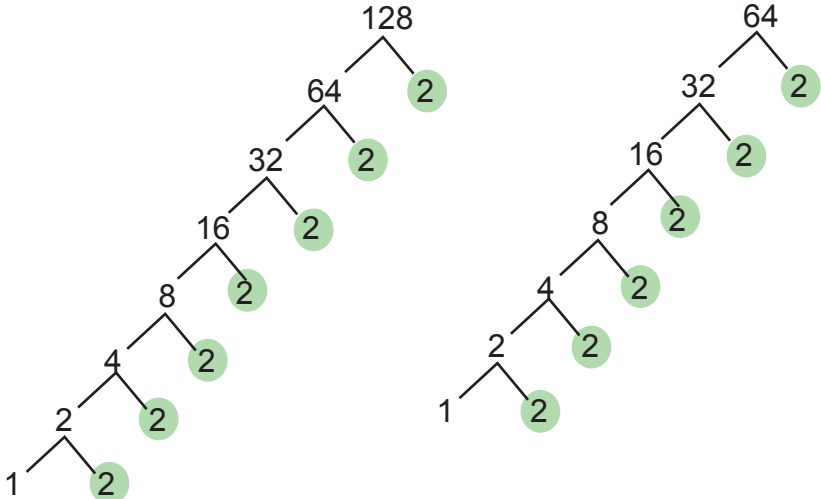

(b)

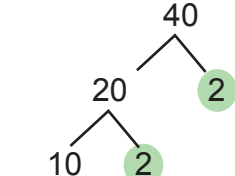

(c)

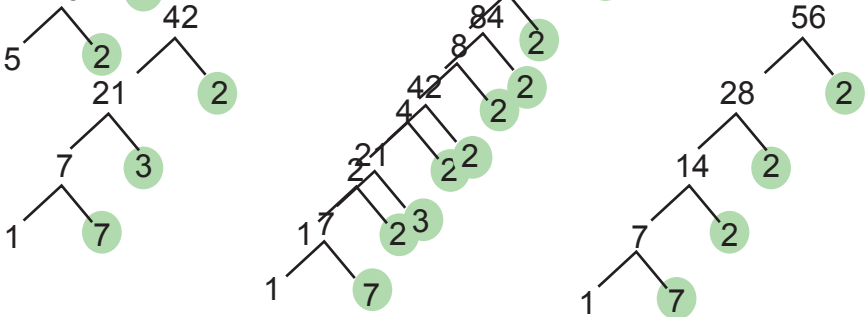

(d)

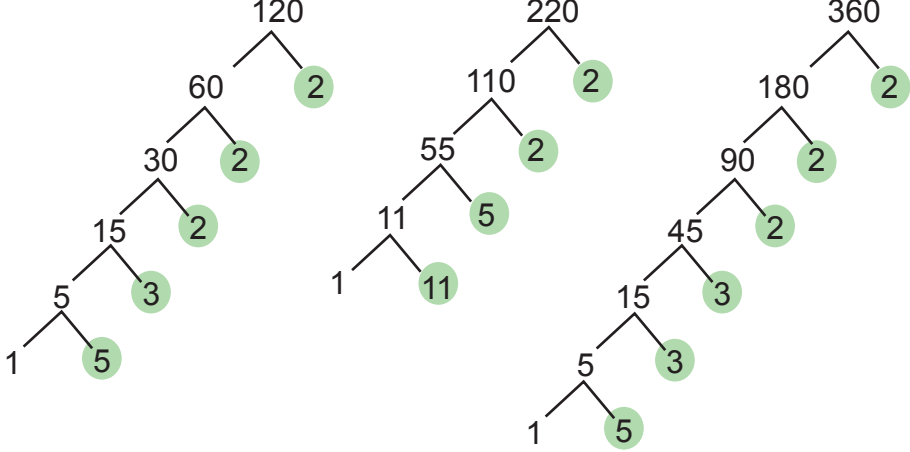

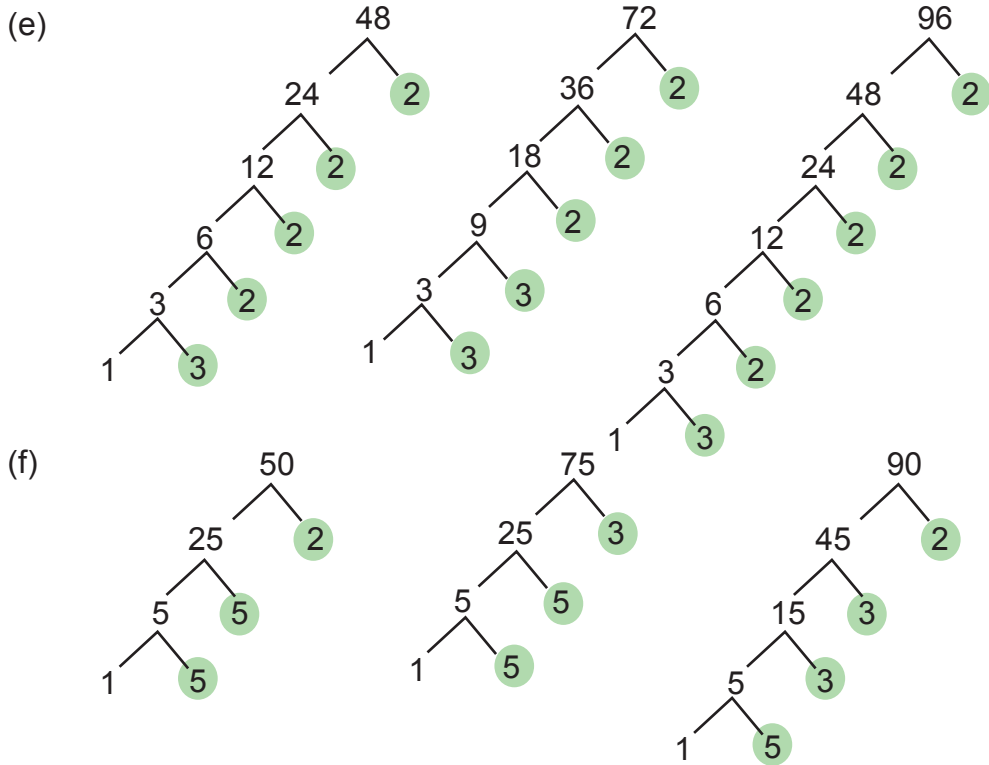

Answers to application 3.11

- (1) 18 (2) 5 litres (3) 12 kg (4) 30 kg (5) 2

Answers to application 3.12

- (3) 45 (4) 90 (5) 15
 (6) 16 (7) 15 (8) $h = 12$

End of Unit 3 Assessment

- (1) a) 1 b) 3^2 c) 75 d) 53
 e) 121 f) 133
 (2) a) LCM = 120; GCF = 60 b) LCM = 3312; GCF = 4
 c) LCM = 180; GCF = 3
 (3) 10 cm (4) 9:00 a.m (5) 12 litres (6) After 280 min/10:40 a.m

Unit 4

Operations on Fractions

Key unit competence: To be able to apply fractions in daily life situations and solve related problems.

List of lessons

Lessons	Number of lessons	Number of periods
4.1 Multiplying a whole number by a fraction.	1	2
4.2 Multiplying a fraction by a whole number.	1	1
4.3 Multiplying a fraction by a fraction.	1	1
4.4 Solving problems involving multiplying fractions.	1	2
4.5 Finding reciprocals	1	1
4.6 Dividing a whole number by a fraction.	1	1
4.7 Dividing a fraction by a whole number.	1	2
4.8 Dividing a fraction by a fraction.	1	2
4.9 Solving problems involving dividing fractions.	1	2
4.10 Multiplying and dividing fractions.	1	2
Assessment	1	2
Total	11	17

Guidance on problem statement

This unit comprises the operation on fractions. It is important to deal with it because it is all about sharing. This unit is aimed to help learners to know why is it necessary to study fractions so that they know how fractions may be applied in every day situation. Give learners time to go through the introductory activity on page 55 in learner's book.

Cross-cutting issues

Throughout the teaching process of this unit, it will be crucial to help learners to master the content and it is better to address cross-cutting issues where possible. In this unit, we will address the following cross-cutting issues as non-stand alone within classroom activities and through the development of the content.

- **Peace and value education:** First of all as a teacher you have to be a peace maker in your class and role model so that learners will imitate how you behave. When there is any conflict, do not leave without helping to solve it within the lesson. Encourage learners to behave well, being humble, honest, etc.
- **Gender Education:** This cross-cutting issue will be addressed through giving equal opportunities to both boys and girls during the lesson. That is to mean they should participate equally in the learning activity.

Learning Objectives

Knowledge and understanding

- Explain how to multiply and divide fractions.
- Describe how to calculate problems involving fractions

Skills

- Multiply and divide fractions.
- Solve word problems involving fractions.
- Explain the steps taken when working out word problems involving fractions.

Attitudes and values

- Appreciate the importance of fractions in daily life situations.
- Confidence and accuracy should be exhibited among learners across different tasks.

Number of lessons: 17

Guidance for classroom organisation

Before you start the lesson, first use warm-ups or energizers in order to engage the learners into the lesson. Do not focus on this only, try to be creative.

The essence is to motivate the learners and make them active throughout the teaching- learning process. Help learners to form groups before you assign them the activity. While they are doing the activity, walk around while monitoring their work and helping where they have difficulties.

Learning and teaching materials for the Unit

Manila cards, scissors, markers and masking tape and other materials that a teacher may see as important to achieve his/her objective.

Lesson 4.1**Multiplying a Whole Number by a Fraction (80 minutes)****Learner's Book page 55****Introduction**

- Give mental work about what a fractions is, simple addition and subtraction of fractions.

For example, $\frac{1}{2} + \frac{1}{2}$, $\frac{1}{4} + \frac{3}{4}$, $\frac{1}{2} + \frac{1}{4}$, $\frac{2}{5} + \frac{1}{5}$.

$\frac{1}{2} - \frac{1}{4}$, $\frac{3}{4} - \frac{1}{2}$, $\frac{5}{6} - \frac{2}{6}$, etc.

- Group the learners and distribute the learning materials.
- Guide them through the activity in the Learner's Book, page 55.
- Facilitate the discussion about the activity.
- Harmonise the outcomes to come out with a general answer.

Introduction

- Let them be familiar with the concept to develop.
- Explain that, the activity learners have been involved in is about multiplying a whole number by a fraction. 9 represents a whole and $\frac{1}{2}$ represent one part of the whole number.
- Multiplication statement is $9 \times \frac{1}{2} = \frac{9}{2} = 4\frac{1}{2}$, meaning, if joined; 4 whole beans and $\frac{1}{2}$ of a bean will be obtained.
- Write an example on the chalkboard.

Example: $12 \times \frac{3}{4}$

Explain that, this multiplication statement means, "twelve three quarter". It is the same as adding $\frac{3}{4}$ twelve times.

That is, $\frac{3}{4} + \frac{3}{4} + \frac{3}{4} + \frac{3}{4} + \frac{3}{4} + \frac{3}{4} + \frac{3}{4} + \frac{3}{4} + \frac{3}{4} + \frac{3}{4} + \frac{3}{4} + \frac{3}{4} = \frac{36}{4} = 9$

Like wise; $12 \times \frac{3}{4} = \frac{12}{1} \times \frac{3}{4} = \frac{12 \times 3}{1 \times 4} = \frac{36}{4} = 9$

So, $12 \times \frac{3}{4} = 9$ wholes.

- Let learners follow through the examples in the Learner's Book, page 55.
- Guide them through with clear explanations step by step.
- Learners should formulate their own questions relating to the lesson.
- Move around monitoring how they carry out the working.
- Contented that they have grasped the concept, let them give a report about their work.

Conclusion

- Let learners read the Study tip, as a summary of the lesson.
- They should attempt Application 4.1.
- Mark the work and give feedback.
- Correct the numbers they fail, if any, and let them take notes.

Remedial Exercise

Slow learners should attempt the exercise below:

- | | | | |
|-----------------------------|----------------------------|-----------------------------|----------------------------|
| (a) $2 \times \frac{1}{2}$ | (b) $3 \times \frac{1}{4}$ | (c) $4 \times \frac{1}{5}$ | (d) $6 \times \frac{2}{3}$ |
| (e) $10 \times \frac{1}{2}$ | (f) $7 \times \frac{1}{7}$ | (g) $12 \times \frac{2}{3}$ | (h) $9 \times \frac{2}{9}$ |

Let fast learners multiply the following numbers:

- | | | | |
|-------------------------------|-------------------------------|-------------------------------|--------------------------------|
| (a) $70 \times 1\frac{1}{9}$ | (b) $56 \times 4\frac{1}{7}$ | (c) $101 \times 3\frac{1}{3}$ | (d) $169 \times 1\frac{9}{12}$ |
| (e) $262 \times \frac{1}{15}$ | (f) $340 \times 3\frac{4}{5}$ | (g) $506 \times 4\frac{1}{3}$ | (h) $969 \times 5\frac{2}{13}$ |

Lesson 4.2

Multiplying a fraction by a whole number (40 minutes)

Learner's Book page 56

Introduction

- Start with mental work on multiplication. For example, 9×3 , 3×7 , 8×9 , 12×6 , 7×6 , 12×5 .
- Ask learners to form groups and provide each group with the materials required to carry out the activity.
- Guide learners as they carry out the activity in the Learner's Book, pages 56 and 57. Walk around supervising them as they carry out the activity.

Observe the sugarcane below:

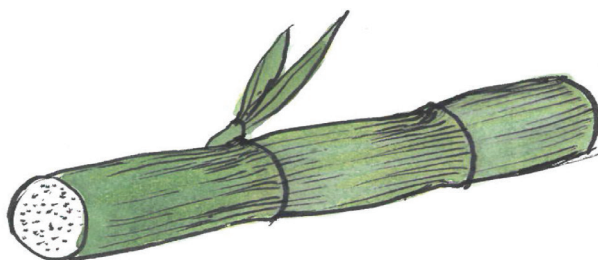

1. How many parts does the sugar cane have?
2. Write the fraction representing one part.

3. Multiply the fraction above by 3.

4. What do you get?

- Ask each group to report what it has got as the answer.
- Give a general report and help learners to realise that 1 out of 3 parts of a sugar cane is $\frac{1}{3}$.

Development

- Guide learners through the examples in the Learner's Book page 57 and clearly show them that "of" means multiplication.
- Explain to them that to multiply a fraction by a whole number, they should write the whole number as a fraction by giving it denominator 1, then multiply the numerators and finally divide by the denominator.
- Give learners an example to work out in groups and check on each group to see whether they are following.

Conclusion

- Guide the learners through the Study tip and use it to emphasise what you have just taught.
- Guide the learners as they attempt Application 4.2.
- Mark their answers and give feed back and help them do corrections.
- Let them take notes.
- Explain to the learners why they should write whole numbers as fractions by writing 1 under them. Show them how to cancel if you are sure that they are good at multiplication and division.
- Provide more exercises for the next period that will enable learners to master the content.

Remedial Exercise

Slow learners can work out simple numbers for practise, for example;

(1) Find $\frac{1}{2}$ of 112,

(2) Find $\frac{1}{3}$ of 15

(3) Find $\frac{1}{7}$ of 21

(4) what is $\frac{1}{5}$ of 35?

(5) What is $\frac{1}{5}$ of 30?

(6) What is $\frac{1}{12}$ of 36?

Additional Exercise

Let fast learners work out more complex numbers: For example;

What is $4\frac{1}{2}$ of 124?

(2) What is $3\frac{1}{4}$ of 168?

(3) What is $6\frac{1}{5}$ of 50?

(4) Find $6\frac{2}{3}$ of 240

(5) Find $4\frac{7}{12}$ of 300

Lesson 4.3**Multiplying a Fraction by a Fraction (40 minutes)****Learner's Book page 58****Introduction**

- Start with mental work on multiplication and division. For example; 8×7 , 4×9 , 6×7 , $48 \div 4$, $54 \div 9$, $60 \div 5$ and so on.
- Ask learners to form groups and provide each group with either paper or a manilla card.
- Guide them as they carry out the activity in Learner's Book page 58.

Development

- Give them time to report their findings and later come up with one report.

Study the figure below and answer the questions that follow

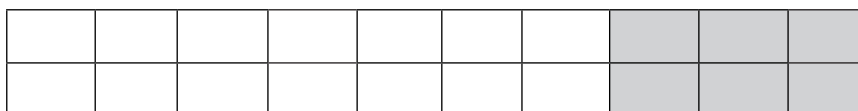

- Write the portion of the coloured fraction above.
 - Multiply it by $\frac{1}{2}$.
 - Write your answer on a piece of paper.
 - Read it loudly.
- Write an example that involves multiplying a fraction by a fraction on the chalkboard.
Example: Multiply: $\frac{2}{5} \times \frac{1}{3} = \frac{2 \times 1}{5 \times 3} = \frac{2}{15}$
 - Explain to the learners that we multiply the numerators then the denominators.
 - Refer to the Learner's Book page 58 and guide learners as they study the examples.
 - Display a chart and explain further to the learners. Remind them that when a mixed number is included in the problem they should change it to an improper fraction first.

Conclusion

- Guide the learners through the Study tip and explain further.
- Ask learners to attempt Application 4.3.
- You can try out multiplication of other fractions practically so that learners can clearly see how it comes out.

Remedial Exercise

Let slow learners do more simple numbers to practise, for example;

1) $\frac{1}{3} \times \frac{1}{3} \times \frac{1}{3}$

(2) $\frac{1}{4} \times \frac{1}{2} \times \frac{1}{3}$

(3) $\frac{2}{5} \times \frac{1}{3} \times \frac{1}{2}$

(4) $\frac{2}{3} \times \frac{1}{4} \times \frac{1}{3}$

(5) $\frac{4}{5} \times \frac{1}{2} \times \frac{2}{3}$

(6) $\frac{2}{3} \times \frac{3}{4} \times \frac{1}{2}$

(7) $\frac{2}{5} \times \frac{3}{4} \times \frac{1}{3}$

(8) $\frac{5}{6} \times \frac{1}{2} \times \frac{2}{3}$

Additional Exercise

Fast learners should try out the following for more practice.

(1) $1\frac{1}{4} \times 1\frac{1}{6} \times 1\frac{1}{3}$

(2) $2\frac{1}{2} \times 1\frac{3}{5} \times 3\frac{1}{4}$

(3) $7\frac{1}{3} \times 4\frac{1}{2} \times 3\frac{2}{11}$

(4) $8\frac{1}{4} \times 2\frac{3}{11} \times 4\frac{1}{5}$

(5) $4\frac{3}{8} \times 3\frac{3}{7} \times 5\frac{1}{6}$

Lesson 4.4**Solving Problems Involving Multiplying Fractions (80 minutes)****Learner's Book page 59****Introduction**

- Start with mixed mental work related to what the learners are going to learn. For example; change $2\frac{1}{2}$ to an improper fraction. How many times does 7 go into 21? What is $\frac{9}{4}$ as a mixed fraction? How many times does 4 go into 36? and so on.
- Ask learners to get to their groups and provide each group with the necessary materials

Development

- Guide learners as they carry out the activity in the Learner's Book, page 59.
- Ask them to report what they have found out.
- Later carry out the same activity as the class watches to make sure the results they got are the same result you get.
- Refer to the Learner's Book pages 59 and 60 and guide learners as they study the examples.
- Display a chart with an example similar to the ones in the book.
- Ask learners to read the questions and work out in their groups.

Example: $\frac{2}{3}$ of learners in Uwera's school are boys. If $\frac{1}{4}$ of the boys play volley ball, find the fraction of those who play volley ball.

Conclusion

- Move around as you check on each group to ensure that they are doing the right thing.
- Guide learners as they attempt Application 4.4.
- Take them through Study tip
- Mark their work and give feed back. Help them do corrections.
- Let them summarize the current lesson.
- Let them take notes
- Ensure that learners practise the multiplication tables since they are crucial when carrying out cancellation.

Remedial Exercise

Provide slow learners with simple word problems to practise for example;

1. A jerrycan was $\frac{5}{6}$ full of water. Keza used $\frac{1}{2}$ of the water to wash the utensils. Find the fraction of the water that remained.
2. $\frac{3}{4}$ of the patients in a clinic are suffering from malaria. $\frac{1}{2}$ of those with malaria are children. What is the fraction of the children suffering from malaria?

Additional Exercise

Fast learners can try out more complex numbers to practise for example;

3. $\frac{5}{9}$ of the people in a village are adults. $\frac{1}{3}$ of the adults are between 25 and 50 years and $\frac{1}{5}$ of them are between 50 and 75 years.
 - (a) Find the fraction of people between 25 and 50 years.
 - (b) What is the fraction of people between 50 and 75 years?
4. $\frac{5}{6}$ of the food in a store is grain. $\frac{2}{5}$ of the grain is rice and $\frac{1}{4}$ of it is maize.
 - (a) What is the fraction of rice in the store?
 - (b) Find the fraction of maize in the store.

Lesson 4.5

Finding reciprocals (40 minutes)

Learner's Book page 61

Introduction

- Help learners to form groups.
- Provide prepared materials.
- Distribute them to the learners.
- Let them know how they are going to go through the activity.
- Make sure that all learners are ready for the activity.

Development

- Let them write any fraction of their choice.
- Ask them to multiply the fraction by an unknown
- Request them to equate it to 1.
- Calculate to find the value of the unknown.
- Let them explain what they have observed.
- Give time for presentation.
- Take them through the examples in Learner's Book, page 62.
- Let them compare their work with the one in the book.
- Explain to them the working process.
- Let them share their working step with the whole class.

Conclusion

- Give learners time for reading through the Studytip.
- Let them share how they are understanding it.
- Take them through Application 4.4 in the Learner's Book, page 62.
- Mark their work and help them with corrections.
- Let them take notes.

Lesson 4.6**Dividing a Whole Number by a Fraction (40 minutes)****Learner's Book page 62****Introduction**

- Review finding reciprocals.
- Guide learners as they carry out the activity in the Learner's Book, page 62.
- Give them time to present their findings to the class.

Development

- Group the learners and distribute the learning materials.
- Explain that the activity was involving dividing a whole number by a fraction.
For example, 2 is the whole number.



Cutting the 2 sheets into 4 equal parts is dividing.

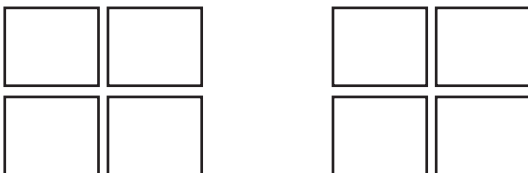

- Notably, each portion of a whole sheet is 1 out of 4 written as $\frac{1}{4}$.

- So, the division is about dividing 2 by $\frac{1}{4}$.
- Form the diagrammatic expression above, 2 sheets of paper have been divided in 8 quarters.
- Therefore, $2 \div \frac{1}{4} = 2 \times \frac{4}{1} = 8$ quarters.
- Write an example on the chalkboard and ask learners to attempt it on slips of paper. $15 \div \frac{2}{5} =$
- Learners have already been exposed to finding reciprocals. They are expected to observe that the reciprocal of $\frac{2}{5}$ is $\frac{5}{2}$.
- Learners work out the multiplication expression.

$$15 \times \frac{5}{2} = \frac{75}{2} = 37\frac{1}{2}$$
- Let learners study and follow through the examples.
- Help then where challenges arise.

Conclusion

- Take them through the Study tip as a summary of the lesson.
- Ask them to attempt Application 4.6 in the Learner's Book, page 63.
- Mark their work, then give feed back.
- Help them with corrections.
- Let them take notes in their exercise books.

Remedial Exercise

Slow learners should attempt the exercise below:

- | | | | |
|--------------------------|--------------------------|--------------------------|-----------------------------|
| (a) $2 \div \frac{1}{2}$ | (b) $2 \div \frac{1}{3}$ | (c) $3 \div \frac{1}{3}$ | (d) $4 \div \frac{1}{4}$ |
| (e) $5 \div \frac{1}{5}$ | (f) $5 \div \frac{2}{3}$ | (g) $6 \div \frac{1}{2}$ | (h) $10 \times \frac{1}{2}$ |

Additional Exercise

Let fast learners multiply the following numbers:

- | | | | |
|--------------------------------|--------------------------------|---------------------------------|---------------------------------|
| (a) $19 \times 4\frac{1}{9}$ | (b) $24 \div 3\frac{1}{7}$ | (c) $108 \div 10\frac{1}{8}$ | (d) $156 \times 11\frac{4}{9}$ |
| (e) $164 \times 24\frac{1}{7}$ | (f) $207 \times 4\frac{1}{11}$ | (g) $1,036 \times 4\frac{1}{3}$ | (h) $1,646 \times 5\frac{1}{7}$ |

Lesson 4.7 Dividing a fraction by a whole number (80 minutes)

Learner's Book, page 63

Introduction

- Start with simple mental work for example;
What do you get when you divide 1 orange into 2?
What does one get when he divides 1 pancake into 3?
- Draw an orange and divide it into two equal parts, each is $\frac{1}{2}$.
- After, divide each $\frac{1}{2}$ into 3 parts.
- Now count the parts you have.
- Read it loudly.

Development

- Get learners into their groups and provide each group with 10 fruits or circular cards.
- Guide them as they carry out the activity in the Learner's Book page 63.
- Let them report what they get after carrying out the activity.
- Take learners through the examples in the Learner's Book, page 64 each time showing them clearly how to go over it.

Divide $\frac{1}{2}$ by 3.

The reciprocal of 3 is $\frac{1}{3}$

$$\frac{1}{2} \div 3 = \frac{1}{2} \times \frac{1}{3} = \frac{1}{6} \text{ (Multiply by the reciprocal of the second fraction)}$$

- Display a chart with examples and discuss each of them with the learners.

Conclusion

- Come up with a common understanding.
- Let learners read the Study tip and allow them to ask questions if any.
- Harmonise the collection of ideas.
- Ask learners to attempt Application 4.7 in the Learner's Book.
- Mark their work and help them do corrections.
- Let them take notes.
- Emphasise that like in multiplication of fractions, all mixed numbers must be changed to improper fractions before dividing.

Remedial Exercise

Slow learners can carry out simple division of fractions for practise.

$$(1) \frac{1}{8} \div 4 \quad (2) \frac{1}{6} \div 3 \quad (3) \frac{4}{5} \div 5 \quad (4) \frac{5}{12} \div 6$$

Additional Exercise

Gifted learners can try out more complex numbers.

$$(1) 2\frac{1}{2} \div 4 \quad (2) 3\frac{1}{4} \div 8 \quad (3) 4\frac{1}{5} \div 15$$

$$(4) 7\frac{1}{2} \div 10 \quad (5) 5\frac{2}{3} \div 9 \quad (6) 4\frac{3}{4} \div 16$$

Lesson 4.8**Dividing a fraction by a fraction (80 minutes)****Learner's Book page 64****Introduction**

- Review the previous lesson.
- Give learners prepared questions.
- Ask them to form groups and provide each group with the necessary materials.
- Guide them as they carry out the activity in Learner's Book page 64.

Development

- Give them time to report their findings and later come up with a general report.
- Write an example that involves dividing a fraction by a fraction on the chalkboard.

Example: Divide: $\frac{2}{7} \div \frac{1}{3} = \frac{2}{7} \times \frac{3}{1} = \frac{2 \times 3}{7 \times 1} = \frac{6}{7}$

- Refer to the Learner's Book and guide them as they study the examples.
- Display a chart and explain further to the learners. Remind them that when a mixed number is included in the problem they should change it to an improper fraction first.

Conclusion

- Guide learners through the Study tip and explain further.
- Ask them to attempt Application 4.8 in the Learner's Book.
- You can try out division of other fractions practically so that learners can clearly see how it comes out.

Remedial Exercise

Let slow learners do more simple numbers to practise more for example;

1) $\frac{1}{3} \div \frac{1}{3}$

(2) $\frac{1}{4} \div \frac{1}{2}$

(3) $\frac{2}{5} \div \frac{1}{3}$

(4) $\frac{2}{3} \div \frac{1}{4}$

(5) $\frac{4}{5} \div \frac{1}{2}$

(6) $\frac{2}{3} \div \frac{3}{4}$

Additional Exercise

Fast learners should try out the following for more practice.

(1) $1\frac{1}{4} \div 1\frac{1}{6}$

(2) $2\frac{1}{2} \div 1\frac{3}{5}$

(3) $7\frac{1}{3} \div 4\frac{1}{2}$

(4) $8\frac{1}{4} \div 2\frac{3}{11}$

(5) $4\frac{3}{8} \div 3\frac{3}{7}$

Lesson 4.9**Solving Problems Involving Dividing Fractions (80 minutes)**

Learner's Book, page 65

Introduction

- Start with division mental work, for example;
- How many times does; 3 go into 24, 5 go into 30, 6 go into 42, 8 go into 72, 10 go into 70? and so on.
- Ask learners to form groups.
- Guide learners as they carry out the activity in the Learner's Book, page 65

Development

- Ask learners to report their results and later discuss as a class to come up with uniform results.
- That is; cards that give the same answer are;

$$\frac{3}{4} \text{ of a jerrycan} = 15 \text{ litres}$$

$$1 \text{ jerrycan} = 15 : 3 \text{ (divide by } \frac{3}{4} \text{)}$$

$$15 \times \frac{4}{3} \text{ (multiply by the reciprocal)}$$

$$= 5 \times 4 = 20 \text{ litres}$$

- Refer to the Learner's Book, page 66 and guide learners as they study the example.
- Display the chart you prepared and use the contents on it to explain further to the learners.
- Example; A shopkeeper sold 80 kg of the beans he had. This was $\frac{4}{5}$ of the full sack. How many kg were in the full sack?

- Ask learners to read the question and through a discussion help them to realise that, if $\frac{4}{5}$ of the full sack is 80 kg, then they have to divide 80 by $\frac{4}{5}$.

$$\text{Hence, } \frac{4}{5} \text{ of sack} = 80 \text{ kg}$$

$$\begin{aligned} 1 \text{ sack} &= 80 \div \frac{4}{5} \\ &= 80 \times \frac{5}{4} = 100 \text{ kg} \end{aligned}$$

Conclusion

Let learners attempt Application 4.9 as you guide them.

- Help them to sum up the lesson by reading the Study tip.
- Mark their work and give feed back
- Emphasise to the learners that to find the original number or amount they should divide by the given fraction.

Remedial Exercise

Let slow learners try out similar numbers but which are a bit simple for practice.

For example;

- Mbabazi used 12 litres of water which was $\frac{3}{5}$ of a full jerrycan. How many litres does a full jerrycan hold?
- It started raining when Mukandori had covered 50 metres of her journey to school. This was $\frac{2}{7}$ of the journey. How many metres are there from Mukandori's home to school?
- Karekezi sold 24 of his goats. That was $\frac{3}{8}$ of the goats he had. How many goats did he have?

Additional Exercise

Fast learners can try out more complex numbers, for example;

- A farmer sold 840 kg of coffee. This was $\frac{3}{7}$ of his harvest.
 - Find the amount of coffee that he harvested.
 - What is the fraction of coffee that remained?
 - If he again sold $\frac{1}{2}$ of the remaining coffee, how many kg did he sell?
- There were 4800 people in the stadium. This is $\frac{2}{5}$ of its capacity.
 - What is the capacity of the stadium?
 - What is the fraction of the seats that were not occupied?
 - If $\frac{1}{3}$ of the people who were in the stadium were women, find the number of women who were there.

Lesson 4.10 Multiplying and Dividing Fractions (80 minutes)

Learner's Book, page 66

Introduction

- Review multiplying and dividing fractions.

Example: $\frac{1}{2} \times \frac{1}{6}$; $\frac{2}{3} \times \frac{1}{2}$; $\frac{3}{5} \times \frac{3}{4}$; $\frac{9}{10} \times \frac{1}{3}$; $3 \div \frac{1}{2}$; $\frac{3}{4} \div 2$; $\frac{1}{2} \div \frac{1}{4}$, etc.

- Group learners and distribute the learning materials.
- Let them get involved in the activity in the Learner's Book, page 66.
- Guide the learners through the procedure.
- Harmonise their outcomes.

Development

- Let learners be familiar with the concept.
- Explain that the lesson is about combining multiplying and dividing fractions.
- Challenge learners to form a multiplication and division operations problem on slips of paper.
- Let them try to work them out, as you check on them.
- Write an example on the chalkboard. Interact with learners in developing the steps for its calculation.

Example: $\frac{3}{4} \times \frac{4}{9} \div \frac{5}{6}$

Step 1: Learners should remind themselves about which operation is to be handled first. Let them use BODMAS (Brackets operation division multiplication, addition and subtraction). Follow the operations as stated.

They should observe that division is handled first. So it is $\frac{4}{9} \div \frac{5}{6}$ that is worked out first.

$$\begin{aligned} \frac{4}{9} \div \frac{5}{6} &= \frac{4}{9} \times \frac{6}{5} \text{ (multiply by the reciprocal of } \frac{5}{6} \text{ which is } \frac{6}{5} \text{.)} \\ &= \frac{8}{15} \end{aligned}$$

Step 2: Without shifting positions, $\frac{3}{4}$ is multiplied by the result from division.

$$\text{So, } \frac{3}{4} \times \frac{8}{15} = \frac{2}{5}$$

- Lead learners into all the necessary steps so that they grasp the concept thoroughly.
- Refer to the examples in the Learner's Book, page 67.
- Let learners study and follow through the steps of the calculation.
- Take time to explain exhaustively the concept.

Conclusion

- Lead learner to read and explain the Study tip.
- They should read it repeatedly as a summary of the lesson.
- Let them attempt Application 4.10, page 68.
- Collect and mark their work.
- Give feedback, then learners take notes in their class work books.

Remedial Exercise

Slow learners should attempt the exercise below:

(a) $\frac{1}{2} \times \frac{1}{2} \div \frac{1}{2}$ (b) $\frac{1}{2} \times \frac{1}{3} \div \frac{1}{3}$ (c) $\frac{1}{3} \times \frac{1}{2} \div \frac{1}{2}$ (d) $\frac{1}{4} \times \frac{1}{2} \div \frac{1}{4}$

Additional Exercise

Let fast learners attempt the exercise below:

(a) $5\frac{2}{7} \times 7\frac{3}{4} \div 6\frac{2}{3}$ (b) $9\frac{3}{9} \times 8\frac{6}{7} \div 7\frac{2}{5}$

(c) $11\frac{3}{5} \times 7\frac{3}{4} \div 4\frac{3}{5}$ (d) $12\frac{1}{6} \times 1\frac{7}{12} \div 9\frac{1}{4}$

Extension activities

Work out:

- (1) $\frac{3}{5} \times \frac{2}{5}$ (2) $\frac{1}{2} \div \frac{1}{2}$
- (3) Munyana shared an orange among her 3 children. She gave each child $\frac{1}{4}$ of the orange. What is the total fraction for all the children?
- (4) $(3\frac{2}{5} \times 5) \div (\frac{1}{3} + \frac{1}{4}) =$
- (5) In the action of helping refugees each has given $\frac{1}{4}$ of a bar soap. How many bars of soap were served if all refugees are 1000 people?
- (6) Two third of the learners in primary 6 are girls. If the boys are 20, how many girls are in the classroom?

Answers to Application 4.1

- 1) (a) $2\frac{1}{3}$ (b) 9 (c) 12 (d) $26\frac{1}{4}$
 (e) 99 (f) 39 (g) 99 (h) $233\frac{1}{3}$
- 2) 30 3) $266\frac{2}{3}$ 4) 407 5) $428\frac{2}{5}$

Answers to Application 4.2

- 1) (a) 3 (b) 6 (c) 21 (d) 48
 (e) 145 (f) $1\frac{1}{5}$ (g) 9 (h) $1\frac{1}{2}$
 2) 220 minutes 3) 261 chairs 4) 555books 5) 1196 oranges
 6) 2 7) 15 8) 198 9) 756

Answers to Application 4.3

- (a) $\frac{1}{54}$ (b) $\frac{9}{35}$ (c) $\frac{2}{15}$ (d) $\frac{1}{66}$
 (e) $\frac{1}{12}$ (f) $1\frac{1}{20}$ (g) $3\frac{27}{40}$ (h) $\frac{1}{6}$
 (i) $31\frac{1}{2}$ (j) $11\frac{3}{4}$ (k) $\frac{513}{680}$ (l) $26\frac{7}{12}$

Answers to Application 4.4

- 1) (a) $\frac{1}{2}$ (b) 150,000frw
 2) (a) $\frac{3}{8}$ (b) Ali got 200kg, Moses got 300kg Katto got 300kg
 3) (a) $\frac{2}{5}$ (b) $12\frac{1}{2}$ litres
 4) 24,000frw 5) 30 acres

Answers to Application 4.5

- (a) $\frac{1}{4}$ (b) $\frac{1}{6}$ (c) $\frac{1}{9}$ (d) $\frac{1}{13}$
 (e) $\frac{1}{20}$ (f) $\frac{1}{42}$ (g) $\frac{1}{13}$ (h) 2
 (h) 8 (i) 11 (j) $1\frac{1}{2}$ (k) $2\frac{1}{3}$
 (l) $1\frac{7}{8}$ (m) $\frac{3}{4}$ (n) $\frac{10}{19}$ (o) $\frac{5}{12}$
 (p) $\frac{4}{13}$ (q) $\frac{7}{29}$ (r) $\frac{20}{231}$ (s) $\frac{1}{10}$ (t) $\frac{1}{18}$

Answers to Application 4.6

- (a) 2 (b) 50 (c) $37\frac{1}{2}$ (d) 55
 (e) 45 (f) 48 (g) 156 (h) $9\frac{15}{31}$
 (i) 45 (j) 24 (k) 42 (l) 3

Answers to Application 4.7

- (a) $\frac{5}{42}$ (b) $\frac{1}{12}$ (c) $\frac{2}{6}$ (d) $\frac{3}{5}$
 (e) $\frac{7}{10}$ (f) $\frac{27}{52}$ (g) $\frac{7}{10}$ (h) $\frac{1}{2}$
 (i) $\frac{5}{12}$ (j) $\frac{1}{10}$ (k) $\frac{1}{4}$ (l) $\frac{2}{9}$

Answers to Application 4.8

- (a) $3\frac{3}{8}$ (b) $2\frac{1}{2}$ (c) $2\frac{2}{9}$ (d) $3\frac{1}{9}$
 (e) $2\frac{43}{55}$ (f) $2\frac{26}{33}$ (g) $2\frac{10}{27}$ (h) $\frac{89}{218}$
 (i) $2\frac{298}{1083}$ (j) $1\frac{3}{7}$ (k) $\frac{2}{3}$ (l) $4\frac{1}{5}$

Answers to Application 4.9

- (1) 3 (2) 280 km (3) 40 hectares
 (4) 50 questions (5) 100 pieces

Answers to Application 4.10

- (a) $1\frac{1}{8}$ (b) $1\frac{3}{5}$ (c) $\frac{6}{7}$ (d) $\frac{9}{16}$
 (e) $1\frac{1}{2}$ (f) $1\frac{17}{18}$ (g) $2\frac{1}{10}$ (h) $3\frac{39}{44}$
 (i) $4\frac{8}{9}$
 (d) 50 questions (e) 100 pieces

Answers to End of unit 4 assessment

- 1) (a) $\frac{4}{15}$ (b) $4\frac{4}{5}$ (c) $\frac{3}{5}$ (d) $1\frac{1}{2}$
 (e) $23\frac{1}{3}$ (f) $137\frac{1}{4}$ (g) $\frac{1}{6}$ (h) $2\frac{16}{17}$
 (i) 2 (j) $2\frac{1}{3}$
 2) Food 384, 000frw , sch fees 160,000frw others 96,000frw
 3) (a) $\frac{4}{15}$ (b) 225 saplings 4) 36km 5) 500ml 6) $12\frac{1}{2}$

Unit 5

Rounding and Converting Decimals, Fractions/ Numbers

Key unit competence: To be able to apply fractions in daily life situations and solve related problems.

List of lessons

Lessons	Number of lessons	Number of periods
5.1 Rounding off decimal numbers to the nearest tenth.	1	1
5.2 Rounding off decimal numbers to the nearest hundredth.	1	1
5.3 Rounding off decimal numbers to the nearest thousandth.	1	1
5.4 Rounding off decimal numbers to the nearest ten thousandth.	1	1
5.5 Rounding off decimal numbers to the nearest hundred thousandth.	1	1
5.6 Rounding off decimal numbers to the nearest millionth.	1	1
5.7 Solving problems involving rounding off decimal numbers.	1	2
5.8 Converting fractions into decimal numbers.	1	2
5.9 Converting decimals into fractions.	1	2
5.10 Solving problems involving converting decimals into fractions and fractions into decimals.	1	2
Assessment	1	2
Total	10	16

Guidance on problem statement

In this unit, the concern is rounding and conversion of fractions. The learners have to know why sometimes it is necessary to present numbers in simplest form not stating all digits. Take learners through the introductory activity in the learner's book page 69

Cross-cutting issues

Throughout the teaching process of this unit, it will be crucial to help learners

to master the content and it is better to address cross-cutting issues as where possible. In this unit we will address the following cross-cutting issues non-stand alone within classroom activities and through the development of the content.

- **Peace and value education:** First of all as a teacher, you have to be a peace maker in your class and role model so that learners will imitate how you behave. When there is any conflict, do not leave without helping to solve it within the lesson. Encourage learners to behave well, being humble, honest, etc.
- **Gender education:** This cross-cutting issue will be addressed through giving equal opportunities to both boys and girls during the lesson. This should be addressed through the way learners work equally in their respective groups. Make sure both boys and girls respond.

Learning Objectives

Knowledge and understanding

- Explain how to round off decimal fractions.
- Describe the various steps taken when rounding off numbers.
- Illustrate and explain how to match fractions and decimals.

Skills

- Convert fractions to decimals and vice versa.
- Explain how to round off numbers.
- Apply the knowledge acquired to match fractions and decimals.
- Carry out various calculations on rounding off numbers.

Attitudes and values

- Confidence and accuracy should be exhibited among learners in groups.
- Self-control should be emphasised in groups such that a learner-centred approach is practised.

Number of lessons: 16

Guidance for classroom organisation

- Before you start the lesson, first use warm-ups or energizers in order to engage the learners into the lesson.
- Do not focus on this only, try to be creative. The essence is to motivate the learners and make them active throughout the teaching- learning process.
- Help learners to form group before you assign them the activity.
- While they are doing the activity, walk around while monitoring their work and helping where they have difficulties.

Learning and teaching materials for the Unit

Manila cards, scissors, markers and masking tape and other materials that teacher may see as important to achieve his/her objective.

Lesson 5.1**Rounding off decimal numbers to the nearest tenth
(40 minutes)****Learner's Book pages 69****Introduction**

- Review rounding off whole numbers to the nearest tens, hundreds etc.
- Group the learners and distribute the learning/instructional materials.
- Let them carry out the activity as laid out in the Learner's Book, page 69.
- Guide the learners as they discuss about the activity, then give conclusive remarks.
- Give them time to present in front of the class.

Development

- Let them be familiar with the concept.
- Explain that the lesson is about rounding off the given decimal numbers to the nearest tenth.
- Provoke the learners to identify the place value for tenth in a given example, hence its digit.

Example: Round off 0.52 to the nearest tenth.

Study the decimal number below and;

(i) Identify the place value for tenth.

(ii) What digit is in tenth?

(iii) Round off to the nearest tenth.

0.52
 |
 | hundredths
 |
 | tenths

- Learners should observe that 5 is in "tenth" place value.
- Let them know that rounding off decimals is almost similar to rounding off whole numbers. The next digit to the right is either rounded up or down.
- In the case above, learners should observe that the digit to the right is 2.
- Basing on the experience about rounding off whole numbers, 2 is nearer to zero (0) than to 10.
- So, zero is added to the digit in the required place value then eliminate the place value to the right.

$$\begin{array}{r} \text{So } 0.52 \\ + \quad 0 \\ \hline 0.5 \end{array}$$

0.52 rounded to the nearest tenth is 0.5.

- Explain further that the answer must bear a digit in the tenth place value as the last to the right.

- Now let the learners play a matching game using cards.
- Write several numbers on the chalkboard and ask learners to copy them on sheets of paper.
- In groups, let them flash cards bearing a rounded off decimal to the nearest tenth.
- Now refer to the examples in the Learner's Book page 70.
- Give more similar examples like the ones below:

(a) 0.92

Solution

$$0.92 = \begin{array}{r} 0.9\overset{0}{2} \\ + 0 \\ \hline 0.9 \end{array}$$

(Because 2 is nearer to 0.)

Therefore, 0.92 is rounded off to 0.9.

(b) 25.78

Solution

$$25.78 = \begin{array}{r} 25.7\overset{8}{8} \\ + 1 \\ \hline 25.8 \end{array}$$

(Because 8 is nearer to 1)

Therefore, 25.78 is rounded off to 25.8.

- Learners study, follow through then discuss the procedure as you guide them.
- Let them formulate their own and share the outcomes of the discussions.

Conclusion

- Guide learners as they read through the Study tip in order to internalise it.
- Ask them to attempt Application 5.1 in the Learner's Book, page 70.
- Mark their work and give feed back. Help them do corrections.
- Let them come up with a summary.
- Let them take notes
- It is expected that learners may not get challenged because they have already been exposed to rounding up or down.
- Emphasise that "tenth" are also referred to as "one place of decimals"

Remedial Exercise

Let slow learners study the number line below then round up or down the digits marked.



Additional Exercise

Fast learners can round off more numbers to the nearest tenth:

(1) 0.589

(2) 3.064

(3) 9.0825

(4) 12.0012

(5) 20.2010

(6) 141.769

(7) 200.200

(8) 301.0001

Lesson 5.2**Rounding off to the nearest hundredth (80 minutes)****Learner's Book, page 71****Introduction**

- Take learners through a warm-up.
- Help them to form groups.
- Give them prepared materials.
- Review rounding off to the nearest tenth.
- In groups, let learners carry out the activity in the Learner's Book, page 71.
- Guide them through the activity.
- Let them do the group presentations.

Development

- Display the chart with the worked examples.
- Let the learners follow through the procedure as they discuss the contents of the example.
- Explain conclusively and give another example.
- Example; Round off 99.816 to the nearest hundredth.
- Let the learners copy it down on sheets of paper and follow the steps.

99.816 6 is rounded up 10 thousandths or 1 hundredth

required place value.

so 99.81

$$\begin{array}{r} + \quad 1 \\ \hline 99.82 \end{array}$$

99.816 \approx 99.82 (to the nearest hundredth).

- Now let learners follow through the example in the Learner's Book, page 71.
- Guide them as they observe the procedure.
- On their own, let the learners formulate similar numbers.
- Let them discuss the procedure then share the outcomes.

Conclusion

- Let them proceed to the Study tip as conclusive remarks.
- Ask them to attempt Application 5.2 that follows.
- Involve all the learners in the activities.
- Explain cases where approximation can be carried out ,like distance, etc.

Remedial Exercise

Let slow learners try out the following for more practice.

Which of the numbers below are nearer to 1.70?

(1) 1.61 (2) 1.67 (3) 1.60 (4) 1.69 (5) 1.65 (6) 1.62

Which of the decimals below are nearer 3.60?

(1) 3.61 (2) 3.69 (3) 3.64 (4) 3.67 (5) 3.62

Additional Exercise

Let fast learners practice more using the following;

Round off to the nearest hundredth.

(1) 131.0131 (2) 6.0004 (3) 19.9009 (4) 121.1212

Draw a number line and on it place the decimals below.

(1) 120.663 (2) 120.667 (3) 120.669 (4) 120.661

Lesson 5.3**Rounding off Decimal Numbers to the Nearest Thousandth
(40 minutes)**

Learner's Book, page 72.

Introduction

- Review the previous lesson.
- Ask learners to mention examples of decimals in Thousandth.
- Record them on the chalkboard.
- In groups, let learners carry out the activity as you guide them.
- Explain that, Thousandth possess 3 decimal places. But, the decimal number to be rounded off possesses 4 decimal places or more.

Development

- Further explain that, as experienced earlier, the digit to the right of the required place value is the one rounded up or down.
- Write an example on the chalkboard, and let the learners lead in explaining the procedure then round off to the nearest Thousandth.

Example

Round off 6.3093 to the nearest Thousandth.

- Learners should observe that 9 is in the place value of Thousandth and 3 is the next digit to the right.
- 3 is rounded down because it is nearer to 0 Thousandth.
- zero (0) is added to the digit in the Thousandth place value.
- Explain each step of the working, that is;

6.3093 3 is rounded down to 0
 required place value.

$$\begin{array}{r} 6.3093 \\ + \quad 0 \\ \hline 6.309 \end{array}$$

So, $6.3093 \approx 6.309$ (rounded to the nearest Thousandth)

- Now let the learners study and follow through an example for group discussion.
- Facilitate a discussion among them, then they share the opinions.
- Representatives from each group flash the cards as members from another check it to see whether they got it right.

Conclusion

- By this time every learner is expected to have grasped the method.
- Let learners internalise the concept by reading the Study tip.
- Guide learners as they attempt Application 5.3 in the Learner's Book, page 73.
- Mark their work and help them do corrections.
- Let them take notes.

Remedial Exercise

Slow learners can try out the following;

1. List the decimals between 1.026 and 1.035.
2. Round off 1.0268 to the nearest thousandth.
3. Round off 1.0264 to the nearest thousandth.

Additional Exercise

Let fast learners read and work out some word problems.

1. A village had an area of 10.3925 sq km. Approximately what was the area rounded to the nearest thousandth?
2. Round off to the nearest thousandth. (a) 146.07598 km (b) 200.89621 dam³
3. What is 9999.9999 nearer to? Round to the nearest thousandth

Lesson 5.4

Rounding off decimal numbers to the nearest ten thousandth (40 minutes)

Learner's Book pages 73

Introduction

- Review the previous lesson.
- Let learners form groups.
- Distribute the necessary learning materials.
- Let them carry out the activity in the Learner's Book as you guide them.
- Lead learners to observe that, ten Thousandth possess 4 decimal places. The number to be rounded off may have more than 4 decimal places.

Development

- Explain that, as seen in the activity, the digit to the right of the digit in the ten Thousandth place value is the one rounded up or down.
- Give more examples by writing them on chalkboard or dictating them. Learners should attempt them in groups.

For example: Round off 3.067259.

- Learners find out that 2 is the digit in the required place value of ten Thousandth. The digit to the right of ten Thousandth is 5. Learners observe that 5 is in the upper limit. So 5 is rounded off to 10 hundred Thousandth. And 1 ten thousandth is added to 2 ten Thousandth to get 3 ten Thousandth.
- In summary, it is worked out this way:

$$\begin{array}{r}
 3.067256 \\
 \begin{array}{l} \text{└─ 5 is nearer to 10 hundred thousandths} \\ \text{└─ Required place value} \end{array} \\
 \\
 3.067256 = + \begin{array}{r} 3.0672\overset{1}{5}6 \\ \underline{1} \\ 3.0673 \end{array}
 \end{array}$$

Therefore, 3.067259 rounded off to the nearest ten thousandth is 3.0673.

- Lead the learners through the examples in the Learner's Book.

Conclusion

- Let learners read the Study tip as a summary of the lesson.
- Let them attempt Application 5.4.
- Mark their work and give feedback.
- Help with the corrections as they take notes.

Remedial Exercise

Slow learners should try out the following:

- How many decimal places has a decimal number in the ten Thousandth place value?
- List 5 decimal numbers in ten Thousandth.

Additional Exercise

Fast learners should attempt the following for more practice.

- Add: 1.76586 and 17.6586. Round off the answer to the nearest ten thousandth.
- Round off to the nearest ten thousandth:
 - 0.000493 g
 - 1.42560 m
 - 15.996981 litres
- Winfred had 3.16753 hectares of land. She gave out 1.04694 to her children. How much did she remain with? Round off the answer to the nearest ten thousandth.

Lesson 5.5**Rounding off decimal numbers to the nearest hundred thousandth (40 minutes)****Learner's Book pages 74****Introduction**

- Give mental work about rounding up or down. For example, mention a digit as learners respond by answering "round up to" or round down to zero".
(a) 4 (b) 3 (c) 9 (d) 5
- Review the previous lesson.
- Distribute learners in groups.
- Give out the suggested learning materials. Ask learners to get involved in the activity in the Learner's Book, page 74.
- Write down the matched decimal numbers on the chalkboard.
- Harmonise the responses as learners discuss to defend their outcomes.

Development

- Learners should be led to observe that, decimal numbers rounded to the nearest hundred thousandth must have 5 decimal places. The last digit must be in the hundred thousandth place value.
- Write examples of decimal numbers to be rounded off to the nearest hundred thousandth on the chalkboard.
- Ask learners to attempt them as you monitor their work.

For example: Round off 0.946384 to the nearest hundredth thousandth.

Look for the following in their procedure:

8 is the digit in the required place value of hundred Thousandth. The digit to its right is 4. 4 is in the lower limit, it is rounded down to 0 hundred Thousandth. 0 hundred thousandth is added to 8 hundred thousandth.

0.946384
 ↳ 4 is nearer to 0 hundred thousandths
 ↳ Required place value

$$3.067256 = + \begin{array}{r} 0.946384 \\ \hline 0.94638 \end{array}$$

0.946384 rounded off to the nearest hundred thousandth = 0.94638

- Let learners follow through the procedure laid down in the examples in the Learner's Book, page 74. Guide them where necessary.

Conclusion

- Let learners read and internalise the Study tip.
- Then they attempt Application 5.5, page 75.
- Mark their work and give feedback.
- Learners take notes in their exercise books.

Remedial Exercise

Slow learners should attempt out the following for more practice:

1. Underline the digit in the hundred thousandth place value.
(a) 0.426874 (b) 1.048969 (c) 12.2401375
2. State whether the digit you underlined is rounded up or rounded down.

Additional Exercise

Fast learners should attempt the following for more practice.

1. Area of a district is 401.073258 square kilometres. Round it off to the nearest hundred thousandth.
2. Distance from town A to town B is 7.012897 km. Round it off to the nearest hundred thousandth.
3. A sack of beans weighs 119,246,043 milligrams. Convert it to kilograms. Round off the answer to the nearest hundred thousandth.

Lesson 5.6

Rounding off decimal numbers to the nearest millionth (40 minutes)

Learner's Book pages 75

Introduction

- Review the previous lesson.
- Let learners form groups and distribute the necessary learning materials.
- Take learners through the activity in the Learner's Book, page 75.
- Move around monitoring their work.
- Write outcomes from each group on the chalkboard.
- Harmonise the outcomes to get a general report.

Development

- Explain that a decimal number rounded to the nearest millionth must possess 6 decimal digits after the decimal point. That is, it must have 6 decimal places.
- Write an example on the chalkboard for learners to practise on.

For example:

Round off 0.0769843 to the nearest millionth.

- On slips of paper, let them write the decimal number, identify the digit in the millionth place value, then round it off.
- Learners are expected to observe that 4 is in the millionth place value.
- They are expected to remember that 3, to the right of 4 is in the lower limit so, it is rounded down to 0 millionth.
- Zero (0) is added to 4 to get 4.

That is, 0.0769843

$$\begin{array}{r}
 \text{4 is nearer to 0 hundred thousandths} \\
 \text{Required place value} \\
 0.076984\overset{0}{3} \\
 0.0769843 = + \quad \underline{\quad 0 \quad} \\
 \hline
 0.076984
 \end{array}$$

Therefore, 0.0769843 rounded off to the nearest millionth is 0.076984.

- Learners formulate their own decimal numbers, then try to round off to nearest millionth.
- Facilitate their work to come up with a general opinion.
- Lead them through the examples in the learner's Book, page 75.

Conclusion

- Learners read and internalise the Study tip.
- They attempt Application 5.6, Learner's Book, page 76.
- Mark their work and give feedback.
- Help them to correct the wrong work.
- Let learner's take notes.

Remedial Exercise

Slow learners should attempt out the following for more practice:

Write the decimal numbers between the following:

- 0.1256730 to 0.1256734. Are the decimal numbers listed rounded up or down when rounding off to the nearest millionth?
- 3.0767515 to 3.0767519. Are the decimal numbers you listed rounded up or down when rounding off to the nearest millionth?

Additional Exercise

Fast learners should attempt the following for more practice.

- List 10 decimal numbers with 7 or more decimal places.
- Round off the decimal numbers in (a) above to the nearest millionth.

Lesson 5.7**Solving Problems Involving Rounding off Decimal numbers
(80 minutes)****Learner's Book pages 76****Introduction**

- Give mental work about rounding off decimal numbers so far experienced. For example: Round off 0.26 to the nearest tenth, round off 0.43 to the nearest tenth, round off 3.092 to the nearest hundredth, round off 12.005 to the nearest hundredth.
- Review rounding off decimal numbers generally, noting what steps are taken.
- Group learners and let them study the activity in the Learner's Book, page 76.

Development

- Explain that rounding off is similar to approximation or estimation.
- Tell learners that these can be applied in our daily life, to get figures that are easy to read, write or memorise.

For example: Population is sometimes estimated to round numbers easy to remember, like 12,000,000; 14,000,000 and so on.

- Sometimes dimensions are not exact figures of the units used in measurements, for example, 9.8 metres, 13.1 kilometres. These are nearer to 10 metres and 13 kilometres approximately.
- Write some examples on the chalkboard for learners to practice.

For example: The length of a classroom is 6.42 metres. What is the length rounded to the nearest whole metre?

Working: Learners should note that in this question, they are to apply rounding off to the nearest ones. The digit in ones is 6. The digit to the right is 4. They should observe 4 is rounded to 0 tenth which is also carried to ones as 0 metres. So, 6 metres + 0 metres = 6 metres. Therefore, 6.42 metres rounded to the nearest whole metres is 6 metres.

- However, explain that the dimensions do not increase in length or reduce. It is for simplicity purposes.
- Ask learners to contribute by listing things in real life that can be rounded off to different place values of units.
- Make a list on the chalkboard and facilitate a discussion about them.
- Come up with a general report.
- Refer to the examples in the Learner's Book, page 76.
- Follow through with the learners, then make a conclusion.

Remedial Exercise

Slow learners should attempt out the following for more practice:

Round off the following as instructed:

- (a) 1.3 cm to the nearest whole centimetre.
- (b) 6.75 m to the nearest tenth.
- (c) 0.957 km to the nearest hundredth.
- (d) 10.42 kg to the nearest whole kilogram.

Additional Exercise

Fast learners should attempt the following for more practice.

Estimate as instructed.

- (a) 3.56 kg to hectograms.
- (b) 0.927 km to dams.
- (c) 8,648.51 square kilometres to whole square kilometres.
- (d) 164 cm² to square metres.

Lesson 5.8**Converting of Fractions into Decimal Numbers (80 minutes)**

Learner's Book, page 77

Introduction

- Start with mental work on division. For example; $8 \div 4$, $10 \div 2$, $12 \div 6$, $18 \div 3$, $9 \div 3$, $12 \div 4$ and so on.
- Group the learners and distribute learning materials/aids.
- Let the learners carry out the activity as per instructions in the Learner's Book, page 77.
- Guide them as they carry out the matching.
- Now write the fraction $\frac{1}{4}$ on the chalkboard and ask the learners to change it into decimal.
- Many of the learners may seem confused and challenged.

Development

- Explain that writing fractions in decimals is a way of expressing the given fractions with denominators 10, 100, 1000, etc.
- The number of zero(s) in the denominator denotes the number of places of digits a numerator is placed from the decimal point.
- Explain further that to express $\frac{1}{4}$ as a decimal number,
 - (i) the denominator is expressed in terms of 100. It is done by multiplying by a common factor both in the numerator and denominator.

Learners suggest the numbers

$$\frac{1}{4} \times \frac{?}{?} = \frac{?}{100}$$

It is likely they will suggest 25.

$$\text{so } \frac{1}{4} \times \frac{25}{25} = \frac{25}{100}$$

- The denominator possesses 2 zeros, so the decimal formed possesses 2 places of decimal.

$$\frac{25}{100} = 0.25$$

- Explain that there is another method. It is carried out by dividing the numerator by the denominator.

That is; $\frac{1}{4} =$

$$\begin{array}{r} 0.25 \\ 4 \overline{) 1.00} \\ \underline{0} \\ (0 \times 4) = 0 \\ \underline{10} \\ (2 \times 4) = 8 \\ \underline{20} \\ (5 \times 4) = 20 \\ \underline{00} \end{array}$$

So, $\frac{1}{4} = 0.25$

- Write some more examples including mixed and recurring decimals on the chalkboard for the learners to do more practice using both methods.
- Now, distribute number cards; some showing fractions and others showing decimals.
- Let learners follow through as they discuss the procedure.
- Refer them to the examples in the Learner's Book, page 78. Lead them through as they ask questions. Explain to their satisfaction.

Conclusion

- Satisfied that they have grasped the concept, let them read and internalise the Study tip
- Let them attempt Application 5.8.
- Both methods are equally useful when converting fractions to decimals.
- Emphasise the place value matching in fractional and decimal form e.g $\frac{9}{1,000} = 0.009$ (meaning nine Thousandth).

Remedial Exercise

Let slow learners copy and complete the number line.

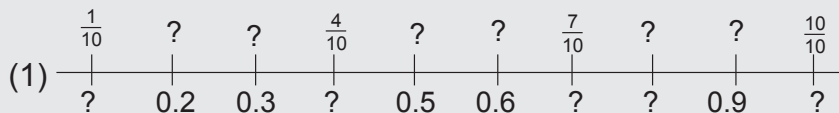

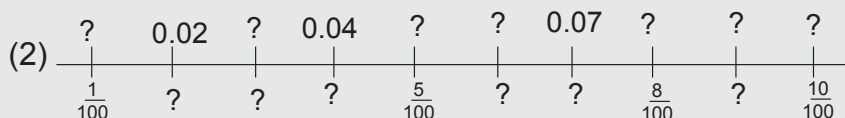

Additional Exercise

Fast learners can try out more challenging questions.

Convert the following to decimal numbers.

(1) $\frac{3}{50}$

(2) $1\frac{1}{20}$

(3) $4\frac{3}{50}$

(4) $\frac{113}{4}$

(6) Lucumu bought 1 kg of sugar. The bag got torn and 125 grammes got split. Express the remaining sugar as a decimal.

Lesson 5.9

Converting of decimals into fraction (80minutes)

Learner's Book page 79

Introduction

- Give mental work about the nature of common fractions and decimals.
- For example; what is $\frac{50}{100}$ expressed as a decimal?
- Review the previous lesson.
- Make a guided discussion as learners carry out the activity in the Learner's Book page 79 in groups.
- Convert the following decimals into fractions and show your working out.
(a) 0.2 (b) 0.4.
- Present your answers to the class.
- Explain that decimals can as well be written as fractions.

Development

- Remind learners that decimals are small parts of 10, 100, 1,000 etc and that the number of zeros denote the number of decimals and vice versa.
- Write some examples on the chalkboard for the learners to do practice as they discuss.

Example

Change these decimals into common fractions.

(1) 0.4 - identify the place value of the last digit 4.

$$= 0.4 \text{ (4 is in tenth, so the denominator of tenth is 10).}$$

$$= \frac{4}{10} \text{ (the zero and decimal point on the left of 4 are deleted).}$$

$$0.4 = \frac{4}{10}$$

It is normal to reduce to the lowest term.

$$\frac{4}{10} \div \frac{2}{2} = \frac{2}{5}$$

$$0.4 = \frac{4}{10} \text{ or } \frac{2}{5}$$

- Lead the learners through the examples in the Learner's Book pages 79 and 80.
- Give more examples or learners can formulate their own.

Example

$$\begin{aligned} \text{(a) } 0.236 &= \frac{236}{1000} \text{ (there are 3 decimal places, therefore, divide by 1,000} \\ &\quad \text{and simplify where possible)} \\ &= \frac{113}{500} \end{aligned}$$

$$\begin{aligned} \text{(b) } 4.09 &= \frac{409}{100} \text{ (there are 2 decimal places, therefore, divide by 100} \\ &\quad \text{and simplify where possible)} \\ &= 4\frac{9}{100} \end{aligned}$$

- Explain exhaustively about the conversions in example 3 and 4.
- Give learners time to internalise the concept.
- Guide them as they discuss the procedure.
- Let learners play a matching game of flashing cards numbered with corresponding fractions and decimals in their groups.

e.g.

$\frac{9}{100}$	→	0.09	→	$\frac{2}{3}$	→	0.66...
0.15	→	$\frac{3}{20}$	→	$\frac{6}{11}$	→	0.54...

Conclusion

- Guide learners as they read and discuss the Study tip.
- Let them attempt Application 5.9 in the Learner's Book, page 80.
- Mark their work and give feed back
- Let them write notes in their note book
- Emphasise the relationship between the number of decimal places and the number of zeros in the denominator.
- Alternatively you can use a number line to show conversion.

Remedial Exercise

Let slow learners change the following to fractions.

- | | | | | |
|---------|---------|---------|-----------|------------|
| (1) 0.9 | (2) 0.4 | (3) 1.6 | (4) 0.111 | (5) 2.7 |
| (6) 2.8 | (7) 3.2 | (8) 1.8 | (9) 0.444 | (10) 0.375 |

Additional Exercise

Ask gifted learners to change to mixed fractions then reduce to the lowest terms.

- | | | |
|------------|-------------|-------------|
| (1) 6.075 | (2) 12.0012 | (3) 0.888 |
| (4) 3.2333 | (5) 10.0075 | (6) 15.0625 |

Lesson 5.10**Solving Problems Involving Converting Decimals into Fractions and Fractions into Decimals (80 minutes)****Learner's Book, page 81****Introduction**

- Review the previous lesson.
- Make a guided discussion as learners carry out the activity in the Learner's Book, page 81 in groups.
- Think of a decimal number with three digits on the decimal place side.
- Write it on a piece of a paper.
- Give it to your colleague.
- Ask him/her to round it to the tenth place value and after convert it into a fraction.

Development

- Discuss the whole process.
- Is the last finding looking the same as the first? Explain.
- Write some examples on the chalkboard for the learners to do practice as they discuss.
- Lead the learners through the example in the Learner's Book, page 81.
- Guide them as they discuss the procedure.

Conclusion

- Guide learners as they read and discuss the Study tip.
- Let them attempt Application 5.10.
- Tell the learners to always read and interpret the word problems correctly before working them out.

Remedial Exercise

1. Take slow learners through worked examples in order to help them to catch up the level of others.
2. Prepare high order thinking questions for fast learners.

Extension activities

- 1) Work out then convert either to fraction or to decimal:
 - (a) $12.234 + 0.134 =$
 - (b) $5\frac{9}{10} \div \frac{2}{5} =$
 - (c) $56.078 \times 11 =$
- 2) Round off to the nearest:

(a) Tenth

- (i) $12.034 + 167.67 =$
 (ii) $999.999 =$
 (iii) $15623.292 - 89.003 =$

(b) Hundredth

- (i) $34.4 + 1728.87 =$
 (ii) $(78.12 + 12.006) \times 342 =$

Answers to Application 5.1

1. (a) 0.9 (b) 8.5 (c) 13.0 (d) 2.2
 (e) 15.0 (f) 18.3
2. (a) 56,748.9 (b) 875.4 (c) 264,537.2 (d) 12,354.7
 (e) 0.9 (f) 456.0

Answers to Application 5.2

- (a) 16.60 (b) 4.22 (c) 0.57 (d) 8.01
 (e) 367.81 (f) 6.00 (g) 5.27 (h) 0.65
 (i) 7.01 (j) 4.32 (k) 6.79 (l) 9.25

Answers to Application 5.3

- (a) 2.799 (b) 12.342 (c) 5.687 (d) 125.821
 (e) 1.469 (f) 25.010 (g) 7.236 (h) 34.697
 (i) 0.697 (j) 67.798 (k) 89.836 (l) 295.211

Answers to application 5.4

- (a) 0.0695 (b) 12.1068 (c) 482.0031 (d) 0.0025
 (e) 5.0000 (f) 19.0028 (g) 0.9757 (h) 73.0101
 (i) 1,206.07799 (j) 63,006.7099 (k) 723.9091 (l) 0.9178

Answers to application 5.5

- (a) 1.10101 (b) 0.06329 (c) 0.00619 (d) 15.73913
 (e) 92.09302 (f) 0.18531 (g) 100.68305 (h) 10.00000
 (i) 45.78909

Answers to Application 5.6

- (a) 0.125108 (b) 4.140732 (c) 0.050699 (d) 13.130364
 (e) 1.110943 (f) 46.932834 (g) 0.834207 (h) 0.032197
 (i) 85.073280

Answers to Application 5.7

- (1) 1,672 kg (2) 177 cm (3) 869.3 kg (4) 10 sec
 (5) 6.23 hectares (6) 3 kg (7) 1,467.5 (8) 236 km

Answers to Application 5.8

- (a) 0.65 (b) 0.3125 (c) 5.9 (d) 2.1
 (e) 0.4 (f) 1.375 (g) 1.375 (h) 5.75
 (i) 1.3636... (j) 1.333... (k) 0.111... (l) 0.666...
 (m) 0.36... (n) 0.54... (o) 1.333... (p) 0.5
 (q) 0.333... (r) 0.166... (s) 0.5 (t) 1.4

Answers to Application 5.9

- (a) $\frac{617}{5000}$ (b) $19\frac{67}{100}$ (c) $195\frac{1}{125}$ (d) $10\frac{2}{25}$
 (e) $17\frac{3}{10}$ (f) $13\frac{1}{2}$ (g) $54\frac{29}{1000}$ (h) $\frac{3}{8}$
 (i) $\frac{32}{125}$ (j) $56\frac{7}{20}$ (k) $6\frac{9}{50}$ (l) $25\frac{1}{4}$
 (m) $25\frac{3}{10}$ (n) $18\frac{3}{4}$ (o) $\frac{7}{8}$ (p) $\frac{1}{3}$
 (q) $\frac{5}{9}$ (r) $\frac{4}{9}$ (s) $\frac{1}{8}$

Answers to application 5.10

- (1) $232\frac{1}{4}$ (2) 0.58 (3) $9\frac{3}{5}$ (4) $\frac{1}{4}$
 (5) $72\frac{3}{100}$ (6) 12.2 (7) $140\frac{1}{7}$ (8) $3\frac{1}{7}$

Answers to Application 5.11

- (1) 77.4% (2) 0.58 (3) 60 (4) $\frac{1}{4}$ kg
 (5) $72\frac{3}{100}$ km (6) 12.2 m (7) $45\frac{1}{5}$ kg (8) 3.142857

End of unit 5 Assessment

- | | | |
|----------------------|-----------------------|---------------------|
| 1) (a) 12.46 | (b) 877.00 | (c) 324.67 |
| 2) (a) 123.9 | (b) 457.6 | (c) 65.5 |
| 3) (a) 23.457 | (b) 0.577 | (c) 567.683 |
| 4) 2.7 | 5) 0.875 | |
| 6) (a) 9.6 sec | (b) $9\frac{69}{100}$ | 7) 3.53 |
| 8) $8\frac{1}{3}$ km | 9) 0.4545... | 10) $\frac{65}{99}$ |
| 11) 4.2727... | 12) $\frac{3}{5}$ | |

Unit 6

Ratios, Proportions, Percentages and Mixtures

Key unit competence: To be able to work out ratios, proportions, percentages and mixtures.

List of lessons

Lessons	Number of lessons	Number of periods
6.1 Converting percentages to decimals	1	1
6.2 Converting decimals to percentages	1	1
6.3 Converting percentages to fractions	1	1
6.4 Converting fractions into percentages	1	1
6.5 Comparing quantities as percentages	1	2
6.6 Comparing percentages as quantities	1	2
6.7 Increasing a number by percentage	1	1
6.8 Decreasing a number by percentage	1	2
6.9 More about increasing and decreasing by percentage	1	2
6.10 Finding percentage increase and decrease	1	2
6.11 Percentage profit and percentage loss	1	1
6.12 Solving problems involving percentages	1	1
6.13 Finding ratios	1	1
6.14 Sharing quantities in ratios	1	2
6.15 Increasing and decreasing quantities as ratios	1	2
6.16 Finding the ratio of increase and decrease	1	2
6.17 Solving problems involving ratios	1	1
6.18 Finding indirect proportions	1	1
6.19 Average price of the mixture	1	1
6.20 The quantity of one type of the mixture	1	1
6.21 The price of one type of the mixture	1	2
6.22 Finding both quantities or prices of the mixture	1	2
6.23 Solving problems involving ratios, percentages, mixtures and indirect proportions.	1	2
Assessment	1	1
Total	24	35

Guidance on problem statement

With in this unit, Learners need to know how ratios are helpful in numbers' distribution. They need to know how they may apply proportions and mixtures. Take them through the Introduction in the Learner's Book, page 83.

Cross-cutting issues

Throughout the teaching process of this unit, it will be crucial to help learners to master the content. And it is better to address cross-cutting issues where possible. In this unit we will address the following Cross-cutting issues as non-stand alone within classroom activities and through the development of the content.

- **Peace and value education:** First of all as a teacher, you have to be a peace maker in your class and role model so that learners will imitate how you behave. When there is any conflict do not leave without helping to solve it. Within the lesson encourage learners to behave well, being humble, honest, etc.
- **Gender education:** This cross-cutting issues will be addressed through giving equal opportunities to both boys and girls during the lesson. This may be addressed through forming groups and assigning tasks.
- **Financial education:** This should be addressed via problems that imply the way of using money that encourage learner to deal with money financially. In this unit, there are problems involving daily life situation concerning money. Make sure that you talk about them in order to help them have an open mind financially.

Learning Objectives

Knowledge and understanding

- Explain the meaning and the role of percentages.
- Identify the relationship between ratios and proportions.
- Explain the concept of mixtures.
- Describe different ways of working out mixtures.

Skills

- Apply percentages, ratios, proportions and mixtures in solving mathematical problems.
- Convert percentages to decimals and vice versa.

Attitudes and values

- Acknowledge the importance of percentages ratios, mixtures and proportions in daily life situations.
- Respect one another when working in groups and welcome other's ideas.

Number of lessons: 35**Guidance for classroom organisation**

- Before you start your lesson, first use warm-ups or energizers in order to engage learners into the lesson. Do not focus on this only, try to be creative. The essence is to motivate the learners and make them active throughout the teaching- learning process.
- Help learners to form groups before you assign them an activity.
- While they are doing the activity, walk around while monitoring their work and helping where they have difficulties.

Learning and teaching materials for the unit

Manila cards, scissors, markers and masking tape and other materials that the teacher may see as important to achieve his/her objective.

Lesson 6.1**Converting Percentages into Decimals (80 minutes)****Learner's Book, pages 83****Introduction**

- Give mental work on converting simple fractions to decimals. For example, change the following to decimals, $\frac{1}{2}$, $\frac{2}{5}$, $\frac{7}{10}$ and so on.
- Let learners get into groups and carry out the activity in the Learner's Book, page 83.

Development

- Share the main competence as converting percentages into decimals.
- Help learners to realise the shifting of the decimal point in relation to number of zeros in the denominator.

$$(1) \quad 17\% = \frac{17}{100} = \frac{.17}{100} = 0.17$$

- Help learners to note that the number of zeros in the denominator correspond to the number of decimal digits.

$$(2) \quad 38\% = \frac{38}{100} = \frac{.38}{100} = 0.38 \quad (3) \quad 9\% = \frac{9}{100} = \frac{.09}{100} = 0.09$$

$$(4) \quad 30\% = \frac{30}{100} \text{ first cancel out the zero in ones place value, meaning divide by 10.}$$

$$= \frac{3}{10} = \frac{3}{10} = 0.3$$

- Encourage and allow learners to match as many question as they can.
- Assign a number of questions for group discussion: 23%, 67%, 82%, 91%, 156%, 4%, 2%, etc.
- Guide learners through the examples in the Learner's Book, pages 83 and 84.

Conclusion

- Take them through the Study tip.
- Let the learners raise their comments about it.
- Ask learners to attempt Application 6.1 in the Learner's Book.
- Mark their work and help them do corrections.
- Let them take the notes.
- Ensure that before this idea is introduced, you practise converting fractions to decimals.

Remedial Exercise

1. You may have lots of 2 digit percentages for the slow learners to change to decimals; 15%, 19%, 21%, 32%, 43%, 76%, 84%.

Additional Exercise

2. Fast learners can attempt single digit percentages: 2%, 3%, 6%, 7%, m%, r%, x%. They may also have 3 or more digit percentages: 113%, 159%, 417%, 2345%, abc%, rstv%.

Lesson 6.2

Converting decimals into percentages (40 minutes)

Learner's Book, pages 85

Introduction

- Review converting percentages into decimals.
- Ask learners to form groups.
- Guide them as they discuss the activity given in the Learner's Book, page 85.
- Assess each group's report as you discuss with the learners to come up with one report.
- Help learners to harmonise their work.

Development

- Share the lesson competences using examples.

Example 1: Express 0.34 as a decimal.

- Method 1: Help learners to realise that the number of decimal digits represent the number of zeros on the denominator.

$$0.34 = \begin{array}{c} 0.34 \\ \downarrow \downarrow \\ 100 \end{array} = \frac{34}{100} = 34\% \quad \text{Method 2: } 0.34 = \frac{34}{100} \times 100\% = 34\%.$$

$$\text{Example 2: } 0.06 = \begin{array}{c} 0.06 \\ \downarrow \downarrow \\ 100 \end{array} = \frac{6}{100} = 6\% \quad \text{OR } \frac{6}{100} \times 100\% = 6\%$$

- Give some questions about decimal numbers to be expressed as percentage for learners to discuss in groups.

0.17, 0.532, 7.44, 13.9

- Refer to the Learner's Book and guide learners through the examples.

Conclusion

- Guide them through the Study tip and let them to give you their point of view.
- Ask them to attempt Application 6.2 in the Learner's Book, page 86.
- Mark their work and help them do corrections.
- Let them to take the notes
- Guide the learners well to relate number of decimal digits to number of zeros.
- Ensure to apply a number of methods that you discover.

Remedial Exercise

1. Guide slow learners as they use method 1 of matching zeros for the following; 0.19, 0.66, 0.39, 0.88, 0.04, 0.09 to change to percentages.

Additional Exercise

2. Prepare more work for fast learners including word problems. Example: About 0.05 of the chicken feeds is silver fish. Express that as a percentage.

Lesson 6.3**Converting Percentages into Fractions (40 minutes)****Learner's Book, pages 86****Introduction**

- Give mental work on reducing fractions.
- Guide learners as they carry out the activity in Learner's Book, page 86.
- Guide them through the examples you prepared on a chart

Development

Example

- (1) Change 30% to a fraction.

$$30\% = \frac{30}{100} = \frac{3}{10}$$

Note: Express percentage as a fraction out of 100 first.
then reduce the fraction.

- (2) $64\% = \frac{64}{100} = \frac{16}{25}$

- (3) $17\frac{1}{2}\%$ change to improper fraction first

$$= \frac{(17 \times 2) + 1}{2} = \frac{35}{2} \text{ then express } \frac{35}{2}\% \text{ as a single fraction}$$

$$= \frac{35}{2} \times \frac{1}{100} = \frac{35}{200} = \frac{7}{40}$$

- Give work for group discussion; 18%, 32%, $22\frac{1}{2}\%$, $66\frac{2}{3}\%$, $1\frac{2}{3}\%$
- Ask learners to present their work and guide them where you site mistakes.
- Guide learners through the suggested examples in the Learner's Book, page 86.

Conclusion

- Guide them through the Study tip and later, ask them to attempt Application 6.3.
- Let learners take notes.
- You may mix the two kinds of percentages (i.e, whole number and mixed number percentages) if the class learns fast.
- Alternatively, you may split them into 2 lessons.
- Give more time to learners when handling the mixed number percentages, for example, $3\frac{1}{3}\%$ etc.
- Provide other more exercises for the next period that will enable learners to master the content.

Remedial Exercise

More work should be prepared to continue guiding the slow learners. 20%, 70%, 35%. Allow them more time when dealing with mixed fractions. $12\frac{1}{2}\%$, $8\frac{1}{3}\%$.

Additional Exercise

Prepare more challenging work for the fast learners for example; express the following as fractions.

(a) 125%, (b) 144%, (c) $4\frac{1}{6}\%$, (d) $8\frac{3}{4}\%$

(e) $12\frac{1}{2}\%$ of the people in town are traders. What fraction of the people in town are traders.

Lesson 6.4

Converting fractions to percentages (40 minutes)

Learner's Book, pages 87

Introduction

- Give mental work activity on;
 - multiplying fractions by whole numbers, converting mixed fraction to improper fractions
 - simplifying fractions
 - converting percentage into fractions.
- Ask learners to form groups and guide them as they carry out the activity in the Learner's Book, page 87.

Development

- Guide learners through examples that you prepared on a chart.

Example: Express the following as a percentage;

(1) $\frac{2}{5}$ Help learners to realise that you multiply a fraction by 100%
 $\frac{2}{5} \times 100\% = 40\%$

(2) $\frac{7}{10} = \frac{7}{10} \times 100\% = 70\%$

(3) $2\frac{1}{2} = \frac{(2 \times 2 + 1)}{2} = \frac{5}{2} = \frac{5}{2} \times 100 = 250\%$

- Emphasise that mixed numbers are first changed into improper fractions.
- Assign some group work to the learners for discussion.

For example, $\frac{4}{5}$, $\frac{32}{40}$, $1\frac{4}{5}$, $12\frac{1}{2}$

- Ask learners to present their answers.
- Guide learners through the examples in the Learner's Book, page 88.

Example 1

Multiply the fraction by 100%, then simplify.

$$\frac{3}{4} \times 100\% = 3 \times 25\% = 75\%$$

Example 2

Multiply the fraction by 100%, then simplify.

$$\frac{1}{8} \times 100\% = \frac{1 \times 100}{8} = \frac{1 \times 25}{2} = 12\frac{1}{2}\%$$

Conclusion

- Guide the learners through the Study tip.
- Ask them to attempt Application 6.4 in the Learner's Book, page 88.
- Mark their work and help them do corrections.
- Let them take notes.

Remedial Exercise

1. Help the slow learners to prepare their own exercises.

Additional Exercise

2. Help the fast learners to develop their competences by giving them suitable exercises.

Lesson 6.5

Comparing Quantities as Percentages (80 minutes)

Learner's Book, pages 88.

Introduction

- Review multiplying a fraction by a whole number.
- Put learners into manageable groups. Let each group discuss the contents of the activity as you guide them.

- Allow each group to present its report.

Development

- Guide learners through some examples.
 1. Mukashaka scored 17 marks out of 20. What was his percentage mark?
Form a fraction $\frac{17}{20}$
Convert the fraction into percentage.
 $\frac{17}{20} \times 100 = 85\%$.
 2. On a farm there are 29 cows, 15 goats and 6 sheep. Find the percentage of each kind of animal.
Get the total number of animals on the farm first.
Secondly form fraction of each kind of animal.
Change the respective fraction to percentage

Total	cows	goats	sheep
$29 + 15 + 6$	$\frac{29}{50} \times 100\%$	$\frac{15}{50} \times 100\%$	$\frac{6}{50} \times 100\%$
= 50	= 58%	= 30%	= 12%

- Emphasise that the fraction formed is of the total quantity.
- Give an example for group discussion.

Example In a school of 400 students, 200 are Africans, 128 are whites, the rest are Asians.
Find the percentage of: (a) Africans (b) Whites (c) Asians
- Ask groups to present their work to the class.
- Correct them where they go wrong.
- Guide them through the examples in the Learner's Book, page 89.

Conclusions

- Let the learners study the Study tip.
- Ask them to attempt Application 6.5 in the Learner's Book, page 90.
- Help them to organise the presentations and then they take the notes
- Emphasise that we make the fraction of the total quantity then multiply by 100. $\frac{\text{Required}}{\text{Total}} \times 100\%$
- Design more work if need be.

Remedial Exercise

Slow learners can work out simple word problems; e.g

1. In a family there are 5 members, 3 are females and 2 are males. Find the percentage of;
 - (a) males
 - (b) females
2. A girl did ten numbers. She got 7 correct ones.
 - (a) What percentage did she pass?
 - (b) What percentage did she fail?

Prepare more challenging work for the fast learners. For example;

1. Uwacu cut her apple into 8 equal parts. She gave out 2 parts.
 - (a) What fraction remained?
 - (b) What percentage did she give out?
 - (c) What percentage remained?
2. Ntare has 200 Tshirts in his boutique. 70 are white, 110 are green and the rest are black. Find the percentage of each colour.
3. A baby spent 8 hours of the day sleeping. What percentage of the day did it sleep?

Lesson 6.6**Comparing Percentages as Quantities (80 minutes)**

Learner's Book, pages 90

Introduction

- Review the previous lesson.
- Distribute learners in groups and let them do activity in the learner's Book, page 90.
- Guide them through the procedure.
- Collect report from all groups.
- Harmonise the reports to come up with a general report.

Development

- Explain the main competence of the lesson. That is, comparing percentages as quantities.
- In the activity, learners observed that percentages increased as quantities increased directly proportionally.

- When percentages increase to a total of 100%, the total of the quantities was realised.
- Write an example on the chalkboard for learners to practise.
Example: In a group, there are 40 men. This is 20% of all the group members. The rest are women. How many members are in the group?
- Lead learners to realise that, out of every 100 group members, 20 are men.

Method 1

Use grouping method.

20% is equivalent to 40 members.

40% is equivalent to 80 members.

60% is equivalent to 120 members.

80% is equivalent to 160 members.

100% is equivalent to 200 members.

Therefore, there are 200 members.

Method 2

First find the equivalent of 1%.

20% is equivalent to 40.

1% is equivalent to $\frac{40}{20}$.

Multiply by 100 to get the total.

$$\begin{aligned} 100\% \text{ is equivalent to } & \frac{40^2}{20^1} \times 100. \\ & = 2 \times 100 \\ & = 200 \end{aligned}$$

- Let learners follow through again so that they get familiar with the concept.
- Refer to the examples in the Learner's Book, page 91.
- Guide learners through, emphasis put in method 2 because it involves algebra.
- Ask learners to formulate their own problems, work them out as you monitor them.

Conclusion

- Let learners read the Study tip.
- Use it to summarise the lesson.
- Let them attempt Application 6.6, page 91.
- Collect and mark their work and give feedback.
- Help them corrections.
- Let learners take notes.

Remedial Exercise

Slow learners should attempt out the following for more practice:

Use grouping method.

1. 10% is equivalent to 10 cows. How many cows are there?
2. 50% is equivalent to 20 kg. How many kilograms are there?
3. 20% is equivalent to 15 pencils. How many pencils are in the box?
4. 25% is equivalent to 20 books. How many books are there?

Additional Exercise

Fast learners should use method 2 to work out the following:

1. 2% of the farmers in a village grow rice. 300 farmers grow rice. How many farmers are in the village.
2. 6% of animals on a farm are sheep. If there are 24 sheep, what is the total of all animal?
3. 15% of learners in a school are in Primary 6. there are 45 learners in Primary 6. Find the total enrollment in the school.
4. $12\frac{1}{2}\%$ of Munyaneza's salary is spent on food monthly. If he spends 40,000 Frw on food, what is his salary?

Lesson 6.7**Increasing a number by a percentage (40 minutes)**

Learner's Book, pages 92

Introduction

- Begin with mental work activity on multiplying fractions by a whole number. For example, $\frac{2}{5} \times 15$ and reducing a fraction for example reduce $\frac{20}{35}$ to the lowest terms.
- Ask learners to form groups.

Development

- Guide them as they discuss the contents of the activity.
Dusabe had 100 Frw.
Her father increased it by 20%.
If it is reduced by 10%, how much will it be?
(a) How much money does she have now?
(b) How do you get the answer?
(c) Explain and present your answer to the class.
- Let each group present its finding and later come up with a general report.
- Write an example on the chalkboard.

Example (1) Increase 70 by 30%.

Guide learners into finding out the meaning of increase.

Guide learners through the following examples involving increasing by a percentages.

Method 1

Steps, \Rightarrow The original 70 is represented by 100%
 \Rightarrow Increase 100% by 30% = 100% + 30% = 130% of old amount
 \Rightarrow Multiply the new percentage by 70 = $\frac{130}{100} \times 70 = 91$

Method 2

Add: 70 plus (30% of 70)
 $= 70 + (\frac{30}{100} \times 70)$
 $= 70 + 21$
 $= 91$

Example (2): Dukuze was getting wages of 4,000 Frw per day. Her wages were increased by 25%. Find her new wages.

Method 1

Original 100% = 4,000 Frw
 Increase by 25% = 100% + 25%
 $= 125\%$
 New wages = $\frac{125}{100} \times 4000$ Frw
 $= 5,000$ Frw

Method 2

Add 4,000 Frw + (25% of 4,000 Frw)
 $= 4,000$ Frw + ($\frac{25}{100} \times 4,000$)
 $= 4,000$ Frw + 1,000 Frw
 $= 5,000$ Frw

- Prepare some numbers for learners to discuss in groups.
 1. Increase 50 by 40%
 2. Bihizi scored 80% in term one. In term two his mark increased by 10%. Find his term two mark.
- Let them study the examples in the Learner's Book, page 92 and 93.

Conclusion

- Guide them through the Study tip and use it to emphasise the procedure.
- Ask them to attempt Application 6.7 in the Learner's Book, page 93.
- You may choose to teach the lesson using one method (ie method 1) then use method 2. In the next lesson.
- Do not rush especially when using mixed number percentages to allow learner's to pick the idea.

Remedial Exercise

Prepare a few simple numbers for slow learners to practice, for example;

1. Increase 20 by 105%
2. Increase 10 by 20%.
3. Mutesi received 40 litres of milk in January. In February, the milk increased by 50%. How many litres did she get in February?

Additional Exercise

Prepare more challenging numbers for the fast learners.

1. Increase 58 by 5%
2. Decrease 120 by $7\frac{1}{2}\%$
3. A poultry farm had 420 birds. The birds increased by $16\frac{2}{3}\%$. What is the new number of birds?
4. The number of animals in a park increased from 144 by $12\frac{1}{2}\%$. Find the new number of animals.

Lesson 6.8**Decreasing a Number by a Percentage (40 minutes)**

Learner's Book, page 94

Introduction

- Give simple mental work about multiplying a fraction by 100.
For example: $\frac{1}{10} \times 100$, $\frac{1}{2} \times 100$, $\frac{5}{10} \times 100$, $\frac{50}{100} \times 100$, etc.
- Let learners form groups.
- Distribute the learning materials.
- Involve the learners in the activity in the Learner's Book.
- Write all the suggested answers on the chalkboard.
- Harmonise them and give a general report.

Development

- Learners should observe that, decrease means reducing, therefore, the operation used is for subtraction (-).
- The essence is, there is a reduction on each 100 of the old amount.
- Write an example and ask learners to try it using the method of grouping as was done in the activity.

For example: The price of sugar was decreased by 10%. If the old price was 700Frw per kg, what is the new price?

Method 1

Each 100 Frw, decrease is 10 Frw

200 Frw, decrease is 20 Frw

300 Frw, decrease is 30 Frw

400 Frw, decrease is 40 Frw

500 Frw, decrease is 50 Frw

600 Frw, decrease is 60 Frw

700 Frw, decrease is 70 Frw

New price = old price - decrease

= 700 Frw - 70 Frw

= 630 Frw

New price is 630 Frw

Method 2

Workout the difference in percentage.

(100% - 10%) of old price = New price

= 90% of 700 Frw

= $\frac{90}{100} \times 700$

= 90 x 7

= 630 Frw

The new price is 630 Frw.

- Take learners through the examples in the Learner's Book.
- Give them time to follow the procedure as you guide them.
- Give learners more examples so that they concretise the concept.

Conclusion

- Let learners study and read the Study tip.
- Take time explaining the meaning and applicability.
- Let learners attempt Application 6.8 in the Learner's Book, page 95.
- Mark their work and give feedback.
- Learner's take notes in their exercise books.

Remedial Exercise

Slow learners should attempt out the following for more practice:

(1) Decrease 58 by 10%.

(2) Decrease 50 by 20%

(3) Decrease 100 by 20%

(4) Decrease 400 by 50%

Additional Exercise

Fast learners should use method 2 to work out the following:

(1) Decrease 420 by $7\frac{1}{2}\%$

(2) Decrease 640 by $12\frac{1}{2}\%$.

(3) A diary factory produced 2,400 cartons of milk daily. During drought season, the cartons decreased by $33\frac{1}{3}\%$. Find the number of cartons produced later.

Lesson 6.9**More about Increasing and Decreasing Quantities by Percentage
(80 minutes)****Learner's Book, page 96****Introduction**

- Review the previous lesson.
- Form groups among the learners.
- Lead them through the activity in the Learner's Book, page 96.

Development

- Explain the main concept of the lesson as finding the original quantity which was increased or decreased to result into given new quantity.
- Guide learners through the activity.

$$\text{New amount} = \text{old amount} + \% \text{ increase}$$

$$\text{New amount} = 100\% + 40\%$$

$$140\% \text{ of old amount} = 2,800 \text{ Frw}$$

$$\text{Find 1\% of old amount} = \frac{2,800}{140} = 200 \text{ Frw}$$

The old amount is assumed to be 100%

$$100\% \text{ of old amount} = 200 \times 100$$

$$= 20,000 \text{ Frw}$$

Therefore, the amount was 20,000 Frw.

- Take learners slowly through all the steps without hurrying.
- The procedure and steps may seem not easy to grasp at first exposure. Improvise various methods to achieve the objective.
- Take learners through the procedure of the examples.
- Ensure the learners are completely conversant with every step.

Conclusion

- Learners read and discuss the Study tip.
- Let them give their opinions about it.
- Let them do Application 6.9 in the Learner's Book, page 97.
- Mark their work and give feedback.
- Guide them in working out corrections.
- Learners take notes in their exercise book.

Remedial Exercise

Slow learners should re-do the Application in order to internalise the concept.

Additional Exercise

Fast learners attempt the exercise below:

- (1) Decreased by $33\frac{1}{3}\%$, a number becomes 1,200. What is the number?
- (2) Increased by $12\frac{1}{2}\%$, a number becomes 7,200. What is the number?
- (3) Gasana harvested beans. She put them in a store. Next season, the produce increased by $37\frac{1}{2}\%$ after the harvest, She had 795 kg. What was the first harvest in kilograms?
- (4) Price of a pair of shoes was decreased by $6\frac{1}{2}\%$ in the Christmas promotion. The new price became 63,900 Frw. What was the price before?

Lesson 6.10**Finding Percentage Increase and Decrease (80 minutes)**

Learner's Book, page 97

Introduction

- Review increasing and decreasing a given number by a given percentage.
- Provide groups with the necessary learning materials.
- Guide learners through the activity on page 97.
- Let them present their findings to the class.

Development

- Learners should realise that they shaded 20 more squares so the fraction shaded is $\frac{20}{40}$.
- Then they express the fraction as a percentage, i.e, $\frac{20}{40} \times 100 = 50\%$.
- Learners observe that expressed as a percentage, the first 40 squares were increased by 20 which is half.
- Refer learners to the example on a prepared chart.

Example: The new fees structure in a school for P.6 is 25,000 Frw. Formerly they were paying 20,000 Frw. By what percentage was the fees increased?

Old fees = 20,000 Frw New fees = 25,000 Frw

The increase is the difference

$$25,000 - 20,000 = 5,000 \text{ Frw}$$

Percentage increases means, how much was increased on each 100 of the old amount.

$$\begin{aligned} \text{\%increase} &= \frac{\text{Increase}}{\text{Old amount}} \times 100\% \\ &= \frac{5,000}{20,000} \times 100\% \end{aligned}$$

$$= \frac{1}{2} \times 100\% = 25\%$$

Conclusively, 25 Frw is the amount that was increased on each 100 Frw of the old fees.

- Now refer to the examples about percentage decrease.

Example: A school had 500 learners last year. This year the number decreased to 450 learners. Calculate the percentage decrease.

Guide them to realise that in decrease, there is reduction in the previous amount. After thorough discussion, learners should find out that, with percentage decrease, we find how many items have been deducted from each 100 of the previous amount.

$$\begin{aligned} \text{So decrease} &= (500 - 450) \text{ learners} \\ &= 50 \text{ learners} \end{aligned}$$

$$\text{Percentage decrease} = \frac{50}{500} \times 100\% = 10\%$$

- The essence is, on every 100 learners of the previous year, 10 didn't report back this year.
- Guide the learners through the examples in the Learner's Book.
- Let them discuss the procedure, then give a general observation.

Conclusion

- Discuss the Study tip and generate a general conclusion.
- Then let them attempt Application 6.10 in the Learner's Book.
- Mark their work and make them do corrections.
- Let the learners take notes in their exercise books.

Remedial Exercise

Slow learners should attempt the exercise below:

1. The old number is 200. The new number is 250. What is the percentage increase?
2. The new number is 400. The old number is 300. What is the percentage increase?
3. The old amount is 1,000 Frw. The new amount is 800 Frw. Calculate the percentage decrease.
4. A paw-paw was costing 500 Frw. Now it costs 400 Frw. What is the percentage decrease?

Additional Exercise

Fast learners attempt the exercise below:

1. The population of a village was 40,000 people. Now it is 55,000. By what percentage has the population increased?

2. Thadeus bought a radio at 9,000 Frw. He later sold it at 8,000 Frw. Calculate the percentage decrease in the price.
3. The bus fare from a certain town to another was 11,000 Frw. Now it is 13,000 Frw. Calculate the percentage increase in the fare.
4. When 150 is increased by $x\%$, it becomes 120. What is the percentage decrease?

Lesson 6. 11

Finding Percentage profit and percentage loss (80 minutes)

Learner's Book, page 99

Introduction

- Review the work done in the previous lesson.
- Guide the learners through the activity in the Learner's Book, page 99.
- Get a collection of their procedure and answers.
- Then let groups present their findings.

Development

- Explain that profit is the more money we get after selling an item compared to its original cost.
- People are involved in business to make more money.
- However, due to some unavoidable circumstances, instead a trader or business person may sell for less money than the amount used to purchase the item. This is called loss.
- Refer to the examples in the Learner's Book.
- Exhaustively explain the difference between percentage increase and percentage profit. Then the difference between percentage decrease and percentage loss.
- Emphasize that:

Profit	=	Selling price - Buying/cost price
Loss	=	Buying/cost price - Selling price

Learners, then realise that:

$$\text{Percentage profit} = \frac{\text{Profit}}{\text{Buying/cost price}} \times 100\%$$

$$\text{Percentage loss} = \frac{\text{Loss}}{\text{Buying/cost price}} \times 100\%$$

- Give more examples for emphasis on the chalkboard.

Example: Kabera bought a cow at 100,000 Frw. He later sold it at 120,000 Frw. Calculate his percentage profit.

Guide learners to find the profit realised.

$$\begin{aligned}\text{Profit} &= \text{Selling price} - \text{Buying/cost price} \\ &= 120,000 \text{ Frw} - 100,000 \text{ Frw} \\ &= 20,000 \text{ Frw}\end{aligned}$$

$$\begin{aligned}\text{Percentage profit} &= \frac{\text{Profit}}{\text{Buying/cost price}} \times 100\% \\ &= \frac{20,000}{100,000} \times 100\% \\ &= 20\%\end{aligned}$$

- Let learners formulate their own problems.
- Then come up with a general observation.

Conclusion

- Take them through the Study tip in order to concretise the competence.
- Ask the learners to attempt Application 6.11 in the Learner's Book, page 100.
- Mark their work and help them with the corrections.
- Let learners take notes.

Remedial Exercise

1. Give slow learners work which is easier for practice.

Additional Exercise

2. To the fast learners, give high order thinking questions which suit concretising the competence.

Lesson 6.12

Solving Problems Involving Percentages (40 minutes)

Learner's Book, pages 100

Introduction

- Review percentage increase and decrease.
- Give them the prepared questions.
- Ask learners to form groups. Guide each group as they discuss and work out the questions in the activity.

A school admitted 200 learners in 2016. The number of learners admitted in 2017 increased by 20%. How many learners were admitted in 2017?

Present and explain your finding before class.

Development

- Allow learners to present their discussion and results.
- Relate the discussion for the activity with the subtopic.
- Guide learners through examples on a displayed chart.

Example: Ndahiro increased on the transport fare of his taxi. The original fare was 300 Frw. Now it is 330 Frw. Calculate the percentage increase.

$$\text{Percentage increase} = \frac{\text{Difference in fare}}{\text{original fare}} \times 100\%$$

$$\text{Percentage increase} = \left(\frac{330 - 300}{300} \right) \times 100\%$$

$$\text{Percentage increase} = \frac{30}{300} \times 100\%$$

$$\text{Percentage increase} = 10\%.$$

- Now talk about percentage decrease and give an example

Example: A factory produced 9,000 bars of soap. In the next phase it produced only 8,640. What was the percentage decrease in production?

$$\text{Percentage decrease} = \frac{\text{Difference in production}}{\text{Original production}} \times 100\%$$

$$\text{Percentage decrease} = \frac{(9,000 - 8,640)}{9,000} \times 100\%$$

$$= \frac{360}{9,000} \times 100\% = 4\% \text{ Percentage decrease} = 4\%$$

- Guide learners as they study the examples in the Learner's Book, pages 100 and 101.
- Give a number for them to try out in groups.

Conclusion

- Guide learners through the Study tip.
- Ask them to attempt Application 6.12 in the Learner's Book, pages 101 and 102.
- Help them in doing corrections.
- Let them come up with a summary.
- Let them take notes.

Remedial Exercise

Prepare a few simple numbers for the slow learners.

1. Martha weighed 20 kg in 2016. In 2017 her mass is 26 kg. Find her percentage increase in mass.
2. Calculate the percentage increase if 120 increases to 168.
3. What is the percentage decrease when 60°C drops to 36°C ?
4. Find the percentage decrease when a learner reduces marks from 50% to 49%

Additional Exercise

Create more challenging questions to occupy the fast learners.

1. In the first quarter of the year, a trader sold 360 bags of coffee. In the second quarter, he sold 390 bags. Find the percentage increase in the sales of coffee.
2. 2,790 was increased by a certain percentage to 4,650. What was the percentage increase?
3. Calculate the percentage fall in the price of sugar from 1,240 Frw to 1178 Frw.
4. The population of a place was 14,480. Because of floods, the number reduced to 10,860. Find the percentage decrease in the population.

Lesson 6.13**Finding ratios (40 minutes)**

Learner's Book, pages 102

Introduction

- In groups, let learners carry out the activity in the Learner's Book, page..... and later make a presentation.

Development

- Explain the subunit.
- Guide the learners through the examples on a displayed chart;

Example (1): A brother and a sister shared some books in the ratio 2 : 3. The brother got 8 books. How many books did the sister get?

Explain to the learners that, we write the parts in their respective positions.

Brother	:	Sister
2	:	3

Let them write the value where it belongs that is, under the ratio

B	:	S
2	:	3
8	:	?

Divide the value by the ratio part (Brother's part) i.e, $\frac{8}{2} = 4$ then multiply the ratio part with the value by the quotient.

$$\begin{array}{r} \text{B} \quad \text{G} \\ 2 \quad 3 \\ 8 \quad \underline{\hspace{2cm}} \text{ books} \\ \frac{8}{2} = 4 \quad = 3 \times 4 \end{array}$$

The sister got 12 books.

Example (2): The ratio of goats to cows on a farm is 7:4. There are 42 goats on this farm. Find the number of cows on the farm.

$$\begin{array}{r} \text{Goats} \quad \text{Cows} \\ 7 \quad : \quad 4 \\ 42 \quad \underline{\hspace{2cm}} \text{ cows} \\ \frac{42}{7} \quad 4 \times 6 \\ = 6 \quad = 24 \text{ cows} \end{array}$$

- Assign work for groups to discuss and present to the class. e.g,
 1. At a restaurant, milk is mixed with water to make tea. The ratio of milk to water is 3:2. If 10 litres of water is used, find the amount of milk.
 2. Kamikazi and Mukashaka contributed some money for a project. The ratio of the money was 8:5. If Mukashaka contributed 60,000 Frw.
 - (a) How much did Kamikazi contribute?
 - (b) What was their total contribution?
 - (c) How much more did Kamikazi contribute than Mukashaka?
- Guide learners through the examples in the Learner's Book.

Conclusion

- Guide them through the Study tip.
- Ask them to attempt Application 6.13 in the Learner's Book.
- Help them to organise then let the learner take notes
- Learners should be encouraged and allowed to investigate or research and come up with any other appropriate method.

Remedial Exercise

Prepare simple questions for the slow learners e.g,

1. Uwilingiye and Ishaka shared fruits in the ratio 2:5. Uwilingiye got 6 apples. How many apples did Ishaka get?
2. The ratio of hens to cocks on a poultry farm is 5:1. There are 80 cocks. Find the number of hens.

Additional Exercise

Fast learners can be given more challenging questions. e.g,

1. A and B shared some beans in the ratio 3:4. A got 18 kg. How many kg did B get?
2. P, Q and R shared some money in the ratio 2 : 3 : 5. P got 5,000 Frw. How much did Q get?

Lesson 6. 14**Sharing Quantities in Ratios (80 minutes)**

Learner's Book, pages 103

Introduction

- Review the previous lesson.
- Put learners in groups and let them carry out the activity in the Learner's Book, page 103.
- Then the learner's make a class presentation.
- Lead learners to observe the procedure as follows:

1 st learner	2 nd learner
3	5
3	5
3	5
+ 3	+ 5
<u>12</u>	<u>20</u>

- So, the 1st learner gets 12 bottle tops while the 2nd learner gets 20 bottle tops.
- They should note that; (12 + 20) gives 32 bottle tops.
- Give an example for the learners to apply the competence.

Example: Joan and James shared 2,000 Frw in the ratio of 3:2. How much did each get?

Explain that the method used in the activity can not be suitable for large numbers. So, there is a short appropriate method.

That is, we add the total shares first:

$$3 + 2 = 5 \text{ shares}$$

Joan got 3 shares and James got 2 shares of the 5 shares. Then each share is expressed as a fraction.

Joan got $\frac{3}{5}$ and James got $\frac{2}{5}$ of the total amount of money.

So to get the amount of money each got, we multiply by the amount

$$\begin{aligned} \text{Joan} &= \frac{3}{51} \times 2,000 \text{ Frw} \\ &= 3 \times 400 \\ &= 1,200 \text{ Frw} \end{aligned}$$

$$\begin{aligned} \text{James} &= \frac{2}{51} \times 2,000 \text{ Frw} \\ &= 2 \times 400 \\ &= 800 \text{ Frw} \end{aligned}$$

- Let learners follow through the working again to internalise the concept.
- Lead them through the examples in the Learner's Book.
- Let them study the two methods and ask questions where they have challenges.
- Ask learners to formulate their own problems, work them out and share with other groups their procedure and answers.
- Give other questions for group discussion.

Conclusion

- Let learners study the Study tip and use it to summarise the lesson.
- Ask them to attempt Application 6.14, page 104 and 105.
- Collect their work and mark it.
- Help them with the corrections.
- Let the learners take notes.

Remedial Exercise

1. Give slow learners work which is easier for practice. Then they should re-do the Application to master the competences.

Additional Exercise

2. To the fast learners, give high order thinking questions which are more complex than the Application. This will invoke their critical thinking.

Lesson 6.15

Increasing and Decreasing Quantities in Ratios (80 minutes)

Learner's Book, pages 105

Introduction

- Give mental work about increasing and decreasing numbers, for example, (a) increase 120 by 30 (b) decrease 100 by 20 (c) What is 17 plus 11?
- Review the previous lesson.
- Guide the learners through the activity in the Learner's Book.

Development

- Harmonise the presentation from different groups.
- Learners should have observed that each of the 5 groups had 6 counters. If another group is formed of 6 more counters, the new amount = 30 counters

+ 6 counters = 36 counters.

- Introduce the competence to be achieved.
- Display a prepared chart with worked examples.

Example 1: Increase 630 kg in the ratio of 7:3.

Explain that when an amount is increased, the new amount is bigger than the old amount. So in this case, explain that we express the new part as a fraction of the old ratio, then we multiply by the old part.

The first to appear is the new part and the last is the old part.

	Method 1		Method 2
New part	= 7	3 parts	= 630 kg
Old part	= 3	1 part	= $\frac{630}{3}$
New amount	= $\frac{\text{New part}}{\text{Old part}} \times 630$		= 210 kg
New amount	= $\frac{7}{3} \times 630$ kg	Then we multiply by the new part	
	= 7 x 210	7 parts	= 7 x 210 kg
	= 1,470 kg		= 1,470 kg

Alternatively, we can equate the old amount to the old part and work out the value of 1 part.

- Then give an example about decreasing quantities in ratio.

Example 1: Decrease 960 in the ratio of 3:5.

Tell learners that the procedure is the same as that of increasing, but a less quantity than the old quantity is realised. Lead then through the procedure:

	Method 1		Method 2
New part	= 3	5 parts	= 960
Old part	= 5	1 part	= $\frac{960}{5}$
New amount	= $\frac{\text{New part}}{\text{Old part}} \times 960$		= 192 kg
New amount	= $\frac{3}{5} \times 960$ kg	Then we multiply by the new part	
	= 3 x 192	3 parts	= 3 x 192 kg
	= 576 kg		= 576 kg

- Now refer to the examples in the Learner's Book.
- Let the learners follow through as you guide them.
- Help them where they get challenges.
- Let them formulate their own questions, work them out, and share their work with other groups. Harmonise the activities.
- Then come up with a general observation.

Conclusion

- Let the learners read the Study tip and use it to summarise the concept.
- Ask learners to attempt Application 6.15 in the Learner's Book, page 106.
- Mark their work, then help them with corrections.
- Let them take notes in their exercise books.

Remedial Exercise

Let slow learners try this work:

1. Increase 100 in the ratio of 2:1.
2. Decrease 200 in the ratio of 2:5.
3. Increase 500 in the ratio of 3:2.
4. Decrease 1,000 Frw in the ratio of 9:10.

Additional Exercise

Let fast learners try this work:

1. What do you get if you increase 42,096 in a ratio of 5:3?
2. A trader had capital of 6,743,800 Frw. The amount reduced in the ratio of 6:7. How much capital does she have now?
3. Having had a good harvesting season, Gasana's maize harvest increased from 5,093 kg on the ratio of 13:11. How many kilograms did he harvest?
4. Mukamusoni had 5,782,500 Frw on her account. She withdrew some money to pay school fees for her children. The amount decreased in the ratio of 7:9. How much money remained on her account?

Lesson 6.16

Finding the Ratio of Increase and Decrease (80 minutes)

Learner's Book, pages 107

Introduction

- Review increasing and decreasing quantities as ratios.
- Ask learners to form group and do the activity in the Learner's Book, page 107.
- Let them give a report of what they discovered.

Development

- Write a general report on the chalkboard.
- For example: The new amount is 600, the old amount is 400.

$$\text{The increase in ratio} = \frac{\text{New number}}{\text{Old number}} = \frac{600}{400} = \frac{3}{2} = 3:2$$

- Help learners to realise that, when finding the ratio of increase or decrease, the new amount is divided by the old amount, then reduced to the lowest terms.
- Thereafter, the fraction is expressed as a ratio.
- Refer to the examples in the Learner's Book, page 107.

- Ask the learners to read the questions and guide them as they follow through the working.
- Give another example on the chalkboard.
- Ask learners to copy it down on slips of paper.
- Let them attempt working it out in their groups as you monitor them.

Example: The amount of milk produced by Uwacu's cows reduced from 1,200 litres to 1,000 litres daily. In what ratio did the milk decrease?

New amount = 1,000 litres, old amount = 1,200 litres

Let learners apply the method they used in the activity. That is, dividing the new amount by the old amount.

$$\text{Ratio of decrease} = \frac{\text{New number}}{\text{Old number}} = \frac{1,000}{1,200}$$

Learners reduce to the simplest terms to get $\frac{5}{6}$.

Then learners apply the concept of changing fractions to ratios $\frac{5}{6} = 5:6$.

Therefore, the ratio of decrease in the milk production was 5:6.

- Lead the learners through the examples in the Learner's Book.
- Give chance to learners to formulate their own problems.
- Facilitate the discussion then the presentation by each group.

Conclusion

- Guide the learners through the Study tip and use it to summarise the lesson.
- Let the learners attempt Application 6.16 in the Learner's Book.
- Mark their work and help them with corrections.
- Let the learners take notes in their exercise books.

Remedial Exercise

Let slow learners try this work:

1. Muzamir had 40 sheep. After a year they increased to 60 sheep. Find the ratio of increase.
2. What is the ratio of decrease from 300 to 200?
3. What is the ratio of increase from 300 eggs to 1,000 eggs?
4. Find the ratio of decrease from 400 kg to 200 kg.

Additional Exercise

Let fast learners try this work:

1. 250 was increase in the ratio of 8:5. What was the increased number?
2. 1.750 Frw was decreased in the ratio 2:3. Calculate the new amount of money.
3. After increasing his egg production of 2,468 eggs in the ratio of 5:4, a poultry farmer boosted her egg production. How many eggs did she collect?
4. Gasana's salary of 56,000 Frw was reduced in the ratio of 6:7. What was his new salary?

Lesson 6.17 Solving Problems Involving Ratios (40 minutes)

Learner's Book, pages 108

Introduction

- Give a review of the work involving ratios previously experienced, then form groups among learners.
- Let the learners carry out the activity in the Learner's Book, page 108.
- Move around as you monitor how they go about it.
- Collect the outcomes from all the groups and come up with a general report.

Development

- Lead learners to realise that by grouping 40 bottles tops in twos and threes, they are applying the concept of sharing in ratios.

$$\text{So, twos} = 2 + 2 + 2 + 2 + 2 + 2 + 2 + 2 = 16$$

$$\text{threes} = 3 + 3 + 3 + 3 + 3 + 3 + 3 + 3 = 24$$

- Display the chart with the worked example.
- Learners can now apply the knowledge they have learned about ratios.
- Give more examples to give the learners more practice.
- Let them write the examples on slips of paper and work them out in their groups.
- Move around supervising the work.
- Then they make a presentation to the class.
- Explain that with word problems, reading, interpreting and understanding are the prerequisite for correct working out of word problems.
- Let the learners follow through the examples in the Learner's Book.
- Ensure the learners are conversant with the vocabulary used in word problems.

Conclusion

- Guide the learners through the Study tip.
- Be more elaborate about the essence of the Study tip.
- Let learners attempt Application 6.17 in the Learner's Book, page 109.
- Mark their work and help them with corrections.
- Let them take notes in their exercise books.

Remedial Exercise

1. Give slow learners a simple exercise with low-toned vocabulary which is easy to read and understand and content matter should also be simple.

Additional Exercise

2. Give fast learners an extra exercise dealing with high order thinking questions.

Lesson 6.18**Finding indirect proportions (40 minutes)****Learner's Book, page 109****Introduction**

- Ask learners to form groups. Guide them as they discuss the activity and come up with the answer.
- Distribute learning materials to learners.
- Allow each group to give a presentation and harmonise the answers.

Development

- Explain indirect proportion.
- In indirect proportion, when the quantity increases the other decreases and vice versa.
- Guide them through examples.

Example 1

6 girls sweep a classroom in 15 minutes. How long will 9 girls take to sweep the same class?

6 girls take 15 minutes

1 girl takes $(15 \times 6) = 90$ minutes (she takes more time)

9 girls take $\frac{90}{9}$ minutes (9 girls share the work done by one girl)
= 10 minutes.

Example 2

14 men can build a fish pond in 10 days. How many men are needed to build the same size of a pond in only 4 days?

10 days need 14 men

1 day needs $(10 \times 14) = 140$ men

4 days need $\frac{140}{4} = 35$ men

- Prepare some numbers for group discussion.
- Let the learners present the work discussed.
- Guide them to organise their discussion and they take notes.
- Let them study the examples given in the Learner's Book, page 110.

Example 1

8 days need 2 people to do the work
More people are needed, so multiply.

1 day needs (2×8) people

Then divide to share the work.

$$4 \text{ days needs } \frac{2 \times 8}{4} \text{ p}$$

$$= 4 \text{ people}$$

Example 2

10 days needs 8 builders to do the work
Multiply to increase the number of
builders to share the work.

1 day needs (10×8) builders

Then divide to share the work.

$$5 \text{ days needs } \frac{10 \times 8}{5} \text{ p} = 16 \text{ builders}$$

Conclusion

- Guide them through the Study tip.
- Ask them to attempt Application 6.18.

Remedial Exercise

1. Prepare more challenging numbers for the fast learners.
2. Prepare a few simple numbers for the slow learners. Thoroughly explain the meaning of the term indirect, giving several examples in the learners' daily experience to help them understand.

Lesson 6.19**Finding average price of the mixture (40 minutes)**

Learner's Book, pages 111

Introduction

- Review basic operations and average.
 - Provide group with the necessary material
 - In groups, let learners discuss the content in the activity.
Take 15 kg of millet with 20 kg of maize.
Ask how much 1 kg of beans and 1 kg of maize in the shop are.
Buy and mix them in a basket.
- (a) Measure. How many kg do you get?
 - (b) Calculate the money you should have spent on your mixture.
 - (c) What do you notice?
 - (d) Why do you think it is important to study mixtures?
 - (e) Present and defend your answer.

Development

- Guide learners as they find the equal shares. Give them chance to present their findings.
- Use the activity to relate the subunit.
- Guide learners through some examples.

Example: Ngabirano is a spice dealer. He mixed 8 kg of ginger powder at

200 Frw per kg and 2 kg of red pepper powder at 300 Frw per kg. Find the average price of the mixture.

Solution:

Product	Quantity	Unit cost	Amount
Ginger powder	8 kg	200 Frw per kg	1,600 Frw
Red pepper powder	2 kg	300 Frw per kg	600 Frw
TOTAL	10 kg		2,200 Frw

$$\text{Average price} = \frac{\text{Total Amount}}{\text{Total quantity}} = \frac{2200 \text{ FRW}}{10} = 220 \text{ Frw}$$

- Ensure that you explain the steps clearly to the learners.
- Allow them to ask questions and ensure that you answer them and where possible site examples.
- Give a question and let learners discuss it in groups.
- Allow the groups to present the work.

Question for discussion: A mandazi maker mixes the following items:

6 kg of baking flour at 1200 Frw per kg

1 kg of baking powder at 200 Frw per kg

2 kg of sugar at 800 Frw per kg.

Find the average price of the mixture that was used to make mandazi.

- Allow learners to study the example in the Learner's Book, page 111.

Conclusion

- Guide learners through the Study tip.
- Let learners attempt Application 6.19 in the Learner's Book, page 112.
- Before teaching this subunit, ensure that you revise finding average or teach the subunit before.

Remedial Exercise

1. Guide slow learners with simple numbers and ask them to attempt this number. A trader mixed millet and cassava flour. He mixed 12 kg of cassava flour at 500 Frw per kg and 4 kg of millet at 700 Frw per kg. Calculate the average price of the mixture.

Additional Exercise

2. Prepare more questions to help learners to revise as a way of practicing. A farmer grinds a mixture of maize bran and silver fish for his poultry. He mixes 13 kg of maize bran and 7 kg of silver fish. Maize bran cost 320 Frw per kg and silver fish cost 800 Frw per kg. Find the average price of making the mixture.

Lesson 6.20 Finding the quantity of one type of the mixture (40 minutes)

Learner's Book, pages 112

Introduction

- Review finding the price of one type of the mixture.
- Let the learner suggest a number to be reviewed. Help in correction of the problem formation
- In groups let learners discuss the activity in the Learner's Book, page 112.

Development

- Introduce the lesson competence to be practiced.
- Give an example to the learners and guide them through its procedure.
Munyaneza mixed 200 kg of maize seed which costs 400 Frw per kg with silver fish which costs 850 Frw per kg. He was making chick mash. He sold the mixture at 700 Frw per kg. How many kg of silver fish did he mix?
- Lead learners to realise that it is the mass of silver fish that is requested to be found.
- Explain that, gain or profit on one type in the mixture, divided by the loss of the other type in the mixture, multiplied by the amount/mass of the mixture gives the amount of the type whose weight is not given.

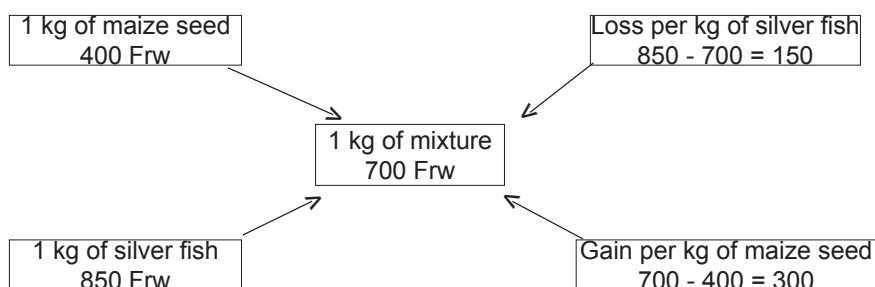

- Lead the learners to realise that;
- by selling 1 kg of maize seed at 400 Frw, and then selling 1 kg of the mixture at 700 Frw, a gain of $(700 \text{ Frw} - 400 \text{ Frw}) = 300 \text{ Frw}$ is realised.
- And, by selling 1 kg of silver fish at 850, and then selling 1 kg of the mixture at 700 Frw, a loss of $(850 \text{ Frw} - 700 \text{ Frw}) = 150 \text{ Frw}$ is realised.

So, $\frac{\text{loss on silver fish}}{\text{gain on maize seed}} \times \text{mass of mixture} = \text{mass of the other type}$

$$\frac{150}{300} \times 200 = 100 \text{ kg of silver fish}$$

- The concept may seem to be complex. But, devise means of explaining it

to the satisfaction of the learners.

- Let the learners study and try to work out the examples below:
Ngarambe mixed 100 kg of soya beans which cost 200 Frw per kg with another type which cost 120 Frw per kg and sold the mixture at 170 Frw per kg. Find the number of kg for the second type.
- Show your working out then discuss your answer..
- Have a guided discussion with the learners such that they achieve the competence. Give some other examples.
- Let them study the example in the Learner's Book, page 112 and 113.
- Challenge the learners to formulate their own, discuss, then share the outcomes.

Conclusion

- Discuss the Study tip before attempting Application 6.20.
- In case the learners fail to grasp the concept in one lesson, it may be re-taught so that the learners have more exposure in order to internalise it effectively.

Remedial Exercise

1. Guide slow learners with simple exercises and ask them to attempt them.

Additional Exercise

2. Prepare more questions to help the fast learners.

Lesson 6.21

Finding the price of one type of the mixture (80 minutes)

Learner's Book, pages 114

Introduction

- Review finding the average price of a mixture.
- You should have a number prepared to use in the review.
- Ask the learners to form groups.

Development

- Guide each group as they discuss to form their lists.
- Give each group a chance to present.
- Inform the learners that they are going to learn how to find the price of only one item in the mixture.
- Guide learners through the example;
Mutesi sold 180 kg of red beans and white beans at 800 Frw per kg. 80 kg were for red beans at 300 Frw per kg. Calculate the price of one kg of white beans.

Steps: First find the total amount on the mixture. ie $180 \times 800 = 144,000$ Frw.

Then find the total amount of red beans 80×300 Frw = 24,000

$$\text{Price of white beans} = \frac{\text{Amount of mixture} - \text{amount of red}}{\text{Quantity of mixture} - \text{quantity of red}}$$

Whole procedure

$$\text{Mixture: } 180 \times 800 \text{ Frw} = 144,000 \text{ Frw}$$

$$\text{Red beans: } 80 \times 300 \text{ Frw} = - 24,000 \text{ Frw}$$

$$\text{White beans: } 100 \quad \underline{120,000 \text{ Frw}}$$

$$\text{Price of 1 kg of white beans} = \frac{120,000}{100} = 1,200 \text{ Frw}$$

- Please do not rush as you explain to the learners.
- Allow them to ask questions freely as you guide them.
- Let them study the examples in the Learner's Book.

Conclusion

- Guide them through the Study tip.
- Let them attempt the Application 6.21.
- Mark their work and help them do corrections.
- Do not rush as you guide learners through the procedure of the corrections.
- Have samples of items to demonstrate a mixture.

Remedial Exercise

Prepare a number for the slow learners.

1. A woman sold 50 red and green apples at 5000 Frw. He sold 30 red apples at 120 Frw each. Find the price of each green apple.
2. A farmer sold 70 hens and cocks at 360,000 Frw. He had 20 cocks which he sold at 8,000 Frw each. Find the price of each hen.
3. A business man bought 120 shirts and T-shirts all at 500,000 Frw. He bought 70 shirts each at 5000 Frw. What was the price of each T-shirt.

Additional Exercise

For fast learner, prepare high order thinking numbers.

Lesson 6.22 Finding both quantities or prices of the mixture (80 minutes)

Learner's Book, pages 115

Introduction

- Give mental work about finding loss and profit.
- Then, using the unitary system, learners find the cost of the given quantities of items.
- In groups let learners discuss the activity in the Learner's Book, page 115.

Development

- Introduce to the learners the lesson competence.
- Guide the learners through an example.

Uwera mixed ground nuts with soya bean and formed 160 kg that she sold at 900 Frw each kg. She bought ground nuts at 1,200 Frw per kg and soya bean at 400 Frw per kg. Find the kilograms of each type she bought.

- Form a mind map plan.

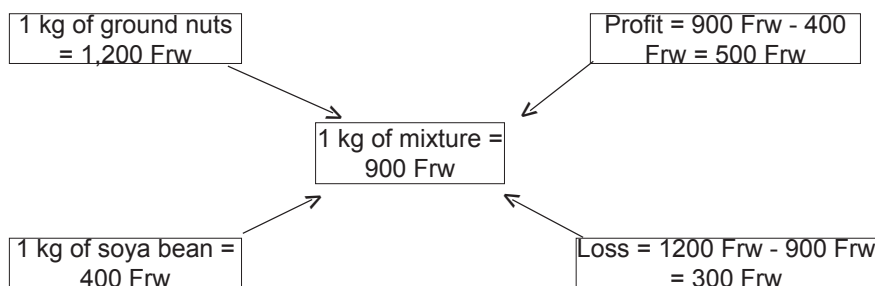

- Lead the learners to note that;

The ratio of the mixture is 500:300, so the total is $500 + 300 = 800$

For every 300 kg bought at 400 Frw, add 500 kg bought at 1,200 Frw.

Ground nuts bought at 1,200 Frw = $\frac{500}{800} \times 160 \text{ kg} = 100 \text{ kg}$

Soya beans bought at 400 Frw = $\frac{300}{800} \times 160 \text{ kg} = 60 \text{ kg}$
- Conclusively explain that, to find the quantities of the two types in a mixture, find the loss and profit and express them as ratio.

Then express each type as a fraction.

Multiply each fraction by the total mass of the mixture.

The results are the amounts of each type in the mixture.

- Display the chart with the prepared example.
- Let the learners in their groups discuss the procedure as you guide them.
- Lead the learners through the example in the Learner's Book, page 115
- Ensure that the learners ably explain the procedure satisfactorily.
- Give some more examples.

Conclusion

- Guide the learners as they discuss them. Then they make class presentation.
- Let them study the Study tip and concretise the procedure.
- Learners attempt Application 6.22.
- Be more specific about how losses and profits are obtained. Some learners may be confused as to which is which and what circumstances lead to loss or profit.
- Handle the lesson with precision so that learners do not get confused.
- Give more work to all the learners to do more practice for perfection.

Lesson 6.23

Solving Problems Involving Ratios, Percentages, Mixtures and Inverse Proportions (80 minutes)

Learner's Book, pages 116

Introduction

- Review the previous lessons.
- In groups lead the learners through the activity in the Learner's Book, page 116.

Development

- Introduce to the learners the lesson competence.
- Guide the learners through an example. Ensure that they get the idea very well.
- Display the chart with the prepared example.
- Let the learners in their groups discuss the procedure as you guide them.
- Lead the learners through the example in the Learner's Book.
- Ensure that the learners ably explain the procedure satisfactorily.
- Give some more examples.

Conclusion

- Guide the learners as they discuss them. Then they make class presentation.
- Let them attempt Application 6.23.

Remedial Exercise

1. Give more questions to the fast learners.
2. Guide slow learners with simple exercises.

Revision Activities

1. If you increase 12% on 20,000 Frw, what is the new amount?
2. How many learners can clean the classroom in 10 minutes working at the same rate if 5 learners can clean it in 15 minutes?
3. In community work, 20 boys and 25 girls attended. What is the ratio of boys to girls?

Extension activities

1. Munezero got 25 out of 30 and 45 out of 50 in Maths quiz. Convert her total mark in percentage.
2. After three year of working very well with the salary of 43,000 Frw, Mugeni got a new salary of 47,300 Frw. What percentage was added to her salary?
3. How many more people are needed to plant trees on the land of 2 hectares working at the same rate in 5 days, if 15 people can plant the land of one hectare in 10 days?,

Answers to Application 6.1

- | | | | |
|-----------|--------------|------------|------------|
| (a) 0.48 | (b) 0.97 | (c) 0.01 | (d) 0.13 |
| (e) 0.22 | (f) 0.157 | (g) 0.012 | (h) 1.25 |
| (i) 1.42 | (j) 0.33 | (k) 0.455 | (l) 0.2075 |
| (m) 0.622 | (n) 0.566... | (o) 0.8702 | |

Answers to Application 6.2

- | | | | |
|-----------------------|------------------------|-----------------------|------------------------|
| (a) 86% | (b) 20% | (c) 12% | (d) 5% |
| (e) 56% | (f) 12.5% | (g) 7.5% | (h) 146% |
| (i) 120% | (j) 19.5% | (k) $33\frac{1}{3}\%$ | (l) $54\frac{6}{11}\%$ |
| (m) $55\frac{5}{9}\%$ | (n) $63\frac{7}{11}\%$ | (o) $44\frac{4}{9}\%$ | |

Answers to Application 6.3

- | | | | |
|--------------------|----------------------|-------------------|--------------------|
| (a) $\frac{2}{5}$ | (b) $\frac{1}{2}$ | (c) $\frac{1}{8}$ | (d) $\frac{3}{4}$ |
| (e) $\frac{1}{50}$ | (f) $\frac{11}{100}$ | (g) $\frac{2}{3}$ | (h) $\frac{2}{25}$ |

(i) $\frac{17}{25}$

(j) $\frac{22}{25}$

(k) $\frac{9}{10}$

(l) $\frac{9}{20}$

(m) $\frac{6}{11}$

(n) $\frac{51}{100}$

(o) $\frac{1}{10}$

(r) $\frac{81}{100}$

(s) $\frac{43}{50}$

(t) $\frac{49}{500}$

Answers to Application 6.4

(a) 40%

(b) 314.3%

(c) 122.2%

(d) 550%

(e) 11.1%

(f) 87.5%

(g) 30%

(h) 37.5%

(i) 83.3%

(j) 40%

(k) 33.3%

(l) 66.6%

(m) 60%

(n) 54.5%

(o) 44.4%

Answers to Application 6.5

1. (a) 75%

(b) 50%

2. (a) 50%

(b) 33.3%

3. 20%

4. 25%

5. 12 %

Answers to Application 6.6

(1) 300

(2) 600

(3) 12,800

(4) 2,000 fish

(5) 500 cars

(6) 600 kg

Answers to Application 6.7

(1) 65 mangoes

(2) 840 people

(3) 1,080

(4) 46,000

(5) $5\frac{1}{2}$

(6) 16,934.4

(7) 33,880

Answers to Application 6.8

(1) 740

(2) 672

(3) 1,140

(4) 336 kg

(5) 3,760,000

(6) 358.000

(7) 63.630 kg

(8) 800,800

(5) 720

(6) 80 learners

Answers to Application 6.9

(1) 500

(2) 40,000

(3) 800 kg

(4) 2,000

(5) 50,000

(6) 1,200

(7) 80,000

Answers to Application 6.10

(1) 33.3% or $33\frac{1}{3}$

(2) 20%

(3) 33.3%

(4) 4.7%

(5) 20%

(6) 15%

Answers to Application 6.11

(1) 20%

(2) 16.6%

(3) 20%

(4) 20%

(5) 10%

(6) 20%

Answers to Application 6.12

- (1) $16\frac{1}{2}$ litres (2) 360 people (3) 12% (4) 40%
 (5) 25% (6) 50% (7) 8% (8) 14.2%

Answers to Application 6.13

- (1) 2:3 (2) 1:10 (3) 50:1 (4) 10:3
 (7) 2:1 (8) 3:2 (33 cups of wheat and 22 cups of milk)

Answers to Application 6.14

- (1) 1st share = 200, 2nd share = 300
 (2) 1st share = 70 kg, 2nd share = 350
 (3) Kaibanda's got 4,500 Frw, Mukamusoni got 7,500 Frw.
 (4) One farmer got 75 kg, the other farmer got 50 kg.
 (5) a) 560,000 b) 80,000 c) 1,200,000
 (6) a) 400 boys b) 850 learners

Answers to Application 6.15

- (1) 350 kg (2) 210 (3) 900 (4) 980
 (5) 27,000 (6) 600 books (7) 1,400 litres
 (8) 2,500 (9) 20,400

Answers to Application 6.16

- (1) 6:5 (2) 5:8 (3) 7:6 (4) 4:5
 (5) 93,000 (6) 9:10 (7) 6:5 (8) 9:10

Answers to Application 6.17

- (1) 250 Frw (2) 70 Rams (3) 350,000 (4) 9:7
 (5) 93,000 (6) 3:2 (7) a) 160 b) 200
 8 a) 270 boys b) 600 learners

Answers to Application 6.18

- (1) $\frac{1}{2}$ of a day (2) 2 days (3) 32 sqm (4) 4 men
 (5) 9 min

Answers to Application 6.19

- (1) 560 Frw (2) 960 Frw (3) 77 Frw
 (4) a) 150 Frw b) 20 kg

Answers to Application 6.20

- (1) 5 kg (2) 15 kg (3) 15 kg
 (4) 6 kg (5) 5 kg

Answers to Application 6.21

- (1) 50 Frw (2) 740 Frw (3) 653 Frw
 (4) 2,000 Frw (5) 293 Frw

Answers to Application 6.22

- (1) First type = 24 kg Second type = 36 kg
(2) First type = 72 kg Second type = 45 kg
(3) First type = 30 kg Second type = 20 kg
(4) First type = 12 kg Second type = 8 kg
(5) First type = 6 kg Second type = 54 kg

Answers to Application 6.23

- (1) 69 learners (2) 40 kg
(3) Novels = 80 textbooks, SST = 240 textbooks, Maths = 320 textbooks
English = 160 textbooks,
(4) 12 days (5) 4:3 (6) 8:3 (7) 300,000 Frw
(8) $66\frac{2}{3}\%$ (9) $\frac{1}{8}$ (10) 180 and 420

End of unit 6 Assessment

- (1) 4,000 m² (2) A : A + B + C (3) 14 days (4) 780 Frw
(5) 24 days (6) 69 learners (7) $7\frac{1}{2}$ questions (8) 4 people
(9) 83 days (10) 1,728 kg

Unit 7

Relationship between volume, capacity and mass

Key unit competence: To be able to apply fractions in daily life situations and solve related problems.

List of lessons

Lessons	Number of lessons	Number of periods
7.1 Revision on mass measurement	1	1
7.2 Revision on capacity measurement	1	1
7.3 Measurement of volume	1	1
7.4 Finding the relationship between unit of volume, capacity and mass.	1	1
7.5 Converting between units of volume, capacity and mass.	1	1
7.6 Assessment	1	2
Total		7

Guidance on problem statement

With in this unit, learners will learn about the relationship which is between volume, capacity and mass. This is helpful in everyday life situation where they may consider to measure a certain amount of liquid while the instrument of the required unit is not available. They can prefer to use available measurement related. Take learners through introduction in the Learner's Book, page 119.

Cross-cutting issues

Throughout the teaching process of this unit, it will be crucial to help learners to master the content and it is better to address cross-cutting issues where possible. In this unit we will address the following cross-cutting issues non-stand alone within classroom activities and through the development of the content.

- **Peace and value education:** First of all, as a teacher, you have to be a peace maker in your class and role model so that learners will imitate how you behave. When there is any conflict do not leave without helping to solve it within the lesson. Encourage learners to behave well, being humble, honest, etc.

- **Gender education:** This Cross-cutting issue will be addressed through giving equal opportunities to both boys and girls during the lesson.
- **Financial Education:** This should be addressed via problems that imply the way of using money that encourage, learners in investing and saving.

Learning Objectives

Knowledge and understanding

- State units of length, capacity and mass in solving problems.
- Explain the relationship between volume, capacity and mass in the case of water.

Skills

- Show the relationship between volume, capacity and mass using a table.
- Convert between units of volume, capacity and mass.
- Solve problems involving the relationship between volume, capacity and mass measurements.

Attitudes and values

- Show respect to one another when working in groups.
- Show the spirit of tolerance when you are with your friends in a group.

Number of lessons: 7

Guidance for classroom organisation

- Before you start the lesson, first use warm-ups or energizers in order to engage your learners into the lesson. Do not focus on this only, try to be creative. The essence is to motivate the learners and make them active throughout the teaching- learning process.
- Help learners to form groups before you assign them the activity.
- While they doing the activity, walk around while monitoring their work and helping where they have difficulties.

Learning and teaching materials for the unit

Manila cards, scissors, markers and masking tape and other materials that a teacher may see as important to achieve his/her objective.

Lesson 7.1

Revision on Mass Measurement (40 minutes)

Learner's Book, pages 119

Introduction

- Start with mental work on measuring mass
- Ask learners to form groups and provide each group with the materials required to carry out the activity.
- Walk around supervising them as they carry out the activity.
- Help them where they have difficulty.

Development

- Ask learners to bring stones or other materials to be used for measurement
- Ask them to measure and record.
- Ask each group to report what it has got as the answer.
- Give a general report about the sub-unit to help the learners internalise the concept.
- Guide learners through the example in the Learner's Book, page 119.
- Give learners an example to work out in groups and check on each group to see whether they have worked it out correctly.

Example

a) $30\text{dag} = \dots\dots\dots\text{g}$

Help learners to understand the worked example step by step.

Step 1 : Compare what is already known

$$1\text{dag} = 10\text{g}$$

Step 2: Compare proportionality.

That is, if we have 30 dag, we get $(30 \times 10\text{g})$ which is equal to 300g.

b) $2,500\text{g} = \dots\dots\dots\text{kg}$

Help learners to know how you convert from the small unit to the big unit through this example.

Step 1: Compare what is already known.

$$1\text{g is equal to } \frac{1}{1,000} \text{ kg}$$

$$\begin{aligned} \text{So } 2,500\text{g will be equal to } & \frac{1}{1,000} \text{ kg} \times 2,500 \\ & = 2.5\text{kg} \end{aligned}$$

Conclusion

- Guide learners through the Study tip and use it to emphasise what you have just taught.
- Guide the learners as they attempt Application 7.1.
- Give them three questions, then leave the remaining as home work.

Lesson 7.2**Revision on Capacity Measurement (40 minutes)****Learner's Book, pages 120****Introduction**

- Start with mental work about units of capacity and volume for example;
 - (a) What is the standard unit for measuring capacity?
 - (b) What is the smallest unit of capacity?
 - (c) Mention the units of capacity in order, starting with hectolitres.
 - (d) Find the volume of a cube of side 2 cm and so on.
- Group learners and provide each group with the necessary learning materials.

Development

- Guide learners as they carry out the activity in the Learner's Book, page 121.
- Allow each group to report its findings.
- Check if all groups have required materials
- Ask them to fill a jerrycan with water.
- After filling it, pour out water. Then fill it with a litre bottle.
- Ask them to record as they fill the jerrycan.
- Take them through an example.

Convert: a) 3,400l to *kl*

1kl is already equal to 1000l

3450l should be equal to $\frac{3450}{1000} = 3.45$

Therefore, 3,450 litres = 3.45 *kl*

- Lead learners through the examples in the Learner's Book, page 121.
- Give other examples to enable learners have more practice.
- Give learners chance to formulate their own conversion problems. Guide where they need help.

Conclusion

- Let learner's re-read the conversion table for capacity measurement.
- Let them read the study tip.
- Then they attempt Application 7.2 in the Learner's Book.
- Mark the work and give feedback. Help them do corrections.
- Let learners take notes.

Remedial Exercise

Give a simple exercise to slow learners to use a table, then answer:

1) 2 *kl* = _____ litres

2) 8 *dl* = _____ *ml*

3) 8 *dl* = _____ *ml*

4) 4 *hl* = _____ *dl*

5) 3l = _____ *cl*

6) 5 *dal* = _____ *dl*

Additional Exercise

Give a complex exercise to fast learners like this one.

1) Convert 800 *ml* to *dal*

2) Change 400 *l* to *hl*.

3) Convert 42 *cl* to *hl*

4) Change 16 *dal* to *kl*.

5) What is 12 *hl* in *kl*?

6) Find the equivalent of 752 *cl* in *l*.

Lesson 7.3 Measurement of Volume (40 minutes)

Learner's Book, pages 122

Introduction

- Give mental work about units of measurement of volume. For example:
 1. What is the standard unit for measuring volume?
 2. Mention the smallest unit for measuring volume?
 3. Give the units of measurement of volume.
- Let learners form groups.
- Distribute the prepared learning materials.
- Guide learners as they carry out the activity in the Learner's Book.

Development

- Collect the suggested answers of all groups and harmonise them to come up with general out comes.
- Tell the learners about the main competence of the lesson.
- Explain to learners that volume is the space occupied by an object.
- Objects have different sizes, so different units are used.
- There are different shapes of objects, so different methods are applied to work out their volume.
- Draw a table of conversion between units of volume.

m^3			cm^3			mm^3		

- Explain that the table does not go beyond m^3 because it is rare to have units of volume in dam^3 , hm^3 and km^3 .
- Learners should observe that unlike in measuring areas, in which units have 2 places in the table, units of measuring volume have 3 places in the table.
- It is so because cubic units mean the unit is multiplied thrice by its self. For examples: $cm \times cm \times cm = cm^3$; $m \times m \times m = m^3$.
- Write an example on the chalkboard.
Example: Convert $2m^3$ to cm^3 .
Emphasize that a conversion table has to be used.

m^3		dm^3			cm^3		
	2	0	0	0	0	0	0

- Write 2 in the first place under m^3 .
- Fill all the places to the right with zero (0) to the last place under cm^3 .
- Learners observe and read the numeral of units formed. It is: $2 m^3 = 2,000,000 cm^3$.
- Now introduce calculation method.

Example: A cuboid has length, width, height of 10 cm, 8 cm and 6 cm.
Calculate its volume.

Learners experienced this concept in Primary 5.

They are expected to recollect that:

$$\begin{aligned}\text{Volume of a cuboid} &= \text{length} \times \text{width} \times \text{height} \\ &= l \times w \times h \\ &= 10 \text{ cm} \times 8 \text{ cm} \times 6 \text{ cm} \\ &= 80 \text{ cm}^2 \times 6 \text{ cm} \\ &= 480 \text{ cm}^3\end{aligned}$$

- Refer to the examples in the Learner's Book, page 122.
- Let learners observe and study how conversions have been handled.

Conclusion

- Let learners read the study tip as a summary of the lesson.
- Let them attempt Application 7.3.
- Mark their work and give feedback.
- Help learners to do corrections.
- Let them take notes in their exercise books.

Remedial Exercise

Let slow learners practise more by re-doing the application.

Additional Exercise

Fast learners should do a more complex exercise.

1. Convert 0.42 m^3 to dm^3 .
2. Convert 9.004 dm^3 to cm^3 .
3. Change 0.003 m^3 to mm^3 .
4. Convert $60,000 \text{ cm}^3$ to m^3 .
5. Change 1.75 dm^3 to mm^3 .

Lesson 7.4

Finding the relationship between units of volume, capacity and mass (40 minutes)

Learner's Book, page 123

Introduction

- Choose a warm-up for yourself to refresh learners.
- Help learners to form groups of five pupils.
- Make sure each group may have access to a cup and beam balance.

Development

- Ask learners to measure the mass of water filled in a cup.
- Ask them to measure the mass of water contained in a cup and its capacity.

- Ask them to identify the volume of the cup.
- Let them discuss and come up with the relationship between these three units of measurements.
- Exchange the ideas by presenting their work.
- Help them to draw the table that shows the relationship of these unit. What is the relation of litre, kilogram and dm^3 ?

Solution

With the help of conversion table, the relationship is:

m^3			dm^3				cm^3			mm^3		
		<i>kl</i>	<i>hl</i>	<i>dal</i>	<i>l</i>	<i>dl</i>	<i>cl</i>	<i>ml</i>				
		<i>t</i>	<i>q</i>	<i>mg</i>	<i>kg</i>	<i>hg</i>	<i>Dag</i>	<i>g</i>	<i>dg</i>	<i>cg</i>	<i>mg</i>	
					1							

So $1\text{ kg} = 1\text{ l} = 1\text{ dm}^3$

- Explain to them that these units are related only when we are measuring water.
- Guide learners as they study the examples in the Learner's Book.
- Give other examples so that learners can understand.

Examples: relate volume of the figure below with its capacity.

Note: This activity may take some time as learners carry it out but its worthy it for the learners will clearly see the relationship between volume and capacity.

Come up with a general conclusion after discussing as class, that is; A cube of volume $1,000\text{ cm}^3$ or 1 dm^3 can hold a litre of water.

$1\text{ litre} = 1,000\text{ cm}^3$ or 1 dm^3 .

- Guide learners as they study the examples in the Learner's Book.
- Give other examples so that learners can understand.

Conclusion

- Let learners study and read the Study tip.
- Ask them to attempt Application 7.4.
- Mark their work and give feed back. Then they take notes.

Lesson 7.5

Converting between units of Volume, capacity and mass (40 minutes)

Learner's Book, pages 125

Introduction

- Request learners to recall the relationship of volume ,capacity and mass measurement.

- Help them to form groups.
- Request them to draw a table showing the relationship of these unit.

Development

- Give them an activity in the Learner's Book.
- Ask them to fill the given measurement in the place on the drawn table.
- Request them to convert them in the same unit as required.
- Let them record the related units.
- Give them time to explain to the class how they have got the answer.
- Give them opportunity to go through the example given.
- Ask them to find out which may be the concern when converting their unit.

Conclusion

- Take them through the study tip.
- Let them attempt the questions of Application 7.5.
- Mark their work and help them do corrections.
- Let them take corrections.

Remedial Exercise

Slow learners can find the relationship between capacity and mass in case of water using numbers which are simple. For example;

Find the capacity of water with the following mass.

1. The water in Uwera's jerrycan weighs 5 kg. Find the capacity of the water in Uwera's jerrycan.
2. Mrs Mulenga used 25 kg of water when washing. Calculate the capacity of water she used.
3. Yesterday I drunk 1.8 kg of water, how much water in litres did I drink?

Additional Exercise

Gifted learners can try out more complex problems such as the ones below:

1. Mrs Nkusi used 32 kg of water to wash the clothes, 8.5 kg to mop, 12.8 kg to wash the utensils and 4.3 kg to cook.
 - (a) Find the total mass of water she used.
 - (b) Express the amount of water she used in decalitres.
2. Ndoori loaded 105 boxes of water on a truck each with water weighing 18 kg.
 - (a) Calculate the capacity of water he loaded.
 - (b) Express the water he loaded in dal.

Revision Activities

Relate the capacity of the cube below with its volume.

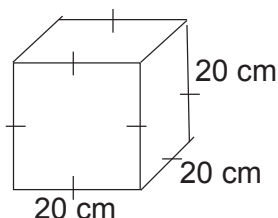

$$\begin{aligned} \text{since volume of a cube} &= s \times s \times s \\ \text{volume} &= 20 \text{ cm} \times 20 \text{ cm} \times 20 \text{ cm} \\ &= 8,000 \text{ cm}^3 \\ 1,000 \text{ cm}^3 &= 1 \text{ litre} \\ \text{so } 8,000 \text{ cm}^3 &= \frac{8000}{1000} \\ &= 8 \text{ litres} \end{aligned}$$

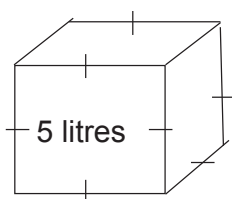

$$\begin{aligned} \text{since } 1 \text{ litre} &= 1,000 \text{ cm}^3 \\ \text{and } 1,000 \text{ cm}^3 &= 1 \text{ dm}^3 \\ \text{Then } 5 \text{ litres} &= 5 \times 1,000 \text{ cm}^3 \text{ or } 5 \times 1 \text{ dm}^3 \\ &= 5,000 \text{ cm}^3 \text{ or } 5 \text{ dm}^3 \\ \text{So the volume of this cube is } &5,000 \\ &\text{cm}^3 \text{ or } 5 \text{ dm}^3 \end{aligned}$$

Convert the following in given unit.

- $98,234 \text{ kg} = \dots \text{ m}^3$
- $90 \text{ dm}^3 = \dots \text{ kl}$
- $1 \text{ ton} = \dots \text{ g}$
- $12,641,564 \text{ g} + 345,564 \text{ dag} = \dots \text{ kl}$

Extension activities

- $(1,243 \text{ kg} + 23,453 \text{ cm}^3) \times 22 = \dots \text{ kl}$
- Munyana's cow gave birth to a calf. The cow gives her 10 l of milk a day. How many m^3 does she collect in a month if her cow is milked the same amount everyday?
- Which bottle has the highest capacity than the other: a bottle of 5 l or that of 432 ml?

Answers to Application 7.1

- (a) 523,000 dg (b) 6,661,500 mg 2) 47,600 kg
- $6\frac{13}{20} \text{ kg}$ or 6.65 kg (4) 231.42 kg 5) 7,500 g
- Harmonise the answers

Answers to Application 7.2

- (1) 250 jerrycans
 (2) $\frac{2}{3} l$ (3) 500,000 l
 (4) (a) 6 small jerrycans
 (b) 2 litres
 (5) 16,240 dl
 (6) Harmonise answers

Answers to Application 7.3

- 1) (a) 3,000,000 cm^3 (b) 15,000 cm^3
 (c) 600 dm^3 (d) 32,000 dm^3
 2) (a) 4 m^3 (b) 15,000 cm^3 (c) 700 cm^3
 3) (a) 620 mm^3 (b) 1,200 cm^3 (c) 1,078 m^3
 4) 48,000,000 cm^3 5) Check for accuracy
 6) Teacher's discretion

Answers to Application 7.4

- 1) 1 kg = 1 dm^3 = 1 l; 1 g = 1 cm^3 = 1 ml;
 1 t = 1 m^3 = 1 kl; 1 hg = 100 cm^3 = 1 dl
 2) 20 litres
 3) No, 1 litre of cooking oil has more mass than 1 kg of water.
 4) Explain as discussed.

Answers to Application 7.5

- 1) (a) 676,700 cl (b) 4,000,000 g (c) 98.65 q (d) 46,900 ml
 (e) 1,700,000 cm^3 (f) 32,500 g
 2) 40 l, 40 kg 3) 10,000 dm^2 4) 700 litres
 5) (a) 10,000 cm^3 (b) 100q
 6) (a) 12,000,000 cm^3 (b) 12 m^3
 7) (a) 2 q (b) 200,00 ml

Unit 8

Speed, distance and time

Key unit competence: To be able to calculate speed, distance and time, solve problems that relate to different time zones and convert speed from km/hr to m/sec and vice versa.

List of lessons

Lessons	Number of lessons	Number of periods
8.1 Comparing the 12-hr format to the 24-hr format.	1	1
8.2 Converting the 12-hr to the 24-hr format.	1	1
8.3 Converting 24-hr to 24-hr format.	1	1
8.4 The concept of time zones	1	2
8.5 Solving Mathematical problems of time zones.	1	2
8.6 Calculating speed.	1	1
8.7 Converting speed from km/hr to m/sec	1	2
8.8 Converting speed from m/sec to km/hr	1	2
8.9 Calculating distance	1	1
8.10 Calculating time	1	1
8.11 Moving bodies towards each other.	1	1
8.12 Moving bodies following each other.	1	1
8.13 Calculating average speed.	1	2
End of Unit 8 Assessment	1	2
Total	14	20

Guidance on problem statement

This unit is related to every day movement so, it will help learners to have a habit of time management in their daily life. Give them a challenging problem by taking them through an introductory activity in the Learner's Book, page 127.

Cross-cutting issues

Throughout the teaching process of this unit, it will be crucial to help learners to master the content and it is better to address cross-cutting issues where possible. In this unit we will address the following Cross-cutting issues as non-stand alone within classroom activities and through the development of the content.

- **Peace and value education:** First of all, as a teacher, you have to be a peace maker in the class and role model so that learners will imitate how you behave. When there is any conflict do not leave without helping to solve it. Within the lesson, encourage learners to behave well, being humble, honest, etc.
- **Gender education:** This cross-cutting issue will be addressed through giving equal opportunities to both boys and girls during the lesson.
- **Environment and sustainability:** Through a problem, including the road where they pass let learner think of the usefulness of the roads and how they can take care of them.

Learning Objectives

Knowledge and understanding

- Explain the relationship between a 12-hour clock and a 24-hour clock.
- Define speed, distance and time.
- Identify different units of speed, distance and time.
- Explain what determines time zones.

Skills

- Convert from km/hr to m/sec and vice-versa.
- Solve problems that relate to different time zones.
- Solve simple problems involving the calculation of speed, distance and time in real life situations.

Attitudes and values

- Appreciate the importance of time in daily life situations.
- Show concern towards respecting one another in group activities and welcoming group ideas.
- Appreciate the relationship between speed, distance and time to understand the notion of time management.

Number of lessons: 20

Guidance for classroom organisation

- Before you start a lesson, first use warm-ups or energizers in order to engage learners into the lesson. Do not focus on this only, try to be creative. The essence is to motivate learners and make them active throughout the teaching- learning process.
- Help learners to form group before you assign them an activity.
- While they are doing the activity, walk around while monitoring their work and helping where they have difficulties.

Learning and teaching materials for the Unit

Manila cards, scissors, markers and masking tape and other materials that teachers may see as important to achieve his/her objective.

Lesson 8.1 Comparing the 12-hr format to 24-hr format (40 minutes)

Learner's Book, page 127

Introduction

- Let learners have discussion on parts of the day (the day and night)
- Ask them what differentiates the two periods.
- Let them know that a day lasts 24 hours.
- Organise learners in groups.

Development

- Distribute sheets of paper to each group.
- Display charts showing the 12-hr format and 24-hr format faces.
- Ask the learners to copy them onto the sheets of paper.
- Guide them to discuss a.m. and p.m. time.
- Let them compare the time readings on both clocks.
- Ask learners to write compared time on the sheets of paper.
- Let them discuss with other groups the comparisons.
- Lead them through the activity in the Learner's Book, page 127.
- Ask the learners to read the 12-hr format time relating it to 24-hr format time.
- Through question and answer, let learners respond to questions from their fellows.

Example: What is 3:00 p.m. in 24-hr format?

Express 19:00 hrs as 12-hr format time.

- Give learners opportunities.
- Refer to the examples in the Learner's Book, page 127 and 128.
- Ask oral questions about the lesson.

Conclusion

- Let them present their work.
 - Now let the learners read and discuss the Study tip and attempt Application 8.1 that follows.
 - Preview the work about time done in Primary 4.
 - Every learner should be actively involved.
 - In case you can get real clocks, use them for the benefits of understanding better.
 - Give examples of business enterprises that use 24-hr format.
 - Help slow learners to practice more comparing 12-hr format with 24-hr format.
 - They should also practice more reading of time of both the 12-hr format and 24-hr format.
- (a) 8:17 a.m. to 24-hr format. (b) 12:03 p.m. to 24-hr format.
 (c) 9:21 p.m. to 24-hr format. (d) 07:49 hrs to 12-hr format.
 (e) 21:20 hrs to 12-hr format

Lesson 8.2**Converting 12-hr format to 24-hr Format (40 minutes)****Learner's Book, page 129****Introduction**

- Form groups.
- Review the previous lesson.
- Ask them to brainstorm/recall the previous lesson.
- Distribute sheets of paper.

Development

- Lead the learners through the activity in the Learner's Book, page 129.
- Request them to match out the time given in the activity.
- Give them time to present their work.
- Remind the learners that a full day has 24 hours.
- Explain that a 12-hr format shows time twice in a single cycle of the 24-hr format.
- Inform them that to convert 12-hr format to 24-hr format, we should first observe if it is a.m. or p.m. time.
- In case it is a.m. time, it changes directly. That is, we add 00:00 to a.m. time. We do so because time has not reached or passed noon.
- If it is p.m. time, we change it by adding 12:00 hours. We do so because we count all the time from midnight or the beginning of a new day.
- Emphasise that 24-hr format is written with 4 digits.
- Guide the learners through the examples in the Learner's Book, page 130.
- Ask learners to formulate their own questions.
- Let one group challenge another for giving the correct conversion from 12-hr format to 24-hr format.
- Give some more examples as learners work them out on slips of paper.
- Evaluate their work.

Conclusion

- Discuss the Study tip and ask for the learner's opinions.
- Ask the learners to attempt Application 8.2 in the Learner's Book, page 130.
- Emphasise the addition of 00:00 to a.m. time and 12:00 to p.m. time when converting to 24-hr format.
- Minutes passed 12:00, eg 12:05 p.m. and minutes passed midnight eg 12:15 a.m. may be confusing to the learners.
- Devise methods of simplicity to overcome the challenge.

Remedial Exercise

Let slow learners attempt the exercise below:

Tell the time the following activities take place then convert to 24-hr format.

- (1) Time for entering the class.
- (2) Time for break.
- (3) Time for lunch.
- (4) Time for ending lessons.
- (5) Time of midday.
- (6) Time of midnight.

Additional Exercise

Let fast learners attempt the exercise below:

- (1) The time now is 5:17 p.m.. What time will it be 8 hours later? Convert to 24-hr format.
- (2) It is midday. What will be the time 12 hours later? Change it to 24-hr format.
- (3) If it is midnight, what time will it be 15 hours and 13 minutes later. Express as 24-hr format.
- (4) It is 12:20 a.m.. How long is the new day?
- (5) 17 hours was the flight from New York to Kigali. A passenger left New York at 3:45 p.m.. At what time did he arrive in Kigali? Convert to 24-hr format.

Lesson 8.3**Converting 24-hr format to 12-hr format (40 minutes)**

Learner's Book, page 131

Introduction

- Brainstorm the learners by asking them to give instances where 24-hr format is used.
- Review the previous work.
- Form groups.
- Distribute the instructional materials.

Development

- Tell learners that they have a watch which shows 24:00 hours.
- Ask them to tell what should the watch show in 12-hours format.
- Give them time to discuss in their respective group, then share with the class.
- Lead the learners through the matching activity in the Learner's Book, page 131.
- Challenge the learners to explain the procedure of converting 24-hr format to 12-hr format.
- Explain that, if the time given is below 12:00, we should subtract 00:00.
- Take them through the example.

Example: Express 09:15 hrs as 12- hr format time.

$$\begin{array}{r} 09:15 \\ + 00:00 \\ \hline \mathbf{09:15} \end{array}$$

- Explain that 0 is dropped, and the time is written; 9:15 a.m.
- Explain further that, when we study the time given, it is below 12:00.
- This means that 09:15 is below 12:00 noon. That is why there are zero hours and zero minutes to be subtracted.
- Now give another example with time above 12:00.

Example: Change 17:20 hrs to 12-hr time.

- We subtract 12:00 because 17:20 has passed 12:00 noon.
- So the 12-hr format has started another cycle.

$$\begin{array}{r} 17:20 \\ - 12:00 \\ \hline \mathbf{05:20} \end{array}$$

- We drop 0 to make the time 5:20.
- Being that it has passed noon, we express the time as p.m..
- So the time is 5:20 p.m.
- Give them more examples for the learners to do more practice.
- Let them formulate their own questions.
- Oversee the class discussion.

Conclusion

- Ask the learners to read and understand the Study tip.
- Let them attempt Application 8.3.
- Emphasise that the time 12 midnight, 12 noon and minutes passed do not follow the two methods used to convert to 12-hr format.
- Give more practice to the learners especially relating to the above.
- Try to provide real clocks or watches.
- Give learners a lot of revision exercise and homework.
- This will effectively cater for all categories of learners.

Lesson 8.4

The Concept of Time Zones (80 minutes)

Learner's Book, page 132

Introduction

- Review the previous work.
- Distribute the learners in groups.
- Let them discuss what causes to have different time in different region.

- Give them time to share their discussion.
- Let them know that they are going to study time zone.
- Give out Atlases or let the learners use their own.

Development

- Refer to the world map showing time zones on page 133.
- Guide the learners through the activity in the Learner's Book, page 132.
- Lead learners to realise that there are 24 time zones in the world.
- Each time zone is represented by 15° .
- The international date line lies on a longitude of 180° East of the Greenwich Meridian.
- Help them to identify the Greenwich meridian.
- Explain that, the Greenwich meridian is the most important longitude when determining the world time zones.
- Refer to the Learner's Book and let the learners study and analyse the example.

Conclusion

- Let the learners read and discuss the Study tip.
- Ask them to attempt Application 8.4 in the Learner's Book, page 134.
- Let learners present their work.
- After presentation let them write down the summary made in their books.
- In case you have availability of the internet, use it for more information and let learner know
- Explain the concept of gaining time as one moves to West. and also of losing time as one moves to the East.
- Also explain that further from the international date line to the East, we lose a full day.
- Give learners more numbers as homework to help them understand the concept better.

Lesson 8.5

Solving Mathematical Problems Relating to Time Zones (80 minutes)

Learner's Book, page 134

Introduction

- Review the previous work.
- Distribute the learners in groups.
- Give out Atlases or let the learners use their own.
- Refer to the world map showing time zones.

Development

- Guide the learners through the activity in the Learner's Book, page 134.
- Explain to them that, we can be able to calculate the time of a particular place or town, by considering the position of the time zone it is further from the 0° .
- Give some examples;

Example: It is 12:00 midnight in Greenwich. What time is it in Rwanda?

Working: Rwanda lies on 30° longitude east of Greenwich.

Places to the East are later in time.

Places in the 1st zone to the East are 1 hour later.

Rwanda is in the 2nd time zone from Greenwich (0 time zone).

1st time zone = 1 hour

2nd time zone = 2×1 hour
= 2 hours

Add 2 hours to the time in Greenwich 12:00 midnight is the end of the 24-hr day. So a new day begin: $00:00 + 02:00 = 02:00$. It is 2:00 a.m. in Rwanda.

- Refer to the Learner's Book and let the learners study and analyse the examples. Lead them to realise that Rwanda is 8 hrs ahead of America in time. If it is 4:00 p.m. in New York, it is 12:00 midnight in Rwanda.

Conclusion

- Let the learners read and discuss the Study tip.
- Ask them to attempt Application 8.5.
- In case you have availability of the internet, use it for more information.

Remedial Exercise

- (1) Given that $15^{\circ} = 1$ hour, calculate the hours in
 (a) 45° (b) 60° (c) 90° (d) 180°
- (2) It is 2:00 am in New York. What is the time in Rwanda?

Lesson 8.6**Calculating Speed (40 minutes)**

Learner's Book, page 136

Introduction

- Review time zones of the world.
- Lead the learners through the activity in the Learner's Book.

Development

- Through participatory work, let each group work out the distance in metres that was covered by each individual in one second.
- Let learners realise that each individual covered a different distance in one second. Though they all covered the same distance.

- Explain that the distance covered in each second is called speed.
- Provide some records from running activities or competitions in which the school was involved.
- Let the learners in groups prepare the speed for each individual.
- Supervise the activity and get to know each group's answer.
- Now refer to the examples in the Learner's Book's Book, page 136.
- Guide the learners through the discussion.
- Let learners formulate their own questions leading to deducing speed involving metres and seconds, then involving kilometres and hours.
- In groups, let them discuss and there after make a class presentation.

Conclusion

- Let the learners read and internalise the Study tip.
- Explain further that speed can be metres per second, (m/sec) or kilometres per hour (km/hr). These are the commonly used units of speed.
- Ask the learners to attempt Application 8.6 in the Learner's Book, page 137.
- In this lesson, do not give questions involving deep calculation yet.
- This will be tackled in the next sub-topic.
- Be more expressive in deducing the concept of units of speed.
- Give more work to cater for both categories of learners.

Lesson 8.7

Converting Speed from km/hr to m/sec (80 minutes)

Learner's Book, page 137

Introduction

- Review the previous work.
- Give mental work about conversion of kilometres to metres and hours to seconds.
- Review converting kilometres to metres and hours to seconds.
- Do this in case there is evidence of forgetfulness in the mental work exercise. Use flash cards.
- Distribute the learners in groups.
- Give out slips of paper, or sheets of paper.
- Guide the learners through the activity in the Learner's Book, page 137.
- Moderate the discussion then evaluate the work.
- Remind them that in P.4, they learnt about conversion of length measurements and conversion of units of time. i.e. 1 km is 1,000 m and 1 hour is 3,600 seconds.

Development

- Explain that the activity they have been involved in is about converting speed in km/hr to speed in m/sec.
- Display the chart with examples you prepared.

- Ask the learners to read the contents, step by step.
- Emphasise division by simple common factors, other than using big factors.
- Refer to the examples in the Learner's Book, page 138.
- In groups, let the learners discuss the steps carried out.

Conclusion

- Give guidance where challenges arise.
- Let learners formulate their own problems, calculate them in groups, discuss and then make a class presentation.
- Ask learners to read and internalise the Study tip.
- Ask learners to attempt Application 8.7.
- The challenge may be in division of large numbers.
- Advise learners to start with the smaller common factors of the numbers to be divided.

Remedial Exercise

Let slow learners try out the following

Convert to m/sec

- (1) 10 km/hr (2) 12 km/hr (3) 8 km/hr
 (4) 20 km/hr (5) 6 km/hr
 (6) A pedestrian walks 4 kilometres per hour to work. What is his speed in metres per second?
 (7) A speed of 9 km/hr was moved by a road grader. Express it as metres per second.
 (8) Kalisa rode a bicycle at a speed of 10 km/hr. Change it to metres per second.

Additional Exercise

Let fast learners practice the following

- (1) 1.2 km/hr (2) 3.6 km/hr (3) 14.4 km/hr (4) 32.4 km/hr
 (5) Mutesi drove her car for 2 hours covering a distance of 144 km. Express her speed as metres per second.
 (6) Tourists visited a National park. Their driver covered 240 km in 6 hours. What was his average speed in metres per second?
 (7) A fire work was propelled at a speed of 720 km/hr. Express the speed as metres per second.

Lesson 8.8

Converting Speed from m/sec to km/hr (80 minutes)

Learner's Book, page 139

Introduction

- Challenge the learners to recall what was taught get different ideas
- Ask learners to explain how they can change metres to kilometres and seconds to hours.
- Let them form groups and distribute learning materials.

Development

- Lead the learners through the activity in the Learner's Book, page 139.
- Moderate the discussion.
- Tell the learners that they have just carried out the steps for converting metres per second to kilometres per hour.
- Explain that, in order to change m/sec to km/hr, we carry out these steps below.
 - (i) Express 1m as a fraction of a kilometre, then multiply the number of metres by $\frac{1}{1000}$ kilometres. Remember 1 km = 1,000 m.
i.e. $1\text{m} = \frac{1}{1000}\text{ km}$, $20\text{ m} = 20 \times \frac{1}{1000}\text{ km} = \frac{20}{1000}\text{ km}$
 - (ii) Express 1 second as a fraction of 1 hour. remember 1 hour = 3,600 seconds. It gives $\frac{1}{3600}$ of an hour.
 - (iii) Speed = distance per unit time
 - (iv) So we divide the fraction of a kilometre by the fraction of an hour.
 - (v) Apply division of fractions by multiplying by the reciprocal.

Example: Express 20 m/sec as km/hr

$1000\text{ m} = 1\text{ km}$	$20\text{m/s} = 20 \times \frac{1}{1000} \div \frac{1}{3600}\text{ hr}$
$1\text{m} = \frac{1}{1000}\text{ km}$	$= \frac{20}{1000} \times \frac{3600}{1}$
$3600\text{ sec} = 1\text{ hr}$	$= 2 \times 36$
$1\text{ sec} = \frac{1}{3600}\text{ hr}$	$= 72\text{ km/hr}$

- Refer to the examples in the Learner's Book, page 139.
- Let the learners discuss the methods carried out, as you guide them.
- Write more examples on the blackboard.
- Ask learners to calculate them on the sheets of paper you provided.
- Move around to separate groups, as you evaluate their work.
- Contented that the concept has been clearly grasped, challenge them to formulate their own questions.

Conclusion

- Let them hold a discussion in groups. Then make a presentation to the class.
- Let them read and undertake the Study tip.
- Let them attempt application 8.8.
- Mark their work and help them do corrections.
- Provide these exercises as home work.

Remedial Exercise

Let slow learners try out the following

- Express to km (don't reduce to lowest terms).
 - 20 metres
 - 5 metres
 - 10 metres
 - 15 metres
 - 30 metres
- Express to hours.(do not reduce to lowest term)
 - 5 seconds
 - 12 seconds
 - 15 seconds
 - 20 seconds
- An athlete covered a distance of 100 metres. Express the distance in kilometres.
 - Tunga drives racing cars. He drove the first leg in 300 seconds. Express as hours.

Additional Exercise

Let fast learners practice the following

- Express to km/hr.
 - 120 m/sec
 - 400 m/sec
 - 500 m/sec
 - 14.4 m/sec
 - 3.6 m/sec
- 100 m for 20 seconds
 - 180 m for 40 seconds
- Mukayahi threw javelin. It covered 50 metres, it took 5 seconds to land. What was its speed in kilometres per hour?
 - Richard was playing darts. He threw the spike for a distance of 5 metres. It lasted in air for 2 seconds. At what speed was the spike moving?

Lesson 8.9**Calculating Distance (40 minutes)**

Learner's Book, page 141

Introduction

- Review defining speed and the previous lesson.

Development

- Let the learners mention the metric units of distance.
- Distribute the learners in groups and provide sheets of paper to them.
- Move from group to group as they carry out the activity in the Learner's Book.
- Learners should realise that the product of speed and time gives the distance.
- Explain that in order to calculate distance, the given speed and time are multiplied to get the product. ie $\text{Distance} = \text{Speed} \times \text{Time}$.
- Write some examples on the chalkboard.
- Ask the learners to calculate them in groups.

- Let them discuss the procedure in order to internalise it.
- Refer to the examples on the chart.
- Ask the learners to study, read and discuss how they were worked out.
- Now refer to the examples in the Learner's Book, page 142.
- Learners should discuss them, then make a conclusion.

Conclusion

- Ask them to read the Study tip.
- Mark their work and help them do corrections.
- Let learners take notes.

Remedial Exercise

Let slow learners re-do activity 8.9. Emphasise application of multiplication of fractions when dealing with fractional time. Kilometres and metres are the commonly used units of distance when calculating distance. However, you can use other metric units of distance.

Additional Exercise

Prepare more questions to help fast learners.

Calculate the distance, then complete the table.

Speed	Time	Working	Distance
10 m/s	5 seconds		
15 m/s	4 seconds		
20 m/s	6 seconds		
40 km	2 hours		
100 km	5 hours		

- A certain distance is covered in 19 seconds. If the speed is $6\frac{1}{2}$ m/sec, calculate the distance.
- Uwera run a certain distance. She run at a speed of 9.8 m/sec. She covered it in 115 seconds. What distance did she cover?
- A moving body moved at a speed of 12.3 m/sec. It took 55 seconds. How long was the distance?
- A racing car was running at a speed of 333.3 km/hr. It covered the route in 9 hours. Calculate the distance it covered.
- Ali drove his car at 120.25 km/hr. He took 3 hours. calculate the distance he covered.
- The speed of a racing boat is 219 km/hr. It spent $3\frac{1}{3}$ hrs cruising. What distance did it cover?

Lesson 8.10 Calculating Time (40 minutes)

Learner's Book, page 142

Introduction

- Brainstorm the learners to mention the units of time, then conversion between them.
- Distribute the learners in groups.
- Distribute sheets of paper to each group.
- You may move out of class to a parking yard or taxi and bus park.
- Research and record the recommended maximum speeds of the taxis and buses.
- Ask resource persons like park attendants or drivers.
- Back to class, let learners continue with the activity in the Learner's Book, page 142.
- Let them do the calculations on the sheets of paper provided.
- Lead them to realise that the result of their calculations is time.
- Tell that, in order to calculate time, distance is divided by speed when the distance and speed are given.

Development

- Display the chart with worked examples.
- Let the learners study them, analyse then discuss them.
- Guide them in case of any challenge.
- Now ask them to study the examples in the Learner's Book, page 142.
- They should again observe that; $\text{Time} = \frac{\text{Distance}}{\text{speed}}$
- Apply the same methods to the next lesson involving distance in kilometres and speed in km/hr.
- Bearing this method in mind, let them formulate their own questions.

Conclusion

- Moderate the discussion as they exchange ideas.
- Let the learners read and discuss the Study tip.
- Ask the learners to do Application 8.10.
- Mark their work and give feedback. Let them do corrections and take notes.
- Give a lot of exercise to the learners. This helps them to master the concept.

Remedial Exercise

Let slow learners calculate time given;

1. Distance is 40m, speed is 10 m/sec.
2. Distance is 50 m, speed is 5 m/sec.
3. Distance is 100 m, speed is 20 m/sec.
4. An athlete run a distance of 200 m at a speed of 10m/sec. calculate the time he took.

5. Distance is 10 km, speed is 5 km/hr.
6. Distance is 15 km, speed is 15 km/hr.
7. Distance is 20 km, speed is 10 km/hr.
8. A bus covered a distance of 100 km. Its speed was 50 km/hr. What time did it take?

Additional Exercise

Fast learners can calculate time given;

1. Distance is 1800 m, speed is $4\frac{1}{2}$ m/sec.
2. Distance is 960,120 m, speed is 12 m/sec.
3. Ikiza covered a distance of 1200 m from home to school. She was walking at a speed of 1.5 m/sec. what time did she take?
4. Distance is 100 km, speed is 80 km/hr.
5. Distance is 575 km, speed is 92 km/hr.
6. Gasoma was driving his car at a speed of 132 km/hr. he covered a distance of 418 km. Calculate the time he took.

Lesson 8. 11 Moving Bodies Towards Each Other (40 minutes)

Learner's Book, page 143

Introduction

- Review the previous work.
- Form groups and guide the learners through the activity.
- Moderate the discussion.

Development

- Explain to them that two moving bodies towards each other take the same time to meet, but cover different distances.
- Inform learners that the meeting time can be calculated basing on the time each can take to cover the whole distance.
- Give an example on the blackboard.

Example: James and Alice were on opposite sides of a track. They run towards each other. James took 5 minutes to cover the track, Alice took 4 minutes. After how long did the two meet?

James took 5 minutes

1 minute, he covered $\frac{1}{5}$ of the track.

Alice took 4 minutes

1 minute, she covered $\frac{1}{4}$ of the track.

In 1 minute, both covered $\frac{1}{5} + \frac{1}{4}$

$$= \frac{4 + 5}{20}$$

$$= \frac{9}{20} \text{ of the track}$$

Both met after;

whole distance divided by the time both met after 1 minute.

$$1 \div \frac{9}{20} = 1 \times \frac{20}{9}$$

$$= \frac{20}{9} = 2\frac{2}{9} \text{ minutes.}$$

- Guide the learners in every step as you make a thorough explanation.
- Learners may be confused at first. But, with precise explanation they will finally understand the concept.
- Now refer to the example in the Learner's Book, page 144.
- Let the learners study it and then discuss it.
- Follow their discussion intently, and intercept where there is a mistake, for correction.
- Give some more examples to help learners master the concept. Learners should lead in the discussion about them.
- Then, ask them to formulate their own.
- Evaluate their procedure of working and answers.

Conclusion

- Ask them to read and discuss the Study tip
- Let them attempt Application 8.11.
- The lesson may seem challenging to some learners. Ensure you explore it as much as you can.
- Also discuss finding distance covered by each, distance apart and remaining distance for each with the learners.
- Mark their work and help them do corrections.
- Let them take notes in their books.

Remedial Exercise

Slow learners can try out the exercise below for practice.

1. Write one part of each of the following.

- (a) 3 (b) 4 (c) 6 (d) 9 (e) 12

2. Calculate the following:

- (a) $\frac{1}{2} + \frac{1}{2}$ (b) $\frac{1}{2} + \frac{1}{3}$ (c) $\frac{1}{3} + \frac{1}{4}$

3. Work out:

- (a) $1 \div \frac{1}{2}$ (b) $1 \div \frac{1}{3}$ (c) $1 \div \frac{1}{4}$

Additional Exercise

Prepare more questions to help fast learners

Work out the following;

1. Nsenga travelled from town Q to town P. He took 3 hrs. Irebe covered the same distance, but from P to Q she took 4 hours. The distance was 140 km.
 - (a) At what time did both meet?
 - (b) Calculate the distance each covered when they met?
2. A bus started its journey from Kampala to Kigali. It took 8 hrs. A taxi started from Kigali to Kampala. It took 6 hours. The distance from Kigali to Kampala is 514 km.
 - (a) Calculate the time both met.
 - (b) What distance had each covered when they met?

Lesson 8.12 **Moving Bodies Following Each Other (40 minutes)**

Learner's Book, page 145

Introduction

- Review the previous work and calculating time.
- Form groups and guide the learners as they carry out the activity in the Learner's Book, page 145.

Development

- Let the learners in groups discuss the activity, then make a presentation to the class.
- Refer to the Learner's Book and lead the learners through the procedure of the example.
- Ensure the learners grasp the concept thoroughly well through question and answer.
- Give some more examples on the blackboard.
- Prioritise the learners in calculating them. Assist them where they get challenges and compliment them.
- Explain the concept comprehensively such that the learners internalise it.
- Give several examples such that learners benefit from more practice.

Conclusion

- Ask the learners to read the Study tip.
- Let them attempt Application 8.12.
- Mark their work and help them do corrections.
- Let them take notes.

Remedial Exercise

Slow learners can try out the exercise below for practice.

1. Two boys run a distance of 50 metres. One was running at a speed of 25 m/sec and the other one was running at a speed of 10 m/sec. What was the difference between each one's time of arrival?
2. A motorcycle and a bicycle were moving in the same direction. Both covered 10 km. The motorcycle was moving at 10 km/hr. The bicycle was moving at 5 km/hr. What was the difference between their arrival time?
3. A dog run at 8 km/hr. A goat run at 4 km/hr. Both covered 8 km. What was the difference between their arrival time?

Additional Exercise

Prepare more questions to help fast learners

1. A car and a lorry were moving in the same direction. They started at the same time, same place. A car was moving at 120 km/hr and a lorry at 80 km/hr. Both covered 200 km. What was the difference in the time of arrival?
2. Both a cat and a kitten started running in the same direction. The cat was running at 4 m/sec while the kitten run at 2 m/sec. Both covered 10 m. Calculate the difference in time taken.
3. Two racing cars one was running at 225 km/hr. The other one was running at 250 km/hr. Both covered 1200 km. Calculate the difference in their arrival time.

Lesson 8. 13**Calculating Average Speed (80 minutes)**

Learner's Book, page 147

Introduction

- Review the previous lesson.
- Give some mental drills about speed.
- Distribute learners into groups according to your plan.
- Let the learners carry out the activity in the Learner's Book, page 147.
- Evaluate their results and help them do corrections.

Development

- Distribute the suggested learning aid.
- Explain the main concept of the lesson.
- Tell the learners that average speed is worked out if we have two or more separate journeys continuously covered.
- Write an example on the chalkboard and ask learners to copy it on sheets of paper, then try to work it out.

Example 1: A lorry covered a journey of 240 km in 4 hours. It continued its journey covering 60 km in 1 hour. What was its average speed?

Explain to learners that average speed is assumed to be constant speed moved by a moving body, covering the same distance per unit time.

In this case, the total distance of the two legs of the journey is divided by the total time taken to cover both distances.

$$\begin{aligned} \text{Average speed} &= \frac{\text{Total distance covered}}{\text{Total time taken}} \\ &= \frac{\text{First distance} + \text{second distance}}{\text{First time} + \text{second time}} \end{aligned}$$

$$\begin{aligned}
 &= \frac{240 \text{ km} + 60 \text{ km}}{4 \text{ hrs} + 1 \text{ hr}} \\
 &= \frac{300 \text{ km}}{5 \text{ hrs}} \\
 &= 60 \text{ km/hr}
 \end{aligned}$$

Therefore, the average speed is 60 km/hr.

- Check for the steps and accuracy of the working displayed by the learners, then correct where they got challenges.
- Explain to them that sometimes, the journey is not only outward, but it can be a return journey.
- Ask learners to give instances where return journeys are experienced. For example, going to school from home and returning home from school.
- Moderate the discussion and make a general observation.
- Write another example on the chalkboard dealing with a return journey. Ask learners to try it on sheets of paper.

Example 2: A car traveled from town A to town B covering a distance of 175 km in 2 hours. It returned later via the same route. It covered the same journey in $1\frac{1}{2}$ hours. Calculate its average speed.

- Let learners get the difference between the first example and this one.
- Move around to monitor how they carry out the working steps.
- Having finished, ask the groups to present their work.
- Then make a general conclusion that:

The first distance = 175 km

The time taken = 2 hours

The second distance is the same as the first distance = 175 km

The time taken = $1\frac{1}{2}$ hours.

$$\begin{aligned}
 \text{So, average speed} &= \frac{\text{Total distance covered}}{\text{Total time taken}} \\
 &= \frac{175 \text{ km} + 175 \text{ km}}{2 \text{ hrs} + 1\frac{1}{2} \text{ hrs}} \\
 &= 350 \text{ km} \div 3\frac{1}{2} \text{ hrs} \\
 &= 350 \times \frac{2}{7} \\
 &= 100 \text{ km/hr}
 \end{aligned}$$

Therefore, the average speed is 100 km/hr.

- Guide the learners as they study and follow through the examples in the Learner's Book.
- Ensure learners are conversant with all the steps to be carried out.
- Give chance to the learners in their groups to formulate their own problems, work them out, then make a presentation to class.

Conclusion

- Guide learners through the Study tip.
- Use it to make a summary of the lesson.
- Ask them to attempt Application 8.13.
- Mark their work, give feedback and help them do corrections.
- Let learners take notes.

Remedial Exercise

Give slow learners work which is simpler for practice.

1. A pedestrian walked a distance of 10 km to visit a friend. He took 2 hours. He returned through the same road. He took 3 hours. What was his average speed?
2. A tractor covered 40 km in 1 hour. It continued to another farm covering 80 km in 2 hours. What was its average speed?
3. A train covered 20 km in 1 hour. It covered another 40 km in 2 hours. Find its average speed.

Additional Exercise

Give fast learners complex numbers to work out.

1. Town P is 180 km from town R. A bus covered the distance in $1\frac{1}{2}$ hours. It continued to another place 150 km away in 2 hours. It further went to another distance of 175 km taking 3 hours. Calculate the average speed of the car.
2. Ali the driver of a pickup covered a certain distance at a speed of 65 km/hr. He took 3 hours to cover the distance. On his return journey, he took 2 hours. What was his average speed?
3. An aeroplane covered 1,200 km in 5 hours. On return, it traveled at a speed of 240km/hr. Calculate its average speed.

Revision activities

Convert:

- 1) 90 km/h into m/sec
- 2) 60 m/sec into km/h
- 3) 50 km/h into m/sec
- 4) Find the speed of a motorcyclist moves 150 km in 3 hours.

Extensional activities

- From Moses' to Nadia's residence, there are 160 km, they agreed to meet at a certain place. They left their homes at 8:00 a.m.. Moses had a speed of 30 km/h while Nadia had a speed of 20 km/h.
 - At what time did they meet?
 - What distance did each cover before they met?
- What distance did I cover if I drove from Kigali towards Huye for 2 hours at a speed of 55 km/h?

Answers to Application 8.1

- | | |
|-----------|------------------|
| 3:23 p.m | 06:45 |
| 6:45 a.m | 20:44 |
| 7:15 a.m | 15:23 |
| 12:12 p.m | 07:15 |
| 8:44 p.m | 12:12 |
- | | | |
|---------------|---|-------|
| (a) 6:07 p.m | = | 18:07 |
| (b) 12:15 p.m | = | 12:15 |
| (c) 11:45 a.m | = | 11:45 |
| (d) 7:05 p.m | = | 19:05 |

Answers to Application 8.2

- | | | | |
|--------------|--------------|--------------|--------------|
| (a) 16:21 hr | (b) 17:56 hr | (c) 09:12-hr | (d) 08:45 hr |
| (e) 00:46 hr | (f) 10:43 hr | (g) 13:59 hr | (h) 07:18 hr |
| (i) 03:14 hr | (j) 14:49 hr | (k) 17:00 hr | (l) 09:56 hr |

Answers to Application 8.3

- | | | | |
|---------------|----------------|---------------|----------------|
| (a) 4:12 a.m. | (b) 03:54 p.m. | (c) 6:32 a.m. | (d) 10:10 p.m. |
| (e) 1:23 a.m. | (f) 11:45 p.m. | (g) 5:15 a.m. | (h) 5:38 p.m. |
| (i) 1:38 p.m. | (j) 3:45 a.m. | (k) 7:40 p.m. | (l) 9:30 a.m. |

Answers to Application 8.4

- | | | | |
|---------------|---------------|----------------|----------------|
| (a) 2:00 a.m. | (b) 5:00 p.m. | (c) 10:00 a.m. | (d) 12:00 noon |
| (e) 9:00 a.m. | (f) 7:00 p.m. | (g) 12:00 a.m. | (h) 12:00 noon |

Answers to Application 8.5

- | | | | |
|---------------|---------------|--------------------|---------------|
| (1) 5:00 p.m. | (2) 8:00 p.m. | (3) 12:00 midnight | (4) 3:00 a.m. |
| (5) 2:50 p.m. | (6) 8 hours | | |

Answers to Application 8.6

- (1) 60 km/hr (2) 90 km/hr
 3) (a) 40 km/hr (b) 50 km/hr (c) 40 km/hr
 (4) 60 km/hr (5) 20 m/sec

Answers to Application 8.7

- 1) (a) 25 m/sec (b) $16\frac{2}{3}$ m/sec (c) 50 m/sec (d) 15 m/sec
 (e) 70 m/sec
 2) 200 m/sec 3) (a) 25 km/hr (b) $6\frac{17}{18}$ m/sec
 4) 15 m/sec 5) 20 m/sec

Answers to Application 8.8

- 1) (a) 54 km/hr (b) 162 km/hr (c) 90 km/hr (d) 360 km/hr
 2) 720 km/hr 3) 36 km/hr 4) 24 km/hr
 5) 36 km/hr 6) 144 km/hr

Answers to Application 8.9

- 1) 10 km 2) 24 km 3) 400 km
 4) 300 m 5) 120 km

Answers to Application 8.10

- 1) 3 hrs 2) 3 hrs 3) $1\frac{1}{2}$ hrs 4) 4 hrs

Answers to Application 8.11

- 1) 90 km, 70 km 2) 18 km/hr 3) After $2\frac{1}{2}$ hours
 4) 200 km 5) 30 km/hr

Answers to Application 8.12

- 1) 5 p.m. 2) 60 km/h 3) 180 km
 4) (a) 3 hrs (b) 120 km

Answers to Application 8.13

- 1) 40 km/hr 2) 60 km/hr 3) 96 km/hr 4) 42 km/hr
 5) 72 km/hr 6) $44\frac{2}{3}$ km/hr 7) 80 km/hr 8) 36 km/hr

End of unit 8 Assessment

- 1) (a) 10:00 a.m. (b) Angel's distance 60km, Karemera's distance 90 km
 2) 250 km 3) 25 m/sec 4) 8:30 hr
 5) (a) 140 km (b) 560 km
 6) (a) 60 km (b) 100 km 7) 80 km/hr 8) 39 km/hr
 9) 1:30 a.m. 10) 2:15 p.m.

Unit 9

Simple interest and problems involving saving

Key unit competence: To be able to work out simple interest and solve problems involving saving.

List of lessons

Lessons	Number of lessons	Number of periods
9.1 Calculating simple interest	1	2
9.2 More about calculating simple interest	1	1
9.3 Solving problems involving simple interest	1	2
9.4 Calculating interest rate	1	1
9.5 Solving problems involving interest rate	1	1
9.6 Calculating principle	1	1
9.7 Solving problems involving principle	1	2
9.8 Calculating time	1	1
9.9 Solving problems involving time	1	1
9.10 Calculating amount	1	2
9.11 Solving problems involving amount	1	2
9.12 Saving money in the Bank or investing it	1	1
9.13 Solving problems involving saving	1	2
End of Unit 9 Assessment	1	2
Total	14	21

Guidance on problem statement

This unit will be concerning simple interest and saving. This unit is mainly related to financial issues. Let learners know that they will need the application of this concept in daily life. Let them react to the introduction in the Learner's Book, page 151.

Cross-cutting issues

Throughout the teaching process of this unit, it will be crucial to help learners to master the content and it is better to address cross-cutting issues where possible. In this unit, we will address the following cross-cutting issues as non-stand alone within classroom activities and through the development of

the content. We will also emphasise on financial education as non-stand alone because this unit deals with money.

- **Peace and value education:** First of all, as a teacher you have to be a peace maker in your class and role model so that learners will imitate how you behave. When there is any conflict do not leave without helping to solve it within the lesson. Encourage learners to behave well, being humble, honest, etc.
- **Gender education:** This cross-cutting issue will be addressed through giving equal opportunities to both boys and girls during the lesson.
- **Financial education:** This should be addressed via problems that imply the ways of using money that encourages learners in saving and investing. Within this unit ,this cross-cutting issue should be focused on because emphasis should be put on money issues, in daily life.

Learning Objectives

Knowledge and understanding

- Define different terms such as simple interest, rate, principle and time.
- Explain the importance of saving.

Skills

- Appreciate the importance of saving in daily life.
- Appreciate the importance of simple interest in daily life situations.
- Show confidence when working out problems involving simple interest.

Attitudes and values

- Calculation of simple interest, rate, principle and time.
- Problems involving simple interest, rate, principle and time.
- Savings: saving money in the bank, or putting it in the investments.
- Problems involving saving and simple interest.

Number of lessons: 21

Guidance for classroom organisation

- Before you start the lesson, first use warm-ups or energizers in order to engage learners into the lesson. Do not focus on this only, try to be creative. The essence is to motivate the learners and make them active throughout the teaching- learning process.
- Help learners to form groups before you assign them an activity.
- While they are doing the activity, walk around while monitoring their work and helping where they have difficulties.

Learning and teaching materials for the Unit

Manila cards, scissors, markers and masking tape and other materials that a teacher may see as important to achieve his/ her objective.

Lesson 9.1 Calculating Simple Interest (80 minutes)

Learner's Book, page 151

Introduction

- Give simple calculations about saving money as mental work, for example, supposing you have 500 Frw and you spend 300 Frw. How much do you save?
- Distribute the learners in groups and give out sheets of paper to each groups.
- Introduce the lesson as calculating simple interest.

Development

- Guide the learners through the activity in the Learner's Book, page 151.
- Having sought the meaning of the terms, principal, time, rate and simple interest, check for their definitions.
- Distribute flashcards, some with the terms while others bear their definitions.

For example,

Time	Interest percentage of the principal	Interest rate
Length of time for which the money is borrowed or lent	Any money lent or borrowed	Principal

- Give one flash card to each group.
- Ask a group representative to flash a card, then request the other to respond by flashing a card matching with the former.
- Let the learners carry on the activity until all cards are matched.
- Now mix all the cards on your table.
- Ask individual learners to take turns in pairing a term card with a definition. Ensure that all learners are involved.
- Now conclude by the remarks:
 - Simple interest is the extra money paid to the money lender or bank customer or it is extra money paid by the bank or SACCO to the customer.
 - Principal is any money lent, borrowed or saved in a bank or SACCO.
 - Time is the period or length of time for which the money is borrowed, lent or saved.
 - Rate is the interest percentage of the principal. It can be per month or per year (p.a).
- Explain that the calculation they have just carried out was about calculating simple interest. So, simple interest = Principal × Time × Rate
- Display the chart with worked example.

- Ask the learners to identify the principal, time and rate.
- Let them follow through the working. Assist where necessary.
- Guide the learners through the examples.
- Explain that if time is given in months, express them in fractional years.
- And, if rate is given as a fractional percentage, change it to a common fraction.

e.g 6 months = $\frac{6}{12}$ of a year or $\frac{1}{2}$ of a year.

$$\text{Rate} = 7\frac{1}{2}\% = \frac{7 \times 2 + 1}{2 \times 100} = \frac{14 + 1}{200} = \frac{15}{200}$$

- Formulate more questions and ask learners to share in working them out.

Conclusion

- Discuss the Study tip then let the learners attempt Application 9.1.
- Explain situation where rates are per month and when rates are per year.
- Guide the learners especially the slow learners on how to express fractional percentages as common fractions.
- Teach problems involving simple interest following the same procedure each time taking note of rate and time.

Remedial Exercise

Let slow learners calculate the simple interest given that;

- (a) Principal is 20,000 Frw, time is 2 years, rate is 10% per year.
(b) principal is 30,000 Frw, time is 1 year, rate is 5% per year.
(c) Principal is 10,000 Frw, time is 2 years, rate is 20% per year.
- Kwizera deposited 50,000 Frw in a bank. He was given an interest rate of 10% per year. The money was in the bank for 2 years. What was the simple interest?

Additional Exercise

Let fast learners calculate more challenging questions on simple interest

- (a) What is the interest on 116,500 Frw after $2\frac{1}{2}$ years at $11\frac{1}{4}$ % per month?
(b) Calculate the simple interest on 2,04600 Frw after $5\frac{1}{4}$ years at 12% per year.
(c) An interest rate of $27\frac{1}{3}$ per year was offered on 3,069,000 Frw. If the time was 8 years, calculate the interest.
- Yudesi borrowed 10,640,000 Frw from Amavubi Savings and Credit Society. She was to pay back the money after $2\frac{2}{3}$ months at a rate of $6\frac{1}{2}$ % per year. Calculate the simple interest she paid back.

Lesson 9.2**More About Calculating Simple Interest (40 minutes)****Learner's Book, page 153****Introduction**

- Give a warm-up exercise of your choice to the learners.
- Review the previous work.
- Form groups among the learners.
- Let them get involved with the activity in Learner's Book, page 153.
- Collect answers from the groups and harmonise them to make a general report.

Development

- Explain the main competence of the lesson.
- Tell learners that sometimes, considering interest, time can be in months and interest in fractional percentages.

So, the months are expressed as fractions of 12 months of a year.

$$4 \text{ months} = \frac{4}{12} \text{ of a year or } \frac{1}{3}, \quad 6 \text{ months} = \frac{6}{12} \text{ or } \frac{1}{2} \text{ of a year.}$$

$$8 \text{ months} = \frac{8}{12} \text{ or } \frac{2}{3} \text{ of a year, } 3 \text{ months} = \frac{3}{12} \text{ or } \frac{1}{4} \text{ of a year.}$$

- Fractional percentages are expressed as fractions, that is:

$$2\frac{1}{3}\% = \frac{2 \times 3 + 1}{3} \div 100 = \frac{7}{3} \times \frac{1}{100} = \frac{7}{300},$$

$$12\frac{1}{2}\% = \frac{12 \times 2 + 1}{2} \div 100 = \frac{25}{2} \div 100 = \frac{25}{2} \times \frac{1}{100} = \frac{25}{200} \text{ and so on.}$$

- Give more examples of months and fractional percentages for learners to do more practice.
- Refer to the example in the Learner's Book, page 153.
- Considering the experience, the learners have been subjected to in handling months and fractional percentages, learners follow through as you guide them.
- Give similar examples in order to expose learners to more practice.

Example: Give that: Principle = 1,680,000 Frw, Interest rate = $12\frac{1}{2}\%$ and time = 8 months, calculate the simple interest

$$\begin{aligned} \text{Simple interest} &= P \times \frac{R}{100} \times T \\ &= 1,680,000 \times 12\frac{1}{2}\% \times \frac{8}{12} \\ &= 1,680,000 \times \frac{25}{200} \times \frac{8}{12} \\ &= \overset{5600}{1,680,000} \times \frac{25}{1200} \times \frac{8}{3} \\ &= 5,600 \times 25 = 140,000 \text{ Frw} \end{aligned}$$

Conclusion

- Let learners read Study tip several times to internalise it.
- Ask them to attempt Application 9.2, page 154.
- Mark the work and give feedback.
- Correct the mistakes in the calculations.
- Learners take notes.

Remedial Exercise

Slow learners attempt this work.

1. Convert to fractions.
 (a) $9\frac{1}{2}\%$ (b) $6\frac{1}{4}\%$ (c) $12\frac{1}{4}\%$ (d) $20\frac{1}{5}\%$
2. Convert to years.
 (a) 2 months (b) 4 months (c) 7 months (d) 9 months
3. Given that the principle is 10,000 Frw, rate is $12\frac{1}{2}\%$ and time is 6 months, find the simple interest.

Additional Exercise

Fast learners should attempt a more complex exercise.

1. Given; simple interest is 62,500 Frw, principle is 200,000 Frw and interest rate is $12\frac{1}{2}\%$, find time.
2. If principle is 1,460,000 interest rate is $17\frac{1}{2}\%$ and time is 15 months, calculate simple interest.

Lesson 9.3**Solving Problems Involving Simple Interest (80 minutes)**

Learner's Book, page 154

Introduction

- Review the methods of working out simple interest.
- Distribute learners in groups and let them carry out the activity in the Learner's Book, page 154.
- Guide them in getting the correct answers.

Development

- Explain that the method of work is the same as that they learned in the previous two lessons.
- Learners have to read and understand the vocabulary in the problem.
- Ask learners to read the examples in the Learners Book, page 155.
- Let them explain what they are required to do.
- Guide them through the procedure and answer their questions.
- Give learners chance to formulate their own problems.

Conclusion

- Let learners read the Study tip.
- Learners attempt Application 9.3, page 155.
- Mark the work and give feedback.
- Help with corrections and let learners take notes.

Remedial Exercise

Let slow learners attempt this work.

1. Zanika saved 20,000 Frw in a bank. The interest rate was 20% per year. It took 2 years. Calculate simple interest.
2. A P.6 boy was saving 5,000 Frw in a SACCO. He was offered an interest rate of 25% per year. He kept it for 1 year. How much was the interest?
3. Phyllis borrowed 8,000 Frw. She paid the money in 3 years. The interest rate was 10% per year. How much interest did she pay?

Additional Exercise

Let fast learners formulate six problems, then calculate them.

Lesson 9.4**Calculating interest Rate (40 minutes)****Learner's Book, page 156****Introduction**

- Review calculating simple interest.
- Ask learners to define the term "rate".
- Form groups and distribute sheets of paper.

Development

- Lead the learners in effecting the instructions in the activity in the Learner's Book, page 156.
- Help them to realise that:

$\frac{2,000 \times 100}{10,000 \times 1}$ is substituted from $\frac{\text{Interest} \times 100}{\text{Principal} \times \text{Time}}$

So, to calculate rate, we use $\frac{\text{S.I} \times 100}{P \times T}$

$$\text{Hence, Rate (R)} = \frac{\text{Interest} \times 100}{\text{Principal} \times \text{Time}}$$

From the above observation:

$$\text{Rate} = \frac{2,000 \times 100}{10,000 \times 1}$$

$$\text{Rate} = \frac{2 \times 10}{1 \times 1}$$

R = 20, but rate is a percentage, therefore, rate is 20% per year.

- Let learners form some more situations basing on the instructions in the activity.
- Evaluate the methods and results.
- Emphasise that, in order to calculate rate, the fraction of interest out of the

product of principal and time is expressed as percentage.

- Display a chart with examples similar to the ones in the Learner' Book, page 156.
- Let the learners follow through the two methods used.
- Explain that substitution is applied in method 2, then the unknown is formed.
- Refer to the examples in the Learner's Book, page 156.
- Let the learners read, study and follow through each example.
- Repeat the procedure several times until the learners master and internalise the two methods.
- Give more examples and let the learners work them out on sheets of paper. Move around checking for the correct methods and answers.
- Let learners formulate their own and exchange them among the different groups.

Conclusion

- Moderate the discussion about the methods, then evaluate accordingly.
- Let learners internalise the Study tip and then attempt Application 9.4.
- Explain to the learner's that money lent, borrowed or saved for short periods the rate may be per month and that for long periods is per year.

Remedial Exercise

Let slow learners calculate the rate as follows:

Find the rate percent (R) at which the interest on;

- (1) 1,000 Frw for 1 year is 200 Frw.
- (2) 5000 Frw for 2 years is 1000 Frw
- (3) Principal is 1,000 Frw , time is 5 months, simple interest is 100 Frw. Calculate the rate percent (R) per month.
- (4) After two years, Mrs mulisa paid an interest of 4,000 Frw. The bank had lent her 20,000 Frw . Calculate the rate (r)

Additional Exercise

Let fast learners try out the following exercise

Find the rate percent (R) given:

- (1) Principal is 450,000 Frw, Time is $\frac{1}{3}$ of a year, interest is 115,000 Frw.
- (2) Principal is 10,426,000 Frw, Time is $3\frac{1}{2}$ year , interest is 770,000 Frw.
- (3) Princile is 1,407,000 Frw, time is $1\frac{3}{4}$ years, interest is 64,800 Frw.
- (4) Tunga borrowed 12,000,000 Frw from a bank. He paid an interest of 600,000 Frw. He used the money for $3\frac{1}{3}$ months. What was the interest rate per year?
- (5) Ineza invested 2,800,000 Frw in a company . She was offered an interest of 144,000 Frw. She invested it for $1\frac{1}{2}$ months. Calculate the rate percent (R) per month.

Lesson 9.5**Solving Problems Involving Interest Rate (80 minutes)***Learner's Book, page 157***Introduction**

- Review calculating interest rate.
- Let learners form groups and guide them through the activity on page 157.
- Collect the different views and write them on chalkboard.

Development

- Harmonise all presentations from the activity and develop a general report.
- Learners have already learned about calculating interest rate.
- Develop this competence further through questions, answers and calculations.
- Explain that in order to work out problems correctly, they have to read, interpret and understand what is needed.
- Ask learners to read the examples in the Learner's Book, page 157.
- Help them to perfect the reading skill.
- Let them explain the procedure and the method to be used.
- Let them follow through the calculations intently. They should ask questions where they have not understood. Explain to their satisfaction.
- Write an example on the chalkboard.
- Ask learners to read and interpret it. Then try with the calculation.
Example: Three business partners wanted to boost their business. They sought for a loan of 4,800,000 Frw from a money lender. She offered them a monthly interest rate. If they invested the money for 8 months and paid an interest of 1,200,000 Frw, what was the interest rate offered?
- Tell learners to use any of the two methods.
- They are expected to observe that: principle = 4,800,000 Frw, interest = 1,200,000, time is 8 months and rate not given.
- In interpretation of the context, learners should realise that rate is per month, not per year, So, months are multiplied directly, not changed into years.

$$\begin{aligned} \text{Interest Rate} &= \frac{\text{Simple interest} \times 100}{\text{Principal} \times \text{Time}} \\ &= \frac{1,200,000 \times 100}{4,800,000 \times 8} \\ &= \frac{25}{8} = 4\frac{5}{8}\% \end{aligned}$$

- Learners formulate their own problems, calculate the interest rate and present their answers for evaluation.

Conclusion

- Let learners read the Study tip.
- Let them attempt Application 9.5.
- Mark their work and give feedback.
- Help them do corrections if any, then take notes.
- Give more problems to all learners as extra exercise to do more practice. The extra exercise may be given as an assignment or homework.

Lesson 9.6

Calculating Principal (40 minutes)

Learner's Book, page 159

Introduction

- Review saving money, then calculating rate.
- Distribute the learners in groups. Hand out sheets of paper to the learners.
- Let the learners carry out the activity in the Learner's Book, page 159 as you guide them through.

Development

- Concur with them by stressing that, in order to calculate principal, interest is divided by the product of rate and time. Then the fraction is multiplied by 100.

$$\text{Principal} = \frac{\text{Simple interest} \times 100}{\text{Rate} \times \text{Time}}$$

- You should explain the concept clearly and comprehensively so that learners do not become confused.
- Learners can also use another method which is; $S.I = P \times T \times \frac{R}{100}$ then substitute to find the principal.
- Display the chart with worked example.
- Guide the learners through the two methods applied, that is;

$$S I = P \times T \times \frac{R}{100} \quad \text{and} \quad P = \frac{S I \times 100}{T \times R}$$

- Be systematic such that the learners grasp the concept.
- Refer to the example in the Learner's Book. page 159. Learners should lead in explaining the flow of the steps. Help them where they get challenges.

Conclusion

- Give more examples for learners to practise more. This will enable them to master the concept.
- Tell them to read the Study tip and later, attempt the Application that follows.

- Mark their work and help them do corrections.
- Be thorough when explaining about fractional rates and time in months.
- Explain terms and words so that the learners improve their vocabulary.

Remedial Exercise

Slow learners should try out the exercise that follows:

Calculate the principal if;

- (1) Interest is 20,000 Frw , time is 1 year, rate is 20% per year.
- (2) Interest is 5,000 Frw , time is 2years, rate is 10% per year.
- (3) Butare got an interest of 4,000 Frw. He lent the money for $\frac{1}{2}$ of a year. How much did he lend out?
- (4) An interest rate of 20% was offered for a certain amount. Ineza borrowed the amount for 2 years. She paid 15,000 Frw as interest. How much did she borrow?

Additional Exercise

Fast learners can work out the following exercises:

Find the principal, given that:

- (1) Interest is 120,120 Frw time is 6 months, rate is $7\frac{1}{2}\%$ per year.
- (2) Interest is 240,800 Frw time is 8 months, rate is $12\frac{1}{2}\%$ per year.
- (3) Interest is 4,168,400 Frw time is $2\frac{1}{3}\%$ months, rate is $7\frac{1}{2}\%$ per month.
- (4) At a rate of 3% per annum, Ingabire got 217,770 Frw as interest for the money she had deposited. The money lasted for $3\frac{1}{2}\%$ years in the bank. How much was the deposit?
- (5) A co-operative society borrowed money from a bank. It had to pay back 5,642,865 Frw as interest. The rate was 20% per month. The money was on the account for $2\frac{1}{4}\%$ months. How much did the society borrow?

Lesson 9.7

Solving Problems Involving Principle (80 minutes)

Learner's Book, page 160

Introduction

- Give a warm-up exercise to learners as you may decide.
- Review work done on calculating principle.
- Group learners and let them do the activity in the learner's Book.
- Moderate the outcome to get a general result.

Development

- Learners have already learned finding principle. This lesson is a continuation, only that it involves the use of descriptive words.
- Ensure learners read and understand the meaning of the problem. This will enable them interpret, understand and work out the problems correctly.
- Ask them to read repeatedly the examples in the Learner's Book.
- If the concept was well perceived in the previous lesson, learners will not get difficulties in working out the questions provided.
- Give examples for the learners to practice more.
- Let them formulate their own problems and work them out.

Conclusion

- Let learners read the Study tip.
- Ask them to Attempt Application 9.7 in the Learner's Book.
- Mark their work and help them do corrections.
- Let them take notes in their exercise books.
- Give extra work in form of revision exercise. This will help learners to do more practice and also improve their vocabulary.
- The revision exercises may be given as assignments or homework.

Lesson 9.8**Calculating Time (40 minutes)****Learner's Book, page 161****Introduction**

- Review the previous work.
- Form manageable groups and distribute sheets of paper.
- Ask the learners to read, then carry out the activity as instructed in the Learner's Book, page 161. Guide them in doing so.

Development

- Explain that, to find time, simple interest is divided by the product of principal and rate. that is;

$$\text{Time} = \frac{\text{Simple interest}}{\text{Principal} \times \text{Rate} \%} \text{ or } \frac{\text{Simple interest}}{\text{Principal} \times \frac{\text{Rate}}{100}} \text{ or } \frac{\text{Simple interest} \times 100}{\text{Principal} \times \text{Rate}}$$

- Further explain that the formula for finding simple interest can be used, then substitution done to find the unknown time.
- Display the chart with worked examples.

Example: Uwase invested 1,360,000 Frw in a company. She was offered 680,000 Frw as interest at a rate of 20% per year. For how long did she invest the money?

Working**Method 1**

Principal is 1,360,000 FRW

Interest is 680,000 FRW

Rate is 20% per year

Time is ?

Simple interest = Principal \times Time \times Rate

$$680,000 = 1,360,000 \times T \times \frac{20}{100}$$

$$680,000 \times 100 = 1,360,000 \times T \times \frac{20}{100} \times 100$$

$$\frac{680,000 \times 100}{1,360,000 \times \frac{20}{100}} = \frac{1,360,000 \times \frac{20}{100} \times T}{1,360,000 \times \frac{20}{100}}$$

$$\frac{5}{2} = T$$

So time was $2\frac{1}{2}$ Years

Method 2

$$\text{Time} = \frac{\text{Simple interest} \times 100}{\text{Principal} \times \text{Rate}}$$

$$\text{Time} = \frac{680,000 \times 100}{1,360,000 \times 20}$$

$$\text{Time} = \frac{5}{2}$$

So time was $2\frac{1}{2}$ Years

- Ask for any challenge, in case there is any, and explain to the satisfaction of the learners.
- Refer to the example in the Learner's Book, page 162.
- Let learners follow through the steps. Explain further whenever there is a challenge.
- If the learners have grasped the concept, give them some more examples for group discussion then make presentations.

Conclusion

- Let learners discuss the Study tip before attempting Application 9.8.
- Explain clearly how 100 becomes multiplied by simple interest in method 2.
- Though both methods are equally applicable, it is up to the learners to opt for any method.
- Explain exhaustively when calculating time, given fractional rates.
- In case the majority of the learners fail to grasp the concept comprehensively, repeat the same subtopic in the next lesson using different examples.

Remedial Exercise

Let slow learners try out the following;

1. In what time will 5,000 Frw yield on interest of 1,000 Frw at 10%?
2. A P.6 learner saved 4,000 Frw in a savings and credit society. She was given 1,000 Frw as interest. The rate was 20% per year. How long was the money saved?

3. In what time will 10,000Frw gain 2,000 Frw at a rate of 10% per year?
4. Mulenzi borrowed 6,000 Frw. He paid back 3,000 Frw at rate of 50%. For how long did he use the money.

Additional Exercise

Fast learners can work out more challenging questions for more practice.

1. In what time will 234,120 Frw yield 780,400 Frw at a rate of 25% p.a?
2. Lwakabamba invested 2,178,000 Frw. He was given 363,000 Frw as interest. If the rate was 20% per year, what time was the money invested?
3. In what time will 360,000 Frw amount to 480,000 Frw at 50% per year?
4. Calculate the time in which 4,800,000 Frw will amount to 6,000,000 Frw at $2\frac{1}{2}$ % per year.

Lesson 9.9

Solving Problems Involving Time (40 minutes)

Learner's Book, page 163

Introduction

- Review the previous work.
- Form groups. Ensure you mix multi-ability learners with slow learners.
- This enables the slow learners to benefit from the fast learners.

Development

- Distribute sheets of paper to individual groups and guide the learners as they work out the activity in the Learner's Book, page 163.
- Since they have covered each term independently, there won't be any difficulties in working out the problems paused.
- Now let the learners follow through the examples in the Learner's Book, page 163.
- Ensure learners read and understand what they are supposed to do.
- Give some more examples for more practice in groups and later allows each group to present their work.
- This will help them to internalise the concept.

Conclusion

- Conclude by asking the learners to read the Study tip and later, attempt the Application that follows.
- Mark their work and help them do corrections.
- Give more work to learners as assignments or homework.

Lesson 9.10 Calculating amount (80minutes)

Learner's Book, page 164

Introduction

- Give mental work about simple subtractions. For examples, 25 - 15, 100 - 91, 50 - 12 and so on.
- Review the previous lesson.
- Distribute learners in groups and hand out instructional materials.
- Let learners get involved in working out the activity in the Learner's Book.

Development

- Explain that the activity was about finding amount.
- Tell learners that amount is the total amount of money realised after adding principle and simple interest.
- Explain that businesses work on this principle to balance their books.
- Account balance on one's account is one way amount is applied in daily life.
- Write an example on the chalkboard and ask learners to copy it on slips of paper, then attempt it.

Example: Ntwari deposited 2,400,000 Frw on his account in a bank. He was offered an interest rate of $33\frac{1}{2}\%$ per year. How much was on his account 2 year later?

Let learners observe the principle, rate and time as earlier experienced.

$$\begin{aligned} \text{Simple Interest} &= \text{Principle} \times \frac{\text{Rate}}{100} \times \text{Time} \\ &= 2,400,000 \times \frac{100}{300} \times 2 \\ &= 800,000 \times 2 \\ &= 1,600,000 \text{ Frw} \end{aligned}$$

- Explain further that to get amount, simple interest is added to principle.

$$\begin{aligned} \text{Amount} &= \text{Principle} + \text{Simple interest} \\ &= 2,400,000 \text{ Frw} + 1,600,000 \text{ Frw} \\ &= 4,000,000 \text{ Frw} \end{aligned}$$

Therefore, 2 years later, Ntwari had 4,000,000 Frw on his account.

Conclusion

- Let learners read and internalise the Study tip.
- Learners attempt Application 9.10 in the learners Book.
- Mark their work and help them do corrections.

Remedial Exercise

Slow learners attempt this work.

1. Ali borrowed 1,000,000 Frw from a SACCO. He was offered an interest rate of 10% per year. He paid 1 year later. How much did he pay back altogether?
2. Given; Principle = 20,000 Frw, time = 2 years, rate = 20%. Find the total amount.
3. Given; time = 3 years, principle = 50,00- Frw and rate = 50%. Find the amount.

Additional Exercise

Fast learners should attempt a more complex exercise.

1. Given; principle = 4,920,000 Frw, interest rate = $12\frac{1}{4}\%$ p.a and time = $1\frac{1}{3}$ years, calculate the amount.
2. If time is 9 months, interest rate is $7\frac{1}{2}\%$ and principle is 1,440,000 Frw, find the amount.
3. Given; interest rate is $37\frac{1}{2}\%$ p.a, principle is 9,660,000 Frw and time is 2 years 8 months, find the amount.
4. Given; rate is $9\frac{1}{4}\%$ p.a, time is 1 year 9 months and principle is 2,880,000 Frw, calculate the amount.

Lesson 9.11**Solving Problems Involving Amount (80 minutes)**

Learner's Book, page 165

Introduction

- Review the previous lesson.
- Group learners and provide them with learning materials.
- Guide learners through the activity.

Development

- Let different groups participate in the role-play.
- Discuss the various outcomes from separate groups.
- You may reward the group that demonstrates better than others.
- Explain that the main concept of this lesson, is to read and interpret the information that is provided in the problem.
- In the previous lesson, learners worked out amount.
- This one is a repeat of the former lesson, but involving the use of words to be interpreted.
- Guide them through the example in Learner's Book, page 166.
- Emphasise the importance of reading and understanding the words

used in the problem.

- Let learners formulate their own problems involving amount.
- Move around while you monitor their work, then give conclusive remarks.

Conclusion

- Let learners read the Study tip.
- They should attempt Application 9.11 in their exercise books.
- Mark their books and help them do corrections.
- After corrections, let them take notes.
- Give learners more work to be done as homework or revision work.
- Ensure all learners attempt it. It is so because it enables learners to practise more.
- After marking it the next day and give feedback.

Lesson 9.12

Saving Money in the Bank or Putting it in Investments (40 minutes)

Learner's Book, page 167

Introduction

- Introduce the lesson by reviewing and previewing money and its financial application, done in primary 4 and primary 5.
- Review work done in Primary 5 about budgeting, spending and saving money.
- Ask learners to form groups.
- Distribute the prepared pretend money amounting to 20,000 Frw in different denominations to each group.
- Inform learners that they are going to learn about saving money.
- In their groups let learners discuss how they can spend the amount they possess and how saving can be done on the same amount.
- Distribute flash cards or Manila cards to each groups.

Development

- Ask each group to write different ways of saving from 20, 000 Frw.
- Remind them that they should not spend beyond their means. That will be wasting money.
- So, they should at least save some little money from 20,000 Frw for future use.
- Guide them thoroughly through the activity as explained in the Learner's Book, page 167.

Example: You are aware that successful people, institutions and businesspeople save money in the banks or in investments.

- (a) Suppose you are given 20,000 Frw, write down different ways of saving from it.

(b) Discuss and give an example of the following:

i) the advantage of saving money in the banks.

ii) the advantages of putting money in investments.

- Then, let them make a presentation in class.
- Prevail to give here and there, as you guide the learners.
- Explain that, in real life, we should not spend all the money we receive.
- Some is spent on priorities, as was learnt in P.5 and some of it is saved.
- The money saved is called savings.
- Give an example of how you would spend 20,000 Frw and how you would save from it.
- Show that the savings should be reasonable, but not kept just for the sake of it.
- Refer to the example in the Learner's Book, page 167 and 168.
- Let the learners discuss them.

Conclusion

- Let them read and discuss the Study tip.
- Ask learners to attempt Application 9.12.
- Mark their work and help learners do corrections.
- Let learners summarise the lesson
- Give them time to write summary in the note book.
- Encourage learners always to save from the petty cash the parents give them for eats at school or pocket money.
- Emphasise that it is advisable never to spend all the money one gets or receives.
- Ask slow learners to write the different ways of saving from 5,000 Frw. Guide them in the exercise.
- In case the fast learners are given 50,000 Frw , ask them to write different ways of saving from it.

Lesson 9.13

Solving Problems Involving Savings and Simple Interest (80 minutes)

Learner's Book, page 169

Introduction

- Let learners brainstorm about the importance of saving money.
- Review the previous work.
- Distribute learners in manageable groups and distribute sheets of paper to each groups.
- Ask them to write down the places where money saved can be kept.
- Assess the list.

Development

- In case the school can access places where saving are deposited, lead the learners through the activity in the Learner's Book, page 169.
- Access accounts balance sheets, in case the learners cannot access savings places.
- Moderate the discussion, guiding where necessary.
- Explain that savings should be kept in banks, savings cooperative societies (Sacco's) or in investments.
- It is done so to keep one's savings safe, because these places offer security.
- Explain further that banks, Saccos or investments have another advantage of offering interest.
- Display the chart with prepared account balance statement.
- Let the learners study it critically, then explain the content.
- Explain that every date the savings are deposited in the bank, records of receipt are made. And every month or year an interest is calculated and added to the savings.
- Any time a saver wants to know how much he/she has on the account, he/she is given a slip of paper showing the total saving and total interest accrued. The sum is the account balance. The slip of paper is the account statement.
- Refer to the Learner's Book and guide the learners as they study the examples.
- Guide them through the procedure.
- Explain in detail how shares in investment benefit the share holders.
- Advise the learners that when they grow and start earning money, they should always save some. And savings should be kept in banks, SACCOS or investment.

Conclusion

- Lead them to internalise the Study tip.
- Ask the learners to attempt Application 9.13.

Remedial Exercise

Let slow learners calculate the total savings.

1. Kayabo is a teacher. He saves 10,000 Frw every month. How much does he save in 4 months?
2. Uwera is a meat seller. She saves 5,000 Frw every week. How much does she save in 3 months?
3. Umar is a taxi driver. He saves 1,000 Frw daily. How much does he save in 6 weeks?

Fast learners can work out more challenging questions.

Additional Exercise

1. Rebecca saves 46,500 Frw every fortnight. She is offered an interest of 3,000 Frw every month. What is her account balance after $3\frac{1}{2}$ months?
2. Savings amounting to 946,000 Frw were deposited in a bank. This was done every month. The bank offered an interest of 37,000 Frw every month. How much was on the account after one year and 2 months?
3. Hadija is a trader. She deposits 112,500 Frw on her account every fortnight. The bank offers her 6,000 Frw every month. How much would be on her account after $2\frac{1}{2}$ years?

Answers to Application 9.1

- (1) 20,000 Frw (2) 234,000 Frw (3) 480,000 Frw
 (4) 360,000 Frw (5) 1,200,000 Frw (6) 972,000 Frw

Answers to Application 9.2

- (1) 15,000 Frw (2) 1,557,750 Frw (3) 74,250 Frw (4) 240,000 Frw
 (5) 62,500 Frw (6) 19,085 Frw (7) 319,375 Frw (8) 69,000 Frw

Answers to Application 9.3

- (1) 2,500 Frw (2) 72,000 Frw (3) 17,500 Frw (4) 180,000 Frw
 (5) 19,500 Frw (6) 240,000 Frw

Answers to Application 9.4

- (1) $8\frac{1}{3}\%$ (2) $3\frac{1}{8}$ (3) 25% (4) 20%
 (5) 2% (6) 5% (7) 5% (8) $3\frac{1}{3}\%$

Answers to Application 9.5

- (1) $6\frac{1}{4}\%$ (2) 10% (3) 10% (4) $17\frac{1}{2}\%$ (5) 2%

Answers to Application 9.6

- (1) 50,000 Frw (2) 2,000,000 Frw (3) 500,000 Frw (4) 72,000 Frw
 (5) 250,000 Frw (6) 320,000 Frw (7) 82,000 Frw (8) 120,000 Frw

Answers to Application 9.7

- (1) 20,000 Frw (2) 95,000 Frw (3) 162,500 Frw (4) 320,000 Frw
 (5) 1,450,000 Frw (6) 800,000 Frw (7) 200,000 Frw

Answers to Application 9.8

- (1) 2 years (2) 1 year (3) 8 months (4) 6 months
 (5) 1 year (6) 61 year (7) 10 years (8) 6 months

Answers to Application 9.9

- (1) 1 year (2) 5 years (3) 1 years (4) $2\frac{1}{2}$ years
 (5) 6 years (6) 2 years

Answers to Application 9.10

- (1) 1,400,000 Frw (2) 2,0722,000 Frw (3) 4,979,000 Frw
 (4) 437,000 Frw (5) 1,754,400 Frw (6) 2,437,500 Frw
 (7) 2,043,750 Frw (8) 1,279,000 Frw (9) 3,680,000 Frw
 (10) 1,132,800 Frw (11) 588,000 Frw (12) 1,530,000 Frw

Answers to Application 9.11

- (1) 991,200 Frw (2) 2,580,000 Frw (3) 1,650,000 Frw
 (4) 2,160,000 Frw (5) 1,530,000 Frw (6) 295,680 Frw
 (7) a) 400,000 Frw b) 1,400,000 Frw (8) 9,750,000 Frw

Answers to Application 9.12

- (1) Teacher's discretion (2) 52,500 Frw
 (3) a) 401,000 Frw b) 13,208,000 Frw
 (4) 1,608,000 Frw (5) a) 1,750,000 Frw b) 16,800,000 Frw
 (6) a) 4,800,000 Frw b) 8,800,000 Frw

Answers to Application 9.13

- (1) a) 780 US dollars b) 4,280 US dollars (2) 504,000 Frw
 (3) a) 540,000 Frw b) 640,000 Frw (4) 340,000 Frw
 (5) 50,000 Frw (6) 164,000 Frw
 (7) a) 225,000 Frw b) 14,225,000 Frw 8) 1,680,000 Frw

End of Unit Assessment

- | | | |
|---------------------|-----------------------|---------------------------|
| (1) 45,000 Frw | (2) 45,000 Frw | (3) 4 years |
| (5) 2 years | (6) 400,000 Frw | (7) 619,800 Frw |
| (8) 52,000 Frw | (9) $37\frac{1}{2}\%$ | (10) Teacher's discretion |
| (11) 8,548,000 Frw | (12) 9,816,000 Frw | (13) 5% |
| (14) a) 480,000 Frw | (15) a) 180,000 Frw | b) 660,000 Frw |

Unit 10

Equivalent expressions and number sequences

Key unit competence: To be able to write sequences of whole numbers, fractions and decimals.

List of lessons

Lessons	Number of lessons	Number of periods
10.1 Algebraic Expressions	1	2
10.2 Equivalent Expressions	1	2
10.3 Finding the missing consecutive Numbers	1	2
10.4 Finding the missing consecutive fractions and decimals	1	2
10.5 Finding the general term/rule of a linear sequence.	1	2
10.6 Finding the general term/rule of a linear sequence for fractions and decimals.	1	2
10.7 Finding the missing Number or n^{th} term in Linear sequence.	1	2
10.8 Finding the missing fraction or n^{th} term in Linear sequence.	1	2
10.9 Finding the Number sequence using the General term/rule	1	2
End of Unit 10 Assessment	1	2
Total	10	20

Guidance on problem statement

With in this unit, learners should be able to apply sequences in daily life. The competence of this unit is regarded to the order of things.

Let learner think about the concept of sequencing and equivalent expressions. Let them go through the introduction in the Learner's Book, page 173.

Cross-cutting issues

Throughout the teaching process of this unit, it will be crucial to help learners to master the content and it is better to address cross-cutting issues where possible.

In this unit, we will address the following Cross-cutting issues as non-stand alone within classroom activities and through the development of the content.

- **Peace and value education:** First of all as a teacher, you have to be a peace maker in your class and role model so that learners will imitate how you behave. When there is any conflict do not leave without helping to solve it within the lesson. Encourage learners to behave well, being humble, honest, etc.
- **Gender education:** This cross-cutting issue will be addressed through giving equal opportunities to both boys and girls during the lesson. Make sure all learners have the same right.

Learning objectives

Knowledge and understanding

- Give examples of algebraic expressions and equivalent expressions.
- Explain how to find the rule for determining the n^{th} term in a linear sequence.

Skills

- Perform operations on algebraic expressions and explain why 2 expressions are equivalent.
- Calculate the n^{th} term in a linear sequence.
- Find the missing number in a linear sequence following a particular rule.

Attitudes and values

- Appreciate the importance of orderliness in finding out different terms of a linear sequence and extend it to real life situations.
- Show concern towards the faithfulness to the group members.

Number of lessons: 20

Guidance for classroom organisation.

- Before you start the lesson, first use warm ups or energizers in order to engage your learners into the lesson. Do not focus on this only, try to be creative. The essence is to motivate the learners and make them active throughout the teaching- learning process.
- Help your learners to form group before you assign them the activity.
- While they are doing the activity, walk around while monitoring their work and helping where they have difficulties.

Learning and teaching materials for the Unit

Manila cards, scissors, markers and masking tape and other materials that a teacher may see as important to achieve his/her objective.

Lesson 10.1 Solving Algebraic Expressions (80 minutes)

Learner's Book, page 173

Introduction

- Give mental work about the meaning of some mathematical algebraic expressions.
 $a + 5 = 10$, what is the value of a ?
 $4 + b = 12$, what is the value of b ?, etc
- Form groups among the learners.
- Distribute the suggested instructional materials.
- Introduce the activity to the learners.
- Prevail during the discussion and when the learners present their findings.

Development

- Refer to the prepared chart.
- Explain the meaning of the stated algebraic expressions.
- Let the learners study, read and explain the meaning of the algebraic expressions as given.
- Ensure they read repeatedly in order to grasp the meaning.
- Give some more examples on the chalkboard.
- Let the learners copy the examples on slips of paper.
- Challenge them to read, then write their meaning.
 Example: $4(3p - 5)$
- It means 4 multiplied by the product of 3 and p minus 5.
- Let learners give several other ways of reading and writing algebraic expressions.
- Ask the learners to formulate their own algebraic expressions on flash cards. Let one group member flash a card, then the other group members reads the algebraic expression.
- Let them play an inter-groups game, flashing cards with written meaning of algebraic expressions while other group members flash the card with written algebraic expressions.

Example

$3k - 1$ \longrightarrow multiply k by 3 and subtract 1 from the product

5 subtracted from the sum of n and 4 \longleftarrow $(n + 4) - 5$

- There are many different ways of reading/writing the meaning of the given algebraic expressions.
- Try to exhaust them, advising about the correctness of the English language use.

Conclusion

- Let the learners read loudly the Study tip.
- Afterwards, ask them to do Application 10.1.
- Mark their work and help them do corrections.

Remedial Exercise

Let slow learners try out the following:

- | | | | |
|-------------|---------------|-------------|-------------|
| (1) $d + 1$ | (2) $k - 2$ | (3) $p + 6$ | (4) $x + 4$ |
| (5) $3x$ | (6) $2p$ | (7) $4y$ | (8) $9q$ |
| (9) $10m$ | (10) $2x + 1$ | | |

Additional Exercise

Let fast learners write the meaning of the following algebraic expressions.

- | | | |
|----------------------------|--------------------------------|-----------------------------------|
| (1) $\frac{3(4y - 5)}{2y}$ | (2) $6(2p + 3) \div 3$ | (3) $\frac{n - 3}{n + 2}$ |
| (4) $\frac{1}{2}n(2n + 4)$ | (5) $\frac{3}{5}(5q + 10) - 3$ | (6) $4 \div \frac{1}{4}(p - 3)$. |

Lesson 10.2**Equivalent Expressions (80 minutes)****Learner's Book, page 174****Introduction**

- Give mental work about, filling in the missing number.
- eg $\boxed{4} + \boxed{?} = 10$, $\boxed{?} + 7 = 11$ and so on
- Review the previous work.
- Organise the learners in manageable groups and refer to the activity in the Learner's Book, page 174.
- Facilitate the discussion.

Development

- Display the chart with worked examples. Guide the learners through the procedure.
- Write an example on the chalkboard. Ask learners in their groups to attempt it on slips of paper.

$$\text{Example: } 6(x + 2) = 3(2x + 4)$$

- Ask learners in their groups to remove the brackets.

$$6 \times x + 6 \times 2 = 3 \times 2x + 3 \times 4$$

$$6x + 12 = 6x + 12 \text{ (Both expressions are equivalent)}$$

- Now refer to the examples in the Learner's Book.
- Let the learners follow through them, as you guide them.
- Write some examples on the chalkboard. Then ask the learners to find their equivalent expressions.

- Give learners a chance to find expressions that are equivalent to the given statements.
- Move around assessing their work and helping those with difficulties.
- Learner's involvement is very crucial in the learning process.
- Ensure all the learners are actively involved.
- A lot of practice is necessary because some learners may find it challenging.

Conclusion

- Let the learners read and internalise the Study tip.
- Let them attempt Application 10.2.
- Mark their work and help them do corrections.

Give them more work to try out in their free time. Distribute work into 2 categories. The first for learners who are slow and other that are the fast.

Lesson 10.3

Finding the Missing Number (80 minutes)

Learner's Book, pages 175

Introduction

- Review the previous lesson.
- Group learners and distribute instructional materials you organised for the lesson.
- Using sheets of paper, let the learners work out the activity as instructed in the Learner's Book, page 175.
- Guide them in case of any challenge.

Development

- Write an example on the chalkboard.
- Let the learners copy it onto slips of paper provided, then try to work it out.

Example:

Find the missing numbers in the sequence

3, 10, 17, 24, 31, ____, ____, ____, ____?

Working

Find the common difference

$(10 - 3 = 7)$, $(17 - 10 = 7)$, $(24 - 17 = 7)$, $(31 - 24 = 7)$,

- The common difference is 7.
- So add 7, to find the missing consecutive numbers.
 $35 + 7 = 42$, $42 + 7 = 49$, $49 + 7 = 56$, $56 + 7 = 63$.
- Therefore the missing numbers are 42, 49, 56 and 63.
- The explanation is extended for the learner's benefit to understand.
- All is summarised in the examples in the Learner's Book, page 176.

- Let the learners follow through the procedure, make discussion then share the outcomes with other groups.
- Let learners suggest their own sequences such that they have a common difference.
- Groups may challenge each other in working out the n^{th} term as you guide them.
- They should cross-check the correctness of their work by listing all the terms.
- Start with simple sequences to enable the learners to understand easily.
- In each case, lead the learners to assess their work by listing all the terms to the required term. Both terms must concur.

Conclusion

- Let the learners read the Study tip aloud several times in order to internalise it.
- Let learners do the Application 10.3.
- Let them take notes.

Remedial Exercise

Guide slow learners with simple numbers

1. List to the 6th term in the sequence: 2, 4, 6, 8,
2. List to the 7th term in the sequence: 1, 3, 5, 7,
3. List to the 10th term in the sequence: 9, 11, 13, 15,
4. List to the 12th term in the sequence: 3, 7, 11, 15,

Prepare more questions to help fast learners

1. Find the 21st term in the sequence: 2, 7, 12, 17,
2. Find the 49th term in the sequence: 1, 12, 23, 34,
3. What is the 101st term in the sequence: 11, 34, 57, 80,
4. Work out the 155th term in the sequence: 7, 16, 25, 34,
5. Find the 185th term in the sequence: 3, 10, 17, 24, 31,

Lesson 10.4

Finding the missing Consecutive Fractions and Decimals (80 minutes)

Learner's Book, page 177

Introduction

- Give mental work about finding consecutive numbers.
For example: (a) 0, 2, 4, 6, _____, _____, _____, _____.

(b) 1, 3, 5, 6, _____, _____, _____, _____.

(c) 1, 4, 9, 16, _____, _____, _____, _____.

(d) 2, 8, 14, 20, _____, _____, _____, _____.

- Review in detail finding missing consecutive numbers of as learned in the previous lesson.
- Let learners go into groups.
- Let them be engaged in the activity in the learner's Book, page 177.

Development

- Explain the main concept of the activity as finding the missing consecutive fractions.
- Tell learners that, as was done in the previous lesson, also consecutive fractions and decimals can be worked out.
- Display a chart with worked examples.
- Let learners follow the order of increase in them, then confirm the general answer in the conclusion.
- Write an example on the chalkboard. Tell learners to copy it onto slips or sheets of paper you provided, then attempt it.

Example: Find the missing fractions.

1, $1\frac{1}{4}$, $1\frac{1}{2}$, $1\frac{3}{4}$, _____, _____, _____, _____.

- Learners should first work out the order of increase. This is done by finding a common difference between neighbouring fractions.

Order of increase is: $d\frac{1}{4} - 1 = \frac{1}{4}$, $d\frac{1}{2} - 1\frac{1}{4} = \frac{1}{4}$, $d\frac{3}{4} - 1\frac{1}{2} = \frac{1}{4}$

So, the 5th fraction is found by adding $\frac{1}{4}$ to $1\frac{3}{4} = 2$.

The 6th fraction is found by adding $\frac{1}{4}$ to $2 = 2\frac{1}{4}$ and so on.

- Carry out the same method with decimals.
- Give some examples about finding the missing decimals.
- Let learners carry out the activity in the Learner's Book.
- Refer learners to the example in the Learner's Book.
- Explain with emphasis the changing values in the place values of decimals e.g. $0.8 + 0.3 = 1.1$, not 0.83 .
- Give learners chance to formulate their own number sequences of fractions and decimals.
- Monitor their working out as you move from group to group.

Conclusion

- Let learners read the Study tip.

- They should now attempt Application 10.4.
- Mark their work and help them in doing corrections.

Remedial Exercise

Slow learners should attempt the exercise below:

Find the missing fractions in the sequence.

- (a) $\frac{1}{2}$, 1, $1\frac{1}{2}$, 2, _____, _____, _____, _____.
- (b) $\frac{1}{3}$, $\frac{2}{3}$, 1, $1\frac{1}{3}$, _____, _____, _____, _____.
- (c) 0.2, 0.4, 0.6, _____, _____, _____, _____.
- (d) 0.5, 1.0, 1.5, _____, _____, _____, _____.

Additional Exercise

Fast learners should formulate more fractional and decimal sequences of their own and find the missing ones.

Lesson 10.5

Finding the General Term/Rule of Linear Sequence (80 minutes)

Learner's Book, page 178

Introduction

- Review the previous work.
- Form groups.

Development

- Let the learners work out the numbers in the activity.
What is the rule for this number pattern? 80, 60, 40, ...
Use the statements below to work out:
 - subtract 20.
 - add 20.
 - divide 20.
 Explain your answer to the class.
- Challenge the learners to deduce a rule for finding a mentioned position of an even number.
- In case most fail, explain that the simplest way of finding the required even number by position is using a generalised rule ($2n - 2$).
Example: Find the 16th even number
 $n = 16$, so $(2n - 2) = (2 \times 16 - 2) = (32 - 2) = 30$
- Given an example from which to proceed.
Example: Find the generalised rule for the sequence: 0, 2, 4, 6, 8,

Step 1: Find the common difference

($2 - 0 = 2$), ($4 - 2 = 2$), ($6 - 4 = 2$), ($8 - 6 = 2$), so the common difference is 2.

Step 2: Multiply the position by the common difference.

1 st	2 nd	3 rd	4 th	5 th
0	2	4	6	8

Position number (n)	1 st	2 nd	3 rd	4 th	5 th
Term	0	2	4	6	8

1×2	2×2	3×2	4×2	5×2
$= 2$	$= 4$	$= 6$	$= 8$	$= 10$

Step 3: Compare the product and the term.

Note: Every term is 2 less than the product.

Step 4: If the position is n , and we multiply $n \times 2$ to get the product $2n$.

- To get the term, we get 2 less than $2n$.
- So the generalised rule for 0, 2, 4, 6, 8, n is $2n - 2$.
- Explain that, to find a general rule for a given sequence, multiply the position number (n) by the common difference. Then compare the gained product and the term. Mark the difference.
- It may require to subtract, add, square or any other method.
- Follow the experienced procedure to explain how to get a general rule.
- Refer the learners to the example in the Learner's Book, page 178.
- Let them follow through, discuss and share the procedure. Guide them where challenges arise.
- Give the learners more examples such that they do more practice.
- Prevail to help where they get challenges.
- Specify, (i) "common difference" and how to get it.
(ii) "Terms"
(iii) Comparison between the "product" and "term".
- At first some learners may be confused about the procedure. But, ensure thorough explanation with suitable examples that learners grasp the concept.

Conclusion

- Let the learner read and internalise the Study tip.
- Let them attempt Application 10.5.
- Mark their work and help them in doing corrections.

Lesson 10.6**Finding the General Term/Rule of Linear Sequence for Fractions and Decimals (80 minutes)****Learner's Book, page 179****Introduction**

- Give a warm-up exercise of your choice.
- Review the previous lesson.
- Let learners form groups and carry out the activity in the Learner's Book.

Development

- Learners are expected to have listed the missing fraction in the order:
1, $1\frac{1}{2}$, 2, $2\frac{1}{2}$, 3, $3\frac{1}{2}$, 4, $4\frac{1}{2}$, 5.
- They learn finding the order of increase in the previous lesson, for this matter, the increasing order is adding $\frac{1}{2}$ to the previous number.
- Applying the concept of finding the general rule, learners are expected to have worked out like this:

Order of term	1 st	2 nd	3 rd	4 th	n th
Term	1	$1\frac{1}{2}$	2	$2\frac{1}{2}$	n
	$1 \times \frac{1}{2} + \frac{1}{2}$	$2 \times \frac{1}{2} + \frac{1}{2}$	$3 \times \frac{1}{2} + \frac{1}{2}$	$4 \times \frac{1}{2} + \frac{1}{2}$	$n \times \frac{1}{2} + \frac{1}{2}$

So, $n \times \frac{1}{2} + \frac{1}{2}$ satisfied the order of increase.

Therefore, the general rule is: $\frac{1}{2}n + \frac{1}{2}$

- Give an example of a decimal and let learners try it.
Example: Find the general term/rule for the linear sequence:
0,2, 0.5, 0.8, _____, _____, _____, _____.
- Draw a table and fill it as follows:

Order of term	1 st	2 nd	3 rd	n th
Term	0.2	0.5	0.8	

- Learners discover that the order of increase is:
(0.5 - 0.2 = 0.3), (0.8 - 0.5 = 0.3)
(1 x 0.3 + 0.2 = 0.5) (2 x 0.3 + 0.2 = 0.8) (n x 0.3 + 0.2)
 $n \times 0.3 + 0.2 = 0.3n + 0.2$
The general rule is $0.3n + 0.2$

- Lead learners to find other general rules for fractions and decimals from other examples.
- Let them study and follow through the example in the Learner's Book.

Conclusion

- Learners study and read the Study tip.
- Let them attempt Application 10.6
- Mark their work and help them do corrections.
- Let learners take notes.

Remedial Exercise

Let slow learners re-do Application 10.6 to master the concept.

Additional Exercise

Fast learners should attempt the exercise below:

Find the general term/rule for the linear sequences below:

- (a) 0.02, 0.05, 0.08, _____, _____, _____, _____.
- (b) 0.15, 0.19, 0.23, _____, _____, _____, _____.
- (c) 1.04, 1.08, 1.12, 1.16, _____, _____, _____, _____.
- (d) 0.33, 0.44, 0.55, _____, _____, _____, _____.

Lesson 10.7

Finding the Missing Number or n^{th} Term of Linear Sequence (80 minutes)

Learner's Book, page 181

Introduction

Review the previous work.

- Give learners oral activities concerning the previous lesson.
- Let them remember the main key concept of the first lesson.
- Facilitate learners in making groups.
- Distribute materials prepared to the learners.
- Let them do their task.

Development

- Take them through the activity.
Example: Find the generalised rule in the sequences 5, 8, 11, 14, 17, ...
- Let them discuss in their respective group.
- Facilitate their discussion with in the groups.
- Give them time to share with the whole class.
- Guide and orient their ideas.
- Write an example on chalkboard from the Learner's Book, page 181.

- Instruct them to work it out it.
- Let them try to correct it under your facilitation.
- Provide time to compare their working steps with the one from their note books.

Example: Find the 36th term in the sequence 2, 4, 6, 8, 10, 12, ...

The order = 1st, 2nd, 3rd, 4th, 5th, 6th, nth, 36th.

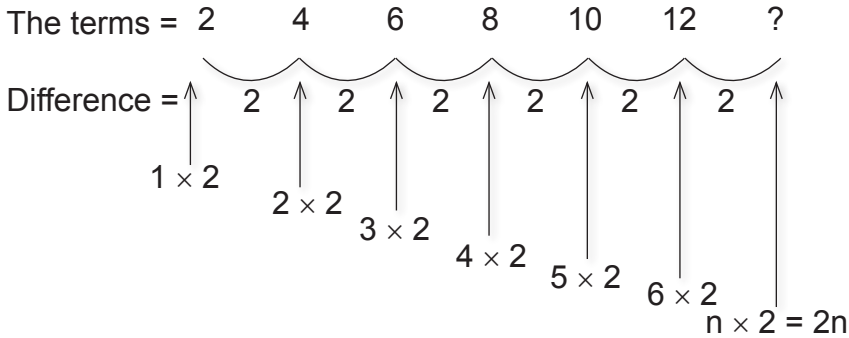

- Let them ask for clarification.

Conclusion

- Let them read Study tip in Learner's Book, page 181
- Let them do their own summary of the lesson.
- Help them to harmonize their work
- Take them through application in Learner 'S Book page 182
- Help them to make correction.
- Mark and give feedback, then they take notes.

Remedial Exercise

Let slow learners find the common difference for the sequences below.

- (1) a) 11, 13, 15, 17, 19, 21,
b) Multiply the position by the common difference.
- (2) a) 9, 13, 17, 21, 25, 29,
b) Multiply the position by the common difference
- (3) a) Find the 2nd even number
b) Find the 7th even number.

Additional Exercise

Let the fast learners find the generalised rule for these sequences.

- (2) 25, 34, 43, 52,
- (3) 49, 64, 79, 94,
- (4) 100, 121, 142, 163,
- (5) 55, 66, 77, 88,

Lesson 10.8**Finding the Missing Fraction or n^{th} Term in a Linear Sequence
(80 minutes)****Learner's Book, page 182****Introduction**

- Review the previous lesson.
- Distribute the learners in groups and hand them learning materials.
- Involve learners in the activity in the Learners Book.
- Monitor their working out, then harmonise their answers to come up with a general answer.

Development

- Explain that this lesson is a continuation of finding the general rule of linear sequence of fractions.
- Tell learners that in this lesson, it is the value of the number in the required place that is found.
- Write an example on the chalkboard:

Example: Find the 9th term in the sequence:

$$\frac{3}{4}, 1\frac{1}{2}, 2\frac{1}{4}, \text{---}, \text{---}, \text{---}, \text{---}.$$

- Ask learners to work out the order of increase.

$$\text{i.e. } d \frac{1}{2} - \frac{3}{4} = \frac{3}{2} - \frac{3}{4} = \frac{6}{4} - \frac{3}{4} = \frac{3}{4}p, \quad 2\frac{1}{2} - 1\frac{1}{2} = \frac{9}{4} - \frac{6}{4} = \frac{3}{4}p$$

- Let them order the terms, then find the general rule.

$$\text{i.e. } d \times \frac{3}{4} = \frac{3}{4}p, \quad 2 \times \frac{3}{4} = \frac{6}{4} = 1\frac{1}{2}p, \quad 3 \times \frac{3}{4} = \frac{9}{4} = 2\frac{1}{4}p$$

The general term/rule is: $n \times \frac{3}{4} = \frac{3}{4}n$.

To find the 9th term, 9 is substituted for n.

$$\text{This results into: } 9 \times \frac{3}{4} = \frac{27}{4} = 6\frac{3}{4}.$$

Therefore, the 9th term/rule is $6\frac{3}{4}$.

- If time allows, let learners formulate their own linear fractional sequences and find the n^{th} rule/term.
- Guide learners through the example in the Learner's Book.
- Let them follow through at their own pace, do not hurry them.
- Explain every step to the learners' satisfaction and understanding.

Conclusion

- Let learners read the Study tip.
- They should now attempt Application 10.8 in the learner's Book.
- Mark their work and help them do corrections.
- Let them take their notes.

Remedial Exercise

Let slow learners re-do Application 10.8 to master the concept.

Additional Exercise

Fast learners should attempt the exercise below:

Find the general term/rule for the linear sequences below:

(a) Find the 11th term in: $\frac{2}{5}, \frac{4}{5}, 1\frac{1}{5}, 1\frac{3}{5}, \underline{\hspace{1cm}}, \underline{\hspace{1cm}}, \underline{\hspace{1cm}}, \underline{\hspace{1cm}}$.

(b) Find the 6th term in: $1\frac{1}{4}, 2\frac{1}{2}, 3\frac{3}{4}, \underline{\hspace{1cm}}, \underline{\hspace{1cm}}, \underline{\hspace{1cm}}, \underline{\hspace{1cm}}$.

(c) Find the 21st term in: $\frac{1}{8}, \frac{1}{4}, \frac{3}{8}, \frac{1}{2}, \underline{\hspace{1cm}}, \underline{\hspace{1cm}}, \underline{\hspace{1cm}}, \underline{\hspace{1cm}}$.

(d) What is the 46th term in: $\frac{2}{15}, \frac{4}{15}, \frac{6}{15}, \frac{8}{15}, \underline{\hspace{1cm}}, \underline{\hspace{1cm}}, \underline{\hspace{1cm}}, \underline{\hspace{1cm}}$.

Lesson 10.9**Finding the Number Sequence Using the General Term/Rule
(80 minutes)**

Learner's Book, page 184

Introduction

- Give a warm-up exercise to learners to suit your purpose.
- Review finding general rule of numbers in a linear sequence.
- Let learners form group and distribute the necessary learning material.
- Let learners carry out the activity in the Learner's Book.

Development

- Remind learners that they learned about finding the general term/rule of numbers in a linear sequence.
- Ask them to refer to their answers of the previous lesson, Application 10.5
- Let them read the general terms/rules they worked out as you write them on the chalkboard.
- With your aid, help learners to deduce the linear sequences for those general terms/rules.
For example: What linear number sequence has a general term/rule $3n + 1$?
- Get contributions from learners as you discuss with them.
- Let them follow the steps as laid down.

Step 1: Substitute the order of terms for “n” in the general rule:

$$1^{\text{st}} \text{ order} = 3n + 1 = 3 \times 1H = 3 + 1 = 4$$

$$2^{\text{nd}} \text{ order} = 3n + 1 = 3 \times 2H = 6 + 1 = 7$$

$$3^{\text{rd}} \text{ order} = 3n + 1 = 3 \times 3H = 9 + 1 = 10$$

$$4^{\text{th}} \text{ order} = 3n + 1 = 3 \times 4H = 12 + 1 = 13$$

- Learners realise that the linear sequence is: 4, 7, 10, 13, _____, _____, _____.
- On slips of paper, let learners try to find linear sequences of general term/ rules you give to them.
- Refer to example in the Learner’s Book, page 184.
- Let them follow through as you guide them.

Conclusion

- Conclude by emphasising that, finding the number sequences using the general term/rule, is an inverse operation of finding the general term/rule of a linear sequence.
- Learners read the Study tip, then attempt Application 10.9.
- Mark their work and help them do corrections.

Remedial Exercise

Let slow learners substitute the order of term, then solve:

$$(a) 2n = 1^{\text{st}} = 2 \times 1 = \underline{\quad\quad}. \quad (b) 2n = 2^{\text{nd}} = 2 \times 2 = \underline{\quad\quad}.$$

$$(c) 2n = \underline{\quad\quad} = \underline{\quad\quad} = \underline{\quad\quad}. \quad (d) 2n = \underline{\quad\quad} = \underline{\quad\quad} = \underline{\quad\quad}.$$

$$(e) 2n = \underline{\quad\quad} = \underline{\quad\quad} = \underline{\quad\quad}. \quad (f) 2n = \underline{\quad\quad} = \underline{\quad\quad} = \underline{\quad\quad}.$$

Additional Exercise

Fast learners should find the linear sequences below:

$$(a) 3n - 4 \quad (b) 5n + 7 \quad (c) \frac{1}{2}n - 1$$

$$(d) \frac{1}{4}n + \frac{1}{4} \quad (e) 0.2n + 0.3 \quad (f) 0.7n + 0.2$$

Remedial Activities

(1) Group the similar terms and simplify:

$$a) 12ab + b = 10 - 11ab$$

$$b) 2x - 7x - 5 = 9 + 3x$$

2. Fill in the missing numbers

$$a) 10, 21, 43, \dots, \dots$$

$$b) 2, 3, 5, \dots, \dots$$

3. Find the missing numbers

- (a) $1\frac{3}{4}, 1\frac{2}{4}, 1\frac{1}{4}, \dots, \dots$
 (b) 0.25, 0.5, 0.75, ..., ...
 (c) 1,000, 550, 100, ..., ...

Answers to Application 10.1

- (1) $3(p-q)$ (2) $\frac{3mn}{4}$ (3) $\frac{y+6}{5}$ (4) $3(2x-6)$
 (5) $\frac{1}{2}xy$ (6) $rs(p+q)$

Answers to Application 10.2

- (a) $4a + 2b = 4a + 2b$ (b) $5x - 25 \neq 5x - 5$
 (c) $9y + 12 = 9y + 12$ (d) $6q - 4 = 6q - 4$
 (e) $11m - 22n = 11 - 22n$ (f) $18x + 9 = 18x + 9$
 (g) $3y + 1 \neq 3y + 2$ (h) $28a - 2 \neq 14a - 29$
 (i) $3x + 3 = 3x + 3$ (j) $3y - 10 = 3y - 10$
 (k) $3m + 15 \neq 5m + 15$ (l) $5x - 7 = 5x - 7$

Answers to Application 10.3

- (a) 23, 28, 33, 38 (b) 13, 16, 19, 22
 (c) 14, 17, 20, 23 (d) 21, 25, 29, 32
 (e) 25, 31, 37, 43 (f) 47, 58, 69, 80
 (g) 28, 34, 40, 46 (h) 61, 74, 87, 100

Answers to Application 10.4

- (a) $7, 8\frac{1}{2}, 10, 11\frac{1}{2}$ (b) $7, 8\frac{1}{4}, 9\frac{1}{2}, 10\frac{3}{4}$
 (c) $\frac{1}{32}, \frac{1}{64}, \frac{1}{128}, \frac{1}{256}$ (d) $4, 4\frac{2}{3}, 5\frac{1}{3}, 6$
 (e) $2\frac{5}{12}, 2\frac{3}{4}, 3\frac{1}{12}, 3\frac{5}{12}$ (f) $4\frac{1}{5}, 5, 5\frac{4}{5}, 5\frac{3}{5}$
 (g) 1.7, 2.1, 2.5, 2.9 (h) 2.2, 2.7, 3.2, 3.7
 (i) 0.22, 0.27, 0.30, 0.33 (j) 2.23, 2.28, 2.33, 2.38
 (k) 0.41, 0.51, 0.61, 0.71 (l) 0.80, 0.95, 1.10, 1.25

Answers to Application 10.5

- (a) $4n + 1$ (b) $2n$ (c) $8n + 3$ (d) $5n + 2$
 (e) $4n + 2$ (f) $3n$ (g) $3n + 1$ (h) $5n + 3$
 (i) $6n + 2$ (j) $2n + 1$ (k) $3n + 2$ (l) $4n - 3$

Answers to Application 10.6

- (a) $\frac{1}{5}n + 1$ (b) $\frac{2}{5}n + 2$ (c) $\frac{1}{4}n + 3$ (d) $\frac{2}{3}n$
 (e) $\frac{5}{6}n$ (f) $\frac{2}{7}n + 5$ (g) $0.5n - 0.3$
 (h) $(0.05n - 0.02) + 2$ (i) $0.4n + 0.1$ (j) $15n + 0.05$

Answers to Application 10.7

- (a) 47 (b) 39 (c) 102 (d) 123
 (e) 52 (f) 282 (g) 295 (h) 601

Answers to Application 10.8

- (a) $3\frac{5}{6}$ (b) $7\frac{2}{3}$ (c) $9\frac{1}{3}$ (d) $20\frac{3}{4}$
 (e) 15 (f) $5\frac{3}{4}$ (g) $25\frac{1}{10}$ (h) $25\frac{1}{4}$

Answers to Application 10.9

- (a) 2, 4, 6, 8, _____, _____, _____, _____.
 (b) 5, 7, 9, 11, _____, _____, _____, _____.
 (c) 5, 8, 11, 14, _____, _____, _____, _____.
 (d) 2, 5, 8, 11, _____, _____, _____, _____.
 (e) 3, 8, 13, 18, _____, _____, _____, _____.
 (f) 4, 8, 12, 16, _____, _____, _____, _____.
 (g) 6, 7, 8, 9, _____, _____, _____, _____.
 (h) 1, 5, 9, 13, _____, _____, _____, _____.
 (i) $\frac{3}{4}$, $1\frac{1}{2}$, $2\frac{1}{4}$, 3, _____, _____, _____, _____.
 (j) $\frac{1}{2}$, 1, $1\frac{1}{2}$, 2, _____, _____, _____, _____.
 (k) $1\frac{5}{6}$, $2\frac{2}{3}$, $3\frac{1}{2}$, $4\frac{1}{3}$, _____, _____, _____, _____.
 (l) $3\frac{5}{10}$, $4\frac{2}{5}$, $5\frac{5}{10}$, $5\frac{4}{5}$, _____, _____, _____, _____.
 (m) 10, 20, 30, 40, _____, _____, _____, _____.
 (n) 5, 9, 13, 17, _____, _____, _____, _____.
 (o) 12, 20, 28, 36, _____, _____, _____, _____.
 (q) 7, 14, 21, 25, _____, _____, _____, _____.
 (r) 11, 19, 27, 35, _____, _____, _____, _____.

- (s) 5, 6, 7, 8, _____, _____, _____, _____.
- (t) 11, 12, 13, 14, _____, _____, _____, _____.
- (u) 3, 8, 13, 18, _____, _____, _____, _____.
- (v) $2\frac{3}{4}$, $3\frac{1}{2}$, $4\frac{1}{4}$, 5, _____, _____, _____, _____.
- (w) $\frac{3}{5}$, $1\frac{1}{5}$, $1\frac{4}{5}$, $2\frac{2}{5}$, _____, _____, _____, _____.
- (x) $\frac{1}{2}$, 1, $1\frac{1}{2}$, 2, _____, _____, _____, _____.
- (y) $4\frac{1}{3}$, $4\frac{2}{3}$, 5, $5\frac{1}{3}$, _____, _____, _____, _____.

End of unit 10 Assessment

- 1) (a) $(n-6)2$ (b) $\frac{m+n}{4}$ (c) $2x + 8$ (d) $1(ab)$
- 2) (a) $6x - 12 = 6x - 12$ (b) $2y + 1 = 2y + 1$
 (c) $28k - 14 = 28k - 14$ (d) $3x + 1 = 3x + 1$
 (e) $169m - 13n = 169m - 13n$ (f) $7x - 2 = 7x - 2$
- 3) (a) 17, 21, 25, 29 (b) 19, 23, 27, 31
 (c) 24, 29, 34, 39 (d) 15, 18, 21, 24
 (e) 21, 26, 31, 36 (f) 18, 22, 26, 30
- 4) (a) $3n + 1$ (b) $4n - 2$ (c) $6n + 5$ (d) $9n + 7$
- 5) (a) 30 (b) 196 (c) 526 (d) 305
- 6) (a) $2\frac{5}{6}$, $3\frac{1}{2}$, $4\frac{1}{6}$, $4\frac{5}{6}$ (b) $4\frac{1}{5}$, 5, $5\frac{4}{5}$, $6\frac{3}{5}$
 (c) $\frac{1}{32}$, $\frac{1}{64}$, $\frac{1}{128}$, $\frac{1}{256}$

Unit 11

Solving Simple Algebraic Equations and Inequalities

Key unit competence: To be able to form and solve simple algebraic equations and inequalities.

List of lessons

Lessons	Number of lessons	Number of periods
11.1 Like terms of algebraic expressions	1	1
11.2 Unlike terms of algebraic expressions	1	1
11.3 Substituting algebraic expressions with addition and subtraction	1	1
11.4 Substituting algebraic expressions involving multiplication	1	1
11.5 Substituting algebraic expressions involving division	1	1
11.6 Simple algebraic equations with one unknown	1	1
11.7 Solving fractional algebraic equations	1	1
11.8 Solving problems involving equations	1	1
11.9 Solving algebraic inequalities with one unknown	1	1
11.10 Finding the solution set	1	1
11.11 Solving problems involving simple algebraic equations	1	1
End of Unit 11 Assessment	1	1
Total	12	12

Guidance on problem statement

This unit is related to solving algebraic equations and inequalities. Let learners know the importance of algebraic equations and how they can apply them in daily life. Let them attempt the introduction in the Learner's Book, page 187.

Cross-cutting issues

Throughout the teaching process of this unit, it will be crucial to help learners to master the content and it is better to address cross-cutting issues where possible. In this unit, we will address the following Cross-cutting issues as non-stand alone within classroom activities and through the development of the content.

- **Peace and value education:** As a teacher, you have to be a peace maker in your class and role model so that learners will imitate how you behave. When there is any conflict do not leave without helping to solve it within the lesson. Encourage learners to behave well, being humble, honest, etc.
- **Gender education:** This cross-cutting issue will be addressed through giving equal opportunities to both boys and girls during the lesson.
- **Inclusive education:** As learners give examples of inequality, make sure that they do not insult others using them in comparison. Be sure that you help learners with special needs to participate as far as they can.

Learning Objectives

Knowledge and understanding

- Give examples of simple algebraic equations or inequalities with one unknown.
- Describe the process of solving simple algebraic equations or inequalities.

Skills

- Solve word problems involving simple algebraic equations with one unknown.
- Solve simple algebraic inequalities with one unknown.

Attitudes and values

- Appreciate the importance of algebraic equations and inequalities in solving word problems.

Number of lessons: 12

Guidance for classroom organisation

- Before you start the lesson, first use warm ups or energizers in order to engage the learners into the lesson. Do not focus on this only, try to be creative. The essence is to motivate learners and make them active throughout the teaching-learning process.
- Help learners to form group before you assign them an activity.
- While they are doing the activity, walk around while monitoring their work and helping where they have difficulties.

Learning and teaching materials for the unit

Manila cards, scissors, markers and masking tape and other materials that a teacher may see as important to achieve his/her objective.

Lesson 11.1 and 11.2 Like and Unlike Terms of Algebraic Expressions (80 minutes)

Learner's Book, page 187 and 188

Introduction

- Start with addition and subtraction mental work. For example; 12 pens + 8 pens, 15 boxes + 7 boxes, 25 books + 8 books, 18 apples - 6 apples, 27 oranges + 12 oranges and so on.
- Guide learners as they carry out the activity in the Learner's Book, page 187 in manageable groups.

Development

- Allow each group to present its report and later discuss as a class to come up with one report.
- Write an examples which require collecting like terms on the chalk board.
Example: Collect the like terms and simplify: 5 tomatoes + 6 onions + 3 tomatoes + 9 onions.
- Ask learners to read the example and later explain to them that like terms have items or expressions which are similar, where as unlike terms have items or expressions which are not similar.
- So collecting like term, in the example will give us;

$$5 \text{ tomatoes} + 3 \text{ tomatoes} + 6 \text{ onions} + 9 \text{ onions}$$

$$= 8 \text{ tomatoes} + 15 \text{ onions}.$$
- Give another example which involves collecting like term and simplifying with more than one operation.

Example: Collect like terms and simplify;

$$7 \text{ mats} + 10 \text{ stools} + 3 \text{ mats} - 4 \text{ stools (collect the like terms)}$$

$$= 7 \text{ mats} + 3 \text{ mats} + 10 \text{ stools} - 4 \text{ stools (now simplify)}$$

$$= 10 \text{ mats} + 6 \text{ stools}.$$

- Refer to the Learner's Book and guide the learners through the examples.
- Give them chance to ask each time they feel they have not understood.
- Explain to the learners that a "term" takes a sign that is before it. For example, in $7y + 8x - 4y + x$,
- To collect like terms $7y$ will be followed by $-4y$. The term $4y$ moves with the sign before it, hence; $= 7y - 4y + 8x + x$

$$= 3y + 9x$$

Conclusion

- Guide learners through the Study tip and use it to emphasise what you have just taught.
- Let learners attempt Application 11.1 and 11.2.

Remedial Exercise

Slow learners can try out simple problems involving collecting like terms for example;

(1) $6a + 4b + 3a + 6b$

(2) $5q + 9p + 7q + 3p$

(3) $7m + 3n + 2m + 6n$

(4) $3x + 7y + 4x - 3y$

(5) $9f + 7g - 6f + 3g$

(6) $8r + 3y - 5r + 10y$

Additional Exercise

Fast learners can carry out more complex problems for example;

(1) $3ab + 4pq + 5ab + 6pq$

(2) $7xy + 6rs - 2xy + rs$

(3) $9fg - 4mn + 4fg - 2mn$

(4) $8vw - 7jk + 3vw - 5jk$

(5) Find the perimeter of the following

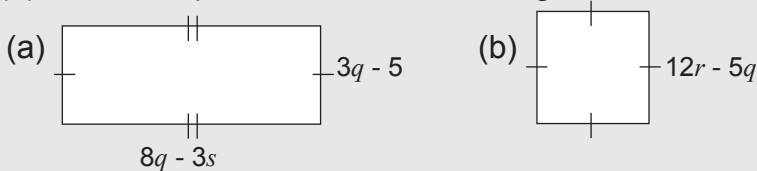

Lesson 11.3

Substituting Algebraic Expressions with Addition and Subtraction (40 minutes)

Learner's Book, page 189

Introduction

- Start with mental work on phrases and expressions for example; what do the following mean?

(a) $a + b$

(b) $a - b$

(c) $a - c + d$

(d) $x - z + y$

(e) $x + y - z$

(f) $p + 2q - r$

- Ask learners to form groups and provide each group with cards and markers

Development

- Guide learners as they carry out the activity in the Learner's Book, page 189.
- Conclude the activity by explaining to the learners the meaning of substitution.
- Write a few examples on the chalkboard for learners to discuss as class.

Example: Find the value of the following if;

$f = 8, g = 5, h = 6, k = 4$ and $m = 3$

(a) $f + k + h$ (b) $g + k - f$ (c) $k + h + m$ (d) $f + g - k$

- Ask learners to read the question and discuss each example as you work out.

(a) $f + k + h$
 $= 8 + 4 + 6$
 $= 18$

(b) $g + k - f$
 $= g + k - f$
 $= 5 + 4 - 8$
 $= 9 - 8$
 $= 1$

(c) $k + h + m$
 $= k + h + m$
 $= 4 + 6 + 3$
 $= 10 + 3$
 $= 13$

(d) $f + g - k$
 $= \frac{f \times g}{k}$
 $= 8 + 5 - 4$
 $= 13 - 4$
 $= 9$

- Explain to the learners that they should take note of the letters that are to be substituted to avoid making mistakes.
- Refer to the Learner's Book and guide learners as they study the examples.

Conclusion

- Guide learners through the Study tip and use it for emphasis.
- Guide learners as they attempt Application 11.3.
- Mark their work and help them do corrections.
- Let them take notes.

Remedial Exercise

Let slow learners try out more substitution for more practice.

Find the value of the following if; $a = 10$, $b = 8$, $c = 5$ and $d = 11$.

1. Find the value of $b + d + a$
2. What is the value of $b - c + d$?
3. Find the value of $a + b - d$.
4. What is the value of $a + b + c$?
5. Work out; $a + b - c$.
6. What is the value of $a + d - c$?

Additional Exercise

Fast learners can try out more complex questions for practice:

If $p = 10$, $r = 5.4$, $s = 2$, $q = 12.5$ and $t = 4$

1. Find the value of $p + q + r$.
2. What is the value of $s + r + p$?
3. Work out, $q + t - r$
4. What is the value of $p - q + r$?
5. Work out; $p + r - s$.
6. Find the value of $t + p - q$.

Lesson 11.4

Substituting Algebraic Expressions with Multiplication (40 minutes)

Learner's Book, page 190

Introduction

- Give mental work about substitution with addition and subtraction.
- Review the previous lesson.
- Let learners form groups and distribute to them the learning materials.
- Check their work and give a general report.

Development

- Explain that the lesson is about substitution with multiplication.
- Learners have been taught about substituting algebraic expression with addition and subtraction.
- In this lesson, they are going to learn about, finding the products of the substitute values.
- Give examples on the chalkboard. Let learners copy them on slips of paper and work them out in pairs.

Examples: Given that: $a = 5$, $b = 7$ and $c = 10$, find the values of

(a) $ab - c$

(b) $4c + 2b - a$

- Explain that before substituting, the terms have to be expanded first.

$$ab - c = a \times b - c$$

$$a = 5, b = 7, c = 10$$

$$= 5 \times 7 - 10$$

$$= 35 - 10$$

$$= 25$$

$$4c + 2b - a$$

$$a = 5, b = 7, c = 10$$

$$= 4 \times c + 2 \times b - a$$

$$= (4 \times 10) + (2 \times 7) - 5$$

$$= 40 + 14 - 5$$

$$= 54 - 5$$

$$= 49$$

- Refer to the examples in the Learner's Book.
- Let learners follow through to come up with a general observation.

Conclusion

- Let them read the Study tip.
- Learners then attempt Application 11.4.
- Mark their work and help them do corrections.
- Let them take notes in their exercise books.

Remedial Exercise

Let slow learners attempt the exercise that follows:

Given that: $e = 4$, $f = 5$, $g = 2$, $h = 3$, find the value of these:

(a) ef

(b) eg

(c) fg

(d) $gh + e$

(e) $2h - 3$

(f) $eg + f$

(g) $3h - g$

Additional Exercise

Give fast learners an exercise which is complex to invoke critical thinking:

Given that: $p = \frac{1}{2}$, $q = -4$, $r = \frac{3}{4}$, $s = -10$, evaluate:

(a) $4p - 2q$

(b) $12r + 6p - s$

(c) $\frac{1}{5}s - 4q$

(d) $\frac{1}{2}p - \frac{1}{4}q$

(e) $r + 4p - 3q$

(f) $25 - q^3 + 8r$

(g) $10q - s^2 + 2p$

(h) $\frac{1}{5}q - r$

Lesson 11.5**Substituting Algebraic Expressions Involving Division**
(40 minutes)**Learner's Book, page 192****Introduction**

- Give warm-up exercise as you may desire.
- Give mental work involving division of simple numbers.
Example: $12 \div 3$, $24 \div 8$, $36 \div 9$, $45 \div 5$, $50 \div 10$, etc.
- Let learners form groups and they carry out the activity.
- Monitor their working out and harmonise the answers.

Development

- Explain the main concept of the lesson.
- Tell learners that division is worked out after substituting the values of the letters.
- Give examples in order to explain the concept.

Example: If $x = 9$, $y = -3$, $z = 12$, work out the following:

(a) $\frac{x}{y}$

(b) $\frac{2z - 6}{x}$

$\frac{x}{y}$ means $x \div y$

$x = 9$, $y = -3$

$= 9 \div -3$ (apply division of integers)

$= -3$

$$\begin{aligned} \frac{2z - 6}{x} &= (2 \times z - 6) \div x \\ &= (2 \times 12 - 6) \div 9 \\ &= (24 - 6) \div 9 \\ &= 18 \div 9 \\ &= 2 \end{aligned}$$

- Give more examples for the learners to practice more.
- Give them chance to formulate their own algebraic expressions.
- Monitor their working out and help where learners have difficulties.
- Let learners read and study the examples on page 192.
- Explain that where the numbers involve division with negatives, apply the concept of division of integers, that is how signs change.

Conclusion

- Let learners read the Study tip.
- Ask them to attempt Application 11.5 in the Learners Book.
- Mark their work and help them do corrections.

Remedial Exercise

Let slow learners attempt the exercise that follows:

Given that: $a = 4$, $b = 6$, $c = 8$, $d = 10$ work out the following:

(a) $\frac{2d}{a}$	(b) $\frac{ab}{c}$	(c) $\frac{d-b}{a}$	(d) $\frac{b+a}{d}$
(e) $\frac{2c}{2a}$	(f) $\frac{d+b}{c}$	(g) $\frac{bc}{a}$	(h) $\frac{d+c}{a}$

Additional Exercise

Give fast learners an exercise which is complex to invoke critical thinking:

Given that: $p = -8$, $q = \frac{5}{9}$, $r = 12$, $s = -6$, evaluate:

(a) $\frac{rs}{p}$	(b) $\frac{9qrt}{s}$	(c) $\frac{1}{4}p \div 2r$	(d) $\frac{3qs}{2r}$
(e) $\frac{ps}{2r}$	(f) $\frac{qs}{2p}$	(g) $\frac{18q + 3s}{4r}$	(h) $\frac{6r - 2p}{4s}$

Lesson 11.6**Simple Algebraic Equations with One Unknown (40 minutes)**

Learner's Book, page 193

Introduction

- Start with simple mental work on missing numbers.
For example; What number do you add to 6 to get 10?
What number can one multiply 4 with to get 8?
What number can you subtract from 10 to remain with 3 and so on.
- Put learners in groups and provide each group with a balance, fruits and seeds.

Development

- Guide each group as they carry out the activity and later help them to realise that equations must balance like the balances they are using.
- Explain to the learners that an equation is a mathematical statement with equal sides, that is, the "left hand side" should be equal to the "right hand side."
- Write an example which requires learners to solve by subtracting; Example; solve; $y + 8 = 12$
- Ask learners to read the equation.
- Explain to them that to find the missing number they should subtract because subtraction is an inverse operation for addition.

$$\text{So; } y + 8 = 12$$

$$y + 8 - 8 = 12 - 8 \text{ (to balance the equation, subtract 8 from both sides)}$$

$$y + 0 = 4$$

$$y = 4$$

- Write another example which requires learners to solve by adding.

Example $p - 10 = 5$

- Let learners read the equation.
- Explain to them that to solve for the unknown in case of this example, they should add since addition is an inverse operation for subtraction.

So; $p - 10 = 5$

$p - 10 + 10 = 5 + 10$ (to balance the equation, add 10 to both sides)

$$p + 0 = 15$$

$$p = 15$$

- Write an example which require learners to solve by dividing.
Example; solve $6y = 18$.
- Ask learners to read the problem and suggest what to do.
- Help them to realise that $6y$ means $6 \times y$ and that to solve multiplication of equations, we apply division because it is its inverse.
- Take the learners through the working, that is:

$$6y = 18$$

$$\frac{6y}{6} = \frac{18}{6}$$

$$y = 3$$

- Give other examples including those involving multiplication. Help them to solve for the unknown.
- Refer to the Learner's Book and guide learners as they study the examples and discuss.
- Ensure that each learner participates in the discussion.
- Explain to the learners that when solving equations that involve addition, they should subtract and when solving equations that involve subtraction they should add.

Conclusion

- Guide learners through the Study tip and use it to emphasise what you have just taught.
- Let them attempt Application 11.6.
- Mark their work and help them do corrections.

Remedial Exercise

Let slow learners solve more simple equations for practice.

(1) $k + 3 = 12$

(2) $m + 7 = 15$

(3) $n + 4 = 13$

(4) $p + 8 = 18$

(5) $q + 12 = 18$

(6) $x + 10 = 12$

(7) When a number is multiplied by 2, the result is 16 Find the number.

(8) What number can you multiply by 6 to get 24?

(9) Mbabazi multiplied a number by 7 and got 35 as the product. Find the number he used.

Additional Exercise

Fast learners can form and solve more equations for example;

- (1) Angella had some rabbits. She bought 7 rabbits more. She now has 25 rabbits. Find the number of rabbits that she had before.
- (2) Bizimana had some chapats. He made 35 more chapats. Now he has 58. Calculate the number of chapatis he had before.
- (3) Anastazia planted 52 saplings. Some of the saplings dried up and she remained with 24. Find the number of saplings that dried.
- (4) A number was multiplied by 8 and 7 was subtracted from its product such that 81 remained. Find that number.
- (5) What number when multiplied by 5 and 13 is subtracted from the product gives 82?

Lesson 11.7 Solving Fractional Algebraic Equations (40 minutes)

Learner's Book, page 195

Introduction

- Give learners simple algebraic equations to solve mentally.
Example: (a) $x + 2 = 10$ (b) $y - 4 = 12$ (c) $m + 3$ (d) $p - 5 = 15$
- Review the work done in the previous lesson.
- Let learners form groups and do the activity in the learner's book.
- Engage learners in the activity in the Learner's Book, page 195.
- Facilitate a discussion about the procedure, then the outcomes.

Development

- Mention the main competence as solving fractional algebraic equations.
- Referring to the outcomes from the activity, expound on the idea of multiplying numbers by fractions.
- Write examples on the chalkboard and ask learners to copy them on to slips or sheets of paper. Then they try the numbers out.

Example 1

$$\text{Solve: } \frac{2}{5}(y - 3) = 4$$

Explain that it is better to do away with the denominator first. 5 is multiplied both sides.

$$\begin{aligned} &= \cancel{5}^1 \times \frac{2}{\cancel{5}_1} (y - 3) = 4 \times 5 \\ &= 2(y - 3) = 20 \\ &= 2 \times y - 2 \times 3 = 20 \\ &= 2y - 6 = 20 \end{aligned}$$

Example 2

$$\frac{5x + 5}{6} = 5$$

Explain that it is better to do away with the denominator first. 6 is multiplied both sides to eliminate the denominator.

$$\begin{aligned} &\cancel{6}^1 \times \frac{5x + 5}{\cancel{6}_1} = 5 \times 6 \\ &5x + 5 = 30 \end{aligned}$$

6 is added both sides to balance the equation.

$$2y - 6 + 6 = 20 + 6$$

$$2y = 26$$

Divide both sides by 2

$$\frac{2y}{2} = \frac{26}{2}$$

$$y = 13$$

So, the value of y is 13.

5 is subtracted both sides to balance the equation.

$$5x + 5 - 5 = 30 - 5$$

$$5x = 25$$

Divide both sides by 5.

$$\frac{5x}{5} = \frac{25}{5}$$

$$x = 5$$

Therefore, the value of x is 5.

- Refer the learners to the examples in the Learner's Book.
- Let learners follow through the procedure.
- Through question and answer, explain the steps thoroughly so that learners understand the concept very well.

Conclusion

- Let learners read the Study tip repeatedly in order to internalise it.
- Then they attempt Application 11.7.
- Mark their work and help them do corrections.

Remedial Exercise

Let slow learners solve the following equations:

(a) $\frac{1}{2}(2a + 2) = 3$

(b) $\frac{1}{2}(3k - 3) = 7$

(c) $\frac{1}{4}(4b + 8) = 4$

(d) $\frac{1}{5}(5a - 10) = 3$

(e) $\frac{1}{8}(6a - 15) = 7$

(d) $\frac{2}{5}(2a + 4) = 10$

Additional Exercise

Give fast learners an exercise which is complex to invoke critical thinking:

Solve the following equations:

(a) $\frac{3}{4}(12a - 8) = \frac{2}{3}(6a - 12)$

(b) $\frac{9}{10}(5q + 25) = \frac{1}{4}(12q - 16)$

(c) $\frac{11}{12}(36r - 24) = \frac{5}{6}(24r + 12)$

(d) $\frac{17}{20}(40y + 60) = \frac{31}{40}(80y - 40)$

Lesson 11.8

Solving Problems Involving Equations (40 minutes)

Learner's Book, page 197

Introduction

- Give learners mental work about simple application of equations.
Example: (a) To what number do you add to 7 to get 10?
(b) What number is added to 6 to get 9?
(a) Think of a number when you subtract 5, you get 12.

- Review the previous lesson.
- Let learners form groups and do the activity in the Learner's Book.

Development

- Explain to learners that equations can be applied in solving problems in our daily life.
- There are many things we would like to find out but we do not know, so we apply equations.
- Display the chart with a worked example. Let learners read the context repeatedly in order to group the meaning.

For example: The sum of 3 consecutive counting numbers is 24.
What are the numbers?

- Let learners realise that in the statement, none of the counting numbers has been given. It is their total that is given.
- Lead them to an imagination of unknown numbers, the 1st number being expressed as a letter: Let the 1st number be x .
- Remind learners about increasing order of consecutive numbers.
- They are supposed to state that: the 2nd number is 1 more, and the next is also 1 more than the previous number.

So, in this case, if 1st number is x

2nd number is $x + 1$

3rd number is $x + 2$

Sum is got as a result of adding all the numbers.

- Lead learners to form and write an equation about the formed numbers:

i.e. $x + (x + 1) + (x + 2) = 24$ (They should simplify the equation)

$x + x + 1 + x + 2$ (Collecting like terms)

$x + x + x + 1 + 2 = 24$

$3x + 3 = 24$ (subtract 3 from both sides)

$3x + 3 - 3 = 24 - 3$

$3x = 21$ (divide by 3 both sides to find the value of x)

$$\frac{3x}{3} = \frac{21}{3}$$

$x = 7$

So, the values of the numbers are:

$(x = 7)$, $(x + 1) = 7 + 1 = 8$, $(x + 2) = 7 + 2 = 9$

Therefore, the consecutive counting numbers are 7, 8 and 9.

- Let learners do the examples in the learner's book.
- In case they do not grasp the idea at first hand, explain every detail in the statement in order for the learners to understand the context.

- Give several other examples in real life experience that solving problems involving equations.
- Let them formulate their own problems as you write them on the chalkboard.
- Monitor how they solve them and give conclusive comments.

Conclusion

- Let learners read the Study tip as a summary of the lesson.
- Let them attempt Application 11.8.
- Mark their work and help them do corrections.
- Learners take notes in their exercise books.

Remedial Exercise

Let slow learners solve the following equations:

1. The sum of two numbers is 10. One of them is 3. What is the other number?
2. The sum of two numbers is 12. One of them is 7. Find the second number.
3. The product of two numbers is 8. One of them is 4. What is the other number?
4. The perimeter of a square is 16 cm. What is each side?
5. The area of a rectangle is 20 cm². Its length is 4 cm. What is its width?

Additional Exercise

Give fast learners an exercise which is complex to invoke critical thinking:

Solve the following equations:

1. The sum of 4 consecutive counting numbers is 104. What are the numbers?
2. The sum of 5 consecutive counting numbers is 210. Find the 3rd number.
3. A mother is 24 years older than her daughter. In 8 year time, the mother will be double the age of the daughter,
 - (a) How old is the daughter?
 - (b) How old is the mother?
 - (c) How old will the daughter be in 8 year's time?
 - (d) Find the mother's age in 8 year's time.
4. The product of a number and 3 is the same as half the sum of that number and 5. What is the number?

Lesson 11.9

Solving Algebraic Inequalities with One Unknown (40 minutes)

Learner's Book, page 199

Introduction

- Review the previous lesson.
- Ask learners to form groups.
- Guide learners as they discuss the information in the activity.

Example: Solve $2y + 26 > 6$ and show the working steps.

Development

- Let them form an inequality and solve it. Allow each group to present its report.
- Later discuss as class to come up with a general report.
- Display a chart with an example similar to the one below.
- Example: Solve and write a solution set. $6m - 3 > 10$
- Ask learners to read the question and later ask them to solve it.
- Help them to realise that the solving is similar to that of equations.

So; $6m - 8 > 10$

(Add 8 to both sides)

$$6m - 8 + 8 > 10 + 8$$

$$6m > 18$$

(Divide both sides by 6)

$$\frac{6m}{6} > \frac{18}{6}$$

$$m > 3$$

- Refer to Learner's Book, page 199 and guide learners through the examples.
- You can give 2 more examples to the learners for them to discuss in groups as you guide them.
- Emphasise to the learners that when solving inequalities, the same procedures like those of solving equations are used. The only difference is that with inequalities the signs $>$, $<$, \geq , \leq are used .

Conclusion

- Guide learners as they discuss the Study tip.
- Let learners attempt Application 11.9.
- Mark their work and help them do corrections.

Remedial Exercise

Let slow learners solve simple inequalities and find solution sets.

(1) $y + 5 < 10$ (2) $y + 5 > 10$ (3) $y - 5 < 10$ (4) $y - 5 > 10$

(5) $5y < 10$ (6) $5y > 10$ (7) $\frac{y}{5} < 10$ (8) $\frac{y}{5} > 10$

Fast learners can solve more complex inequalities and find the solution sets.

(1) $4k + 4 > 16$ (2) $2y - 9 < 9$ (3) $4k - 4 > 16$

(4) $3p + 5 > 11$ (5) $2(3k + 4) > 26$ (6) $2(2m + 4) < 24$

Lesson 11.10 Finding the Solution Set (40 minutes)

Learner's Book, page 200

Introduction

- Give learners mental work about simple values for inequalities.
Example: (a) x is a number greater than 5. What are some of these numbers?
(b) y is a number less than 7. What are some of the numbers?
- Review the previous lesson.
- Group the learners in manageable groups and let them do the activity in the learner's book.
- Follow their participatory work as you move from one group to another.
- Facilitate their discussion and harmonise the outcomes.

Development

- Explain that the lesson is about finding the possible values of the solved inequalities.
- In the previous lesson, learners were taught how to solve inequalities.

Example: Solving $3x - 5 < 10$

$$= 3x - 5 < 10$$

$$= 3x - 5 + 5 < 10 + 5$$

$$= 3x < 15$$

$$= \frac{3x}{3} < \frac{15}{3}$$

$$= x < 5$$

Therefore, $x < 5$ means "x is less than 5".

- So, today's lesson is about listing the possible values of x which satisfy the statement $x < 5$.
- The numbers to be listed are less than 5. These numbers include positive and negative integers. The list will continue to infinity because we can not exhaust them.
- Conclusively $x = (\dots -1, 0, 1, 2, 3, 4)$. It is this expression that is known as a solution set.
- Give learners another example to expose them more to finding the solution set.

Example: Find the solution set for $7y + 11 > 25$

Let learners solve the inequality first as earlier learnt.

$$= 7y + 11 > 25$$

$$= 7y + 11 - 11 > 25 - 11$$

$$= 7y > 14$$

$$= \frac{7y}{7} > \frac{14}{7}$$

$$= y > 2$$

- Learners are expected to interpret the expression as “values of y greater than 21.
- Ask them to draw a number line and label the possible values.
- Explain that “less than” possible values are on the left of the number line. And, “greater than”, possible values are on the right of the number line.
- Learners observe that the possible values of y , greater than 2 include: 3, 4, 5, 6 and so on.
- Therefore, the solution set is: $y = (3, 4, 5, 6, \dots, \dots, \dots)$.
- Let learners study the examples in the learner's book.
- Guide them in interpreting them correctly.
- Emphasize that, solution set is a set of possible values of an unknown. And, a solution set is written inside curly brackets.
- If the solution set values are “greater than”, ellipsis should be put on the set.
- Ellipsis is a sign of continuity to infinity.

Conclusion

- Let learners attempt the Application that follows.
- Mark their work and give feedback. Help them do corrections.
- Let learners take notes.

Remedial Exercise

Let slow learners label the solution sets given below on the number line.

- (a) $y < 4$ (b) $x > -3$ (c) $m < 5$ (d) $x > -1$
 (e) $x < 2$ (f) $y > 0$ (g) $k < -1$ (h) $n > 3$

Let fast learners solve and give solution sets for each of the following:

- (a) $-3 \leq y < 15$ (b) $24 > m \geq 12$ (c) $48 \leq 6y \leq 6$
 (d) $13 < 26m \leq 169$ (e) $30 \leq 5y \leq 15$ (f) $144 \geq 24x \geq 48$

Lesson 11.11

Solving Problems Involving Simple Algebraic Equations and Inequalities (40 minutes)

Learner's Book, page 201

Introduction

- Review solving inequalities which was done in the previous subtopic using a few numbers.

Examples: (a) Solve $\frac{3}{4}p \geq 8$ (b) $2(x + 2) \leq 12$

- Ask learners to form groups and guide them as they discuss the contents of the activity.

Development

- Allow each group to present its result and later come up with a general result.
- Display the chart with an example similar to the one below. Example; Uwimana made cupcakes. She sold 17 cupcakes and those that remained were more than 5. How many cup cakes did she have made?
- Ask learners to read the question and form an inequality, that is; let the number of cakes be x .

So $x - 17 > 5$ (Discuss each step as you work out)

$x - 17 > 5$ (Add 17 to both sides)

$x - 17 + 17 > 5 + 17$

$x > 22$

So the cup cakes that were made may have been (23, 24, 25, ...).

- Refer to the learner's book and guide learners as they study the example.
- Create more examples for learners to discuss in groups as you guide them.
- Explain to the learners words that mean less or greater than in word problems. Words like more, above or higher may be used to mean greater, words like below or lower may be used to mean less.

Conclusion

- Guide learners as they discuss the Study tip.
- Let learners attempt Application 11.11.
- Mark their work and help them do corrections.

Remedial Exercise

Slow learners can form and solve simple inequalities for example;

1. When 7 is added to a number the result is greater than 10. What are the possible numbers?
2. When 5 is subtracted from a number, the difference is less than 6. What are the possible numbers?
3. When 3 is multiplied by a number the product is less than 18. What are the possible numbers?
4. When a number is divided by 4, the quotient is a number that is equal to 6. What are the possible numbers?

Additional Exercise

Fast learners should attempt the exercise below:

1. There was some water in the tank. The builders used 83 litres and less than 20 litres of water were left. Find the amount of water which could have been in the tank.
2. Kagabo had cattle. 21 of his cows calved down and he now has 72 heads of cattle. How many heads of cattle had he at first?

3. Uwachu made some candles and packed 6 candles in each packet. She filled more than 12 packets. Find the number of candles she is likely to have made.
4. $\frac{3}{4}$ of the Learners in the school come by bus. The Learners who come by bus are 240. Find the number of Learners in that school.

Answers to Application 11.1

- (a) $9x$ (b) $4y$ (c) $3p + 4q$
 (d) $3mno + 6xy + 4ab$ (e) $4xyz$
 (f) $12a - 8d$ (g) $12x + 24m$

Answers to Application 11.2

- (a) $7xyz + abc - 3xyr$ (b) $12x^2y - 4xy^2 - 6a - 19b$
 (c) $3x - xz + 6yx + 4tz$ (d) $17abfg - 3abcd - 5acd - 10defg$
 (e) $4abc + 2acd - 4bca$ (f) $fgh + fjk + 3fkj$
 (g) $4pqr + 9prq - 4rxy$ (h) $stu - 2tuv + 7rst$

Answers to Application 11.3

- (a) 7 (b) 7 (c) 5 (d) 6
 (e) 15 (f) 16 (g) 17 (h) 10
 (i) 20 (j) 10 (k) 17 (l) 13
 (m) 20 (n) 0 (o) 8

Answers to Application 11.4

- (a) $x = 480$ (b) $r = 76$ (c) $y = -22$ (d) $y = 72$
 (e) $z = -20$ (f) -48 (g) -60 (h) -134
 (i) 0 (j) -18 (k) 4 (l) -38 (m) 300
 (n) -33.3 (o) 24 (p) 5 (q) 7
 (r) 557 (s) 42 (t) -64 (u) -304

Answers to Application 11.5

- (a) $-4\frac{1}{2}$ (b) 7 (c) -2 (d) $-6\frac{2}{9}$
 (e) -18 (f) 4 (g) 3 (h) $-\frac{1}{2}$
 (i) -16 (j) $\frac{8}{9}$ (k) $-2\frac{2}{5}$ (l) $-\frac{1}{24}$
 (m) 12 (n) 51 (o) 34

Answers to Application 11.6

- 1) (a) $x = 14$ (b) $r = 4$ (c) $y = -1$ (d) $y = 5$
 (e) $z = 2$ (f) $m = 5$ (g) $p = 4$ (h) $q = 10$
 (i) $x = 9$
- 2) (a) $y = 10$ (b) $x = 3$

Answers to Application 11.7

- (a) $x = 3\frac{1}{2}$ (b) $p = 2$ (c) $m = 2$ (d) $a = 1$
 (e) $x = 14$ (f) $m = 20$ (g) $x = 3$ (h) $p = 9\frac{17}{28}$
 (i) $a = -1\frac{1}{3}$ (j) $x = 3$ (k) $m = 4$ (l) $p = 4$
 (m) $a = 16$ (n) $q = 3$ (o) $x - 9$ (p) $y = 7$
 (q) $p - 12$ (r) $r = 2$

Answers to Application 11.8

- 1) 8 2) 12 3) 10 cm 4) base = 12 cm
 5) (a) 18 years (b) 48 years (c) 30 years (d) 60 years
 6) 11, 12, 13 (7) 23, 24, 25, 26

Answers to Application 11.9

- (a) $x > -1$ (b) $x > 3\frac{2}{5}$ (c) $x > -9$ (d) $y < \frac{9}{2}$
 (e) $y > 7$ (f) $-2 < x < 6$ (g) $x \leq 10$ (h) $x > -\frac{5}{3}$
 (i) $x > -4$ (j) $x > -2$

Answers to Application 11.10

- (a) $x = (6, 7, 8, _, _, _)$ (b) $y = (4, 5, 6, _, _, _)$
 (c) $x = (_, _, _, -1, 0, 1, 2, 3)$ (d) $m = (_, _, _, -1, 0, 1, 2, 3, 4)$
 (e) $x = (2, 3, 4, _, _, _)$ (f) $n = (4, 5, 6, _, _, _)$
 (g) $q = (_, _, _, -1, 0, 1, 2, 3)$ (h) $y = (5, 4, 3)$
 (i) $x = (4, 5, 6, 7)$ (j) $m = (7, 6, 5, 5)$
 (k) $x = (1, 2, 3, 4, 5)$ (l) $y = (11, 10, 9, 8, 7, 6, 5, 4, 3)$

Answers to Application 11.11

- 1) (a) $13x = 4b + 1$ (b) $-7bcdef + 12bdefc$
 (c) $6xz + 5xyz - 2yz$ (d) $y > 7$
- 2) 40 (3) 26 (4) $6x + 15$
- 5) (a) $x = 5.5$ cm (b) 32.5 cm (c) 11 cm
- 6) (a) $35 < x < 40$ (b) 36, 38, 39
- 7) (a) $x = (-2, -1, 0, 1, 2, 3)$ (b) $x = (0, 1, 2, 3, 4, _, _, _)$
 (c) $x = (3, 4, 5, 6, _, _, _)$ (d) $x = -7$
 (e) $x = 1$ (f) $x = 0$
- 8) 210 FRW 9) 108 books
- 10) (a) 21 (b) 44 (c) 56 (d) 0
- 11) (a) 14 (b) $\frac{1}{8}$ (c) -24 (d) $\frac{1}{4}$

End of Unit 11 Assessment

- (1) (a) $12x - 4b + 1$ (b) $5bdef$ (c) $6xz + 5xyz - 2yz$ (d) $y > 7$
- (2) The number is 40. (3) $x = 26$ (4) $p = 87$
- (5) $x > 4$ (6) a) $x = 8$ b) 35 cm c) 16 cm
- (7) a) $35 < x < 40$ years b) (36, 37)

Unit 12

Regular Polygons and Bearings

Key unit competence: To be able to use bearings and compass points and understand the relationship between them. To use the angle sum of a triangle to determine the interior angles of regular polygons.

List of lessons

Lessons	Number of lessons	Number of periods
12.1 Definition of polygons and their examples	1	1
12.2 Investigating the interior and exterior angles of a polygon.	1	1
12.3 Investigating the sum of interior angles and the sum of exterior angles of a regular polygon.	1	1
12.4 Elements of regular polygons: Finding the interior and exterior angles of a regular polygon.	1	1
12.5 Finding the sum of interior angles of a regular polygon.	1	1
12.6 Exterior angles and their sum.	1	1
12.7 Finding sides and apothem.	1	1
12.8 Finding perimeter of regular polygons.	1	1
12.9 Finding area of regular polygons.	1	1
12.10 Finding bearings and compass points.	1	1
12.11 Finding bearing	1	1
12.12 Tiling/construction	1	1
End of Unit 12 Assessment	1	2
Total	13	14

Guidance on problem statement

In this unit, learner will know more about regular polygons and bearings. Let learners brainstorm about different polygons that can be available in the surroundings. Let them think ideal with introduction in the Learner's Book, page 205.

Cross-cutting issues

Throughout the teaching process of this unit, it will be crucial to help learners to master the content and it is better to address cross-cutting issues where possible.

In this unit, we will address the following cross-cutting issues as non-stand alone within classroom activities and through the development of the content.

- **Peace and value education:** As a teacher, you have to be a peace-maker in the class and role model so that learners will imitate how you behave. When there is any conflict, do not leave without helping to solve it within the lesson. Encourage learners to behave well, being humble, honest, etc.
- **Gender education:** This cross-cutting issue will be addressed through giving equal opportunities to both boys and girls during the lesson.

Learning objectives

Knowledge and understanding

- Define a regular polygon.
- Name and identify regular polygons.
- Give the formula used to calculate the perimeter and area of a regular polygon.
- Explain that directions can be specified using compass points and bearings and express the relationship between them.
- Explain that bearings are measured in degrees, measured Clock-wise from North and written with three digits.
- Understand and use the angle sum of a triangle to determine the angle sum of a polygon.

Skills

- Derive the interior angle of a regular polygon.
- Use angle properties of regular polygons to decide whether or not they can tile the plane.
- Find the sum of interior/exterior angles of a regular polygon using the angle sum of a triangle.
- Calculate the length of the side, apothem, perimeter and areas of regular polygons.
- Use bearings to define direction.

Attitudes and values

- Work systematically when investigating mathematical challenges involving regular polygons.
- Appreciate the importance of regular polygons in every day life activities.
- Show concern for patience, mutual respect, tolerance, teamwork, spirit and curiosity in solving and discussing mathematics problems involving regular polygons.
- Appreciate the relevance of bearings in daily life (e.g. bearings are used by aircraft pilots and in tiling patterns in the built environment).

Number of lessons: 14**Guidance for classroom organisation**

- Before you start the lesson, first use warm-ups or energizers in order to engage learners into the lesson. Do not focus on this only, try to be creative.
- The essence is to motivate learners and make them active throughout the teaching- learning process. Help learners to form groups before you assign them an activity.
- While they are doing the activity, walk around while monitoring their work and helping where they have difficulties.

Learning and teaching materials for the unit

Manila cards, scissors, markers and masking tape and other materials that a teacher may see as important to achieve his/her objective.

Lesson 12.1**Definition of Polygons and their examples (40 minutes)*****Learner's Book, page 205*****Introduction**

- Preview 2D shapes. Let the learners list examples of 2D shapes they learned about in P.4.
- The list should include; square, triangle, rectangle, parallelogram, rhombus, kite, trapezium and others.
- Group the learners and let them get involved in the activity in the Learner's Book, page 205.
- Ask the learners to define a polygon. Write their responses on the chalkboard and make a class discussion.

Development

- Explain that all the shapes they mentioned are called polygons.
- More examples of polygons should be listed from the above.
- Tell the learners that a polygon is a simple closed figure/shape with straight line segments.
- Further explain that, some polygons have equal sides and others have sides of different measurement.
- Distribute polygon cards of different shapes.
- Let the learners study them, then mention their number of sides.
- Ask them how polygons are named.
- Write their contributions from the discussion.
- Now display the prepared chart.
- Ask learners to compare the polygon cards with the shapes on the chart.
- Let them read loudly the number of sides and the corresponding name of the polygon.

- Now refer the learners to the examples in the Learner's Book, page 206.
- Let a volunteer display a polygon card at a time as other members tell its number of sides then name it.
- Learners should read and recite the contents in the example repeatedly.
- Let learners draw the shapes of the polygons on sheets of paper to internalise their conformation.
- Emphasise the nature of regular polygons and irregular polygons.
- At this juncture, do not involve construction of regular polygons but base the teaching on the polygon cards.

Conclusion

- Let learners repeatedly read loud the Study tip.
- Learners do Application 12.1.
- Mark their work and help them do corrections.
- Involve all learners in extra work about drawing and naming polygons.

Lesson 12.2

Investigating the Interior Angle and Exterior Angle of a Regular Polygon (40 minutes)

Learner's Book, page 207

Introduction

- Review the names of polygons with their respective number of sides.
- Revisit the properties of regular polygons.
- Guide learners as they carry out the activity in the Learner's Book.
- Modulate the presentations thereafter.

Development

- Explain the meaning of interior angle and exterior angle.
- Refer to the examples through the procedure and methodology.
- Give learners time to study and follow through in order to internalise the procedure.
- Give more examples to the learners for more practice.

Example: Trace to draw a regular hexagon from a hexagon polygon card.

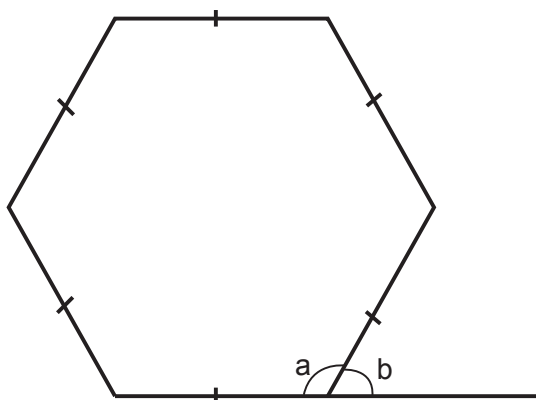

- Extend one edge using a ruler to form an interior angle and exterior angle. Name them a and b respectively.
- Use a protractor to measure a and b . $a = 120^\circ$ and $b = 60^\circ$.
- Therefore, the interior angle $a = 120^\circ$ and exterior angle $b = 60^\circ$.
- Give learners other polygon cards to do more practice.
- Move around the class supervising their work.

Conclusion

- Take the learners through the Study tip in order to internalise the concept.
- Then let the learners attempt Application 12.2 that follows.
- Mark their work and help them do corrections.
- Let the learners take notes.
- All learners should be given assignment in form of homework about investigating the interior and exterior angles of different polygons.

Lesson 12.3

Investigating the Sum of Interior Angles and the Sum of Exterior Angle of a Regular Polygon (40 minutes)

Learner's Book, page 209

Introduction

- Give mental work about supplementary angles, for examples, what is the supplement of:
 - (a) 120° (b) 36° (c) 90° (d) 45° , etc
- Let them explain why they get those answers they have presented.

Development

- Refer them to the activity in the Learner's Book.
- Guide them through the procedure in groups.
- Ensure the learners use the necessary learning aids, i.e, polygon cards, ruler, sharp pencil, protractor and sheets of paper.
- Lead them to discover that by using a protractor to measure interior angles of a regular pentagon measures 108° . Accept the error of 1° more or less than 108° . And, that a regular pentagon has 5 equal interior angles.
- Ask them to add them.
- Move around while monitoring their work.
- They are expected to have added like this:

$$108^\circ + 108^\circ + 108^\circ + 108^\circ + 108^\circ = 540^\circ$$
- Therefore, the sum of interior angles of a regular pentagon is 540° .
- Let them proceed to measuring the exterior angles.
- Monitor how they display the skill. Advise where necessary.

- They may not be very precise in accuracy. Help them to achieve the goal.
- Lead them to realise that each exterior angle measures 72° or close to 72° .
- Let them add the 5 exterior angles, i.e., $72^\circ + 72^\circ + 72^\circ + 72^\circ + 72^\circ = 360^\circ$.
- Learners present their findings to the class in their groups.
- Explain that the major competence is investigating the sum of interior angles and the sum of exterior angles of a regular polygon.
- Guide the learners through the examples in the Learner's Book.
- Strictly let learners discuss the sums of the interior and exterior angles by measuring not by use of a formula.

Conclusion

- Let the learners read the Study tip repeatedly for the benefit of internalising the competence.
- Ask them to attempt Application 12.3 in the Learner's Book.
- Monitor and evaluate their work, then help them do corrections.
- Correct their mistakes, then they take notes.

Lesson 12.4

Elements of regular polygons: Finding the Interior and exterior angles of a regular polygon (40 minutes)

Learner's Book, page 210

Introduction

- Review exterior angles of regular polygons.
- Distribute the learners in groups.
- Let learners get involved in the activity in the Learner's Book, page 210.
- Lead learners to realise that the relationship between the angles is that they are supplementary angles.

Development

- Define interior angles as angles that lie inside the vertices of polygons.
- Lead learners to deduce that, the sum of the interior and exterior angles of a polygon is 180° . (lie on a straight line).
- Distribute sheets of paper to the learners in groups.
- Tell them to draw polygons of their choice or you can distribute sheets of polygons.
- Let them extend lines (edges) to form exterior angles.
- Using protractors, let the learners measure the interior, then the exterior angle.
- Let them add them, then they discuss what the sum deduces.
- Now refer the learners to the examples in the Learner's Book, page 211.
- Let them follow through as you explain.
- Distribute flash cards.
- Let a participant in one group flash a card on which a certain angle is

scribbled e.g.; 96° 108° 84° 51° 72° 129°

- Then reciprocated by another member in another group flashing a supplementary one bearing an angle totalling to 180° .

Conclusion

- Conclude by emphasising that, the exterior angle and adjacent interior angle of a polygon are supplementary (add up to 180°).
- Learners are expected to have been exposed to supplementary angles. Therefore the lesson should be oriented to that concept.
- Learners should practically measure the interior and exterior angles to prove that they are supplementary.
- Learners read aloud the Study tip.
- Let them attempt the Application 12.4.
- Mark their work and help them do corrections.

Remedial Exercise

Let slow learners try out the following:

- (1) $90^\circ + \square = 180^\circ$ (3) $63^\circ + \square = 180^\circ$ (5) $180^\circ - \square = 45^\circ$
 (2) $135^\circ + \square = 180^\circ$ (4) $\square + 17^\circ = 180^\circ$ (6) $180^\circ - \square = 92^\circ$

Additional Exercise

Let fast learners try out the following:

- The interior angle of a polygon is twice the size of the exterior angle.
 - Calculate the size of the exterior angle.
 - Find the interior angle.
- The exterior angle of a polygon is 90° less than the interior angle.
 - What is the size of the interior angle?
 - Calculate the exterior angle.
- The interior angle of a polygon is $(r + 36^\circ)$ and the exterior angle is r° .
 - Calculate the size of the exterior angle.

Lesson 12.5

Finding the Sum of Interior Angles of a Regular Polygon (40 minutes)

Learner's Book, page 211

Introduction

- Review the previous lesson.
- Let learners form group and carry out the activity in the Learner's Book, page 211.
- Lead learners to realise that interior angle sum is got by adding all the inside angles of a regular polygon.

Development

- Distribute the sheets of regular polygons.
- Let the learners measure the interior angles of each regular polygon.
- On sheets of paper, let them record the sum of the interior angles of each regular polygon.

Examples: Triangle

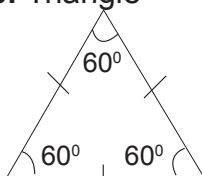

$$= 60^\circ + 60^\circ + 60^\circ = 180^\circ$$

Regular quadrilateral:

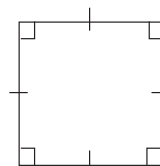

$$90^\circ + 90^\circ + 90^\circ + 90^\circ = 360^\circ$$

- Learners should measure and record interior angles for up to duodecagon or more.
- Now refer to triangulation.
- Learners should be reminded how many triangles has each polygon.
- Basing on the experienced fact in the lower classes, that the interior angle sum of a triangle is 180° , we can use it also to find the interior angle sum of a regular polygon.
- Referring to the poster of triangles in a polygon displayed yesterday, learners mention the number of triangles in each polygon.

Example: A hexagon has 4 triangles. But the interior angle sum of each triangle is 180° . So, learners realise that when the number of triangles in a polygon are added together, the interior angle sum of a polygon is realised. So, interior angle sum of hexagon = $180^\circ + 180^\circ + 180^\circ + 180^\circ = 720^\circ$ or number of triangles multiply by 180° .

- Let the learners draw polygons of their choice, triangulate them, then use the number of triangles to find the interior angle sum of the polygons drawn. They make a discussion then class presentation.
- They poster their work for display in class.
- Emphasise the use of angle sum of triangles other than the use of improvised method of $180^\circ (n - 2)$. It helps the learners to practically discover the interior angle sum of a given polygon. The use of $180^\circ (n - 2)$ can be used better when the polygon has so many sides.

Conclusion

- Let learners study and read the Study tip.
- Ask learners to attempt Application 12.5.
- Mark their work and give feedback.
- Help with the corrections, then learners take notes.

Lesson 12.6

Exterior Angles of Regular Polygons and their Sum (40 minutes)

Learner's Book, page 213

Introduction

- Review the previous work.
- Group the learners.
- Let them carry out the activity in the Learner's Book, page 213.
- Guide them to the correct answer.

Development

- Moderate a discussion about it.
- Distribute sheets of polygons to groups.
- Using a ruler and a pencil, let the learners extend lines along the angles of the polygons, then measure the angles formed between the extended lines and the edges of the polygons. For example:

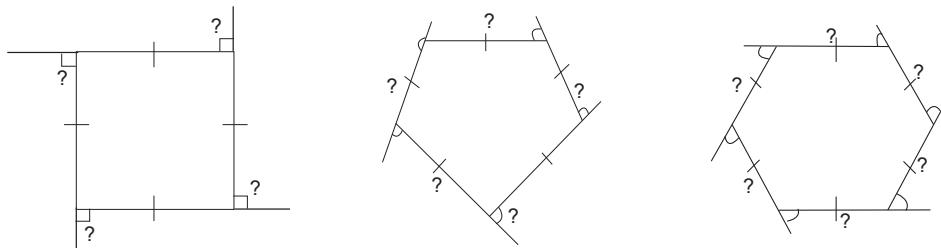

- Let the learners discuss their observations.
- Guide the learners to discover that all the angles outside the polygons are equal.
- And these angles outside the polygons are called exterior angles.
- Through measuring using a protractor, learners discover that;
- Each exterior angle of a regular equilateral triangle measures 120° .
- Each exterior angle of a regular quadrilateral (square) measures 90° .
- Each exterior angle of a regular pentagon measures 72° .
- Let the learners continue measuring up to a duo-decagon.
- Now, let the learners add all the exterior angles of each polygon. What do they observe by comparison?
- Lead learners to realise that; the exterior angle sum of a polygon is 360° .

- Bearing in mind that the exterior angle sum of a polygon is 360° , we can find each exterior angle without measuring using;

$$\text{Each exterior angle of a regular polygon} = \frac{\text{Exterior angle sum}}{\text{Number of sides}}.$$

- Learners study the examples in the Learner's Book, then discuss the procedure.
- Learners can find the unknown exterior angle, bearing in mind that all exterior angles add up to 360° .
- The activities and methodology above involves two subtopics; Exterior angle of a regular polygon and Exterior angle sum of polygons.
- Exterior angles of regular polygons are equal, unlike irregular polygons.
- Exterior angle sum of regular polygons is the same as angle sum of irregular polygons of the same type.

Conclusion

- Let learner read and internalise the Study tip.
- Let them attempt Application 12.6.
- Mark their work, then help with the corrections.
- Let the learners take notes.

Remedial Exercise

Let slow learners try out the following:

1. Name the shapes below;

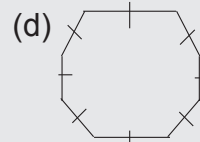
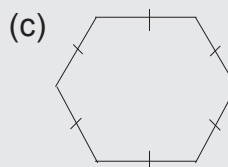
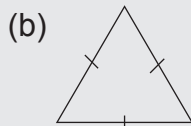
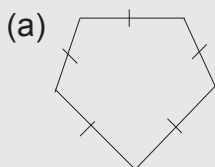

2. (a) What is the exterior angle of a regular triangle?

(b) Solve: (i) $p + p + p + p = 360^\circ$

(ii) $m + m + m + m = 360^\circ$

(iii) $y + y + y + y + y + y = 360^\circ$

(iv) $x + x + x + x + x + x + x + x = 360^\circ$

Additional Exercise

Let fast learners do the exercise below:

1. What is the exterior angle of a regular polygon with these sides?

(a) 15 sides

(b) 18 sides

(c) 20 sides

(d) 36 sides

2. Find the polygons with the exterior angles below;

(a) 45°

(b) 60°

(c) 12°

(d) 18°

(e) 30°

(f) 20°

Lesson 12.7 Finding Sides and Apothem (40 minutes)

Learner's Book, page 215

Introduction

- Review the previous work.
- Preview finding area of a triangle.
- Group the learners.
- Introduce the learners to the activity in the Learner's Book, page 215.

Development

- Learners should be led to realise that a pentagon has the number of triangles formed from its centre equal to the number of sides.
- And, that every side (edge) of the triangle becomes the base of the formed triangle.
- Explain that the line from the centre which is perpendicular to the side (edge) of a regular polygon is called apothem.
- The apothem, learners should observe, is the same as the height of the formed triangle.
- Lead learners in their groups to work and realise that, in order to find the area of a regular polygon, the area of each triangle is worked out using the side as the base and apothem as the height. i.e

$$\text{Area of 1 triangle} = \frac{1}{2} \times \text{side} \times \text{apothem}.$$

- Then the area of all the triangles is added together.
OR: The area of 1 triangle is multiplied by the number of triangles that can be formed in a regular polygon.

$$\text{i.e. Area of polygon} = \text{Number of triangles} \times \left(\frac{1}{2} \times \text{side} \times \text{apothem}\right)$$

- Give an example.
- Learners copy it onto sheets of paper and try it out.

Find the area of the hexagon below;

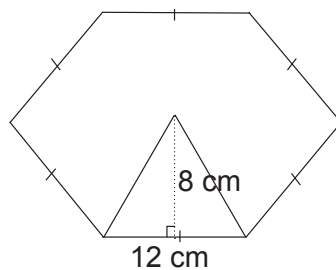

- Learners should identify the side to be 12 cm and apothem to be 8 cm.
- They should also observe that there are 6 triangles that can be formed in the regular hexagon.

So; Area = $6 \times \left(\frac{1}{2} \times \text{side} \times \text{apothem}\right)$

$$\text{Area} = 6 \times \left(\frac{1}{2} \times 12 \text{ cm} \times 8 \text{ cm}\right)$$

$$\text{Area} = 6 \times 1 \times 6 \text{ cm} \times 8 \text{ cm} = 288 \text{ cm}^2$$

Conclusion

- Now refer to the examples in the Learner's Book, page 215.
- Let the learners follow through the example as they discuss.
- Give several examples for learners to do practice.
- Each group through one participant presents its outcomes to the classmates.
- Liken the side of the polygon to the base and apothem to height of a triangle for quicker understanding.
- Emphasise that area can only be worked out using the experienced method for regular polygons only.

Conclusion

- Let learners read and internalise the Study tip.
- Let them attempt Application 12.7.
- Mark their work and help them do corrections.

Remedial Exercise

Slow learners do this exercise;

Divide the polygons named below into triangles from the centre.

(1) Square (2) Pentagon (3) Septagon (4) Octagon (5) Decagon

(6) Find the area of the shaded part:

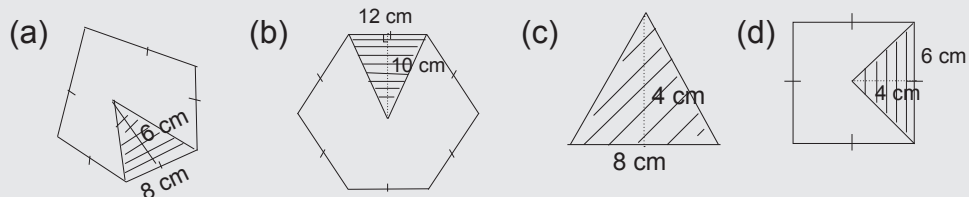

Additional Exercise

Gifted learners should do this exercise.

- Find the apothem of a square whose area is 96 cm^2 and a side of 6 cm .
- Work out the side of a pentagon with apothem of 10 cm and area of 300 cm^2 .
- What is the name of a regular polygon with apothem 14 cm , side of 18 cm and an area of 882 cm^2 ?
- Calculate for apothem of a regular octagon with side of 16 cm and area of 512 cm^2 .

Lesson 12.8**Finding Perimeter of regular polygons****Learner's Book, page 216****Introduction**

- Review the previous lesson.
- In groups, learners get involved in the procedure of the activity in the Learner's Book, page 216.
- Learners should be challenged to remember perimeter.
- They should remember that; perimeter is the distance around an enclosed figure/shape.
- Learners have experienced finding perimeter of a triangle, square, rectangle.

Development

- Now it is a continuation to find perimeter of other polygons like; pentagon, hexagon, septagon and others.
- Distribute polygon cards in groups of learners.
- Using strings, learners place them once around each polygon.
- In each group, one participant records the distance after measuring the length from the ruler.
- Learners realise that the distance measured on the string is the perimeter of the polygon.
- Now introduce the calculation method.
- Draw a regular polygon and write the distance of one side. Learners copy it on to sheets of paper.
- Then ask the learners to suggest how finding the perimeter of the polygon can be done.

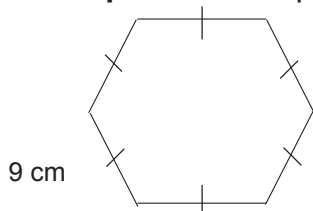
Example: Find the perimeter of the polygon shown below;

- Learners are expected to explain that, to find the perimeter we add 9 cm six times because the polygon has 6 sides.

$$\begin{aligned}
 \text{So perimeter} &= s + s + s + s + s + s \\
 &= 9 \text{ cm} + 9 \text{ cm} + 9 \text{ cm} + 9 \text{ cm} + 9 \text{ cm} + 9 \text{ cm} \\
 &= 54 \text{ cm}
 \end{aligned}$$

- Explain that alternatively, perimeter can be worked out by multiplying the distance of one side by the number of sides.

- Perimeter = number of sides \times side distance
- Refer to the examples in the Learner's Book, page 216.
- Let the learners study them, then follow through the procedure.
- Using sheets of regular polygons, learners use a string or centimetre ruler to measure the perimeter.
- Move around supervising their work.
- The exercise is expected to be a simple one because the learners were exposed to measuring different shapes in P.4 to find perimeter.
- So devise means of making it simpler.

Conclusion

- Learners read and internalise the Study tip.
- Let them attempt Application 12.8.
- Mark their work and help them to do corrections.

Lesson 12.9 Finding Area of Regular Polygons (40 minutes)

Learner's Book, page 218

Introduction

- Give mental work about names and properties of regular polygons.
- Review perimeter of polygons.
- Let learners carry out the activity in the Learner's Book, page 218 in groups.

Development

- Guide the learners to deduce the area of regular polygons.
- Learners discover that;
- Area of a regular polygon = $\frac{1}{2}$ of apothem multiplied by its perimeter.
- Write an example on the chalkboard.
- Ask the learners to copy it on the sheets of paper and using the method above, work out the area.

Example: Find the area of the polygon shown below.

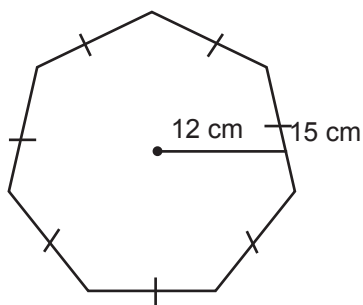

Working

Apothem = 12 cm, side = 15 cm

Perimeter = $7 \times 15 = 105$ cm

But area = $\frac{1}{2} \times$ apothem \times perimeter

Area = $\frac{1}{2} \times 12$ cm $\times 105$ cm

= $\frac{1260}{2} = 630$ cm²

- Let learners follow through the examples in the Learner's Book, page 218.
- Guide them through all the steps of the procedure.
- Learners formulate their own, work them out and discuss the outcomes.
- Using polygon cards and sheets of polygon, let learners measure the apothem and perimeter of every polygon.
- Then let them use the appropriate method to calculate their area.
- Follow their work by moving from group to group.
- Let them hold a discussion, then present the outcomes.
- Devise means of making learners able to understand the concept clearly.
- More practical measuring of perimeter and apothem is desired to help the learners understand better.

Conclusion

- Learners read and internalise the Study tip.
- Let them attempt Application 12.9.
- Mark their work and help them do corrections.

Remedial Exercise

Let slow learners attempt the exercise below:

Find the area of the polygons below:

Polygon	Side	Apothem	Area
Equilateral triangle	9 cm	6 cm	?
Square	10 cm	7 cm	?
Pentagon	3 cm	2 cm	?
Hexagon	4 cm	3 cm	?

Additional Exercise

Let fast learners attempt the exercise below:

1. The area of a regular polygon is 72 cm^2 . It has apothem of 6 cm, what is its perimeter?
2. The area of a regular polygon is $1,152 \text{ cm}^2$. Its perimeter is 144 cm. Find the length of its apothem.
3. The area of a regular polygon is $1,372 \text{ cm}^2$. Calculate its apothem if its perimeter is 196 cm.

Lesson 12.10 Finding Bearings and Compass Points (40 minutes)

Learner's Book, page 219

Introduction

- Give mental work about the eight points of a compass.
- In groups let learners get involved in the activity in the Learner's Book, page 219.

Development.

- Make use of a compass, if available to locate the points.
- Draw a compass on the classroom floor.
- Get a participant to stand in the middle. She turns according to instructions.
- Let the learners locate the North using the sunrise and sunset directions if the real compass is not available.
- Ask learners to demonstrate clock wise turning, then anti-clockwise turning.
- On the compass, let learners observe the angles between the compass points.
- Learners observe the following:

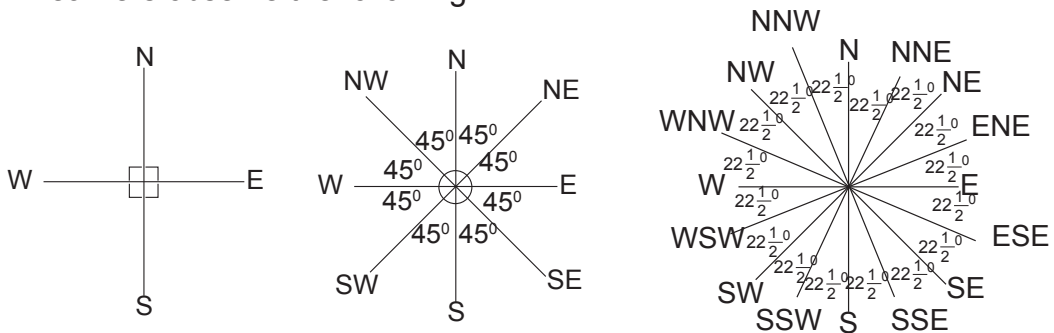

- Turning from the North to the right is turning clock-wise and turning from the North to the left is anti-clockwise.
- Turning can be done from one point to another clock-wise or anti-clockwise.
Example: Keza was facing Northwards. She turned clock-wise through 135° . What was her new direction?

Draw a sketch of a compass.

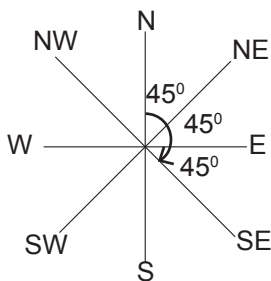

$$45^\circ + 45^\circ + 45^\circ = 135^\circ$$

The direction is South East (SE)

- Refer to the examples in the Learner's Book, page 220.
- Let learners by demonstration using the compass sketch on the classroom floor, prove the lay out and outcomes.
- Write more examples on the chalkboard as learners demonstrate to find the suitable directions.
- Then they draw the sketches on sheets of paper.
- They formulate their own and use the compass sketches on sheets of paper to work out the problems.
- Engage learners in various turns in order to understand better.

Conclusion

- Learners read and internalise the Study tip.
- Let learners attempt Application 12.10.
- Mark their work and help them do corrections.

Remedial Exercise

Let slow learners find the new direction by turning;

- | | |
|--------------------------------------|--|
| (a) Clock-wise 90° from North | (b) Anti-Clockwise 90° from North |
| (c) Clock-wise 45° from North | (d) Anti-Clockwise 45° from North |
| (e) Clock-wise 90° from East | (f) Clock-wise 90° from West. |

Additional Exercise

Let fast learners Find the new direction by turning;

- | | |
|---|--|
| (a) Clock-wise $157\frac{1}{2}^\circ$ from South-West | (b) Anti-Clockwise $67\frac{1}{2}^\circ$ from NNE |
| (c) Clock-wise $112\frac{1}{2}^\circ$ from ESE | (d) Anti-Clockwise $247\frac{1}{2}^\circ$ from WNW |
| (e) Anti-Clockwise 315° from SSE | (f) Clock-wise 270° from NNW. |

Lesson 12.11 Finding Bearing (40 minutes)

Learner's Book, page 221

Introduction

- Review the previous work.
- In groups, learners carry out the activity in the Learner's Book, page 221.

Development

- Distribute sheets of paper with prepared compass sketches like the ones below:

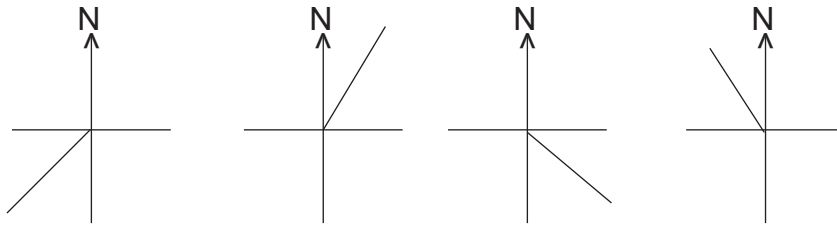

- Using the protractors, let the learners measure the angles clock-wise from the North compass point.
- Let learners discuss the outcomes and share with other classmates.
- Explain that the activities they are involved in are involving “finding bearing”
- Explain “bearing” as the angle between the North and the required direction turning clock-wise.
- Tell learners that bearing is expressed in degrees with 3 digits.
- Learners should observe that the degrees do not exceed 90° in bearing and compass direction, but are within the range of 90° between cardinal points near each other.
- In true bearing and opposite bearing, learners observe that the bearing can be less than 90° or more than 90° .
- Lead the learners through the examples explaining bearing procedures.
- Learners do more practice by forming their own problems.
- Involve learners in real practical work other than rendering them in imagination.
- Give learners situations where opposite directions are carried out in real life, e.g learners going from home to school and back home, people travelling on journeys and returning, etc.

Conclusion

- Learners read and internalise the Study tip.
- Learners do Application 12.11.
- Mark their work and help them do corrections.

Remedial Exercise

Let slow learners find the opposite directions for these compass directions.

- (1) North (2) South (3) East
 (4) West (5) North East (6) South West
 (7) Musoni moved from North West to school. In which direction will she face going back home?

Additional Exercise

Let fast learners attempt the exercise below:

The direction of the swimming pool from the parading ground is 027°E .

- (a) Draw a sketch.
 (b) What is the direction of the parading ground from the swimming pool?
 (c) Using the map of your local area, find the directions from one place to another, then find the opposite directions.

Lesson 12.12 Tiling/Construction (40 minutes)

Learner's Book, page 224

Introduction

- Review bearing handled in the previous lesson.
- Give mental work about the opposite compass directions.
- Group learners and distribute them suggested instructional materials.

Development

- Guide the learners through the activity in the Learner's Book.
- Ensure you lead them to discover how the art of laying tiles, making beautiful patterns is done.
- Let learners in their groups explain the importance of tiling in their daily life.
- Collect the observations and make different analysis harmonising the presentation.
- This is mostly a practical lesson.
- Ensure every learner is hands-on through the lesson.
- Refer to examples and lead the learners through it as they practically simplify it.
- Evaluate how articulate and precise the learners display their skills.
- Guide them in even more practice of tiling different polygons cards to form different patterns.

Conclusion

- Take the learners through the Study tip.
- Be more elaborate in the explanations to avoid confusion.
- Ask the learners to glue their tiling patterns on manila cards then poster them in the walls in the Mathematics corner.

- Guide them through Application 12.12.
- Move around supervising their work and helping where need be.
- Take them on a guided tour/visit to study and observe how tiling is done in construction.
- Visit different construction sites as learners record the tiling patterns and polygon shapes used.
- Back to the classroom, let the learners make presentation to class about their observations.
- Facilitate the discussions, then evaluate the learners outcomes.
- Correct the errors, and make a conclusive report.

Answers to Application 12.1

- 1) (a) Pentagon (b) Septagon (c) Nuo-decagon
 (d) Duodecagon (e) Square (f) Equilateral triangle
- 2) (a) 5 sides (b) 7 sides (c) 11 sides
 (d) 12 sides (e) 4 sides (f) 3 sides

Answers to Application 12.2

Check for correct figure and measurement.

- (a) Interior angle = 108° , exterior angle = 72° .
 (b) Interior angle = 138° , exterior angle = 52° .
 (c) Interior angle = 140° , exterior angle = 40° .
 (d) Interior angle = 120° , exterior angle = 60° .
 (e) Interior angle = 150° , exterior angle = 30° .
 (f) Interior angle = 138° , exterior angle = 52° .
 (g) Interior angle = 144° , exterior angle = 36° .
 (h) Interior angle = 90° , exterior angle = 90° .
 (i) Interior angle = 120° , exterior angle = 60° .
 (j) Interior angle = 90° , exterior angle = 90° .
 (k) Interior angle = 147° , exterior angle = 33° .
 (l) Interior angle = 135° , exterior angle = 45° .

Answers to Application 12.3

- (a) $540^\circ, 366^\circ$ (b) $900^\circ, 360^\circ$ (c) $1,260^\circ, 360^\circ$ (d) $720^\circ, 360^\circ$
 (e) $1800^\circ, 360^\circ$ (f) $900^\circ, 360^\circ$ (g) $1,440^\circ, 360^\circ$ (h) $360^\circ, 360^\circ$
 (i) $180^\circ, 360^\circ$ (j) $360^\circ, 36^\circ$ (k) $620^\circ, 360^\circ$ (l) $1,080^\circ, 360^\circ$

Answers to Application 12.4

- (1) a) 104° b) 55° c) 57° d) 90°
 e) 40° f) 115° g) 71° h) 57°
- (2) a) 60° b) 135° c) 122° d) 45°
 e) 115° f) 55° g) 95° h) 36°

Answers to Application 12.5

1. (a) 1080° (b) 900° (c) $1,260^\circ$ (d) $1,440^\circ$
 (e) 180° (f) 360° (g) 360° (h) 720°
 (i) 540°
2. (a) $1,620^\circ$ (b) $2,340^\circ$ (c) $2,700^\circ$ (d) $1,080^\circ$
 (e) $1,080^\circ$ (f) $1,260^\circ$ (g) $2,160^\circ$ (h) 360°
 (i) $3,240^\circ$
3. (a) 4 sides (b) 5 sides (c) 6 sides (d) 7 sides
 (e) 9 sides (f) 10 sides

Answers to Application 12.6

1. (a) 72° (b) 90° (c) 120°
2. (a) 45° (b) 36° (c) 72° (d) 40°
 (e) 30°
3. 6 sides
4. (a) Exterior angle 60° , Interior angle 120° (b) hexagon
5. (a) 60° (b) 45°

Answers to Application 12.7

- (1) An apothem is the distance from the centre of a polygon perpendicular to the side of a polygon.
- (2) Side is length from one end to another around a polygon.

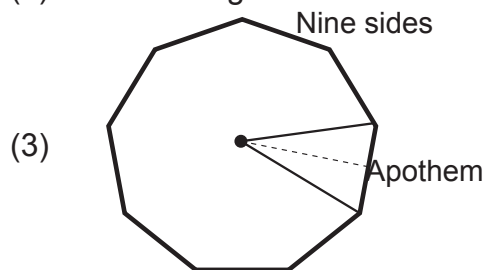

(4) 6 cm

(6) 4 cm

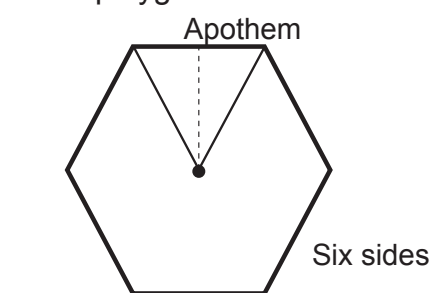

(7) 6 cm

Answers to Application 12.8

- (1) 32 cm (2) 50 cm (3) 21 cm (4) 30 cm
 (5) 40 cm (6) 36 cm (7) 120 cm (8) 93 cm
 (9) 115.2 cm

Answers to Application 12.9

- (1) 60 cm² (2) 72 m² (3) 20,000 m² (4) 108 cm²
 (5) (a) 240 cm² (b) 240 cm² (6) 480 cm² (7) 480 cm²
 (8) 1,890 cm²

Answers to Application 12.10

- (1) a) Northeast b) Southwest c) West d) North
 e) Northwest f) SSE
 (2) a) N50oE b) 545oE c) W30oN d) W55oS

Answers to Application 12.11

- (1) a) The bearing of x from y is 220°.
 b) The bearing of p from o is 300°.
 c) The bearing of w from u is 125°.
 d) The bearing of A from B is 080°.
 (2) The bearing of B from A is 278°.
 (3) a) 090° b) 270° c) 142° d) 322°
 (4) a) 230° b) 050° c) 130° d) 310°

Answers to application 12.12

Teacher should oversee and evaluate the activities, then advise accordingly.

End of unit 12 Assessment

- (1) (a) 1,440° (b) 900°
 (c) 1,080° (d) 540°
 (e) 180° (f) 720°
 (2) (a) 5 sides (b) 11 sides (c) 6 sides
 (3) (a) 28°, 49°, 71°, 93°, 119°
 (4) 24 cm (5) 62 cm² (6) 45° (7) 1,080 cm²
 (8) 090° (9) 45 cm (10) 12 sides (11) 270°
 (12) a) Check for correct pattern (b) 100 tiles
 (13) a) 090° b) 225° c) 045° d) 270°
 (14) 215° (15) 040°

Unit 13

Construction of Polygons and Nets for Cuboids and Prisms

Key unit competence: To be able to construct polygons using a protractor, a ruler and a pair of compasses. Design nets to make cuboids and prisms.

List of lessons

Lessons	Number of lessons	Number of periods
13.1 Drawing triangles using protractor and ruler.	1	1
13.2 Drawing a square using protractor and ruler.	1	1
13.3 Drawing a rectangle using protractor and ruler.	1	1
13.4 Drawing a regular pentagon using protractor and ruler.	1	1
13.5 Drawing a regular hexagon.	1	1
13.6 Constructing triangles using compasses and ruler.	1	2
13.7 Constructing triangles using compasses and ruler.	1	2
13.8 Constructing a square using compasses and ruler.	1	2
13.9 Finding the centre angle of a regular polygon.	1	1
13.10 Constructing a regular pentagon and hexagon.	1	1
13.11 Constructing a regular septagon and octagon.	1	1
13.12 Constructing a regular nonagon and decagon.	1	1
13.13 Designing nets of cuboids, cubes and prisms.	1	1
End of Unit 14 Assessment	1	2
Total	14	18

Guidance on problem statement

In this unit, learners will know more about construction of polygons and nets for cuboids which will lead to the use of net properties in making different object, e.t.c. Take learners through imagination about the importance of constructing polygons and let them go through the introduction in the Learner's Book, page 229.

Cross-cutting issues

Throughout the teaching process of this unit, it will be crucial to help learners to master the content and it is better to address cross-cutting issues where possible. In this unit we will address the following Cross-cutting issues as non-stand alone within classroom activities and through the development of the content.

- **Peace and value education:** As a teacher, you have to be a peace-maker in your class and role model so that learners will imitate how you behave. When there is any conflict, do not leave without helping to solve it within the lesson. Encourage learners to behave well, being humble, honest, etc.
- **Gender education:** This cross-cutting issue will be addressed through giving equal opportunities to both boys and girls during the lesson.

Learning Objectives

Knowledge and understanding

- Show how to construct polygons with given properties using a protractor, ruler and compasses.
- Demonstrate how a 2D shape can be folded to make a 3D solid and name the 2D shape used.
- Show that the net of a solid is not unique.

Skills

- Construct polygons using a protractor, ruler and compasses.
- Explore different strategies for constructing polygons with given properties.
- Design nets to make cuboids and prisms.

Attitudes and values

- Appreciate that there are likely to be a number of different successful approaches to accurately construct a polygon or designing a net.

Number of lessons: 18

Guidance for classroom organisation

- Before you start the lesson, first use warm-ups or energizers in order to engage learners into the lesson. Do not focus on this only, try to be creative.
- The essence is to motivate learners and make them active throughout the teaching- learning process. Help learners to form groups before you assign them an activity. While they are doing the activity, walk around while monitoring their work and helping where they have difficulties.

Learning and teaching materials for the unit

Manila cards, scissors, markers and masking tape and other materials that a teacher may see as important to achieve his/her objective.

Lesson 13.1 Drawing Triangles Using a Protractor and Ruler (40 minutes)

Learner's Book, page, 229

Introduction

- Start mental work on triangles e.g, name the types of triangles.
- In groups let learners carry out the activity in the Learner's Book, page 229.

Using a protractor and a ruler, draw a right angle, angle 65° and angle 120° .

Explain your working steps.

Present your working out to the rest of the class.

- Give chance to each group to present its findings.
- Introduce the subunit.

Development

- Guide learners through an example
E.g: Construct triangle ABC with $AB = 7$ cm, $AC = 6$ cm and angle $BAC = 70^\circ$.
- Guide learners through the steps;
 - Step 1: Draw a long line (the base line).
 - Step 2: Measure 7 cm and cut it off on the base line.
 - Step 3: Use protractor to draw 70° at point A.
 - Step 4: Measure off 6 cm from A to make AC using ruler.
 - Step 5: Join point B to C using ruler and a pencil.
- Ensure that all measurements are accurate i.e. the line segments and the angles.
- Ask learners to study and work along the example in the Learner's Book, page 229.
- Move around observing the learners to ensure that they;
 - use the tools skillfully.
 - measure angles and lengths accurately.
 - use sharp pencils.
- Emphasise the right procedures, use of sharp pencils and avoiding to use thick lines.

Conclusion

- Explain how angles are represented e.g. $ABC = B$.
- Always check through the learners construction to ensure accuracy.
- Let the learners read and analyse the Study tip.
- Let them attempt Application 13.1.
- Mark their work and help them do corrections.

Remedial Exercise

Give more numbers to slow learners where the lengths are whole numbers not decimal numbers and the angles assigned to them multiples of ten and acute.

Additional Exercise

Prepare more numbers for the fast learners;

1. Draw triangle CDE with $CD = 9$ cm, $EC = 7$ cm and $CDE = 80^\circ$.
2. Draw triangle KLM such that $KL = LM = 7.5$ cm and $KLM = 65^\circ$.
3. Draw triangle XYZ where $XY = 10$ cm, $X = 70^\circ$ and $Y = 70^\circ$.
4. Draw triangle EFG where $EF = 6.5$ cm, angle $E = F = 55^\circ$.

Lesson 13.2**Drawing a Square Using a Protractor and Ruler (40 minutes)**

Learner's Book, page 233

Introduction

- Review naming 2-dimension shapes (triangle, square, rectangle and so on).
- Ask learners to state the properties of a square.
- In groups let learners carry out the activity in the Learner's Book, page 233.
- Guide learners through an example.

Development

- Example: Draw a square ABCD whose side is 7 cm.
- Take learners through the steps with illustrations.

Note that these properties should be indicated;

- each angle is a right- angle or 90° .
- all sides are equal.

- Begin with drawing a long straight line
- Measure off 7 cm using a ruler to get points A and B.
- Label the lengths.
- At point A draw 90° using a protractor.
Emphasise that the vertical line at A must be long.
- At point B also draw 90° using a protractor.
Emphasise that the vertical line at B should be long.
- Measure 7 cm from A following the vertical line. Where 7 cm mark is from A, label D.
- Measure 7 cm from B following the vertical line. Where 7 cm mark is from B label C.

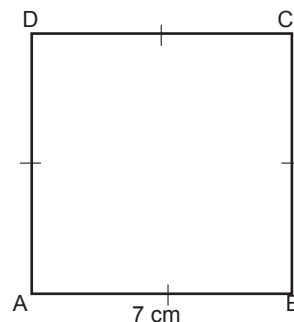

- (viii) Join points C and D using a straight line.
- (ix) Include the symbols for equal sides and right angles.
- (x) Label it and name the square ABCD.

- Allow learners to ask as many questions as they can.
- Inform learners that drawing a square and a rectangle have the same procedures.
- Let learners study and try out the example in the Learner's Book, page 233.

Conclusion

- Guide learners through the Study tip.
- Let learners attempt Application 13.2.
- Mark their work and give feedback.
- Help learners to make corrections.
- Let them take the notes.
- Help learners to realise that constructing squares and rectangles follow the same steps.

Remedial Exercise

Let slow learners do the exercise below:

1. Draw a square whose sides are 4 cm.
2. Draw a rectangle CDEF of $CD = 6$ cm and $CF = 3$ cm.

Additional Exercise

Let fast learners attempt the exercise below:

1. Draw a square of sides 5.5 cm.
2. Draw a square whose side is 6.8 cm. Measure the diagonals of the square.

Lesson 13.3

Drawing a Rectangle Using a Protractor and Ruler (40 minutes)

Learner's Book, page, 234

Introduction

- Give mental work about properties of a rectangle.
Example: (a) How many sides has a rectangle?
(b) Are all the four sides equal? Why?
(c) How many angles has a rectangle?
(d) Are they equal?
(e) What is the measure of each interior angle?
- Review the previous lesson.
- Let learners form groups and you distribute learning materials.
- Let them do the activity in the Learner's Book.

Development

- Learners were taught about properties of a rectangle in P.4.
- It is the basis upon which the lesson is centred.
- Learners will be aided to remember that:
 - (a) A rectangle has two opposite, equal parallel sides.
 - (b) The four angles of a rectangle are equal and they measure 90° each.
- Refer to the example in the Learner's Book.
- Let learners read the statement and draw a sketch indicating all the information that is given in the question.
- Move around monitoring the sketch draw by various groups.
- Draw the same on the chalkboard.
- Check well for sharpened pencils, ruler with straight edges and readable protractors.
- Let learners read step by step as they follow the instructions.
- Move around guiding them on how to manipulate the instruments and drawing accurately.
- Let learners take time to think about what is to be done in a step before embarking on it.
- Having finished step 4, declare that, the concept of drawing a rectangle using a protractor and ruler has been completed successfully.
- Ensure you check for accurate drawing of the 4 sides and 4 equal angles.

Conclusion

- Collect the instructional materials and their work on paper.
- Poster their work on manila cards for display.
- Let learners read the Study tip.
- Let them attempt Application 13.3.
- Move around monitoring how efficient they are.
- Mark their work and help them do corrections.
- Give an extra exercise in form of an assignment or homework such that they do more practice.

Lesson 13.4**Drawing Regular Pentagon Using a Protractor and Ruler
(40 minutes)*****Learner's Book, page 236*****Introduction**

- Review naming 2-dimension shapes, angles on polygons and how to get them.
- Ask learners to form groups and ask them to carry out the activity in the Learner's Book, page 236.
- Guide each group as they carry out the activity. Give them time for presentation.
- Explain the intention of the lesson.

Development

- Guide learners through an example.

Example: Construct a pentagon ABCDE whose sides are 3.2 cm.
- Demonstrate each step to the learners as they work along.
- Step 1: Calculate the exterior and interior angle:

i.e - exterior angle of a regular polygon = $\frac{360^\circ}{\text{number of sides}}$

- exterior angle of a regular pentagon = $\frac{360^\circ}{5} = 72^\circ$
- Calculate the interior angle;

$180^\circ - \text{exterior angle} = \text{interior angle}$

$180^\circ - 72^\circ = 108^\circ$

 - (a) Draw a long straight base line.
 - (b) Measure off 3.2 cm and label points A and B.
 - (c) Use protractor and draw 108° at point A. The angle should face to the right.
 - (d) Then use a protractor to draw 108° at point B. The angle should face to the left.
 - (e) Start from A and move along the upward line to measure off 3.2 cm. Label point E.
 - (f) At point E, measure and draw 108° . It should face to the right.
 - (g) From point B, along the line going up, measure off 3.2 cm and label point C.
 - (h) The point where line from E meets line from C should be labeled D.
- Ensure that the final drawing is labeled and it is accurate.
- You may ask learners to try out the same number you have demonstrated in the example.
- Let learners also attempt the example suggested in the Learner's Book, page 237.

Conclusion

- Guide learners through the Study tip.
- Let learners attempt Application 13.4.
- Mark their work and help them do corrections.
- Sometimes it becomes a little hard for learners to draw angles bigger than 90° (obtuse angles). Ensure that you practise drawing such angles.

Remedial Exercise

You may help the slow learners on a one-to-one basis and ask them to try out some construction for example, Construct a regular pentagon of sides 3 cm.

Additional Exercise

Let fast learners draw a regular pentagon of sides: (a) 4.5 cm (b) 3.8 cm

Lesson 13.5 **Drawing a Regular Hexagon (40 minutes)**

Learner's Book, page 238

Introduction.

- Review the previous lesson.
- Let learners form groups and distribute to them the necessary learning materials.
- Let learners get involved in the activity in the Learner's Book.

Development

- Facilitate the discussion and come up with a general report.
- Learners learned about a hexagon and its properties in Unit 12.
- It is this awareness they are going to use in this lesson.
- Tell learners that the main competence to be achieved in this lesson is to draw a regular hexagon using a protractor and ruler correctly.
- Refer to the example in the Learner's Book.
- Ask learners to read it repeatedly in order to follow the instructions very well when drawing.
- Move around checking for straight-edged ruler, readable protractor scales and well sharpened pencils.
- On sheets of paper, let learners draw a sketch of a hexagon with the properties given in the question.
- Check for: (a) side of 3.5 cm
(b) interior angle of 120° .
(c) symbols indicating equal sides.
(d) six sides
(e) vertices named STUVWX
- Draw a similar sketch on the chalkboard.
- Now lead learners through each step of drawing.
- Move around to all groups to monitor how they manipulate the instruments and accuracy in drawing.
- Learners should be given enough time to articulate the concept.
- When they are done, declare that the polygon hexagon STUVWX has been successfully drawn.
- Collect their work to be displayed in class.

Conclusion

- Let learners read the Study tip.
- Then they attempt Application 13.5.
- Follow how they carry out drawing to accuracy.

- Help them where they get challenges.
- Mark their work and help them do corrections.
- Give extra exercise to all learners in form of assignment, revision work or homework such that learners do more practice.

Lesson 13.6

Constructing Triangles Using a Ruler and a Pair of Compasses (80 minutes)

Learner's Book, page 240

Introduction

- Review drawing lengths using ruler and pencil.
- In groups let learners carry out the activity in the Learner's Book, page 240.
- Guide each group as they discuss and construct.

Development

- Guide learners through an example; illustrate and demonstrate the steps.
Example: Construct triangle ABC where $AB = 8$ cm, $BC = 6$ cm and $AC = 5.5$ cm.
- Guide learners through the steps:
 - (i) Help them to come up with a correct labeled sketch
 - (ii) Draw a long line using pencil and ruler.
 - (iii) Open or adjust your pair of compasses to measure 8 cm.
 - Demonstrate using the chalkboard compasses.
 - Ensure that every learner sees what you do.
 - You may move to each group as you demonstrate, so that they see clearly.
 - (iv) Using the length measured, mark it on the line drawn in (ii). Draw the arcs using compasses.
 - (v) Label the points to make $AB = 8$ cm.
 - (vi) Now measure 5.5 cm using pair of compasses and a ruler.
 - (vii) Fix the compasses needle at A, draw an arc up.
 - (viii) Now adjust your compasses and measure 6 cm. Place the compasses needle at B and draw an arc of radius 6 cm up to meet the first arc you drew of radius 5.5 cm.
 - (ix) Hold a ruler and a pencil and draw;
 - A straight line from A to the point where arcs meet.
 - A straight line from B to the point where arcs meet
 - Help learners to realise that the triangle is already done.
 - (x) Now ask a learner to come and label the constructed triangle.

- Ask learners to try out the steps you have done by constructing the same triangle.
- Let the fast learners also try out the suggested example in the Learner's Book, page 240.
- Move around observing learners' work to ensure that they do the right thing.
- There is no need for rushing through the steps since learners are learning new concepts and skills.
- You may spend the whole period just helping learners to try out examples. In the next lesson you may allow them to attempt the exercise.

Conclusion

- Guide learners through the Study tip.
- Help them to construct more triangles.
- Help them practice the skills to become perfect.
- Let learners attempt Application 13.6.

Remedial Exercise

Let slow learners re-do Application 13.6

Additional Exercise

Let fast learners construct the following;

- (1) Triangle CDE with $CD = 7$ cm, $DE = 8$ cm, $CE = 6$ cm.
- (2) Triangle XYZ with $XY = 10$ cm, $XZ = 7.5$ cm and $YZ = XZ$.
- (3) JKL of sides 6.5 cm and measure angle JLK.
- (4) Construct the following triangle:
 - (a) FGH where $FG = 7$ cm, $G = 60^\circ$ and $GH = 6$ cm.
 - (b) MNO with $MN = MO = 7.5$ cm and $OMN = 45^\circ$

Lesson 13.7

Constructing a Rectangle Using a pair of Compasses and a Ruler Only (80 minutes)

Learner's Book, page 243

Introduction

- Review properties of rectangles and squares.
- Review constructing a right angle.
- Let each group carry out the activity in the Learner's Book, page 243.

Development

- Follow up the group presentations and allow each group to display its work.
- Guide learners as you demonstrate the steps in the examples: Construct a rectangle KLMN such that $KL = 7$ cm and $LM = 5$ cm.
- Guide learners through the steps and encourage them to work along.
Steps:
 - (a) Draw a long straight line using ruler and sharp pencil.
 - (b) Using a pair of compasses, adjust it to make a length of 7 cm on a ruler.

- (c) Cut off 7 cm from the line you drew in (b) using arcs.
- (d) Label points K and L, 7 cm to make $KL = 7$ cm.
- (e) Use pair of compasses and construct 90° at K then at L.
- (f) Measure 5 cm using a pair of compasses from a ruler.
- (g) Place the compasses needle at K and draw the arc to make a length of 5 cm. Label the point N.
- (i) Place the compasses with a length of 5 cm, at L and draw an arc to make segment $LM = 5$ cm.
- (j) Label the fully constructed rectangle correctly.

- Ask learners to try constructing the same.
- Move around observing to help those with challenges.
- Let the fast learners now attempt the example in Learners Book, page 243.
- Ensure that every construction is accurately done.
- Help learners to organise their presentation and let them take notes.

Conclusion

- Guide learners through the Study tip.
- Let learners attempt Application 13.7.
- Mark their work and help them in doing corrections.
- Help learners to realise that constructing squares and rectangles follow the same steps.

Remedial Exercise

Let slow learners re-do Application 13.7.

Additional Exercise

Fast learners construct rectangles and triangles of the given sides;

- (a) Rectangle with sides of 3.2 cm and 4.2 cm.
- (b) Rectangle with sides of 3.8 cm and 4.6 cm.
- (c) Rectangle with sides of 4.2 cm and 3.8 cm.
- (d) Rectangle with length 5.6 cm and width 3.2 cm
- (e) Rectangle with length 6.3 cm and width 3.8 cm

Lesson 13.8

Constructing a Square Using a pair of Compasses and a Ruler (80 minutes)

Learner's Book, page 244

Introduction

- Give mental work about the properties of a square.
- Review the previous work.
- Let learners get into groups.
- Let them access the suggested instructional materials.
- Get learners to be involved in the activity in the Learner's Book.

- Guide learners and moderate their findings to make a general report.

Development

- Learners are expected to come up with the following from the activity.

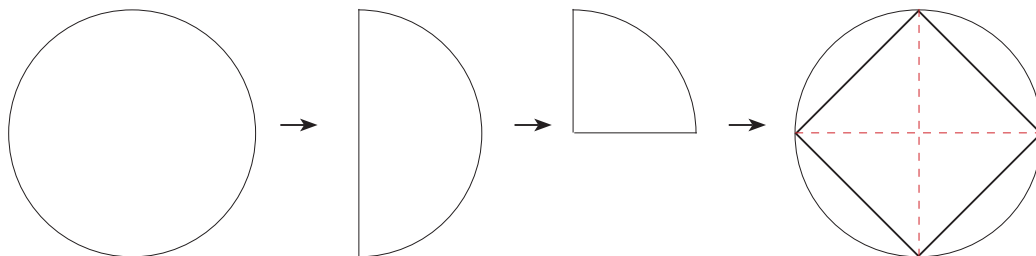

- When measured, the sides have equal length. It has 4 sides. Even the angles are equal and all measure 90° . Therefore, it is a square.
- Refer to the example in the Learner's Book.
- Let learners read the instruction.
- They already learnt about properties of a square in P.4. So in construction, they are practically worked out and shown.
- Check for good working conditions of the instruments.
- On sheets of paper instruct learners to draw a sketch of a square with each side labelled 3.5 cm.
- Move around monitoring the sketch and advising accordingly.
- Demonstrate how to fix a pencil in compasses.
- The pencil should be firmly fixed into the compass.
- Let learners carry out step by step as instructed in the example.
- Demonstrate how to handle and manipulate a compass during construction.
- Guide learners through every step. Each learners must have a chance to be involved in the practice.
- Check for accuracy. Let learners repeat the construction process as many time as time can allow.
- Finally let them poster their work. Then the teacher displays it in the class.

Conclusion

- Declare that the steps laid out in the example, are the ones used to construct a square accurately.
- Let learners read the Study tip.
- Let them attempt Application 13.8.
- Guide them whenever they need help.
- Mark their work as you check for accuracy in construction.

Remedial Exercise

Let slow learners should continue with re-doing the Application.

Fast learners can be given extra work of construction as the teacher may decide.

Lesson 13.9 Finding the Centre Angle of a Regular Polygon (40 minutes)

Learner's Book, page 246

Introduction

- Review the previous work.
- Group the learners.
- Give out the suggested instructional materials.
- Let learners carry out the activity as laid out in Learner's Book.
- Guide them through the procedure, harmonises their outcomes. Then come up with a general report.

Development

- From the observation in the activity, when diagonals of a regular polygon intersect, they form equal angles at the centre.
- These angles are known as centre angles.
- Let learners observe that the number of centre angles is equal to the number of sides of a polygon.
- Refer to the examples in the Learner's Book.
- Let learners draw a regular pentagon as formerly learnt in lesson 13.4
- Using a protractor let learners bisect two interior angles of 108° .

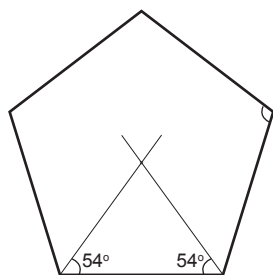

Note:

A triangle will be formed.

It will have 2 base angles of 54° each.

Measure the angle formed at the centre.

Accurately measured, the angle at the centre is 72° .

- In case all the interior angles are bisected, learners will observe that each centre angle of a regular polygon is 72° .
- Angles at a point add up to 360° .
- In another instance, it has been observed that the number of centre angles is equal to the number of sides. So, by dividing the number of centre angles into 360° , each centre angles will be obtained.
- Lead learners through the rest of the steps in the examples in the Learner's Book.
- Learners observe that:

$$\begin{aligned}\text{Centre angle of a regular pentagon} &= \frac{\text{Sum of centre angles}}{\text{Number of centre angles}} \\ &= \frac{360}{5} = 72^\circ\end{aligned}$$

$$\text{Centre angle of a regular octagon} = \frac{360}{8} = 45^\circ$$

- Explain further that the value of a centre angle of a regular polygon is equal to the value of its exterior angle.

Conclusion

- Let learners read repeatedly the Study tip. It helps them to internalise the concept.
- Learners attempt Application 13.9 in the exercise books.
- Mark their work and help them do corrections.

Remedial Exercise

Slow learners should continue with re-doing the Application to master the skill.

Additional Exercise

Fast learners should attempt the exercise below:

Draw the following regular polygons, bisect the interior angles, then find the centre angle of each of them.

- (a) Square (b) Octagon (c) Equilateral triangle (d) Hexagon

Lesson 13.10 Constructing a regular Pentagon and Hexagon (40 minutes)

Learner's Book, page 247

Introduction

- Give mental work about the properties of a regular pentagon and regular hexagon.
- Review finding centre angles of regular polygons.
- Form groups among learners and distribute instructional materials.
- Involve learners in the activity in the Learner's Book.

Development

- Lead learners through all the steps in the activity.
- Ensure learners use a sharpened pencil, ruler with straight edges, readable scales on the protractor and a properly fixed pair of compasses.
- Move from one group to another supervising the activity.
- In case learners have difficulty, demonstrate using the chalkboard instruments.
- Move back to groups to check on the progress.
- Finally, learners will observe that the polygon formed is a regular pentagon. And that it has 5 equal sides.

- Collect the work, post it and display it in the Mathematics corner.
- Refer learners to the example in the Learner's Book.
- Let learners on their own, demonstrate the skills they acquired in the activity.
- Move around monitoring every step.
- Ensure learners take time to carry out every step satisfactorily. Do not rush them.

Conclusion

- Let learners read the Study tip several times. This will help them to internalise the concept and achieve the competences desired.
- Learners attempt Application 13.10 in their exercise books.
- Monitor how they display the acquired skills.
- Mark their work and help them do corrections.

Remedial Exercise

Slow learners should continue with re-doing the Application to master the skill.

Additional Exercise

Fast learners should try out constructing regular pentagons and hexagons with different sides formulated by themselves.

Lesson 13.11 Constructing a Regular Septagon and Octagon (40 minutes)

Learner's Book, page 250

Introduction

- Give mental work about the properties of a regular septagon then after, about the properties of a regular octagon.
- Distribute learners in groups and give learners desirable learning aids.
- Let learners be engaged in the activity in the Learner's Book.
- Ensure learners use instruments in good working condition.

Development

- Learners have already been exposed to drawing septagons and octagons using a protractor and ruler.
- They have already learnt about finding the centre angles of regular polygons.
- It is upon this basis that learners build on to be able to construct regular polygons using compasses and ruler.
- Ask learners to draw sketches on sheets of paper you provided.
- Look at them to confirm they are of a septagon and octagon.
- Slowly, but systematically, lead the learners in construction step by step as laid out in the activity.
- Guide them as you monitor their procedure. Advise accordingly.

- Every step, write it on the chalkboard before they carry it out practically.
- Follow every step as you monitor the learners.
- Conclusively, learners will give explanations as follow:
 - A septagon has 7 sides. It has 7 interior angles.
 - Each interior angle of a septagon measures approximately 128° .
 - An octagon has 8 sides. It has 8 interior angles.
 - Each interior angle of an octagon is 135° .
- Now refer to the examples in the Learner's Book.
- Lead learners to study every step as you explain.
- Check on the learners as they display the skills.
- Ensure they work according to the instructions in the steps.

Conclusion

- Ask the learners to read the Study tip. Let them contribute more according to their observations. Discuss them.
- Let them attempt Application 13.11.
- Check on their practical skills and guide where necessary.
- Mark their work and help them do corrections.
- Give as much practical work to learners for more practice.
- Guide them whenever they get challenged. The extra work may be in form of revision exercise, homework or assignment.

Lesson 13.12 Constructing a regular Nonagon and Decagon (40 minutes)

Learner's Book, page 253

Introduction

- Give mental work about the properties of a regular nonagon then after, about the properties of a regular decagon.
- Review the previous work.
- Form groups among learners. Ensure your groups are comprised of girls and boys. They should also be mixed with slow and fast learners.
- Let learners access the suggested instructional materials.
- Refer them to the activity in the Learners Book.
- Learners should use instructional tools in good working condition.
- On sheets of paper, tell learners to draw sketches of a nonagon and decagon.
- Move around to check whether they have drawn the correct polygon.
- Guide them through the activity in the Learner's Book.
- Follow every step they carry out as mentioned in the activity in the Learner's Book.
- If handled well, it is expected learners will not get challenges because they have been subjected to proper use of the construction tools.

- Learners have already worked out centre angles of a nonagon. So they can easily identify the figure to be a nonagon, having a centre angle of 40° , regular or equal sides which are eight.
- On measuring, learners prove that the interior angles of a regular nonagon measure 140 and those of a regular decagon measure 144.
- Now refer learners to the examples in the Learner's Book.
- Let learners read the instructions.
- Ask them to interpret every step as they construct.
- Guide them through all the steps slowly, for the benefit of understanding the concept very well.
- Monitor every step to your satisfaction. Help learners with difficulties to achieve the desired skills.

Conclusion

- Let learners read the Study tip. They also contribute more according to their observation.
- Let them attempt Application 13.12.
- Guide them to construct correct polygons.
- Mark their work as you move from one group to another.
- Correct mistakes as you move.
- Give extra work to all learners for more practice.

Lesson 13.13 Designing Different Nets of Cuboids, Cubes and Prisms (40 minutes)

Learner's Book, page 257

Introduction

- Review naming 3-dimensional objects.
- Ask learners to identify faces, vertices and edges on 3D figures.
- In groups let learners discuss and count the faces as required in the activity.
- Do it personally, with your partner or in a group.
 - Get an empty box of chalk and unfold it carefully.
 - Display the flat shapes that were folded to form it.
 - Draw the net of the flat shapes displayed.
 - Present your work to the rest of the class.
- Let each group present its findings.

Development

- Introduce the new lesson and share competences.
- Help learners to realise what a prism is by describing it.
- Have a number of 3-dimension objects and guide learners to sort out prisms, pyramids, e.t.c.

- Show general properties of prism as;
 - opposite faces are equal.
 - the faces are joined together.
- Inform them that the name of the prism may depend on the opposite faces, e.g;
 - triangular prism = opposite triangular faces (also called tetrahedron).
 - square prism = opposite faces are square.
 - rectangular prism = opposite faces are rectangles (also called cuboids).
 - pentagonal prism = opposite faces are pentagons.
 - hexagonal prism = opposite faces are hexagons, e.t.c.
- Guide them to cut open the objects/boxes that you requested them to bring or those you provided to them.
- Once boxes or objects are cut open, remind them of the faces.
- Let them identify the opposite faces.
- Fold back and help them to name the different prisms formed.
- Provide the pre-drawn nets and ask learners to discuss what prisms they form.
- You may give out well drawn nets and ask learners in groups to cut them out.
- Let them fold cut-outs made and form prisms.
- Let them name the prisms formed.
- Ask learners to study and discuss the example in the Learner's Book, page 257.
- Help learners to cut the objects to form faces, then use them to form nets for shapes.
- Encourage learners to collect as many 3-D items as they can for reference.
- Do not rush as you guide learners through the steps.
- Have a number of drawn nets for prisms in advance.
- Let the learners manipulate the material i.e; cutting out, folding, gluing, e.t.c.

Conclusion

- Guide them through the Study tip.
- Let learners attempt Application 13.13.
- Mark their work and help in making corrections.

Remedial Exercise

Let slow learners draw as many nets as possible. Ask them to cut them out carefully, fold, glue or mask tape to form prisms. Let them name the prisms they have formed.

Additional Exercise

Let fast learners trace out nets and cut them out. Let them fold and glue them. Let them draw their own nets without tressing and form prisms.

Answers to application 13.1

Guide the learners how to measure sides and angles correctly. Follow through.

Answers to application 13.2

Guide the learners how to use a ruler and protractor precisely. Follow through.

Answers to application 13.3

Move around the class supervising the activities. Evaluate their work and guide where necessary.

Answers to application 13.4

Learners should use well sharpened pencils. Check for accurate equal sides and equal interior angles of 108° . Follow through.

Answers to application 13.5

Guide learners on how to handle and manipulate protractor and ruler. Check for accuracy.

Answers to application 13.6

Check for accuracy and follow through.

Answers to application 13.7

Check for proper interpretation of the instructions and accuracy.

Answers to application 13.8

Check for accurate construction of the equal sides and right angles. Follow through.

Answers to application 13.9

- | | |
|--------------------|----------------|
| (a) 120° | (b) 51° |
| (c) 40° (d) | 36° |
| (e) 30° | (f) 60° |

Answers to application 13.10

Check for accurate measurement of the radius and centre angles of 72° for regular pentagons and 60° for regular hexagons. Check for equal arcs along the circle and straight edges. Follow through.

Answers to application 13.11

Check for accurate measurement of the radius and centre angles of 51° for regular septagon and 45° for regular octagon. Check for equal arcs along the circle and straight edges. Follow through.

Answers to application 13.12

Check for accurate measurement of the radius and centre angles of 40° for regular nonagon and 36° for regular decagon. Check for equal arcs along the circle and straight edges. Follow through.

Answers to application 13.13

Guide the learners to articulate the skill of accurate and precise drawing of faces and nets. Follow through.

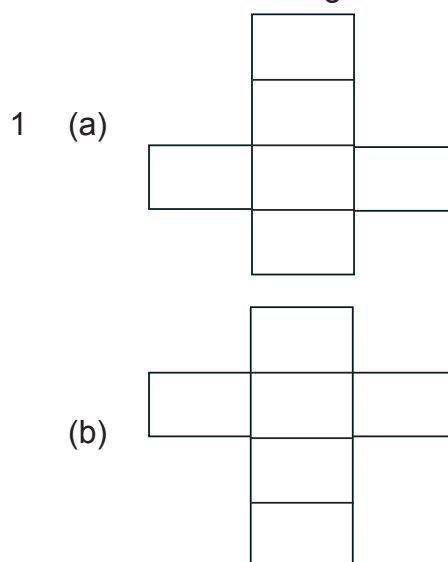

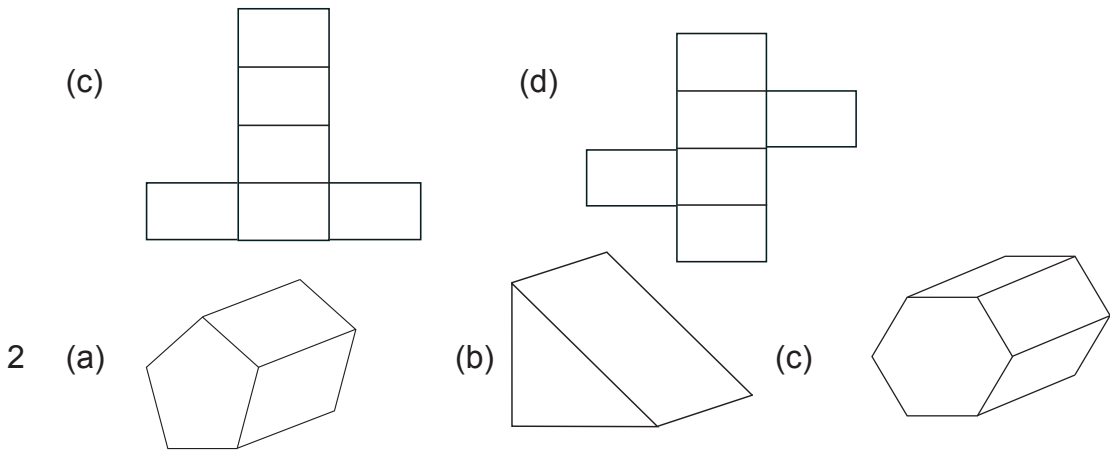

End of Unit 13 Assessment

1. Check for accurate equal measurement of 5.5 cm along all the 3 sides. Each interior angle has to be 60°. Follow through the accurate drawing.
2. Check for accurate drawing of 5 equal sides of 4.5 cm. Check for accurate drawing of 5 equal interior angles of 108° each. Follow through to check for accuracy in drawing a pentagon.
3. Check for accuracy in constructing sides and angles. Follow through to assess the skill of construction using compasses.

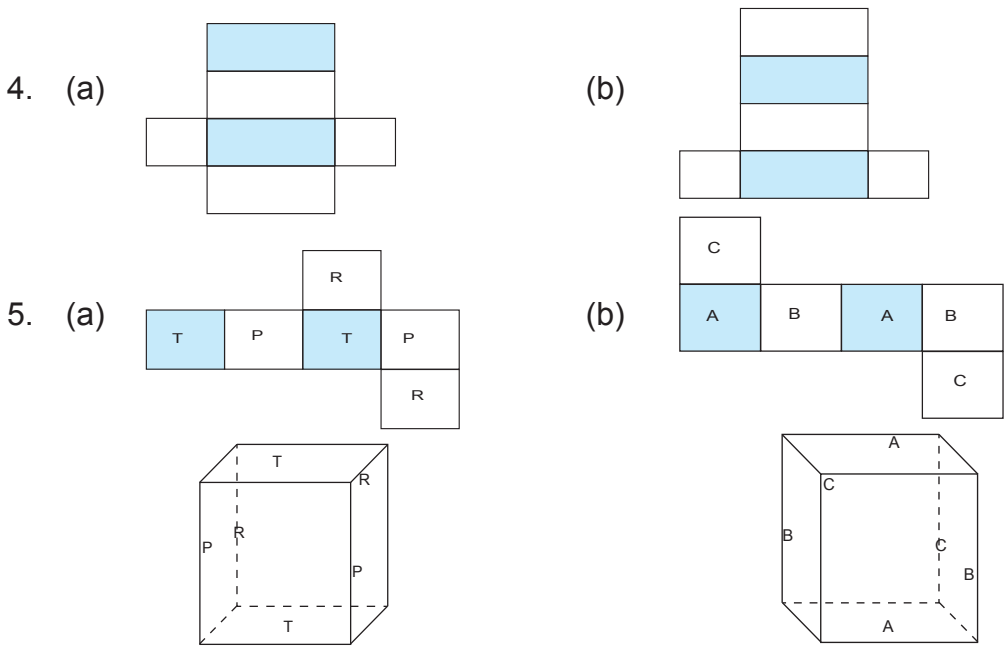

Numbers 6 to 9, supervise the activities as you guide the learners. Check for accuracy in constructing sides and angles.

Unit 14

Area bounded by a Circle, Surface Area of Cuboids and Volume of a Cylinder

Key unit competence: To be able to calculate the area enclosed by a circle, the surface area of cuboids and the volume of a cylinder.

List of lessons

Lessons	Number of lessons	Number of periods
14.1 Finding Area Bounded by a Circle	1	1
14.2 Calculating Area of a Circle Using Radius	1	1
14.3 Calculating Area of a Circle Using Diameter.	1	2
14.4 Calculating Area of a Circle Using Circumferential.	1	2
14.5 Finding Radius Using Area.	1	2
14.6 Calculating Surface Area of a Cuboid.	1	1
14.7 Finding the Length of a Cuboid.	1	1
14.8 Finding the Width of a Cuboid.	1	1
14.9 Finding the Height of a Cuboid.	1	1
14.10 Finding Volume of a Cylinder.	1	1
End of Unit 14 Assessment	1	2
Total	11	15

Guidance on problem statement

In this unit learners will be dealing with areas related to a circle and cuboid. Learners should realise the application of area. Let them think of how they will apply this concept not only in the classroom. Let them experience, through introduction in the Learner's Book, page 261.

Cross-cutting issues

Throughout the teaching process of this unit, it will be crucial to help learners to master the content and it is better to address cross-cutting issues where possible. In this unit, we will address the following cross-cutting issues as non-stand alone within classroom activities and through the development of the content.

- **Peace and value education:** As a teacher, you have to be a peace-maker in the class and role model so that learners will imitate how you behave. When there is any conflict do not leave without helping to solve it within the lesson. Encourage learners to behave well, being humble, honest, etc.

- Gender education: This cross-cutting issue will be addressed through giving equal opportunities to both boys and girls during the lesson.

Learning objectives

Knowledge and understanding

- State the formula for finding the area bounded by a circle and explain how it can be derived from the circumference of a circle.
- Explain the surface area of a cuboid as the area of its net.
- State the volume of a cylinder and explain the meaning of each letter.

Skills

- Calculate the area bounded by a circle.
- Use the net of a cuboid to determine its surface area.
- Calculate the volume of a cylinder.
- Select appropriate units when calculating area and volume.

Attitudes and values

- Appreciate the difference between area, surface area and volume and the importance of using the correct units.

Number of lessons: 15

Guidance for classroom organisation

- Before you start the lesson, first use warm-ups or energizers in order to engage the learners into the lesson. Do not focus on this only, try to be creative. The essence is to motivate the learners and make them active throughout the teaching- learning process.
- Help learners to form groups before you assign them an activity.
- While they are doing the activity, walk around while monitoring their work and helping where they have difficulties.

Learning and teaching materials for the unit

Manila cards, scissors, markers and masking tape and other materials that a teacher may see as important to achieve his/her objective.

Lesson 14.1

Finding Area Bounded by a Circle (40 minutes)

Learner's Book, page 261

Introduction

- Review explaining area of a rectangle and square.
- Distribute the learners in groups.
- Give out the suggested instructional materials to each group.
- Lead them through the steps as instructed in the activity in the Learner's Book, page 261.

Development

- Moderate the discussion.
- Learners should discover that the number of square within the circle is its area.
- Let learners refer to the examples in the Learner's Book, page 262.
- Explain that; just like finding of area of a rectangle and square experienced in P.4, the area of a circle can be found by counting the number of squares enclosed in it.
- Learners derived pi (π) in P.5 so, when the area of a circle is divided by the square of radius, an estimate of pi (π) is got.
- In the example, learner should observe that there are 78 squares in the circle, hence the area is 78 squares or 78 square units.
- The radius is 5 squares. So, when 5 is squared, 25 is got. So, $\frac{\text{Area}}{r^2} = \pi$. When 28 is divided by 9, an estimate of 3.14 is realised, which is the value of pi (π).
- Ask learners to draw more circles of radii, 4cm, 3 cm and 6 cm.
- Let them find the respective area of each circle by counting squares. Then divide the area by the square of radius.
- Let the individual group make a class presentation after tabulating the results. Assist where they find challenges.
- Guide learners through the examples on page 264. Explain the procedure to the satisfaction of learners.

Conclusion

- Let learners read and internalise the Study tip.
- Let them attempt Application 14.1.
- Mark their work and help them do corrections.
- Let them take notes in their class books.

Remedial Exercise

Slow learners should attempt the exercise below:

- Distribute 12 segments you have cut from a circular disk.
- Locate a centre on sheets of paper.
- Ask them to arrange them such that they form a circle.

Let fast learners attempt the exercise below:

- Distribute sheets of paper to the fast learners.
- Ask them to use radius of 3 cm and draw a circle.

- Let them cut the disk into 16 segments, then arrange them to approximate a parallelogram.
- Using the established formula, ask them to calculate the area of the circle.
- Let them attempt to find the area given the radii; $r = 10$ cm, $r = 1.4$ cm, $r = 100$ cm.

Lesson 14.2

Finding Area of a Circle Using Radius (40 minutes)

Learner's Book, page 263

Introduction

- Brain storm the learners to explain the concept of area.
- Let them give examples of units of area.
- Remind them that area is the space enclosed by a boundary.
- Review finding the area of a rectangle and a square by counting squares.
- Form groups.
- Distribute learning materials.

Development

- Guide the learners through the procedure of the activity.
- Draw a circle on a paper and divide it into 12 segments as shown.

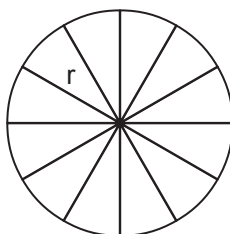

- Now cut it out and cut into the 12 segments.
- Arrange the segments to approximate a parallelogram as shown.

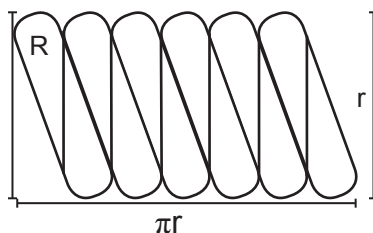

- Link its dimensions to the circumference and radius. Establish the formula for calculating area of a circle. State the formula for calculating the area of the circle from the following observations.

Development

- Explain that the activity is about establishing the formula for finding area of a circle.
- Lead learners to realise that after arranging the 12 segments, the shape formed approximates a parallelogram.
- Challenge the learners to mention the formula for finding the area of a parallelogram. They should state that;
- Area of a parallelogram = base x height.
- Explain further that the 6 segments form the base of a parallelogram and, at the same time are $\frac{1}{2}$ of the circumference of a circle.
- The length of a segment at the side represents the distance from the centre to the curve of the circle, i.e radius.
- Realising that base = $\frac{1}{2}$ of circumference, and height = radius, substitution is done in place of base and height.
- That is: Area of parallelogram = base x height
- Area of a circle = $\frac{1}{2}$ of circumference x radius.

$$A = \frac{1}{2}C \times r$$

But the formula for circumference of a circle is

$$C = 2\pi r, \text{ so } \frac{1}{2} C = \frac{1}{2} (2\pi r).$$

$$\text{Region bounded by the circle} = \frac{1}{2}(2\pi r) \times r.$$

$$A = \frac{1}{2} \times \frac{1}{2} \pi r \times r \text{ (divide by 2)}$$

$$A = \pi r \times r$$

Therefore, the formula for finding area of a circle is $A = \pi r^2$.

Conclusion

- Finally let learners discover that; Area bounded by a circle = πr^2 .
- Guide the learners through the steps, elaborating every step.
- Repeat the procedure whenever the learner get challenges.
- Ask the learners to repeatedly read the Study tip.
- Let attempt Application 14.2, page 264.
- Guide the learners to articulate the activity.
- It may challenge some learners, but assist where necessary.

Lesson 14.3 Calculating Area of a Circle Given Diameter (80 minutes)

Learner's Book, page 265

Introduction

- Give mental work to learners involving changing diameter to radius and vice-versa. e.g diameter = 14cm, radius = ? Radius = 10 cm, diameter = ?
- Review the previous work.
- Distribute the learners in pairs.
- Lead the learners in carrying out the activity in the Learner's Book, page 265.
- Explain the procedure as you demonstrate.

Development

- Now let learners in pairs practice the steps you demonstrated to them.
- Moderate the discussion, then assess the presentation.
- Give learners more examples moving around manipulating the formula for calculating area of a circle
- Give credit to those who worked out the radius first in the activity and encourage those who failed to try harder next time.
- Write two examples on the chalkboard and ask learners to attempt them on the pieces of paper you provided.

Example 1: The diameter of a circle is 7cm. Calculate the area bounded.

$$\begin{aligned} \text{Radius} &= \frac{\text{diameter (d)}}{2} \\ r &= \frac{7}{2} \text{ cm} \\ \pi &= \frac{22}{7} \\ A &= \pi r^2 \\ A &= \pi \times r \times r \end{aligned}$$

$$\begin{aligned} \text{Area} &= \frac{22}{7} \times \frac{7}{2} \times \text{cm} \times \frac{7}{2} \text{ cm} \\ A &= 11 \times 1 \text{ cm} \times \frac{7}{2} \text{ cm} \\ A &= \frac{77}{2} \text{ cm}^2 \\ A &= 38 \frac{1}{2} \text{ cm}^2 \\ \text{Area is } &38 \frac{1}{2} \text{ cm}^2 \text{ or } 38.5 \text{ cm}^2 \end{aligned}$$

- Now refer to the examples in the Learner's Book, page 265.

Conclusion

- Ask learners to follow through while discussing every step.
- Let them formulate their own questions, work them out, then make a class presentation in pairs.
- Learners should read and internalise the Study tip.
- Let them attempt the Application 14.3.
- Ensure you give learners enough practice.

Remedial Exercise

Let slow learners attempt the exercise below:

- (1) Find the radius, give that the diameter is
 - (i) 28 cm
 - (ii) 12 dm
 - (iii) 42dm
 - (iv) 63cm
 - (v) 21 m
- (2) Calculate the area bounded by a circle given;
 - (a) diameter = 7cm
 - (b) diameter = 10cm
 - (c) diameter = 14 m

Additional Exercise

Let fast learners attempt the exercise below:

- (1) Calculate the area bounded by circles with a diameter of:
 - (i) 20 cm
 - (ii) 3 cm
 - (iii) 5 cm
 - (iv) 7 m
- (2) Calculate the area of a circle, given that.
 - (a) $D = 0.98$ m
 - (b) $D = 11.2$ cm
 - (c) $D = 5.6$ m
 - (d) $D = 3\frac{1}{2}$ cm
 - (b) $D = 24\frac{1}{2}$ cm
- (3) The following are radii of circles. Calculate the area bounded.
 - (i) 49 cm
 - (ii) 50 dm
 - (iii) 6.3 m
 - (iv) $12\frac{1}{4}$ cm
 - (v) 0.35 m

Lesson 14.4**Calculating Area of a Circle Given Circumference (80 minutes)**

Learner's Book, page 266

Introduction

- Review the meaning of area and circumference.
- Then revisit the previous lesson.
- Form groups among learners.
- Give out the essential learning aids.
- Involve learners in the activity in the Learner's Book, page 266.
- Harmonise the results to come up with a general report.

Development

- Explain that much as we can use radius and diameter to calculate the area of a circle, we can as well use the circumference.
- Tell learners that the essence of using circumference is to retrieve the radius.
- Write an example on the chalkboard and let learners copy it on slips of paper and try to work it out.

Example: The circumference of a circle is 44 cm. Calculate its area.

- Remind learners that circumference is the length around a circle. Area is the region that is bounded by the circle.
- First move around from one group to another to see how they set up.
- Some or all of them are expected to use the deduction from the activity to do the calculation. Hence: circumference = $2\pi r$

Step 1: Substitute the values of circumference (C) and π , then solve for radius (r).

$$C = 2 \times \pi \times r$$

$$C = 44 \text{ cm}, \pi = \frac{22}{7}, r = ?$$

$$44 = 2 \times \frac{22}{7} r$$

$$44 = \frac{44}{7} r$$

$$7 \times 44 = \frac{1}{7} \times \frac{44}{7} r \text{ (multiply by 7 both sides to eliminate 7)}$$

$$7 \times 44 = 44r$$

$$\frac{308}{44} = \frac{44}{44} r$$

$$7 = r$$

So, the radius is 7 cm.

- Now lead them to calculate area.

$$\text{Area} = \pi r^2$$

$$\text{Area} = \pi \times r \times r$$

$$\text{Area} = \frac{22}{7} \times 7 \text{ cm} \times 7 \text{ cm}$$

$$\text{Area} = \frac{22}{7} \times 7^1 \text{ cm} \times 7 \text{ cm}$$

$$\text{Area} = 22 \times 7 \text{ cm}^2$$

$$\text{Area} = 154 \text{ cm}^2$$

Therefore, the area of the circle is 154 cm^2 .

- Ask learners to refer to the examples in the Learner's Book, page 266 and 267.
- Guide them through every step of the procedure.
- In case some learners seem to be confused, repeat explaining slowly but exhaustively to every learner's satisfaction.
- Give some more examples for learners to do more practice.

Conclusion

- Let learners read and internalise the Study tip.
- Let them attempt Application 14.4
- Mark their work and help them in doing corrections.

Remedial Exercise

Slow learners should attempt the exercise below:

- The circumference of a circle is 314 cm. Find its radius.
- The circumference of a circle is 22 cm. Find its radius.
- Let learners re-do the application to understand the concept more.

Additional Exercise

Let fast learners attempt the exercise below:

- The circumference of a circle is 35.2 cm. What is its radius?
- The circumference of a circle is 4,400 cm². Calculate its radius.
- The circumference of a circle is 52.8 m². Calculate its radius.
- Find the radius of a circle with circumference 9.68 m².

Lesson 14.5**Finding Radius using Area (80 minutes)**

Learner's Book, page 268

Introduction

- Give mental work about multiplication of table 7:
For example: 7×3 , 7×9 , 7×6 , 7×12 , etc
- Review the work that was done in the previous lesson.
- Learners form groups among learners and distribute instructional materials.
- Engage learners in the activity in the learner's Book, page 268.

Development

- Explain the main competence of the lesson.
- Tell learners that the activity leads to finding the radius given the area.
- Display a worked example on a chart.

Example: The area of a circle is 154 cm². What is its area?

- Let learners read and understand the question.
- Let them state the formula for area of a circle first: $A = \pi r^2$.
- Then they should substitute the given values, then solve.

$$A = 154 \text{ cm}^2, \pi = \frac{22}{7}, r = ?$$

$$154 = \frac{22}{7} \times r^2$$

$$154 = \frac{22}{7} r^2 \text{ (multiply by 7 both sides to eliminate the denominator)}$$

$$7 \times 154 = \frac{22}{\cancel{7}^1} r^2 \times \cancel{7}^1$$

$$1,078 = 22r^2$$

$$\frac{1,078}{22^1} = \frac{22^1}{22^1} r^2 \text{ (divide by coefficient 22 by both sides)}$$

$$49 = r^2 \text{ (find the square root on both sides)}$$

$$\sqrt{49} = \sqrt{r^2}$$

$$7 = r$$

Therefore, the radius is 7 cm.

- Let learners study and read the example in the Learner's Book, page 268.
- Let them lead in following through the procedure.
- Tell them to ask questions where they have not understood.
- Give more examples so that learners do more practice.

Conclusion

- Let learners read and understand the Study tip.
- Learners attempt Application 14.5.
- Mark their work and help them do corrections.

Remedial Exercise

Let slow learners re-do the application to master the concept.

Additional Exercise

Give extra exercise to the fast learners with harder numbers.

Lesson 14.6

Calculating the Surface Area of a Cuboid (40 minutes)

Learner's Book, page 269

Introduction

- Take learners through the steps of calculating area of rectangles and squares.
- Ask them to mention objects which have rectangular and square faces.
- Form groups among the learners.
- Distribute boxes and sheets of paper to each group.
- Guide the learners through the procedure as laid down in the activity in the Learner's Book, page 269.

Development

- Learners discover that the boxes provided have six faces. And each face has a rectangular shape.
- They as well realise that the faces of some boxes are all equal.
- Learners are expected to have been exposed to shapes of cuboids and cubes.
- Explain that, each pair of opposite faces of a cuboid is equal.
- Cuboids have 3 pairs of equal opposite faces. Ask the learners to recognise these pairs of faces.
- Let them do the same with the faces of a cube and prove that they are all equal.

- Ask the learners to draw illustrations of the nets of the dismantled boxes.
- Let them locate the dimensions of each of the edges that form rectangles of the net.
- Guide them to calculate the area of each face, then add to find the total area.
- Explain that, the area of each surface of the cuboid is referred to as surface area.
- To find the surface area of a cuboid or cube, the sum of area bounded by the rectangular faces is calculated then added. Lead the learners through this experience.
- Explain that different shapes of nets can be obtained after dismantling the cuboid or cube. Let learners observe this practically as you guide them.
- Refer to the examples in the Learner's Book, p age 269 and 270.
- Let learners scrutinise the shape and dimensions of the illustration of the box. Then study its net.
- Let them follow through the procedure of calculating surface area. Help them where they are challenged.
- Draw another illustration of a cube. Ask the learners to draw its net and calculate its surface area.

Example:

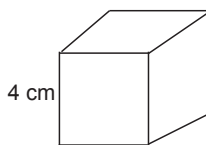

A net of a cube

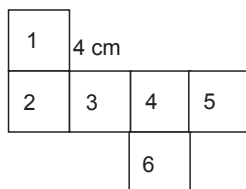

Working

A cube has 6 faces

All the faces are square in shape.

Surface area of a cube is the sum of area bounded by all the 6 square faces.

All edges are equal.

Each edge is 4 cm.

Surface area = $6(s \times s)$

S.A = 6 (side \times side)

S.A = $6 \times (4 \text{ cm} \times 4 \text{ cm}) = 6 \times 16 \text{ cm}^2$

S.A = 96 cm^2

So the surface area is 96 cm^2

Conclusion

- Ask learners to draw illustrations of cuboids and cubes, draw their nets then calculate their surface area.
- Guide learners to recognise respective dimensions of the edges.
- Monitor their display of perfected skills.
- Let them read and internalise the Study tip.
- Let them attempt Application 14.6.
- Mark their work and help them do corrections.
- To ease identification of the correct dimensions of the net, label all edges with corresponding dimensions before dismantling the box into its net.
- Exhaustively explain the difference between volume and surface area.
- Guide slow learners to dismantle and re-assemble boxes while identifying the different faces. Then draw the faces separately.

Additional Exercise**Let fast learners attempt the exercise below:**

1. Draw 6 different nets of each of the following:

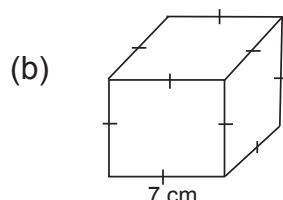
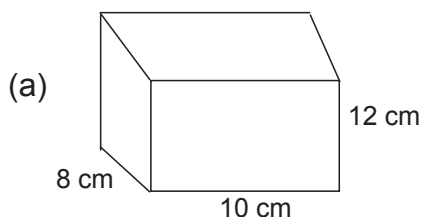

2. Calculate the surface area of the shapes above.

Lesson 14.7**Finding the Length of a Cuboid (40 minutes)****Learner's Book, page 271****Introduction**

- Review calculating surface area in the previous lesson.
- Let learners get into groups and distribute to them the recommended learning aids.
- Involve them in the activity in the Learner's Book, page 271.
- Harmonise the outcomes to make a general report.

Development

- Let learners observed that, they have been calculating for the value of length.
- Explain that if some of the values in the formula $A = 2lw + 2lh + 2wh$ and one is left out, substitution is done, then solving helps to find the unknown value.
- Display the chart with a worked example.

Example: The shape below is a rectangular prism. Study it and answer the question given.

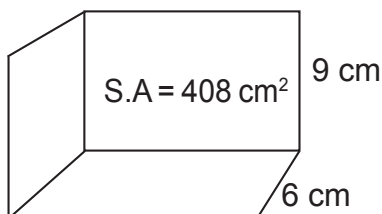

- Ask learners to state the formula for working out surface area of a cuboid.

$$S.A = 2(l \times w) + 2(l \times h) + 2(w \times h)$$

$$S.A = 408 \text{ cm}^2, w = 6 \text{ cm}, h = 9 \text{ cm}, l = ?$$

Substitute the given values and solve to find the unknown.

$$408 = 2(l \times 6) + 2(l \times 9) + 2(6 \times 9)$$

$$408 = 2 \times 6l + 2 \times 9l + 2 \times 54$$

$$408 = 12l + 18l + 108$$

$$408 = 30l + 108 \text{ (collect like terms)}$$

$$408 - 108 = 30l$$

$$300 = 30l$$

$$\frac{300}{30} = \frac{30l}{30}$$

$$10 = l$$

Therefore length is 10 cm.

- Repeat the procedure so that learners grasp the concept.
- Refer learners to the example in the Learner's Book, page 271.
- Let them study it and follow through.
- Give more example so that learners do more practice.

Conclusion

- Let learners read and internalise the Study tip.
- Ask them to attempt Application 14.7.
- Mark their work and help them do corrections.
- Let learners take notes.

Remedial Exercise

Let slow learners re-do the application to master the concept.

Additional Exercise

Let fast learners formulate their own questions, calculate them, then you assess them. This encourages creativity and critical thinking among learners.

Lesson 14.8

Finding the Width of a Cuboid (40 minutes)

Learner's Book, page 272

Introduction

- Give learners mental work involving multiplication. For example: 12×7 , 13×3 , 25×3 , 11×9 , 4×10 and so on.
- Review the previous work.
- Let learners form groups and distribute them instructional materials.
- Let learners carry out the activity in the Learner's Book, page 272.
- Guide them to find the missing side.
- Harmonise the answers to get one general result.

Development

- Learners have observed that in the activity, they are requested to find the value of width which is not given.
- Using the formula for finding surface area of a cuboid, $S.A = 2(l \times w) + 2(l \times h) + 2(w \times h)$, learners have understood that substitution is carried out, then solving for the unknown.

- Write an example or display the worked example on the chalkboard.
Example: Surface area of a cuboid is 370 cm². Its length is 11 cm, and height is 9 cm. What is its width?
 Learners have already learnt about substituting in the known values. So they are expected to carry it out easily.

$$S.A = 2(l \times w) + 2(l \times h) + 2(w \times h)$$

$$S.A = 370 \text{ cm}^2, h = 9 \text{ cm}, l = 11 \text{ cm}, w = ?$$
 Substitute the given values and solve to find the unknown.

$$370 = 2(11 \times w) + 2(11 \times 9) + 2(w \times 9)$$

$$370 = 22w + 198 + 18w$$

$$370 = 40w + 198 \text{ (collect like terms)}$$

$$370 - 198 = 40w$$

$$172 = 40w$$

$$\frac{172}{40} = w$$

$$4.3 = w$$
 Therefore width is 4.3 cm.
- Refer learners to the example in the Learner's Book, page 272.
- Let them follow through as you guide them.
- Do it again until they have understood completely.

Conclusion

- Let learners read and internalise the Study tip.
- Let them do Application 14.8.
- Mark their work and help them do corrections.

Remedial Exercise

Let slow learners attempt the exercise below:

- Given; surface area = 52 cm², l = 3 cm, h = 4cm, find w.
- Given; l = 3 cm, h = 3 cm, surface area = 54 cm², find w.
- Given; h = 4 cm, l = 5 cm, Surface area = 94 cm², find w.

Additional Exercise

Let fast learners attempt the exercise below:

- The surface area of a cuboid is 88.6 cm². Its length is 5.2 cm and its height is 3 cm. Find its width.
- The length of a rectangular water tank is 10.5 m. Its height is 4.5 m and surface area is 244.5 m². What is its width?
- The height of a box is 32 cm. The length is 64 cm. If the surface area is 13,312 cm². What is its width?
- Find the width of a rectangular container whose surface area is 222.32 m², length 9.8 m and height is 4.2 m.

Lesson 14.9**Finding the Height of a Cuboid (40 minutes)****Learner's Book, page 273****Introduction**

- Give learners mental work about estimating the length, width and height of walls of their classroom. (Use a ruler to confirm the measurements.)
- Review the work done in the previous lesson.
- Group learners and distribute to them instructional materials.
- Let them carry out the activity in the Learner's Book, page 273.

Introduction

- Explain that the formula in the activity is assimilated to the formula for finding surface area of a cuboid.
- So, learners have been involved in working out the unknown assimilated to height of a cuboid.
- Let learners get involved in the example in the Learner's Book, page 274.
- Learners observe that, the work is almost similar to the previous except in this instance, it is height which is worked out.
- Learners follow through step by step slowly in order to understand the procedure.
- Guide them and assist where challenges arise.
- Encourage learners to divide slowly by simple common factors until division is completely done with.
- Give more examples and let learners calculate them on sheets of paper provided by the teacher.
- Let groups make discussion and make presentation to class.
- Harmonise the discussion.

Conclusion

- Learners read and internalise the Study tip.
- Let them attempt Application 14.9.
- Mark their work and help them do corrections.
- Let them take notes in their class books.

Remedial Exercise

Let slow learners attempt the exercise below:

- The length of a cuboid is 5 cm, its width is 3 cm and the surface area is 94 cm^2 . What is its height?
- Given length is 4 cm, width is 3 cm and surface area is 108 cm^2 , find the height.

Additional Exercise

Let fast learners formulate their own questions and later alone calculate the height.

Lesson 14.10 Finding Volume of a Cylinder (40 minutes)

Learner's Book, page 275

Introduction

- Review finding the volume of a cuboid and a cube covered in P.5.
- Ask the learners to recognise the area bounded by the base of a cuboid and a cube.
- Let them give their views about the result of when the base area (area of one face) is multiplied by the height.
- Distribute the learners in groups.
- Ask them to read through the activity and figure out how to carry it out.
- Hand out sheets of paper and shapes of boxes and cylinders.
- Learners may come along with them if earlier told as preparation for the lesson.

Development

- Guide the learners through the activity in the Learner's Book, page 275.
- From the activity, the base of a box (cuboid is a rectangle and the base of a cylinder is a circle).
- To find the volume of a box (cuboid) the area of the base or area of one face is multiplied by the height, i.e. $\text{Volume} = (l \times w) \times h$. Like wise, to find the volume of a cylinder, the area of the base or circular face is multiplied by the height.
- Learners should recall that the area of a circle or circular face is found by: $A = \pi r^2$. It is this area that is multiplied by the height (h) to get the volume hence;
 $\text{Volume of a cylinder} = \text{area of the circular face} \times \text{height}$.

$$\text{Volume} = \pi r^2 \times h$$

Example: Calculate the volume of the cylinder.

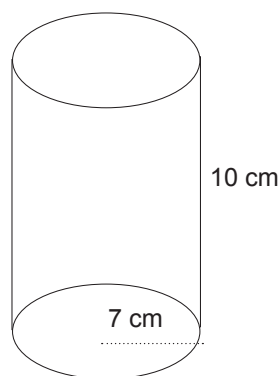

Ask learners to state the formula;

$$\text{Volume of a cylinder} = \pi r^2 \times h.$$

Let them mention the dimensions;

Radius is 7 cm, height is 10 cm.

The suitable $\pi = \frac{22}{7}$ because 7 cm is a multiple of 7.

So volume = $(\pi \times r \times r) \times h$ (substitute)

$$\text{Volume} = \left(\frac{22}{7} \times 7 \times 7 \right) \times 10 \text{ cm}$$

$$\text{Volume} = (22 \times 1 \text{ cm} \times 7 \text{ cm}) \times 10 \text{ cm} = 1,540 \text{ cm}^3$$

- Learners should know that $(\text{cm} \times \text{cm}) \times \text{cm} = \text{cm}^3$, hence the units of volume. Therefore the volume is $1,540 \text{ cm}^3$.
- Explain that the units of volume are cubic units, for example, cubic centimetres (cm^3), cubic decimetres (dm^3), cubic metres (m^3) and other cubic units.

- Refer learners to examples in the Learner's Book, page 275 and ask them to read and follow through.
- Explain the procedure articulately so that learners understand the concept thoroughly.
- Draw illustrations of cylinders with labeled radii and heights on the chalkboard.
- Ask the learners to copy them in their note books and calculate their volume.
- Move round supervising the exercise.
- Be more explicit when explaining how the volume of a cylinder might be found linking it to a cuboid, area of the base or one face multiplied by height.
- Ensure the formula of finding the volume of a cylinder is established but not simply stated.

Conclusion

- Ask them to cut the shapes and using glue, fix them onto manila cards with the working alongside the cut-outs. Hang them in the Mathematics corner.
- Let learners read and internalise the Study tip.
- Let them attempt Application 14.10.
- Mark their work and help them do corrections.

Remedial Exercise

Let slow learners work out the following:

- (1) $\frac{22}{7} \times 7 \times 7 \times 2$ (2) $\frac{22}{7} \times 7 \times 7 \times 3$ (3) $3.14 \times 10 \times 10 \times 5$
 (4) $3.14 \times 2 \times 2 \times 10$ (5) $\frac{22}{7} \times 7 \times 7 \times 1$ (6) $3.14 \times 10 \times 10 \times 10$

Additional Exercise

Solve the equation $v = \pi r^2 h$; find r given that;

- (1) $V = 1,540$, $h = 10$, $\pi = \frac{22}{7}$ (2) $V = 6160$, $h = 10$, $\pi = 3\frac{1}{7}$
 (3) $V = 1,570$, $h = 5$, $\pi = 3.14$ (4) $V = 12,560$, $h = 10$, $\pi = 3.14$

Answers to Application 14.1

The following answers are approximate figures. Consider answers nearer to:

- 1) (a) 28 squares (b) 50 squares (c) 113 square (d) 154 squares
 (e) 200 squares (f) 314 squares (g) 254 squares (h) 380 squares
 (i) 452 squares

Answers to Application 14.2

- 1) (a) $2,464 \text{ cm}^2$ (b) 616 cm^2 (c) 154 cm^2 (d) $3,850 \text{ cm}^2$
 (e) $5,544 \text{ cm}^2$ (f) 124.74 m^2
 2) $63,585 \text{ cm}^2$ 3) 154 cm^2 4) 38.5 cm^2

Answers to Application 14.3

- 1) 314 cm^2 2) $1,256 \text{ cm}^2$ 3) 13.88 m^2 4) $61,600 \text{ cm}^2$
 5) 1.54 m^2 6) 706.5 cm^2 7) 28.26 m^2

Answers to Application 14.4

- 1) 616 cm^2 2) $31,400 \text{ cm}^2$ 3) $7,850 \text{ cm}^2$ 4) 490.6 cm^2
 5) 0.06 cm^2 6) 24.64 cm^2

Answers to Application 14.5

- 1) 7 cm 2) $r = 14 \text{ cm}$ 3) 1.4 m 4) 100 cm
 5) 70 cm 6) 50 cm

Answers to Application 14.6

The following answers are approximate figures. Consider answers nearer to:

- (1) 412 cm^2 (2) $1,392 \text{ cm}^2$ (3) 320 cm^2 (4) 746 cm^2
 (5) $1,300 \text{ cm}^2$ (6) $2,400 \text{ cm}^2$

Answers to Application 14.7

- (1) 7 cm (2) 7 m (3) 9 cm (4) 10 m
 (5) 7 cm (6) 13 m

Answers to Application 14.8

- (1) 4 cm (2) 7 cm (3) 4.3 cm (4) 10 m
 (5) 6.05 m (6) 11 m

Answers to Application 14.9

- (1) 4 cm (2) 40 cm (3) 5 m (4) 200 cm
 (5) 5 m (6) 6 m

Answers to Application 14.10

- (1) $2,310,000 \text{ cm}^3$ (2) 14 cm, 616 cm^2 (3) $1,540 \text{ m}^3$
 (4) 14 m, $9,240 \text{ m}^3$ (5) $1,695.6 \text{ cm}^3$, 113.04 cm^2 (6) $1,386 \text{ cm}^2$

End of Unit 14 Assessment

- (1) (a) $A = 136 \text{ cm}^2$, $V = 1,088 \text{ cm}^3$ (b) $A = 28.3 \text{ cm}^2$, $V = 226 \text{ cm}^3$
 (2) $A = 113.04 \text{ m}^2$ (3) $V = 58.92 \text{ m}^3$ (4) 2.36 m^3 (5) $V = 248 \text{ dm}^3$
 (6) 6.22 m^3 (7) (a) $9,856 \text{ cm}^2$ (b) $1,386 \text{ cm}^2$ (c) $16,277.76 \text{ cm}^2$
 (8) $7,065,000 \text{ cm}^2$ 9. (a) $69,300,000 \text{ cm}^3$ (b) $28,260,000 \text{ cm}^3$

Unit 15

Statistics

Key unit competence: To be able to extend methods for collecting data, representing and interpreting it in order to answer a question or explore a hypothesis.

List of lessons

Lessons	Number of lessons	Number of periods
15.1 Collecting data to investigate a question	1	1
15.2 Interpreting data in frequency tables	1	1
15.3 Representing data in a bar chart	1	2
15.4 Interpreting data in a bar chart	1	1
15.5 Representing data in pie charts	1	2
15.6 Interpreting data in pie charts to draw a conclusion	1	1
End of Unit 15 Assessment	1	2
Total	7	10

Guidance on problem statement

This unit provides the essence of data collection, presentation and interpretation. Learners need to be guided on what they will gain from this unit. Let them be challenged through the introduction provided in Learners Book, page 279 and help them to have the general idea of the unit content.

Cross-cutting issues

Throughout the teaching process of this unit, it will be crucial to help learners to master the content and it is better to address cross-cutting issues where possible. In this unit, we will address the following Cross-cutting issues as non-stand alone within classroom activities and through the development of the content.

- **Peace and value education:** As a teacher, you have to be a peace maker in your class and role model so that learners will imitate how you behave. When there is any conflict do not leave without helping to solve it within the lesson. Encourage learners to behave well, being humble, honest, etc.
- **Gender Education:** This cross-cutting issue will be addressed through giving equal opportunities to both boys and girls during the lesson.

Learning Objectives

Knowledge and understanding

- Explain when it is appropriate to use a tally and how to obtain frequency from the tally.
- Explain how to use pie charts to represent proportions.
- Interpret line graphs as representation of data.

Skills

- Devise a question or hypothesis that requires data for its resolution.
- Decide what data to collect to answer a question.
- Collect data using a table and tally.
- Represent data in a bar chart or pie chart where the total frequency is a factor of 360° .
- Interpret representations of data to draw conclusions.

Attitudes and values

- Appreciate the power of data to answer questions and adopt a systematic and organised approach to dealing with data.

Number of lessons: 10

Guidance for classroom organisation

- Before you start the lesson, first use warm-ups or energizers in order to engage learners into the lesson. Do not focus on this only, try to be creative. The essence is to motivate the learners and make them active throughout the teaching-learning process.
- Help learners to form group before you assign them an activity.
- While they are doing the activity, walk around while monitoring their work and helping where they have difficulties.

Learning and teaching materials for the Unit

Manila cards, scissors, markers and masking tape and other materials that a teacher may see as important to achieve his/her objective.

Lesson 15.1

Collecting Data to Investigate Question (40 minutes)

Learner's Book, page 279

Introduction

- Start with a review of a few things about statistics using questions.
- Ask learners to form groups and provide each group with marks of the same value.
- Guide learners as they carry out the activity in the Learner's Book, page 279.

Development

- Allow each group to present its findings and present the number of marks recorded up with a single table as a report.
- Let learners do the example in the Learner's Book, page 279.
- Remind learners that mass is presented in groups of fives using tallies.
- You may ask a few oral questions to check whether the learners were following:
 - (a) How many times does 33 kg appear?
 - (b) How many learners had 42 kg?
- Bring out a question that needs investigating a question.
Example: Which type of food do the children of P.6 feed on most in their homes?
- Create initials for each type of food for easy recording for example "R" for rice, "P" for posho, "C" for cassava, "S" for sweet potatoes and "B" for bitokye.

Conclusion

- Let the learners collect data and help them to harmonise it.
- Guide the learners as they discuss the Study tip.
- Let the learners attempt Application 15.1.
- Mark their work and help them do corrections.
- Let each child say what they eat as you record.
- Organise data in the table you prepared on the chart. Ensure that every learner participates.
- Emphasise to the learners that tallies must be presented in fives. Explain to the learners that "frequency" is the same as number of times or occurrences.

Remedial Exercise

Let both slow and fast learners investigate the following questions; by collecting data from 50 respondents and organise the data in tables.

- (a) The age at which most Rwandan children start primary one.
- (b) The game that is most liked by Rwandan citizens.

Lesson 15.2**Interpreting Data in Frequency Tables (40 minutes)**

Learner's Book, page 281

Introduction

- Review presenting data in tables.
- Let learners get into their groups and guide them as they carry out the activity in the Learner's Book, page 281.

Development

- Display a chart you prepared and ask learners to study the table on it.
Example: Saplings that Rucimango planted in the first 4 months of the year.

Months	Tally	Frequency
Jan		21
Feb		16
Mar		23
April		8

- (a) Which month had the least number of saplings planted?
 (b) How many saplings were planted in Jan?
 (c) How many more saplings were planted in March than in February?

- Let learners answer questions about the table.
- You can ask oral questions and each time encourage learners to answer fully.
- Refer to the Learner's Book and guide learners as they study the example.
- Form more questions to help learners interpret the table fully. For example
 - (a) Which age group has the least number of learners?
 - (b) If all learners who are 13 and 14 years supervise 2 learners of other age groups, how many learners does each one supervise?
- Encourage learners to study every data of the table and answer using complete sentences. This will help them to develop the language as well.

Conclusion

- Guide learners as they discuss the Study tip.
- Let them attempt the Application 15.2.
- Mark their work and help them do the corrections.
- Let them take notes in their exercise books.

Remedial Exercise

Let slow learners copy and complete the frequency tables:
 Animals at Manzi's farm

Animal	Tally	Frequency
Goats		_____
Sheep	_____	9
Cattle		_____
Rabbits	_____	35
Pigs		_____
Total		

Bottles of drinks Uwachu sold at her restaurant

Drinks	Tally	Frequency
Soda		_____
Juice	_____	32
Milk	_____	24
Water		_____
Omusururu	_____	17
Total number of bottles		

Let fast learners copy and answer questions about the table below.

Babies who were immunised at Butaro Hospital.

Months	Tally	Frequency
Jan		_____
Feb		_____
Mar		_____
April		_____
May		_____
June		_____
Total		

- Complete the table.
- How many months are shown on the table?
- Which month registered the highest number of babies?

Lesson 15.3

Representing Data in a Bar Chart (40 minutes)

Learner's Book, page 283

Introduction

- Review interpreting frequency tables which was done in the previous sub-topic using the chart you displayed.
- Ask learners to form groups and guide them as they carry out the activity in the Learner's Book, page 283.

Development

- Give chance to each group to present their work.
- Come up with a general presentation.

That is; A suitable scale for the vertical axis should be picked on, and in this case each small square representing 10 would work.

Next we represent the data in the graph.

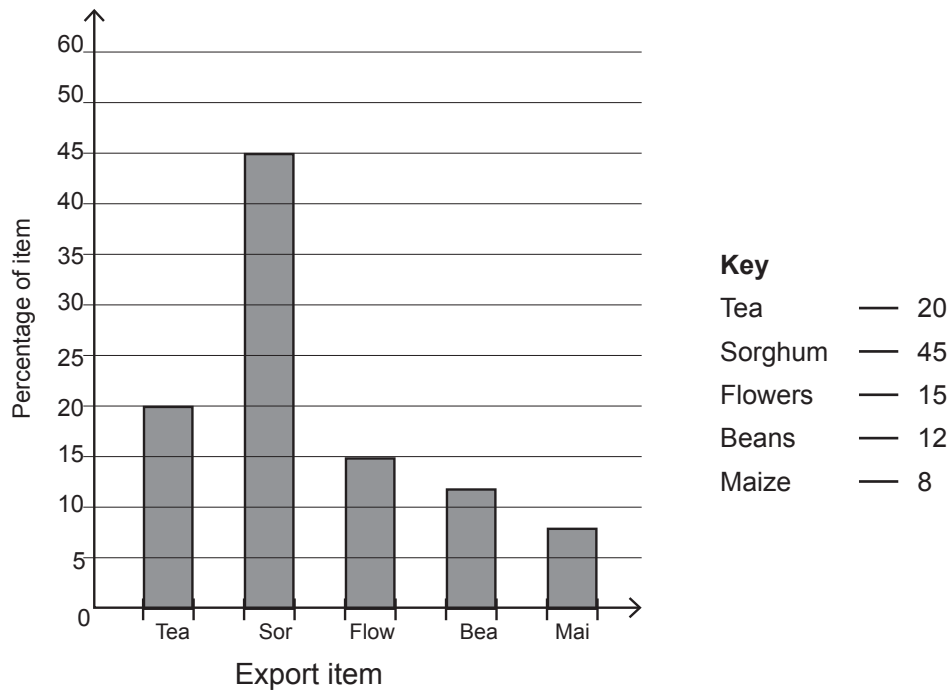

- Explain to the learners the importance of choosing a suitable scale. A scale helps us to draw an appropriate graph, that is one which is not too big if the data is of large numbers.
- You may ask a few questions to check whether the learners were following.
- Refer to the Learner's Book and lead learners through the example.
- Give learners different groups of data and ask them to choose suitable scales. For example:

Subject	Science	Maths	English	SST
Marks	60	85	70	80

- Here the suitable vertical scale will be 1 small square equal to 10.
- Guide learners through the Study tip.
- Let the learners attempt Application 15.3.
- Mark their work and help them to do corrections.

Remedial Exercise

Let both slow and fast learners collect data from 60 respondents concerning:

Favourite subject

House work which people participate in most.

- (a) In both questions learners should collect data.
- (b) Organise data in frequency tables.
- (c) Represent the data in bar charts.

Lesson 15.4**Interpreting Data in a Bar Chart (40 minutes)**

Learner's Book, page 285

Introduction

- Review representing data in bar charts using the chart you used in the previous lesson.
- Ask learners to form groups.
- Guide each group as they discuss while carrying out the activity in the learner's book, page 285.
- Let each group present its report and later make a class discussion to come up with one general report.

Development

- The diagram in the activity is a bar chart/graph.
- The title to the graph can be "trays of eggs collected by Uwera weekly.
- Number of trays are represented on the vertical axis while days of the week are represented on the horizontal axis.
- Display a chart you prepared and use it to teach interpreting data in a bar chart.
- Let learners study the graph and answer oral questions about it.
- Refer to the example in the Learner's Book, page 285.

Conclusion

- Let the learners study the scales and tell what each scale represents.
- Guide learners through each question while encouraging them to answer in full.
- Form other questions that can help learners to exhaustively interpret the graph.
For example;
 - (a) In which month did Mr. Muhire export:
 - i) the least number of tonnes of Maize?
 - ii) the highest number of tonnes of maize?
 - (b) What is represented on the horizontal axis?
 - (c) What is represented on the vertical axis?
- Let learners read and interpret the Study tip.

- Let them attempt Application 15.4.
- Explain to the learners that bar charts and bar graphs are the same. Explain that some times the bars on a chart are horizontal.

Remedial Exercise

Let slow learners interpret tables similar to the one below.

The table shows favourite sauce of a grade 6 class.

Type of sauce	meat	peas	beans	fish	G nuts
Number of Learner's	12	10	24	6	14

1. How many learners like ground nuts?
2. Which type of sauce is most liked by the learners?
3. Which type of sauce is least liked by the learners?
4. How many more learners like beans than meat?
5. If 3 of the learners who like peas are boys, how many girls like peas?

Additional Exercise

Fast learners can also interpret data in tables but this time using more complex questions.

Type of animal	cattle	sheep	rabbit	goats	cats
Number of animals	60	20	40	25	5

1. What is the most uncommon animal at the farm?
2. If $\frac{1}{5}$ of the goats on the farm are bull goats, how many bull goats are at the farm?
3. Express rabbits at the farm as a fraction of all the animals at the farm.
4. Express the cattle at the farm as a percentage of all the animals at the farm.
5. If $\frac{1}{2}$ of the sheep at the farm give birth to 2 lambs each, how many sheep will be at the farm?

Lesson 15.5

Representing Data in a Pie-chart (40 minutes)

Learner's Book, page 288

Introduction

- Start with mental work on multiplication of a fraction by a whole number. For example, $\frac{1}{2} \times 40$, $\frac{1}{3} \times 90$, $\frac{1}{4} \times 80$, $\frac{1}{5} \times 100$, $\frac{1}{6} \times 60$, $\frac{2}{5} \times 50$, $\frac{3}{8} \times 160$ and so on.
- Ask learners to form groups and provide each group with a manila sheet, ruler, coloured pencils, and a compass.
- Guide learners as they carry out the activity in the Learner's Book, page 288.

Development

- Allow each group to present its report and later give a general report. That is; a circle which is big enough to be drawn and divided into 5 parts. Multiply each fraction by 360° gives;
- We notice that the sum of the products of each fraction is equal to 360° .
- Help learners to realise that what they are going to learn requires them to change fractions into degrees by multiplying given fractions by 360° .
- Display a chart with an example similar to the one below to read the question and later work out.

Example: $\frac{1}{4}$ of the learners in a school are in the drama club, $\frac{1}{3}$ are in the debate club and $\frac{5}{12}$ are in science club. Represent the data above in a pie chart.

- Explain to the learners the meaning of a pie chart. Help them to realise that pie charts are also called circle graphs.
- Tell learners that since they have to present data in a circle, they must first change the data into degrees. Hence the portion for:

$$\text{Dram club} = \frac{1}{4} \times 360^\circ = 90^\circ.$$

$$\text{Debate club} = \frac{1}{3} \times 360^\circ = 120^\circ$$

$$\text{Science club} = \frac{5}{12} \times 360^\circ = 150^\circ.$$

- Now guide learners as they transfer the data they have gotten as degrees to the circle measuring the angles using protractor.

Step 1: Draw a circle.

Step 2: Measure 90° , 120° , now the remaining angle is 150° .

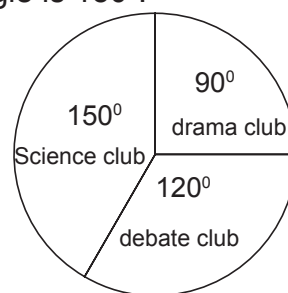
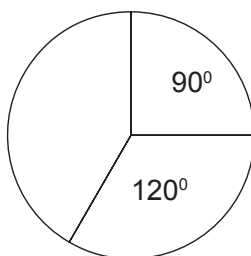
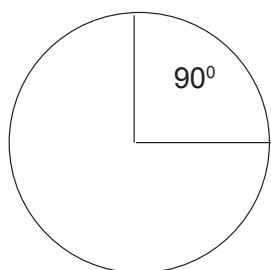

- Refer to the Learner's Book, page 288 and guide them through the example.
- Give learners chance to ask questions and later guide them through the accurate measurement of sector angles in degrees.
- Take learners through the Study tip and ask them to mention any other organisation or professionals who use circle graphs.
- Let learners attempt Application 15.5.

- Emphasise to the learners that the outer scale of the protractor should be used when measuring angle. Ensure that they measure accurately to avoid wrong presentation.

Remedial Exercise

Let both slow and fast learners list 3 major events they carry out at school every day which require time. Present time spent on each event as a fraction out of the hours they spend at school. Change the time to degrees and finally represent the data in a pie chart.

Lesson 15.6 Interpreting Data in Pie-charts to Draw Conclusion (40 minutes)

Learner's Book, page 289

Introduction

- Review representing data in pie charts using simple data.
- Ask learners to form groups and guide them as they carry out the activity in the Learner's Book, page 289.
- Allow each group to present their findings and later discuss to come up with a single presentation.
- Display a chart with an example of a pie chart and ask learners to study it, then ask a few questions about it.

Development

- For example; The circle graph below shows crop cover at Mrs Gasabo's farm.

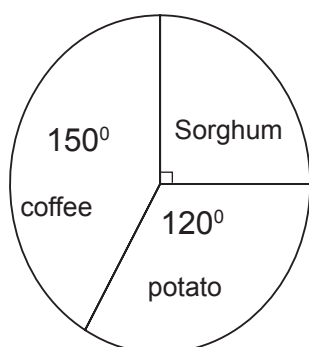

- (1) Which crop covers the biggest part of the land?
- (2) How big is the sector for sorghum?
- (3) If Mrs Gasabo's garden has an area of 72 acres, find the size of the land covered by potato and so on.

- Help learners to realise that all they need is to study the graph, read the questions and understand, then work out.
- Refer to the Learner's Book and guide learners as they study the example and work out each part of it.

Conclusion

- Let learners read and internalise the Study tip.
- Use the Study tip to emphasise what you have just taught.
- Let learners attempt Application 15.6.
- Ensure that learners practice multiplication of fractions by whole numbers since it is a concept they apply when interpreting pie charts.
- Remind learners that a right angle is 90° , so even if 90° is not indicated on a pie chart, they should just know how to go over it.

Remedial Exercise

Slow learners can try out the exercise below to help them master their cancellation skill.

For example

$$(1) \frac{25}{100} \times 360 =$$

$$(2) \frac{40}{100} \times 360 =$$

$$(3) \frac{60}{100} \times 360 =$$

$$(4) \frac{45}{360} \times 720 =$$

$$(5) \frac{90}{360} \times 720 =$$

$$(6) \frac{135}{360} \times 720 =$$

$$(7) \frac{12}{30} \times 360 =$$

$$(8) \frac{15}{30} \times 360 =$$

$$(9) \frac{20}{30} \times 360 =$$

Additional Exercise

Fast learners can copy and answer questions for the pie chart below.

The graph below shows a company's sales for 5 years. A company raised 56 million dollars.

- Find the size of the sector for the year 2013.
- In which year did the company realise the highest sales?
- How much did the company raise in 2012?
- In which year did the company realise the greatest decrease in sales?
- If 1 dollar = 880 Frw, how much Rwandan francs did the company raise in the year 2015?
- Find the percentage sales for 2015.

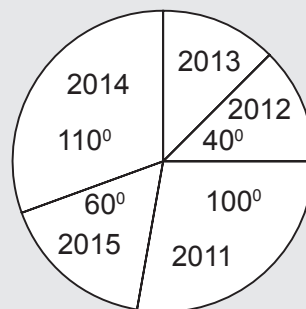

Answers to Application 15.1

1) (a)

Marks	Tally	Frequency
55		3
56		1
57		3
59		1
60		1
61		1
63		1
65		1
66		4
67		1
68		4
70		5
71		3
72		2
73		4
74		2
78		1
83		5
85		1
Total		44

(b) 44 learners

2) (a)

Kilograms	Tally	Frequency
1		5
2		9
3		10
4		17
5		10
6		9
Total		60

(b) 60 kg

Answers to Application 15.2

- 1) (a) 48 saplings (b) Eucalyptus and cypress
 (c) 20 saplings (d) 26 saplings
- 2) (a) 12 learners (b) 13 years (c) 46 learners

Answers to Application 15.3

- 1) (a) Bar graph showing litres of milk on a farm in a week.

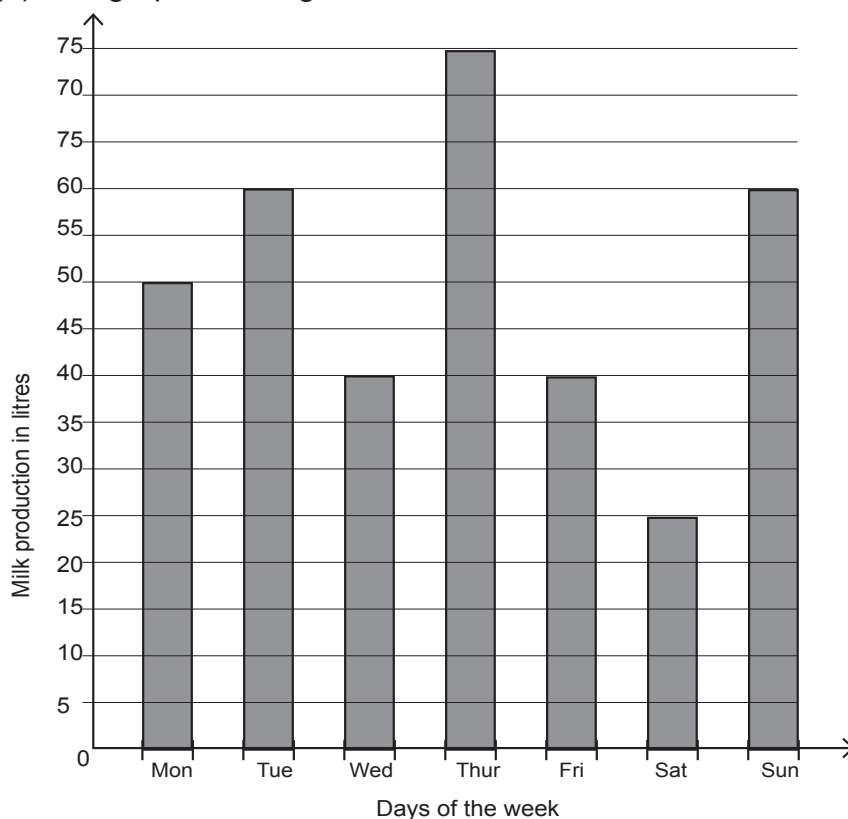

- (b) 360 litres were produced in the week.

- 2) (a) Frequency table for best colours of clothes.

Colour of the clothes	Tally	Frequency
Green		18
Red		18
Blue		3
Orange		6
Yellow		15
Total		60

(b) A bar chart showing the best colours of clothes that P.6 learners picked.

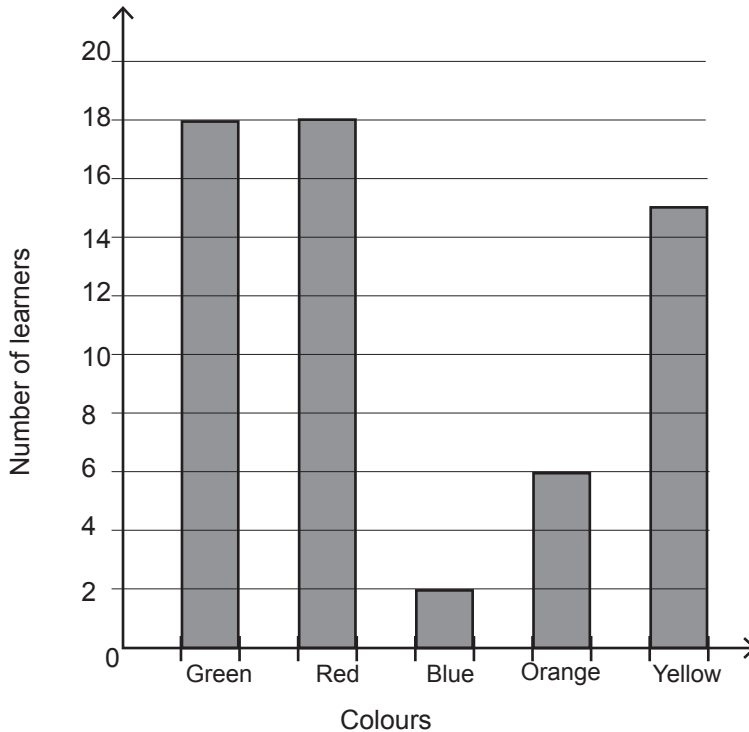

Answers to Application 15.4

- 1) (a) week 2 and week 5 (b) week 3
- (c) 190 kg (d) 133,000 Frw
- 2) (a) English (b) Science and Mathematics
- (c) 20 copies (d) 375,000 Frw
- (e) 360 copies

Answers to Application 15.5

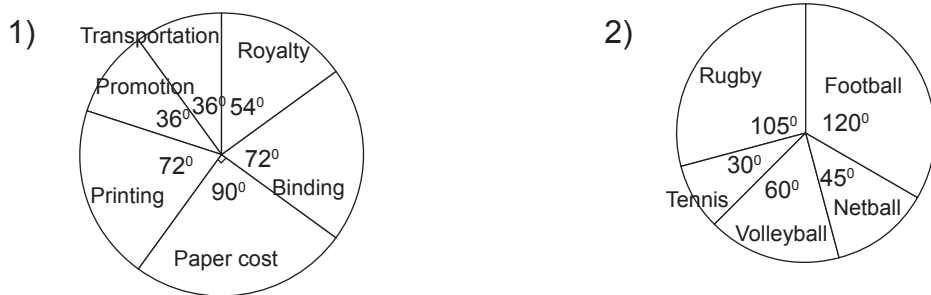

Answers to Application 15.6

- 1) (a) Taxi (b) 40,000 people
- (c) 16,000 people
- 2) (a) $16\frac{2}{3}\%$ or 16.6% (b) 90 pigs (c) 225,000 Frw

End of unit 15 Assessment

1)

Height in Cm	Tallies	Frequency
118		4
125		6
128		11
130		9
132		3
134		2
138		1
140		1
142		3
Total		40

2. A bar chart showing age groups of people in a certain village on the voter's register.

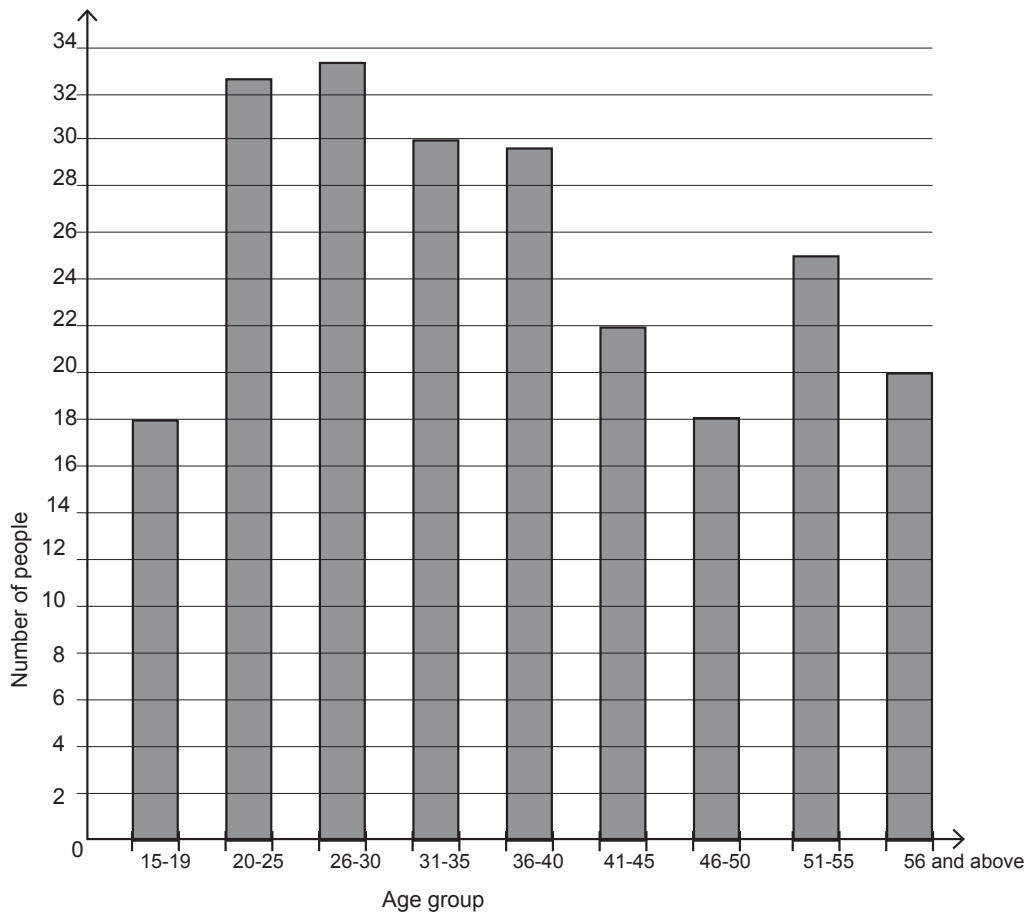

3) Pie chart representing most liked food by P.6 learners.

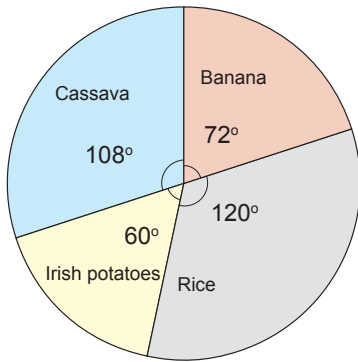

4) Pie chart showing predictions for the world cup winner.

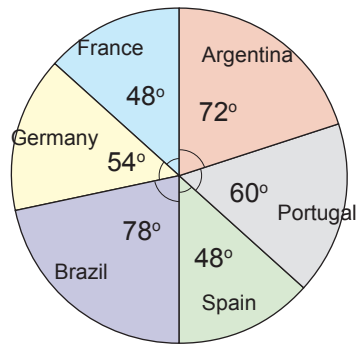

Bar graph showing predictions for the world cup winner.

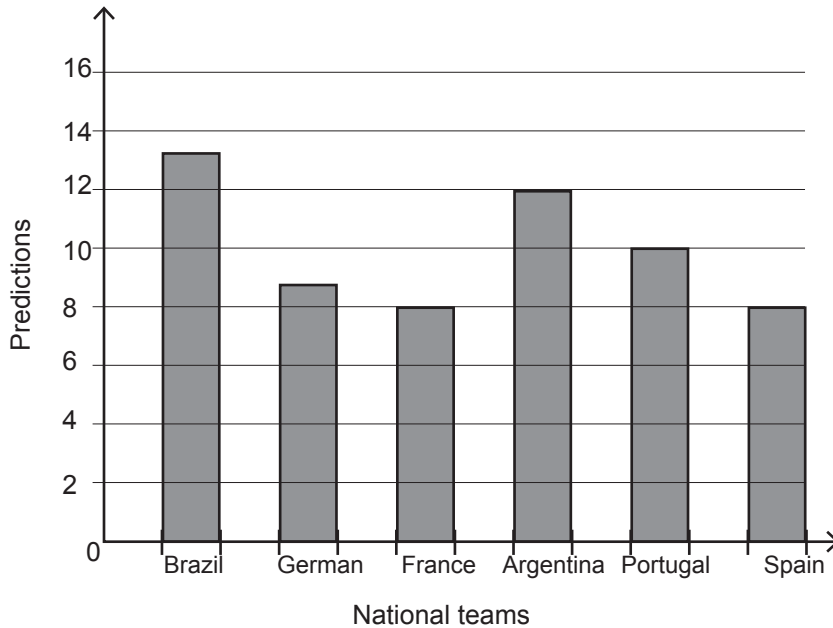

5) Pie chart showing games played by different people in our village

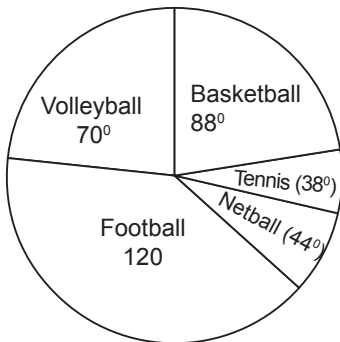

6) (a) $26\frac{2}{3}\%$ (b) 17 learners

(c) 12 learners

7) (a) 1 square = 8 litres of milk

(b) none

(c) 96 litres

(d) Thursday and Saturday

(e) 35,200 Frw

Unit 16

Probability

Key unit competence: To be able to order events in terms of likelihood (impossible, equally likely, certain).

List of lessons

Lessons	Number of lessons	Number of periods
16.1 Vocabulary of chance, impossible, certain, equally likely, events, unlikely, likely.	1	1
16.2 Using Data to Decide how likely something is to happen.	1	1
End of Unit 16 Assessment	1	1
Total	3	3

Guidance on problem statement

In this unit, the learners will deal with where they will be experienced with game of chance through practices. So, let them go through the introductory activity in the learner's book page 293 in order to be oriented about the unit content.

Cross-cutting issues

Throughout the teaching process of this unit, it will be crucial to help learners to master the content and it is better to address cross-cutting issues where possible. In this unit, we will address the following cross-cutting issues as non-stand alone within classroom activities and through the development of the content.

- **Peace and value education:** As a teacher, you have to be a peace-maker in the class and role model so that learners will imitate how you behave. When there is any conflict do not leave without helping to solve it within the lesson. Encourage learners to behave well, being humble, honest, etc.
- **Gender education:** This cross-cutting issue will be addressed through giving equal opportunities to both boys and girls during the lesson.
- **Financial education:** In this unit, financial education may be addressed via explaining to them where game of chance may be used in their daily life.

Learning objectives

Knowledge and understanding

- Explain that random events have different chances to occur and illustrate each terminology related to probability.

Skills

- Use the language of chance and associate it with events.
- Use likelihood to compare and order events.

Attitudes and values

- Appreciate that random events cannot be predicted.

Number of lessons: 3**Guidance for classroom organisation**

- Before you start the lesson, first use warm-ups or energizers in order to engage learners into the lesson. Do not focus on this only, try to be creative.
- The essence is to motivate learners and make them active throughout the teaching-learning process.
- Help learners to form group before you assign them an activity.
- While they are doing the activity, walk around while monitoring their work and helping where they have difficulties.

Learning and teaching materials for the Unit

Manila cards, scissors, markers and masking tape and other materials that a teacher may see as important to achieve his/her objective.

Lesson 16.1**Vocabulary of chance impossible, certain, equally likely, events, chance, unlikely, likely (80 minutes)**

Learner's Book, page 293

Introduction

- Preview playing a Bingo game as was done in P.4.
- Group the learners.
- Let them carry out the activity in the Learner's Book, page 293.
- Guide them and moderate the discussion.

Development

- Introduce learners to a betting game using a coin.
- Let learners discuss the likelihood of getting a tail when a coin is tossed.
- Learners should observe that a coin has 2 faces, the head and the tail. Demonstrate to show these faces to the learners.
- Ask those who think that the “tail” is likely to face up. Count them and write the number on the chalkboard.

- Now ask for those who think it will be a “head” facing up. Record the number as well.
- Toss the coin and let all the learners view what is on top.
- Did the learners in choosing a face ensure it is a must to show up?
- Explain that, when a coin is tossed, there is equal likelihood for any of the two faces showing up.
- So it is equally likely a tail shows up.
- Let the learners play more games of tossing a coin.
- Ask them to mention things that happen by chance and it is not easy to predict them.
- Suggest more and use the language of chance to explain their likelihood, then order the events.

Example

It will rain tonight

A lion eats grass.

An in-half cow will deliver a male calf.

- Lead learners to competently use the vocabulary of chance. Notably they are expected to give.
- It will rain tonight - equally likely.
- A lion eats grass - impossible.
- An in-half cow will deliver a male calf - even chance.
- So the order of events is impossible, equally likely, likely.
- Let the learners throw a die several times, betting on which number shows up.
- Explain the likelihood of any number showing up, a pair of numbers showing up or all faces showing up at once.
- Refer to the examples in the Learner’s Book, page 294. Let the learners follow through as they discuss. Prevail to explain the likelihood.

Conclusion

- Let the learners read, discuss and internalise the Study tip.
- Ask them to do Application 16.1 in the Learner’s Book, page 294.
- The learner’s vocabulary of the English language is not so wide.
- Ensure you do your level best to satisfy the learners as to the use of the vocabulary of chance.
- Explain thoroughly the likelihood of different events and as to how they can be ordered.

Remedial exercise

Give more work in form of extra-exercise to cater for all the learners.

Lesson 16.2**Using data to decide how likely something is to happen (80 minutes)****Learner's Book page 295****Introduction**

- Review the previous work.
- Group the learners.
- Refer to the activity in the Learner's Book, page 295.
- Let them carry it out in their groups guided by the teacher.

Development

- Explain that prepared data can be used to find the possibility of something to happen.
- Display the chart with prepared data.
- Let the learners study then read through.
- Let them discuss it and make presentations.
- Explain further relating to the data below;
- The table below shows rainfall received in Bunagana in 2016.

Month	Jan	Feb	Mar	Apr	May	Jun	Jul	Aug	Sep	Oct	Nov	Dec
Rainfall in (mm)	182	184	262	286	275	202	192	216	258	262	204	198

- (i) More rain will be received in December 2017 than in December 2016.
- (ii) Two rain seasons are experienced in Bunagana every year.
- (iii) Most rainfall was experienced in April.
- (iv) The dry season starts in May.

Likelihood

- (i) Even chances
 - (ii) Likely
 - (iii) Certain
 - (iv) Impossible
- Ask the learners to order the events.
 - Use more data for learners to explore more, for example, temperature for the 12hrs of a day, enrollment in schools for years and so on.
 - Let learners suggest data.
 - Then they make up their own statements.
 - Refer to the examples in the Learner's Book, page 295.
 - Guide the learners as they read through and discuss about the data and the likelihood for different events.

Conclusion

- Let them read through and internalise the Study tip.
- Then let the learners do Application 16.2, Learner's Book, page 296.
- Give as much data as can be retrieved from the National Archives for the

benefit of determining the future happenings.

- Learners should make up their own statements for likelihood and order the events many times in order to internalise the concept of probability.

Remedial exercise

1. Give more extra exercises to all learners.
2. Define and give two examples of impossible and possible events.
3. In a box of chalk, 20 pieces are blue, 30 pieces white, 25 pieces are green, 15 pieces are yellow, and other 15 pieces of chalk are orange. If you want to take one chalk randomly, find:
 - (a) The probability of getting white chalk.
 - (b) The probability of getting orange chalk.

Answers to Application 16.1

- 1 (a) likely (b) certain (c) likely (d) certain
(e) likely (f) impossible (g) unlikely (h) impossible
- 2 (a) something can't happen (b) It must happen
(c) Even chances of happening (d) It may happen
(e) The chances of something to happen are very few.
- 3 Teacher assess the statements.

Answers to Application 16.2

1. (a) 0.001 (c) 1.001 (h) 4
(i) -8 (l) 100°
2. The probability is 4 out of 52 cards in the deck.
3. (a) Probability greater than 4 is 2 out of 6.
(b) No because the highest number on a die is 6.
4. Probability is 1 out of 4.
5. Probability of getting queen of a heart is 1 out of 52.

End of Unit 16 Assessment

1. (a) Impossible (b) Unlikely (c) Certain (d) Certain
2. (a) likely (b) even chance (c) likely
3. 3 out of 6 (4) 1 out of 52
5. (a) 1 out of 6 even chance (b) 1 out of 3 even chance
(c) certain (d) even chance, even chance, certain

Glossary

An event: This is any possible outcome from the sample space. An event is also a subset of a sample space.

Cube: This is a solid bounded by six identical faces which are squares.

Cuboid: This is a solid bound by three pairs of identical faces which are all rectangles.

Data: This is a set of values and observations that gives raw information in a more organised form.

Direct proportion: This is where the quantities are such that, when one quantity increases or decreases in the ratio a/b , the other quantity decreases or increases in the ratio b/a .

Interest: This is the money paid for borrowing or depositing money for a specific period of time. It is also a fixed percentage charge on unpaid loans.

Loss: This is the amount of money lost when a commodity is sold below the actual buying price.

Percentage: This is the fraction whose denominator is 100.

Probability: This is the likelihood/possibility of an occurrence of an event at a given period of time.

Profit: This is the extra amount gained after selling a commodity at a price higher than the buying price.

Pyramid: This is a solid figure formed with triangular slanting faces which meet at a vertex above a polygonal base.

Ratio: This is a mathematical statement of how two or more quantities / numbers are compared.

Statistics: This is the study of collecting, organising, representing and displaying of numerical data. Examples of data include ages, mass, height of students.

References

1. Rwanda Education Board (2015). Mathematics Syllabus for Upper Primary P4 - P6: Ministry of Education, Kigali.
2. Byamukama, J. & Mulisa, L. (2010). New Upper primary Maths Pupils Book Grade 6, Longman.
3. Male H., Kihara J., Mangale S. (2004). Understanding mathematics Primary 6, Longhorn Publishers, Nairobi.
4. Mugumu, D. & al. (2008). Mathematics Pupil's Book: Primary six. Kigali, Rwanda: MK 6. Publishers Ltd & NCDC.
5. Richard E (1997). Algebra I, Addison – Wesley Publishing Company, Inc, Phillipines.
6. Engelsohn H., Feit J (1980). Basic Mathematics, Moriah Publishing, New York.
7. Allen R (2004). Intermediate Algebra for College Students, Pearson Education, Inc, New Jersey.