

PHYSICAL EDUCATION AND SPORTS

Primary Four
Teacher's guide

Kigali, January,2019

ACRONYMS

CSE: Comprehensive Sexuality Education

RB : Right Back

LB : Left Back

FERWABA : Fédération Rwandaise de Basketball

FERWafa : Fédération Rwandaise de Football Association

FERWAHAND : Fédération Rwandaise de Handball

FIFA : Fédération Internationale de Football Association

FRSS : Fédération Rwandaise du Sport Scolaire

FRVB : Fédération Rwandaise de Volleyball

PE : Physical Education

PES: Physical Education and Sports

RAF: Rwanda Athletics Federation

RCA: Reflect Connect Apply

PA: Physical Activity

CD: Compact Disk

Copyright

© 2019 Rwanda Education Board

All rights reserved.

This document is the property of Rwanda Education Board.

Credit should be given to REB when the source of this book is quoted

FOREWORD

Dear teachers,

Rwanda Education Board is honoured to present Primary Four Physical Education and Sports teachers' guide which serves as a guide to competence-based teaching and learning to ensure consistency and coherence in the learning of the Physical Education and Sports subject. The Rwandan educational philosophy is to ensure that learners achieve full potential at every level of education which will prepare them to be well integrated in society and exploit employment opportunities.

In line with efforts to improve the quality of education, the Government of Rwanda emphasizes the importance of aligning teaching and learning materials with the syllabus to facilitate their learning process. It is in this context that we developed this Teachers' guide which provides guidance to Physical Education and Sports teachers on how to lead and help students perform different techniques, sports and games as prescribed in the syllabus. The teacher will then help students to connect what they have learnt with the real life situations and develop certain values and attitudes allowing them to make a difference not only to their own life but also to the nation.

The general objective of Physical Education and Sports (PES) subject is the global development of the child: physically, intellectually, socially, emotionally as well as healthily. Hence, the teaching of Physical Education and Sports subject is the most active and participative in all subjects. You will find in this guide many activities and demonstrations that facilitate the performance of different techniques, sports and games in which learners can develop skills, ideas and make new discoveries during concrete activities carried out individually, with peers or in a team. Therefore, your role as a teacher is to plan ahead the lesson with needed materials and fully engage learners in all activities, sports and games.

I wish to sincerely appreciate all people who contributed towards the development of this teacher's guide, particularly REB staff who organized the whole process from its inception. Special gratitude goes to the University of Rwanda which provided content providers, quality assurers, validators as well experts in design and layout services, illustrations and image anti-plagiarism, lecturers and teachers who diligently worked to successful completion of this book. Any comment or contribution would be welcome for the improvement of this textbook for the next edition.

Dr. NDAYAMBAJE Irénée

Director General of REB

ACKNOWLEDGEMENT

I wish to express my appreciation to the people who played a major role in development of this Physical Education teacher's guide. It would not have been successful without active participation of different education stakeholders.

I owe gratitude to different Universities and schools in Rwanda that allowed their staff to work with REB in the in-house textbooks production project. I wish to extend my sincere gratitude to lecturers, teachers and all other individuals whose efforts in one way or the other contributed to the success of writing of this textbook.

Special acknowledgement goes to the University of Rwanda which provided content providers, quality assurers, validators as well experts in design and layout services, illustrations and image anti-plagiarism.

Finally, my word of gratitude goes to the Rwanda Education Board staff particularly those from the Curriculum, Teaching and Learning Resources Department (CTLR) who were involved in the whole process of in-house textbook writing.

Joan Murungi

Head of Curriculum, Teaching and Learning Resources Department/ REB

Contents

ACRONYMS	i
FOREWORD	iii
ACKNOWLEDGEMENT	iv
PART I. GENERAL INTRODUCTION	viii
I.0. About the teacher's guide	viii
I.1. The structure of the guide	viii
I.2. Importance of PES subject	x
I.3. Methodological guidance	xi
PART II. SAMPLE LESSON PLAN	xxi
UNIT 1: MOTOR CONTROL	1
1.1.Key unit competence:	1
1.2 Prerequisite knowledge and skill	1
1.3 Cross-cutting issues to be addressed	1
1.4 List of lessons	2
Lesson 1: Aerobic warm- up exercises and various basic techniques of gymnastic	3
Sub lesson 1: Aerobic warm-up exercises	5
Sub lesson 2: Various basic techniques of gymnastic	7
Lesson 2: Basic gymnastic equipments	11
1.5. Additional information	13
1.6. End unit assessment	14
1.7. Additional activities	14
UNIT 2: BODY CONTROL AND BALANCE	17
2.1. Key unit competence	17
2.2. Prerequisite knowledge and skills	17
2.3. Cross-cutting issues to be addressed:	17
2.4. List of lessons	18

Lesson 1: Exercises and games which develop cognitive, social and emotional control	19
Lesson 2: Different types of formations and hand-eye coordination	24
2.5. End unit assessment	30
2.6. Additional activity	30
UNIT 3: GYMNASTICS	33
3.1. Key unit competence	33
3.2. Prerequisite knowledge and skills	33
3.3. Cross-cutting issues to be addressed:	33
3.4. List of lessons	34
Lesson 1: Exercises of rolling forward and use different gymnastics equipments	35
Lesson 2 : Backward Exercise	44
3.5. Additional information for teachers	48
3.6. End unit assessment	50
3.7. Additional activities	51
UNIT 4: ATHLETICS	55
4.1 Key unit competence	55
4.2 Prerequisite knowledge and skills	55
4.3 Cross-cutting issues to be addressed:	55
4.4 List of lessons	56
Lesson 1: Exercises of running	57
Lesson 2: Exercises of jumping	60
Lesson 3: Exercises of throwing	67
4.5 End unit assessment	70
4.6 Additional activities	70
UNIT 5: FOOTBALL	71
5.1. Key unit competence:	71
5.2. Prerequisite knowledge and skills	71
5.3. Cross-cutting issues to be addressed:	71

5.4. List of lessons	72
Lesson1: Basic football techniques	73
Lesson 2: Basic football tactics	84
5.5. Additional information for teachers	85
5.6. End unit assessment	88
5.7. Additional activities	88
UNIT 6: VOLLEYBALL	89
6.1. Key unit competence	89
6.2. Prerequisite knowledge and skills	89
6.3. Cross-cutting issues to be addressed:	89
6.4. List of lessons	90
Lesson 1: Basic technical tactics of playing volleyball	91
Lesson 2:Develop body coordination and evaluate his/ her performance level in game situation	104
6.5. Additional information	107
6.6. End unit assessment	109
6.7. Additional activities	110
UNIT 7: BASKETBALL	115
7.1. Key unit competence	115
7.2. Prerequisite knowledge and skills	115
7.3. Cross-cutting issues to be addressed	115
7.4. List of lessons	116
Lesson 1: Basic techniques of basketball	117
Lesson 2: Technical development activities of basketball	134
Lesson 3: Develop Body coordination and evaluate him/her performance level in modified game of basketball and following basic rules	139
7.5. End unit assessment	143
7.6. Additional activities	143
UNIT 8: HANDBALL	147
8.1 Key unit competence	147
8.2. Prerequisite knowledge and skills	147

8.3. Cross-cutting issues to be addressed:	147
8.4. List of lessons	148
Lesson 1: Basic techniques of playing handball	149
Lesson 2: Technical development activities of handball	161
Lesson 3: Development of body coordination and evaluation of performance level in modified game of handball by following basic rules	168
8.5. End unit assessment	171
8.6. Additional activities and games	171
UNIT 9: TRANSMITTED DISEASES	173
9.1. Key unit competence	173
9.2. Prerequisite knowledge and skills	173
9.3. Cross-cutting issues to be addressed:	173
9.4. List of lessons	174
Lesson 1: The role of games/sports to increase HIV awareness	175
Lesson 2: Preventive modes of HIV/AIDS	179
9.5. Additional information	180
9.6. End unit assessment	181
REFERENCES	183

PART I. GENERAL INTRODUCTION

I.o. About the teacher's guide

This book is a teacher's guide for Physical Education and Sports for P4. It is designed to help teachers in the implementation of competence based curriculum.

As the name says, it is a guide that teachers can refer to when preparing their lessons. Teachers may prefer to adopt provided activities/games/exercises and related guidance but they are also expected to be more creative and consider their specific classes' contexts and prepare accordingly.

I.1. The structure of the guide

This section presents the overall structure of this guide, the unit and lesson structure to help teachers to understand the different sections of this guide and what they will find in each section.

Overall structure

The whole guide has three main parts as follows:

Part I: General Introduction

This part provides general guidance on how to develop the generic competences, how to integrate cross cutting issues, how to cater for learners with special educational needs, active methods and techniques of teaching Physical Education and Sports and guidance on assessment

Part II: Sample lesson plan

This part provides a sample lesson plan, developed and designed to help the teacher developing their own lesson plans.

Part III: Unit development

This is the core part of the guide. Each unit is developed following the structure as prescribed in subtitle structure of a unit

This teachers' guide has some changes considering pre-established number of periods allocated for each unit in the syllabus.

The following changes upon periods allocated to each unit were made:

- Unit 1 (Motor control) changed from 4 to 3 periods.
- Unit 3 (Gymnastics) changed from 2 periods to 3 periods.
- Unit 5 (Football) changed from 5 periods to 4 periods.
- Unit 9 (Transmitted diseases) changed from 1 period to 3 periods.

Structure of a unit

Each unit is made of the following sections:

Unit title: From the syllabus

Key unit competence: From the syllabus

Prerequisites (knowledge, skills, attitudes and values

This section indicates knowledge, skills and attitudes required for the success of the unit. The competence-based approach calls for connections between units/topics within a subject and interconnections between different subjects. The teacher will find an indication of those prerequisites and guidance on how to establish connections.

Cross-cutting issues to be addressed

This section suggests cross cutting issues that can be integrated depending on the unit content. It provides guidance on how to come up with the integration of the issue. Note that the issue indicated is a suggestion; teachers are free to take another cross-cutting issue taking into consideration the learning environment.

List of lessons/sub-heading

This section presents in a table suggestion on the list of lessons, lesson objectives copied or adapted from the syllabus and duration for each lesson. Each lesson /subheading is then developed.

End unit assessment

This part provides guidance on how to conduct the end unit assessment in a practical way. It suggests activities/ games as well as guidance on criteria to be considered such as:

- Cognitive skills (e.g.: level of concentration, memory, capacity of anticipation, problem solving);
- Technical competences (e.g.: to throw the ball, to catch it, to dribble it, to pass it to others etc);
- Strong emotional points such as self-confidence and feeling secure;
- Social competences such as cooperation and solidarity;
- Attitudes and values: e.g.: optimism, confidence, respect and impartiality.

Additional information/activities

- This section provides additional games/exercises for the teacher to have a wide range of activities/games related to the unit.
- Adapted activities for learners with special educational needs

- Remedial Activities for learners who need more time and exercises to achieve a certain level of performance
- Extended activities: for talented learners.

Structure of each lesson

Each lesson/sub-heading is made of the following sections:

Lesson title 1:

- **Introduction:** This section gives a clear instruction to the teacher on how to start the lesson
- **Teaching resources**

This section suggests the teaching aids or other resources needed in line with the activities to achieve the learning objectives. Teachers are encouraged to replace the suggested teaching aids by the available ones in their respective schools and based on learning environment.

- **Steps of the lesson**

This section provides activities/games/exercises and guidance step by step: introduction; lesson development and assessment.

I.2. Importance of PES subject

- Physical Education and Sport enables learner global development:

Physically, PES subject facilitates biological maturation (muscle development, widening of heart cavity, better pulmonary ventilation, coordination and motion speed). It also helps to prevent and correct the morphological and physiological defects;

- Intellectually, the learner acquires knowledge and ability of concentration: he/she observes, recalls, performs experiments, uses strategies, evolves and makes decisions;
- Emotionally, the learner is deeply involved: he/she discovers his/her own potentials; develops self-confidence, gets enthusiasm and happiness;
- Socially, the learner makes friends through playing and develops attitude and competence of communicating, cooperating and building positive relations with others.
- Game and sport provide learners with an excellent context of learning how to develop and protect their health and welfare. Through the game, a learner discovers that he/she has to take care of him/herself and of others;
- PES is a powerful way of building personality because it promotes self-confidence and competition skills. It develops knowledge and self-monitoring, respect of the law, will, attention, courage, and communication with others;
- This subject enables early detection and enhancement of sport talents for young learners;
- When games are carefully planned taking into account learner's age, they

enable learners to acquire practical competences such as respect, honesty, comprehension, communication, empathy, problem solving, comprehension of rules foundation and the way of complying with them.

- Success in play and sport activities is a source of self-confidence which contributes to the improvement of performance in other subjects even for students with low academic performance;
- Games contribute to bridge psychological gaps which usually exist between learners and teachers: when teachers regularly play with their learners, the mood becomes much more cordial and learners become more open.
- Recreational and sport activities provide learners with a real relaxation after hours of intensive concentration.

I.3. Methodological guidance

I.3.1. Developing competences

Since 2015 Rwanda shifted from a knowledge based to a competency based curriculum for pre-primary, primary and general secondary education. This called for changing the way of learning by shifting from teacher centered to a learner centered approach. Teachers are not only responsible for knowledge transfer but also for fostering student's learning achievement, and creating safe and supportive learning environment. It implies also that a learner has to demonstrate what he/she is able to do using the knowledge, skills, values and attitude acquired in a new or different or given situation.

The competence-based curriculum uses an approach of teaching and learning based on discrete skills rather than dwelling on only knowledge or the cognitive domain of learning. It focuses on what learner can do rather than what learners know. Learners develop basic competences through specific subject unit competences with specific learning objectives broken down into knowledge, skills and attitudes. These competences are developed through learning activities disseminated in learner-centered rather than the traditional didactic approach. The student is evaluated against set standards to achieve before moving on.

In addition to specific subject competences, learners also develop generic competences which are transferable throughout a range of learning areas and situations in life. Below are examples of how generic competences can be developed in Physical Education and Sports:

Generic competence	Examples of activities that develop generic competences
Critical thinking	<ul style="list-style-type: none"> • Demonstrate the importance of sports to the society • Demonstrate advantages have the schools where sport is valued contrary to a school or institution where sport is neglected. • Compare and contrast the benefits of physical exercises to the consequences of physical inactivity.
Research and Problem solving	<ul style="list-style-type: none"> • Research using internet or books from the library and develop strategies to cope with physical inactivity in society • Fabricate sports materials from local materials (e.g. making a soccer ball). • Demonstrate strategies that can be used by his/her school to solve the problem of sports equipment and sports materials by finding local grown solutions
Innovation and creativity	<ul style="list-style-type: none"> • Create a set of physical activities of a training session for a given sport. • Leading a given activity in sport training session with objectives, methodology, observations, results and conclusions. • Design a sketch map of some techniques and tactics used in different games. • Create a chart of the main steps in a performing a given technique in different sports/games. • Develop techniques and tactics to apply during a game situation
Cooperation, Personal and Interpersonal management and life skills	<ul style="list-style-type: none"> • Playing in Pairs • Playing in small groups/teams • Playing in large team and/or a club

Communication	<ul style="list-style-type: none"> • Organise and present in writing and verbally a complete and clear report of a training session or a match for a given sport • Select and use a set of verbal and non-verbal channels of communication during a game situation (a voice, facial expressions and bodily movements) • Observe and interpret different game situations and react accordingly. • Argue verbally or in writing about any given performance/ results in sports.
Lifelong learning	<ul style="list-style-type: none"> • Exploit all opportunities available to improve on knowledge and skills. Reading sports journals, listening to sports news and following different games on TV or on playgrounds/ stadium.

I.3.2. Addressing cross-cutting issue

Among the changes in the competence based curriculum is the integration of cross cutting issues as an integral part of the teaching learning process-as they relate to and must be considered within all subjects to be appropriately addressed. The eight cross cutting issues identified in the national curriculum framework are: genocide studies, environment and sustainability, gender, Comprehensive Sexuality Education (CSE), Peace and Values Education, Financial Education, standardization Culture and Inclusive Education.

Some cross cutting issues may seem specific to particular learning areas or subjects but the teacher need to address all of them whenever an opportunity arises. In addition, learners should always be given an opportunity during the learning process to address these cross cutting issues both within and out of the classroom so as to progressively develop related attitudes and values.

Below are examples on how crosscutting issues can be addressed in PES:

Cross-cutting issue	Examples on how to integrate the cross-cutting issue
Inclusive education	<p>: In teaching-learning process the teacher must identify the students with special education needs and plan adapted exercises accordingly. Involve all learners in all activities without bias. E.g.:</p> <ol style="list-style-type: none"> 1. Allow a learner with physical disability (using wheelchair) to be a referee, a coach, an assistant, a judge... 2. Simplify expectations from activities. Modify activities so that they suit the abilities and attention span of the learners.
Gender	<p>In teaching-learning process the teacher must provide exercises that engage both girls and boys and help them to exploit their full potentials: No activity is reserved only for girls or boys.</p> <p>Teachers should ensure equal participation of both girls and boys during physical activities and equal participation in open discussion.</p>
Peace and Values Education	<p>In teaching-learning process the teacher must encourage tolerance, patience, cooperation, teamwork spirit, mutual help, and respect of opinions of colleagues, obeisance of rules and creation of a more peaceful game situation.</p>
Standardization culture	<p>In teaching-learning process the learners must use standardized materials in prevention of injuries and accidents. The teacher also must help learners to know choosing and use safe sports clothing for their health (e.g.: safe sports shoes), safe physical exercises (avoid bad body postures and forbidden body exercises, adapted physical activities).</p> <p>e.g.: There are standards for throwing materials: javelin for teens, javelin for males, for females ... There are standards for soccer balls, Basketball balls/ Volleyball balls, Handball balls...</p>

<p>Environment and sustainability</p>	<p>In teaching-learning process environment and sustainability are addressed when:</p> <p>The teacher explains to learners the importance of a safe and clean environment for safe physical and sport activities.</p> <p>Learners avoid throwing away used materials before, during and after exercises.</p> <p>There are rules set for cleaning the playgrounds before and after exercises.</p> <p>Learners avoid spitting or blowing the nose in pitch, field, court... during exercises.</p>
<p>Financial Education</p>	<p>In teaching-learning process financial education may be addressed when:</p> <p>Learners are able to find themselves local grown solutions as regards to sports equipment and sport materials when there is shortage;</p> <p>Learners are good managers of sports infrastructures and sports materials, knowing that some of them are costly.</p> <p>Learners are aware that sport is an income generating activity and a way of job creation for many people around the world.</p>

I.3.3. Special educational needs

Learners or people with disabilities did not always have equal opportunities in society. As far as games and sports are concerned, these learners are often relegated to the passive role of spectators rather than players. Currently we are convinced that games and sports are very beneficial to people with physical, mental, emotional and psychological disabilities.

What attitude to adopt?

To promote the integration of learners with disabilities during recreational and sports activities, the following tips may help teachers / educators in the training of these learners:

- Adopt an approach of sport and game which is based on skills, and focus on what learners are capable of doing. In this respect, you can introduce small changes in

- games and activities for learners with disabilities;
- Be relaxed and natural when you are with people with disabilities. Do not treat them as if they need your pity or your charity. Do not think they necessarily need help. Let them do and say things themselves;
 - Avoid keeping learners living with disabilities out of the game: in a regular class, let them participate in other's games. However, avoid being too demanding about the level of their performance.

What can we modify?

Within the framework of integration of learners in games, according to the nature and the gravity of impairment, learners can, in some cases, participate in games designed for all learners. In other cases, the teacher or educator should think about changes he/she can make to meet the special needs of learners he/she has in the group. He/she should also think about adaptation of the game, the playground, equipment and duration of the game.

Below are some examples of adaptation to initiate:

Adapt roles and rules

- Make the game easier or harder by changing some rules;
- Let learners play different roles and in different positions;
- Allow players to play in different ways, for example, sitting instead of standing;
- Simplify expectations of the game;
- Simplify instructions.

Adapt the playground

- Change the size of the playground. Enlarge or reduce the playground;
- Change the distance: for example, put a target closer;
- Change the height of a target;
- Allow more or less space between players;
- Let learners move from different spaces.

Adapt the materials

- Reduce the size or weight of materials;
- Choose balls of various textures, bright colours or balls which make noise.

Adapt the duration of the activity

- Reduce or extend the time allotted to the activity.

Aspects to consider when you want to modify an activity

Ask yourself the following questions:

- Does the modification damage the activity? This should not be the case;
- Does the modification correspond to the ability and duration of learners' attention?
- Will the learner with disability be able to play with others?
- Is the activity proportional to ages of participants?
- Does the activity respond to the needs of all participants?

Strategies to help learners with physical disabilities or mobility difficulties

- Adapt activities so that students who use wheelchairs or other mobility aids, or other students, who have difficulty moving, can participate.
- Ask for adaptation of sports equipment e.g. the height of the volleyball net may need to be changed to make it easier for a student to reach it or fit their legs or wheelchair under.
- Encourage peer support between students.
- Get advice from parents or a health professional about assistive devices

Strategies to help learners with hearing disabilities or communication difficulties

- Always get the student's attention before you begin to speak.
- Encourage the student to look at your face.
- Use gestures, body language and facial expressions.
- Use pictures and objects as much as possible.
- Ask the parents/caregivers to show you the signs they use at home for communication using the same signs yourself and encourage other students to also use them.
- Keep background noise to a minimum.

Strategies to help learners with visual disabilities

- Help students to use their other senses (hearing, touch, smell and taste) to play and carry out activities that will promote their learning and development.
- Use simple, clear and consistent language.
- Use tactile objects to help explain a concept.
- If the student has some sight, ask them what they can see. Get information from parents/caregivers on how the student manages their remaining sight at home.

- Make sure the student has a group of friends who are helpful and who allow the student to be as independent as possible.
- Plan activities so that students work in pairs or groups whenever possible.

I.3.4. Guidance on assessment

Assessment in PE must be a continuing process that arises out of interaction during teaching and learning process. It includes lesson evaluation during RCA after each session and end of unit assessment. This formative assessment should play a big role in teaching and learning process. The teacher should encourage individual, peer and group evaluation of the activity done.

In this step the teacher sets exercise to assess abilities, skills, knowledge and attitudes of individual learner basing on unit or lesson objectives. During assessment activity, learners perform exercises individually or work in teams. The teacher avoids intervening directly. In fact, results from this assessment inform the teacher on next steps for the whole class and individuals. In some cases, the teacher can end up with giving remedial and extra activities.

I.3.5. Teaching methods and techniques

a. Suitable Methods / techniques to teach PES)

Physical Education and Sports is taught in the class rooms (e.g. using a projector and videos to teach steps of performing a technique, a system of game play, using a chalk board to teach rules of the game...), in the play fields/courts, in the gymnasiums, in the tracks and fields and in the swimming pools.

Teaching methods include:

- **Demonstration method:** A teacher makes him/herself a demonstration or asks a learner to do a demonstration. It is advised not to do a demonstration if you are not sure to do it better than every individual learner.
- **Verbal Explanation:** It involves giving a verbal or gestural clarification of activity, how it is done or what is to be done. When explaining:
 - The voice should be loud, clear, and precise.
 - Teacher should not explain when he/she has gained the full attention of the class.
- **Practice session:** Learners are given time to practice exercises intended to develop the desired skills.
- **Supervision:** During a PE lesson the teacher plays a role of supervision where he/she must move around in field and make corrections for individual learner during exercises.

Correction: Corrections are done starting by group correction to individual correction. Corrections for inaccuracy in performing given techniques are done immediately.

- **Evaluation:** Let learners do their own evaluation each other, then help them by giving some advice using encouraging words. Evaluation is a continued activity throughout the exercises.
- **Discussion:** Discussions are used before and after teaching learning activities in open talks
- **Application:** Use of learnt skills in different situations to solve a given problem.

b. Steps of a PE lesson

A PE lesson using play-based approach follows these steps: Opening discussions; warm-up activities; main activity or game itself; cool down and R-C-A discussions. (Right To Play, 2017)

Introduction

Step 1: Opening discussions

The opening discussions prepare learners for the learning experience. Discussions encourage them to think about the learning objective of the play. Opening discussions include 1 to 2 quick questions to stimulate learners' curiosity and engagement.

Strategies for good discussions:

- Set appropriate arrangement for good discussions: e.g. semi-circle, circle, U-shape
- Set ground rules which create a safe atmosphere for learners
- Prepare learners for discussions
- Ensure interactive and inclusive discussions
- Acknowledge each learner's contribution
- Ensure classroom management and control

Step 2: Warm-up activities

A warm-up is performed before a game/play. It helps the body prepare itself for exercise and reduces the chance of injury. The warm-up should be a combination of rhythmic exercise which begins to raise the heart rate and raise muscle temperature, and static stretching through a full range of motion.

Lesson Development

Step 3: Main activity or game itself

A game/play is chosen according to the age of learners and skills you want to develop. Adapt the games to the differences among learners.

Step 4: Cool down

A cool down activity is an easy exercise that allows the body to gradually transit to a resting or near-resting state.

Assessment

Assessment in PE lesson is done when learners are performing exercises/activities/games. At this level, through the RCA discussions the teacher allows learners to do their self-evaluation and provide the feed-back.

Step 5: RCA discussions

Reflect-Connect-Apply is a teaching and learning strategy that leads learners through a 3-step discussion about their experience:

- **Reflect** on the game/play. The teacher asks questions about their experience and feelings during the game. Examples: What was interesting? What was easy? What was challenging? What strategies have you used to win? How did you feel in case of success or failure?
- **Connect** to life experiences and lesson content. The teacher asks questions like: How does this game connect to what you already know, believe or feel? Does it reinforce or expand your view? The teacher also asks questions that connect the game to lesson content
- **Apply** acquired experience to another situation. The teacher asks questions like, “How could you use what you have learned from this experience? How could you use your new learning to benefit yourself, others, your community?” Learning is transferred and applied.

RCA is based on the work of educationalists such as Freire, Brown, Piaget, Brantford and others who support the concept of an educational process that is active, relevant, reflective, collaborative and applied, and has its roots in experiential learning theory (Kolb, 1984).

Play-based learning technique is closely linked to the Experiential Learning Cycle. It starts with a game or play-based activity and ends with a closing Reflect, Connect and Apply (RCA) discussion linked to the subject matter.

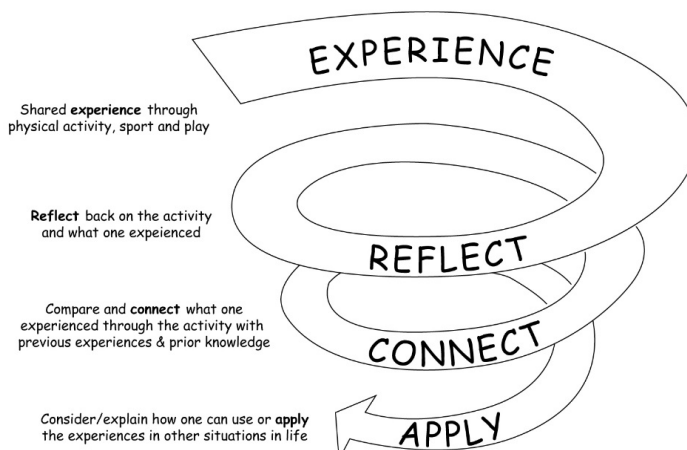

(Figure 1): Experiential Learning Cycle (David A. Kolb, 1984 – Experiential Learning Theory)

PART II. SAMPLE LESSON PLAN

School Name:

Teacher's name:

Term	Date	Subject	Class	Unit No	Lesson No	Duration	Class size
2	5 th June 2018	Physical Education and Sports	P4	2	1 of 2	40 min	43
Type of Special Educational Needs and number of learners				Two learners missing one arm.			
Unit title		Body control and Balance.					
Key Unit Competence:		Perform a range of simple actions and movements with consistency, fluidity, clarity and cooperation with others.					
Title of the lesson		Exercises and games which develop cognitive, social and emotional control.					
Instructional objective		Using different games learners should be able to develop intelligence, cooperation, social respect, emotional control, patience and happiness.					
Plan for this Class (location: in / outside)		Safe playground					
Learning Materials (for all learners)		Playground, Armband, beanbag (rolled up sock), a rug, towel or grass.					
References		MINISTRY OF EDUCATION. 1998. National curriculum development center. Physical and sports training Program in ordinary level. Kigali. Right to play,(2007),Red ball child games-leader English					

Timing for each step	Description of teaching and learning activity		Competences and cross cutting issues to be addressed
	The lesson is taught using four games and these will help learners to develop intelligence, cooperation, social respect, emotional control, patience and happiness.		
	Teacher activities	Learner activities	

Introduction :	<ul style="list-style-type: none"> • Ask learners to make semi-circle. 	Respond to the teacher's questions	Peace and values education:
Opening discussion:2min	<ul style="list-style-type: none"> • Check sports uniform; • Set simple ground rules with learners to create a safe atmosphere; 	Example of questions	Is developed through following instructions and encouraging teamwork spirit, mutual help, and respect of opinions of colleagues.
	<ul style="list-style-type: none"> • Start the lesson with introductory questions related to the lesson 	<ul style="list-style-type: none"> • What are games do you prefer to play? • What is the importance playing games? 	
	<ul style="list-style-type: none"> • Ensure interactive and inclusive discussion; 	Answers:	
	<ul style="list-style-type: none"> • Acknowledge each learner's contribution. 	<ul style="list-style-type: none"> • I like to play stick game, cat and rat game and Simon says game. 	Inclusive education :
Warm up:5min	<ul style="list-style-type: none"> • Use the game follow my hand for warming up learners, and help them to follow instructions. 	<ul style="list-style-type: none"> • It helps us to create friendship, to work as a team, think critically and problem solving skills. 	Is addressed through adapting the lesson to the learner with physical impairment to use his/her able body parts.
	<ul style="list-style-type: none"> • Help learners for flexibility exercises 	Learners play the game ' Balance tag ' for warming- up their body.	
Stretching:2min		Perform flexibility exercises	

<p>Development of the lesson:25 min</p>	<ul style="list-style-type: none"> • Explain to the learners that the lesson will be taught through two games: Frozen tag and frozen bean bag game. • Show learners playing area boundaries. • Let learners play and provide the necessary support. <ul style="list-style-type: none"> • Check if learners have a willing of helping each, socializing, and work as team and if they are controlling their emotions during the game. 	<p>Listen to teacher's explanations and ask related questions</p> <p>Play as well as following rules of the game.</p>	<p>Gender: Engage both girls and boys in the lesson and help them to exploit their full potentials.</p> <p>Cooperation: Is developed through playing together and help each other to pick up the dropped bean-bag and put it on the head of the learner who dropped it.</p> <p>Fair play: Tagging learner gently and adhering to the rules of the game.</p>
---	---	--	--

<p>Conclusion:</p> <p>Cool down:3 min</p> <p>Final discussion:3min</p>	<p>Use the game ‘Lazy day rest game ‘ to help learners feel relaxed</p> <p>Ask questions</p> <p>Reflect Which game that was easy to play?</p> <p>Connect</p> <ul style="list-style-type: none"> • How the frozen game is helpful? <p>Apply</p> <ul style="list-style-type: none"> • What are going to do to improve your cognitive, social and emotional control? 	<p>Play the game for relaxation</p> <p>Answers :</p> <ul style="list-style-type: none"> • Frozen beanbag <p>Answers :</p> <p>The frozen game is helpful because it was helping us to be happy, to think critically, to work together and create friendship with my colleagues.</p> <p>Answers</p> <p>Just continue playing together with my friends, helping each other</p>	<p>Communication :</p> <p>Is developed through answering questions verbally.</p> <p>Environment and sustainability:</p> <p>Is developed through respecting playing environment and removing all used materials</p>
--	---	---	--

Teacher self-
evaluation

Teacher evaluates the achievement of objective.

UNIT 1: MOTOR CONTROL

1

1.1. Key unit competence:

Learners will learn better this lesson if they are able to perform a range of aerobic warm-up exercises and develop basic techniques in gymnastics.

1.2 Prerequisite knowledge and skill

Learners will learn better this unit if they are able to perform physical activities like running, jumping, etc

1.3 Cross-cutting issues to be addressed

- **Peace and values education:** Encourage teamwork spirit, mutual help, and respect of opinions of colleagues among learners.
- **Gender education:** Engage both girls and boys and help them to exploit their full potentials: No activity is reserved only for girls or boys.
- **Inclusive education:** Identify the learners with special education needs, ensure interactive and inclusive discussion
- **Financial education:** Facilitate/guide learners to make non cost materials like ropes from banana leave fibers.

1.4 List of lessons

	Lesson title	Learning objectives (from the syllabus including knowledge, skills and attitudes):	Number of periods
1	Aerobic warm up exercises and various basic techniques of gymnastic.	Appreciate the importance of physical activities to health.	1
1.1	Aerobic warm up exercises	Perform confidently the exercises on prolonged inspiration, expiration and relaxation of muscles and aerobic warm up.	
1.2	Various basic techniques of gymnastic.	Perform basic techniques in gymnastic activities. Take account of one's own safety and that of others during gymnastics. Respect of instructions during gymnastic exercises. Develop different attitude such as coordination, flexibility, balance and agility.	
2	Basic gymnastic equipments.	Use gymnastics equipment appropriately. Take account of one's own safety and that of others during gymnastics.	1
3	End unit assessment		1

Lesson 1: Aerobic warm- up exercises and various basic techniques of gymnastic

a. Prerequisite

A learner is able to perform different physical exercises needed to carry out different aerobic warm up exercises

b. **Teaching resources:** Playground, whistles, stops watches etc

c. Introduction

Opening discussions(in playground)

- Check sports uniform;
- Set simple ground rules with learners to create a safe atmosphere;
- Choose a system/formation which matches with the type of activity, for opening discussion;
- Start the lesson with introductory questions related to the lesson to arouse motivation and curiosity of learners and prepare them to learn;
- Ensure interactive and inclusive discussion;
- Acknowledge each learner's contribution.



Warm-up activities or game

- **Title of the game:** Follow my hand

Summary description of the game:

This game aims at warming-up the whole body. During this game, the “followers” move

after the “leaders” and try to keep their face at about 50 cm from the right hand of the leader whatever his/her position may be.



Organization and rules of the game

1. Group learners into pairs.
2. Ask one learner from each pair to start the game by playing the role of leader.
3. Another partner of each group will start the game by playing the role of follower.
4. Explain and demonstrate
5. If teacher says: “go!” every follower tries to keep their face at about 50 centimetres from the right hand of the leader.
6. Leaders move across the playground, raising and lowering their right hands in any direction.
7. If teacher says: “stop” all followers switch roles to become leaders and bring their partners to right hand.
8. Say “go!” and “stop!” in one or two minutes. Make sure learners are permanently paying attention to one another.
9. Ask leaders to bring their partner with another part of the body. For example, all followers have to keep their face at 50 centimetres from left elbow of their partner, and so on.

d. Lesson development

Sub lesson 1: Aerobic warm-up exercises

Game 1: Avocados and oranges

Description of the game: This game aims at warming up the body. Learners run to catch the learners of the opponent group.

Organization and rules of the game:

1. Mark the boundaries of the playground that allows enough space for learners to run and chase each other;
2. Divide learners into pairs;
3. Ask one member of each group to be an avocado. Another partner in each group will be an orange.
4. Explain and demonstrate;
5. When you call out “oranges” the oranges in each group will chase their avocado partners. When you call out “avocado”; the avocados will chase the oranges. If the orange chases and touches the avocado, the orange must count to ten before chasing the avocado again, giving enough time to move away;
6. Exchange roles about every thirty seconds. Make sure learners pay attention to one another so that they cannot mix up;
7. Check if oranges chase avocados when you say (orange);
8. Check if all learners participate.

Variations:

- Call out other fruit names to confuse learners (for example; pear, pawpaw, banana and so on)
- Add the instruction (fruit salad), which means that all learners run around but without chasing anyone.
- Add the instruction (squashed fruits) which means that all learners must quickly lie down.

Game 2. Title of the game: “As if”

Summary description of the game: This game aims at relaxing the body and Reduce or prevents muscles pain and stiffness of joints. In this game learner will perform an action by copying what is said by the teacher. Teacher is also advised to check if learners are able to identify the action indicated in instructions.

Organization and rules of the game

1. Ask learners to find a place in the playground and face the teacher.
2. Explain and demonstrate:
Say a sentence to the group: for example: “leap as if you were a little rabbit”

Then, ask them to perform the action indicated in the sentence.

Examples of actions include:

- Jump on the spot as if you were skipping a rope.
- Run as if a wild animal was chasing you.
- Walk as if you were crossing a muddy path.
- Raise your arms in the air as if you were catching a light ball.
- Comb as if a brush was fixed to your hand.
- Swim as if you were in a large pool.
- Move around; shake yourselves up lively as if you were a wet animal getting rid of water.

3. Add as many actions as possible.
4. Give learners the opportunity to add their own actions.
5. It is the teacher who decides when the game ends.
6. Ask the learners to take care of their colleagues to avoid accidents.

Variations:

- Start the game by giving only one or two examples;
- Ask each learner to show the group how to practice 1 or 2 creative exercises.
- Encourage them to be as creative as possible, to imagine themselves in different areas of life and to pretend to be different people or different animals.



Cool-down activities/exercises

- Put learners on semi circle
- Stand in front of them
- Ask learners stand still and breath in and out

e. Assessment

The teacher should apply a teaching and learning strategy that leads learners through a 3-steps discussion (**REFLECT-CONNECT-APPLY**) about their experience:

Reflect: What was interesting and challenging during the game

Connect: Ask learners the following questions,

- How do the games connect/relate to what you are already know, believe or feel?
- When else in life is necessary to perform aerobic warm up exercises?

Apply:

- How are you going to apply your new experiences from the games in your daily life?
- What are you going to improve the way performed the exercises of aerobic warm-up exercises?

Sub lesson 2: Various basic techniques of gymnastic

a. Prerequisites

Learners will learn better this lesson, if they are able to perform different physical exercises.

b. Teaching resources

Sportswear, playground, whistles, stop watches, bench, rope and other gymnastic equipments.

c. Introduction

- **Opening discussions:** For the opening discussion refers to the lesson 1 but try to ask learners different introductory questions related with basic techniques of gymnastics.
- **Warm-up activities or game**
- **Title of the game:** Cat-knee

Summary description of the game: This game aims at warming up the body. Learners will slap (gently) the partner's knee while avoiding being touched by him/her. Teacher is advised to check if learners slap one another, find another partners whenever t he/she says (stop) and check if learners pay attention so as not to bump into one another.

Organization and rules of the game:

1. Demarcate clearly a playground large enough to allow learners to run one after another;
2. Group learners in pairs;

3. Ask each group of the two to stand up one metre apart facing each other;

Explain and demonstrate: It is a touch game. When the teacher says (Go!) every learner tries to slap his/her partner on the leg (under the knee) as many times as possible till when the teacher says (Stop). Learners slap their partners on legs trying to avoid being tapped themselves. Remind learners to slap gently their comrades. When the teacher says (Stop), every learner must find a new partner and repeat the play only when they hear the word (Go!).

4. Say (Go!) every 30 to 60 seconds;

5. It is up to the teacher to decide when the game ends. Make sure learners are permanently paying attention to one another all the time;

Variation:

- Make groups of 3 to 4 learners;
- Ask them to replay the same game and try to touch legs of any group member but this time trying to protect their legs from any of their groups' members.

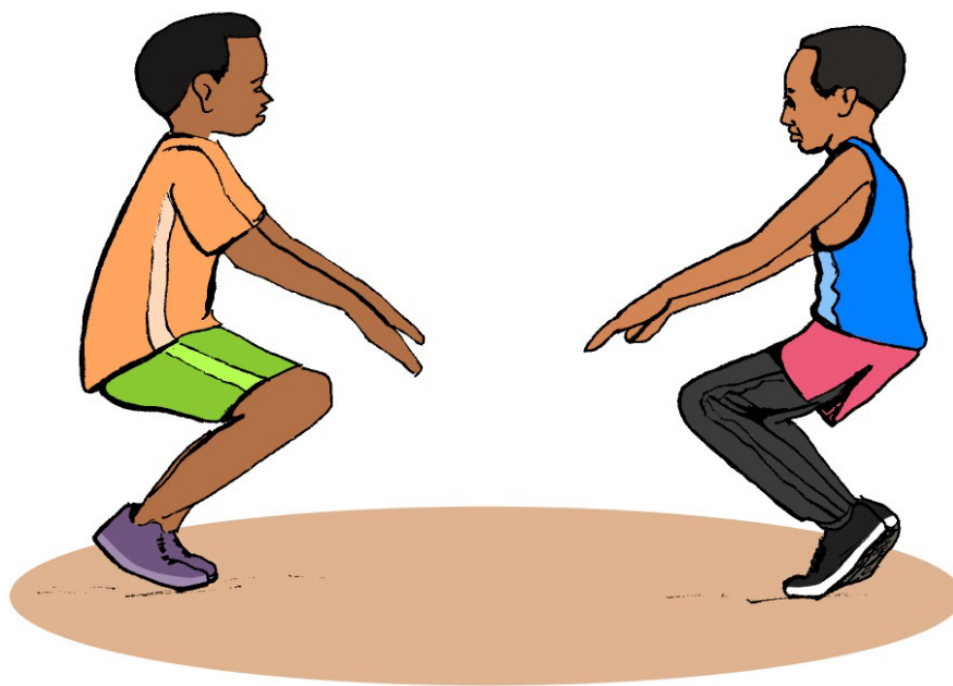

d. Lesson development

To teach this lesson, teacher will use two exercises.

Exercise 1: Crouch jump

Teaching points:

1. Instruct learners to place both hands on the ground;
2. Command learners to jump back and forth over the ground;

N.B: while learners jumping, the weight should be on the hands and jump with legs as high as possible.



Exercise 2: Jumping over the rope

Teaching points:

1. Organise learners in groups of 3;
2. Give each group long rope, one learner will jump first as the other two remaining act as rope turners;
3. Tell the learners to jump while entering the turning rope, they should stand besides; time the turning rope when it touches the floor;
4. Tell the rope turners to command the jumper 'go' each time the rope touch the floor;
5. Tell the jumper to concentrate on jumping in the centre of the rope while facing a turner;
6. Tell the jumper to exit the rope by facing and jumping toward one turner and exist immediately after jumping;



Cool down activities: Refer to the lesson one.

e. **Assessment**

The teacher should apply a teaching and learning strategy that leads learners through a 3-step discussion (**Reflect-Connect-Apply**) about their experience:

Reflect: Ask learners the following question,

- What was interesting and challenging during the exercise/game of crouch jumps and rope jumping

Connect: Ask learners the following question,

- How does the exercises/game connect/relate to what you already know, believe or feel?

Apply: Ask learners the following questions,

- How are you going to apply your new experiences from the exercises of crouch jumps and rope jumping in your daily life?

Lesson 2: Basic gymnastic equipments

a. Prerequisites

A learner is able to perform different motor skills needed to perform different basic gymnastics exercises.

b. Teaching resources

Mats, carpets, playground, whistles, stop watches, balls, bench, rope, piece of chalk and other gymnastics equipments.

c. Introduction

Opening discussions: Follow the instructions from **lesson 1** but for this lesson ask learners different gymnastics equipments and related exercises to be done on those equipments.

Warm-up activities or game

Title of the game: On the beach, in the water

Summary description of the game:

This game aims at following commands and warming-up the body, learners must be attentive to the orders of the teacher and take actions according to the instructions indicated.

Organization and rules of the game:

1. Ensure that the playground is clean and safe;
2. Draw a line on the floor with a piece of chalk or a rope;
3. Ask all learners to stand on one side of the line;
4. Explain and demonstrate:
 - Learners are on the beach.
 - There is water on the other side of the line.
5. Give two commands: (on the beach) or (in water), and learners have to jump from the correct side of the line;
6. Start with those two commands, moving back and forth until learners feel comfortable and confident;
7. Tell learners that you will add more command, and that they have to be careful;
8. Do all learners understand and follow commands? Are they involved or participate in the game?
9. Do all learners feel at ease and try to follow commands? Are all learners involved? Does every one participate?

10. Reduce commands according to how skilful learners are.

Other orders:

“**Hot sand!**” Learners jump from one foot to another.

“**Seagulls**”: Learners cover their heads with hands

N.B: It is up to the teacher to decide when the game ends.

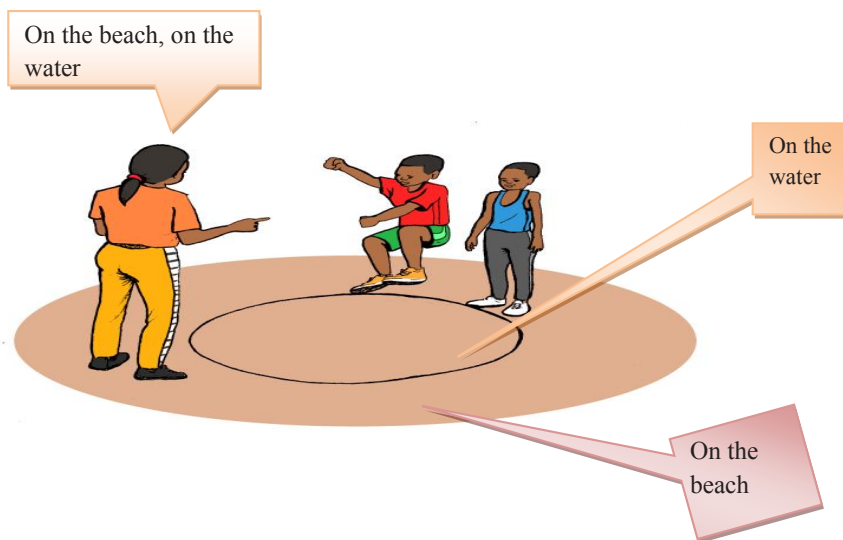

d. Lesson development

Exercises 1: Moving on parallel beams

Teaching points:

1. Instruct learners to move (walk) on the parallel beam with controlled, deliberate steps;
2. Tell learners that the speed is not the goal;
3. Telling learners to step slowly on the beam, pause momentarily in good balance and walk till they complete the routine.

Cool down activities: Refers to the lesson 1.

e. Assessment

Reflect: What was interesting and challenging during the exercise/game of crouch jumps and rope jumping

Connect: How does the exercises/game connect/relate to what they already know, believe or feel?

Apply: How are you going to apply your new experiences in your daily life?

1.5. Additional information

A Play based learning approach is a learner centered learning approach whereby appropriate games are used to help learners to learn faster and better, more easily and in an enjoyable manner. Psychologists have recognized that through play, learners are attentively focused on their objective.

How to use a game in learning

Game is one activity of a lesson that can be divided into two phases:

Preparatory phase

- Select or develop a game according to the subject and learning outcome
- Prepare all materials needed
- Identify the steps of lesson where the game will fit

Execution phase

- Arrange the classroom according to the game selected
- Explain to learners the name and the purpose of the game
- Lead the game in a funny way following its instructions
- If the game is long, work on it with few learners, then help others encourage their teams
- Stop the game
- Ask learners to reflect on the game and discover the relationship between the game and the lesson
- Continue with the steps of the lessons

The game could fit in the introduction when reviewing the previous lesson to help learners to discover a new concept, in the main body while teaching new concept by demonstration or manipulation and in the conclusion and evaluation, by strengthening the new skills acquired, capturing learners' ideas, and assessing the learning outcomes.

Benefits of play

- Learners learn by acting out funny scenarios
- Most activities are done by learners, in their learning environment under the teacher's guidance, taking into consideration the age of learners, their gender, needs, and their backgrounds experiences. In this way learners are motivated, interested, and engaged and retain more learning
- Learners construct knowledge and understanding. They learn practical skills by being engaged in a productive and motivating learning environment
- Play facilitates the development and internalization of life skills (problem solving, cooperation and communication skills, lifelong learning competences), encourage the development of attitudes and values, including conflict resolution
- Play promotes literacy, numeracy and the development of scientific concepts

- Play allows learners to work alone or with others, to help their holistic development
- Learners can initiate the playing rules/games
- In play learners work without fear of making errors can take risks and try things out
- In play learners enjoy control, can succeed and have experiences that build their self confidence

Challenges

- Involves creative thinking in planning lessons.
- Selecting or developing appropriate games can be a very time-consuming job and challenging for the teacher
- Play can over-simplify the situation being investigated so that learners overlook some important learning
- Play can consume large amounts of time (NB: it is more important for learners to learn than for them to “cover” content quickly).
- It can become “too much fun” and disrupt the task
- Learners can get too involved and lose objectivity

1.6. End unit assessment

Independently carry out warm up and basic techniques of gymnastics exercises using different gymnastics equipments.

1.7. Additional activities

Here below are other additional games of warm-up; teacher is advised to choose any other game to use for warming-up learners.

Game 1: Secret cat

Summary description of the game:

This game is aimed at warming –up legs and arms, learners play role of secret cat (named discreetly by the teacher) run to catch the rest of the comrades.

Materials needed: Whistle, a piece of chalk (or anything to draw a line on the ground).

Organization and rules of the game:

1. Demarcate clearly a playground large enough to allow learner to run one after another.
2. Draw a clear start line on one of playground extremities using a piece of chalk or landmarks.
3. Ask learner to stand on the line, all facing the same direction.
4. Tell learner that you are going to walk behind them and touch some of them on the back.

5. Ask them to close eyes so they may not know to whom you gave a slap.
6. Explain and demonstrate:
 - Any learner who is given a slap in the back becomes a cat (Chose between 4 and 5 cats for 20 learners).
 - Cats have no right to tell other learner who are on the line that they have been chosen.
 - When the teacher says (Go!), learner run across the whole playground, and cats try to gently slap as many learner as possible.
 - A learner who is touched must come back to the line.
 - The round is complete when all learners who are not cats are on the line.
7. Choose new cats every round.
8. Keep on playing until every learner has had an opportunity to become a cat. Make sure that learner is paying attention while running, not running into each other.
9. Check if
 - Do cats slap each other gently;
 - Do different learner get chance to become cats in each round;
 - Do all touched learner come back to the line;

Variations:

At the beginning of one round, touch all learners on the backs, so that they all become cats.

At the beginning of the one round, walk up the line but do not touch anyone's back.

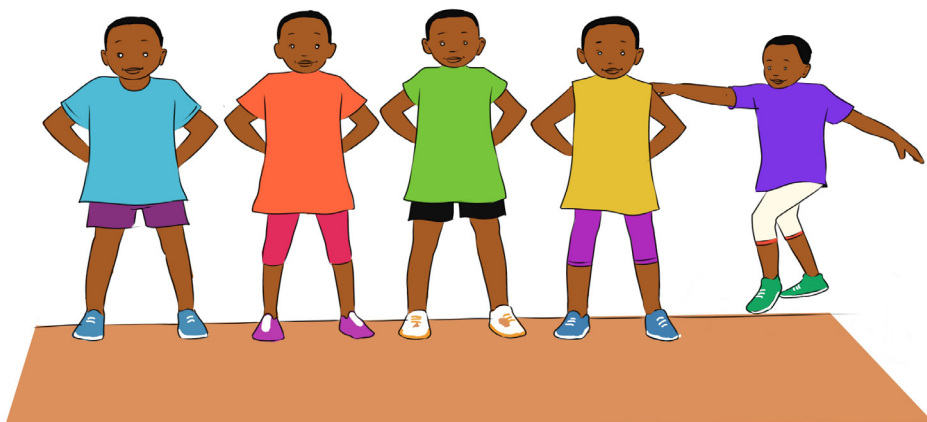

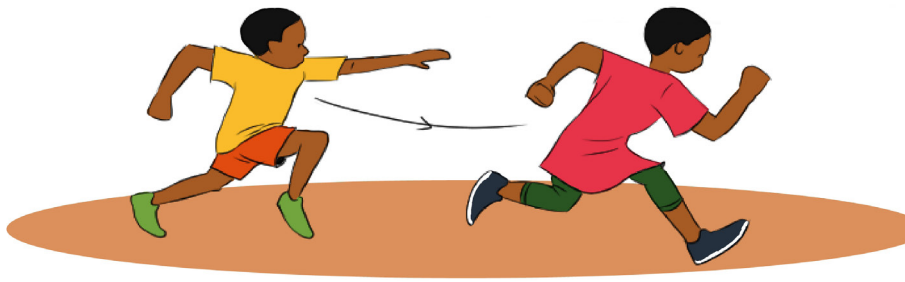

Game 2: Cat-shadow

Summary description of the game: This game aims at warming-up learners. This game requires learners to carry out orders of the teacher to walk in the shadow of the partner or to avoid being caught.

Materials: whistle

Organization and rules of the game:

1. Demarcate clearly a playground large enough to allow learner to run one after another.
2. Make sure that there is a sunny day while playing this game.
3. Choose one of them to be number 1 and the other to be number 2.
4. Put learner in pairs.
5. Ask learner to say where their shadow is and where they are.
6. Explain and demonstrate:
7. When the teacher says (number 1), all number 1s chase shadows of their partner. The number 2s run so that number 1s cannot walk on their shadows.
8. While chasing shadows, number ones count how many times they have been able to walk on shadows of their partners.
9. When you say: (number 2) all number 2s change the role and start chasing shadows of their partners (no 1s)
10. Change numbers every 30 seconds. Make sure that learner are permanently watching one another all the time.

Variation

Show learner different ways of moving while chasing one another.

For example; walking, hopping, and marching, with straight legs,

UNIT 2: BODY CONTROL AND BALANCE

2

2.1. Key unit competence

Perform a range of simple actions and movements with consistency, fluidity, clarity and cooperation with others.

2.2. Prerequisite knowledge and skills

Learner will learn better this unit, if he/she is able to respond to the teacher's instruction, perform simple actions/movements with consistency, fluidity and clarity and apply some attitudes like, flexibility, coordination, balance, etc.

2.3. Cross-cutting issues to be addressed:

- **Peace and values education:** Instruct learners to follow instructions and encourage them to have patience, team work spirit, mutual help and respect different opinion of others.
- **Gender education:** Encourage both girls and boys to participate actively at the same pace when playing different games used in this unit.
- **Inclusive education:** Simplify expectations for activities. Modify activities so they suit the abilities of slow and attention span of the learners. Allow all learners with physical disability (using wheelchair) to play sitting on it during different games used in this unit.

2.4. List of lessons

#	Lesson title	Learning objectives (from the syllabus including knowledge, skills and attitudes):	Number of periods
1	Exercises and games which develop cognitive, social and emotional control.	<p>Perform different exercises and games that develop intelligence, cooperation, social respect, and emotional control, patience and happiness.</p> <p>Appreciate the importance of physical activities to health</p> <p>Self-confidence</p> <p>Apply fair play</p>	1
2	Different types of formations and hand-eye coordination.	<p>Practice different types of formations and hand-eye coordination.</p> <p>Flexibility</p> <p>Balance</p> <p>Coordination</p>	1
3	End unit assessment		1

Lesson 1: Exercises and games which develop cognitive, social and emotional control

a. Prerequisites

A learner will learn better this lesson if he/she is able to:

Respond to the teacher's instructions;

Perform a range of aerobic warm-up exercises;

Carry out prolonged inspiration, expiration and relaxation exercises of muscles.

b. Teaching resources:

playground, Armband, beanbag (rolled up sock), a rug, towel or grass, etc.

c. Introduction:

- **Opening discussions:** For opening discussion, refers to the unit one, lesson one.
- **Warm-up activities or game**

Title of the game: Balance tag.

Summary description of game:

This game aims at warming-up the body, and it will also help learners to hold their balance.

Organization and rules of the game

1. Designate a play area large enough for a game of tag.
2. Tell the learners you will be playing a game of tag.
3. Explain that this tag game is different because a tagged Learner must stand in the balance position for 5 seconds.
4. Show learners the balance position – standing on one foot with both hands on their hips.
5. Ask for 2-3 volunteers to play the role of the catcher.
6. Give each catcher an armband to identify them.
7. Explain and demonstrate that:
 - Catchers will work to tag all the other learners.
 - When a catcher tags a learner, the learner must stand in the balance position for 5 seconds.
 - After 5 seconds, the learners can continue running.
8. After playing the game for a while, choose new catchers.
9. Make sure the learners tag one another gently.

Variations

Challenge learners to hold the balance position for 10 seconds.

Ask learners to balance as though they are a different Animal each time they are caught. For example, "Balance like a monkey on one foot."

Change the Balance Position to something more difficult. For example, “Standing on one foot with two hands in the air, or “Standing on one foot with one hand on your nose.”



d. Lesson development

For this lesson, teacher is advised to use the below proposed games to help learners to develop intellectual, social skills and good relationships with friends.

Game 1: Frozen tag

Summary description: This game aims at developing cooperative skills and good relationships with friends. There will be a volunteer (learner) to tag the other learners, the tagged ones are frozen and need to be unfrozen.

Organization and rules of the game

1. Ask for a volunteer to be “it.” This person tries to tag the other learners. Appoint more than one learner to be “it” if the group is large enough.
2. Explain and demonstrate that:
 - If the person that is “it” tags someone, the tagged learner is “frozen” and must stand with legs apart.
 - To become unfrozen, another learner must crawl through the frozen player’s legs.
3. The game is finished when all learners are frozen.
4. The last learner frozen becomes “it” for the next game.
5. Ensure the play area is clean and free of obstacles.

Variations

Once a learner is freed from being frozen, they must stay connected to the learner who “unfroze” them while trying to avoid being tagged.



Game 2: Frozen beanbag

Summary description of the game: This game aims at developing leadership, respect and empathy for others.

Organization and rules of the game

1. Tell the learners the boundaries of the play area.
2. Give each learner a beanbag.
3. Ask the learners to place the beanbags on their heads.
4. Explain and demonstrate that:
 - The learners are free to move around the play area at their own pace.
 - If the beanbag falls off a learner’s head, that learner is frozen.
 - To become unfrozen another learner must bend over, pick up the beanbag and place it on the head of the learner who dropped it, without dropping their own.

5. The game finishes at your discretion.
6. Ensure the play area is clean and free of obstacles.
7. Check if learners have a willing of helping each other who the bean bag and if they are exploring the entire play area.

Variations

- Provide the learners the opportunity to place two beanbags on their head.
- Encourage the learners to speed up their movements.
- Place obstacles for the learners to step on or over while.

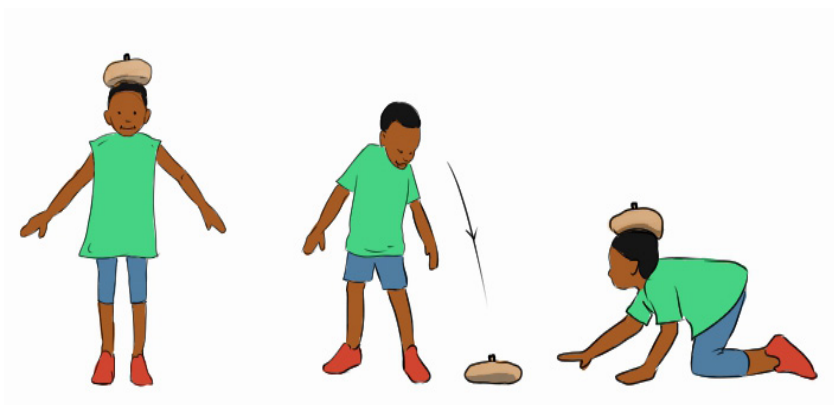

Cool down activities/exercises: Refer to unit one, lesson one

Game: Lazy day rest game

Summary and description of the game: This game aims at cooling and relaxing the body while contracting and relaxing various muscles.

Organization and rules of the game

1. Ask learners to lie on their backs, legs slightly apart and arms relaxed at their sides.
2. Ask the learners to slowly contract and relax different muscles for example:
 - Take a deep breath, hold and relax;
 - Pull your toes toward and then away from your body, hold and relax;
 - Pull your stomach/belly in, hold and relax;
 - Make a tight fist with your hand, hold and relax;
 - Smile while turning your head from side to side and repeat action.
3. Continue asking the learners to slowly contract and relax different muscles until they have cooled down and are relaxed;
4. Make sure there is enough space between learners so they do not hit each other as they follow the instructions;

5. Check if learners are not trying to disturb others, moving slowly and avoiding sudden stretches, are the learners behaving calmly and quietly, and stand or sit while completing the activities.

Variations: Ask the learners to stand or sit while completing the activities. A chair may also be used.

e. *Assessment*

Reflect: Ask learners the following question,

- What was the difficult part of the games?

Connect: Ask learners the following question,

- How the frozen game have been helped you to improve your cognitive, social and emotional control?

Apply: Ask learners the following questions,

- What is something you can do to improve your cognitive, social and emotional control?

Lesson 2: Different types of formations and hand-eye coordination

a. Prerequisites

Learners will learn better this lesson if they are able to control their emotions, develop self-confidence, cooperate and apply fair play with others while playing.

b. Teaching resources:

Bean bag, buckets, banana leaves, rope, chalks, song/music/clap if music is not available.

c. Introduction:

Opening discussion: For opening discussion refers to the unit one, lesson one.

Warm-up activities/exercises:

Game: Islands and oceans

Summary description of the game: This game aims at warming-up learners. During the game learners will try to find their island when music is stopped.

Organization and rules of the game

1. Give each learner a hula hoop and ask the learners to spread out in the play area;
2. Ask the learners to place the hula hoop on the ground and stand inside it. (If you do not have hula hoops, draw circle, on the ground for each learner using chalk.)
3. Explain and demonstrate that:
 - The circle each learner is standing in represents an Island.
 - The space in between the circles represents water.
 - When music is playing, the learners will pretend to swim through the Water area.
 - When the music stops, each learner will return to the Island and stand on it.
 - When the learners are on the Island, they will be asked to do an activity. For example, “Stretch tall on your Island,” “Fill as much space on the island as you can,” “Make different positions on your island (a stretch, a tuck),” “Lift up the Island and stand underneath,” “Fall asleep under a palm tree,” “Jump on, off, skip around the Island,” etc.
 - When the music starts again, the learners will jump off their Islands and “swim” around again. When the music stops, each learner should “swim” back to an Island.
4. Ask the learners to do another series of activities each time they stand on an Island.
5. The game can be played as long as desired.
6. Check if,
 - Learners are swimming around the islands when the music is being played;

- Learners are returning to their own Islands when the music stops?
- Learners performing the activities on the Island?

Variations

- Give learners 3 seconds to find an Island every time the music stops. After the time limit is up, you, acting as a Shark, will swim into the water to try and catch the remaining swimmers;
- Instead of asking the learners to find an Island of their own, every time the music stops, one hula hoop should be taken away and the learners have to crowd together onto the remaining Islands.

d. Lesson development

For this lesson below, teacher is advised to put emphasis on different formations/ dispositions learners are making within games. The lesson is taught using three games.

Game 1 is called: Duck, Duck, Goose.

Game 2 is called: Bean bag game for balance

Game 3 is called: Bean bag game for coordination

- Bean bag toss
- Bean bag relay

Game 1: Duck, Duck, Goose game

This game will help learners control their body and balance as well.

Organization and rules of the game

1. Have the learners form a large circle, standing facing inward.
2. Select one learner to be the Wolf. This learner will go around the circle tapping the other learners lightly on the head or shoulder while saying “Duck, Duck, Duck...” fairly loudly.
3. When they choose to do so, they need to tap one learner and instead of saying “Duck”, they say “Goose”. The learner who is the Goose needs to get up, run around the circle and chase the wolf.
4. If the goose tags the wolf, goose wins. If the wolf sits at the empty spot first, wolf wins!



Game 2: Bean Bag game for balance

Have your learner **balance a bean bag on the head** while walking along a balance beam, a length of rope, or along a line marked out on the ground.

Increase the challenge by asking your kids to keep the bean bag on their heads while:

- Doing a heel-toe walk
- Walking around obstacles
- Lowering the body to touch an object on the ground!



Walking while balancing a bean bag on his head

Game 3: Bean Bag Games for Coordination

1. Bean bag toss

- This bean bag game develops hand-eye coordination. Show your learners how to toss a bean bag gently into the air and then catch again. Younger learners can do a very gentle toss; older kids can toss just above head level.
- Increase the challenge by introducing a hand-clap between tossing and catching. (ie toss, clap, catch), or a one-handed catch for older kids.

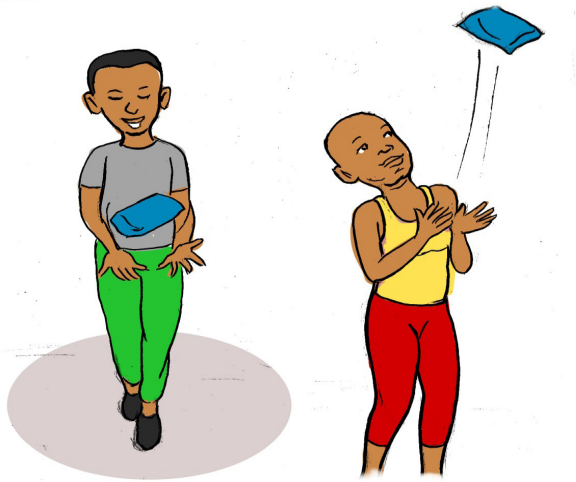

- For a learner whose hand-eye coordination is particularly poor, tie the beanbag into a vegetable net bag, and suspend it from a tree branch with a rope.
- The learner can then practice pushing the beanbag away and catching it again, as it is shown here below on the picture
- Two learners can also practice tossing the bean bag to each other. Start off standing close together as shown and then increase the distance between the learners.



Bean Bag tossing between 2 learners.

2. Bean bag relay

- You need a few learners for this – get them to stand in a line, one behind the other.
- Put a pile of beanbags in the front, and an empty bucket at the back.
- The learner in front grabs a bean bag and passes it overhead to the learner behind and so on, until the last learner pops it in the bucket, and then runs to the front to repeat the bean bag relay.
- Your learner will be using hand-eye coordination to accurately receive and pass the bean bag without dropping it, and bilateral coordination by using both hands together to receive and pass the bean bag.
- You can also have the learners pass under their legs, or alternate passing under and over (harder).



A relay game with bean bags

- **Cool-down activities /exercises**

Game: Bridge or Tunnel: This will help learners to feel relaxed and being good-natured and cooperative. Teacher is advised to give learners clear instructions.

Summary description of the game: This game aims at relaxing learners. Learners will need to follow the instructions from the teacher and form bridge or tunnel shapes with partner.

Organization and rules of the game

1. Ask the learners to find an open space in the play area.
2. Explain and demonstrate that:
 - When you say, “Go!” they should move freely about the play area hopping,

jogging, dancing or marching.

- You will call out either “Bridge” or “Tunnel.”
- When they hear the word “Bridge,” they should find a partner, stretch their arms in the air and touch palms with their partner.
- Ask learners not to lean on their partner when making the bridge shape to avoid falling into one another.
- When they hear the word “tunnel,” they should find a different partner and stand back to back, spreading their legs wide apart, placing their hands on their knees, and bending over slightly.
- After holding either position for 15 seconds, you will say, “Go!” again and they should continue moving around the play area until the next position is called.
- The game ends at your discretion. Check if ,
- Every learner is working with a partner to create bridge and tunnel shapes;
- Learners are choosing a variety of partners each time “bridge” or “tunnel” are called.

Variations

- Demonstrate additional descriptions and positions to add to the game. For example:
- “Mountains” – learners find a partner and stand side-by-side, then bend over and place their hands on the ground 1 meter in front of their bodies.
- “Water Well” – learners find a partner and kneel facing each other, they then create a circle (the well) with their arms, holding hands with their partner.

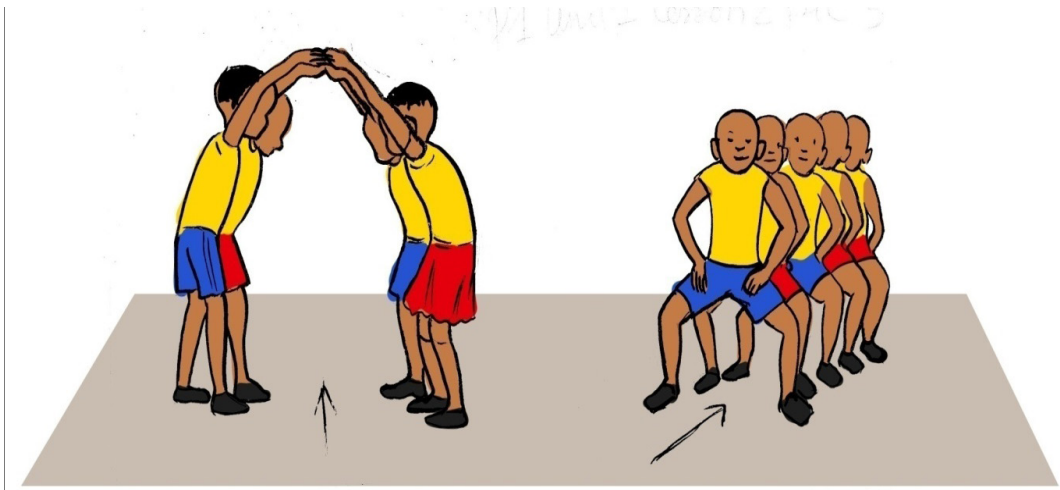

e. Assessment

- **Reflect:** Ask learners the following question,
 - Which game that was more interesting to you?
 - Did the game become easier as you played? Why or why not?
- **Connect:** Ask learners the following questions,

-How the games you have been playing helped you to improve eye-hand coordination, balance and make different formations?

-When else in life is necessary to have eye-hand coordination and balance?

- **Apply:** Ask learners the following questions,

-What is something you can do to improve coordination and balance?

2.5. End unit assessment

In game situation learners perform a range of actions and movement with consistency, fluidity, and clarity and the teacher put emphasis on how learners have balance, apply eye-hand coordination and help each other.

2.6. Additional activity

Here below there is an additional game to help learners to develop concentration and attention skills. It is up to the teacher to use it during lesson development or not.

Name of the game: Directions

Summary description of the game: This game aims at developing concentration and attention skills of learners, and it requires learners to follow instruction or directions.

Organization and rules of the game

1. Ask the learners to find a space in the play area and to face you.
2. Ask the learners to point in the following directions: left, right, forward and backward.
3. Explain and demonstrate that:
 - This is a game about directions.
 - You will give the learners a direction and they will start walking in that direction (for example, “Walk to your left,” “Walk forward”).
 - When you give a new direction, the learners will change the direction they are walking in.
 - Ask learners to watch where they are moving so that they do not collide with others.
4. Once they are comfortable with changing direction, add actions to the instructions (for example, “Jump left,” “Skip right,” “Twirl backward,” “Crawl forward”).
5. The game ends at your discretion.
6. Check if every learner is moving in the correct direction and being good-natured and cooperative.



Variation

- Give the learners multiple directions to follow and ask them to move in one direction right after the other (for example, “Take two steps forward, and hop three times to the right.”).
- Ask learners with common characteristics to move together (for example, “All learners wearing sandals, move two steps to the left,” “All learners with brown hair crawl to the right”).

Discussion

Reflect

- What was easy about the game?
- What was difficult about the game?
- Did it become easier to play the game after a while? Why or why not?

Connect

- What are some times in your life when you know your “lefts” and “rights” are important?
- What have you done to help you remember your “lefts” and “rights?”

Apply

- Why is it important to understand directions such as left and right?
- When would it be helpful to know directions such as left and right?



UNIT 3: GYMNASTICS

3

3.1. Key unit competence

Perform floor exercises or use exercising machines.

3.2. Prerequisite knowledge and skills

Learners will learn better this unit if they are able to respond to the teacher's instruction and perform different physical activities and flexibility exercises.

3.3. Cross-cutting issues to be addressed:

- **Gender education:** Engage both girls and boys and help them to exploit their full potentials during the exercise of forward and backward roll.
- **Inclusive education:** For learners with disability or other learners with different special education needs plan adapted exercise for them. Find the easiest backward exercise for them.
- **Comprehensive sexuality education:** In teaching-learning process the teacher and learners must set instructions that prevent sexual harassment, violence and bad body touches.
- **Environment and sustainability:** Help/guide learners to collect all material used during teaching and learning process.

3.4. List of lessons

#	Lesson title	Learning objectives (from the syllabus including knowledge, skills and attitudes):	Number of periods
1	Forward roll exercises	Perform basic gymnastic exercises to develop suppleness focus on rolling forward Demonstrate the safe use of different gymnastic equipment.	1
2	Backward roll exercise	Practice different basic gymnastic exercises with control focussing on rolling backward.	1
3	End unit assessment		1

Lesson 1: Exercises of rolling forward and use different gymnastics equipments

a. Prerequisites

Learners will learn better this lesson if they are able to perform different motor skills and simple gymnastics movements.

b. Teaching resources:

chalk (anything to mark a line on the ground), mat, whistle, etc

c. Introduction

- Opening discussion: Refers to the unit 1 lesson 1.
- Warm-up activities

Game: Secret tag.

Summary description of the game:

This game aims at warming-up the arms and legs. Teacher will walk behind learners and tap some of them on the back. And the tapped one is chasers. Chasers will try to gently tag as many learners as possible.

Organization and rules of the game.

1. Mark clear boundaries for a play area that allows learners to run and chase each other.
2. Mark a clear line using chalk or markers at one end of the playing area.
3. Ask the learners to stand on the line facing in the same direction.
4. Tell the learners that you will walk behind them and tap some learners on the back. Ask them to close their eyes so that no one will know who has been tapped.
5. Explain and demonstrate that:
 - Whoever you tapped on the back is a Chaser. (Select 4-5 Chasers for every 20 learners).
 - The Chasers are not allowed to tell the other learners that they have been picked.
 - When you say, "Go!" the learners will run into the open space and the Chasers will try to gently tag as many learners as possible.
 - A tagged learner will return to the line.
 - The round is complete when all learners (other than the Chasers) are standing on the line.
 - Select new Chasers each round.
6. Continue playing until every learner has had a chance to be a Chaser.

7. Make sure the learners are watching where they are running, and not running into each other.
8. Check if chasers are tagging each other gently.
9. Check if learners who have been tagged returning to the line.

Variations

- At the beginning of one round, tap everyone on the back so that they all become Chasers.
- At the beginning of one round, walk up the line but don't tap any one on the back.



d. Lesson development

Forward roll technique is done in two ways, include: forward roll for beginners done in seven steps and advanced forward roll done in three steps. So teacher is advised to demonstrate clearly the exercises or use the most able learners to demonstrate it.

A forward roll is a basic gymnastics move that looks like a graceful somersault. To perform one correctly, you should be able to move from the starting position into a roll and get back on your feet all in one motion. It takes practice to do a forward roll without using your hands to support you as you stand up.

Forward Roll exercise for beginners

Steps 1: Stretch first.

Start off by stretching your back, wrists, and legs to avoid getting hurt while doing this trick

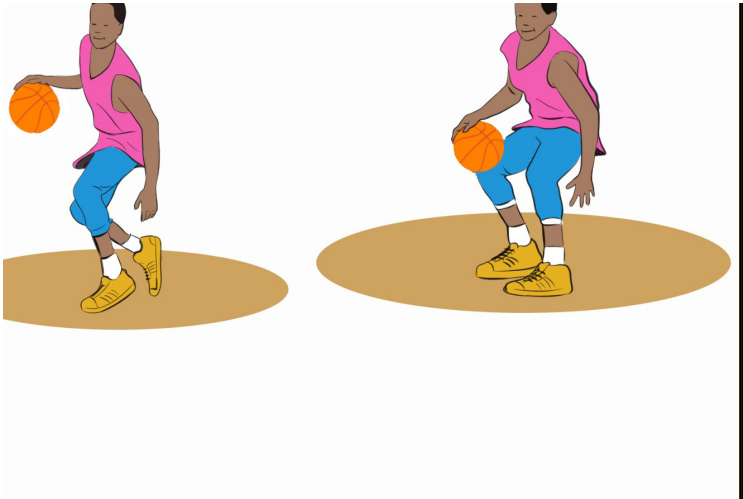

Step 2: Stand on a mat in a wide open space.

- Take learners outside in the grass or inside of the gym mat.
- Look for a flat space where you'll have plenty of room
- Help learners to do a forward roll on a downward incline and use gravity to help you move into the roll.

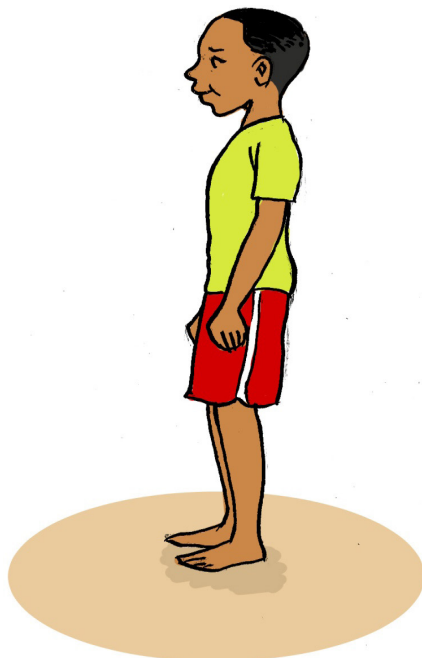

Step 3: Get in starting position.

1. Ask learner to squat feet together;
2. Place the feet together;
3. Bend the knees so they are squatting;
4. Place the hands on the ground in front of with elbows bent;
 - The hands should be evenly spaced at shoulder width;
 - This is the starting position for a beginner's forward roll;
5. Alternatively, start in an upright standing position with hands stretched straight over your head.
6. Pike your body forward and bend your knees to move into a squatting position to start the roll.



Step 4: Drop your head between your arms

1. Be sure to tuck in your chin.
2. Move into the roll, you
3. Do not want to place weight on your neck it should move directly onto your upper back.
4. Tuck in your chin will help ensure that you don't put pressure on your neck.



Step 5: Roll forward

1. Push over onto your upper back, so that your body rolls forward;
2. Push your hips over your head;
3. Follow the curve of your spine as you roll;
4. Keep your back curved and keep your hands in position;

Note:

- Do not roll from side to side, roll straight forward along your spine. Otherwise, you may fall to one side or the other.
- Be sure to keep your chin tucked in and your back curved. If you straighten out, your roll won't have as much momentum.



Step 6: Have straight legs and pointed toes

Throughout the roll, your legs should stay straight and your toes pointed.

Bend your legs only at the end of the roll, when it's time to stand up.

N.B: This is the standard positioning for a beginner's forward roll.

However, some gymnasts prefer to tuck in the legs during a forward roll. If it helps you gain momentum to keep your legs tucked, you can practice that way, too.



Step 7: Stand without using your hands for support

1. Place your feet flat on the floor and move into a standing position without putting your hands on the ground at the end of the roll;
2. Straighten your legs,
3. Finish upright with your hands over your head.

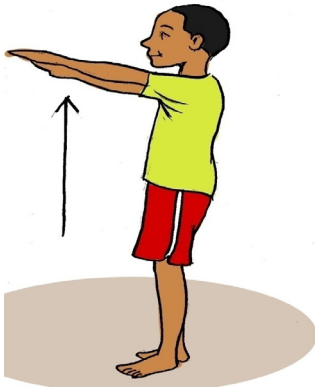

Doing Advanced Variations

Step 1: Do a handstand forward roll.

1. Start with basic handstand, legs spaced apart and the body upright.
2. Move into a handstand and pause for a moment. Instead of three kicking out of the handstand, bend your arms and lower your body toward the ground
3. Tuck your head and move into a forward roll;
4. Finish in a standing position with your hands stretched over your head. In a correct handstand forward roll your arms stay straight
5. Curve your back and roll. But doing one with bent arms is perfectly fine too.

N.B: Before learners attempt a handstand forward roll, they have to be sure they have mastered both the handstand and the forward roll separately.



Step2: Do a forward roll kip-up.

1. Start in the same way as the standard forward roll;
2. Instead of completing the roll and standing up, kick your legs outward and lunge your body out of the roll,
3. Jump with both feet into a standing position. The ending of a forward roll kip-up looks similar to the back handspring landing;
4. Use hands to help propel the body off the ground to jump into your landing;

Raise the body upright and end with arms extended over your head when both feet are firmly planted on the ground.



Step3: Do a dive roll.

This impressive advanced variation requires to;

1. Dive into the roll instead of starting in a fixed position;
2. Begin by doing a short headfirst dive, as though you have a small log to dive over,
3. Support your body with your hands as you move into a roll.
4. Make the dives bigger as you get used to diving.



Cool-down activities/exercises: For cool-down activity, refers to the unit 2, lesson 2.

e. Assessment

Reflect

- What was easy/ difficult about the exercise of rolling forward?
- Did it become easier to perform the exercise after a while? Why or why not?

Connect

- Which sport mostly need to perform a forward roll?

Apply

- When would it be helpful to perform the exercise of rolling?

Lesson 2 : Backward Exercise

a. Prerequisites

Learners will learn better this lesson if they are able to perform exercise of forward roll with balance, coordination and flexibility and use different gymnastics equipments.

b. Teaching resources:

Refers to the lesson 1.

c. Introduction

- **Opening discussion:** Refers to the unit 1, lesson 1
- **Warm-up activities/exercises:** Refers to the lesson 1.

d. Lesson development

A backward roll is a basic skill to master. It may be harder to learn at first and take a bit of practice to get it right. Help learners to start from working up done in five steps and then to the real backward roll done also in five steps .Demonstrate each step to the learners or use the most able learners to demonstrate it.

.Working Up to a Backward Roll

Step 1: Try rocking back.

Start in a squat position.

Hold your hands close to the body with the palms flat towards the ceiling. They should be shoulder height.



Step 2. Try putting the mats in a V:

Set up your mat in a V shape master the backward roll. This helps you to protect your neck and learn how to roll in a straight line.



Step 3: Use a wedge.

- Sit on the higher end of a wedge to learn the best movement of a backward;
- Hold your hands close to your body;
- Face the palms flat towards the ceiling;
- Tuck the chin. Roll backwards down the wedge;
- Reach for the mat while keeping your hands close to your shoulders;
- Kick your toes over your head to roll yourself;
- Land on your feet.

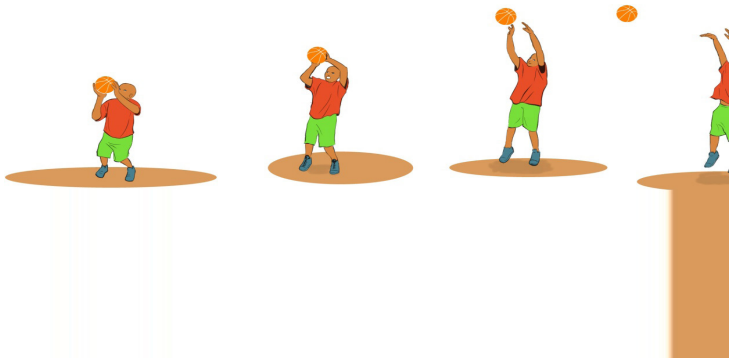

Step 4: Use a spotter.

- Ask someone to spot you if you are still unable to complete the roll,
- Tell the spotter stands to your side and grab your hips and help you to learn correct hand placement or build arm strength to push yourself off the ground.

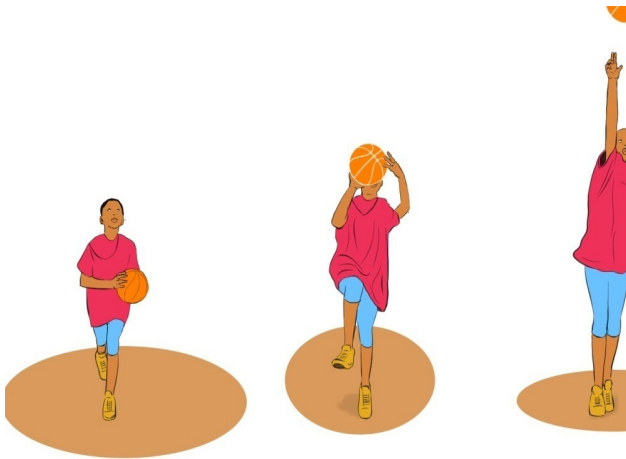

B.2. Completing a basic backward roll

Step1. Start in a squat position.

- Start with your knees together and your back straight. Your thighs should be parallel to the floor;
- Hold your hands out in front of you if you need help balancing,
- Start trying to begin in a standing position as you begin master the backward roll.

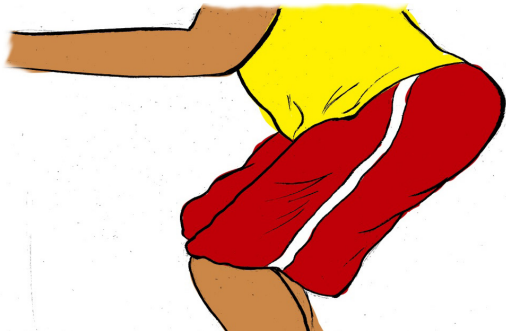

Step2. Hold your palms facing the ceiling

- Bend your arms close to your body.
- Place your palms facing towards the ceiling just above your shoulders.
- Tuck your chin to your chest like you are looking at your bellybutton. This is called having “pizza hands.” Your hands are flat like you are carrying two pizzas in them.

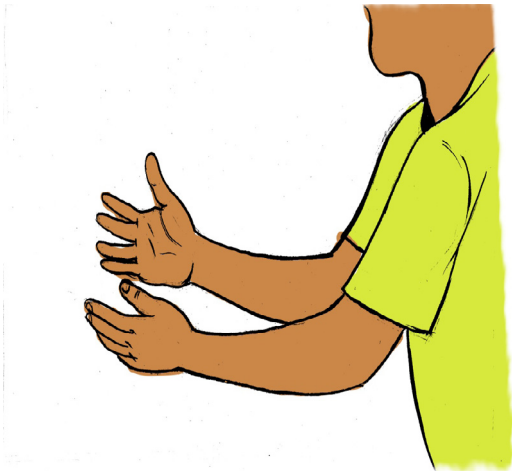

Step3. Drop your butt

- Drop your butt down by bending your legs from the squat position;
- Push back with your heels. You'll start to roll onto your back;

N.B:

- Another way to think about dropping down is to treat it like you are sitting down.
- Make sure that your back is rounded as you fall back onto it.
- Keep your legs together. Don't let them separate.

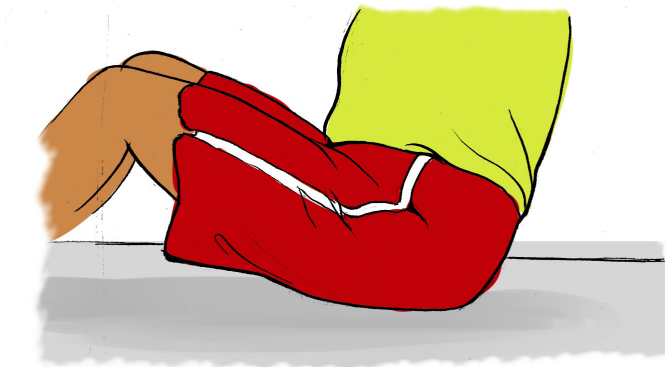

Step4. Push with your hands and shoulders

- Push with your arms and shoulders as the knees and legs start to go over your head;
- Shift your weight from your lower back to your upper back then to your hands;
- Drive the backward roll by moving your toes over your head, not by throwing your neck and head backwards;
- Engage your hands and arms when your body rolls towards your neck. You always want to protect the neck and head;
- Keep your hands in the flat position; they should easily make contact with the floor so you can push yourself over;

N.B: Your hands will be flat against the floor while your elbows will be pointing towards the ceiling.

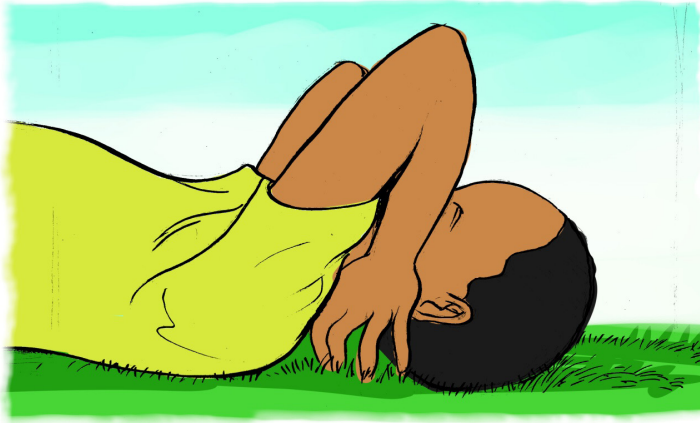

Step 5. Straighten your arms

- Start to lift up the hips as the arms are straightened. This will roll the body over your head.
- Land on your feet.
- If you land on your knees, try tucking yourself into a tighter ball.

Cool-down activities/exercises: Refers to the unit 2, lesson 2.

e. Assessment

Reflect

- What was easy/ difficult about the exercise of rolling backward?
- Did it become easier to perform the exercise after a while? Why or why not?

Connect

- Which sport mostly need to perform a backward roll?

Apply

- When would it be helpful to perform the exercise of rolling backward?

3.5. Additional information for teachers

a. Forward roll

The forward roll (colloquially called a roly poly) is one of the most basic elements in gymnastics and one of the first learnt. The forward roll is started from a standing position and then the gymnast crouches down, places their hands shoulder wide apart and hands facing forward. They tuck their chin to their chest and place the back of their head onto the floor. They then push off of the floor with their legs and rotate over their head onto their back.

The gymnast then presses their feet onto the floor and whips the arms forward to stand up.

Forward roll Prescription

- Stand tall with arms glued to your ears
- Squat down and reach in front of you as far as you can
- Once hands touch the ground jump and send your hips over your head
- Allow yourself to roll in a tuck position until feet touch the ground
- Reach in front of you and stand up using the momentum as if you were doing a narrow stands squat.



b. Backward roll

The backward roll is similar to the forward roll, but in reverse. The gymnast starts in a standing position and bends to a squat/sitting position with their arms in front. They then lower and lean back slightly until their bottom reaches the floor. They then continue this momentum and roll over their back onto their shoulders. They should then place their hands next to their shoulders and tuck their head into their chin. The hands then push the floor strongly and straighten their arms and continue to rotate their body over their head. The feet are then placed on the floor and the gymnast stands.

Backward roll prescription

- From a standing position, keep your arms up and sit back into a squat and roll onto your back
- As soon as your butt and back touches the ground, bend your arms and reach behind your ears
- Your hands should catch ground as you continue to roll back on your shoulders, protecting and taking any pressure off your neck and head
- To complete the roll, allow the momentum to bring your legs and hips over your head
- Only when the hips roll past vertical over your body do you press with your arms to finish the rotation to land on your feet again.



Backward roll Variations:

- **Backward roll to handstand** : This is essentially the same as a backward roll, however when the hands make contact with the ground, they straighten fully and the body continues to straighten upwards into a handstand position.
- **Backward roll on rings** - This is the same movement as a backward roll but it is performed on rings. It can also be used in a combination such as backwards roll to Maltese.
- **Shoulder roll** – This is similar to a backward roll but the roll is performed over one shoulder rather than pushing with the arms and rolling over the head. This is more commonly performed in Rhythmic Gymnastics, as it is faster and it also protects the hair.
- **Sideways roll:** A sideways roll is also known as a log roll, barrel roll, or pencil roll. This can be started by lying down on the back or front with the body outstretched. The gymnast then rolls onto their side and does a complete rotation of the body, remaining parallel to the performing surface. The log roll is a sideways roll with the hands next to the waist and the pencil roll is with the hands stretched above the head. A sideways roll can also be performed when a gymnast over-rotates or loses their balance in a vertical, forward or sideways direction.

3.6. End unit assessment

Practice different basic gymnastic exercises with control focussing on rolling.

3.7. Additional activities

Teacher can also help the weak learners to follow the steps below to perform backward roll in easiest way.

Stand: Stand up with your legs and back straight and your hands at your sides.



Crouch. Crouch down onto your knees.



Begin to roll. Roll backwards, onto your back

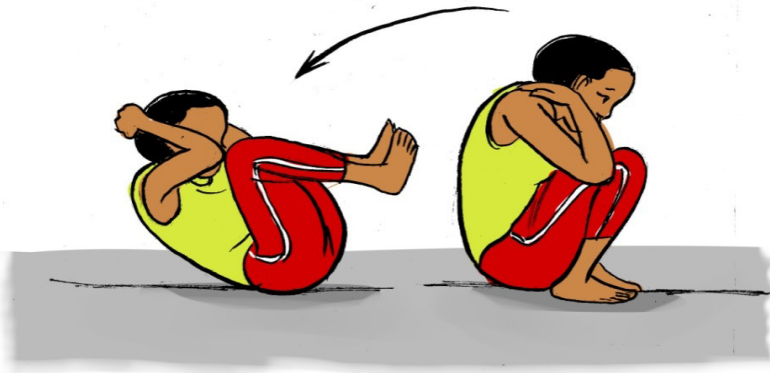

Gather your legs. Put your hands just below your hips to hold your legs up into the air (Like a back stand).



Flop your legs down. Let your legs fall backwards to your side.



Sit up. Use your arms to help you sit back up.





UNIT 4: ATHLETICS

4

4.1 Key unit competence

Use basic techniques in running, jumping, and throwing with speed, resistance and endurance.

4.2 Prerequisite knowledge and skills

Learners will learn better this unit, if they are able to carry out different aerobic warm-up exercises- perform strength, flexibility and balance exercises and respond to the teacher's instructions.

4.3 Cross-cutting issues to be addressed:

- **Gender education:** Engage both girls and boys and help them to exploit their full potentials during the exercise of running, jumping and throwing.
- **Inclusive education:** Facilitate learners with disability and some of them will be the referees, an assistant, the judges during educative games used in this unit. Do not let them be inactive.
- **Comprehensive sexuality education:** In teaching-learning process the teacher and learners must set instructions that prevent sexual harassment, violence and bad body touches.
- **Environment and sustainability:** Help/guide learners to collect all material used during teaching and learning process.
- **Financial education:** facilitate learners to make their own skipping ropes from banana leaves fibers and sisals fibers.

4.4 List of lessons

#	Lesson title	Learning objectives (from the syllabus including knowledge, skills and attitudes):	Number of periods
1.	Exercises of running		
1.1	Running 70 to 100 meters at top speed (sprint)	Perform running exercises of 70 to 100 meters at top speed.	1
1.2	Running nonstop for 5 to 8 minutes(endurance)	Run nonstop for 5 to 8 minutes.	2
2	Exercises of jumping	Perform jumping exercises: Jump with legs and arms open, jump forward, jump backward, jump left, jump right, jump with knees touching the chest.	2
3	Exercises of throwing	Perform exercises of throwing balls in different positions. Perform throwing exercises balls with two hands while bending and legs opened. Perform throwing sharp pointed sticks to a fixed target.	2
4	End unit assessment	State the reasons of athletics movement such as running, jumping and throwing in their daily life. Run various short distances with various intensities, and period of time Perform simple jumping and throwing exercises from their own choice.	1

Lesson 1: Exercises of running

a. Prerequisites

Learners will learn better this lesson if they are able to,

- Respond to the teacher's instructions;
- Perform different aerobic warm-up exercises;
- Perform different flexibility exercises;
- Practice different formations/dispositions during running exercises.

b. Teaching resources:

Playground, landing area, Armbands, batons, hurdles, corners, whistle, flag-poles, stopwatch, cards or piece of paper/balls.

c. Introduction

- **Opening discussion:** Refers to the unit 1 lesson 1.
- **Warm –up activities/exercises:** Refers to the unit 3 lesson 1.

d. Lesson development: Running exercises

This lesson has two sub-lessons:

The first sub-lesson called: Running 70 to 100 meters at top speed (sprint).

Second sub-lesson called: Running nonstop for 5 to 8 minutes (endurance).

1. Running 70 to 100 meters at top speed

Game 1: Formula One

Summary description:

Relay as a combination of flat-, hurdles- and slalom-sprint

Materials needed:

9 hurdles, 12 slalom-poles, 3 mats, 3 stopwatches, about 30 markers/cones, 3 batons / soft –rings.

Organisation and rules of the game

The distance is about 60m or 80m long and is divided into one area each for flat sprinting, for sprinting over hurdles and for sprinting around slalom poles (see figure).

- A soft ring is used as the relay baton. Each participant has to start with a forward roll on the tumble mat.
- The “Formula-One” is a team event in which each team member has to complete the full course.
- Up to **six teams** can compete at the same time on one course.

Scoring

The ranking is evaluated according to the team finished before and with the best time. The next teams are ranked according to their finishing time.

Assistants

- For each of the areas (hurdles, slalom) at least two assistants are required to set up the equipment properly. Apart from the team attendants, two additional assistants/learners with physical impairment of legs can be used to serve as exchange zone judges. One person also needs to be a starter. Finally, there is a need to have as many timekeepers as there are teams competing in the event. Timekeepers are also responsible for recording the scores on the event cards.

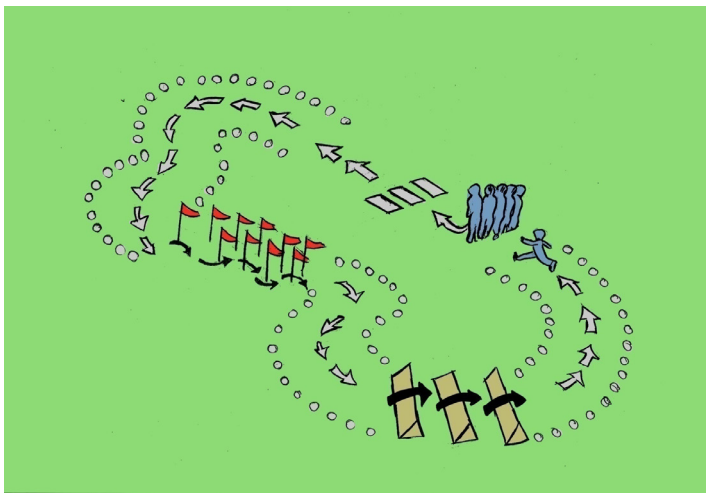

2. Running nonstop for 5 to 8 minutes

Game: 5 to 8 Endurance” Race

Summary description: Five to Eight-minute race using a course of 150m.

Materials needed: 1 stopwatch, 6 flag-poles, 6 corners - poles, 20 cards/chips per learner

Organisation and rules

- Each team has to run around a course of 150m (see figure above) from a given starting point.
- Each team member tries to run around the course as often as possible in 8 minutes.
- The start command is set for all teams at the same time (by blowing a whistle or by starting pistol, etc.).

- Each member of the team starts with one card (ball, piece of paper, cork or similar) which he/she has to take back to his/her team after each completion of a round on the course, and before starting again, he/she takes a new card or similar, and so on.
- After 7 minutes, the last minute is announced by another blow of a whistle or by starting pistol.
- After 8 minutes the completion of the run is indicated by a final signal.

Scoring

After having finished the course, all participants hand the collected cards to the assistant who counts them for scoring. Only completed rounds are counted; those which are not completed are ignored.

Assistants

For efficient organization of the event, at least two assistants per team are required. They are responsible for designating the starting line, as well as for dealing, collecting and counting the cards. They also must record the scores on the event card.

In addition, a starter is required for time keeping and giving the other signals (last minute and final signal).

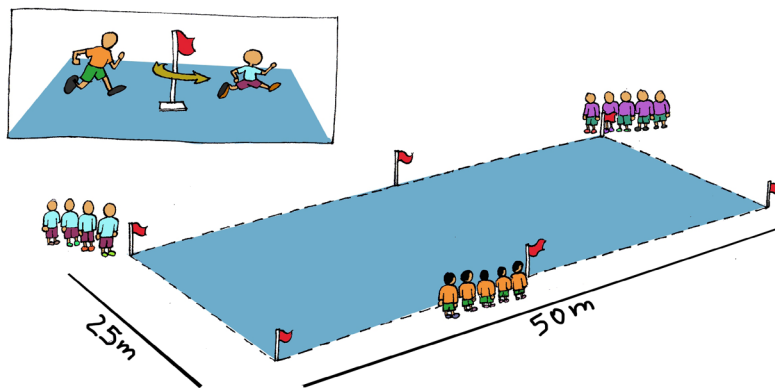

e. Assessment

Reflect:

- How do you feel after performing different running exercises?
- What was more challenging during the exercises of running?

Connect: How is sprinting important in our daily life

Apply: In which games/sports one can apply speed running?

Lesson 2: Exercises of jumping

a. Prerequisite

Learners will learn better this lesson, if they are able to perform body control and balance, coordination exercises.

b. Teaching resources:

1 cross-hop-mat, or white chalk for drawing on the sol, 1 stopwatch, playground, gymnasium.

c. Introduction

Opening discussion: Refers to the unit 1, lesson 1

Warm-up activities:

- Make learners stand on two parallel lines
- Instruct them to run around the playground at least three times for warming – up their body
- Stand by the side and follow them to see the progress of every learner.
- Ask them to increase speed progressively as they are running.
- After doing a warm-up, ask them to do flexibility exercises.

d. Lesson development

Exercise 1: Cross Hopping

Summary description:

The game is played with two feet hops with change of direction.

Procedures

- From the centre of a jumping cross the participant jumps forward, backward and to the sides.
- Specifically, the starting point is from the centre of the cross forward; then backward to the centre; then to the right and back to the centre; then to the left and back to the centre; and, finally, backward and back to the centre.

Scoring

Each team member has a 15-second-time trial in which he tries to carry out as many two-footed bounces as possible. Each square (front, centre, both sides, back) is scored with one point so that in one round a maximum of eight points can be obtained. Out of two trials the best one is scored.

Assistants

One assistant per team is required for this event and this person has the following duties:

- To give the command to start.
- To control and regulate the procedure.
- To keep the time and count the number of bounces.
- To record the scores on the event card

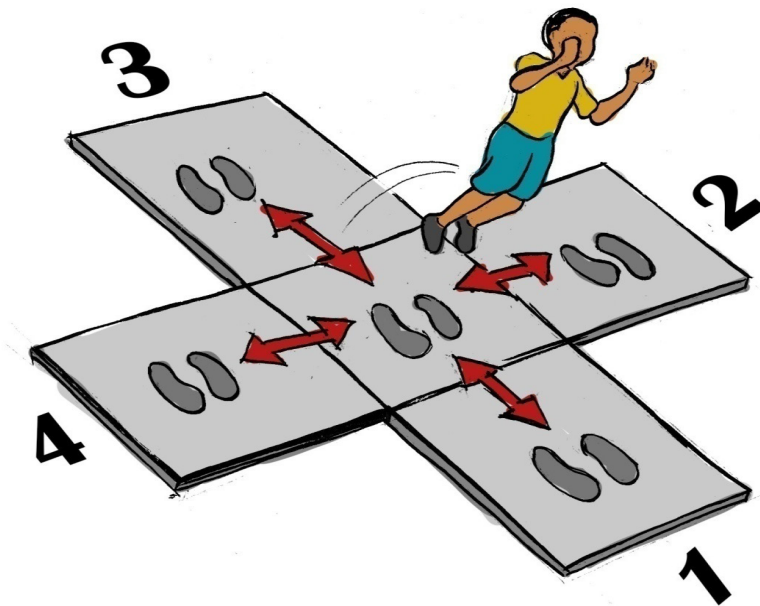

Exercises 2: Forward squat jumps

Before performing jump squats, teacher should familiarize learners with basic takeoff and landing position, correct jumping technique and the mechanics of creating and absorbing force.

PART1: Performing the Jump squat

- Take the proper stance



Lower yourself into squat:



Initiate the jump

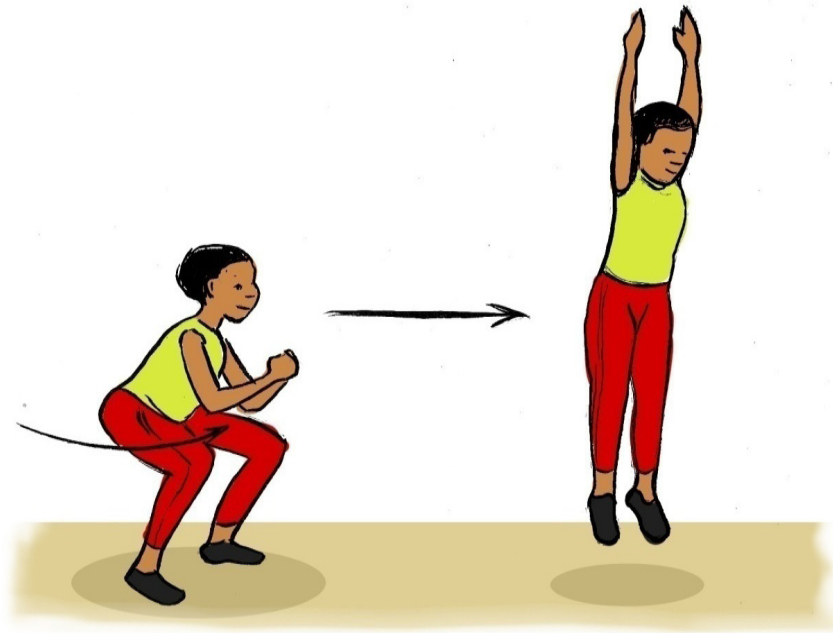

Jump as high as you can



PART 2: Landing Safely and Correctly.



Control your descent

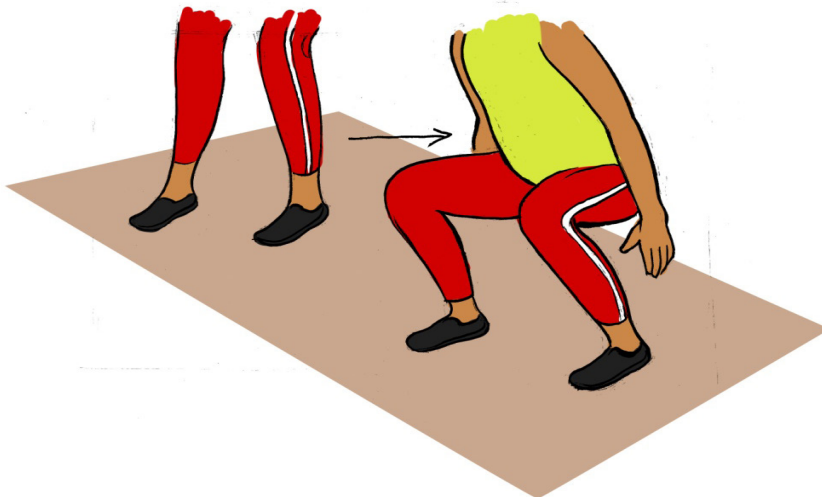

Touchdown with knees touching the chest



Bend your knees to absorb impact.

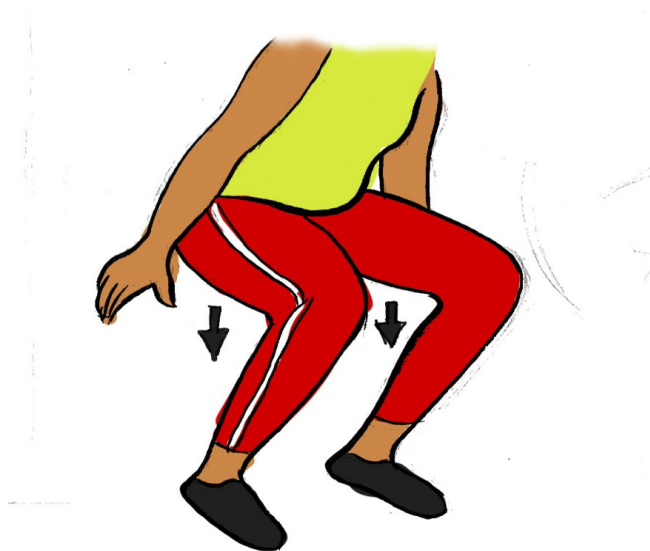

Put yourself in position for the next jump squat

Exercises 3: Jumping with knees touching the chest

- Dip down into a quarter squats and immediately explode upward;
- Drive the knees towards the chest, attempting to touch them to the palms of the hands;

- Jump as high as you can, raising your knees up, and then ensure a good land by re-extending your legs, absorbing impact through allowing the knees to rebend;

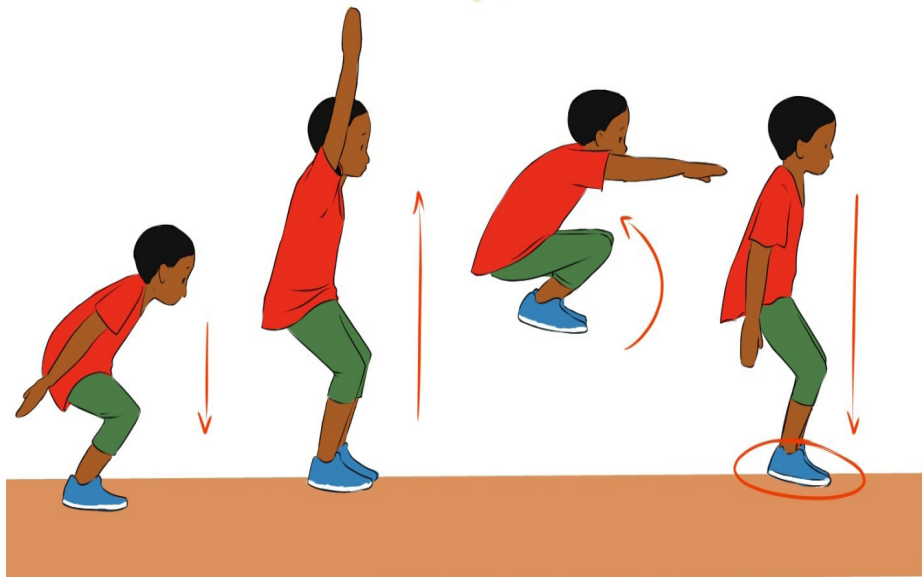

Cool-down activities/exercises

Make learners stand on semi-circle.

Instruct them to perform leg stretch exercises as they relax.

e. Assessment

Reflect:

- What was more challenging during the exercises of jumping?
- How do you feel after performing different jumping exercises?

Connect:

- How helpful is jumping in our daily life?

Apply:

- In which games/sports one can apply jumping?

Lesson 3: Exercises of throwing

a. Prerequisites

Learners will learn better this lesson, if they are able to perform different exercises with balance and coordination.

b. Teaching resources:

2 medicine balls (1 kg) or other ball of 1 kg, 1 measuring tape (20m), 1 gymnast, 1 cone per meter

c. Introduction

Opening discussion: Refers to the unit one , lesson one

Warm-up activities/exercises: Refers to the lesson 1

d. Lesson development

This lesson is to be taught using two educative games, include:

Game 1: Knee throwing.

Game 2: Teens javelin throwing.

For successful of this lesson, teacher is advised to teach all this two educative games and try to give clear instructions to the learners.

Game 1: Knee throwing

Summary description: Two-handed medicine ball throwing for distance from a kneeling position

N.B: With the help of banana leaves fibbers, teacher can improvise balls to use in this game.

Procedure

- The participant kneels on a mat (or some other type of soft surface) in front of a raised, soft object (e.g. soft tumble mat or foam mat).
- The participant then leans back (pre-tensing the body) and heaves the medicine ball (1kg) using a two handed over-head forward throw for maximum distance while kneeling.
- After having thrown the participant may fall forward onto the soft, raised cushion that is in front of him/her.

Safety note: The medicine ball should never be thrown back to the participants. It is advisable to carry it back or to roll it back to the foul line for the next throw.

Scoring: Each participant gets two trials. The measurement is recorded in 20cm intervals (taking the higher figure when the landing happens between the lines) and is taken at 90° (right angle) to the foul line. The better of the two trials of each team member is the one that is included in the team total.

Assistants: This event requires two assistants per team. They have the following duties:

- To control and regulate the procedure.
- To assess the distance where the medicine ball lands (90° measurement from the foul line)
- To carry back or roll back the medicine ball to the foul line.
- To score and record the scores on the event card.

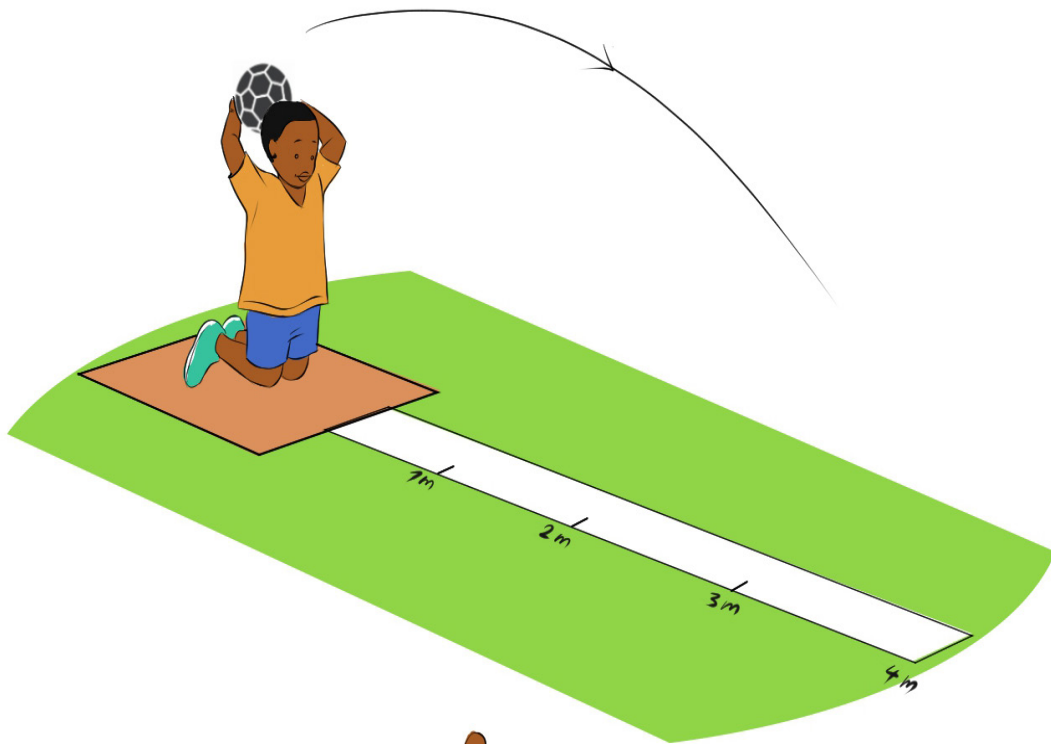

Game 2: Teens Javelin Throwing.

Summary description: One-armed throws for distance/precision with an appropriate Javelin.

Materials needed: 8 cones, 1 measuring tape (30m), 2 “advanced” javelins.

Procedure

- The throw is carried out from a 5m run-up area. The athlete throws the javelin as far as possible (= 30m) in line with markers.
- If the javelin lands beyond the 30m distance, inside a 5m wide target-area, a 10m bonus is given.
- The performance will be directly recorded from the marking out or from a measuring tape unrolled on the ground.
- Each individual result for each of the three trials is recorded.

Scoring: Each team member’s best result is recorded and added to the other results of the team. The total performance of the team is then scored.

Assistants: One assistant is required for the event and he/she is in charge of:

- Controlling the regular course of the event.
- Scoring and recording the scores on the event card.

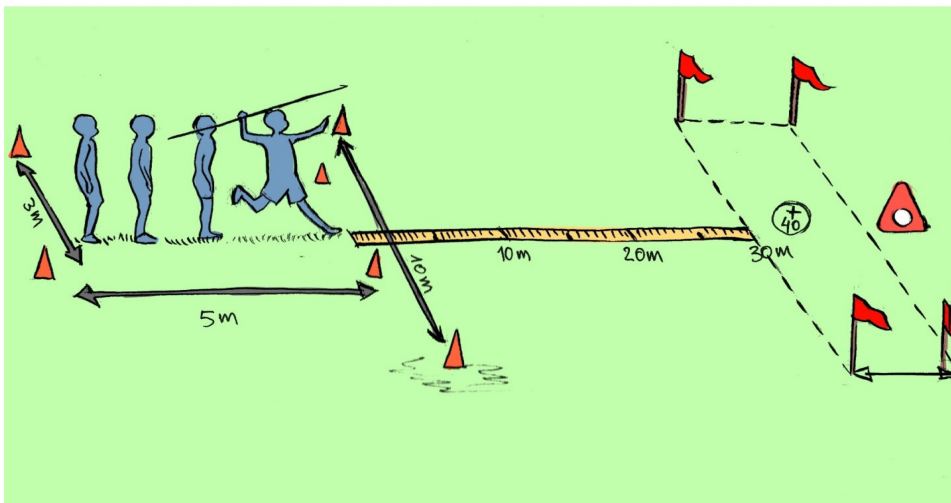

Cool-down activities/exercises : Refers to the lesson 2

e. Assessment

Reflect:

- How do you feel after performing different throwing exercises?
- What was more challenging during the exercises of throwing?

Connect: How helpful is throwing in our daily life?

Apply: In which games/sports one can apply throwing?

4.5 End unit assessment

Organise a running, jumping and throwing competition and observe how learners are performing those exercises with speed, resistance and endurance.

4.6 Additional activities

Do your own research for flexibility/stretching exercises.

Visit this website: <https://www.self.com/gallery/essential-stretches-slideshow>

UNIT 5: FOOTBALL

5

5.1. Key unit competence:

Kick, pass, control, shoot, block, and stop a football in accordance to the basic rules of football.

5.2. Prerequisite knowledge and skills

Learners will learn better this unit if they are able to perform different running, jumping and throwing exercises which are basic skills to play football.

5.3. Cross-cutting issues to be addressed:

- **Peace and values education:** In teaching-learning process the teacher must encourage tolerance, patience, cooperation, teamwork spirit, mutual help, and respect of opinions of colleagues, obeisance of rules and creation of a more peaceful game situation.
- **Gender education:** Encourage both girls and boys to participate actively
- **Inclusive education:** In teaching-learning process the teacher must identify learners with special education needs and plan adapted exercises accordingly. Involve all learners in all activities without bias.
 - Allow a learner with physical disability (using wheelchair) to be a referee, a coach, an assistant, a judge...
 - Simplify expectations for activities: Modify activities so they suit the abilities and attention span of the learners.
- **Comprehensive sexuality education:** Set instructions that prevent sexual harassment, violence and bad body touches.
- **Financial education:** Facilitate learners to make no cost materials like balls from banana leave fibers, etc.
- **Environment and sustainability:** During teaching and learning process, teacher should :
 - Explain to the learners the importance of a safe and clean environment for a physical sport activity.
 - Tell learners to collect all materials used during learning and teaching process.Avoid throwing away used materials anywhere.

5.4. List of lessons

#	Lesson title	Learning objectives (from the syllabus including knowledge, skills and attitudes):	Number of periods
1	Basic Football techniques.	Perform techniques for playing in teams. Focus on controlling, running with the ball, passing and shooting the ball.	1
2	Basic football tactics	Perform tactics for playing in team. Focus on shooting, pass attacking, defending a team, stopping the ball with foot, dodging the ball, and kicking the ball oriented to the partner.	1
3	Safe play	Put in practice basic football techniques	1
4	End unit assessment		1

Lesson1: Basic football techniques

a. Prerequisites

A learner will learn better this lesson if he/she is able to perform different motor skills, basic skills of athletics

b. Teaching resources:

Balls, cones, whistle, stopwatch, playground, etc

c. Introduction

Opening discussion: Refers to the unit 1, lesson 1

Warm-up activities/exercises

- Make learners stand on two parallel lines ;
- Instruct them to run around the playground at least three times for warming –up their body;
- Stand by the side and follow them to see the progress of every learner;
- Ask them to increase speed progressively as they are running;
- After doing a warm-up, ask them to do stretching exercises;

d. Lesson development: Basic football techniques

Basic football techniques include:

- Controlling the ball
- Running with the ball
- Passing the ball
- Shooting the ball

For each technique:

- Show learners how to execute the basic skills with explanations step by step.
- Let learners practice based on instructions and provide necessary support.
- If possible with learners, improvise balls from locally made materials.

Technique 1: Controlling the ball

Before they can pass the ball, learners must first control it. Depending on how they receive the ball, they can control with the head, chest, thigh and foot. A good first touch gives the learner time and space. But poor control allows the opponent to put pressure on and intercept the ball.

Teaching points for control:

Ask learners to,

- Keep the head relaxed and watch the ball carefully to judge its speed and height.
- Move both feet quickly so the body is in front of the ball at all times.

- Decide early which body part will control the ball. Relax that body part.
- Cushion the ball by withdrawing the body part controlling the ball.
- Keep the ball close to the body after controlling it.

a. Inside of the foot

Controlling the ball with the inside of the foot is the safest way to receive the ball. The opposite foot should be placed on the pitch, helping the learner keep his balance. The technique involves a soft reverse touch in which the foot is withdrawn or pulled back to cushion the ball as it makes contact. The amount the foot withdraws depends on how hard the ball is hit.



b. Outside of the foot

Controlling the ball with the outside of the foot is useful when the ball is rolling in front of the learner from side to side. Instead of turning his body into the path of the ball, a learner can control it using the outside of the foot. The learner should use the area around the little toe to control the ball. That technique provides a larger contact surface.



c. Sole of the foot

Controlling the ball with the sole of the foot is rarely used in the modern game because the learner has to be standing still. However, if a learner is dribbling and needs to stop or change direction, he/she will simply put his/her foot on top of the ball hard enough to stop it. Then he/she will pass, shoot or dribble.

d. Thigh

Controlling the ball with the thigh is useful when the ball comes to a learner from height. A learner must make sure he/she is in the right position. Then, when the ball touches the thigh, he/she can pull his/her foot back to the ground. If a learner does not lower his/her leg, the ball will bounce off and He/she will lose control. The learner should try to contact the ball about halfway up the thigh.



e. Chest

Controlling the ball with the chest allows a learner to receive it when it comes to him/her above the waist. The chest provides a large area to get the ball under control. A learner must arch his/her back and bend his legs to receive the ball.

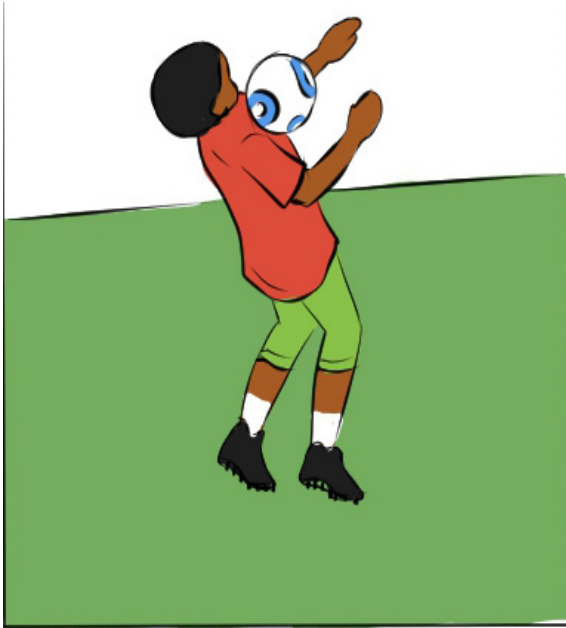

f. Head

Controlling the ball with the head is useful if a learner receives a pass above the chest and has time and space to control it. A learner allows the ball to hit his/her forehead while he/she pulls his/her head back. The ball then drops to the ground and is brought under control by his/her feet.



Technique 2: Running with the ball

1. Changing the pace with the ball

Learners, during any game, need to change pace and direction of the ball and in the initial stages the techniques of changing the pace needs more practice and repetition.

Practice 1

4 learners line up outside an area 15 m in length. The 15m area is divided into 3 sections of 5 meters as in diagram (spaced 1 meter apart), 1 cone is placed on the far line 15 m from the start. The practice is for all learners.

Key points: Teacher should insist on technical ability first, before speed is considered.

- All learners complete the same sequence, each player going through the same 4 stages. After completing each step, they always return to the start before moving on to the next step.
- The learners set off to the first cone and then turn back sharply returning to the start point(see learners 1)
- Having completed the first step, they then turn again and proceed back to the centre weaving in and out of the 5 cones(as demonstrated by learners), before returning to the start.
- They then proceed to go round the farthest cone before turning back to the original start point(learner 3)
- On the return to the start point- learners must use both feet alternately, using short sharp touches from one foot to the other(see learner 4)
- As learners improve, the teacher can introduce a competitive element racing learner against each other.

Diagram

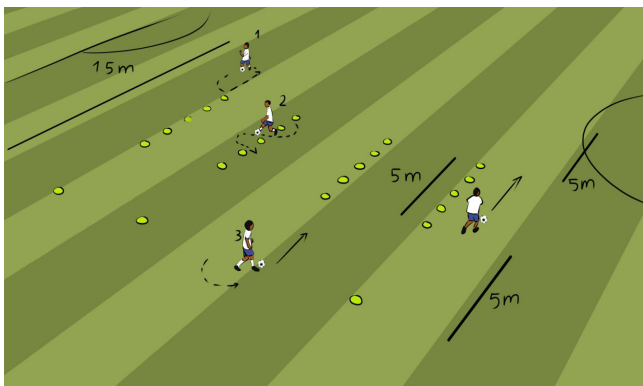

2. Running in tighter situations

To try and improve control whilst moving with the ball, 12 learners in 20 m square (each with the ball all moving around the area, varying speed and direction-making sure they do not collide with other players or other

Point to note: Learners should be encouraged to vary their pace and direction to give urgency to the practice.

3. Running with the ball at pace



Running with the ball, at a certain pace, is an important skill particularly in terms of setting up attacks at opponent's goal.

The ability to run at speed with the ball under control offers a greater challenge. Consideration to be given to how the ball is to be controlled whilst running.

- Both the inside and the outside of the foot should be used. Starting at jog, the speed can be built up as technique improves.
- Learners should run with the ball, varying their length of stride, and also their direction. Once reaching a certain point they should be ready to turn quickly making sure they retain good control of the ball.
- At all times the head needs to be steady looking down at the ball, with the occasional glance up to see exactly the position in the field.
- When running, learners should ensure the ball is not too far ahead all the time. Sometimes fairly close, others (in longer runs) it can be as far as five meters ahead when they are no opponent nearby.

Here are some practices to assist progression in running with the ball.

SET UP: 20m square, for players with one ball.

DIAGRAM 1: - The session start with player A passing the ball to player D

DIAGRAM 2: - D controls the ball then runs with it to either player C or B (in the diagram to C). Player C will then run diagonally with the ball to B.

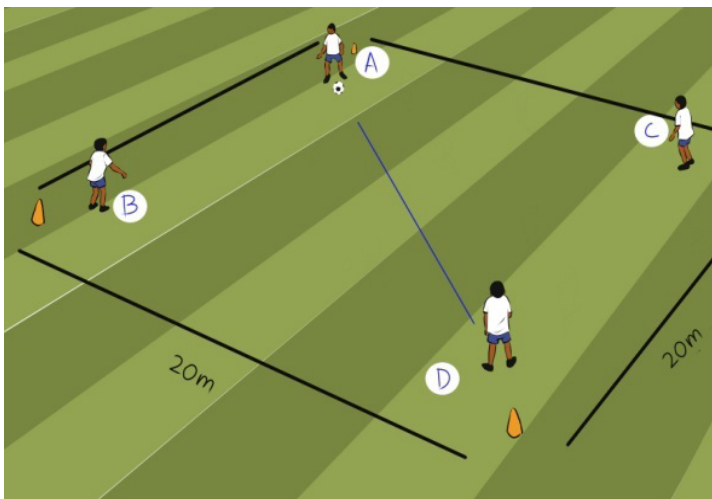
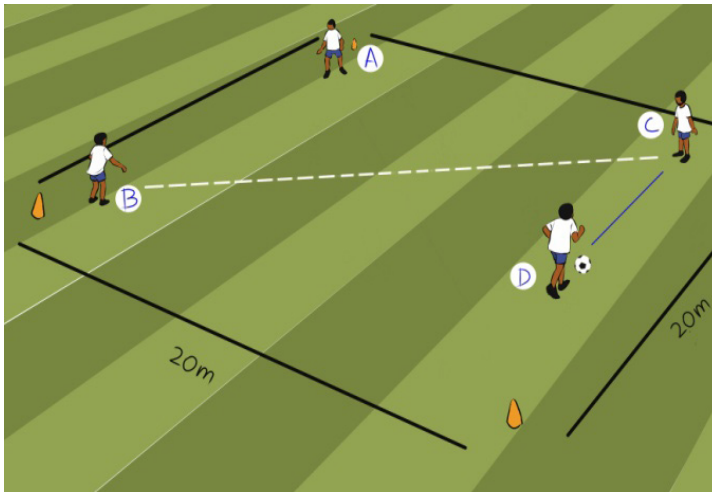

This exercise is repeated, all learners being presented with the opportunity to run with the ball.

4. Exchanging on the run

Divide learners into groups of six, each group has three learners facing each other 20m apart.

The front learner runs with the ball towards the front learner of the opposite queue.

The ball is then exchanged with the learner at the front of the opposite queue (see learner **A** and **B** above)

Learner A will then join the back of the queue, while **B** runs with the ball to the opposite side and so the session continues.

Points to note: when the learners exchange the ball, the ball should be moving continually and never stopped.

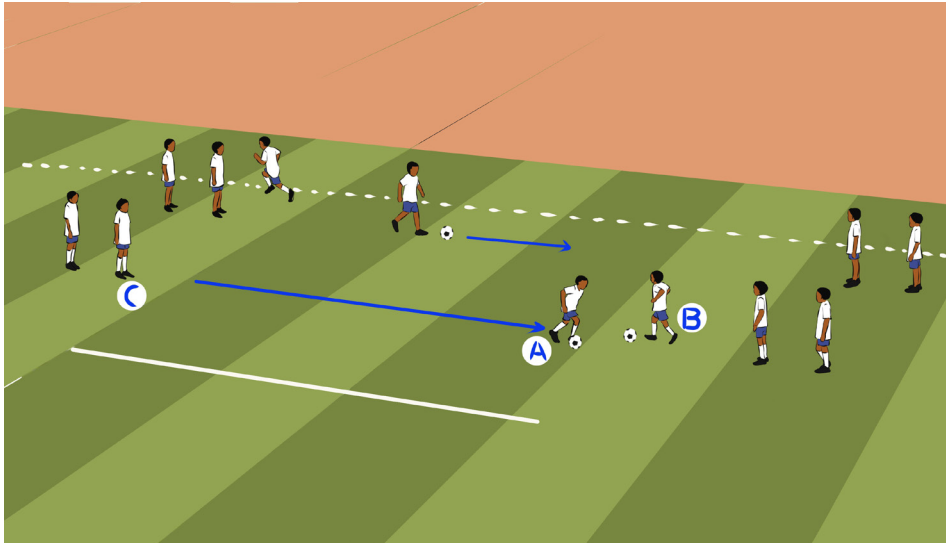

Technique 3: Shooting

A well-directed, firmly struck shot is almost impossible for a goalkeeper to save. A learner must keep his eyes on the ball and also on the field to choose the best opportunity to shoot. Technique is very important. A learner can either place or drive a shot, whether it is a volley or a ground shot.

Teaching points for shooting: Ask learners to:

- Keep the eyes on the ball.
- Look up and choose a target. Then look back to the ball before having a shot.
- Approach the ball slightly from the side.
- Place the non-striking foot directly to the side of the ball.
- Strike the centre of the ball so it doesn't rise too high.
- Keep the upper body still and strike through the ball.

Ground kicks

A learner needs good balance to strike the ball well. For maximum power, he/she must follow through with the striking foot in a sweeping motion toward the target.

The placement of the non-striking foot affects the height of the shot. If it is placed:

- Directly next to the ball, the shot will stay low
- Slightly behind the ball, the shot will rise

The shooter's upper-body position also affects the outcome of a shot. If a learner runs:

- Forward, over the ball, the shot will stay low
- Backward, the ball will rise

Volleys

Balance is vital if a learner is going to strike the ball in the air. He/she must be the right distance from the ball. Therefore, he/she has to be quick to adjust his/her upper body and feet in the direction of the goal. The shot will not be accurate if a learner is reaching for the ball. So it is important for the learner to be leaning over it before he/she swings his/her foot and follows through.



Inside of the foot

To place the ball, a learner uses the inside of his/her foot, much like when he/she is passing to a teammate. The ball does not need to be hit with much power. The accuracy of the shot will beat the goalkeeper. The non-striking foot is placed next to the ball. The striking foot is opened up just before the ball makes contact with it.

Outside of the foot

Learners use the outer area of the front part of the foot to bend the ball around an opponent or goalkeeper. The harder the ball is hit, the greater the bend and power. But it is essential that the learner follows through. If he/she does not, the ball will not bend.

Chip

A chip shot makes the ball rise into the air and then fall quickly. A learner will chip the ball when he/she wants it to fly over the oncoming goalkeeper. He/she thrusts the striking foot underneath the ball, making contact with the tips of the toes. Most of the action is from the knee downwards. The thigh does not move much.

Technique 4: Passing the ball

All good passers demonstrate these teaching points.

They:

- Place the non-striking foot next to the ball,
- Pointing at their target ,
- Lock the striking ankle but relax the body,
- Look up to find a teammate and then look back to the ball before striking it,
- Follow through with the striking foot in the direction of the target
- Move after a pass and prepare for a return pass.
- Pass the ball using inside of the foot

Good form includes these features:

- The head is slightly over the ball
- The body is balanced and straight
- The non-striking foot is placed to the side of the ball, pointing toward the target
- The player follows through with the striking foot to ensure accuracy and the desired distance



Passing the ball using outside of the foot

Learners pass with the outside of the foot when:

- They want to bend the ball around an opposing player
- They cannot make a simple pass with the inside of the foot

e. Assessment

Reflect:

- Which parts are mostly used to perform different basic techniques of football?
- Which technique is somehow easy/difficulty to perform?

Connect: How can you be more prepared to receive, control, pass and shoot the ball when it comes to you?

Apply: How will you prepare yourself to perform different basic techniques of football?

Lesson 2: Basic football tactics

a. Prerequisites

Learners will learn better this lesson if he/she able to perform basic football techniques.

b. Teaching resources: playground, balls, cones.etc

c. Introduction

Opening discussion: Refers to the unit 1, lesson 1.

Warm-up activities/exercises: Refers to the unit 5, lesson 1

d. Lesson development

To teach this lesson, teacher is advised to use small sided games.

Small Sided Games

Small sided games are games with a small number of players on each side, for example 3 vs 3 or 5 vs 5. The key point is that because there are fewer learners, each learner gets more touches of the ball, and there are many additional benefits

Teach is advised to create small sided games that are suited to the level of learners.

Example: Age 9-10: 4 vs 4, 5 vs 5 and 7 vs 7

For the learners who play small sided game for the first time, the teacher is advised to:

- Put learners in the smallest possible small-sided game: the so-called “1 versus 1” game.
- In the “1 versus 1” game, a learner plays alone on his/her side playing in defense and attack and he/she has only one opponent on the pitch.
- Focus at this stage is on dribbling techniques and protecting the ball.
- But this will quickly change and, according to the of learners age,

Playing 4 vs. 4

Ideal Attacking Shape

Provides:

1. Length (north)
2. Depth (south)
3. Width (east and west)

Possible team formations are 1-3-1 (pictured here), 2-2-1 and 2-1-2

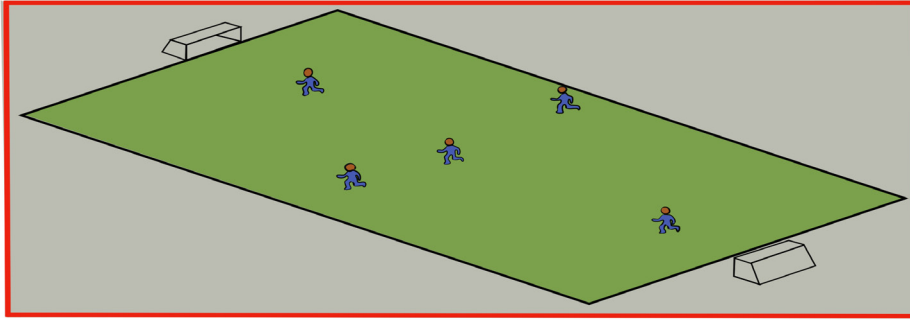

Possible team formations are 2-4-1 (pictured here), 2-3-2 and 3-2-2.

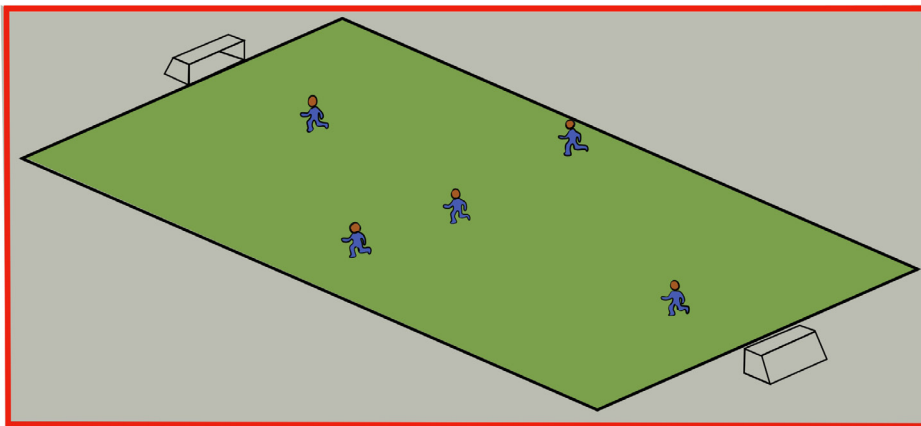

Cool-down activities/exercises

Ask learners to stop playing.

Make them stand on two parallel lines.

Let them jog and stretch their muscles.

e. Assessment

- **Reflect:** How do you feel after playing different side games?
- **Connect:** How do you organise yourself tactically when playing football at home?
- **Apply:** Which possible team formation that seems to be easier/ difficult to apply?

5.5. Additional information for teachers

1. Behavior in matches

There are two situations in a match that require different behaviors:

Team in possession of the ball

- Move forward
- Lose markers
- Support/backup
- Passes, dribbling, shots

Team not possessing the ball

- Fall back while facing the ball
- Covering (slow down the opponents' progress)
- Marking
- Interceptions
- Duels

2. General principles

- All players must help their team-mates.
- Everyone participates in attack.
- Everyone participates in defense.
- Defense starts as soon as the ball is lost.

The main individual tactics are simple principles that a player learns in order to make the best decisions during a particular passage of play.

Main individual tactics for attacking

- Play the ball immediately; don't let your team-mates lose their markers for nothing. Lose your marker immediately after passing the ball.
- Always try to be in an unmarked position.
- Pass and get into position to:
 - Help a team-mate,
 - Call for the ball,
 - Support a team-mate.
- Avoid unnecessary confrontations. It is better to eliminate an opponent quickly than take the longer option of dribbling around them.

When faced by an opponent

- Take the ball to the opposite side of your opponent;
- Get away from your opponent by using quick bursts, feints and sudden changes of direction;
- Take the ball to the left and then pass to the right and vice versa;
- Do not carry the ball too far, progress should be made by short touches with the ball close to the body;

- Use cross-pitch balls to a team-mate in a good position;
- Avoid playing down the centre in your own half, if the ball is lost it could be dangerous;
- Don't pass the ball into crowded areas, play it to a teammate who is in free space;
- Play the ball between two opponents to a team-mate who calls for it;
- Always support a team-mate who has the ball;
- Run to meet the ball, don't wait for it to come to you;
- Don't let the ball go past without controlling it, otherwise an opponent may get there first;
- Be encouraged to dribble against an opponent (depending on the situation);
- Play in a sensible, simple, useful manner. This is the most difficult thing to achieve. This is how a good player can be recognised

Main individual tactics for defending

- Always keep yourself between your opponent and your own goal.
- Always watch your opponent and the ball.
- Try to counter the opponents' attacking build-up as soon as possible by marking.
- Don't give your opponent space, slow your opponent down when he/she runs with the ball (shutting down).
- Slow an attack down (shutting down).
- Try to get to the ball before your opponent, or otherwise hinder him/her when he/she receives the ball.
- Contest all balls.
- Mark your opponent on the side of the ball, in other words the side where he/she will make the pass.
- When a high ball comes in, jump a moment earlier than your opponent.
- Do not dribble in your own penalty area.
- Avoid cross-pitch passes from the outside to the inside.
- Play on the outside along the touchline.
- Don't hit the ball randomly; build an attack from the back.
- If you lose the ball, strive to recover it.
- Avoid ineffective tackles; don't throw yourself at an opponent who has the ball.
- Wait until your opponent changes the weight on his/her feet before challenging him/her.
- Never turn your back on an attacker.
- Push your opponents towards the touchline.
- Carefully follow play, even if the ball is far away.

- A good defender never gives up.
- The goalkeeper must command his/her area.

5.6. End unit assessment

In small sided game situation, assess how learners are applying basic techniques and tactics of football

5.7. Additional activities

The game below can be used to improve passing, movement ability and communication.

Name of the game: Relay passing

What you need: 6+ players, 1 ball for each group of 6

Goal of the game: Players improve passing, movement ability and communication.

Organization and rules of the game

- Each group splits into two sets that line up facing each other at opposite ends of the play area.
- The basic exercises involves A passing to D and running to the back of the line, D passing to B and running to the back of the line.
- Practice this for a few minutes and then add the requirement that learner must shout out the name of the learner they are passing to. If they don't, ask them to go back and do it again.

Extension

- Vary the body part used to control the ball (knee, chest, head and outside of the foot). Increase the passing distance.
- Allow learners only one touch.
- The learner who receives the pass (D) lays it off for the learner who passed it (A), who runs on to it, takes the pass, and passes it to the next player in line (E). A then runs to the back of that line.

Safety

- Do not let learners to play the game for too long
- Make sure you allow plenty of water breaks

UNIT 6: VOLLEYBALL

6

6.1. Key unit competence

Improve techniques of passing, receiving, setting, and serving and use these techniques in game situations.

6.2. Prerequisite knowledge and skills

From the unit 4, a learner is able to perform exercises of throwing balls in different positions and perform throwing exercises balls with two hands while bending and legs opened. This can be (a starting point) the prerequisite skills of applying basic techniques and tactics of volleyball.

6.3. Cross-cutting issues to be addressed:

- **Peace and values education:** In teaching-learning process the teacher must encourage tolerance, patience, cooperation, teamwork spirit, mutual help, and respect of opinions of colleagues, obeisance of rules and creation of a more peaceful game situation.
- **Gender education:** Encourage both girls and boys to participate actively in the lesson.
- **Inclusive education:** Identify learners with special education needs and plan adapted exercises accordingly. Involve all learners in all activities without bias.
 - Allow a learner with physical disability (using wheelchair) to be a referee or help you to set materials.
 - Simplify expectations for activities: If possible, modify activities so they suit the abilities and attention span of the learners.
- **Comprehensive sexuality education:** Set instructions that prevent sexual harassment, violence and bad body touches.
- **Financial education:** Facilitate learners to make no cost materials like balls from banana leave fibers, etc.

6.4. List of lessons

#	Lesson title	Learning objectives (from the syllabus including knowledge, skills and attitudes):	Number of periods
1	Basic techniques of playing volleyball.	Apply techniques to improve performance in volleyball Enjoy playing volleyball using techniques and tactics.	2
3	Develop body coordination and Evaluate the performance level in game situation.	Create individual techniques and tactics in game situations. Evaluate his/her performance in volleyball. Use creativity during the game situation. Enjoy playing volleyball using techniques and tactics.	1
4	End unit assessment	In game situation learners perform pass, serve and setting the ball using technical skills and evaluate one's and others performance and follow volleyball basic rules.	1

Lesson 1: Basic technical tactics of playing volleyball

a. Prerequisites

Learners will learn better this lesson if they are able to perform throwing, coordination and balance exercises.

b. Teaching resources:

Volleyball balls, net, whistle, playground, watch, etc.

c. Introduction

Opening discussion: Refers to the unit one lesson one but remember to ask learners different questions related with this lesson.

Warm-up activities

- For each warm-up session, plan a sequence of activities for few minutes of continuous movement.
- The learners should work up a light sweat before proceeding to the other activities.
- Combine some or all of the activities below.
- The learners can circle the court or shuttle from end to end.
- The teacher can call out changes in activity speed, movement type, and direction and so on.
- Or, chosen learner can lead, making changes as they go.

1. Walk, jog and run



Running around the court

Methods

Vary the pace and/or direction.

For example:

Go forward, backward or sideward.
Zigzag or weave.

Variations

Use the footwork and arm movements for passing, setting, digging, chasing a loose ball, and so on.

2. Skip



Methods

Vary the pace and/or direction for example
Go forward, backward or sideward.
Zigzag or weave

Variations

Take short, medium or long steps.
Take low, medium or high steps.
Cross the lead knee in front of the Body.
Reach alternate arms high above the head.
Swing the arms ahead and back or diagonally across the body.

3. High knees

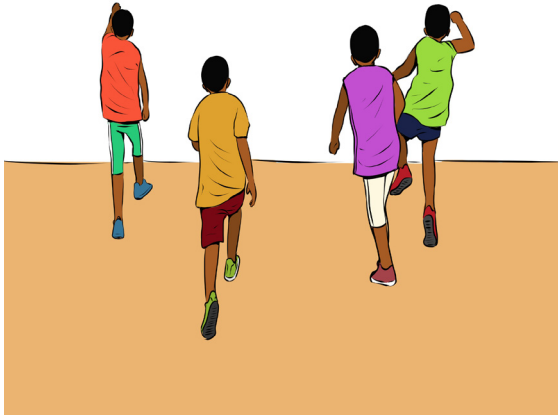

Methods

March, jog or run. Plant a foot. Raise the other knee high toward the chest. Pump the arms in rhythm.

Focus on quick feet and high knee lift rather than fast, forward movement.

Variations

Go forward, backward and sideward.

4. River cross (bounding)



Methods

Spring diagonally off one foot and land on the other (like jumping from one stone to another to cross a river).

Advance in a zigzag pattern.

Use the arms freely for momentum and balance.

Variations

Spring and land on the same foot.

Spring and land on both feet.

Bound continuously or pause and hold each landing.

Stretching activities

Learners should do the following for each stretch:

- Isolate the muscles being stretched.
- Inhale in the start position. Exhale in the stretch position.
- Stretch slowly and gently. Stay within the comfort zone.
- Stretch until they sense a slight tension in the target muscles.
- Hold the stretch position for ten seconds.
- Return to the start position.
- Deepen the stretch slightly over a series of repetitions.

Teaching tips of stretching

Discourage any notion of competition when stretching is involved. Learners differ in strength and flexibility. The body positions that one learner easily achieves may be impossible or dangerous for another. However, even though their positions and movements may be different, each learner can be achieving an excellent stretch. Emphasize the importance of:

- Being attuned to one's own body
- Staying within one's comfort level
- Following correct form in each activity. Flexibility will increase gradually.

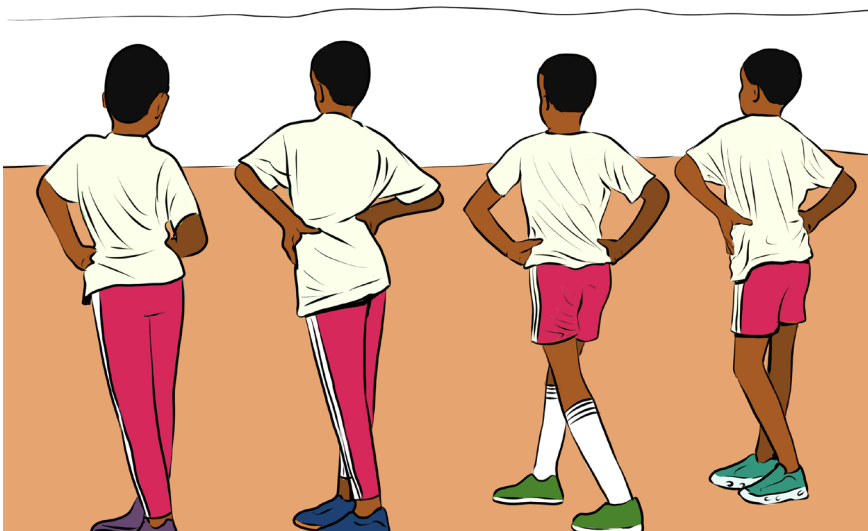

Stretching the trunk



Stretching the hamstring

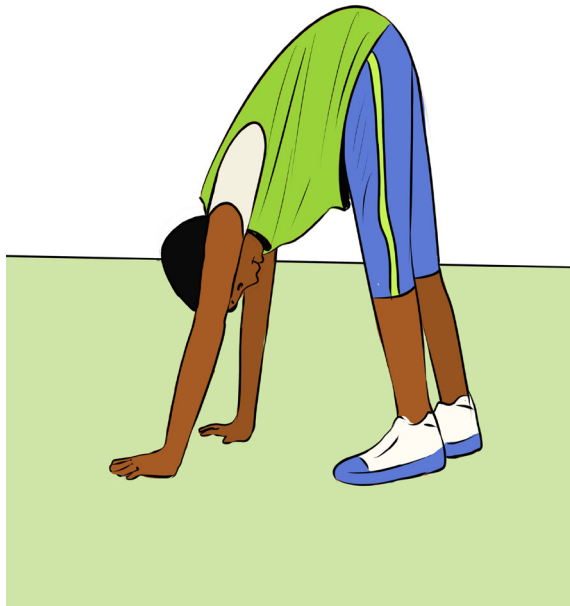

calves

d. Lesson development

Volleyball is a fun sport for all ages. The sooner learners start playing, the more skilled they will become -- it takes years to master some volleyball skills. Learners are able to learn most volleyball basics, such as ready position, passing, serving, and setting. Other skills, such as spiking and defense might be too complicated for young learners. The key to working with learners is to keep it fun and give lots of encouragement. You can even have parents join in the lesson so that everyone has fun. Teacher is suggested to put emphasize on the following four techniques:

For each technique:

- Show learners how to execute the basic skills with explanations step by step.
- Let learners practice based on instructions and provide necessary support.
- If possible with learners, improvise fiber balls from locally made materials to use.

Technique 1: The ready position

The ready position is the basic movement skill that learners should start with.

In volleyball, the **ready position** means assuming a comfortable position where the body is ready to move in any direction to get into position to play the ball. Body position in volleyball can be at one of three different levels: high, medium and low. These levels

relate to the different basic skills of the game.

- a. **Low posture - used for digging attacks or rolling and sprawling to recover balls just about to touch the ground**
 - Feet facing the target and weight equally distributed on the balls of the feet
 - Knees bent more than 90 degrees
 - Arms slightly bent, above the knees and in front of body and hands apart
 - Head up and eyes on the ball/other team
 - Weight forward
- b. **Medium posture - used for the forearm pass, overhead pass and the starting position for a spike**
 - Body leaning forward
 - Knees slightly bent
 - Shoulders in front of knees
 - Feet shoulder-width apart facing the target with weight equally distributed on the balls of the feet
 - Arms slightly bent and above the knees
 - Head up and eyes on the ball/other team
- c. **High posture - used for serving, setting and blocking**
 - Feet shoulder-width apart
 - Side by side for blocking
 - Stride position for other skills
 - Weight evenly distributed
 - Knees slightly bent
 - Eyes on the ball
 - Arms up with hands shoulder height

Techniques 2: Passing

- a. **Teach proper hand placement:**
 - Have them place one hand flat,
 - Tell learners to place their hand underneath that hand, and curl in their thumbs to the middle of their hand. Their forearms should form a flat surface, which is where the ball will be hit.
 - Alternatively, they can make a fist with their left hand and then cover the fist with their right hand so that their thumbs line up on top.
 - Learners should never interlock their arms because it is dangerous and they could end up with a broken finger.

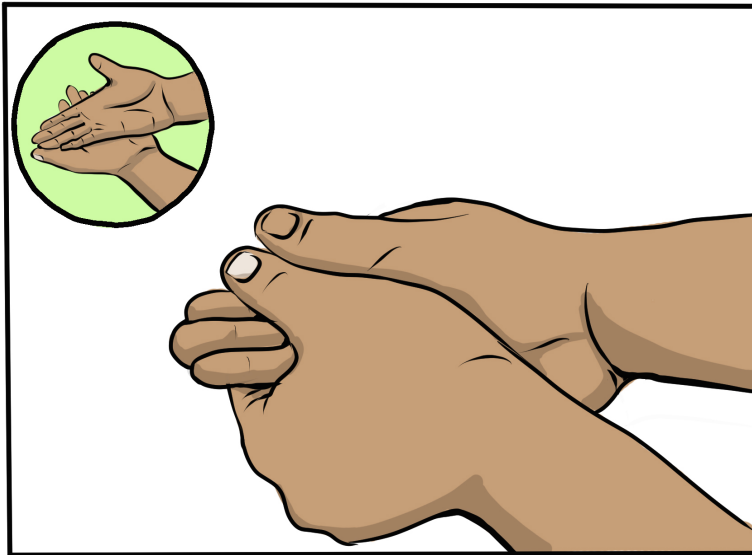

b. Show the learners a proper stance

- Get learners stand with their feet slightly more than shoulder-width apart and their knees bent.
- Have them practice squatting as if they were sitting in a chair.
- Learners should be light on their feet so that they can move and get to any ball.
- Help them to develop this agility; you can have them shuffle laterally from one side of the court to the other.

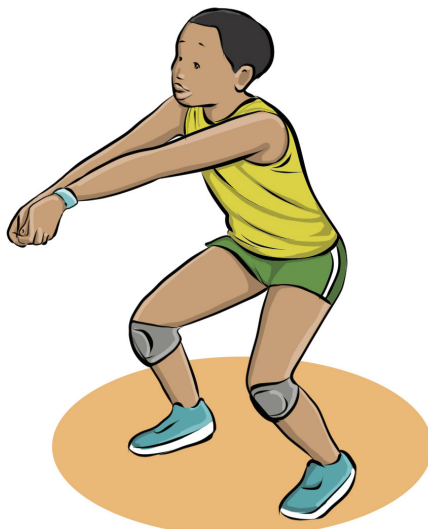

c. Have the learners practice passing

- Get learners stand in pairs and practice throwing the ball to one another.
- Throw the ball underhand to the other learner's arms.

- Hit the ball with their forearms back to the other learner. This is known as bumping the ball
- Have learners do this until they get used to the feel of hitting the ball on the proper surface.
- One learner can hit the ball 10 times and then the other can hit the ball 10 times.



d. Play passing games

- Help learners to start moving around and making fun games out of it. For example, the ball can be thrown towards alternating sides of the learner instead of directly at their arms.
- Give them a point each time the learner who threw the ball is able to catch the ball that was hit back towards them.
- Team with the most points at the end of a minute wins.

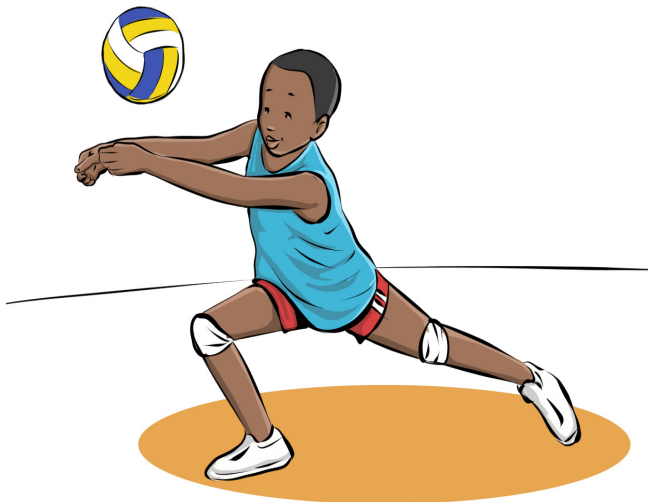

Techniques 3: Serving

a. Show them how to toss the ball

- Instruct learners to toss the ball with their non-hitting hand, learners should toss the ball in the air slightly in front of them.
- Their tossing hand shouldn't move too much and the ball shouldn't go too high.
- If the ball is thrown very high, then it will be moving faster and more difficult to hit. Aim for about 2ft (0.6m) above the head and about 2ft (0.6m) in front of them.

N.B: Remind learners that the key to a good serve is to keep it simple. It should all be one smooth, fluid movement.

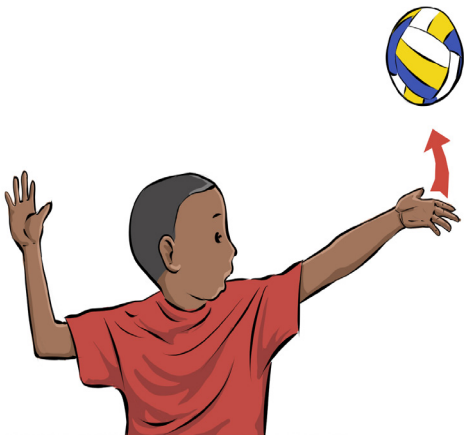

b. Teach them to step towards the ball

- Ask learners to take a large step forward in the direction that they wish to hit the ball. This will help them to generate enough power to hit the ball over the net. They should step forward with the foot on the same side as their hitting hand.



c. Have learners to make contact with the ball

- The hitting arm should be extended above their head and they should hit the ball with the heel of their hand. This will help the ball to go the furthest without spinning. The arm should follow through after hitting the ball until the hand is down by their thigh.
- The hand should be completely open when hitting the ball.
- The ball should be hit as it is descending from its toss. The learner should reach up towards the ball to make sure their arm is fully extended.



d. Let learners practice serving.

- Learners can stand several feet away from a wall and practice serving the ball against the wall. They can form pairs with one learner on each side of the net and practice hitting it over.
- The toss, step, and hit should all happen in one fluid motion.
- Some learners won't be able to serve across the full court. You can have them stand closer to the net so that they can practice hitting the ball over.

N.B: The key to getting a good serve is lots and lots of practice.

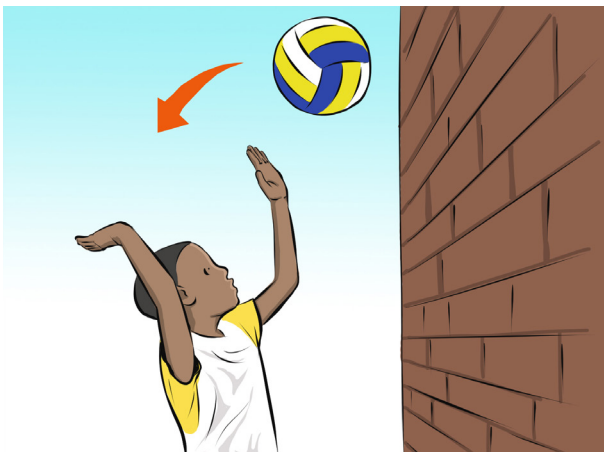

e. Teach an underhand serve if they aren't able to do an overhand serve

- To serve the ball underhand, they can drop the ball and step forward, but they will move their hitting hand down by their side and then swing it forward instead raising it up in the air. They will hit the ball over the net with their fist. This method is the easiest for making contact with the ball.
- An underhand serve is easier for younger learners, but they should still be practicing the overhand serve so that they can learn it and be able to do it eventually.



Technique 4: Setting

a. Teach proper hand placement.

- Start with both hands hovering right over their forehead when setting the ball.
- The thumbs and pointer fingers should form a triangle and the palms should face outward.
- The elbows should be out to the side in a wide position, which will provide leverage to push the ball. They will then push their hands upward to set the ball.
- The key is for the hands to make contact with the ball when it is right at their foreheads and for all 10 fingers to touch the ball.

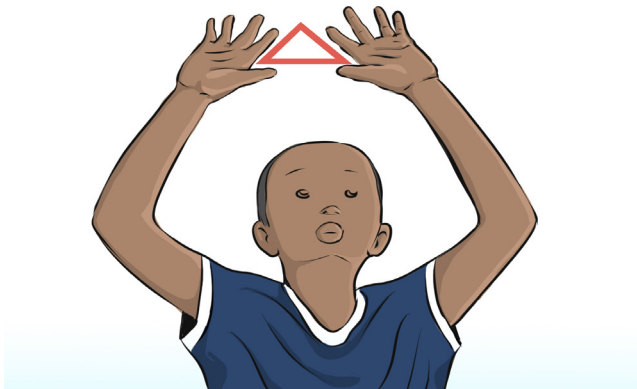

b. Have them practice catching the ball

- Advise learners to toss the ball up themselves and catch it right above their forehead with their hands in the setting position.
- Wrap around the ball with fingers.

N.B:

- This will help them get used to the setting position.
- This drill can be done seated so that learners don't worry about foot placement.



c. Have them practice pushing the ball upwards

- Divide the learner into pairs.
- One learner can toss the ball to themselves and then instead of catching it, they will set it to the other learner.
- They should push the ball upwards, straightening their arms into parallel lines in one smooth, direct motion. The other learner should be about 5 feet (or 1.5m) away and they will catch the ball.
- The learner setting the ball can remain seated and the other learner can stand and catch the ball and return it to their partner.
- After 10 times, they can switch turns.
- To make this drill more difficult, increase the distance between learners by having them take a large step backwards.
- To set the ball further, they will need to push their arms more diagonally rather than straight up. You can increase the distance so that learners are up to 10ft (about 3m) apart total.



Cool down activities:

For cool down activities refer to the unit 5 lesson two.

Assessment

Reflect: Which techniques that seems to be easier/ difficult to perform than others?

Connect:

- How previous basic techniques learnt in previous lesson are connected /helpful to this lesson?
- How can you control the height of the pass?
- What is similar/ different from being in the ready position at the net, at the attack line, in the back court, on the end line?
- What do you have to remember when you are getting into the ready position?

Apply: How can you apply these basic techniques in game situation?

Lesson 2: Develop body coordination and evaluate his/her performance level in game situation

a. Prerequisites

Learners will learn better this lesson if they are able to perform basic techniques of volleyball.

b. Teaching resources:

Net, playground, whistle, volleyball balls, watch.

c. Introduction

Warm-up activities: For the warm-up and stretching activities refers to the lesson one

Cool-down activities: Refer to the unit 5 lesson two.

d. Lesson development

This lesson aims at

- Developing body coordination of learners ,
- Evaluate one's own and other's performance ,
- Apply basic technical tactical skills in game situation

To achieve these, use the game and Mini game below:

Name of the game: Round and Round

Learners improve their ability to move around the court and get into the ready position. Learners will move to different areas on the court and, on the teacher's signal, will get into a ready position.

To set up the activity:

Set up the net.

Divide learners into groups of 10 -15 learners.

Learners line up at the side of the court close to the net.

Explain and demonstrate:

- This drill only uses half of the court (a second group could do the same drill on the other side of the court).
- All learners move around the playing area keeping their shoulders and feet facing the middle of the court.
- Learners move:
 - Across the front of the net using a slide step.
 - Backwards to the attack line.
 - Across the attack line to the other side of the court using a slide step.

- Back to the middle of the back court.
- Across the middle of the back court to the other side of the court using a slide step.
- Back to the end line.
- Across the end line to the other side of the court using a side step.
- Forward up to the net along the right sideline to start again.
- On the Teacher's signal all learners stop and get into the ready position.

Variations

Simplifications

- Learners move from the net to the end line in a square (they do not move across the attack line or the middle of the back court).
- Learners stop frequently and check their ready position.

Extensions

- After the Teacher signals stop, the Teacher tosses a ball over the net to see if learners are in good position.
- Appoint one learner to be the leader. Learners play "follow the leader" with the leader moving around the court changing directions frequently and making sure his/her feet and shoulders are facing the net.

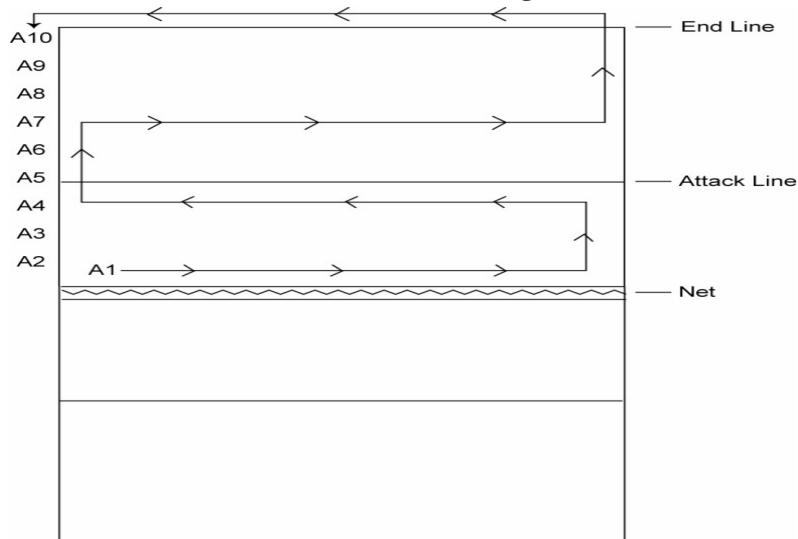

Mini game

To set up the activity:

- Set up several modified courts (8 meters wide by 8 meters long)
- Set up a net on each court.
- Divide learners into teams of 4. Pair each team up with another team (Team A and Team B).
- Send each pair of teams to one of the modified courts.
- Team A starts on Side A and Team B starts on Side B.
- Toss a coin or play Rock Paper Scissors to decide which team gets first serve.

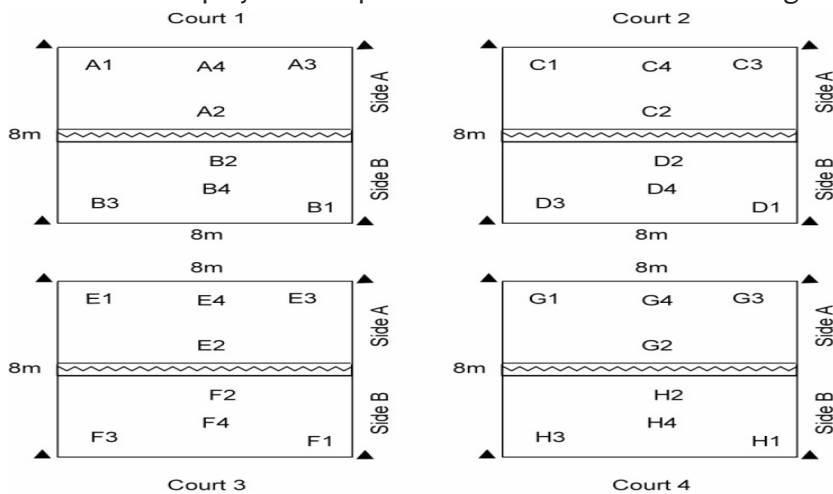

Explain and demonstrate:

- The first learner on the team that won the coin toss/Rock Paper Scissors game serves the ball over the net from behind the service line.
- Learners from the receiving team try to use three hits (forearm pass, Overhead pass, attack) and send the ball back over to Team A's court.
- The sequence of three hits on the side that receives the ball continues until the ball hits the ground or the ball is hit out of bounds.
- Teams score a point for every time they successfully get the ball over the net after three hits. Before the drill begins,
- Ask each team to set a goal for how many points they want to accumulate in a certain time period.
- Play games for 4-6 minutes and then switch up the teams. A sample rotation schedule is included below:

Games	Court 1	Court 2	Court 3	Court 4
Game 1	Team A vs Team B	Team C vs Team D	Team E vs Team F	Team G vs Team H
Game 2	Team A Vs Team C	Team B Vs Team D	Team E Vs Team G	Team F Vs Team H
Game 3	Team A Vs Team D	Team B Vs Team C	Team D Vs Team E	Team F Vs Team G

Variations

Simplifications

- Learners are not allowed to spike the ball during the activity.
- Learners start the activity by tossing the ball over the net (instead of serving it).

Extension

- Teams can only use overhead passes.

e. Assessment

Reflect:

- Which techniques have you used to receive a served ball from opponent team?
- What techniques did you use when you were sending the ball over the net? Did it work with all teams? Why or why not?
- As you played, what became more and more challenging?

Connect:

- What can you do to improve your ability to performing a pass, set or service?
- What do you consider when evaluating how your teammate is performing a pass, set or service?

Apply:

- Next time what will you do to improve the level of performing different basics techniques?

6.5. Additional information

a. Playing Surface

The playing surface must be flat, horizontal and uniform. It must not present any danger of injury to the learners. The game should not be played on rough or slippery surfaces. Games are played on a specific type of court. A volleyball court includes:

- 18-metre long sidelines and 9-metre long end lines.
- A centre line directly under the net dividing the court into two.
- A service zone that extends behind each end line all the way to the free zone. The free zone is an area around the court that must be free from any obstructions.
- An attack line designated by a line 3 meters back from the centre line. The area in front of this line is called the front court, while the area between this line and the end line is designated as the back court.

For indoor courts, the free playing space is the space above the playing area which is free from any obstructions. The free playing space should measure a minimum of 7 meters in height from the playing surface.

- All lines on the court are 5 cm wide.
- A net that divides the court into two equal courts of 9 meters by 9 meters. Net heights will vary based on age, gender and level of competition. The net height for men, co-ed and outdoor is 2.43 meters, the height for women is 2.24 meters, and **the recommended height for 11- 12-year-old males and females is 2.13 meters.**

Net heights for recreational purposes can be adjusted to maximize the success of all participants and should be determined by the age, strength and skill of the learners participating.

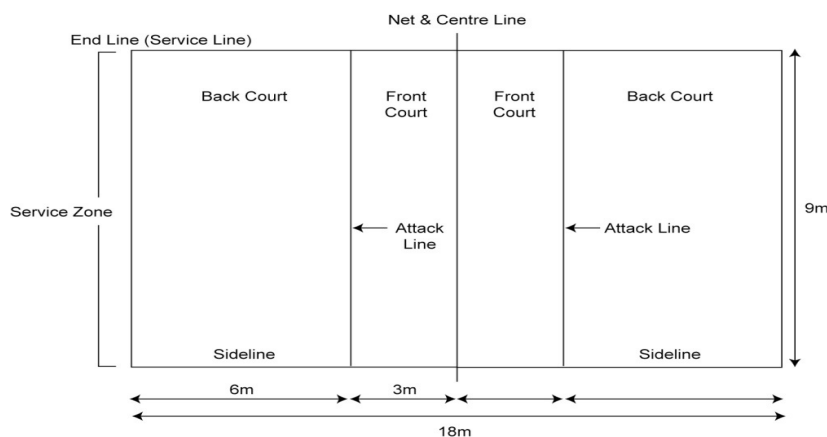

b. Basic Uniforms and Equipments

1. Uniforms

Recreational volleyball is usually played in a pair of shorts, along with a T shirt or long-sleeved shirt, a pair of sport shoes, and sometimes knee pads. Competitive volleyball learners usually wear a uniform that consists of a matching jersey, shorts and socks. The color and the design for the jerseys, shorts and socks must be uniform

For the team (except for the libero).The libero's jersey must contrast in colour with that of the other members of the team.

2. Equipments

There are very few items needed to play a game of volleyball. The equipment needed for both recreational and competitive volleyball is very similar.

Ball: The volleyball is made of flexible leather, synthetic leather, or rubber.

It weighs between 9 and 10 ounces (255-284 grams) and has a circumference of 65-67 cm. For recreational play, lighter/softer balls can be used or balls that are a little bigger to ensure all learners are successful.

Net: The net is 1 meter wide and 9.50 to 10 meters long and is made of 10-cm square black mesh. The net has horizontal bands at its top and bottom. Each extreme end of the band has a hole, through which passes a cord, fastening the band to the net posts for keeping its top and bottom taut.

Posts: The posts supporting the net are placed at a distance of 0.50-1.00 metres outside the sidelines. They are 2.55 meters high and preferably adjustable. The posts are rounded and smooth, fixed to the ground without wires.

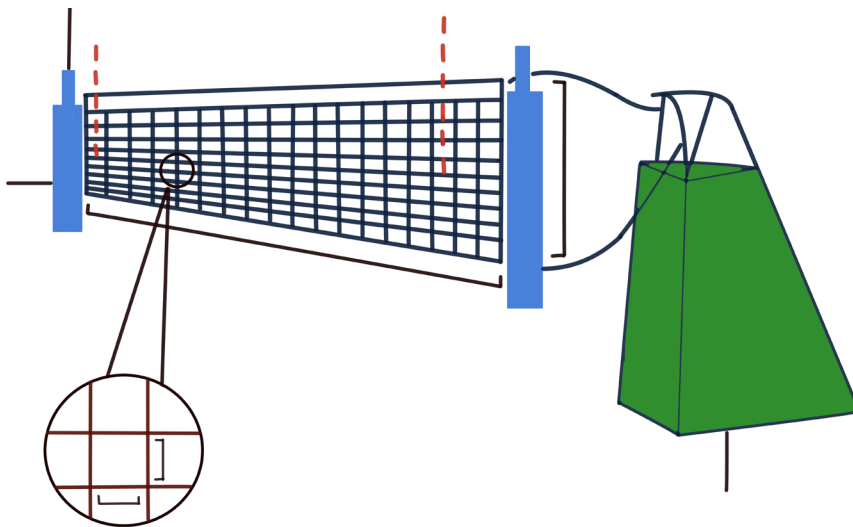

6.6. End unit assessment

In game situation learners will execute Pass, serve and setting the ball using basic technical skills and rules and evaluate his/her own and others' performance

6.7. Additional activities

a. The Forearm Pass (Underhand Pass or Dig)

The forearm pass is considered one of the most important skills in volleyball. This is because it is frequently the first contact with the ball when receiving an opponent's serve or attack. It is used to play balls that are shoulder-height or lower, and balls that come off of the net.

Teaching points for the forearm pass.

Preparing

- Feet shoulder-width apart with one foot in front of the other
- Knees bent
- One hand is placed in the palm of the other hand with thumbs together
- Forearms make a flat surface with elbows straight
- Back straight

Action

- Feet move behind the ball to receive the ball in front of the body
- Knees, waist and arms extend to the ball
- Forearms contact the ball between the wrists and elbows
- Eyes watch the ball into the arms
- Forearms extend up and forward until parallel to the floor – DO NOT swing arms.

Follow-through

- Feet move back to the floor after contacting the ball
- Body moves back into the ready position
- Eyes watch the ball to the target

b. The Overhead Pass (Set pass or Volley)

The overhead pass is often used to pass a ball that is higher than shoulder level. It is used by setters to pass (set) the ball to an attacking learner to complete an attack hit or spike. The set can be used to receive balls that have been sent over the net in a manner other than a serve or spike. It is a very accurate pass and one of the most efficient ways of handling free balls.

Teaching points for the set pass

Preparing

- Feet shoulder-width apart in a stride position
- Knees bent

- Elbows high and out
- Hands make a diamond shape using the thumb and index fingers

Action

- Feet move behind the ball to receive the ball in front of the body
- Knees, body and arms extend to the ball
- Elbows and wrists extend to the ball
- Fingers and hands push the ball, the ball may not come to rest in the hands
- Elbows and hands extend up and forward after contact
- Eyes watch the ball into the hands

Follow-through

- Feet move back to the floor after contacting the ball
- Body moves back into the ready position
- Eyes watch the ball to the target

c. The Underhand Serve

The Underhand serve is the easiest to perform and does not require as much strength and coordination. It is the best serving skill to start with when teaching young and beginning learners.

Teaching points for the underhand serve

Preparing

- Feet shoulder-width apart in a stride position
- Feet, shoulders and eyes face the target
- Non-serving hand holds the ball at waist-level
- Serving hand is open with wrist bent
- Body is bent forward slightly

Action

- Step with the opposite foot
- Serving arm extends back behind your body and swings forward
- Weight is shifted from back foot to front foot as the arm swings forward
- Non-serving hand releases the ball just before the ball is hit
- Heel of open hand strikes the ball at waist-level and on the back side of the ball just below the centre. Eyes on ball

Follow-through

- Non-serving hand drops
- Serving hand follows-through towards the target

- Weight is shifted forward
- Body moves back into the ready position and moves into rotational position on the court

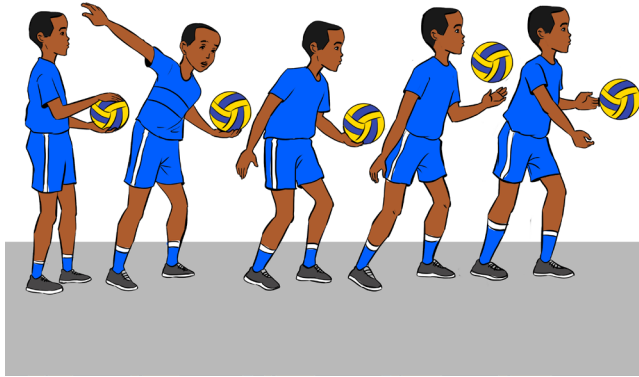

d. The Overhand Serve

The overhand serve is a more difficult skill to learn because the ball is hit with greater force from a higher point. This makes it a more difficult serve to return. The overhand serve has a number of variations with varying levels of difficulty. These are:

- The floater serve,
- The topspin serve,
- The jump serve.

The focus here is on the overhand floater serve commonly referred to as the tennis serve.

Teaching points for the overhand serve

Preparing

- Feet shoulder-width apart in a stride position
- Feet, shoulders and eyes face the target
- Non-serving hand holds the ball at shoulder-level
- Serving hand is open

Action

- Step with the opposite foot and bring your striking hand back
- Toss the ball approximately 1 meter above the head in front of the serving shoulder
- Serving arm extends back at ear-level and swings forward
- Weight is shifted from back foot to front foot as the arm swings forward serving hand strikes the ball with heel and palm of open hand

- Eyes on ball
- Ball is contacted above the head when the serving arm is fully extended

Follow-through

- Serving hand follows-through towards the target
- Weight is shifted forward
- Body moves back into the ready position and moves into rotational position on the court.



UNIT 7: BASKETBALL

7

7.1. Key unit competence

Receive, hold, and pass, Shot and dribble the ball using technical skills and following basic rules.

7.2. Prerequisite knowledge and skills

From the previous units, learners are able to receive, hold and throw the ball in different directions with one hand or two hands.

This can be (a starting point) the prerequisite skills of applying basic techniques and tactics of playing basketball.

7.3. Cross-cutting issues to be addressed

- **Peace and values education:** In teaching-learning process the teacher must encourage cooperation, teamwork spirit, mutual help, and obeisance of rules and creation of a more peaceful game situation.

The teacher prevents any kind of conflict and violence which are the source of misunderstanding between learners.

- **Gender education:** The teacher encourages both girls and boys to perform different basic techniques of basketball.

- **Inclusive education:** In teaching-learning process the teacher must identify learners with special education needs and plan adapted exercises accordingly. Involve all learners in all activities without bias.

Allow a learner with physical disability (using wheelchair) to be a referee, a coach, an assistant, a judge...and perform some basic techniques with normal learners, like passing and catching the ball



Simplify expectations for activities: Modify activities so they suit the abilities and attention span of the learners.

- **Comprehensive sexuality education:** The teacher sets instructions that prevent sexual harassment, violence and bad body touches.
- **Financial education:** The teacher facilitates learners to make no cost materials like balls from banana leave fibers. These can be used to perform different basic techniques of basketball, such as catching and passing the ball.
- **Environment and sustainability:** During teaching and learning process, teacher should :
 - » Explain to the learners the importance of a safe and clean environment for a physical sport activity.
 - » Tell learners to collect all materials used during learning and teaching process.
 - » Avoid throwing away used materials anywhere.

7.4. List of lessons

#	Lesson title	Learning objectives (from the syllabus including knowledge, skills and attitudes):	Number of periods
1	Basic techniques of basketball.	Perform different basic techniques in basketball.	1
2	Technical development activities of basketball	Practice different developmental activities using basic techniques of basketball with confidence.	1
3	Develop body coordination and evaluate the performance level in modified game of basketball and following basic rules.	Enjoy playing modified game of basketball using basic technical tactics of basketball. Create individual technical tactics in game situations with confidence, team work and fair play Evaluate one's own and others' performance in basketball.	1
4	End unit assessment	With the help of modified games and different technical tactical developmental activities, learners are able to receive, hold, and pass, Shot and dribble the ball and evaluate one's own and others' performance and following basic rules of basketball.	1

Lesson 1: Basic techniques of basketball

a. Prerequisites

Learners will learn better this lesson if they are able to perform a range of actions and movements with consistency and self confidence.

b. Teaching resources

Basketball balls, whistle, playground, cones, stopwatch

c. Introduction

- **Open discussion:** Refers to the unit one, lesson one and ask learners different questions related with this lesson.
- **Warm –up activities:** For the warm-up and stretching activities refers to the Unit 6 lesson one.

d. Lesson development

Basic techniques of basketball include:

- Pass and catch the ball
- Dribbling the ball
- Shooting the ball
- Lay – up

N.B: For each technique teacher should:

- Show learners how to execute the basic skills with explanations step by step.
- Let learners practice based on instructions and provide necessary support.
- If possible with learners, improvise balls from locally made materials.

Technique 1: Pass and catch

1. Pass the ball:

The six main pass techniques are over head pass, two-handed chest pass, one handed bounce pass, one handed chest pass, one handed bounce pass and baseball pass.

a. Over head pass

The overhead pass is a two-handed pass thrown from above the passer's head, similar to a soccer throw-in. The overhead release allows passers to throw swift, long passes on a flat trajectory. Learners often use the overhead technique to throw skip passes to teammates across court.

To make good overhead passes, teacher should instruct learners to:

- Bring the ball slightly behind the head with the elbows pointing out and forward;
- Grip the sides of the ball with the thumbs pointing toward the floor;
- Step toward the target and release with a snap of the wrists ;

- Follow-through with the arms extended, elbows locked, palms down and fingers pointing toward the target.

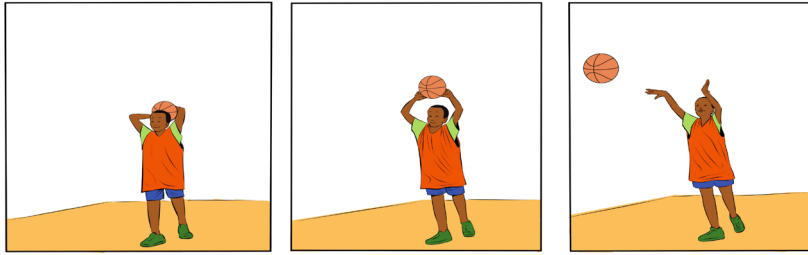

b. Two-handed chest pass

The two-handed chest pass allows for a quick release, flat trajectory and good pace. It is the most common pass.

To make good Two-handed chest passes, teacher should instruct learners to:

- Hold the ball at chest height, elbows close to the body and angled a little outward;
- Spread the fingers on the sides of the ball and place the thumbs behind it;
- Step toward the target, thrust the arms and release with a snap of the wrists;
- Follow-through with the arms extended and hands pointed toward the target, thumb down and palms outward.

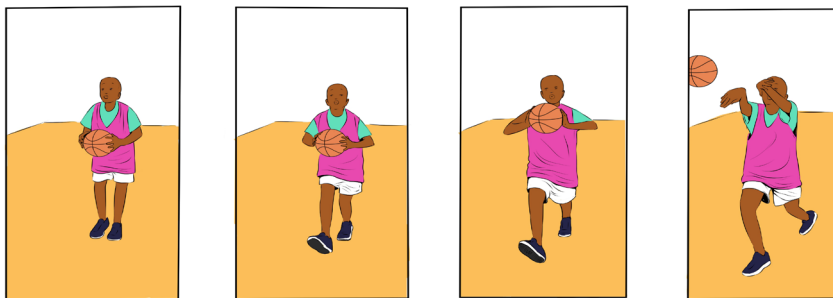

c. Two-handed bounce pass

This pass is the same as the two-handed chest pass, but the ball hits the floor on its way to the target. Learners use the bounce pass to direct the ball under a defender's reach, or to take speed off the ball and make it easier for a teammate to handle.

To make good Two-handed bounce pass, teacher should instruct learners to:

- Use the same technique as for a two-handed chest pass but thrust the arms down and out rather than straight out
- Bounce the ball with moderate backspin about two thirds ($\frac{2}{3}$) of the distance to the target
- Deliver the ball at the teammate's waist.

d. One handed chest pass

When passers are defended closely, it is difficult or impossible for them to make safe two-handed chest or bounce passes. A better choice is to step to either side of the defender and throw a one-handed chest pass.

To make good one-handed chest pass, teacher should instruct learners to:

- Slide the passing hand behind the ball and the other hand to the inside of the ball,
- Step diagonally toward or past the defender's foot ,
- Shift the ball close to the shoulder of the passing arm,
- Thrust the arm toward the target as the attack foot touches down and release the ball with a snap of the wrist ,
- Follow-through with the passing arm extended, elbow locked and palm down or turned slightly to the inside.

e. One handed bounce pass

Learners can also use one-handed bounce passes to make entry passes to teammates who are posting up.

To make good one-handed bounce pass, teacher should instruct learners to:

- Use the same technique as for a two-handed chest pass but thrust the passing arm down and out rather than straight out
- Bounce the ball about two thirds ($\frac{2}{3}$) of the distance to the target so that it bounces to the height of the teammate's waist

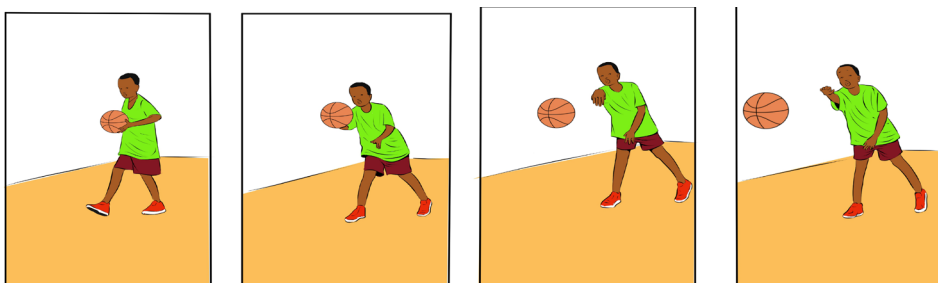

f. Hand off

Passers can hand-off to teammates cutting close to them. The exchange should be simple. But, unless both passers and receivers use correct techniques, hand-offs can easily result in fumbles and turnovers.

To make a good hand-off exchange:

- The passer and receiver come very close to one another.
- The receiver always moves behind the ball handler. In that way, the passer can use the body to protect the ball from defenders.
- The passer offers the ball at waist height. The passing hand is on the bottom of the ball, not on the side. The passing arm is slightly extended.

- The passer presents a stationary ball rather than tossing it up or toward the receiver. In that way, the receiver can take the ball clearly from the passer's hand.



g. Base ball pass

This is a one-handed technique for throwing long passes from a stationary position. If passers are moving, the chest pass is a safer choice.

To make good base ball pass, teacher should instruct learners to:

- Slide the passing hand behind the ball and the other hand to the inside of the ball for support
- Raise the ball to head height and draw the passing arm back behind the head
- Step forward with the opposite foot
- Release the ball as the opposite foot touches down
- Follow-through with the passing arm extended, elbow locked, palm down and fingers pointed toward the target. (Many learners throw more accurately if they follow-through with the thumb pointed down and the palm slightly out.) As the weight shifts fully to the front foot, the rear foot may lift and step through.

Catching the ball

The three main catching techniques are two-handed catch, one-handed trap and slap.

a. Two-handed catch

To make good two-handed catch, teacher should instruct learners to:

- Extend the arms toward the ball, fingers spread,
- Move their bodies into line with the pass
- Cushion the ball by bending their elbows and drawing the ball into the body

b. Trap and slap catch

In the trap and slap catch, learners stop (trap) the ball with one hand and immediately grasp (slap) it with the other hand to bring the ball into two-handed control. Learners use the trap and slap technique when the ball is away from the body.

To make good trap and slap catch, teacher should instruct learners to:

- Extend the arm that is closer to the ball
- Spread the fingers wide, thumb pointing up
- Lean toward the extended hand
- Stop the ball with the extended hand and pull the ball toward the body
- Reach across with the other hand to slap the ball. That slap brings the ball into two-handed control.

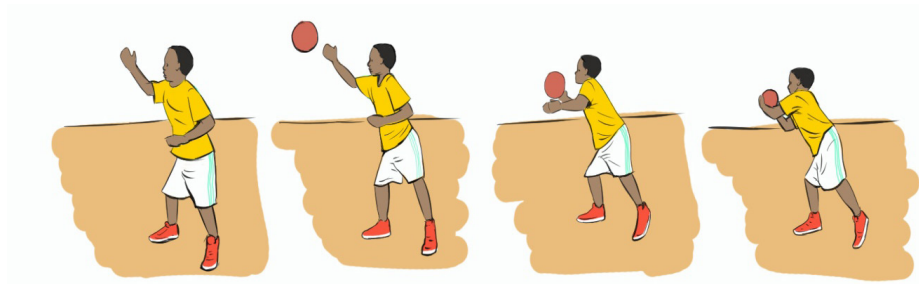

Technique 2: Dribbling

a. Pull back dribble

The pullback move is used by a learner/learner to create space or to set up a second move that takes the learner/learner past the defender.

Footwork: the learner/learner plants, puts the weight on the forward foot and rocks back so that the weight shifts to the rear foot.

Handwork: At the same time, the learner/learner slides the fingertips to the front of the ball and pulls it back, bouncing the ball to the side of the body.

Now the learner/learner can push off the rear foot in a change of speed and/or direction. For example, in a “pullback and go” move, the learner stops with a pullback dribble. Then, as the defender reacts to the pullback, the learner/learner drives past on either side.

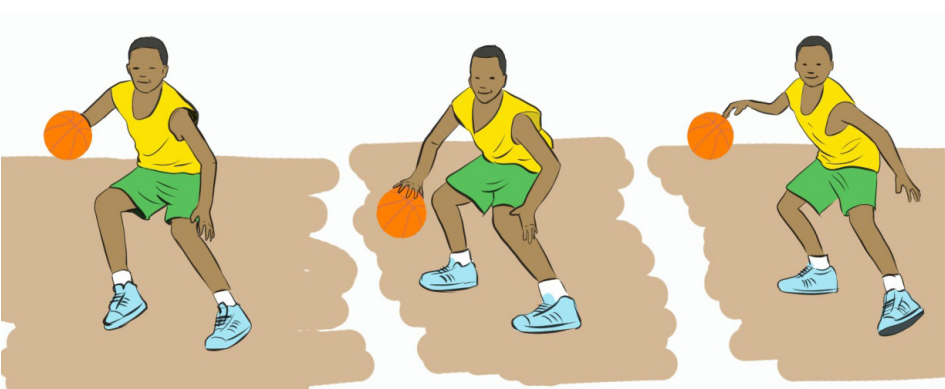

b. Front crossover dribble

The front crossover is an explosive change of direction.

Footwork: The moving learner/learner plants the outside foot, pushes off diagonally to the inside and steps in the new direction with the inside foot.

Handwork: At the same time, the learner/learner slides the fingertips to the outside of the ball and pushes the ball down and across the body in the new diagonal direction. The ball bounces just in front of the inside foot into the control of the other hand.

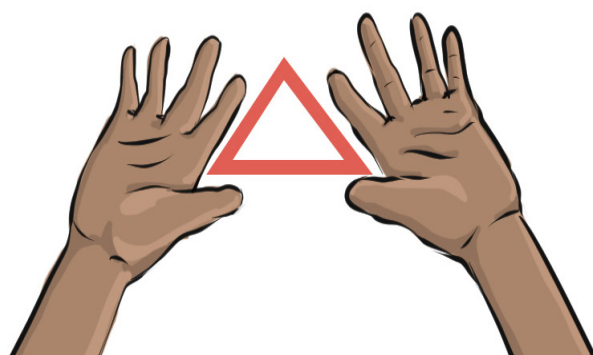
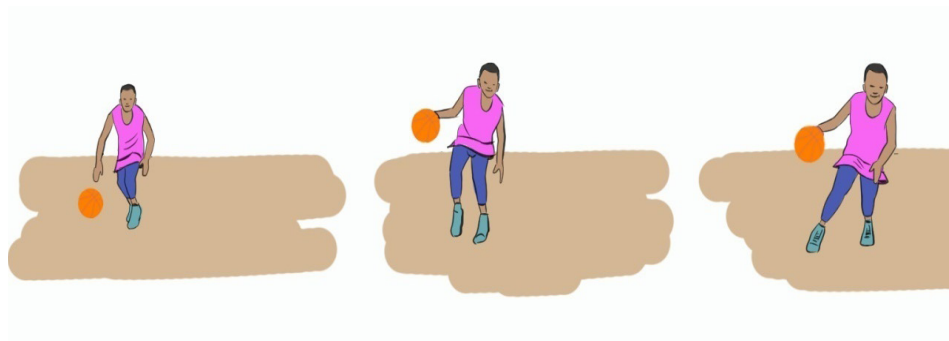

c. Between the leg crossover dribble

The footwork and handwork are very similar for the between the legs crossover and the front crossover.

Instead of bouncing the ball in front of the inside foot, the learner/learner bounces it underneath the inside leg and into the other hand.

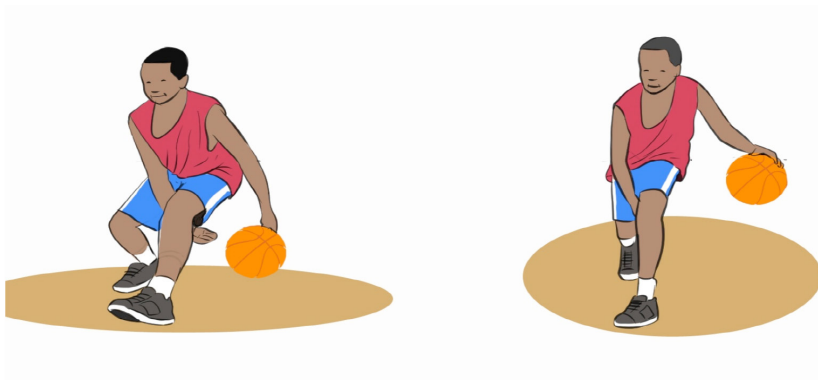
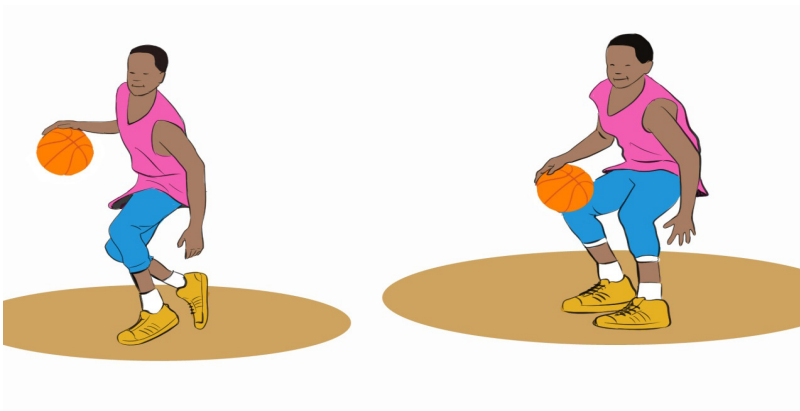
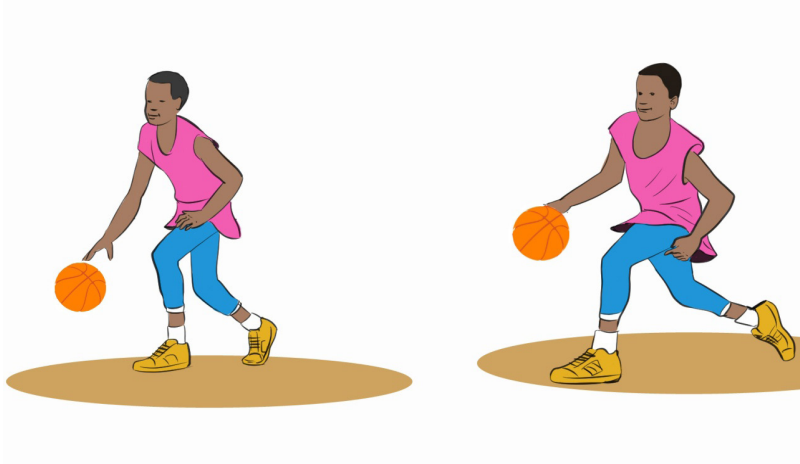

d. Behind the back crossover

Footwork: The footwork is the same as for the front and between the legs Crossover. The moving learner/learner plants the outside foot, pushes off and steps diagonally with the inside foot.

Handwork: As the learner/learner plants the outside foot, the learner/learner slides the fingertips to the outside of the ball and pulls the ball down and behind the body in the new diagonal direction. The ball bounces just under the inside hip into the other hand.

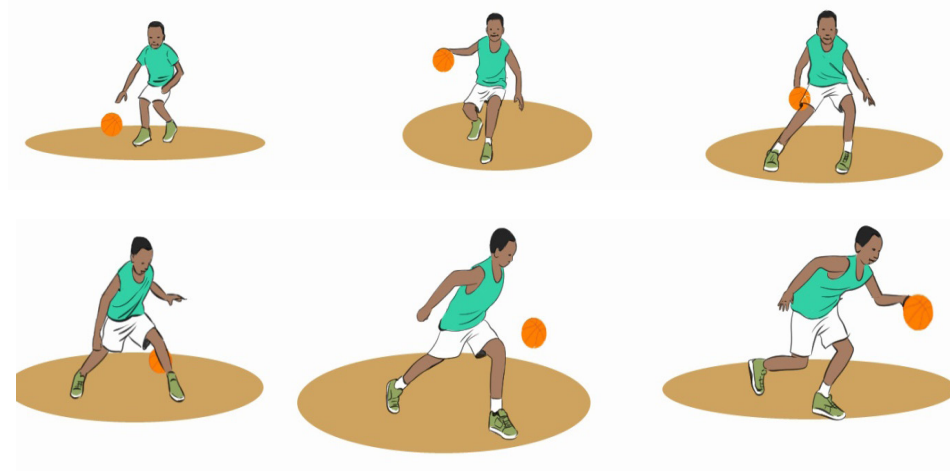

e. Reverse crossover

The reverse crossover is a slower but safer change of direction. The learner/learner keeps the body between the ball and the defender. Against persistent defenders, guards often use a series of reverse crossovers to advance the ball up court in a zigzag path.

Footwork:

- The learner/learner moves on a diagonal path, plants the inside foot, toes pointed in the direction of the ball.
- The learner/learner then executes a reverse pivot. That is, the learner/learner moves the outside foot in a backward direction leading with the heel.
- During the reverse pivot, the learner/learner briefly turns the back to the defender.
- When the outside foot touches down again it is pointed diagonally in the new direction.

Handwork:

- As the learner/learner plants the inside foot, and begins the reverse pivot, the learner/learner slides the fingertips to the front and inside of the ball and pulls the ball down to bounce midpoint between the legs.
- The ball bounces up into the control of the other hand just as the outside foot is touching down.
- When learners master the reverse crossover, they can gradually tighten and speed up the reverse pivot to turn the move into a spin dribble.

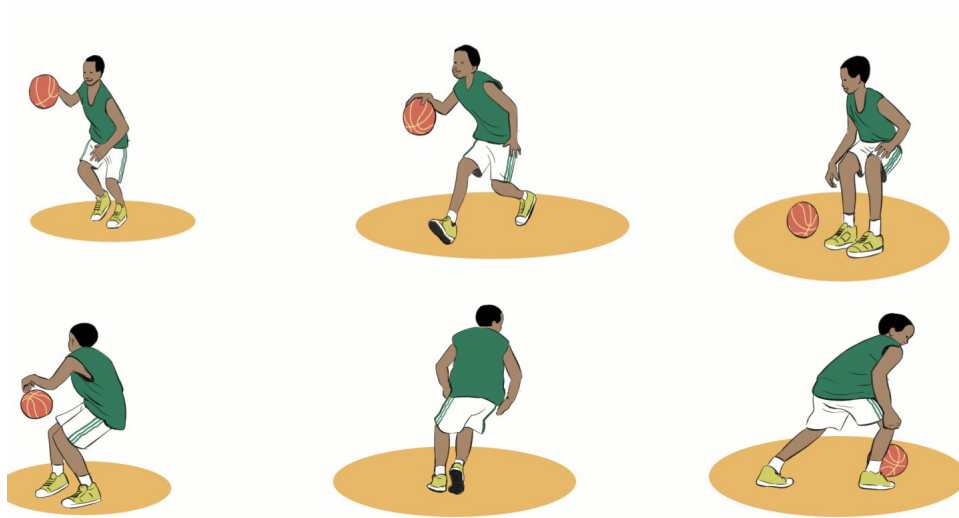

f. Spin dribble

The spin dribble is a tight, fast reverse crossover. This change of direction move is most effective when the learner/learner approaches close and head on at the defender. The learner/learner spins on the inside foot, turning the back to the defender, and comes out of the spin moving close to the original direction and path.

Footwork: The moving learner/learner plants the inside foot, toes pointed in the direction of the ball. Then, the learner/learner reverses pivots: the learner/learner moves the outside foot in a backward direction, leading with the heel. When the outside foot touches down again, it is pointed in the new direction.

Handwork: As the learner/learner plants the inside foot, the learner/learner slides the fingertips to the front and inside of the ball. The turning of the body pulls the hand and ball along. The learner/learner throws the ball down forcefully after turning past 180o and meets the bounce with the other hand.

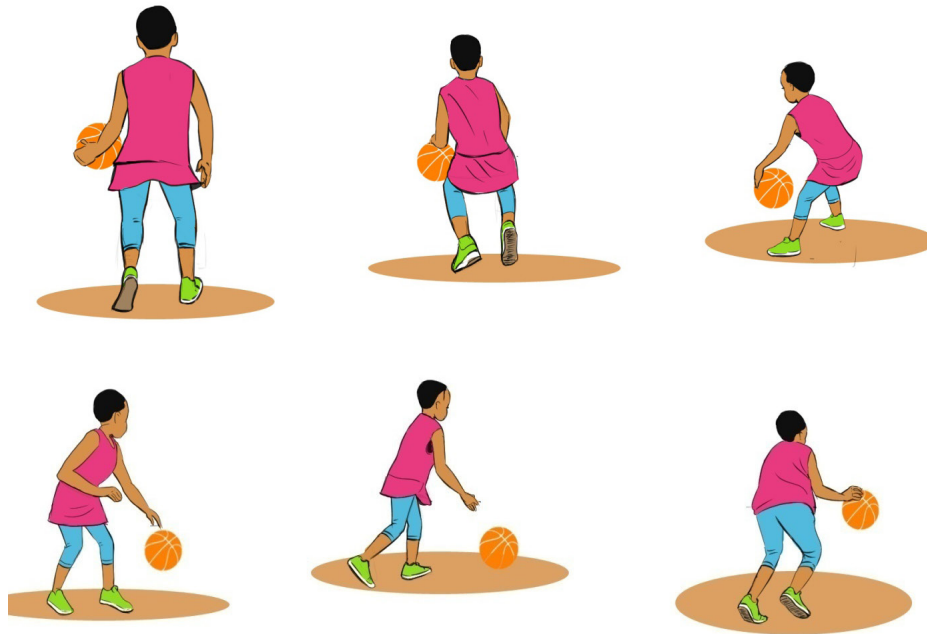

g. Inside outside dribble

The inside-out dribble is a quick move that fakes a change of direction.

Some people call it a “half-crossover.” To the defender, it appears that the learner/learner is beginning a front crossover, but the ball does not change sides.

Footwork: The moving learner/learner plants the inside foot.

Handwork:

- At the same time, the learner/learner slides the fingers to the outside of the ball and pushes it toward the centre of the body.
- As the hand/ball moves toward the inside, the learner/learner turns or rolls the hand slightly so that the fingertips are on the inside of the ball.
- The learner/learner then throws the ball down and diagonally ahead to the outside.
- The same hand controls the ball as it bounces off the floor.

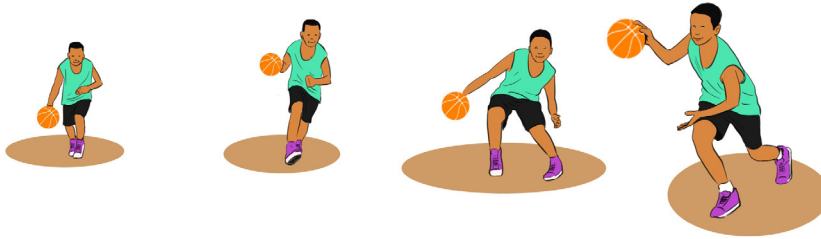

h. Crab dribble

When executing the crab,

- The learner keeps the back to the defender and each dribble is a low bounce between the feet.
- The learner takes a stance much like a defensive stance: the body low and the feet shoulder width apart.
- When moving, the learner backs up in a series of short, diagonal zigzags, like a defensive shuffle. The feet do not cross.
- The learner looks over their shoulder to see the court and uses the non dribbling hand and arm to keep the defender away from the ball.

Learners use the crab dribble to protect the ball while closely guarded and slowly moving a short distance. Guards sometimes use the crab when waiting for a screen or for a teammate to get open for a pass. Post learners use the crab to improve their position near the basket and to set up for a post move and inside score.

Footwork:

- The learner has their back to the defender and the basket.
- The learner shuffles backward (toward the basket) in a series of diagonal zigzags.
- To change directions, the learner plants one foot and makes a reverse pivot and then shuffles in the new diagonal direction.

Handwork:

- As the reverse pivot begins, the learner pushes the ball down with the outside hand to bounce midpoint between the feet.
- The learner meets the bounce low with the other hand and continues to dribble with that hand until the next change of direction.



Techniques 3: Shooting

a. Ready position

- **Body:**
 - The shooter/learner is square to the target: the head, shoulders, chest, knees and toes all face the basket.
 - The knees are bent, the buttocks low and the back straight. Feet are shoulder-width apart.
 - Most shooter/learner s slightly advance the foot on the same side as the shooting hand.
 - The shooter/learner is balanced and feels “bouncy,” rather than stiff or tense.
- **Arms:**
 - The shooter/learner keeps the shooting arm close to the body.
 - The forearm is perpendicular to the floor.
 - The elbow is directly under the wrist and points down to the shooting foot. It does not angle outward to the side.
- **Hands:**
 - The shooter/learner holds the ball with both hands.
 - The shooting hand is in front of the armpit, behind and slightly under the ball.

- The offhand is spread at the side of the ball to support and balance it.
- The offhand helps to support the ball until shortly before the release.
- The shooter/learner spreads the fingers wide. Only the pads of the fingertips (not the palms) contact the ball.



- On the shooting hand, the index and middle finger form a V in the middle of the ball. For some learners, the three middle fingers form a W.

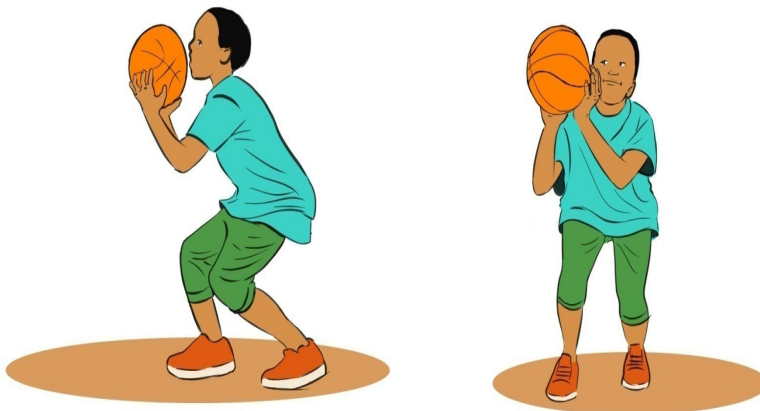

b. Set shot

From the ready position to the follow-through, the shooter/learner is balanced and square to the target, eyes locked on the basket. The movements are fluid and continuous.

Footwork:

- The shooter/learner pushes upward with the feet and legs.
- The legs straighten. That thrust from the lower body supplies most of the power for the shot.
- The shooter/learner will release the ball before that upward momentum is spent.

Handwork: The shooter/learner:

- Pushes the ball upward past the head's temple. The forearm remains perpendicular to the floor.
- Pushes upward and outward with the shooting hand. As the arms extend, the offhand separates from the ball.
- Releases the ball with a snap of the wrist and fingers. The elbow locks near the shooter/learner's temple.
- Continues into and holds the follow-through until the ball reaches the target. The arms are in the release position.
- The V or W of the fingers stays in line with the basket.

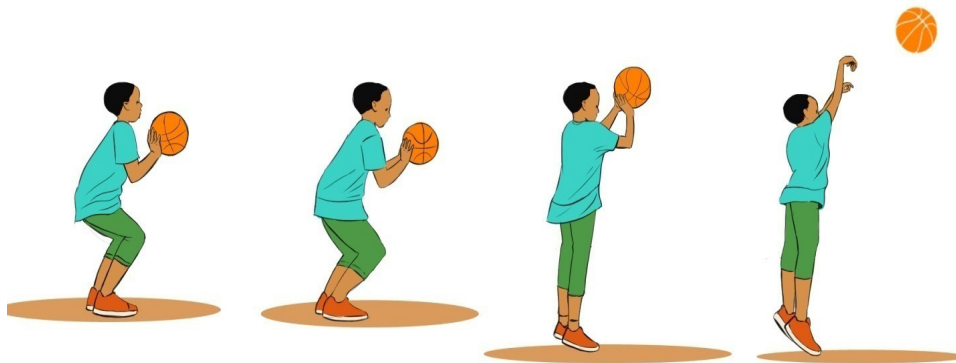

c. Jump shot

It takes time for learners to develop the coordination to shoot a jump shot well. Teacher can help learners by using a gradual progression like the following:

Start the learners close to the basket. Instruct them to:

- Take a ready position
- Jump straight up, not to the side or backward. A slight forward movement in the jump is acceptable.
- Release the ball on the way up, rather than at the peak of the jump or on the way down.
- Have the learners take a ready position, fake a shot, then shoot. Instruct learners to keep the ball close to the same height during the fake as it was in the ready position. Learners should not fake by extending their arms or straightening their legs or bodies. Rather, they should bend their knees more and drop their

buttocks a little closer to the floor. That movement creates the illusion that the ball is rising.

- Have the learners dribble once or twice into easy range, jump stop to the ready position and shoot.
- Emphasize balance in the stop, jump and follow-through.
- Have the learners dribble into range, jump stop, fake a shot and then shoot.
- Have the learners jump stop and shoot behind a chair or a teammate. Gradually, learners will become comfortable shooting over screeners and defenders.

Technique 4: Layups

Layups are high percentage shots taken from a run and jump close to the basket. Learners usually jump off one foot but can jump off both at the same time. They can release the ball overhand (with the palm facing the basket) or underhand (with the palm facing the shooter).

a. Ready position for making a lay up

Body: The shooter/learner squares to the target on the approach and jumps so that the head, shoulders, chest, knees and toes all face the basket.

Arms: The shooting arm is close to the body. The forearm is perpendicular to the floor. The elbow is directly under the wrist and points down to the shooting foot. It does not angle out to the side.

Hands: The shooting hand is further from the basket. That means the ball is also further from the defender and better protected. The shooter/learner holds the ball with both hands. The shooting hand is in front of the armpit, behind and slightly under the ball. The offhand is spread at the side of the ball to protect and support it until shortly before the shot release.

The shooter/learner spreads the fingers wide. Only the pads of the fingertips (not the palms) contact the ball. On the shooting hand, the index and middle finger form a V in the middle of the ball. For some learners, the three middle fingers form a W.



b. Layup footwork

Footwork: The moving learner makes the approach in a four-count sequence: inside, outside, inside and up.

- **Inside.** The learner plants the inside foot (opposite side to the shooting hand) and picks up the ball or catches a pass.
- **Outside.** The learner plants the outside foot (same side as the shooting hand). That foot is now the pivot foot.
- **Inside.** The learner takes a long step and lands on the inside foot.
- **Up.** The learner jumps off the inside foot, driving the outside knee upward towards the target. That jump and knee thrust elevate the shooter and turns the body to the goal. The jump is upward rather than forward.

Handwork: As the knee drives upward and towards the basket, the learner raises the ball with two hands. The ball is in the fingertips (not the palms). As the arms extend to their fullest, the offhand separates from the ball. Just before the peak of the jump, the learner releases the ball with a soft flick of the fingers. Sometimes, especially when they expect to get bumped, learners make their jump off both feet at the same time. The handwork remains the same, but the footwork changes to this sequence: inside, outside, both, up.

- **Inside.** The learner plants the inside foot and picks up the ball.
- **Outside.** The learner plants the outside foot.
- **Both.** The learner takes a long jump and lands on both feet.
- **Up.** The learner then immediately jumps off both feet.

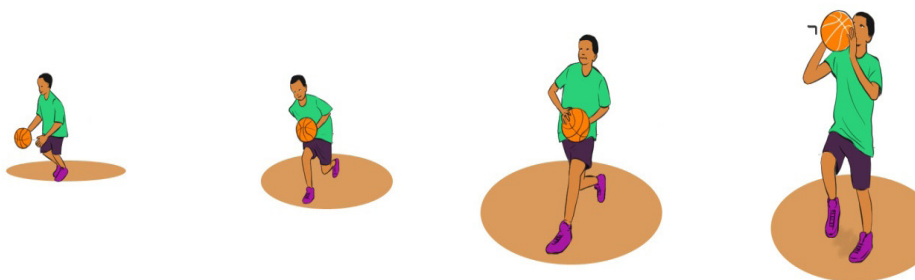

Teaching tips of layups

Good learners shoot layups with their right hand when approaching from the right side of the goal. They use their left hand when approaching from the left side. Help beginning learners to learn the layup shot from both sides with the following progression:

- Start the learners a little beyond the right elbow.
- Have them dribble slowly to the elbow and pick up the ball.
- As they pick up the ball, instruct them to chant and perform this 4-count sequence: LEFT, RIGHT, LEFT, UP.
- From the left elbow, instruct them to chant and perform this sequence: RIGHT, LEFT, RIGHT, UP.

Encourage the learners to imagine that the outside (shooting side) elbow and knee are connected by a rope. As the shooting arm rises, the knee lifts up.

Cool down activities: Refer to the unit 5 lesson two.

e. Assessment

Reflect

What are the main basic techniques used in basketball?

Highlight different steps/tips to follow when making pass, dribble, shot or layup?

Which hand have you used to pass, dribble, shoot or make a layup?

Connect

What part of the hand gives you the best control of the ball?

How can you change the direction more sharply?

Apply

Which technique will you use to progress with the ball?

Lesson 2: Technical development activities of basketball

a. Prerequisites

Learner will learn better this lesson if they are able to perform different basic techniques of basketball.

b. Teaching resources: Cones, playground, whistle, stopwatch, balls, sport uniform

c. Introduction:

- **Open discussion:** Refers to the unit one, lesson one and ask learners different questions related with the lesson.
- **Warm –up activities:** For the warm-up and stretching activities refers to the Unit 6 lesson one.

d. Lesson development

In this lesson learners will apply different basic techniques learnt in the lesson one through different technical development activities.

Activity 1: Stretching out

Learners try to:

- Keep possession of a ball while dribbling around a cone and take turns leading a stretch during a cool-down

How to Play

To set up the activity:

- Divide the learners into two groups. The groups spread out along opposite sidelines facing each other.
- Space out at least six cones along the midline of the court (foul line to foul line).

Explain and demonstrate:

On the teacher's signal, learners dribble to the closest cone, circle the cone and return to their starting places.

- On their return, ask one learner to step out and lead the team in a stretch. Ask the learner to explain the benefit of the stretch and the proper way to do it.
- Repeat the sequence as many times as desired asking different learners to lead and explain a variety of stretches (dynamic and active isolated).

Safety note: Over several practices, ask every learner to lead.

Caution the learners to adjust speed and direction to avoid collisions when dribbling.

Variations

Simplifications

- Learners move without a ball. They sprint to the nearest cone, touch both hands

to the floor and then jog backwards to their starting places.

- Teachers can lead each stretch while asking learners questions about stretching techniques.

Extensions

Learners dribble using only their left or right hand, or they change from hand to hand in repeated crossovers.

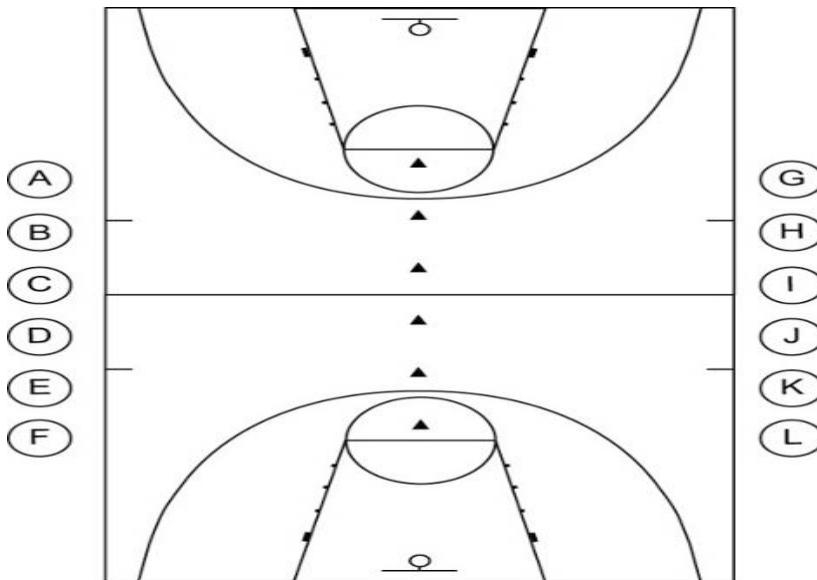

Activity 2: Bump

Learners / Shooters start in a line and try to avoid being “bumped,” by scoring before the next shooter scores and bump the previous shooter by scoring before that shooter scores

How to Play

To set up the activity:

- Direct the learners to line up behind the free throw line.
- The first two learners, A and B, have a ball.

Explain and demonstrate:

- Learner A shoots a first shot from the free throw line and follows the shot. B quickly steps to the line, shoots and follows the shot.
- Learners rebound their missed shots and continue to shoot (from where they rebound the ball) until scoring or being bumped by the shooter behind. For example:

- If learner A scores before B, A passes to C and rejoins the line. B continues to rebound and shoot, trying to score before C.
- If learner B scores before A, B passes to C, A passes to D. B rejoins the line. Learner A is bumped and must complete a task (see suggestions below) before rejoining the line.

Teacher direct bumped learners to complete a task like the following ones before rejoining the shooting line:

- One or more form shooting drills
- One or more ball handling drills
- A slalom dribble course
- 10 jump shots against a wall
- 3 successful free throws at another goal
- One or more wind sprints
- Play continues for 10 minutes. Learners can keep track of successful shots from the free throw line and/or how many times they bump or were bumped by another learner.

Safety note: Caution the learners to complete tasks in another area of the court to avoid collisions or loose balls.

Variations:

Simplifications

- Shooters/learners start from a step inside the free throw line.
- Shooters/learners alternate shot attempts. After a miss, a shooter/learner must wait for the other learner to shoot before shooting again.
- Instead of bumping or being bumped, learners count:
- 2 points for scoring before the shooter ahead
- 1 point for scoring before the shooter behind
- 0 points if the shooter behind scores first

Extensions

- Shooters/learners start behind the 3-point line for the first shot.
- Learners cannot dribble after rebounding missed shots.
- Learners must shoot from the spot where they recover the ball.

Activity 3: Box in

Learners try to complete three consecutive passes to a teammate against another team as many times as possible.

How to Play

To set up the activity:

- Place four cones to mark off playing area 5-metres square.
- Divide four learners into two teams, A and B. Team A starts with the ball. Team B plays defense.

Explain and demonstrate:

- Team A tries to complete passes without dribbling and without losing possession of the ball.
- Team B tries to steal the ball or to force wayward passes and violations.
- Team A scores 1 point each time it makes three consecutive passes within the playing area.
- Teams rotate from offence to defense after a steal, a boundary violation or a 5-second violation. Also, teams rotate after the offence scores 3 consecutive points.
- Play continues for 3-5 minutes.

Safety note: Caution the learners to:

- Be strong with the ball, but to keep their elbows down while pivoting
- Keep their heads away from the ball on defense

Variations:

Simplifications:

- Increase the size of the playing area.
- The defender must stay an arm's length away from the passer.

Extensions

- Reduce the size of the area and/or add a third learner to each team.
- Learners must dribble three times before passing.

Cool down activities:

Refer to the unit 5 lesson two.

e. [Assessment](#)

Reflect:

- Which activity that was more challenging?

Connect:

- How do you know when you have stretched far enough?

- Where should you focus your eyes during your shot?
- What is your target for shooting at an angle to the goal?
- How can you prepare for a quick shot release before you have the ball?

For example:

- Where your body should be facing?
- What should your stance be?
- How can you create space for a pass
- Why is it important to step toward your target and follow through with each pass?
- How can you catch and pass without travelling?

Apply:

- How will you practice your shooting form without a basket?
- How long should you hold the stretch?
- What will you do for a missed shot?

Lesson 3: Develop Body coordination and evaluate him/her performance level in modified game of basketball and following basic rules

a. Prerequisites:

Learners will learn better this lesson if they are able to perform different basic techniques of handball.

b. Teaching resources:

Sport uniforms, open containers (bucket, boxes, baskets or hoop), whistle, stopwatch, etc.

c. Introduction:

- Open discussion: Refers to the unit one, lesson one and ask learners different questions related with the lesson.
- Warm –up activities: For the warm-up and stretching activities refers to the Unit 6 lesson one.

d. Lesson development

Modified games: Are games with “friendly” rules that provide all learners with the opportunity to play and be included in the game.

To involve more learners, you can make modifications like these:

- Have teams substitute every two minutes or after every score.
- Have teams play 4 vs. 4 or 3 vs. 3 at each goal.
- If there are no goals available, teams can score into a target marked on the wall, or into a container fastened at the correct height or sitting on the ground. They can also score by catching a pass within a marked area.
- If they are using modified balls that bounce poorly, change the rules to eliminate dribbling.
- Here below are proposed modified games, teacher is advised to use them as they are described or modify them to suit the needs of their learners.

Modified game 1: Bucketball

Learners try to score by shooting or throwing the ball into the team’s bucket and stop the opposing team from scoring into its bucket

How to Play

To set up the activity:

- Divide learners into two teams, A and B. Each team has 4-6 learners.
- Place a cone on each foul line. One cone is team A’s. The other is team B’s.

Explain and demonstrate:

- Learners A1 and B1 each stand with one foot touching the team cone. A1 and B1 each hold a bucket and can move the bucket to catch teammates’ shot attempts.
- Learners try to score into the bucket held by their teammate.

- Basketball rules apply. Exceptions:
- A score counts only if the bucket holder has a foot touching the team cone.
- There are no key violations.
- After a set time or several baskets, learners rotate to take a turn holding the team bucket.

Safety note: Caution the learners to avoid swinging the bucket near other learners.

Variations:

Simplifications

- Allow passing only. Or, limit learners to three dribbles only.
- Add a second ball to the game.

Extensions

- Remove the cones. Allow bucket holders to move anywhere on the court. Count scores only if the bucket is above the holder's shoulders.
- Add one or more basketballs to the game.

Modified game 2: Three Team Basketball

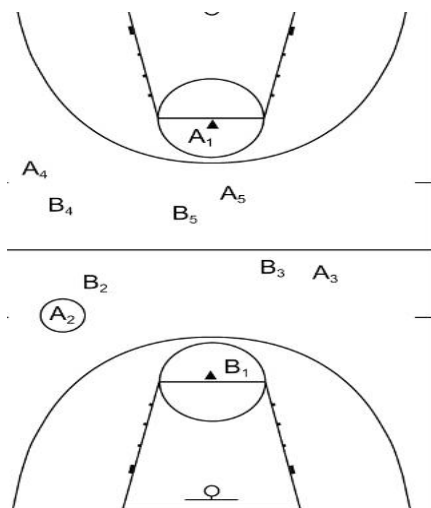

Learners try to advance the ball by passing to and receiving passes from a third team. They score against an opponent and keep an opponent from scoring.

How to Play

To set up the activity:

- Divide learners into three equal teams of 4 learners.

Explain and demonstrate:

- All teams play at the same time.
- At any time in the game, one team is on offence, one team is helping the offence

and one team is on defense.

- No dribbling is allowed.
- Learners on the offensive team can shoot but cannot pass to one another. They can pass only to the helping team.
- Learners on the helping team cannot shoot or pass to one another. They can pass only to the offensive team.
- Learners on the defensive team try to gain possession through interceptions, steals, blocked shots or rebounds.

Example:

- Team A starts on offence. Team B starts on defense. Team C starts as the helping team.
- Team A advances the ball by passing to and receiving passes from team C.
- Team B tries to force a turnover and prevent a score.
- If team B gains possession, team B advances the ball with the help of team C. Team A defends.
- When a basket is scored, the teams rotate from defense to offence to helping.

Safety note: Caution the learners, especially the passing team, to avoid collisions with other learners.

Variations

Simplifications

- Learners on the helping team must stay within one step of the boundary lines.
- Learners are allowed one dribble.

Extension

- Learners on the helping team can set screens for the offence. The helper must yell, “Screen!” before setting a screen. The call will alert the defender to avoid a collision.

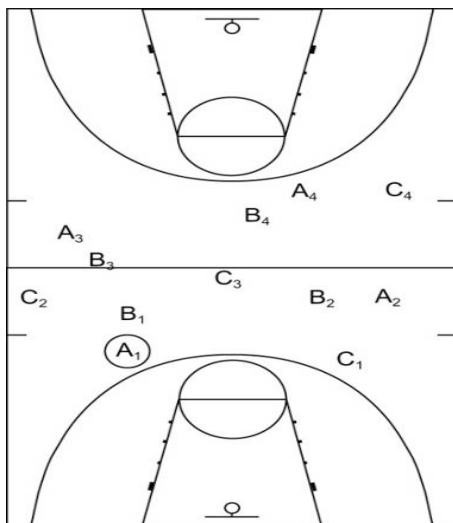

Modified game 3: Naismith

Learners try to score against an opponent without dribbling and defend against passes and shots

How to Play

To set up the activity:

- Divide learners into equal teams of 4-5 learners.

Explain and demonstrate:

- Two teams play 4 vs. 4 or 5 vs. 5 at one goal.
- One team starts on offence with the ball outside the 3-pointline.
- The other team starts on defense.
- Offensive learners cannot dribble. They can cut, screen, pass, shoot and rebound. If the offence scores, it takes the ball out of bounds under the goal. It must advance the ball past the 3-point line before turning and attempting to score again.
- When the defensive team gains possession, it must advance the ball past the 3-point line before turning and attempting to score.

Safety note: Caution the learners to:

- Avoid fouling opponents
- Avoid stopping under a jumping learner. To do so can cause serious injury.

Variations

Simplification

- Teams score 1 point for every five passes caught inside the 3-point line.

Extension

- Teams play full court 4 vs. 4 or 5 vs. 5 without dribbling.
- The defence can try to steal the ball anywhere on the court.

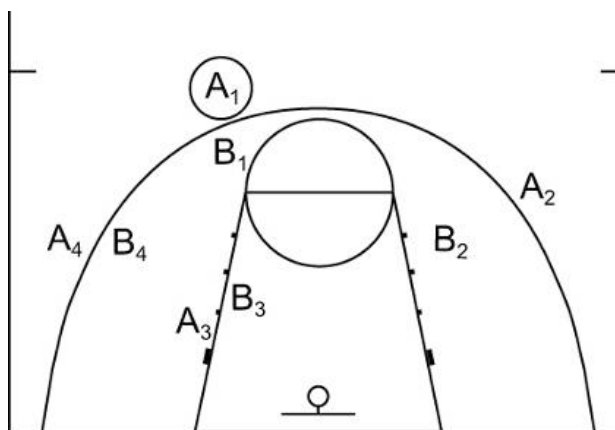

Cool down activities: Refer to the unit 5 lesson two.

e. Assessment

Reflect:

- What are you noticing about unsuccessful passes?
- Which style of play is giving your team more success?
 - Lots of dribbling and few passes?
 - Lots of passing and little dribbling?
 - On defense, what kinds of talk among your teammates make it easier for you to defend well?

Connect:

- How can your teammates get open for passes?
- How can your teammates make it difficult for the offence to get good shots?

Apply:

- To avoid misses, deflections and interceptions:
 - What can the passers do?
 - What can the catchers do?

7.5. End unit assessment

Using different technical development activities and modified game, learners are able to perform basic techniques such as pass, catch, dribble, shot the ball and layups and evaluate one's own and others' performance level and following basic rules.

7.6. Additional activities

Additional modified game 1: Six passes quick

Learners try to Complete three passes while running up court and they finish by shooting a successful layup

What you need: 10 learners, 2 balls and 2 goals

How to Play

To set up the activity:

- Divide the court in half lengthwise.
- Learner G, the shooter, starts with a ball to the right of the basket.
- On the right side of the court, learners A, B and C are passers.
- Learner A is on the sideline at the free throw line extended. B is in the centre circle. C is up court on the sideline at the free throw line extended.
- On the left side of the court, learners D, E and F are passers.

Their positions mirror those of A, B and C.

- Additional learner line up behind A and D.

Explain and demonstrate:

- G passes to A (1) and runs up court. A returns the pass (2).
- G catches and passes to B (3). B returns the pass (4).
- G catches and passes to C (5); C returns the pass (6).
- G catches and shoots a layup. C follows G.
- C rebounds, passes to D (1) and runs down court.
- C continues the pass-and-catch sequence with D, E and F and shoots a layup.
- After each pass, passers rotate counter-clockwise to the next passing position: A moves to B's spot, B moves to C's spot and so on.
- After each layup, the shooter joins the line at A or D.

Safety note: Caution the learners to:

- Move quickly to the next position after passing the ball
- Stay in the designated areas to avoid collisions

Variations:

Simplification

- The pass and catch sequence runs up court only. No shot is taken. Another group can run on the left side of the court.

Extensions

- Specify the kinds of passes and or shots.
- Add two extra passing spots for Eight Passes Quick.

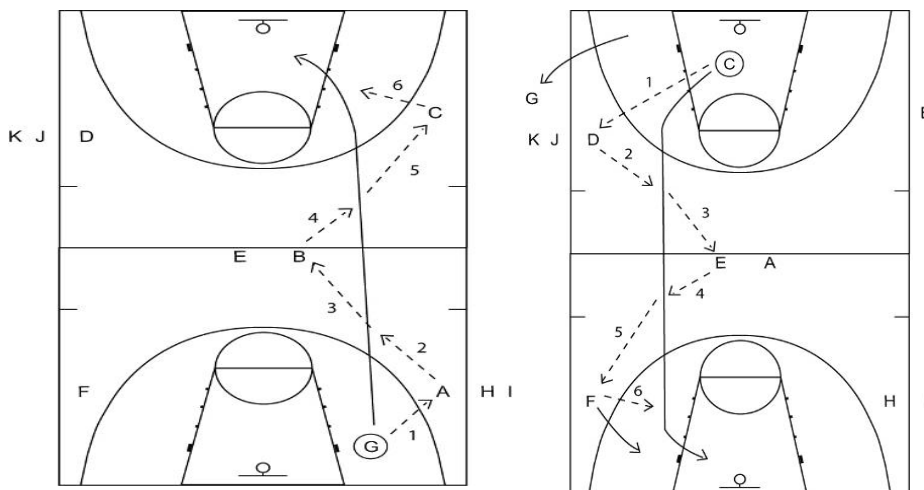

Additional modified game 2: New ball

Learners try to score against an opponent in a full-court game and gain possession of a new ball put into play by the Teacher

What you need: 2 goals, 2 basketballs, 8+ learners

How to Play

To set up the activity:

- Divide learners into equal teams of 4-5 learners.

Explain and demonstrate:

- Two teams play 4 vs. 4 or 5 vs. 5 full court. The teacher stands at the sideline holding another ball.
- When the teacher yells, “New ball!” the ball handler must dribble to the sideline and hand the ball to the teacher before rejoining play.
- Meanwhile, the teacher puts the other ball in play by passing to any learner on the court.
- The teacher yells “New ball!” at any time.

Safety note: Caution the learners to:

- Avoid fouling opponents, especially when going for a loose ball allow the first person to reach the loose ball to gain possession
- Avoid going straight at one another for loose balls
- Dribble over and hand (not throw) the original ball to the teacher.

Discussion Points

- When your team loses possession of the ball, where do you run?
- If you are lying on the floor in possession of the ball, what can you do to avoid a turnover?

Variations

Simplification

- After the teacher yells, “New ball!” the first defensive learner to reach the Teacher takes a hand-off and play continues.

Extension

The teacher can put the new ball into play by:

- Rolling the ball to an open area
- Bouncing it high toward the learners
- Shooting at either basket



UNIT 8: HANDBALL

8

8.1 Key unit competence

Catch, pass, and throw the ball, using these techniques in a game situation.

8.2. Prerequisite knowledge and skills

From the previous units, learners are able to receive, hold and throw the ball in different directions with one hand or two hands. This can be (a starting point) the prerequisite skills of applying basic techniques of playing handball.

8.3. Cross-cutting issues to be addressed:

- **Peace and values education:** Teacher is encouraged to give feedback to the learners in positive way and help them to play cooperatively.
- **Gender education:** Encourage both girls and boys to participate actively
- **Inclusive education:** In teaching-learning process the teacher must identify learners with special education needs and plan adapted exercises accordingly. Involve all learners in all activities without bias.
 - Allow a learner with physical disability (using wheelchair) to be a referee, a coach, an assistant, judges and help you to set materials in the playground
 - Simplify expectations for activities: Modify activities so they suit the abilities and attention span of the learners.
- **Comprehensive sexuality education:** Set instructions that prevent sexual harassment, violence and bad body touches.
- **Financial education:** Facilitate learners to make no cost materials like balls from banana leave fibers; these balls can be used to perform basic handball technique such as catching, passing and throwing the ball etc.

8.4. List of lessons

#	Lesson title	Learning objectives (from the syllabus including knowledge, skills and attitudes):	Number of periods
1	Basic techniques of playing handball.	<ul style="list-style-type: none">• Practice different basic techniques necessary to play handball.	1
2	Technical development activities of handball.	<ul style="list-style-type: none">• Perform different exercises focus on pass and catch, dribble, shooting and goalkeeping.	1
3	Develop body coordination and evaluate his/her performance level in modified game of handball and following basic rules.	<ul style="list-style-type: none">• Create individual techniques in game situations.• Evaluate his/her one's and others' performance in handball.	1
4	End unit assessment		1

Lesson 1: Basic techniques of playing handball

a. Prerequisites

Learners will learn better this lesson if they are able to run fast, change direction of movements and perform a range of actions and movements with consistency and self confidence.

b. Teaching resources:

Playground, sport uniform, whistle, balls, stopwatch, goalposts, cones.etc

c. Introduction

- **Open discussion:** Refers to the unit one, lesson one and ask learners different questions related with the lesson.
- **Warm –up activities:** For the warm-up and stretching activities refers to the Unit 6 lesson one.

d. Lesson development:

Considering the level of learners and activities which are performed in the court, handball technique include:

- Catching and passing
- Dribbling
- Shooting
- Goalkeeping

N.B: For each technique teacher should:

- Show learners how to perform each technique with explanations step by step.
- Let learners practice based on instructions and provide necessary support.
- If possible with learners, improvise balls from locally made materials.

Technique 1: Catching and Passing

e. Catching the ball

Catching the ball is an essential technical element in handball. Accurate catching is very important and ensures a fast, smooth and efficient game. Catching the ball with two hands is the best method. In some situations one can use one hand with the help of the other hand before passing or shooting. So-called “putting down” a ball is rarely used.

The “softness” of catching the ball is another feature of catching. Fingers must be relaxed and properly placed on the ball providing shock absorption during impact. An additional element, which is important while catching, is the speed of movement and the proper positioning of a learner in regard to the path of a ball.

In principal the ball is caught by two hands forming a bowl, where the two thumbs are pointing towards each other and forming the bottom of the bowl. The hands are meeting the ball in front of the body and drawn back at the moment, where you catch the ball. By catching low balls you turn the bowl, so the little fingers are forming the bottom of the bowl.

Correct catching high balls (between breast and head)

- Keep the eyes on the ball until they have caught it.
- The arms are slightly bent and move towards the ball.
- Hands and fingers form a tunnel, a heart standing on its head.
- The fingers and the thumbs are spread.
- The thumbs are directed towards each other.
- Move to the ball without waiting.
- While catching, the learner must assume a posture required to pass.
- Catching the ball elastically in front of the body and “absorbing” it by moving the hands to the body.
- The thumbs are behind the ball and prevent it from passing to the breast



f. Passing the ball

This is one of the basic, technical elements. A pass must be accurate, fast and tactically useful. Accurate, so that a learner has no problems when catching the ball. A decision to which a pass should be directed depends on the learner’s position in a particular situation. A pass should be directed to that learner, whose position may menace the opponent.

It is very important to teach your learners the basic skills of passing from the beginning. Otherwise they will find it difficult when it comes to more complicated shooting forms.

Teacher should instruct learners to:

- Hold the ball high with the over arm at shoulder height and the elbow at 90 degrees angle.
- Draw the throwing arm backwards.
- Have left foot in front if you are passing with the right arm. Right foot forward if you are passing with the left arm.
- Move the passing arm forward and finish the movement with a stretched arm.

A final movement in the wrist/fingers gives the ball extra speed and the chosen direction.

They can obtain extra power in the pass by rotating in the body and following through.

When it comes to passing teammate timing is essential:

- Find the right moment to pass
- Choose the best receiver
- Decide the speed of the pass
- Choose the type of pass

Technique 2: Dribbling

After receiving the ball and before dribbling a learner holds the ball with both hands.

The ball is being dribbled sideways at hip level. Bouncing on the ground is performed by the combined action of the elbow and wrist joints. The angle of the bounced ball depends on the speed that the learner is moving at. The faster the run the more the angle becomes obtuse. If an opponent comes closer, a learner must lower his position as well as the dribbling, protecting the ball from being taken by the opponent.

Technique 3: Shooting

Shots are one of the most important elements of handball. They are vital elements that decide the scores. While shooting the muscles of the lower and upper limbs, pelvic region and trunk are extremely engaged.

One can assume that shooting is performed similarly to passing, but with a stronger action of the trunk and upper limbs. The shot power is conditioned by the distance and hand action time on a ball. The greater the distance that the hand on the ball covers in the time unit the stronger the shot will be (a ball reaches a higher velocity) performed.

The names of shots have been derived from the way the learners move on the court and the position of his/her body to the ground. In handball there are the following shots:

Shot in Place



Leaning Back Shot

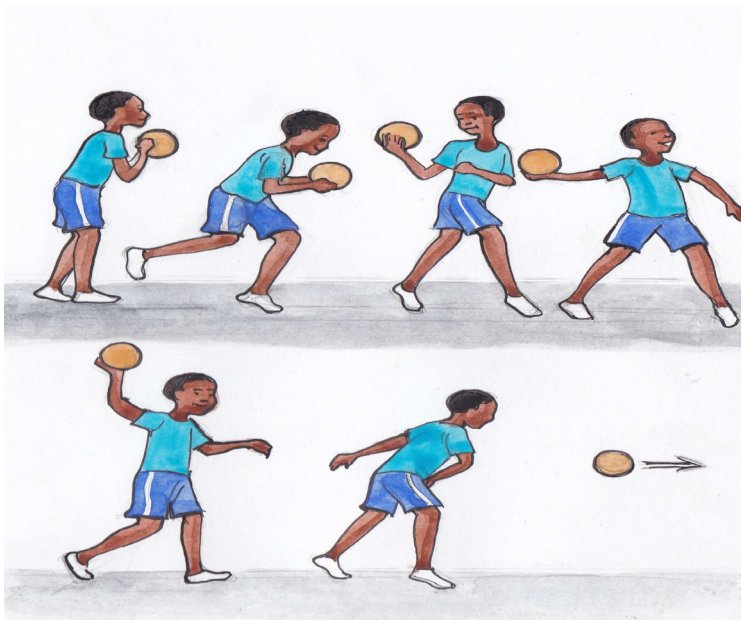

Vertical Jump Shot



Stride /Jump Shot

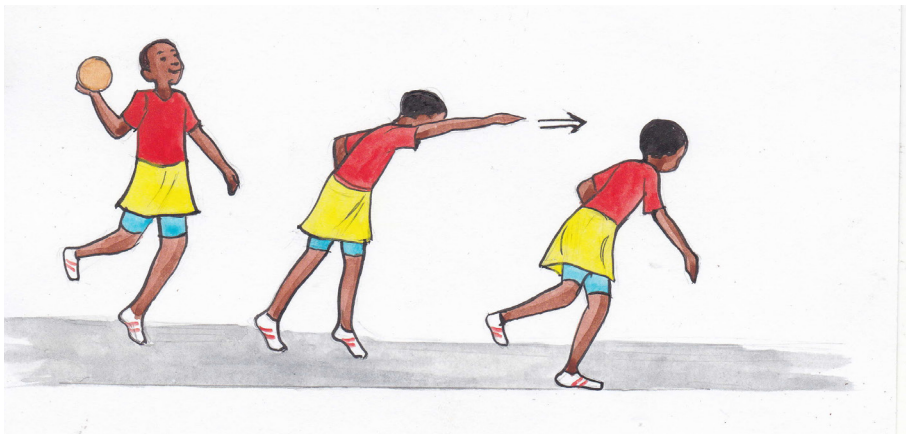

This shot is mainly used by the offence learners during a group tactical attack. The performance of this shot is preceded by a cross-legged jump or a jump towards the goal. Correct performance of the shot and particularly the position of the trunk and proper co-ordination of arms and legs make it the one of the strongest.

Shot While Falling

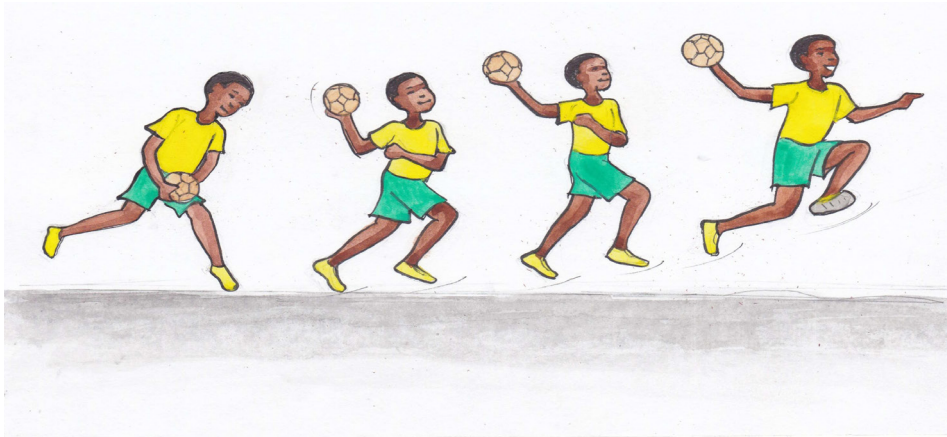

These are used during a game and while performing penalty shots. During a game (Competitions, training sessions) the shots are mainly performed by the pivot and wing learners. A pivot learner performs the shot facing backwards, forwards, right or left sideways the goal.

a. Forward Position

- A learner is on one foot or both.
- Leaning his/her trunk forwards before falling is performed without bending the hips.
- Up to the moment of losing balance, the ball being held in both hands, he/she brings it sideways at the level of the head or shoulder, twisting his/her trunk at the same time.
- Then the ball is carried with one hand, the other directed forwards is ready to absorb the impact while falling.
- The throw, which is the final backward move of the hand, should be executed at the very moment, when the learner's body is at an angle of 40 to the ground. Simultaneous,

b. Backward position

The method of the attack depends on the position of defender. If he/she is on the right, the pivot learner performs a half-turn to the left making the shot while falling.

If the defender is on the left, one should perform a half-turn around the right shoulder.

The shot can then be performed using the following technique: a learner takes-off from his right leg and throws the ball using the right hand, or he takes a step onto the left leg and shoots towards the goal.

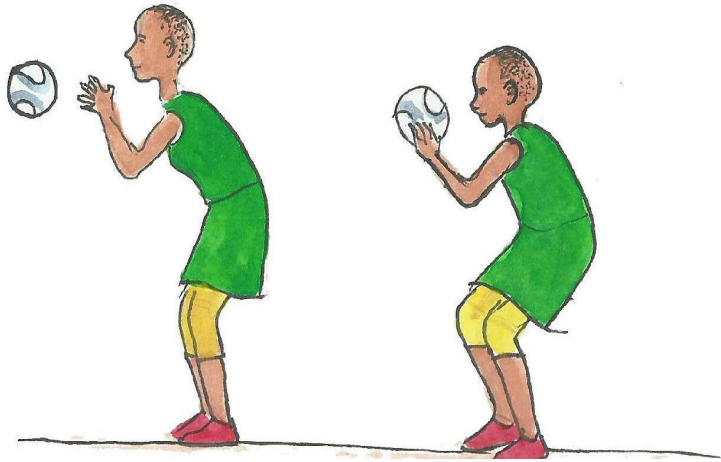

Hand

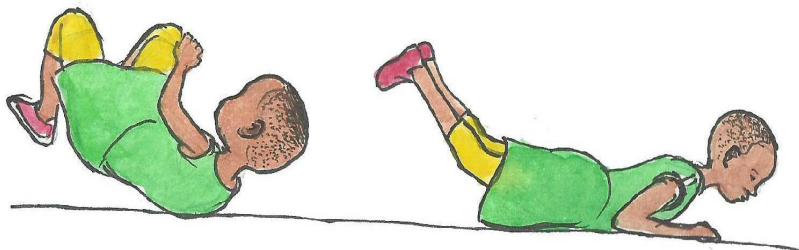
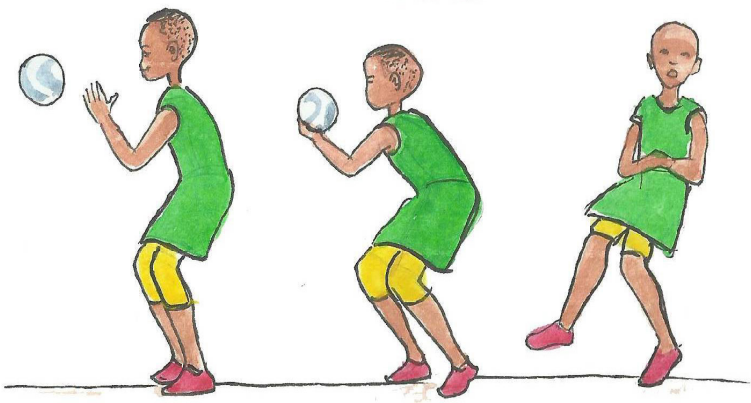

Technique 4: Goalkeeping

At the age of 5 to 9 the learners should be to play at all positions in the team including the goalkeeper's position. In this way they gain experience and understanding of the different tasks in all positions, and are therefore capable of choosing the right position for themselves in a team at a later stage. A lot of learners would like to try to be a goalkeeper. A good save or a goal is easy for them to relate to and to be goalkeeper is attractive, because you are the only one! But being a goalkeeper can be rather scary for some learners, so do not force a learner to be a goalkeeper, if he doesn't want to.

At the age of 10 to 11 you can start finding 2 or 3 learners, who have the right abilities to become talented goalkeepers. And you can start training the more specific skills for goalkeepers:

- Movements in the goal
- Positioning in the goal when the opponents are shooting from different positions
- Saves with one arm, both arms, with the legs and with arms and legs

The basic elements of goalkeeping

N.B: It's VERY IMPORTANT to properly plan and organize goalkeeper training while following the steps of progression, and when we recognize any of possible mistakes or problems during the progression to know that we should go step back in progression!

Basic stance

Basic goalkeeper stance is the most optimal position of the body that allows the goalkeeper to most effectively use her/his body as a defensive area, and to react on high, middle and low shots in the fastest and most practical way.

- The arms
- Core, back and head
- Body is just slightly bent forward in the hip joint
- Knees
- Legs
- Feet

There are a few variations of basic stance:

- Low basic stance - applied by very tall goalkeepers or goalkeepers who expect low or middle shots
- High basic stance – used by "shorter" goalkeepers, who are expecting high shot.

Movement in basic stance and proper positioning

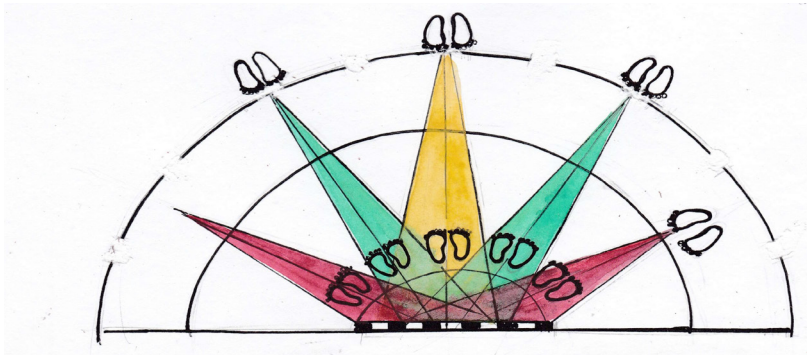

Coming into possession of the ball

”In a match situation: after the opponents shoot the ball towards our goal, and if we save the shot, or if they missed the goal – who is after that the first learner in attack in our team?”

Understanding the difference between stopping or rebounding shots depending on their strength

Saves of shots from gm (high, middle and low)

- Saves of high shots from gm
- Side push off step
- Reaction with one or two hands
- Position of the foot

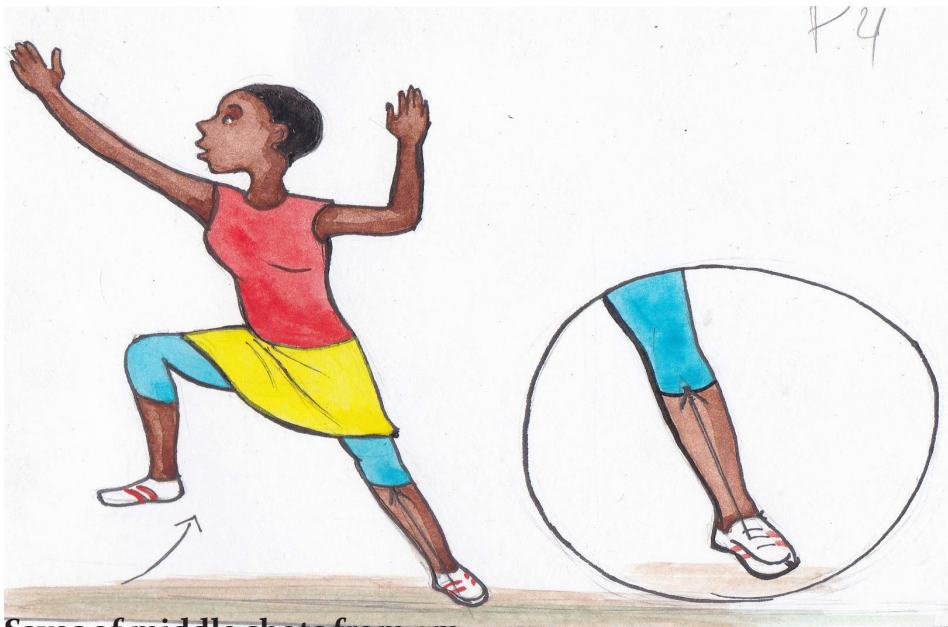

Saves of middle shots from gm

- Side steps reaction with one or two hands
- Proper foot position of reacting leg



Saves of low shots from 9m

There are two most common techniques for saves of 9m low shots:

Step to the side and Sliding (we don't want to teach young goalkeepers to slide as a first choice for low saves!)

- Push off from proper leg
- Hands position
- Foot position
- Hip mobility!



Saves of shots from 6m (high, middle and low)

- What precedes any save of 6m shot?

- "Attacking" the ball
- Timing
- Positioning
- Importance of basic stance and keeping the hands up while moving
- Saves of 6m high shots – normal high reaction; "opening" in jump...
- Saves of 6m middle shots – X jump, one leg lift up; "helicopter"...
- Saves of 6m low shots – normal low save reaction, "low wall"...
- Training with the rubber band!
- Saves of wing shots
- Wing stance

Learners can position and react on wing shots differently depending if they come from:

- Small angle
- Normal angle
- Big angle of shooting



Depending on the direction/height of the wing shot, shots can be:

- High
- Middle and
- Low wing shots

Saves of wing shots- the most common mistakes to avoid:

- Automatic reaction (most often lifting up the leg and going backwards)
- Always the same way to react
- Wrong timing
- Going too far out
- Going backwards

- Hiding behind the post
- Hiding behind the hands
- Bending down
- Fear from the ball – learning to use the hands properly; self confidence

- **Cool down activities:** Refer to the unit 5 lesson two.

e. Assessment

Reflect:

- What are basic techniques needed to play handball?
- Which techniques seem to be easier/ difficult to perform?
- Which types of shots use in handball?

Connect:

- Identify different types of dribbling in handball?
- How do you prepare yourself while catching and passing, dribbling, shooting the ball and goalkeeping?
- How are the above basic techniques useful when playing handball?
- Why is important to keep the head-up and eyes looking straight while dribbling?

Apply:

- Which position will you take while performing a jump shot in handball match?
- What will you do to become a good goalkeeper in handball?

Lesson 2: Technical development activities of handball

a. Prerequisites

Learners will learn better this lesson if they are able to perform basic handball techniques learnt in the previous lesson.

b. Teaching resources:

Playground, benches, gymnastics equipment, cones, slalom and any other items available.

c. Introduction

Open discussion: Refers to the unit one lesson one.

Warm-up activities: For the warm-up and stretching activities, refer to the Unit 6 lesson one.

d. Lesson development

Organizing games and exercises in such a way that the learners have the longest possible movement time, as many ball contacts as possible and of course many throws at the goal during the lesson.

In order to get a good result from your teaching it is important that your learners are motivated and understand what they are doing. This task lies on your shoulders! If the exercise is too complicated or too easy the learners will automatically lose the motivation and concentration. That requires a sufficient theoretical knowledge of handball and the ability to organize and plan a handball lesson.

Ball handling exercises

The aim of “ball handling exercises” is to teach the learners basic throwing, catching and dribbling. The exercises described are also used for warming up, ball-eye-hand coordination and developing basic technical/tactical knowledge.

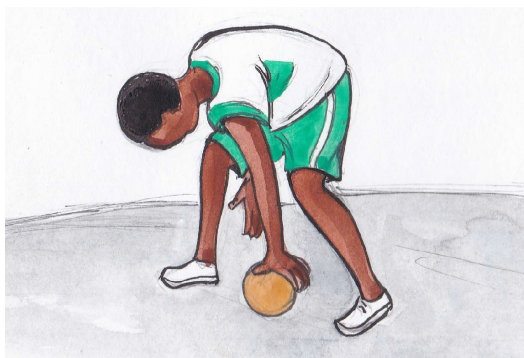

Fast ball handling through the spread legs, moving the hands accordingly

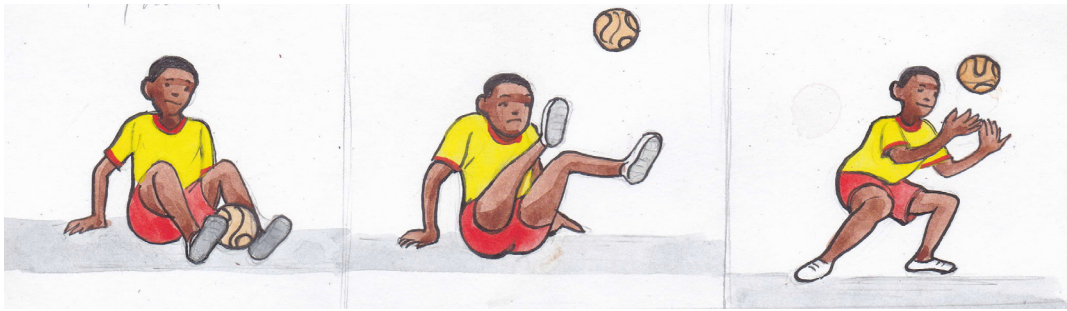

Tossing a ball with the feet while sitting and catching it while standing up

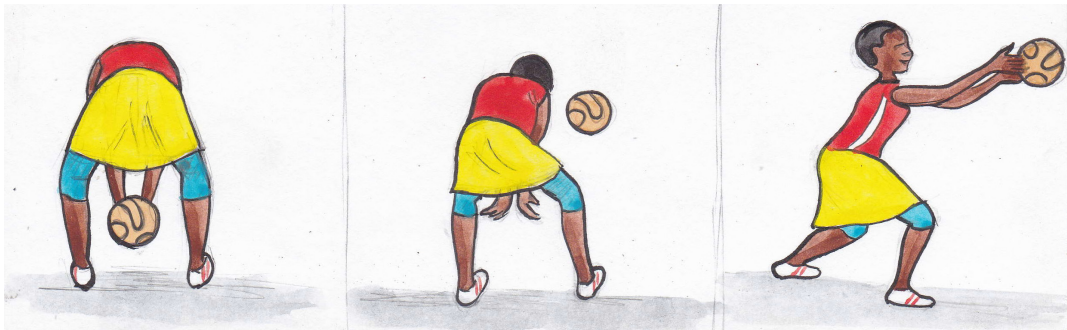

Tossing the ball backwards through the legs, turning around and catching the ball

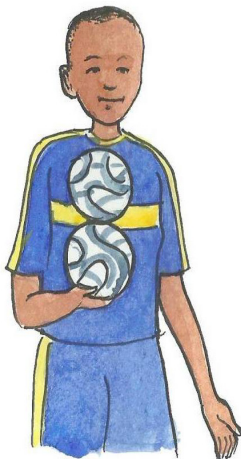

Carrying a ball with a second

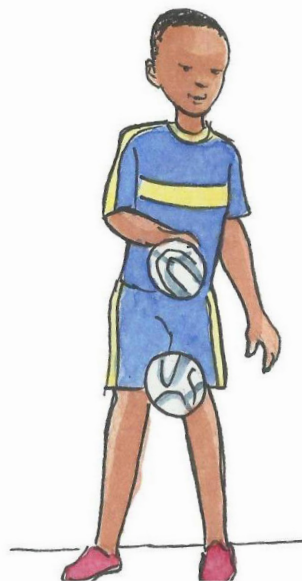

Dribbling the ball with a second one

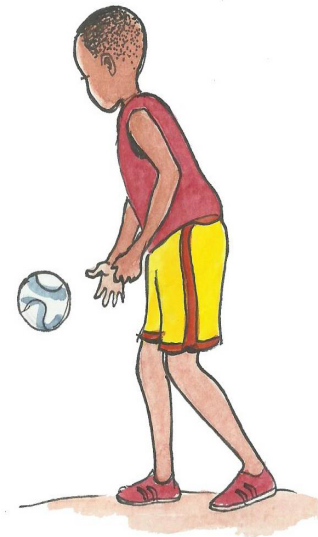

Dribbling around the body

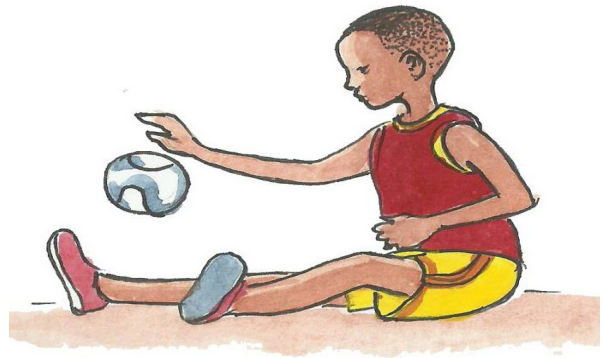

Dribbling while sitting



Dribbling while jumping up and down



Dribbling around/over obstacles



Running after a partner while dribbling and imitating all his moves.

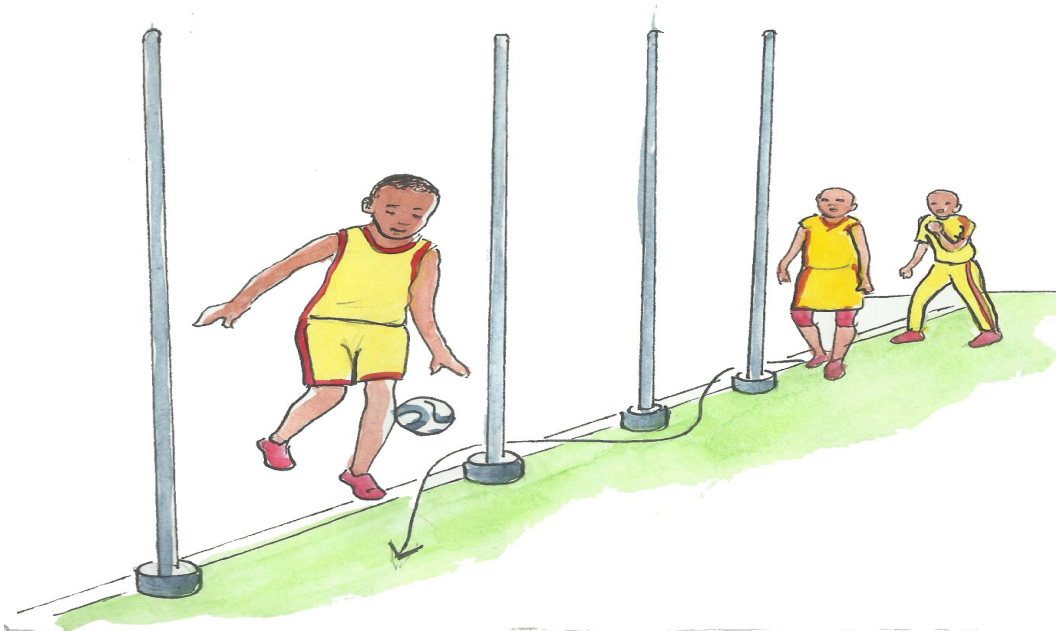

Dribbling through rods in slalom



Bounce passes through a hoop to the partner

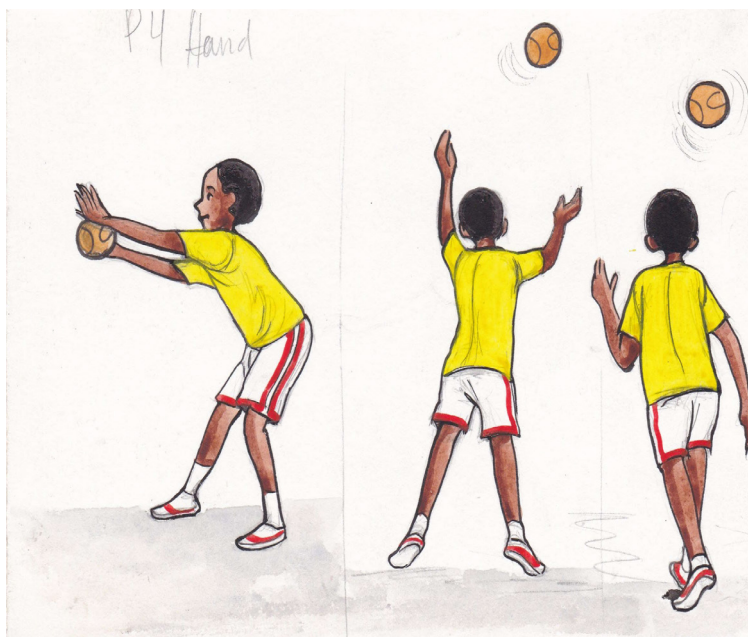

Throwing the ball at the wall and catching it

Exercises that improve throwing and catching while standing and moving as well as the ball-hand-eye coordination.

Passing and catching in a circle: First, one ball is passed, and then two balls are passed at the same time.

Group of 3: Two attackers are passing a ball to each other. The learner in the middle must try to intercept it.

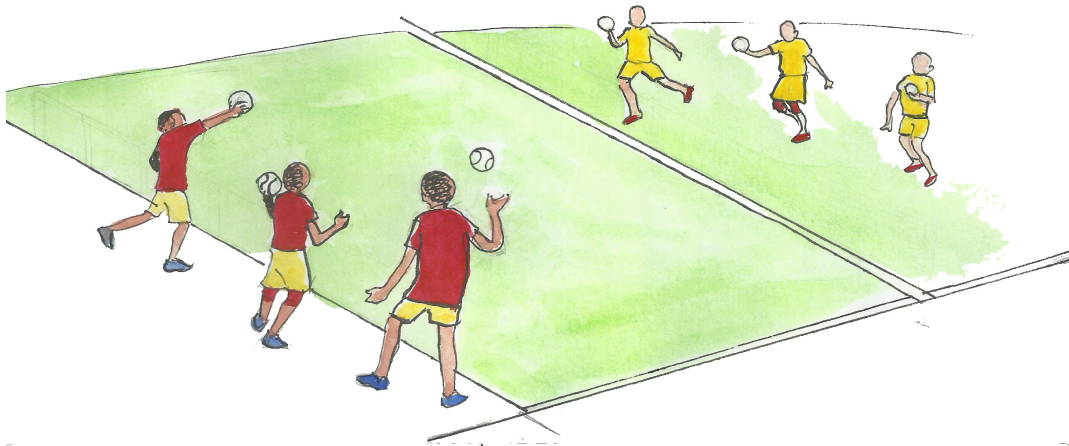

Two teams try to hit a medicine ball over the ground line of the opponent

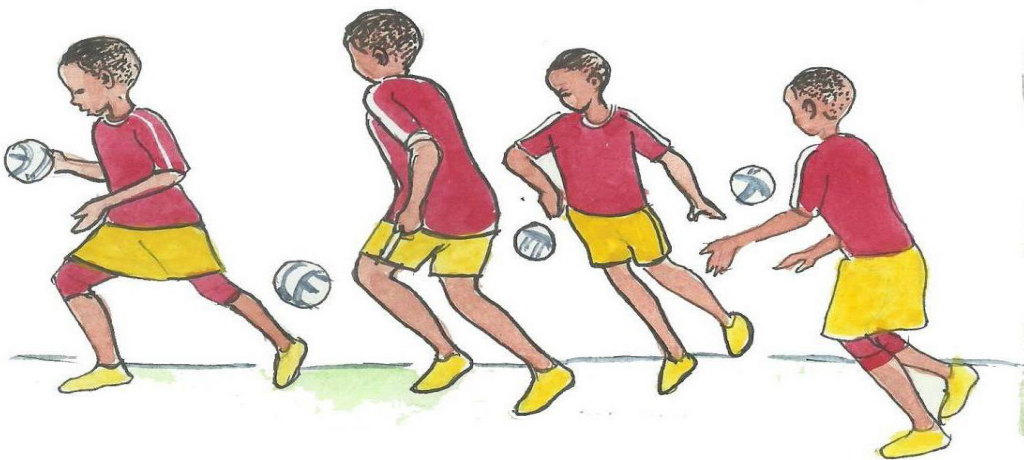

- All the learners take a ball and run around bouncing the ball within a restricted area.
- While they are running around they must keep control of their own ball and at the same time try to knock the other learner's balls out of their control.
- If one loses the ball get it back as quickly as possible and continue to play.
- Learners run around with a ball as above, however, at the teacher's signal, all learner put their ball down, but carry on running around.
- The teacher then removes one ball and at his/her signal all the learners must try to get a ball.
- Learner who doesn't get a ball must run to the other end of the hall and come back, before he/she gets his/her ball back.

Game one: Relay Games

Relay games are a very good form of activity, but all too often they are badly organized with two large groups competing which lead too much inactivity and too much stress on individual competition. In this way, you will be able to greatly increase the level of activity and reduce the prestige of individual competition.

With a little bit of imagination it is possible to vary the exercises by changing the way of running, the way of handling the ball, the number of balls etc.

Game 2: Run-around as group competition

Three groups on three fields carry out the same tasks as a competition between the three groups. The tasks:

- Dribbling three times around a bench (or another marking)
- A forward roll on a mat
- Throwing at the goal from a marking
- Bouncing back and passing to the next learner of the group
- The group with the highest number of goals is the winner.
- Cool down activities: Refer to the unit 5 lesson two.

e. Assessment

Reflect:

- How did you feel when you were performing different exercises/ Why did you feel that way?

Connect:

Have you been disappointed when you were performing exercises/game? What do you do to take care of yourself when you are playing?

Apply:

Which exercises that you are able to demonstrate to your teammate?

What can you do to improve your level of performing different basic techniques of handball?

Lesson 3: Development of body coordination and evaluation of performance level in modified game of handball by following basic rules

a. Prerequisites:

Learners will learn better this lesson if they are able **to practice drills related with handball.**

b. Teaching resources:

playground, whistles, stop watch ,etc

c. Introduction

Open discussion: Refers to the unit one, lesson one and ask learners different questions related with the lesson.

Warm –up activities: For the warm-up and stretching activities refers to the Unit 6 lesson one.

d. Lesson development:

For this lesson, teacher should use different handball related modified which are ideal approaches for the development of the best possible playing skills.

Game 1: Find the light learner

Divide the learners into groups of four. Put one ball into each group. The learners in each group are numbered one to four. The ball is always passed from 1 to 2 to 3 to 4, and back to 1. It is important that the learners circulate as much as possible around the hall while passing the ball.

Game 2: 10 Passes

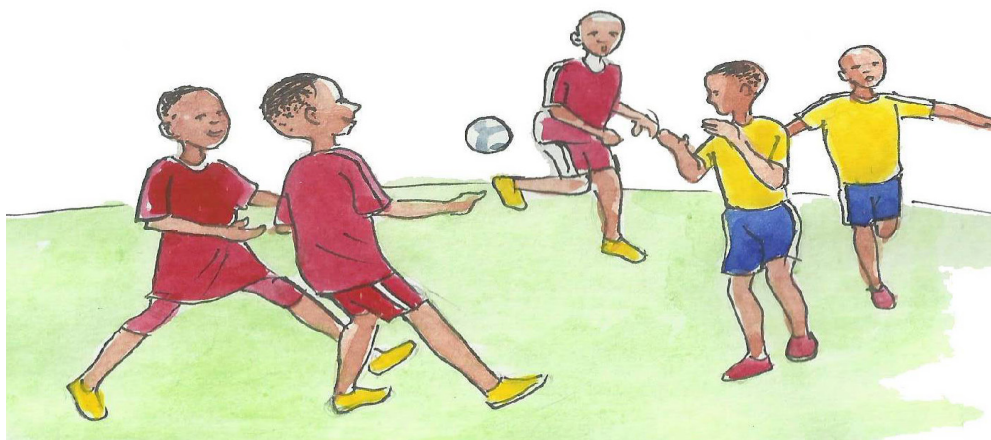

Divide the learners into two groups and put them into a restricted area. Throw the ball in the air to start the game. It is then up to the two groups to try to pass the ball between themselves 10 times. Count the passes with learners out loud. When one

group loses the ball or takes it out of the restricted area then the counting starts for the other group. Every time a group gets to 10 passes, they score one point. Try to use the handball rules as much as possible.

Variations:

- 5 against 4
- 5 against 5 with neutral learners.

Game 3: Tiger ball



Objectives: Steal balls; intercept passes; reaction, cleverness, perception, anticipation. Learners stand in a circle with 2 ‘tigers’ inside the circle.

Those two are trying to intercept the passes. (Credit time or award one point for every ball stolen).

Rules:

- Pass to the learner standing next to oneself is not allowed.
- Passing at head height, direct, indirect, left or right-handed passes are allowed.

Game 4: Hit the box (3 against 3 or 4 against 4)

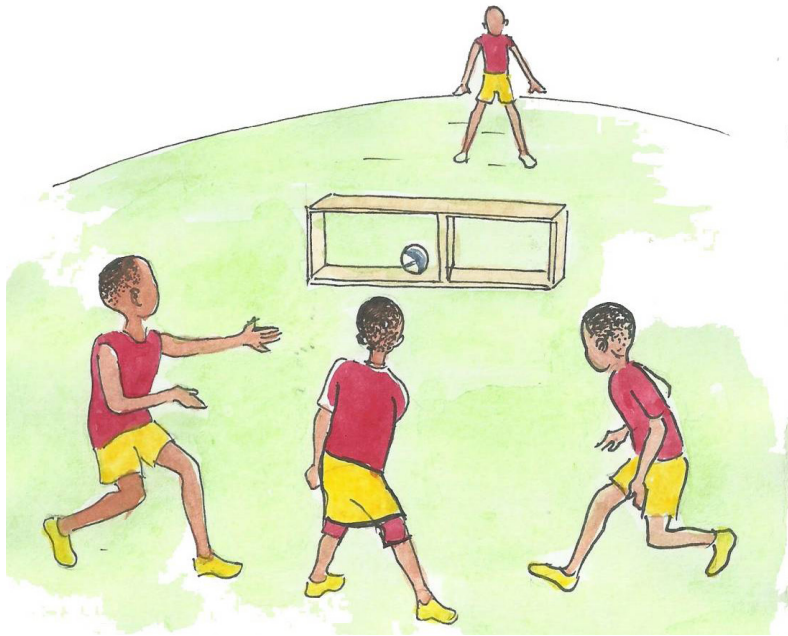

Objectives:

Steal the ball, spoil and intercept passes, spoil goal shots, break free to take up a position suitable for a goal shot; target shot; introduce the 'goal-area rule'.

A middle section of a vaulting box is placed in the middle of a circle measuring 8 to 10m in diameter. Two teams compete outside the circle. In case of numerical inferiority the team concerned remains in possession of the ball within a set time frame (up to 3 min) and tries to score as many goals as possible (shots passing through the box). When the time has expired, take turns. With a balanced number of learners per team (4–4) change position of attack and defense every time the attackers have lost the ball (ball crossed the sideline, too many steps, illegal entering of the goal area, missed shot). If the team in possession of the ball scores a goal, they will remain in possession of the ball. In difficult situations (nobody is in a position to receive a pass) you are entitled to bounce the ball once.

Cool down activities: Refer to the unit 5 lesson two.

e. Assessment

Reflect:

- What are the titles of different modified games you have been playing?
- Which modified game that seems to be easier/ difficult to perform?

Connect: What kind of passes, dribbling have you used in the game?

Apply: Under what situation a team use more than five passes in handball

8.5. End unit assessment

Using different technical development activities and modified games, learners are able to perform handball basic techniques such as pass, catch, dribble, shot the ball, goalkeeping and evaluate one's own and others' performance level and following basic rules.

8.6. Additional activities and games

Game 1: King ball

- Divide the learners into two teams.
- Place the learner on a small box or bench at the other end of the court.
- A team scores a goal, when it passes the ball to the teammate standing on the box or bench.
- The opponents try to intercept the ball and block the passes to the learners on the box/bench.

Variation:

Only score if it is a jump pass or an underhand pass.

Game 2: Interval handball

- Divide the learners into 4 teams, one behind each bench.
- 2 teams play each other diagonally across the hall. The team score when it hits the bench.
- When one team hits the bench, both teams must rush back to their bases leaving the ball.
- The other teams then run out to pick up the ball and start to play.
- Time limit = 1 minute, if no score – change.
- By changing the bench for a chair, the target can be made harder to hit.



UNIT 9: TRANSMITTED DISEASES

9

9.1. Key unit competence

Protect oneself against HIV/AIDS through games and sports.

9.2. Prerequisite knowledge and skills

A learner is able to perform different motor skills involving a range of games and sports, recognise adapted strategies to ensure good health and how to protect oneself against transmitted diseases.

9.3. Cross-cutting issues to be addressed:

Peace and values education: In teaching-learning process the teacher must

- Encourage tolerance, patience, teamwork spirit, mutual help, and respect of opinions of colleagues, obeisance of rules and creation of a more peaceful game situation.
- Increase a sense of cooperative and responsibility among learners
- Improve communication at all levels.
- Tell learners to follow instruction

Gender education: Encourage both girls and boys to participate actively

Inclusive education: In teaching-learning process the teacher must

- Identify learners with special education needs and plan adapted exercises accordingly.
- Involve all learners in all activities without bias.
- Use simple gestures to make learners with hearing impairment understand.

Comprehensive sexuality education: Set instructions that prevent sexual harassment in language and in action during teaching and learning process.

Environment and sustainability: During teaching and learning process, teacher should :

- Explain to the learners the importance of a safe and clean environment for a physical sport activity
- Tell learners to collect all materials used during learning and teaching process
- Avoid throwing away used materials anywhere.

9.4. List of lessons

#	Lesson title	Learning objectives (from the syllabus including knowledge, skills and attitudes):	Number of periods
1	The role of games to increase HIV awareness.	Perform different games TO increase awareness on HIV Inclusion.	1
2	Preventive modes of HIV/ AIDS.	Perform games which help to know different preventive modes of HIV/AIDS.	1
3	Unit assessment		1

Lesson 1: The role of games/sports to increase HIV awareness

a. Prerequisites:

Learners will learn better this lesson if they have basic knowledge related with non-transmitted and transmitted diseases.

b. Teaching resources:

Cones: 1 for each team, beanbags: 1 for each team, plastic bottles: 5 to 6 whistles, plastic balls or locally made balls.

c. Introduction:

- **Open discussion:** Refers to the unit 1 lesson 1.
- **Warm up activities:** For warm up, teacher is advised to use a proposed below game.

Title of the game: Beanbag Bowling

Objective of the game: Developing motor skills and coordination of wide gestures.

Organization and rules of the game

1. Make groups of 3 to 6 learners.
2. Explain that it is a relay race.
3. Place a cone or any marker for every team around the playground (see image).
4. Ask each team to line up behind the cone.
5. Put 5 to 6 bottles in the center of the playground at equal distance from all cones of all the teams.
6. Give a beanbag to each group.
7. Explain and demonstrate:
 - Every learner must have his/her turn
 - He/she must run clockwise around the exterior perimeter of the playground .
 - The first learner A, runs around the markers and turns back to the cone of his/her team. A throws the beanbags and tries to knock over one of the bottles.
 - If he/she knocks it down, the team A gains 5 points. The learner A runs in the middle of the playground to redress the bottle, picks up the beanbags and runs back to give it to the next learner.
 - If A misses his/her throw, he/she picks up the beanbag and passes it to the next learner, who continues the relay race.
 - When you say “Go!” the front learners of each group start the game.
8. The game ends when all the learners have had 2 to 3 turns each.

Points to check

- Do learners try to knock down the bottles with beanbags?
- Do learners pick up the beanbag after having knocked it down?
- Do they stand near their cones when throwing the beanbags?

d. Lesson development:

The role of games/sports is to increase HIV/AIDS awareness.

Name of the game: Ball tag

Learners get letters assigned to them that spell out “HIV”

What you need

Soft balls/plastic balls, learners: 6 or more

How to play

- Make sure playing area is safe
- Divide learners into teams of 6-8 teams
- Ask each group to stand in a circle
- Make flashcards of HIV/AIDS symptoms and letters that make HIV/AIDS
- Explain and demonstrate different symptoms of HIV/AIDS (Some examples of HIV/AIDS symptoms: headache, tiredness, mouth ulcers, rash, sore throat, night sweats, etc.)
- Ask each child to pick one symptom displayed inside of the circle and play the role of that symptom.
- Ask the learners to announce the symptom they chose (Encourage each child to pick a different symptoms.)
- Ask for one volunteer from each group. Give each volunteer a ball.
- Explain and demonstrate that:
 - The ball represents a “HIV”
 - The volunteer will start the game by throwing the ball into the air and calling out a symptom.
 - As soon as the ball is thrown, all of the learners will scatter except for the child whose symptom was called. This learner must try to catch the ball as quickly as possible.
 - After catching the ball, the child will yell “Stop!” and all the learners must freeze where they are. The child who has the “HIV” must then try to hit the nearest child with the ball. Learner must throw gently and hit below the shoulders. If a child is hit, that child gets an “H” and becomes the next caller. If the thrower misses the person, the thrower receives a “H.”
 - Each child will play the game and try to avoid collecting enough letters to spell the word “HIV”

- Every time a child is hit by a ball or the thrower misses, the child earns a letter in the word “HIV/AIDS”
- The thrower becomes the next person to call out a symptom.
- The game finishes at your discretion.
- Ensure the play area is free of obstructions.

Watch For

- Are the learners remembering the symptom they were assigned?
- Are all the learners engaged and participating?

Variations

Call more than one symptom to catch the ball.

Game two: HIV knock down

Learners throw a ball to the bottles representing different HIV transmission modes: unprotected sexual intercourse, sharing needles or other materials used for injection, mother to child transmission, etc.

What You Need

- Balls (3 per team)
- Bottles, cones or sticks (anything that will fall over when hit by a ball) – 6-10 for each team
- Chalk (anything to mark the start line)
- 6 learners or more

How to Play

1. Mark a start line using chalk or markers.
2. Divide learners into teams of 6-8.
3. Ask each team to line up behind the start line.
4. Place 6-10 bottles on the ground (standing upright) approximately 5-10 meters away from each team (see diagram).
5. Tell the learners that these bottles represent HIV transmission modes.
6. Ask the learners if they know of anything about HIV transmission modes
7. Give each team 3 balls.
8. Explain and demonstrate that:
 - Each child will take a turn throwing 3 balls from the start line to knock down the bottles.
 - Once the balls are thrown, the child must run to retrieve them and stand up the bottles again and talk about HIV transmitted mode written on that bottles.

- The child returns to the start line, the next child can throw at the bottles.
9. Continue the game until all learners have had at least 2-3turns.

Watch For

- Are the learners throwing the balls from the start line?
- Are the learners collecting the balls and standing up the bottles after their turns?
- Are the learners understand the explanations

e. Assessment :

Reflect

- What are some symptoms of a HIV/AIDS we used in this game?

Connect

- Does anyone know different HIV/AIDS symptoms?
- Is it enough to only rely on HIV/AIDS symptoms to confirm that one is HIV/AIDS positive?

Apply

- What can you do if you are taking care of someone who has a HIV/AIDS?

Lesson 2: Preventive modes of HIV/AIDS

a. Prerequisites

Learners will learn better this lesson if they are able to identify different ways of HIV transmission.

b. Teaching resources:

Playground /classroom, stopwatch.

c. Introduction

Opening discussion: Refers to the unit 1 lesson,

Warm up activities: Refers to the lesson one.

d. Lesson development

Name of the game: Go with the flow.

A guessing game in which a player called the “HIV catcher” tries to guess who HIV is. The HIV is the one to give a sign secretly to the learners to talk about different HIV preventive modes.

What You Need

No. of learners: 6 or more

How to play

1. Ask the group to raise their hands if know different HIV preventive modes.
2. Explain and demonstrate the following preventive modes:
 - Abstinence(not having sex)
 - Use condoms in the right way every time you have sex
 - Limiting the number of your sexual partner.
 - Never sharing needles.
3. Ask the learners to demonstrate what you have just shown them.
4. Divide the learners into groups of 6-10.
5. Ask each group to form a circle.
6. Ask for one volunteer to be the HIV Catcher.
 - The HIV Catcher leaves the room or closes their eyes while the group chooses the HIV.
 - The HIV Catcher then comes back into the room (or opens their eyes).
7. Explain and demonstrate that:
 - The object of the game is for the HIV to make direct eye contact with other learners and twitch the nose (or any other secret sign you agree with). If a child receives a sign you agreed with from the HIV, the child must explain what to do as HIV preventive mode.

8. The HIV must try to twitch the Nose at all players before the HIV Catcher discovers who the HIV is.
 - It is the job of the HIV Catcher to figure out who the HIV is.
 - The HIV Catcher has three chances to guess who the HIV is.
9. Once the game is finished, the player who was the HIV becomes the new HIV Catcher for the next round.

Watch for:

- After being signalled by the HIV, are the learners correctly explaining different HIV preventive modes?

e. Assessment

Reflect:

- How did you feel when you were the HIV Catcher?
- What did you do when the HIV twitched his/her nose at you?

Connect

- Is it possible to spread HIV through touching? How?
- How can you advise someone to prevent against HIV?

Apply

- What are some things you can do to prevent yourself from getting a HIV in the future?
- If you do get a HIV/AIDS, what can you do to help yourself get better?
- What can you do if you are taking care of someone who has a HIV?

9.5. Additional information

HIV (human immunodeficiency virus): Is a lentivirus (a subgroup of retrovirus) that causes HIV infection and over time acquired immunodeficiency syndrome (AIDS).

AIDS: Is a condition in humans in which progressive failure of the immune system allows life-threatening opportunistic infections and cancers to thrive. Without treatment, average survival time after infection with HIV is estimated to be 9 to 11 years, depending on the HIV subtype. In most cases, HIV is a sexually transmitted infection and occurs by contact with or transfer of blood, pre-ejaculate, semen, and vaginal fluids. Non-sexual transmission can occur from an infected mother to her infant through breast milk. An HIV-positive mother can transmit HIV to her baby both during pregnancy and childbirth due to exposure to her blood or vaginal fluid. Within these bodily fluids, HIV is present as both free virus particles and virus within infected immune cells.

Activities That Put You at Risk for HIV Infection

- Sexual contact that involves semen, pre-cum, vaginal fluids or blood.
- Direct blood contact, particularly through sharing injection drug needles or 'works' (cotton, cookers, etc).
- Infections due to blood transfusions, accidents in health care settings or certain blood products. This is possible, although extremely rare.
- Mother to baby (before or during birth, or while breastfeeding through breast milk)

Sexual intercourse (vaginal): Unprotected vaginal intercourse is high-risk activities. In the penis, vagina, HIV may enter through cuts and sores (many of which would be very small and hard to notice), or directly through the mucus membranes.

Sharing injection needles or works: Sharing needles or other materials used for injecting is considered a high-risk practice. Injection needles can pass blood directly from one person to another if you share them. If a person with HIV injects with a needle then shares it with another person, the second person is at very high risk for getting HIV.

Mother to Child: Mother to child transmission is now rare in the U.S. and other high-income countries because pregnant women who are HIV-positive are normally given medications to prevent the fetus from getting infected. However, it is possible for an HIV-infected mother to transmit HIV before or during birth or through breast milk. Breast milk contains HIV, and while small amounts of breast milk do not pose significant threat of infection to adults, it is a risk for infants.

Bodily Fluids that are NOT infectious:

- Saliva / spit
- Tears
- Sweat
- Feces / poop
- Urine / pee

9.6. End unit assessment

Within different game situation learners are able to identify the ways that a person can be infected by HIV and demonstrate different HIV preventive modes.

REFERENCES

1. MIJESCAFOP, UNICEF, and MINEDUC (1999). Guide pour Animateur Pédagogique en Education Physique et Sportive à l'Ecole Primaire. MINEDUC.
2. REPUBLIC OF UGANDA, MINISTRY OF EDUCATION,1997, Module CE/2-Part2 Physical Education.
3. Right to Play. (2008). Health Game. Right To Play.
4. REB, July 2015, Teacher training Manual.
5. Right to Play.(2008). Le Programme de Ballon Rouge. Right To Play
- 6, REB, Kigali 2015, upper primary physical education and sports syllabus
7. REB, August 2012, Pedagogical Guide of PES - P4 up to P6.
8. Cezar Hantau & Cristina Hantau, 2014. **“Study Concerning The Effectiveness Of Handball Goalkeeper At The 7 M Throws,”** Marathon, Department of Pshisycal Education and Sport, Academy of Economic Studies, Bucharest, Romania, vol. 6(1), pages 27-31, Iunie.
9. **Vanja Radic,(2017) BASICS OF HANDBALL GOALKEEPING-Methodology of training young goalkeepers .**
10. **Mr. Nabeel Taha, PHF Expert: Joanna Franquelli (October):Handball at school, www.ihf.in.**
11. **Beverly Oden: <http://www.thoughtco.com/the-ready-position-in-volleyball-3528852.updatedjuly232017>.**
12. <https://www.google.com/search?q=warm+exercises+before+running&ie=utf-8&oe=utf>
13. <https://www.self.com/gallery/essential-stretches-slideshow>
14. [https:// m.wikihow.com/DO-a-forward-roll/retrieved on 25/03/2018](https://m.wikihow.com/DO-a-forward-roll/retrieved%20on%2025/03/2018)
15. <https://www.onnit.com/academy/the-top-5-exercises-for-rope-climbing/>
16. <://sfaf.org/hiv-info/basics/how-is-hiv-transmitted.html>
17. <https://en.wikipedia.org/wiki/HIV>
18. www.vanjaradic.fi/articles/
- 19.www.youtube.com/user/HandballGoalkeeper

20. www.facebook.com/HandballGoalkeeperCoaching/(Youtube channel with many different specific goalkeeper drills and exercises)

21. <https://www.theguardian.com/science/neurophilosophy/2014/aug/18/muller-lyer-illusion-goalkeeping>

22. <https://www.breakthroughbasketball.com/fundamentals/passing.html>