

BIOLOGY

for Rwanda Schools

Teacher's Guide

Senior 5

© 2020 Rwanda Education Board

All rights reserved.

This book is property of the Government of Rwanda.

Credit must be given to REB when the content is quoted.

CONTENTS

| | |
|---|--------------|
| Preface | (xi) |
| Introduction to the Teacher's Guide | (xiii) |
| Content Map | (xxix) |
| Unit 1: Interdependence between Organisms within their Environment | 1–22 |
| 1.1 Learning Objectives | 1 |
| 1.2 Sample Lesson Plan | 2 |
| 1.3 Teaching Aids | 8 |
| 1.4 Teacher's Tip | 8 |
| 1.5 Teaching Methods | 8 |
| 1.6 Teaching and Learning Materials | 8 |
| 1.7 Teaching Methodology | 9 |
| 1.8 Additional Content for the Teacher | 9 |
| 1.9 Summary | 10 |
| 1.10 Weblinks for Content Enrichment | 11 |
| 1.11 Learners' Activities | 11 |
| 1.12 Answers to Self-evaluation | 13 |
| 1.13 Answers to End Unit Assessment | 14 |
| 1.14 Assessment Methods | 22 |
| 1.15 Assessments | 22 |
| Unit 2: Transport Across the Cell Membrane | 23–34 |
| 2.1 Learning Objectives | 23 |
| 2.2 Teaching Aids | 23 |
| 2.3 Teacher's Tip | 24 |
| 2.4 Teaching Methods | 24 |
| 2.5 Teaching and Learning Materials | 24 |
| 2.6 Teaching Methodology | 24 |
| 2.7 Additional Content for the Teacher | 25 |
| 2.8 Summary | 26 |
| 2.9 Weblinks for Content Enrichment | 27 |
| 2.10 Learners' Activities | 27 |
| 2.11 Answers to Self-evaluation | 28 |
| 2.12 Answers to End Unit Assessment | 28 |

| | | |
|----------------|--------------------------------------|---------------|
| 2.13 | Assessment Methods | 34 |
| 2.14 | Assessments | 34 |
| Unit 3: | Chromosomes and Nucleic Acids | 35–54 |
| 3.1 | Learning Objectives | 35 |
| 3.2 | Teaching Aids | 35 |
| 3.3 | Teacher’s Tip | 36 |
| 3.4 | Teaching Methods | 36 |
| 3.5 | Teaching and Learning Materials | 36 |
| 3.6 | Teaching Methodology | 36 |
| 3.7 | Additional Content for the Teacher | 36 |
| 3.8 | Summary | 37 |
| 3.9 | Weblinks for Content Enrichment | 39 |
| 3.10 | Learners’ Activities | 39 |
| 3.11 | Answers to Self-evaluation | 41 |
| 3.12 | Answers to End Unit Assessment | 42 |
| 3.13 | Assessment Methods | 54 |
| 3.14 | Assessments | 54 |
| Unit 4: | DNA Replication | 55–75 |
| 4.1 | Learning Objectives | 55 |
| 4.2 | Teaching Aids | 56 |
| 4.3 | Teacher’s Tip | 56 |
| 4.4 | Teaching Methods | 56 |
| 4.5 | Teaching and Learning Materials | 56 |
| 4.6 | Teaching Methodology | 56 |
| 4.7 | Additional Content for the Teacher | 57 |
| 4.8 | Summary | 58 |
| 4.9 | Weblinks for Content Enrichment | 59 |
| 4.10 | Learners’ Activities | 59 |
| 4.11 | Answers to Self-evaluation | 62 |
| 4.12 | Answers to End Unit Assessment | 63 |
| 4.13 | Assessment Methods | 75 |
| 4.14 | Assessments | 75 |
| Unit 5: | Cell and Nuclear Division | 75–104 |
| 5.1 | Learning Objectives | 75 |
| 5.2 | Teaching Aids | 76 |
| 5.3 | Teacher’s Tip | 76 |

| | | |
|----------------|------------------------------------|----------------|
| 5.4 | Teaching Methods | 76 |
| 5.5 | Teaching and Learning Materials | 76 |
| 5.6 | Teaching Methodology | 77 |
| 5.7 | Additional Content for the Teacher | 77 |
| 5.8 | Summary | 78 |
| 5.9 | Weblinks for Content Enrichment | 79 |
| 5.10 | Learners' Activities | 79 |
| 5.11 | Answers to Self-evaluation | 87 |
| 5.12 | Answers to End Unit Assessment | 87 |
| 5.13 | Assessment Methods | 104 |
| 5.14 | Assessments | 104 |
| Unit 6: | Protein Synthesis | 105–142 |
| 6.1 | Learning Objectives | 105 |
| 6.2 | Teaching Aids | 106 |
| 6.3 | Teacher's Tip | 106 |
| 6.4 | Teaching Methods | 106 |
| 6.5 | Teaching and Learning Materials | 106 |
| 6.6 | Teaching Methodology | 106 |
| 6.7 | Additional Content for the Teacher | 107 |
| 6.8 | Summary | 114 |
| 6.9 | Weblinks for Content Enrichment | 116 |
| 6.10 | Learners' Activities | 116 |
| 6.11 | Answers to Self-evaluation | 125 |
| 6.12 | Answers to End Unit Assessment | 126 |
| 6.13 | Assessment Methods | 142 |
| 6.14 | Assessments | 142 |
| Unit 7: | Autotrophic Nutrition | 143–167 |
| 7.1 | Learning Objectives | 143 |
| 7.2 | Teaching Aids | 144 |
| 7.3 | Teacher's Tip | 144 |
| 7.4 | Teaching Methods | 144 |
| 7.5 | Teaching and Learning Materials | 144 |
| 7.6 | Teaching Methodology | 144 |
| 7.7 | Additional Content for the Teacher | 145 |
| 7.8 | Summary | 146 |
| 7.9 | Weblinks for Content Enrichment | 146 |

| | | |
|----------------|------------------------------------|----------------|
| 7.10 | Learners' Activities | 147 |
| 7.11 | Answers to Self-evaluation | 153 |
| 7.12 | Answers to End Unit Assessment | 154 |
| 7.13 | Assessment Methods | 167 |
| 7.14 | Assessments | 167 |
| Unit 8: | Transport System in Plants | 168–184 |
| 8.1 | Learning Objectives | 168 |
| 8.2 | Teaching Aids | 169 |
| 8.3 | Teacher's Tip | 169 |
| 8.4 | Teaching Methods | 169 |
| 8.5 | Teaching and Learning Materials | 169 |
| 8.6 | Teaching Methodology | 170 |
| 8.7 | Additional Content for the Teacher | 170 |
| 8.8 | Summary | 172 |
| 8.9 | Weblinks for Content Enrichment | 173 |
| 8.10 | Learners' Activities | 173 |
| 8.11 | Answers to Self-evaluation | 176 |
| 8.12 | Answers to End Unit Assessment | 176 |
| 8.13 | Assessment Methods | 184 |
| 8.14 | Assessments | 184 |
| Unit 9: | Gas Exchange in Animals | 185–212 |
| 9.1 | Learning Objectives | 185 |
| 9.2 | Teaching Aids | 186 |
| 9.3 | Teacher's Tip | 186 |
| 9.4 | Teaching Methods | 186 |
| 9.5 | Teaching and Learning Materials | 186 |
| 9.6 | Teaching Methodology | 186 |
| 9.7 | Additional Content for the Teacher | 187 |
| 9.8 | Summary | 189 |
| 9.9 | Weblinks for Content Enrichment | 190 |
| 9.10 | Learners' Activities | 190 |
| 9.11 | Answers to Self-evaluation | 197 |
| 9.12 | Answers to End Unit Assessment | 198 |
| 9.13 | Assessment Methods | 212 |
| 9.14 | Assessments | 212 |

| | |
|---|----------------|
| Unit 10: Smoking and Related Diseases | 213–227 |
| 10.1 Learning Objectives | 213 |
| 10.2 Teaching Aids | 213 |
| 10.3 Teacher’s Tip | 213 |
| 10.4 Teaching Methods | 213 |
| 10.5 Teaching and Learning Materials | 213 |
| 10.6 Teaching Methodology | 214 |
| 10.7 Additional Content for the Teacher | 214 |
| 10.8 Summary | 215 |
| 10.9 Weblinks for Content Enrichment | 216 |
| 10.10 Learners’ Activities | 216 |
| 10.11 Answers to Self-evaluation | 217 |
| 10.12 Answers to End Unit Assessment | 218 |
| 10.13 Assessment Methods | 227 |
| 10.14 Assessments | 227 |
| | |
| Unit 11: General Principles of Homeostasis | 228–243 |
| 11.1 Learning Objectives | 228 |
| 11.2 Teaching Aids | 228 |
| 11.3 Teacher’s Tip | 228 |
| 11.4 Teaching Methods | 229 |
| 11.5 Teaching and Learning Materials | 229 |
| 11.6 Teaching Methodology | 229 |
| 11.7 Additional Content for the Teacher | 229 |
| 11.8 Summary | 230 |
| 11.9 Weblinks for Content Enrichment | 231 |
| 11.10 Learners’ Activities | 231 |
| 11.11 Answers to Self-evaluation | 232 |
| 11.12 Answers to End Unit Assessment | 232 |
| 11.13 Assessment Methods | 243 |
| 11.14 Assessments | 243 |
| | |
| Unit 12: Regulation of Glucose | 244–266 |
| 12.1 Learning Objectives | 244 |
| 12.2 Teaching Aids | 245 |
| 12.3 Teacher’s Tip | 245 |
| 12.4 Teaching Methods | 245 |
| 12.5 Teaching and Learning Materials | 245 |

| | | |
|--|------------------------------------|----------------|
| 12.6 | Teaching Methodology | 245 |
| 12.7 | Additional Content for the Teacher | 246 |
| 12.8 | Summary | 247 |
| 12.9 | Weblinks for Content Enrichment | 248 |
| 12.10 | Learners' Activities | 248 |
| 12.11 | Answers to Self-evaluation | 253 |
| 12.12 | Answers to End Unit Assessment | 254 |
| 12.13 | Assessment Methods | 266 |
| 12.14 | Assessments | 266 |
| Unit 13: Regulation of Temperature | | 267–291 |
| 13.1 | Learning Objectives | 267 |
| 13.2 | Teaching Aids | 267 |
| 13.3 | Teacher's Tip | 268 |
| 13.4 | Teaching Methods | 268 |
| 13.5 | Teaching and Learning Materials | 268 |
| 13.6 | Teaching Methodology | 268 |
| 13.7 | Additional Content for the Teacher | 268 |
| 13.8 | Summary | 269 |
| 13.9 | Weblinks for Content Enrichment | 271 |
| 13.10 | Learners' Activities | 271 |
| 13.11 | Answers to Self-evaluation | 274 |
| 13.12 | Answers to End Unit Assessment | 274 |
| 13.13 | Assessment Methods | 291 |
| 13.14 | Assessments | 291 |
| Unit 14: Behaviour and Responses in Mammals | | 292–311 |
| 14.1 | Learning Objectives | 292 |
| 14.2 | Teaching Aids | 293 |
| 14.3 | Teacher's Tip | 293 |
| 14.4 | Teaching Methods | 293 |
| 14.5 | Teaching and Learning Materials | 293 |
| 14.6 | Teaching Methodology | 293 |
| 14.7 | Additional Content for the Teacher | 294 |
| 14.8 | Summary | 294 |
| 14.9 | Weblinks for Content Enrichment | 295 |
| 14.10 | Learners' Activities | 295 |
| 14.11 | Answers to Self-evaluation | 299 |

| | | |
|---|------------------------------------|----------------|
| 14.12 | Answers to End Unit Assessment | 299 |
| 14.13 | Assessment Methods | 311 |
| 14.14 | Assessments | 311 |
| Unit 15 : Immune System, Vaccination and Antibiotics | | 312–334 |
| 15.1 | Learning Objectives | 312 |
| 15.2 | Teaching Aids | 313 |
| 15.3 | Teacher’s Tip | 313 |
| 15.4 | Teaching Methods | 313 |
| 15.5 | Teaching and Learning Materials | 313 |
| 15.6 | Teaching Methodology | 313 |
| 15.7 | Additional Content for the Teacher | 314 |
| 15.8 | Summary | 314 |
| 15.9 | Weblinks for Content Enrichment | 316 |
| 15.10 | Learners’ Activities | 316 |
| 15.11 | Answers to Self-evaluation | 323 |
| 15.12 | Answers to End Unit Assessment | 323 |
| 15.13 | Assessment Methods | 334 |
| 15.14 | Assessments | 334 |
| Unit 16: Human Reproductive System and Gametogenesis | | 335–353 |
| 16.1 | Learning Objectives | 335 |
| 16.2 | Teaching Aids | 335 |
| 16.3 | Teacher’s Tip | 335 |
| 16.4 | Teaching Methods | 336 |
| 16.5 | Teaching and Learning Materials | 336 |
| 16.6 | Teaching Methodology | 336 |
| 16.7 | Additional Content for the Teacher | 336 |
| 16.8 | Summary | 338 |
| 16.9 | Weblinks for Content Enrichment | 339 |
| 16.10 | Learners’ Activities | 340 |
| 16.11 | Answers to Self-evaluation | 342 |
| 16.12 | Answers to End Unit Assessment | 343 |
| 16.13 | Assessment Methods | 353 |
| 16.14 | Assessments | 353 |

| | |
|---|----------------|
| Unit 17: Genetics | 354–377 |
| 17.1 Learning Objectives | 354 |
| 17.2 Teaching Aids | 355 |
| 17.3 Teacher’s Tip | 355 |
| 17.4 Teaching Methods | 355 |
| 17.5 Teaching and Learning Materials | 355 |
| 17.6 Teaching Methodology | 356 |
| 17.7 Additional Content for the Teacher | 356 |
| 17.8 Summary | 357 |
| 17.9 Weblinks for Content Enrichment | 358 |
| 17.10 Learners’ Activities | 358 |
| 17.11 Answers to Self-evaluation | 364 |
| 17.12 Answers to End Unit Assessment | 365 |
| 17.13 Assessment Methods | 377 |
| 17.14 Assessments | 377 |
| | |
| Unit 18: Mutations | 378–402 |
| 18.1 Learning Objectives | 378 |
| 18.3 Teacher’s Tip | 379 |
| 18.4 Teaching Methods | 379 |
| 18.5 Teaching and Learning Materials | 379 |
| 18.6 Teaching Methodology | 379 |
| 18.7 Additional Content for the Teacher | 379 |
| 18.8 Summary | 380 |
| 18.9 Weblinks for Content Enrichment | 381 |
| 18.10 Learners’ Activities | 382 |
| 18.11 Answers to Self-evaluation | 387 |
| 18.12 Answers to End Unit Assessment | 387 |
| 18.13 Assessment Methods | 402 |
| 18.14 Assessments | 402 |

PREFACE

This Teacher's Guide has been developed to accompany **Biology for Rwanda Schools Student's Book for Senior 5**.

It provides:

- details of units and sub-units covered in the syllabus of Biology.
- aims and objectives of Biology.
- a suggested lesson plan for effective time management.
- a detailed content map.
- different methods of teaching.
- a list of materials needed for learning activities in the unit.
- suggested weblinks that have additional content for the teacher.
- useful tips for the teacher.
- methods of assessment and evaluation in Biology.
- solutions to the in-text Activities, Self Evaluation and Unit Review Exercises.

Any suggestions for the improvement of this guide would be gratefully acknowledged.

— **Authors**

INTRODUCTION TO THE TEACHER'S GUIDE

The purpose of this teacher's guide is to help you, the teacher of Biology to implement the Biology syllabus. It is designed to stimulate you to create exciting and meaningful teaching programmes and lessons by enabling you to choose relevant and purposeful teaching activities. It will encourage you to research and look for new and challenging ways of facilitating students' learning in Biology.

The Teacher's Guide provides direction for you to use the competence-based approach in your classroom. It provides examples of teaching and learning strategies for Biology and examples of assessment tasks and activities. Teaching and learning is focused on student learning. Activities in the classroom and laboratory are designed to help the students achieve the key unit competences. This teacher's guide will enhance your creativity and help you develop teaching level programmes, and meaningful and interesting lessons.

THE COMPETENCE-BASED APPROACH

A competence-based approach takes learning to higher levels by providing challenging and engaging learning experiences which require deep thinking rather than just memorisation. This is an approach where teaching and learning is based on discrete skills rather than dwelling on only knowledge or the cognitive domain of learning. Its focus is on what young people can do rather than just on what they know. This approach addresses the learners' individual needs, interests, abilities and backgrounds, creating an environment where learning activities are organized in a way that encourages the learners to construct the knowledge either individually or in groups in an active way. With the help of the teachers, whose role is central to the success of the syllabus, the learners gain appropriate skills and the ability to apply what they have learned in real life situations. Thus, they become able to make a difference not only to their own lives but also to the success of the nation.

RATIONALE OF TEACHING AND LEARNING BIOLOGY

Biology is the study of life and it plays a crucial role in our everyday existence. Biology has many applications, both in the natural environment and in health and education. Studying biology develops an understanding of living systems and of how to apply learning in direct ways to maintain the health of humans, animals and

plants. Biology enables us to understand the relationships between living organisms and what is beneficial and what is harmful. Technological advances in new areas, such as DNA and genetics, have made this varied discipline more exciting than ever.

Biology and society

Biology is one of the natural science subjects and is an important discipline that has contributed significantly to the global environment. Biologists are at the forefront of genetic engineering and health transformation and a number of major developments in these areas are due to the discoveries of biologists. The work of biologists have led to new technologies in the production of small scale and industrial products that are beneficial to man and the environment. Application of the knowledge of biology is evident in medicine, pharmacy, agriculture, fisheries and food processing industries. In particular, biology has played a role in the harmonisation of man's needs with the conservation of nature and the environment.

Biology plays a role in Rwanda's ambition to:

- Develop a competence-based society.
- Promote science and technology competitiveness in regional and global job markets.
- Address the issues concerning lack of appropriate skills in the Rwandan education system.

Biology and learners

Biology is a worthwhile subject because it prepares students for the real world of work through career pathways such as medicine, agriculture, pharmacy, food science, environmental studies and many others. Biology provides the skills that guide on construction of theories and laws that help to explain natural phenomenon and manage man and the environment. It provides solutions to the problems faced by our modern society by empowering the students to be creative, innovative and to use independent approaches to solve problems in unfamiliar situations.

Competences

A competence is the ability to perform a particular task successfully, resulting from having gained an appropriate combination of knowledge, skills and attitudes. The national policy documents, based on the national aspirations, identify 'Basic Competences' alongside the 'Generic Competences' that will develop higher order

thinking skills. Basic Competences are addressed in the stated **broad subject competences** and in objectives highlighted on a year on year basis and in each of the units of learning. The selection of types of learning activities must focus on how learners are able to demonstrate such competences throughout and at the end of the learning process. A Generic Competence is a competence that is not specific to a particular subject or situation. Generic Competences are transferrable and applicable to a range of subjects and situations, including employment. The core competences that must be emphasised and reflected in the learning process are briefly described below and teachers will ensure that learners are exposed to the tasks that help them acquire such skills.

(a) Generic competences

Critical thinking and problem-solving skills: The acquisition of such skills will help the learners think imaginatively and broadly to evaluate and find solutions to problems encountered in all situations.

Creativity and innovation: The acquisition of such skills will help the learners take initiative and use imagination beyond the knowledge provided to generate new ideas and construct new concepts.

Research: This will help the learners find answers to the questions based on existing information and concepts and to explain the phenomena based on findings from information gathered.

Communication in official languages: Teachers, irrespective of not being teachers of language, will ensure the proper use of the language of instruction by learners. This will help the learners communicate clearly and confidently and convey their ideas effectively through speaking and writing and use the correct language structure with relevant vocabulary.

Cooperation, inter-personal management and life skills: This will help the learner to cooperate with others in a team in whatever tasks are assigned and to practise positive ethical moral values and respect for the rights, feelings and views of others. Learners will perform practical activities related to environmental conservation and protection. They will also advocate for personal, family and community health, hygiene and nutrition and respond creatively to a variety of challenges encountered in life.

Lifelong learning: The acquisition of such skills will help the learners to update their knowledge and skills with minimum external support and to cope with the evolution of advances in knowledge for personal fulfilment in areas that need improvement and development.

(b) Broad biology syllabus competences

The syllabus competences listed below describe the educational purposes of a course based on this syllabus. It outlines the educational context in which the syllabus content should be viewed. These competences are the same for all learners and are not listed in order of priority. Some of these competences may be delivered by the use of suitable local, international or historical examples and applications, or through collaborative experimental work.

Learners should be able to:

1. Stimulate the learners and create a sustained interest in biology so that the study of the subject is made enjoyable and satisfying.
2. Provide, through well-designed studies of experimental and practical biological science, a worthwhile educational experience for all learners, whether or not they go on to study science beyond this level. In particular, it should enable them to:
 - Become confident citizens in a technological world, with an informed interest in scientific matters.
 - Recognise the usefulness, and limitations, of scientific method and its application in other subjects and in everyday life.
 - Be suitably prepared for studies in biological science beyond the Rwandan Advanced Level, in further or higher education, and for professional courses.
3. Develop abilities and skills that:
 - Are relevant to the study and practice of biological science.
 - Are useful in everyday life.
 - Encourage efficient and safe practice.
 - Encourage effective communication using universal scientific conventions.
 - Protect themselves against common illnesses and fatal diseases, including HIV/AIDS and malaria.
4. Develop attitudes and values relevant to biological science such as:
 - A concern for accuracy and precision, objectivity, integrity, a spirit of enquiry, initiative, and inventiveness.
 - Advocate for personal, family and community health, hygiene and nutrition.
 - Peace and tolerance, justice, respect for others and for human rights, solidarity and democracy, patriotism, hard work, commitment, resilience and dignity.

5. Stimulate interest in, and care for, the local and global environment and help the learners understand the need for conservation.
6. Promote an awareness that:
 - Scientific theories and methods have developed, and continue to develop, as a result of groups and individuals working together, and that biological science overcomes national boundaries.
 - The study and practice of biology is affected and limited by social, economic, technological, ethical and cultural factors.
 - The applications of biological science may be both helpful and harmful to the individual and the community.
 - Demonstrate awareness and concern for the environment, conservation and sustainability and act accordingly.
 - The use of Information Technology is important for communication, as an aid to experiments and as a tool for interpreting experimental and theoretical results.
7. Use and experiment with a range of scientific and technological tools and equipment and draw appropriate conclusions.
8. Use ICT skills effectively to enhance learning and communication.

(c) Key competences at the end of senior five (S5)

- Explain complex relationships between organisms within their environment.
- Explain the physiological processes by which materials move in and out of cells and the significance of these processes in the life of organisms.
- Describe the structure of a chromosome and how DNA is folded in a chromosome.
- Explain the process of DNA replication and its significance to living organisms.
- Describe the stages of the cell cycle and explain the significance of cell and nuclear division in organisms.
- Explain the relationship of a gene to the sequence of nucleotides in DNA and describe the process of protein synthesis in eukaryotes.
- Describe the process of photosynthesis and explain the various environmental factors that influence the rate of photosynthesis.
- Describe the structure of the transport tissue in plants and the mechanisms by which substances are moved within the plant.

- Describe the structures of gas exchange in different groups of animals.
- Describe the effects of tobacco smoking on the gas exchange system.
- Explain the general principles of homeostatic mechanisms.
- Explain the mechanism of the regulation of blood glucose levels.
- Explain the importance of thermoregulation and the ways by which organisms regulate body temperature.
- Explain the different forms of behaviour and responses and their importance in the survival of organisms.
- Relate the structures of the human reproductive system to their functions and describe gamete formation.
- Describe the immune system and apply the knowledge gained in familiar and unfamiliar contexts.
- Explain the role of genes in inheritance and genetic disorders.
- Describe the types, causes and effects of mutation in organisms.

PEDAGOGICAL APPROACH

Learners learn the best when they are actively involved in the learning process through a high degree of participation, contribution and production. At the same time, each learner is an individual with their own needs, pace of learning, experiences and abilities. Teaching strategies must therefore be varied but flexible within well-structured sequences of lessons. Learner-centred education does not mean that the teacher no longer has responsibility for seeing that learning takes place.

ROLE OF THE TEACHER

The change to a competence-based curriculum is about transforming learning and ensuring that learning is deep, enjoyable and habit-forming.

Teachers ought to shift from the traditional method of instruction to that of a facilitator in order to value the individual needs and expectations of learners.

The teacher must identify the needs of the learners, the nature of the learning to be done, and the means to shape the learning experiences accordingly.

A teacher's role is to organise the learners, both in the classroom or outside, and engage them through participatory and interactive methods through the learning processes as either individuals, in pairs or in groups. This ensures that learning is personalised, active, participative, and co-operative.

The teacher will design and introduce tasks to the class to perform or for immediate discussion. The role of the teacher will be to guide the learners in constructing their own knowledge.

Learners are taught how to use textbooks and other resource materials in different ways; for example, to search for and make use of information in writing their own notes.

The teacher must select and develop appropriate materials such as teaching models, or charts, for the learners to use in their work.

In practical lessons, the teacher will first demonstrate the handling of the apparatus and the show the way the experiment should be carried out before exposing to the learners, as the task that can be dangerous if not performed correctly.

The teacher ought to demonstrate how to mix the reagents in the correct proportions before leaving the learners to do it on their own.

The teacher must devise remedial strategies, both in and outside the classroom, to address the issue of low achievers and those with learning difficulties. The teacher must ensure these learners to keep pace with the rest of the group in acquiring the required competences.

ROLE OF THE LEARNER

The activities of the learner are indicated against each learning unit and they all reflect appropriate engagement of the learner in the learning process.

The teaching and learning processes will be tailored towards creating a learner-friendly environment based on the learner's capabilities, needs, experience and interests.

The learning activities will be organised in a way that encourages the learners to construct knowledge either individually or in groups in an active and engaging way.

Learners work on one unit competence at a time in the form of concrete units with specific learning outcomes broken down into knowledge, skills and attitude.

In practical lessons, learners will work in groups where the availability of the apparatus will not permit working individually. They will also be encouraged to do simple project work individually.

TEACHING AND LEARNING STRATEGIES

To assist and encourage the learners to learn, you perform certain tasks. These are referred to as teaching strategies. You need to engage the learners directly in learning but there are times when you have to take charge of the learning in the class and teach some particular concepts or ideas.

Some useful teaching strategies are:

- **Lecture:** If a demonstration covers skills, teachers will often use a lecture to reach knowledge-based objectives. Teachers choose to lecture when they have a limited amount of time, when the background information is not available or easily accessible to learners (e.g., the material is not in print), or when the concepts could be best clarified through verbal explanation.
- **Brainstorming:** This method is used in groups to support and encourage creative problem-solving.
- **Discussions:** Discussions are a way of exploring issues. Discussions can occur between teacher and learners.
- **Debates:** A debate is a fair and formal way of discussing a topic or an issue. It normally takes place after preparations from two groups—one for the topic and one against the topic.

- **Group work:** The purpose of group work is to give the learners opportunities to share ideas and at the same time learn from group members. Every group should have a group leader to supervise the group's activities such as delegating tasks and consulting the teacher. Group work activities can take place anywhere: in the classroom, under a tree, on a riverside, at the beach, in a forest or school garden.
- **Peer teaching and learning:** This is organised as a partnership activity. One learner performs while the other observes and assists in making corrections and suggesting new ideas and changes. The teacher's role in this strategy is to observe as well encourage positive interaction and effective communication through which the intended outcome is achieved.
- **Demonstrations:** Science demonstration lessons are usually practical lessons where demonstration steps or procedures are outlined and then followed, when others are observing and taking notes. Demonstrations can be conducted by the teacher, learners or an expert from a Science related background. Learners can then repeat the same demonstration lesson. In any learner demonstration, supervision is required at all times.
- **Project:** The learners can demonstrate physically their understanding of the outcomes in various activities they have chosen to investigate.
- **Excursions and field trips:** Excursions and field trips are a valuable and positive addition to any Science programme. Science teachers should take every opportunity to study and increase their knowledge of local resources and places suitable for excursions. On any excursion, identify the safety measures required to ensure the learners' safety.
- **Making models:** Models can be used to show a Science concept. Models can be working models or built to scale if they are demonstration models.
- **Collecting and observation:** Observing is an open ended activity. Observations may be carried out over a short or long period. Specific or general observations may be made and data collected to be later classified and analysed.
- **Testing predictions:** This involves making a prediction and testing it. Choose a problem you want to investigate, carry out background research on the problem and predict what might happen.
- **Research using internet or library books:** Research involves collection of data and analysing them in order to gain new information or knowledge

about a particular subject. Any form of research must be well planned and those who will be involved must be notified well in advance.

SPECIAL NEEDS EDUCATION AND INCLUSIVE APPROACH

All Rwandans have the right to access education regardless of their different needs. The underpinnings of this provision would naturally hold that all citizens benefit from the same menu of educational programmes. The possibility of this assumption is the focus of special needs education. The critical issue is that we have persons/learners who are totally different in their ways of living and learning as opposed to the majority. The difference can either be emotional, physical, sensory and intellectual learning challenged learners traditionally known as mental retardation.

These learners equally have the right to benefit from the free and compulsory basic education in the nearby ordinary/mainstream schools. Therefore, the schools' role is to enrol them and also set strategies to provide relevant education to them. The teacher, therefore, is requested to consider each learner's needs during teaching and learning process. Assessment strategies and conditions should also be standardised to the needs of these learners. Detailed guidance for each category of learners with special education needs is provided in the guidance for teachers.

Learning strategies for the learners with SEN

Learners with learning disabilities sometimes do not intuitively pick up on learning strategies. Introducing a variety of strategies, using them across a number of learning environments and discussing with the student as to which ones work the best and where, is a valuable exercise. It provides insight into learning styles, different ways to organize thinking, and the ways to make effective plans.

Study skills

- Provide study guides or help learners to create their own.
- Encourage study groups, in order to support auditory learners and provide context for learning information.
- Have learners generate possible test questions from which to study.
- Have learners put one fact only on post-it notes, and then organize them into clusters/clumps on their desks. Discuss why each clump has been assembled and how the facts relate to one another.

- Have learners use a highlighter and work as group to identify key words or ideas. Discuss how the highlighted text relates to the overall topic and sub-topics of the piece.

Test-taking

- Help the learners learn how to identify which questions to answer first.
- Teach the learners to skim through the test and answer the easiest questions first, before proceeding to more challenging questions.
- Show them how to use a watch to judge how much time to spend on a question depending on the mark value.
- Teach the process of elimination for multiple choice or true and false questions. Teach the use of a mini map or outline for essay questions.
- Encourage the learners to highlight key or signal words in test questions.
- Teach the strategy of explicitly identifying the steps in multi-step questions.

Memory

- Teach visualization, cognitive mapping and mnemonic strategies.
- Provide advance notice for tests, to allow for longer study time.
- Teach learners to divide information into categories.
- Exaggerate and use humour in presentations and studying tasks.
- Use visual, auditory and kinesthetic modes of presenting and exploring material.
- Provide frequent, regular opportunities to practice.

Note-taking

- *Taking notes involves a combination of quickly processing language, recalling spelling and engaging fine motor skills. Learners with learning disabilities can have immense difficulty with this kind of writing. Teachers should directly teach learning strategies that enable the learners to develop skills in taking useful notes and at the same time consider arranging for learners to have access to peer helper notes.*

ALTERNATE TEACHING APPROACHES

Approach 1: The 5Es—Engage, explore, explain, elaborate and evaluate

This '5Es' is a constructivist approach based on the idea that learners learn the best when they participate in activities that give them opportunities to work things out for themselves. As the names suggest, there are five phases; engage, explore, explain, elaborate and evaluate.

1. Engage

In this phase:

- teachers engage learners in activities that capture their interests and stimulate curiosity,
- learners raise questions,
- teachers verify learners' prior understandings of the topic,
- learners compare ideas.

2. Explore

In this phase, learners undertake hands-on activities where they:

- experience the phenomenon or concept,
- explore the questions they have raised, test their ideas and solve the problems.

3. Explain

Only after learners have had opportunities to explore, they have opportunities to:

- compare their ideas with scientific explanations,
- use scientific terminology,
- construct explanations that can be justified using information collected.

4. Elaborate

In this phase, learners have opportunities to:

- apply what they have learnt to new contexts,
- develop a deeper understanding of the problem or phenomenon as they discuss and compare ideas.

5. Evaluate

In this phase learners and the teacher:

- look for evidence of changes in learners' ideas, beliefs and skills,
- evaluate what learners know and can do.

Approach 2: The interactive approach

The interactive approach involves a teacher-learner partnership in which the learner and the teacher discuss and cooperate in selecting the topic. The learners are active participants and this helps improve their understanding about familiar and unfamiliar concepts as well as their learning processes.

There are five phases in this approach; preparation, exploration, learners' questions, investigations and reflection.

1. Preparation

In this initial phase, teachers:

- select the topics jointly with learners
- verify learners' prior understandings of the topic
- assemble background information.

2. Exploration

In this phase, learners:

- clarify the topic and focus their thinking on particular aspects of the topic
- participate in an activity, preferably hands-on, that enables them to become more familiar with the topic.

3. Learners' questions

In this phase, learners:

- explore the topic and pose further questions for investigation.

4. Investigations

In this phase, learners and the teacher:

- select questions to investigate
- plan and carry out investigations to finalise their answers to the selected questions.

5. Reflection

In this phase, learners have opportunities to:

- compare their views on the topic before and after exploration, questioning and investigation
- reflect on what has been determined and what needs further exploration.

Approach 3: Predict, Observe, Explain

This approach is based on learners drawing on their own experiences to make predictions. There are three phases in this approach: predict, observe and explain.

1. Predict

In this phase:

- teachers pose the question and allow time for learners to think about and clarify the question
- learners make a prediction and give reasons for their prediction
- teachers and learners accept all predictions without judgement
- learners may change their minds as they share their predictions and reasons.

2. Observe

In this phase, teachers or learners perform relevant activities, either as a class demonstration, in a group or individually, and learners record their observations.

3. Explain

In this phase, students attempt to explain their observations which may conflict with their original prediction. Teachers encourage students to reflect on their predictions and modify them to better fit the observations.

ASSESSMENT

Assessment evaluates the teaching and learning methods through the collection and interpretation of evidence of an individual learner's progress in learning and makes a judgment about the learner's achievements measured against a set of defined standards. Assessment is an integral part of the teaching learning processes. In the new competence-based curriculum assessment must also be competence-based. The learner is given a complex situation related to his/her everyday life and asked to try to overcome the situation by applying what he/she has learned.

Assessment will be organised at the following levels: school-based assessment, district examinations, national assessment (LARS) and national examinations.

TYPES OF ASSESSMENT

Formative and continuous assessment (assessment for learning)

Continuous assessment involves formal and informal methods used by schools to check whether learning is taking place. When a teacher is planning his/her lesson, he/she should establish criteria for performance and behavioural changes at the beginning of a unit. At the end of every unit, the teacher should ensure that all the learners have mastered the stated key unit competences based on the criteria stated before going to the next unit. The teacher will assess how well each learner masters both the subject content and the generic competences described in the syllabus. From this, the teacher will gain a picture of the all-round progress of the learner. The teacher will use one or a combination of the following: (a) observation (b) pen and paper (c) oral questioning and tests during or at the end of one or more learning units.

Summative assessment (assessment of learning)

When assessment is used to record a judgement of the competence or performance of the learner, it serves a summative purpose. Summative assessment gives a picture of a learner's competence or progress at any specific moment. The main purpose of summative assessment is to evaluate whether the learning objectives have been achieved and to use the results for the ranking or grading of learners. The results of summative assessment are also used for deciding on progression, for selection into the next level of education and for certification. This assessment should have an integrative aspect whereby a student must be able to show mastery of all competences.

Record keeping

This is gathering facts and evidence from the assessment instruments and using them to judge the learner's performance by assigning an indicator against the set criteria or standard. Assessment procedures generate data in the form of scores which will be carefully recorded and stored in a portfolio. These scores will contribute to remedial actions and alternative instructional strategies. They will also be used to provide feedback to the learner and their parents to check learning progress

and to provide advice, as well as be used in the final assessment of the learners. This portfolio is a folder (or binder or even a digital collection) containing the learner's work as well as the learner's evaluation of the strengths and weaknesses of the work. Portfolios reflect not only work produced (such as papers and assignments), but also it is a record of the activities undertaken over time as part of student learning. The portfolio output (formative assessment) will be considered only as enough for three years of the Advanced level. It will serve as a verification tool for each learner that he/she attended the whole learning before he/she undergoes the summative assessment for the subject.

Item writing in summative assessment

Before writing a question paper, a plan or specification of what is to be tested or examined must be created. This will show the units or topics to be tested on, the number of questions in each level of Bloom's taxonomy and the marks allocation for each question. In a competence based curriculum, questions from higher levels of Bloom's taxonomy should be given more weight than those from the knowledge and comprehension level.

Before developing a question paper, the item writer must ensure that the test or examination questions are tailored towards competence based assessment by doing the following:

- Identify topic areas to be tested on from the subject syllabus.
- Outline subject-matter content to be considered as the basis for the test.
- Identify learning outcomes to be measured by the test.
- Prepare a table of specifications.
- Ensure that the verbs used in the formulation of questions do not require memorisation or recall answers only but test for broad competences as stated in the syllabus.

Reporting to Parents

The wider range of learning in the new curriculum means that it is necessary to think again about how to share a learners' progress with their parents. A single mark is not sufficient to convey the different expectations of learning which are in the learning objectives. The most helpful method of reporting is to share what students are doing well and where they need to improve.

CONTENT MAP

Unit 1: Interdependence between Organisms within their Environment

| | |
|-------------------------------|---|
| Introduction | <ul style="list-style-type: none"> • This unit introduces the student to various interrelationships among organisms and their effects. • This unit also focusses on inter and intraspecific relationships between organisms, including competition, parasitism, predation, saprophytism, mutualism and commensalism. • This unit tells about significance of organisms' interactions in nature. |
| Contents | Interrelationships among organisms and their effects, Inter and intraspecific relationships between organisms: Competition, Parasitism, Predation, Saprophytism, Mutualism, Commensalism; Significance of organisms' interactions in nature. |
| Number of Periods | 10 |
| Competences Practised | To be able to explain the complex relationships between organisms within their environment. |
| Classroom Organisation | Whole class orientation, then group and individual work. |
| Equipment Required | Ecological charts and graphs, audio visual data, computer aided material, and video-film materials (e.g., clips from YouTube). |
| Activities | <ul style="list-style-type: none"> • Individually, classify examples of species interactions, e.g., competition, predation, parasitism, commensalism, and mutualism. • Compare interspecific and intraspecific competition and give examples in each case. • In groups, discuss and interpret the graphical illustrations for relationships between predators and prey. • Observe predator-prey relationships in the environment or from wildlife movies. |
| Language Practice | Discussion in groups, presentation of findings. |

| | | | |
|-------------------------------|--|--|--|
| Vocabulary Acquisition | Terms use in biological interaction among organisms. | | |
| Competences Developed | <ul style="list-style-type: none"> • Compare interspecific and intraspecific competition. • Interpret graphs for predator-prey relationships. • Classify examples of species interactions, e.g., competition, predation, parasitism, commensalism, and mutualism. | | |
| Revision | Self-evaluation and Sample questions provided. | | |
| Assessments | Formative and Summative assessment to diagnose the learners ability. | | |
| Learning Objectives | Knowledge and Understanding | Skills | Attitudes and Values |
| | <ul style="list-style-type: none"> • Explain the various interactions of organisms in nature. • State the significance of organisms' interactions in nature. • Explain the terms interspecific and intraspecific competition. • Describe the adaptations of predators to catch and kill prey and adaptations of prey to avoid predators. | <ul style="list-style-type: none"> • Compare interspecific and intraspecific competition. • Interpret graphs for predator-prey relationships. • Classify examples of species interactions, e.g., competition, predation, parasitism, commensalism, and mutualism. | <ul style="list-style-type: none"> • Appreciate the relationships existing between organisms within their environment. • Recognise the role of saprophytes in mineral recycling. |

Unit 2: Transport Across the Cell Membrane

| | |
|---------------------|--|
| Introduction | This unit focuses on <ul style="list-style-type: none"> • Diffusion and factors affecting the process of diffusion. • Significance of process of diffusion in organisms. • Osmosis and significance in organisms. |
|---------------------|--|

| | |
|-------------------------------|---|
| | <ul style="list-style-type: none"> • Process of osmosis including: turgidity, plasmolysis, water potential, osmotic potential and wall pressure. • Osmosis in animal cells. • Active transport. • Process of active transport. • Factors affecting the process of active transport. • Significance of active transport in organisms. • Endocytosis: phagocytosis, pinocytosis, exocytosis. |
| Content | Diffusion and factors affecting the process of diffusion, Significance of process of diffusion in organisms, Osmosis and significance in organisms, Process of osmosis including: turgidity, plasmolysis, water potential, osmotic potential and wall pressure; Osmosis in animal cells, Active transport, Process of active transport, Factors affecting the process of active transport, Significance of active transport in organisms, Endocytosis: phagocytosis, pinocytosis, exocytosis, interactions in nature. |
| Number of Periods | 18 |
| Competences Practised | To be able to explain the physiological processes by which materials move in and out of cells and the significance of these processes in the life of organisms. |
| Classroom Organisation | Whole class orientation, then group and individual work. |
| Equipment Required | Potato tubers, pawpaw petioles, unripe pawpaw fruits, filamentous algae, onion epidermis, slides and microscopes, visking tubing, knives, potassium permanganate, methylene blue, water, sucrose solutions of varying concentrations, and animal tissues e.g., blood smear of a frog. |
| Activities | <ul style="list-style-type: none"> • Investigate simple diffusion using plant tissues, non-living materials such as glucose solutions and visking tubing. • Calculate surface areas and volumes of simple shapes e.g., cubes to illustrate the principle that the surface area to volume ratio decreases with increasing size. • In groups, investigate and present the effects of immersing plant tissue in solutions of different water potentials. Use the results to estimate the water potential of tissues. • Learners interpret data on movement of solvents and ions in and out of the cell in a table or graph form. |

| | | | |
|-------------------------------|--|--|---|
| Language Practice | Discuss in groups, correlate the observation | | |
| Vocabulary Acquisition | Biological term use in transport across the cell membrane. | | |
| Competences Developed | <ul style="list-style-type: none"> • Apply the knowledge of hypertonic environments in food preservation by salting. • Carry out an investigation on simple diffusion by using plant tissues and non-living materials. • Research adaptations of plants and animals to salty habitats. • Interpret and present data in graphic and table form on the effects of varying concentrations of: e.g., sugar, salt on plant and animal tissues. • Distinguish between endocytosis and exocytosis. | | |
| Revision | Self-evaluation and Sample questions provided. | | |
| Assessments | Formative and Summative assessment to diagnose the learners ability. | | |
| Learning Objectives | Knowledge and Understanding | Skills | Attitudes and Values |
| | <ul style="list-style-type: none"> • Describe and explain the processes and significance of movement in and out of the cell mentioned in the content. • Recall that the increasing size of organisms is constrained by its ability to obtain resources through diffusion across the cell surface and its ability to move substances out of cells. | <ul style="list-style-type: none"> • Apply the knowledge of hypertonic environments in food preservation by salting. • Carry out an investigation on simple diffusion by using plant tissues and non-living materials. | <ul style="list-style-type: none"> • Appreciate the importance of movement of substances across cells. • Show concern when exposing living organisms to concentrated media. |

| | | | |
|--|--|--|--|
| | <ul style="list-style-type: none"> • Explain the movement of water between cells and solutions with different water potentials and explain the effects on plant and animal cells. | <ul style="list-style-type: none"> • Research adaptations of plants and animals to salty habitats. • Interpret and present data in graphic and table form on the effects of varying concentrations of: e.g., sugar, salt on plant and animal tissues. • Distinguish between endocytosis and exocytosis. | |
|--|--|--|--|

Unit 3: Chromosomes and Nucleic Acids

| | |
|-------------------------------|---|
| Introduction | <ul style="list-style-type: none"> • This unit introduces the composition of chromosomes. • This unit also introduces the structure of nucleotides. • This unit also introduces the structure of nucleic acids: DNA and RNA. • This unit also introduces the Watson-Crick hypothesis of the nature of DNA. • This unit also introduces the nature of genes. • This unit also discusses the structure of a genetic code. |
| Content | Composition of chromosomes, Structure of nucleotides, Structure of nucleic acids: DNA and RNA, The Watson-Crick hypothesis of the nature of DNA, Nature of genes, Structure of a genetic code. |
| Number of Periods | 12 |
| Competences Practised | To be able to describe the structure of a chromosome and how DNA is folded into a chromosome. |
| Classroom Organisation | Whole class orientation, then group and individual work. |

| | | | |
|-------------------------------|--|---|--|
| Equipment Required | Models of DNA, illustrations, computer simulations, suitable model materials, tooth picks, ribbons, electric wires, straws of different colours, and prepared slides on mitosis. | | |
| Activities | <ul style="list-style-type: none"> • In groups, use microscopic slides of prophase during mitosis to observe and draw a typical structure of a chromosome. • Using charts and diagrams, compare DNA and RNA and then make a group presentation. • Design and make group presentations about the structure of the DNA molecule and complimentary base pairing using plastic model shapes or homemade kits. | | |
| Language Practice | Discussion with groups and teacher, group presentation. | | |
| Vocabulary Acquisition | Term use in chromosomes and nucleic acids. | | |
| Competences Developed | <ul style="list-style-type: none"> • Use of complimentary base pairing to write the sequence for messenger RNA and the first DNA codes for three base codon. • Draw the structure of DNA (6–10 base pair sequence). • Research on how Watson and Crick determined the nucleotide base pairing pattern. • Distinguish between RNA and DNA. | | |
| Revision | Self-evaluation and Sample questions provided. | | |
| Assessments | Formative and Summative assessment to diagnose the learners ability. | | |
| Learning Objectives | Knowledge and Understanding | Skills | Attitudes and Values |
| | <ul style="list-style-type: none"> • Describe the composition of chromosomes and the structure of nucleotides. • State how nucleotides pair. • Describe the structure of DNA and RNA. | <ul style="list-style-type: none"> • Use of complimentary base pairing to write the sequence for messenger RNA and the first DNA codes for three base codon. | <ul style="list-style-type: none"> • Appreciate the importance of the presence of DNA in chromosomes. • Acknowledge the role of telomeres in |

| | | | |
|--|--|--|---|
| | <ul style="list-style-type: none"> • Explain that the structure of the DNA molecule is described as a ladder twisted into a spira • Explain the Watson- Crick hypothesis of the nature of DNA. • Outline the significance of telomeres in permitting continued replication. • Describe the nature of genes. • Describe the structure of a genetic code. | <ul style="list-style-type: none"> • Draw the structure of DNA (6–10 base pair sequence). • Research on how Watson and Crick determined the nucleotide base pairing pattern. • Distinguish between RNA and DNA. | preventing the loss of genes and its relation to the development of cancer. |
|--|--|--|---|

Unit 4: DNA Replication

| | |
|--------------------------|--|
| Introduction | <ul style="list-style-type: none"> • This unit introduces the mechanism of DNA replication. • This unit also introduces the experimental evidence of DNA replication. • This unit also introduces semiconservative replication. • This unit also introduces that enzymes involved in replication limited to: helicase, DNA binding proteins, DNA polymerase, and DNA ligase. |
| Content | Mechanism of DNA replication, Experimental evidence of DNA replication, Semiconservative replication, Enzymes involved in replication limited to: helicase, DNA binding proteins, DNA polymerase, and DNA ligase. |
| Number of Periods | 6 |

| | | | |
|-------------------------------|---|--|---|
| Competences Practised | To be able to explain the process of DNA replication and its significance to living organisms. | | |
| Classroom Organisation | Whole class orientation, then group and individual work. | | |
| Equipment Required | Computer animations, models and illustrations. | | |
| Activities | <ul style="list-style-type: none"> • In groups, discuss and present the process of replication of DNA. Use models, illustrations, charts and simulations stages. • In groups, analyse the rate of replication of bacterial DNA and eukaryotic DNA and discuss and present reasons for the shorter time taken by human DNA to replicate. • Individually, research and present other possibilities of replication e.g., the conservative and dispersive hypothesis of DNA replication. | | |
| Language Practice | Group discussion, presentation of finding. | | |
| Vocabulary Acquisition | Biological term use in DNA replication. | | |
| Competences Developed | Apply knowledge of complementary base pairing in DNA to interpret Meselson and Stahl's experiment to test different hypothetical models for DNA replication using E.coli grown in a heavy nitrogen (^{15}N) medium. | | |
| Revision | Self-evaluation and Sample questions provided. | | |
| Assessments | Formative and Summative assessment to diagnose the learners ability. | | |
| Learning Objectives | Knowledge and Understanding | Skills | Attitudes and Values |
| | <ul style="list-style-type: none"> • Determine how the structure of DNA enables it to reproduce itself accurately. • State semiconservative replication as a process by which | <ul style="list-style-type: none"> • Apply knowledge of complimentary base pairing in DNA to interpret Meselson and Stahl's experiment to | <ul style="list-style-type: none"> • Appreciate the importance of proper DNA replication. • Acknowledge improper DNA replication would result into genetic changes in the nucleus that would have |

| | | | |
|--|---|---|--|
| | <p>DNA unzips and each new molecule of DNA (daughter DNA) contains one intact strand from the original DNA (parent DNA) and one newly synthesised strand.</p> <ul style="list-style-type: none"> • State the role of enzymes involved in replication of DNA. • List the ingredients used to make DNA in a test tube. • Describe how semiconservative replication of DNA takes place. • State that conservative and dispersive replications are other hypothesis for DNA replication. • Explain the importance of DNA replication in organisms. | <p>test different hypothetical models for DNA replication using E.coli grown in a heavy nitrogen (^{15}N) medium.</p> | <p>both positive and negative effects on organisms. For example changes in the metabolism of cells, variation that can result into evolution and mutations that may lead to death.</p> |
|--|---|---|--|

Unit 5: Cell and Nuclear Division

| | |
|----------------------------|---|
| <p>Introduction</p> | <ul style="list-style-type: none"> • This unit introduces the student about haploid and diploid conditions of the cell cycle. • This unit also focusses on mitosis and role of mitosis in living organisms. • This unit tells about meiosis and its role in living organisms and the significance of cell division limited to: spindle formation, synapsis, bivalents, chiasma formation and movement of chromosomes. • This unit also tells about comparison of mitosis and meiosis. |
|----------------------------|---|

| | |
|-------------------------------|---|
| Content | Haploid and diploid conditions of the cell cycle, Mitosis and role of mitosis in living organisms, Meiosis and its role in living organisms and the significance of cell division limited to: spindle formation, synapsis, bivalents, chiasma formation and movement of chromosomes; Comparison of mitosis and meiosis. |
| Number of Periods | 8 |
| Competences Practised | To be able to describe the stages of the cell cycle and explain the significance of cell and nuclear division in organisms. |
| Classroom Organisation | Whole class orientation, then group and individual work. |
| Equipment Required | Micrographs, compound microscopes, computer animations, prepared slides on root tips and cheek cells, and computer aided learning materials. |
| Activities | <ul style="list-style-type: none"> • Devise an experiment to investigate how long onion root tip cells spend in each phase of the cell cycle and present your findings in tabular form showing the stages of mitosis. • Examine the prepared slides of dividing plant root tip and animal cheek cells and outline how dividing animal cells are different from dividing plant cells. • Carry out a research project to find out why cultured skin is grown in a medium of proteins similar to blood. Write a journal entry to summarise the research. • Identify the stages of meiosis by using micrographs and outline what is taking place at each stage. |
| Language Practice | Group discussion, presentation of finding, writing a journal. |
| Vocabulary Acquisition | Biological term use in cell and nuclear division. |
| Competences Developed | <ul style="list-style-type: none"> • Interpret data related to time for different cell cycles to identify the tissues from which the cells came. • Apply the knowledge of mitosis to predict which set of cells came from and which part of the plant and where other cells have come from. • Make a table showing the phases of the cell cycle mentioning one important event that occurs at each phase. • Compare mitosis and meiosis. |

| | | | |
|----------------------------|--|--|---|
| Revision | Self-evaluation and Sample questions provided. | | |
| Assessments | Formative and Summative assessment to diagnose the learners ability. | | |
| Learning Objectives | Knowledge and Understanding | Skills | Attitudes and Values |
| | <ul style="list-style-type: none"> • Describe the main stages of the cell cycle including: interphase (growth and DNA replication), mitosis and cytokinesis. • Explain what is meant by homologous pairs of chromosomes. • Explain the meaning of the terms haploid and diploid. • Describe the process of mitosis and meiosis. • Outline the significance of mitosis in cell replacement and tissue repair by stem cells. • State that uncontrolled cell division can result in the formation of a tumour. • Define meiosis as reduction | <ul style="list-style-type: none"> • Interpret data related to time for different cell cycles to identify tissues from which the cells came. • Apply the knowledge of mitosis to predict which set of cells came from and which part of the plant and where other cells have come from. • Make a table showing the phases of the cell cycle mentioning one important event that occurs at each phase. • Compare mitosis and meiosis. | <ul style="list-style-type: none"> • Appreciate the importance of effective cell division. • Show concern to individuals with physical disabilities like Down's syndrome. |

| | | | |
|--|---|--|--|
| | <p>division in which the chromosome number is halved from diploid to haploid.</p> <ul style="list-style-type: none">• Explain the need for reduction prior to fertilisation in sexual reproduction.• Outline the role of meiosis in gametogenesis in humans and in the formation of pollen grain and embryo sacs in flowering plants.• Explain how crossing over and random assortment of homologous chromosomes during meiosis and random fusion of gametes at fertilization leads to genetic variation, including the expression of rare recessive alleles. | | |
|--|---|--|--|

Unit 6: Protein Synthesis

| | |
|-------------------------------|--|
| Introduction | <ul style="list-style-type: none"> • This unit introduces the genetic code. • This unit also introduces the process of protein synthesis. • This unit also introduces the transcription: formation of mRNA. • This unit also introduces the translation: ribosomes and polysomes. • This unit also introduces the role of DNA and RNA in protein synthesis. • This unit also introduces the effects of alteration of nucleotide sequence. |
| Content | <ul style="list-style-type: none"> • The genetic code, Process of protein synthesis, Transcription: formation of mRNA, Translation: ribosomes and polysomes, The role of DNA and RNA in protein synthesis, Effects of alteration of nucleotide sequence. |
| Number of Periods | 14 |
| Competences Practised | To be able to explain the relationship between a gene and the sequence of nucleotides in DNA and to describe the process of protein synthesis in eukaryotes. |
| Classroom Organisation | Whole class orientation, then group and individual work. |
| Equipment Required | Models, illustrations, computer animations and charts of DNA and RNA strands and amino acids. |
| Activities | <ul style="list-style-type: none"> • Read and make a flowchart that shows protein synthesis. Put the steps of the process in separate boxes in the flow chart in the order in which they occur from production of mRNA to the final translation of the DNA code. <p style="margin-left: 20px;">In groups, students research and present their findings in journal form on how genetic drugs can be used to stop the expression of genetic diseases with specific reference to how they may interfere with activities of nucleic acids in the nucleus and the cytoplasm of the cell.</p> <ul style="list-style-type: none"> • Carry out an investigation or simulation on the effect of change in genetic code on the structure of the protein manufactured during protein synthesis. |

| | | | |
|-------------------------------|--|--|--|
| | <ul style="list-style-type: none"> • Make a minilab report to demonstrate how gene mutations affect protein synthesis using a sequence of bases of one strand of an imaginary DNA molecule. • Work in groups to construct the model of protein synthesis. | | |
| Language Practice | Discussion in groups, presentation of finding. | | |
| Vocabulary Acquisition | Term use in genetic code and protein synthesis. | | |
| Competences Developed | <ul style="list-style-type: none"> • Construct a flow chart, in proper sequence, for the stages of transcription and translation. • Using the evidence, predict the effect of change in genetic code on the structure of the protein manufactured during protein synthesis. • Carry out research to find and understand better about protein synthesis and on genetic diseases. | | |
| Revision | Self-evaluation and Sample questions provided. | | |
| Assessments | Formative and Summative assessments to diagnose the learners ability. | | |
| Learning Objectives | <p>Knowledge and Understanding</p> <ul style="list-style-type: none"> • State the features of a genetic code. • State that a gene is a sequence of nucleotides that form part of a DNA molecule that codes for a specific polypeptide. • Describe how the information in DNA is used during transcription and translation to construct polypeptides. | <p>Skills</p> <ul style="list-style-type: none"> • Construct a flow chart, in proper sequence, for the stages of transcription and translation. • Using the evidence, predict the effect of change in genetic code on the structure of the protein manufactured during protein synthesis. | <p>Attitudes and Values</p> <ul style="list-style-type: none"> • Appreciate the importance of the genetic code in determining the structure of a protein. • Agree that the way DNA code for polypeptides is central to our understanding of how cells and organisms function. |

| | | | |
|--|---|---|--|
| | <ul style="list-style-type: none"> • State the roles played by mRNA, tRNA and the ribosomes in the formation of the polypeptide. • State that ribosomes provide surface area for the attachment of mRNA during polypeptide synthesis. • State that polysomes consists of up to 50 ribosomes on the same mRNA strand and that they speed up polypeptide synthesis. • Describe the way in which the nucleotide sequence codes for the amino acid sequence with specific reference to Hb^A (normal) and Hb^S (sickle cell) alleles for β-globin polypeptides. • State that gene mutation is a change in the sequence of nucleotides that may result in an altered polypeptide. | <ul style="list-style-type: none"> • Carry out research to find and understand better about protein synthesis and on genetic diseases. | <ul style="list-style-type: none"> • Be aware that DNA is an extremely stable molecule that cells replicate with extreme accuracy to minimise possibilities of DNA mutations. • Appreciate the role of the genetic code in determining the characteristics of an individual. |
|--|---|---|--|

Unit 7: Autotrophic Nutrition

| | |
|-------------------------------|--|
| Introduction | <ul style="list-style-type: none"> • This unit describes the types of autotrophic nutrition. • This unit also describes the structure of the chloroplast. • This unit also describes the adaptations for photosynthesis. • This unit also describes absorption and action spectra. • This unit also describes Calvin cycle and the process of photosynthesis in C3 plants. • This unit also describes other carbon dioxide fixation pathways (C4 CAM). • This unit also describes the rate of photosynthesis: limiting factors of photosynthesis. • This unit also describes the importance of autotrophic nutrition. • This unit also describes about the tests for starch in terrestrial plants and for oxygen in aquatic plants. |
| Content | Types of autotrophic nutrition, Structure of the chloroplast, Adaptations for photosynthesis, Absorption and action spectra, Calvin cycle and the process of photosynthesis in C3 plants, Other carbon dioxide fixation pathways (C4 CAM), Rate of photosynthesis: limiting factors of photosynthesis, Importance of autotrophic nutrition, Tests for starch in terrestrial plants and for oxygen in aquatic plants. |
| Number of Periods | 16 |
| Competences Practised | To be able to describe the process of photosynthesis and explain the various environmental factors that influence the rate of photosynthesis. |
| Classroom Organisation | Whole class orientation, then group and individual work. |
| Equipment Required | Aquatic plants e.g. Elodea, Redox indicator (e.g. DCPIP) and a suspension of chloroplasts from crushed green leaves, test tubes, light bulbs, colour filter, charts and illustrations of the Calvin cycle and cyclic and non-cyclic photophosphorylation, syringes, leaf materials, cork borers and light gels or colour filters. |

| | |
|-------------------------------|--|
| Activities | <ul style="list-style-type: none"> • In pairs, carry out tests for starch in terrestrial plants and for oxygen in aquatic plants. • Carry out investigations on the effects of changing light intensity, carbon dioxide and temperature on the rate of photosynthesis using whole plants, e.g., aquatic plants such as Elodea or using the floating leaf disc assay technique. • Use chromatography to separate and identify chloroplast pigments and carry out an investigation to compare the chloroplast pigments in different plants. • Carry out an investigation to determine the effect of light intensity or light wavelength on the rate of photosynthesis using a redox indicator (e.g., DCPIP) and a suspension of chloroplasts (the Hill reaction) or by using a floating leaf disc assay. |
| Language Practice | Presentation of finding, group discussion. |
| Vocabulary Acquisition | Term use in autotrophic nutrition/photosynthesis. |
| Competences Developed | <ul style="list-style-type: none"> • Use their knowledge of plant cells and leaf structure from the section on cell structure while studying photosynthesis. • Describe the relationship between the structure and function in the chloroplast, using diagrams and electron micrographs. • Interpret absorption and action spectra of chloroplast pigments. • Carry out an investigation of limiting factors. • Relate the anatomy and physiology of the leaves of C4 and CAM plants to high rates of carbon fixation and low rates of transpiration. • Apply the knowledge and understanding of limiting factors to increase crop yields in protected environments, such as glasshouses. • Investigate the effect of light intensity or light wavelength on the rate of photosynthesis. • Differentiate between C4, CAM and C3 plants during carbon dioxide fixation. |
| Revision | Self-evaluation and Sample questions provided. |
| Assessments | Formative and Summative assessments to diagnose the learners ability. |

| Learning Objectives | Knowledge and Understanding | Skills | Attitudes and Values |
|---------------------|---|---|--|
| | <ul style="list-style-type: none"> • State and explain the types of autotrophic nutrition. • Explain the role of light in autotrophic nutrition. • State the pigments involved in light absorption. • Recall the structure of the leaf in relation to photosynthesis. • State the sites and stages of photosynthesis in chloroplasts. • Describe the role of chloroplast pigments (chlorophyll a, chlorophyll b, carotene and xanthophylls) in light absorption in the grana. • Outline the three main stages of the Calvin cycle. • Describe and outline the conversion of the Calvin cycle intermediates to carbohydrates, lipids and amino acids and their uses in the plant cell. | <ul style="list-style-type: none"> • Use their knowledge of plant cells and leaf structure from the section on cell structure while studying photosynthesis. • Describe the relationship between the structure and function in the chloroplast, using diagrams and electron micrographs. • Interpret absorption and action spectra of chloroplast pigments. • Carry out an investigation of limiting factors. • Relate the anatomy and physiology of the leaves of C4 and CAM plants to high rates of carbon fixation and low rates of transpiration. • Apply the knowledge and understanding of limiting factors to increase crop yields in protected environments, such as glasshouses. | <ul style="list-style-type: none"> • Appreciate the importance of photosynthesis as an energy transfer process that produces complex organic compounds using light energy absorbed by chloroplast pigments. • Acknowledge that environmental factors influence the rate of photosynthesis and investigation shows how they can be managed in protected environments used in crop production. |

| | | | |
|--|--|---|--|
| | <ul style="list-style-type: none"> • Explain the term limiting factor in relation to photosynthesis and the effects of the changes in the limiting factors on the rate of photosynthesis. | <ul style="list-style-type: none"> • Investigate the effect of light intensity or light wavelength on the rate of photosynthesis. • Differentiate between C4, CAM and C3 plants during carbon dioxide fixation. | |
|--|--|---|--|

Unit 8: Transport System in Plants

| | |
|-------------------------------|---|
| Introduction | <ul style="list-style-type: none"> • This unit introduces the need for a transport system. • This unit also discusses the structure of transport tissues. • This unit also discusses the transport mechanisms of plants: xylem sap and phloem sap. • This unit also discusses the transpiration: water stress, adaptations of xerophytes to reduce water loss by transpiration. |
| Content | Need for a transport system, Structure of transport tissues, Transport mechanisms of plants: xylem sap and phloem sap, Transpiration: water stress, adaptations of Xerophytes to reduce water loss by transpiration. |
| Number of Periods | 14 |
| Competences Practised | To be able to describe the structure of the transport tissues in plants and the mechanisms by which substances are moved within the plant. |
| Classroom Organisation | Whole class orientation, then group and individual work. |
| Equipment Required | Prepared slides of cross-sections of xerophytes, simple potometers, leaf impressions, epidermal peels, grids, cut shoot, light bulb, fan, plant shoot and root from aquatic and dry environments, prepared slides of transverse sections of stems, roots and leaves of herbaceous dicotyledonous plants, prepared slides of xylem vessel elements, phloem sieve tube elements and companion cells and light microscopes. |

| | |
|-------------------------------|--|
| Activities | <ul style="list-style-type: none"> • Make annotated drawings, using prepared slides of cross-sections, to show transport structures in stem and roots and how the leaves of xerophytes have adapted to reduce water loss by transpiration. • Experimentally, investigate and explain the factors that affect transpiration rates, using simple potometers, leaf impressions, epidermal peels, and grids for determining surface area. • Discuss the reasons for the fact that transpiration is an inevitable consequence of gas exchange in plants. • Investigate mass flow hypothesis in the translocation of phloem sap. |
| Language Practice | Discussion in groups, presentation of finding. |
| Vocabulary Acquisition | Term use in transport systems in plants. |
| Competences Developed | <ul style="list-style-type: none"> • Observe, draw and label, from prepared slides, plan diagrams of transverse sections of stems, roots and leaves of herbaceous dicotyledonous plants to show the tissues in correct proportion. • Draw and label, from prepared slides, the cells in roots, stems and leaves using transverse and longitudinal sections. • Recognise, from prepared slides, using the light microscope to draw and label the structure of xylem vessel elements, phloem sieve tube elements and companion cells. • Relate the structure of xylem vessel elements, phloem sieve tube elements and companion cells to their functions. • Experimentally investigate and explain the factors that affect transpiration rate using simple potometers, leaf impressions, epidermal peels, and grids for determining surface area. • Make annotated drawings, using prepared slides of cross-sections, to show how the leaves of xerophytes are adapted to reduce water loss by transpiration. • Carry out an investigation to demonstrate mass flow hypothesis. |
| Revision | Self-evaluation and Sample questions provided. |
| Assessments | Formative and Summative assessments to diagnose the learners ability. |

| Learning Objectives | Knowledge and Understanding | Skills | Attitudes and Values |
|---------------------|--|---|---|
| | <ul style="list-style-type: none"> • Recall that plants have two transport tissues: xylem and phloem. • Explain the movement of water between plant cells, and between them and their environment, in terms of water potential. • Recall the term transpiration and understand that transpiration is an inevitable consequence of gas exchange in plants. • Explain how hydrogen bonding is involved with the movement of water in the xylem by cohesion-tension in transpiration pull and adhesion to cellulose cell walls. • State that assimilates, such as sucrose and amino acids, move between sources and sinks in phloem sieve tubes. | <ul style="list-style-type: none"> • Observe, draw and label, from prepared slides, plan diagrams of transverse sections of stems, roots and leaves of herbaceous dicotyledonous plants to show tissues in correct proportion. • Draw and label, from prepared slides, the cells in roots, stems and leaves using transverse and longitudinal sections. • Recognise, from prepared slides, using the light microscope to draw and label the structure of xylem vessel elements, phloem sieve tube elements and companion cells. • Relate the structure of xylem vessel elements, phloem sieve tube elements and companion cells to their functions. | <ul style="list-style-type: none"> • Appreciate the importance of transport systems in plants. • Acknowledge that plants do not have systems for transporting oxygen and carbon dioxide. Instead, these gases diffuse through air spaces within stems, roots and leaves. • Show resilience when setting apparatus and making observations using microscopes and solutions of different concentration to ensure improved reliability. • Show concern when selecting crop plants to reflect adaptations to environments e.g., where they grow |

| | | | |
|--|---|--|--|
| | <ul style="list-style-type: none"> • Explain how transport systems in plants move substances from where they are absorbed or produced to where they are stored or used. • Explain how sucrose is loaded into phloem sieve tubes by companion cells using proton pumping and the co-transporter mechanism in the cell surface membranes. • Explain the mass flows in phloem sap down a hydrostatic pressure gradient from source to sink. | <ul style="list-style-type: none"> • Experimentally, investigate and explain the factors that affect transpiration rate using simple potometers, leaf impressions, epidermal peels, and grids for determining surface area. • Make annotated drawings, using prepared slides of cross-sections, to show how leaves of xerophytes are adapted to reduce water loss by transpiration. • Carry out an investigation to demonstrate mass flow hypothesis. | <p>well, and when under water or not under water stress.</p> |
|--|---|--|--|

Unit 9: Gas Exchange in Animals

| | |
|----------------------------|--|
| <p>Introduction</p> | <ul style="list-style-type: none"> • This unit introduces the gaseous exchanges in insects and fish. • This unit introduces the significance of counter current gaseous exchange in bony fish. • This unit also introduces the gaseous exchange in amphibians. • This unit explains the structure of human gas exchange system. • This unit introduces the functions of tissues within the gas exchange system. • This unit also introduces the mechanism of ventilation (breathing). • This unit describes the gas exchange in the alveoli. • This unit also introduces the lung volume and capacities. |
|----------------------------|--|

| | |
|-------------------------------|--|
| | <ul style="list-style-type: none"> • This unit describes the use of spirometer to measure ventilation rate. • This unit describes about the nervous control of breathing. |
| Content | Gaseous exchanges in insects and fish, Significance of counter current gaseous exchange in bony fish, Gaseous exchange in amphibians; Structure of human gas exchange system, Functions of tissues within the gas exchange system, Mechanism of ventilation (breathing), Gas exchange in the alveoli, Lung volume and capacities, Use of spirometer to measure ventilation rate, Nervous control of breathing. |
| Number of Periods | 18 |
| Competences Practised | To be able to describe the structures of gas exchange in different groups of animals. |
| Classroom Organisation | Whole class orientation, then group and individual work. |
| Equipment Required | Models, computer simulations and illustrations, live specimens of animals (locust/cockroach, tilapia, frog/toad, rat/rabbit), spirometer (or model of a spirometer), and spirometer traces for analysis. |
| Activities | <ul style="list-style-type: none"> • Learners dissect an insect such as locust/cockroach to locate the tracheal system. • Learners examine the gills of a freshly killed bony fish and study the structure. Draw and label. • Observe fish in aquaria to monitor and sequence mouth and operculum movements during gas exchange. • Learners research using the internet or textbooks and report to the class about counter flow and parallel flow. • Observe a live frog or toad in a glass tank and discuss its gas exchange surfaces. • Use models, computer simulations and illustrations to discuss the structure and functioning of the human gas exchange system. • Design a model of the spirometer based on its main features. • Learners discuss the role of the brain in controlling gas exchange. Use illustrations or computer aided materials. • Learners use illustrations of spirometer trace to define tidal volume, inspiratory reserve volume, expiratory reserve volume, vital capacity and residual volume. • Using data of lung volumes, learners calculate pulmonary ventilation (PV) and alveolar ventilation (AV). |

| | | | |
|-------------------------------|---|---|---|
| Language Practice | Group discussion. | | |
| Vocabulary Acquisition | Parts of traction system in an insect, parts of human respiratory system. | | |
| Competences Developed | <ul style="list-style-type: none"> • Dissect an insect, fish and a small mammal to study gaseous exchange organs. • Relate the structure of gas exchange organs to function. • Differentiate between the gaseous exchange in bony fish and that in cartilaginous fish. • Interpret a graph of human lung volumes measured with a spirometer. • Calculate the volume of air in the lungs and in the alveoli. • Analyse and interpret data from a spirometer. • Search and use data to calculate pulmonary ventilation and alveolar ventilation. | | |
| Revision | Self-evaluation and Sample questions provided. | | |
| Assessments | Formative and Summative assessment to diagnose the learners ability. | | |
| Learning Objectives | Knowledge and Understanding | Skills | Attitudes and Values |
| | <ul style="list-style-type: none"> • Describe the tracheal system of insects and relate to its function. • Describe the structure of the gills in relation to function. • Explain the significance of counter current flow in bony fish. • Describe the mode of gaseous exchange in amphibians. • Describe the structure of the human gas exchange system. | <ul style="list-style-type: none"> • Dissect an insect, fish and a small mammal to study gaseous exchange organs. • Relate the structure of gas exchange organs to function. • Differentiate between the gaseous exchange in bony fish and that in cartilaginous fish. | <ul style="list-style-type: none"> • Appreciate the similarities and differences in gas exchange surfaces of animals. • Appreciate the role of the brain in controlling gas exchange. |

| | | | |
|--|--|--|--|
| | <ul style="list-style-type: none"> • Describe the distribution of tissues within the trachea, bronchi, bronchioles and alveoli and relate each tissue to its function. • Explain the mechanism of ventilation in humans. • Explain the process of gas exchange in alveoli with emphasis on diffusion. • Describe the role of the brain in controlling gas exchange in humans. • Define the terms related to the lung capacities (tidal, reserve volume, vital capacity, residual volume, and dead air space). • Describe how a spirometer can be used to measure vital capacity, tidal volume, breathing rates, and oxygen uptake. | <ul style="list-style-type: none"> • Interpret a graph of human lung volumes measured with a spirometer. • Calculate the volume of air in the lungs and in the alveoli. • Analyse and interpret data from a spirometer. • Search and use data to calculate pulmonary ventilation and alveolar ventilation. | |
|--|--|--|--|

Unit 10: Smoking and Related Diseases

| | |
|---------------------|--|
| Introduction | <ul style="list-style-type: none"> • This unit describes about the effects of tar and carcinogens in tobacco smoke on the gas exchange system. • This unit introduces the symptoms of lung cancer and chronic obstructive pulmonary diseases (COPD). • This unit explains the effects of nicotine and carbon monoxide on the cardiovascular system. |
|---------------------|--|

| | |
|-------------------------------|--|
| | <ul style="list-style-type: none"> • This unit discusses the contribution of tobacco smoking to atherosclerosis and coronary heart disease. • This unit introduces the evidence linking cigarette smoking to disease and early death. • This unit also describes about how tobacco smoking contributes to atherosclerosis and coronary heart disease. |
| Content | Effects of tar and carcinogens in tobacco smoke on the gas exchange system, Symptoms of lung cancer and chronic obstructive pulmonary diseases (COPD), Effects of nicotine and carbon monoxide on the cardiovascular system, Contribution of tobacco smoking to atherosclerosis and coronary heart disease, Evidence linking cigarette smoking to disease and early death. |
| Number of Periods | 4 |
| Competences Practised | To be able to describe the effects of tobacco smoking on the gas exchange system. |
| Classroom Organisation | Whole class orientation, then group and individual work. |
| Equipment Required | Charts, cured tobacco leaves, computer simulations, and smoking machine or video clip. |
| Activities | <ul style="list-style-type: none"> • Learners boil tobacco in water to extract a solution which is allowed to cool. Learners then spray the solution on a plant infested with aphids and prove that tobacco contains poisonous substances that kill the aphids. Or using a video experiment to demonstrate how the quantity of tar from smoking is produced. • In groups, learners research from the internet or the library the effects of smoking on the gas exchange system and present their findings. • Learners observe and interpret research statistics linking tobacco smoking to disease. |
| Language Practice | Discuss your finding, writing a journal to control tobacco. |
| Vocabulary Acquisition | Dangerous chemical in tobacco smoke, smoking related disease. |

| | | | |
|------------------------------|---|--|---|
| Competences Developed | <ul style="list-style-type: none"> • Interpret photographs to differentiate healthy lungs from infected lungs. • Interpret data linking cigarette smoking to disease and early death. • Observe and interpret research statistics linking to tobacco smoking. | | |
| Revision | <ul style="list-style-type: none"> • Self-evaluation and Sample questions provided. | | |
| Assessments | Formative and Summative assessment to diagnose the learners ability. | | |
| Learning Objectives | Knowledge and Understanding | Skills | Attitudes and Values |
| | <ul style="list-style-type: none"> • Describe the effects of tar and carcinogens in tobacco smoke on the gas exchange system. • Describe the signs and symptoms of lung cancer and chronic obstructive pulmonary diseases (COPD). • Describe the effects of nicotine and carbon monoxide on the cardiovascular system. • Explain how tobacco smoking contributes to atherosclerosis and coronary heart disease. | <ul style="list-style-type: none"> • Interpret photographs to differentiate healthy lungs from infected lungs. • Interpret data linking cigarette smoking to disease and early death. • Observe and interpret research statistics linking to tobacco smoking. | <ul style="list-style-type: none"> • Evaluate the epidemiological and experimental evidence linking cigarette smoking to disease and early death. • Influence the campaign against cigarette smoking. |

Unit 11: General Principles of Homeostasis

| | |
|-------------------------------|--|
| Introduction | <ul style="list-style-type: none"> • This unit describes about the significance of constant internal environment. • This unit discusses the factors that must be kept constant in the body: glucose, temperature, pH, water, ions, respiratory gases, and osmotic pressure of blood fluids. • This unit explains about the role of the negative feedback mechanism. • This unit describes about feedback mechanisms related to the endocrine and nervous systems in homeostatic activities. • This unit describes the causes of changes in the internal environment. • This unit also introduces the formation, composition and movement of tissue fluid and its relationship to the blood and lymph. • This unit describes about the adaptations of organisms to different environmental conditions. |
| Content | Significance of constant internal environment, Factors that must be kept constant in the body: glucose, temperature, pH, water, ions, respiratory gases, and osmotic pressure of blood fluids; Role of the negative feedback mechanism, Feedback mechanisms related to the endocrine and nervous systems in homeostatic activities; Causes of changes in the internal environment; Formation, composition and movement of tissue fluid and its relationship to the blood and lymph, Adaptations of organisms to different environmental conditions. |
| Number of Periods | 4 |
| Competences Practised | To be able to explain general principles of homeostatic mechanisms. |
| Classroom Organisation | Whole class orientation, then group and individual work. |
| Equipment Required | Charts and computer aided materials and rubber tubes. |

| | | | |
|-------------------------------|--|---|--|
| Activities | <ul style="list-style-type: none"> • Learners research from the library or internet the definition of homeostasis and factors that must be kept constant and present their findings in class. • In groups, learners use charts to discuss the mechanism of negative feedback and its role. • Learners are engaged in discussion of why there are diabetic people and people with high blood pressure, while others have no problems. • Learners work in groups to demonstrate how a fluid can leak through pores of a rubber tube as illustration of tissue fluid formation. • Learners are guided to make a field study on adaptations of different organisms to different environmental conditions. | | |
| Language Practice | Presentation of finding, discussion in groups. | | |
| Vocabulary Acquisition | Term use in components of homeostatic. | | |
| Competences Developed | <ul style="list-style-type: none"> • Relate organisms' ways of life to their environmental conditions. • Carry out research on homeostasis and deduce the findings. | | |
| Revision | Self-evaluation and Sample questions provided. | | |
| Assessments | Formative and Summative assessments to diagnose the learners ability. | | |
| Learning Objectives | Knowledge and Understanding | Skills | Attitudes and Values |
| | <ul style="list-style-type: none"> • Explain the significance of a constant internal environment. • State the factors that must be kept constant in the internal environment of the body. • Discuss the role of the negative feedback mechanism. | <ul style="list-style-type: none"> • Relate organisms' ways of life to their environmental conditions. • Carry out research on homeostasis and deduce the findings. | <ul style="list-style-type: none"> • Appreciate the importance of maintaining a constant internal environment. • Appreciate the adaptations of animals to different environmental conditions in relation to homeostasis. |

| | | | |
|--|--|--|--|
| | <ul style="list-style-type: none"> • Explain the feedback mechanism in relation to the endocrine and nervous system. • Identify the main internal and external causes of change in the internal environment. • Describe the formation, composition and movement of tissue fluid in relation to blood and lymph. | | |
|--|--|--|--|

Unit 12: Regulation of Glucose

| | |
|---------------------|--|
| Introduction | <ul style="list-style-type: none"> • This unit discusses the importance of glucose. • This unit describes the role of the liver and the pancreas in glucose regulation. • This unit also explains the detailed structure of a liver lobule and the Islet of Langerhans. • This unit also discusses the homeostatic control of blood glucose concentration by insulin and glucagon. • This unit also introduces the interaction of glucose control mechanisms by other hormones. • This unit also describes about the causes of blood sugar imbalances in the body. • This unit also discusses the diabetes mellitus. • This unit also explains the monitoring of blood glucose levels. • This unit discusses the detection of glucose in urine. |
|---------------------|--|

| | |
|-------------------------------|--|
| Content | Importance of glucose, Role of the liver and the pancreas in glucose regulation, Detailed structure of a liver lobule and the Islet of Langerhans, Homeostatic control of blood glucose concentration by insulin and glucagon, Interaction of glucose control mechanisms by other hormones, Causes of blood sugar imbalances in the body, Diabetes mellitus, Monitoring of blood glucose levels, Detection of glucose in urine. |
| Number of Periods | 7 |
| Competences Practised | To be able to explain the mechanism of the regulation of blood glucose levels. |
| Classroom Organisation | Whole class orientation, then group and individual work. |
| Equipment Required | Charts/illustrations, computer aided study materials, microscopes and accessories. |
| Activities | <ul style="list-style-type: none"> • Learners work in groups to discuss the process by which blood glucose level is controlled. Use illustrations and computer aided materials. • Learners research from the library or internet, negative feedback and causes and effects of blood sugar imbalances. Learners present their findings to the class. • Using a microscope, learners observe the prepared slides of liver tissue and pancreas tissue to study their structures and relate to the functions. • Carry out experiments to test for glucose in 'urine' samples. Coloured water may be used in place of real urine to avoid cases of infection. • Learners carry out research, from scientific articles or from the internet, on the role of adrenaline in the control of blood glucose level. |
| Language Practice | Group discussion, presentation of finding. |
| Vocabulary Acquisition | Term use in glucose regulation, cause of blood sugar imbalances in the body. |
| Competences Developed | <ul style="list-style-type: none"> • Test coloured water (simulated urine) for glucose. • Relate the structure of the liver and the pancreas to their functions. |

| | | | |
|----------------------------|---|---|--|
| | <ul style="list-style-type: none"> • Relate the microstructure of the liver and the pancreas to sugar regulation. • Make research using internet or articles on the role of adrenaline in the control of blood sugar. | | |
| Revision | Self-evaluation and Sample questions provided. | | |
| Assessments | Formative and Summative assessment to diagnose the learners ability. | | |
| Learning Objectives | Knowledge and Understanding | Skills | Attitudes and Values |
| | <ul style="list-style-type: none"> • Describe the role of hormones in sugar regulation. • Describe the detailed structure of a liver lobule and the Islet of Langerhans. • Explain the negative feedback mechanism in the process of blood glucose control. • Discuss the causes and effects of blood sugar imbalances in the body. • Describe the functions of the liver and pancreas in the regulation of glucose in the body. • Describe the three main stages of cell signalling in control of blood glucose by adrenaline as follows: <ul style="list-style-type: none"> – Hormone-receptor interaction at the cell surface. | <ul style="list-style-type: none"> • Test coloured water (simulated urine) for glucose. • Relate the structure of the liver and the pancreas to their functions. • Relate the microstructure of the liver and the pancreas to sugar regulation. • Make research using internet or articles on the role of adrenaline in the control of blood sugar. | <ul style="list-style-type: none"> • Appreciate the importance of a controlled diet for diabetics. • Assist diabetics and people having hypertension in coping with their situation. |

| | | | |
|--|---|--|--|
| | <ul style="list-style-type: none"> • Formation of cyclic AMP that bind to kinase protein. • An enzyme cascade involving activation of enzymes by phosphorylation to amplify the signal. • Explain the principles of the operation of dip sticks and biosensors for quantitative measurements of glucose in the blood and urine. • Explain how urine analysis is used in diagnosis with reference to glucose, protein and ketones. | | |
|--|---|--|--|

Unit 13: Regulation of Temperature

| | |
|---------------------|--|
| Introduction | <ul style="list-style-type: none"> • This unit discusses the importance of temperature regulation. • This unit also describes about morphological, physiological and behavioural adaptation to temperature changes in the environment. • This unit describes about the response to cold and hot conditions by endothermic and ectothermic animals. • This unit also discusses the role of the brain: hypothalamus and thermo receptors in temperature regulation. • This unit also describes the effect of temperature conditions on animal behaviour. • This unit also discusses the temperature control in plants. |
| Content | <p>Importance of temperature regulation; Morphological, physiological and behavioural adaptation to temperature changes in the environment; Response to cold and hot conditions by endothermic and ectothermic animals, The role of the brain: hypothalamus and thermoreceptors in temperature regulation, Effect of temperature conditions on animal behaviour, Temperature control in plants.</p> |

| | |
|-------------------------------|---|
| Number of Periods | 7 |
| Competences Practised | To be able to explain the importance and ways by which organisms regulate body temperature. |
| Classroom Organisation | Whole class orientation, then group and individual work. |
| Equipment Required | Charts and graphs for temperature regulation in different animals, and computer aided materials. |
| Activities | <ul style="list-style-type: none"> • Learners carry out a simple experiment to show that enzymes require an optimum temperature and use the results to discuss why it is important to regulate body temperature. • In groups, learners observe photographs of animals, e.g., from the arctic regions and deserts, and record the observable features that enable them live in those conditions in relation to temperature changes. |
| | <ul style="list-style-type: none"> • Use computer aided materials or illustrations to describe the process of temperature regulation in endotherms and ectotherms. • Using internet or textbook material, learners research the role of the brain and thermo receptors in temperature regulation and present their findings. • Design and carry out a project to investigate the effect of temperature conditions on animal behaviour. • In pairs, interpret and list the adaptive features shown by plants inhabiting extreme cold and hot environments. |
| Language Practice | Discussion in group, presentation in finding. |
| Vocabulary Acquisition | Biological term use in physiological and behavioural adaption in animals. |
| Competences Developed | <ul style="list-style-type: none"> • Interpret data related to the effects of temperature on animal behaviour. • Interpret and list the adaptive features shown by plants inhabiting extreme cold and hot environments. • Research using internet the role of brain in temperature regulation. • Design and investigate the effect of temperature. |

| | | | |
|----------------------------|---|--|--|
| Revision | Self-evaluation and Sample questions provided. | | |
| Assessments | Formative and Summative assessments to diagnose the learners ability. | | |
| Learning Objectives | Knowledge and Understanding | Skills | Attitudes and Values |
| | <ul style="list-style-type: none"> • Explain the importance of temperature regulation. • Describe the morphological, physiological and behavioural adaptations to temperature changes in the environment. • Describe the responses to cold and hot conditions by endothermic and ectothermic animals. • Explain the role of the brain and thermo receptors in temperature regulation. • Describe the different processes in which plants minimise overheating. | <ul style="list-style-type: none"> • Interpret the data related to the effects of temperature on animal behaviour. • Interpret and list the adaptive features shown by plants inhabiting extreme cold and hot environments. • Research using internet the role of brain in temperature regulation. • Design and investigate the effect of temperature. | <ul style="list-style-type: none"> • Acknowledge the importance of maintaining fairly constant temperatures for efficient metabolism. |

Unit 14: Behaviour and Responses in Mammals

| | |
|-------------------------------|--|
| Introduction | <ul style="list-style-type: none"> • This unit discusses the behaviour: simple responses. • This unit describes about learning: habituation and imprinting. • This unit also explains the different types of behaviour in terms of stimulus, receptor, nerves and effectors. • This unit also describes how types of behaviour result from sequential responses • This unit discusses the conditioning and latent learning. • This unit introduces the social behaviour. • This unit describes about courtship, territoriality and dominance hierarchies. • This unit explains the behavioural rhythms and biological clocks. • This unit discusses the animal migration. |
| Content | <p>Behaviour: simple responses, Learning: habituation and imprinting.</p> <p>Conditioning and latent learning, Social behaviour; Courtship, Territoriality and dominance hierarchies; Behavioural rhythms and biological clocks, Animal migration.</p> |
| Number of Periods | 14 |
| Competences Practised | To be able to explain the different forms of behaviour and responses and their importance in the survival of organisms. |
| Classroom Organisation | Whole class orientation, then group and individual work. |
| Equipment Required | Online sources, charts and diagrams for animal behaviour and migration. |
| Activities | <ul style="list-style-type: none"> • Discuss how taxes and kineses can orient animals to favourable places. • Learners discuss the contribution of innate behaviour and learned behaviour to an animal's overall behaviour and survival. • Discuss the significance of latent learning. • Research the different forms of communities that exhibit territorial behaviour. • Make a group presentation about the interpretations of Pavlov's experiment. • Research and discuss the advantages of bird migration. |

| | | | |
|-------------------------------|---|--|--|
| Language Practice | Discussion in groups, presentation of findings, writing in exercise book. | | |
| Vocabulary Acquisition | Term use in types of behaviours. | | |
| Competences Developed | <ul style="list-style-type: none"> • Apply the knowledge of reflex actions to describe the components of a reflex arc and explain the different reflex behaviours. • Distinguish between simple reflex actions and a fixed action pattern. • Analyse the forms of conditioning. • Analyse the contribution of innate behaviour and learned behaviour to an animal's overall behaviour and survival. • Distinguish between classical and operant conditioning. • Analyse the significance of latent learning. • Relate learning and response to survival in the environment. • Distinguish between migration and dispersion. | | |
| Revision | Self-evaluation and Sample questions provided. | | |
| Assessments | Formative and Summative assessments to diagnose the learners ability. | | |
| Learning Objectives | Knowledge and Understanding | Skills | Attitudes and Values |
| | <ul style="list-style-type: none"> • State the different types of behaviour. • Recall that the nervous system is responsible for coordinating behaviour. • Explain the different types of behaviour in terms of stimulus, receptor, nerves and effectors. • Explain how types of behaviour result from sequential responses. | <ul style="list-style-type: none"> • Apply the knowledge of reflex actions to describe the components of a reflex arc and explain the different reflex behaviours. • Distinguish between simple reflex actions and a fixed action pattern. • Analyse the forms of conditioning. | <ul style="list-style-type: none"> • Appreciate the importance of animal welfare. • Value the causes and effects of bird and other animal migration. • Show concern for the behaviour of animals in societies. • Acknowledge the need for a territory by |

| | | | |
|--|---|---|--|
| | <ul style="list-style-type: none"> • Give examples of imprinting and understand its significance. • Explain the value of habituation. • Define the terms: conditioning, habituation, survival, courtship behaviour and migration. • Discuss the advantages and disadvantages to organisms living in societies. • Describe how birds and mammals maintain their territory. • Explain the significance of behavioural rhythms. • Discuss the advantages of bird migration. | <ul style="list-style-type: none"> • Analyse the contribution of innate behaviour and learned behaviour to an animal's overall behaviour and survival. • Distinguish between classical and operant conditioning. • Analyse the significance of latent learning. • Relate learning and response to survival in the environment. • Distinguish between migration and dispersion. | <p>some animals for their continued survival.</p> <ul style="list-style-type: none"> • Show concern for the importance of conditioned reflex in relation to survival. |
|--|---|---|--|

Unit 15: Immune System, Vaccination and Antibiotics

| | |
|----------------------------|--|
| <p>Introduction</p> | <ul style="list-style-type: none"> • This unit discusses the origin and describes the mode of action of phagocytes. • This unit also discusses the modes of action of B-lymphocytes and T-lymphocytes. • This unit also explains the meaning of the term immune response, making reference to the terms antigen, self and non-self. • This unit explains the role of memory cells in long-term immunity. |
|----------------------------|--|

| | |
|-------------------------------|--|
| | <ul style="list-style-type: none"> • This unit explains the role of antibodies in allergies. • This unit discusses the differences between generalised and localised allergic reactions. • This unit also discusses the causes, symptoms and treatment of asthma and hay fever. • This unit also discusses the reasons why vaccination programmes have eradicated smallpox but not measles, TB, malaria or cholera. • This unit also discusses the antibiotic |
| Content | Origin and mode of action of phagocytes, Immune responses, Types of immunity, Allergy as an immune response, Asthma and hay fever, Antibiotics. |
| Number of Periods | 8 |
| Competences Practised | To be able to describe the immune system and apply the knowledge gained in familiar and unfamiliar contexts. |
| Classroom Organisation | Whole class orientation, then group and individual work. |
| Equipment Required | Microscopes, prepared slides of white blood cells, and statistics on disease occurrence. |
| Activities | <ul style="list-style-type: none"> • Learners study the prepared slides of blood smear and observe, draw and describe the structures seen. Learners should focus on phagocytes and lymphocytes. • Interpret charts for humoral and cellular responses to show the relationship between the two forms of response. • Learners compare the data showing statistics of cases of smallpox, measles, malaria and tuberculosis over centuries and discuss why vaccination has not eradicated some of these diseases. • Learners carry out research and present their findings on the reasons for antibiotic resistance in the treatment of bacterial infections. |
| Language practice | Discuss in group, presentation in finding. |
| Vocabulary Acquisition | Term use in immune system, vaccination and antibiotics. |

| | | | |
|------------------------------|--|---|--|
| Competences Developed | <ul style="list-style-type: none"> • Recognise phagocytes and lymphocytes under a light microscope. • Relate the molecular structure of antibodies to their functions. • Interpret the differences between cellular responses and humoral responses. • Carry out research and be able to present the findings on the reasons for antibiotic resistance in the treatments of infections. | | |
| Revision | Self-evaluation and Sample questions provided. | | |
| Assessments | Formative and Summative assessments to diagnose the learners ability. | | |
| Learning Objectives | Knowledge and Understanding <ul style="list-style-type: none"> • State the origin and describe the mode of action of phagocytes. • Describe the modes of action of B-lymphocytes and T-lymphocytes. • Explain the meaning of the term immune response, making reference to the terms antigen, self and non-self. • Explain the role of memory cells in long-term immunity. • Distinguish between active and passive, natural and | Skills <ul style="list-style-type: none"> • Recognise phagocytes and lymphocytes under a light microscope. • Relate the molecular structure of antibodies to their functions. • Interpret the differences between cellular responses and humoral responses. • Carry out research and be able to present findings on the reasons for antibiotic resistance in the treatments of infections. | Attitudes and Values <ul style="list-style-type: none"> • Support and promote national immunisation days. • Support and have sympathy for asthmatic patients. |

| | | | |
|--|--|--|--|
| | <p>artificial immunity and explain how vaccination can control disease.</p> <ul style="list-style-type: none">• Explain the role of antibodies in allergies.• Distinguish between generalised and localised allergic reactions.• Discuss the causes, symptoms and treatment of asthma and hay fever.• Discuss the reasons why vaccination programmes have eradicated smallpox but not measles, TB, malaria or cholera.• Define antibiotic as a substance produced by one microorganism that is capable of destroying or inhibiting the growth of another microorganism.• Explain how antibiotics work.• Explain the reasons for antibiotic resistance. | | |
|--|--|--|--|

Unit 16: Human Reproductive System and Gametogenesis

| | |
|-------------------------------|--|
| Introduction | <ul style="list-style-type: none"> • This unit discusses the structure of human male and female reproductive systems. • This unit describes the histology of mammalian ovary and testis. • This unit describes the gametogenesis in a male and a female. • This unit explains how spermatozoa are produced. • This unit also explains how oocytes are produced. • This unit also describes the significance of gametogenesis. |
| Content | Reproduction in humans, Male and female reproductive systems, Gametogenesis: spermatogenesis and oogenesis. |
| Number of Periods | 10 |
| Competences Practised | To be able to relate the structures of the human reproductive system to their functions and describe gamete formation. |
| Classroom Organisation | Whole class orientation, then group and individual work. |
| Equipment Required | Illustrations and computer aided study materials, prepared slides of testis and ovarian tissue, sperm and egg, microscopes, and small mammals (rat/rabbit/guinea pig). |
| Activities | <ul style="list-style-type: none"> • In pairs, learners dissect and identify structures of the reproductive system of male and female small mammals. • Learners use prepared slides or micrographs to study the histology of the testis and ovaries. • Prepare or use prepared slides to study the structure of gametes. • Learners analyse and interpret chart diagrams of spermatogenesis and oogenesis to find out their similarities and differences. • Learners discuss the significance of gametogenesis in terms of the haploid nature of gametes. |
| Language Practice | Discussion in groups, presentation of finding, writing notes. |
| Vocabulary Acquisition | Biological term use in human reproductive system and gametogenesis. |

| | | | |
|------------------------------|---|---|--|
| Competences Developed | <ul style="list-style-type: none"> • Relate the histology of the testis and ovary to their functions. • Analyse and interpret the chart diagrams of spermatogenesis and oogenesis. • Prepare the slides well to study the structure of gametes. • Research on gametes and their formation and deduce their findings. | | |
| Revision | Self-evaluation and Sample questions provided. | | |
| Assessments | Formative and Summative assessments to diagnose the learners ability. | | |
| Learning Objectives | Knowledge and Understanding | Skills | Attitudes and Values |
| | <ul style="list-style-type: none"> • Describe the structure of human male and female reproductive systems. • State where female and male gametes are produced. • Describe the histology of mammalian ovary and testis. • Outline gametogenesis in a male and a female human as a process involving mitosis, growth, meiosis and maturation. | <ul style="list-style-type: none"> • Relate the histology of the testis and ovary to their functions. • Analyse and interpret chart diagrams of spermatogenesis and oogenesis • Prepare the slides well to study the structure of gametes. • Research on gametes and their formation and deduce their findings. | <ul style="list-style-type: none"> • Appreciate the significance of the process of gametogenesis at puberty as a key characteristic of sexual maturity. • Acknowledge the relevance of meiosis during gametogenesis as an essential tool in maintaining the diploid condition after fertilization. |

| | | | |
|--|--|--|--|
| | <ul style="list-style-type: none"> • Explain how spermatozoa are produced. • Explain how oocytes are produced. • Explain the significance of gametogenesis. | | |
|--|--|--|--|

Unit 17: Genetics

| | |
|--------------------------|--|
| Introduction | <ul style="list-style-type: none"> • This unit discusses the concept of inheritance. • This unit also explains the terms gene, locus, allele, dominant, recessive, co-dominant, linkage, test cross, F1 and F2, phenotype, genotype, homozygous and heterozygous. • This unit describes how to conduct a test cross. • This unit discusses why monohybrid ratios of 1:2:1 occur. • This unit also explains Mendel's laws of inheritance: monohybrid inheritance, independent assortment and segregation. • This unit describes codominance, multiple alleles and lethal alleles. • This unit also explains dihybrid inheritance. • This unit explains linkage and crossing over. • This unit explains how the sex is determined in humans. • This unit also discusses the sex linkage and genetic disorders. |
| Content | Concept of inheritance, Definition of genetic terms, Mendel's laws of inheritance: monohybrid inheritance, independent assortment and segregation; Co-dominance, multiple alleles and lethal alleles; Dihybrid inheritance; Linkage and crossing over; Sex determination; Sex linkage; Genetic disorders. |
| Number of Periods | 18 |

| | |
|-------------------------------|---|
| Competences Practised | To be able to explain the role of genes in inheritance and how genetic disorders occur. |
| Classroom Organisation | Whole class orientation, then group and individual work. |
| Equipment Required | Online resources, CDs, simulations, diagrams, charts, micrographs, pedigree charts, illustrations, different plant seeds (e.g., beans and peas), animals, and money coins. |
| Activities | <ul style="list-style-type: none"> • Learners, in groups, use genetic diagrams provided to solve problems involving monohybrid and dihybrid crosses, including those involving autosomal linkage, sex linkage, co-dominance, multiple alleles and gene interactions. The focus is on problem-solving. • In groups, use genetic diagrams to solve the problems involving test crosses with the help of a chi-squared test to test the significance of differences between observed and expected results (the formula for the chi-squared test will be provided.). (See mathematical requirements). • Learners, using genetic crosses provided on the chart, calculate the phenotype and genotype ratios involving monohybrid and dihybrid crosses. • Discuss the effect of lethal genes on phenotype ratios. • Using uniform money coins, and beads/seed learners demonstrate monohybrid and dihybrid inheritance. • Use the provided pedigree chart showing the transmission of hemophilia to calculate the ratio of normal carriers hemophiliac and make presentation. |
| Language Practice | Discuss in group, presentation of finding. |
| Vocabulary Acquisition | Terms use in Mendel's law of inheritance, genetic term. |
| Competences Developed | <ul style="list-style-type: none"> • Analyse various patterns of inheritance. • Use genetic diagrams to solve the problems involving monohybrid and dihybrid crosses, including those involving autosomal linkage, sex linkage, and codominance, multiple alleles and gene interactions. (The term epistasis does not need to be used: knowledge of the expected ratio for various types of epistasis is not required. The focus is on problem solving). |

| | | | |
|----------------------------|--|--|---|
| | <ul style="list-style-type: none"> • Use the complete and accurate format to show a genetic cross and the results of a simple monohybrid cross. • Use genetic diagrams to solve the problems involving test crosses. • Use the chi-squared test to test the significance of the differences between observed and expected results (the formula for the chi-squared test will be provided). (See mathematical requirements). • Demonstrate monohybrid and dihybrid inheritance. • Interpret Pedigree charts. | | |
| Revision | Self-evaluation and Sample questions provided. | | |
| Assessments | Formative and Summative assessments to diagnose the learners ability. | | |
| Learning Objectives | Knowledge and Understanding | Skills | Attitudes and Values |
| | <ul style="list-style-type: none"> • Explain the terms gene, locus, allele, dominant, recessive, co-dominant, linkage, test cross, F1 and F2, phenotype, genotype, homozygous and heterozygous. • Explain how to conduct a test cross. • Explain why monohybrid ratios of 1: 2 :1 occur. • Describe an example of inheritance involving multiple alleles. | <ul style="list-style-type: none"> • Analyse various patterns of inheritance. • Use genetic diagrams to solve the problems involving monohybrid and dihybrid crosses, including those involving autosomal linkage, sex linkage, and codominance, multiple alleles and gene interactions. (The term epistasis does not need to be used: knowledge of the expected | <ul style="list-style-type: none"> • Appreciate the roles of genes in determining the phenotype and patterns of inheritance. |

| | | | |
|--|--|---|--|
| | <ul style="list-style-type: none"> • Explain the effect of lethal genes on phenotype ratios. • Give a genetic explanation of Mendelian dihybrid inheritance. • Explain the use of test crosses to determine unknown genotypes in studies of dihybrid inheritance. • Explain the significance of recombination. • Explain how sex is determined in humans and the role of sex related Y genes in determining sex. • Describe how non-disjunction can affect the distribution of sex chromosomes in gametes and offspring. • Explain why linked genes do not show independent assortment. • Explain how crossover values can be used to make a chromosome map. | <p>ratio for various types of epistasis is not required. The focus is on problem solving).</p> <ul style="list-style-type: none"> • Use the complete and accurate format to show a genetic cross and the results of a simple monohybrid cross. • Use genetic diagrams to solve the problems involving test crosses. • Use the chi-squared test to test the significance of the differences between observed and expected results (the formula for the chi-squared test will be provided). (See mathematical requirements). • Demonstrate monohybrid and dihybrid inheritance. • Interpret Pedigree charts. | |
|--|--|---|--|

Unit 18: Mutations

| | |
|-------------------------------|--|
| Introduction | <ul style="list-style-type: none"> • This unit introduces mutations. • This unit also explains the types of mutations: gene and chromosomal mutation. • This unit explains the differences between gene and chromosomal mutations. • This unit explains that gene mutation occurs by substitution, deletion, inversion and insertion of base pairs in DNA. Outline how such mutations may affect the phenotype. • This unit explains that the causes of mutation: chance, radiation, and chemical. • This unit describes about the effect of mutations on the phenotype. • This unit also discusses the effect of environment on the phenotype. • This unit explains the significance of mutations |
| Content | Mutations, Types of mutations: gene and chromosomal mutation, Differences between gene and chromosomal mutations; Causes of mutation: chance, radiation, and chemical; Effect of mutations on the phenotype; Effect of environment on the phenotype; Significance of mutations. |
| Number of Periods | 7 |
| Competences Practised | To be able to describe the types, causes and effects of mutation in organisms. |
| Classroom Organisation | Whole class orientation, then group and individual work. |
| Equipment Required | Online resources, CDs, computer simulations, diagrams, charts, micrographs, clay logs, and illustrations. |
| Activities | <ul style="list-style-type: none"> • In groups, discuss the differences between gene and chromosomal mutation and one possible effect on an organism. • Learners manipulate a thin clay log composed of different colours to represent different genes in order to show how an inversion can occur. • Use computer simulations to discuss the types and significance of mutations. • In groups, use charts and illustrations to show how sickle cell anaemia is inherited and outline the features of the offspring with or without sickle cell anaemia. |

| | | | |
|-------------------------------|--|--|--|
| Language Practice | Discussion in groups, presentation of finding. | | |
| Vocabulary Acquisition | Biological terms use in mutations. | | |
| Competences Developed | <ul style="list-style-type: none"> • Make a chart illustrating and summarising different kinds of gene and chromosomal mutations. • Distinguish between gene and chromosomal mutation. • Use a thin clay log composed of different colours to represent different chromosomes. • Manipulate the clay to show how an inversion can occur. • Use internet to search simulations of mutations and deduce the findings. | | |
| Revision | Self-evaluation and Sample questions provided. | | |
| Assessments | Formative and Summative assessment to diagnose the learners ability. | | |
| Learning Objectives | Knowledge and Understanding | Skills | Attitudes and Values |
| | <ul style="list-style-type: none"> • Define mutation. • Describe the types of mutation and causes of mutations. • Explain the significance of mutations. • Explain that gene mutation occurs by substitution, deletion, inversion and insertion of base pairs in DNA. Outline how such mutations may affect the phenotype. • Explain that the environment may affect the phenotype. | <ul style="list-style-type: none"> • Make a chart illustrating and summarising different kinds of gene and chromosomal mutations. • Distinguish between gene and chromosomal mutation. • Use a thin clay log composed of different colours to represent different chromosomes. • Manipulate the clay to show how an inversion can occur. | <ul style="list-style-type: none"> • Appreciate that mutations can bring about change in the genetic constitution of an organism and that these may or may not result in evolution. |

| | | | |
|--|--|--|--|
| | <ul style="list-style-type: none">• Outline the effects of mutant alleles on the phenotype in the following human conditions: albinism, sickle cell anaemia, haemophilia and Huntington's disease.• Explain the relationship between genes, enzymes and phenotypes with respect to the gene for tyrosinase involved in the production of melanin.• Explain how a change in the base sequence of the gene for haemoglobin results in abnormal haemoglobin and sickle- shaped red blood cells. | <ul style="list-style-type: none">• Use internet to search simulations of mutations and deduce the findings. | |
|--|--|--|--|

Unit 1: Interdependence between Organisms within their Environment

1.1 LEARNING OBJECTIVES

| Knowledge and Understanding | Skills | Attitudes and Values |
|---|---|---|
| <ul style="list-style-type: none">• Explain the various interactions of organisms in nature.• State the significance of organisms' interactions in nature.• Explain the terms interspecific and intraspecific competition.• Describe the adaptations of predators to catch and kill prey and adaptations of prey to avoid predators. | <ul style="list-style-type: none">• Compare interspecific and intraspecific competition.• Interpret graphs for predator-prey relationships.• Classify examples of species interactions, e.g. competition, predation, parasitism, commensalism, and mutualism. | <ul style="list-style-type: none">• Appreciate the relationships existing between organisms within their environment.• Recognise the role of saprophytes in mineral recycling. |

1.2 SAMPLE LESSON PLAN

School Name:

Teacher's Name:

| Term | Date | Subject | Class | Unit No. | Lesson No. | Duration | Class Size |
|---------------------------------|-------|--|-------|----------|------------|------------|-------------|
| I | | Biology | S5 | 1 | 1 of 2 | 40 minutes | 52 learners |
| Learners with SEN | | <p>Hearing Impairment (3): Make the learners sit in front of the teacher so that they can hear the lesson clearly.</p> <p>Visual Impairment (1): Make the learner sit so that he/she can see the teacher pointing at illustrations and see the teacher's facial expressions and gestures. Arrange for a Braille book if the learner is completely blind.</p> | | | | | |
| Unit Title | | Interdependence between organisms within their environment. | | | | | |
| Key Unit Competency | | To be able to explain the complex relationships between organisms within their environment. | | | | | |
| Title of the Lesson | | Interrelationship among organisms and their effects. | | | | | |
| Plan for this Class | | Inside the class | | | | | |
| Instructional Objectives | | Using their own examples, without consulting any document, the learners will be able to explain clearly the interrelationship among organisms and their effects. | | | | | |
| Materials | | <ul style="list-style-type: none"> • Pens, pencils, paper and textbook. • Braille textbooks if there are blind learners in the class. | | | | | |
| References | | <ul style="list-style-type: none"> • Advanced Level Biology Syllabus, Secondary 5, REB, 2015 • Comprehensive Biology Student's Book, Secondary 5 • Comprehensive Biology Teacher's Guide, Secondary 5 • Internet and library materials • English dictionary | | | | | |

| Timing | Description of Teaching and Learning Activity | | Generic Competences and Cross-cutting Issues to be Addressed |
|-----------------------------------|---|---|---|
| | The teacher begins the lesson by asking few introductory questions and then guides the learners to carry out an activity and study the lesson given in Student's Book. Thereafter, the teacher asks questions to assess the students' learning and to check whether the instructional objective is met. | | |
| | Teacher's Activities | Learner's Activities | |
| Introduction 10 minutes | <ul style="list-style-type: none"> Introduce the lesson by asking the learners following questions. <p>Questions:</p> <ol style="list-style-type: none"> What do you mean by the term 'interaction'? Do you think any organism in a community can exist without interacting with others? Give an example of interaction between organisms of same species. <ul style="list-style-type: none"> After the learners present their views, announce the new lesson title, <i>i.e.</i>, <i>Interrelationship among organisms and their effects.</i> | <ul style="list-style-type: none"> Learners will discuss among themselves and come up with the answers. <p>Possible answers:</p> <ol style="list-style-type: none"> Interaction means the way in which two or more things or people are connected and affect one another. No. Every organism interacts with other organisms within a community. Two members of a species competing with each other for food. | <p>Communication skills:</p> <p>The learners discuss with each other and express their views in the classroom.</p> |

| | | | |
|--|--|--|---|
| <p>Development of the Lesson 25 minutes</p> | <p>1. Pre-reading:</p> <ul style="list-style-type: none"> • Ask the learners to study various Biological interactions among organisms given in lesson 1 of the Student's Book and carry out Activity 1 given in the Student's Book. • After learners carry out the activity, ask them to state: <ol style="list-style-type: none"> 1. On what basis are the biological interactions classified? 2. What do the following signs indicate in an interaction? <ul style="list-style-type: none"> (+) (-) (0) 3. Classify the various biological interactions among organisms. 4. What are the effects of different biological interactions. | <ul style="list-style-type: none"> • Learners will study the lesson and carry out the activity. • Learners expected answers to the questions. <ol style="list-style-type: none"> 1. Biological interactions can be generally classified into different categories based on whether the effects of interactions are beneficial, harmful or neutral for each of any two species. 2. The sign (+) indicates that a particular species is benefiting from the interactions. The sign (-) indicates that a particular species in the interactions is being harmed. And sign (0) simply indicates neutral position where it is neither benefited nor harmed in the interactions. | <p>Cross-cutting Issues</p> <p>Peace and Values Education:</p> <p>Discussion among the learners from different backgrounds during learning promotes social cohesion which builds a more peaceful society.</p> |
|--|--|--|---|

| | | | |
|--|--|---|--|
| | | <p>3. Various biological interactions can be classified as:</p> <ul style="list-style-type: none">(i) Competition type: Populations of two or more species are affected adversely.(ii) Parasitism: One organism benefits and the other is harmed.(iii) Predation: One organism kills and consumes another.(iv) Mutualism: The interacting species mutually benefit from each other.(v) Commensalism: One species is benefited while the other species is neutral or is not benefited. | |
|--|--|---|--|

| | | | |
|--|--|--|--|
| | | <p>(vi) Saprophytism: The condition of certain living organisms feeding and living on dead organic matter.</p> <p>4. These biological interactions have the potential to influence and mould the structure, growth, and maintenance of populations within a community. In some cases, these may result into long-term ecological and evolutionary changes among the individuals participating in these interactions.</p> | |
| <p>Conclusion and Lesson Assessment 5 minutes</p> | <p>Summary</p> <ul style="list-style-type: none"> • Ask the learners what they have learned in today's lesson. | <ul style="list-style-type: none"> • The learners summarize what they have learned in today's class. | |

| | | | |
|--|--|--|--|
| | <p>Assessment</p> <ul style="list-style-type: none"> • Ask the following question: <ul style="list-style-type: none"> – Using your own examples, without consulting any document, explain clearly the interrelationship among organisms and their effects. | <ul style="list-style-type: none"> – Biological Interactions are a concept of different organisms interacting with one another within a community. – Competition: An interaction of two organisms striving for the same resource – Parasitism: A relationship where one organism benefits and the other is harmed. – Predation: An interaction between species in which one species (predator) uses another species as food (prey). – Mutualism: An interaction where the interacting species mutually benefit from each other. | |
|--|--|--|--|

| | | | |
|----------------------------------|--|---|--|
| | | <ul style="list-style-type: none"> – Commensalism: An interaction in which one species is benefited while the other species is neutral or is not benefited. – Saprophytism: A condition of certain living organisms feeding and living on dead organic matters. | |
| Teacher's Self-evaluation | <ul style="list-style-type: none"> • Were all the learners able to explain clearly the interrelationship among organisms and their effects? • Were all the SEN learners able to explain clearly the interrelationship among organisms and their effects? • Any changes needed in teaching approach? | | |

1.3 TEACHING AIDS

Visual: Images of interactions of organisms.

Audio-video: Video showing the interactions of organisms in nature and its significance.

1.4 TEACHER'S TIP

Teacher starts the unit by briefing the learners about interactions of organisms in nature. Every organism interacts with other organisms within a community. The various interactions are competition, parasitism, predation, saprophytism, mutualism, and commensalism. Using photographs and explaining examples, brief up the interactions. Also, state their significance in nature.

1.5 TEACHING METHODS

Brainstorming, short lecture technique, group discussion technique, observation technique, drawing technique, demonstration technique, and practical work.

1.6 TEACHING AND LEARNING MATERIALS

Ecological charts and graphs, audio visual data, computer aided material, and video-film materials (e.g., clips from YouTube).

1.7 TEACHING METHODOLOGY

Teacher initiates the topic by introducing basic vocabulary about ecological relationships (symbiosis, mutualism, competition, parasitism, commensalism) and asking them to study about these. Teacher assists them to draw diagrams, make charts.

Teacher also discusses the types of the interactions. Start by asking the learners to tell any of the examples they could cite.

Learners reply to the questions raised by the teacher.

Appreciating them, teacher further asks if they are aware of the effects of the interactions.

Learners will come up with varied answers. Some correct, some near to correct, others being irrelevant.

Teacher will not demotivate the child. But agreeing to the correct answers, dwells further in discussion.

Using short lecture technique, teacher will explain the importance of interactions.

Teacher further explains the learners different adaptations and examples related to interactions of organisms.

1.8 ADDITIONAL CONTENT FOR THE TEACHER

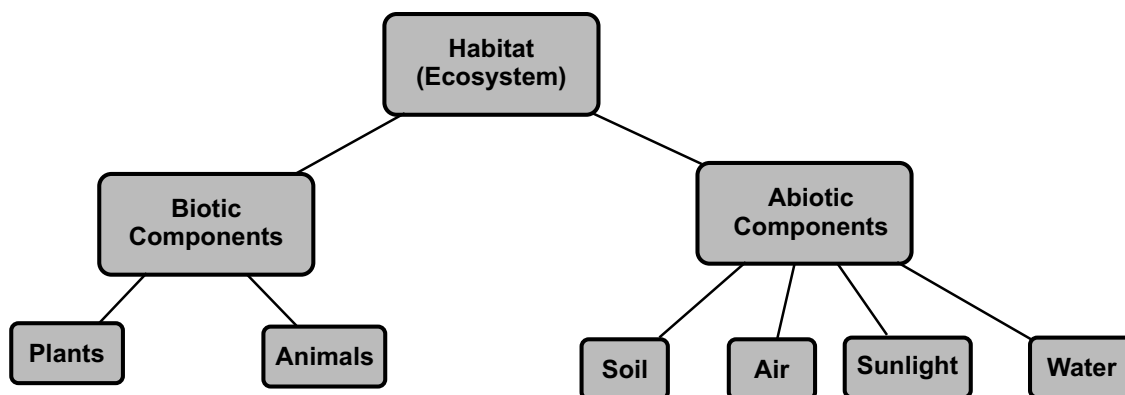

Activity

Aim: Compare interspecific and intraspecific competition and give one example each.

Instruction

1. Learners are expected to differentiate between interspecific and intraspecific competitions.
2. They should give the subdivision of both interspecific and intraspecific competitions. Example: Exploitative competition, interference competition, etc.
3. They should support every subdivision with an example.
4. Schematic diagrams should be drawn.

1.9 SUMMARY

- The basic species interactions are competition (direct interference type), competition (resource use type), commensalism, parasitism, predation, mutualism and saprophytism.

Competition

- Competition is an interaction of two organisms striving for the same resource. It is of two types: Interspecific competition is a competition of individuals of the same species competing for a limited resource, while intraspecific competition is a competition of different species competing for a limited resource.
- Competition helps in structuring ecological communities and also plays an important role in character displacement.

Parasitism

- Parasitism is a relationship between two organisms where one benefits and the other is harmed. The two types of parasitism are: Ectoparasite and endoparasite. A social parasite is a parasite that takes advantage of the interaction of other organisms.
- Parasitism alters the behaviour and morphology of their hosts; it promotes coexistence in biodiversity; it affects the keystone species and modifies the structure of ecosystem.

Predation

- Predation is an interaction between species in which one species (predator) uses another species as food (prey). It can be divided into: Carnivory, parasitism, cannibalism, herbivory.
- Predation prevents a single species from becoming dominant; it also either increases or decreases species' richness; and it acts as a source of natural selection.

Mutualism

- Mutualism is an interaction of two or more species where the interacting species mutually benefit from each other so much that they become completely dependent on one another. Example: Bees and flower.
- Mutualism helps in moulding or structuring community towards better species interactions.

Commensalism

- Commensalism is an interaction of two or more species in which one species is benefited while the other species is neutral or is not benefited. Example: Cattle egret and cattle.
- It helps in determining the function and structure of populations and communities.

Saprophytism

- Saprophytism is a condition of certain living organisms feeding and living on dead organic matters. Example: Pink Indian pipe.
- Many micro saprotrophs and other decomposers, involving insects, snails, beetles, help in recycling valuable nutrients such as iron, calcium, potassium and phosphorous from dead organic matter which is released back into the soil to be reabsorbed by plants.

1.10 WEBLINKS FOR CONTENT ENRICHMENT

- <http://www.nature.com/scitable/knowledge/library>
- <https://www.khanacademy.org/partner-content/CAS-biodiversity>
- <http://study.com/academy/topic/interaction-among-organisms-in-the-ecosystem.html>

1.11 LEARNERS' ACTIVITIES

Activity 1

The teacher should guide the learners to carry out the activity on their own.

Hint:

- Learners are expected to know what biological or species interaction is all about.
- They should know why + and – signs are used for the species interactions.
- They should classify all types of species interactions and their effects, which are clearly given in the text.

For example:

| Types of interaction | Effect on Species 1 | Effect Species 2 | General nature of interaction |
|----------------------|---------------------|------------------|---------------------------------|
| 1. Parasitism | + | – | Population 1 harms population 2 |

Activity 2

The teacher should guide the learners to carry out the activity on their own.

Hint:

1. In this activity, learners have to classify and write only on few of the relationships given in the text, which are:
 - (a) Competition
 - (b) Parasitism

- (c) Predation
 - (d) Mutualism
 - (e) Protocooperation
 - (f) Commensalism
 - (g) Saprophytism
2. One example each should be given.
 3. Diagrams should be drawn if it is feasible.

Activity 3

The teacher should guide the learners to carry out the activity on their own.

Hint:

1. Any type of predator-prey relationship animation can be shown. Example: Lion chasing and killing a deer. Lion is the predator and deer is the prey. Observe the relationship. Ask questions such as: What will happen to lions if deer population is very much reduced or in vice versa.
2. In the same way, you can download any wildlife video clips that have predator-prey relationship. It could be tiger and zebra; snake and frog etc. By the way, these clips can be downloaded from www.youtube.com.
3. After you let the learners watch either the animation or wildlife video clips, let them discuss the relationship between the predator and prey.
4. Relate the observation with the predator-prey relationship cycle.

Activity 4

The teacher should guide the learners to carry out the activity on their own.

Hint:

1. Let the learners plot a graph using the data provided.
2. They can do it manually using graph papers or computer device to plot a graph (example: Microsoft Excel).
3. Once they have plotted, let them study the pattern of oscillation for both predator and prey.

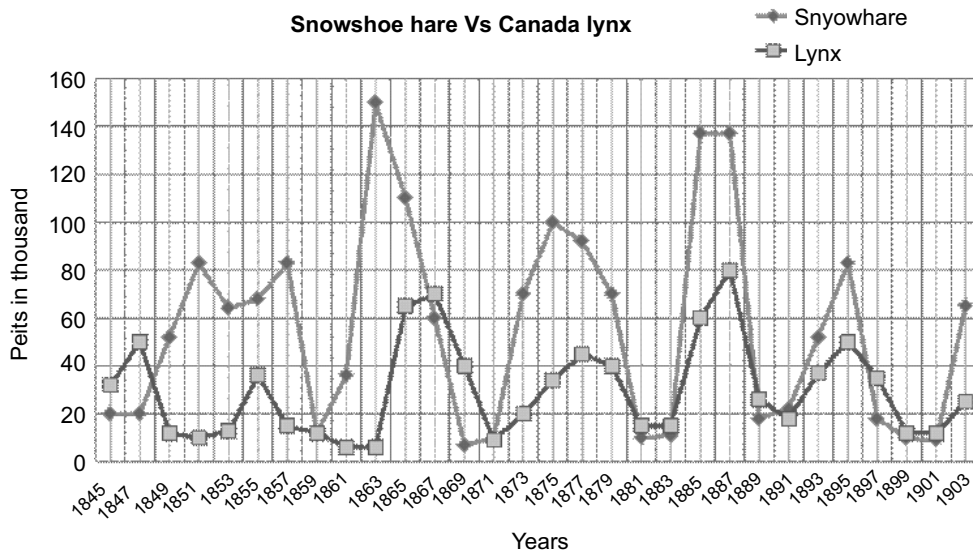

Prey-predator relationship graph (prey = Snowshoe hare; predator = lynx)

4. Let them give their conclusion as to whether the graph follows the predator-prey relationship cycle.

Answer/ Conclusion

The given graph follows the prey-predator pattern (oscillation) as there is a **regular pattern** of increase and decrease of prey and predator population.

1.12 ANSWERS TO STUDENT'S BOOK SELF-EVALUATION

Self-evaluation

- (i) Intraspecific
- (ii) Gause exclusion principle
- (iii) Social parasite
- (iv) on the host

Self-evaluation

- (i) Predator
- (ii) Natural selection
- (iii) Predation
- (iv) batesian mimicry

Self-evaluation

- (i) benefits
- (ii) commensalism
- (iii) Saprophytes
- (iv) commensalism

1.13 ANSWERS TO END UNIT ASSESSMENT 1

I. Choose whether the given statements are True (T) or False (F):

1. **False**; Organisms interactions can be both beneficial or harmful.
2. **False**; Commensalism benefits both species.
3. **True**; Competing for food involves fewer similar needs and different adaptations.
4. **True**; Herbivory involves a predator like goat feeding on prey as grass.
5. **False**; When keystone predator feeds on dominant prey, it generally promotes species richness by releasing the inferior prey species to coexist with the dominant species.
6. **True**; Oscillation is characterized by regular pattern of increase and decrease population.
7. **False**; Parasitism promotes coexistence in biodiversity. Usually in an ecosystem, competitively dominant species out-competes a competitively inferior species and doesn't allow coexistence with this species.

II. Multiple choice questions:

1. **(a), (d), (c)**; Commensalism, mutualism and protocooperation involves species benefitting.
2. **(c)**; Interference competitions are a form of species interaction in which two species compete for a shared resource.
3. **(d)**; All the above.
4. **(a)**; Saprophytes recycle minerals.
5. **(d)**; Brood parasitism is an interaction where the parasite, typically a bird, deposits its eggs in the nest of another species. Example: Cuckoo bird.
6. **(c)**; Sexual cannibalism is type of cannibalism in which a female organism kills and consumes a conspecific (same species) male before, during, or after copulation. Rarely, males eat females. Examples: black widow spider, praying mantis, and scorpion.

7. **(a)**; Flea on dog is an example of parasitism.
8. **(d)**; Saprophytes are living organisms which feed on dead organic matters such dead plant or animal tissue. In this regard, they are detritivores. They break down organic matters into simpler forms that can be taken up and recycled by plants. Thus, they play every important role soil biology. Examples are most fungi (molds), bacteria, and few flowering plants such as Indian pipe and some orchids.
9. **(b)**; A commensal is a species that benefits from the association.
10. **(c)**; In mutualism, bees depend on flowers for food in the form of nectar and pollen. And the flowering plants depend on bees or other pollinators to carry their male reproductive cells specifically to the female parts of other flowers of the same species.

III. Long answer type questions:

1. The basic species interactions are competition, commensalism, parasitism, predation, mutualism and saprophytism.

Competition

Competition is an interaction of two organisms striving for the same resource. It is of two types: Interspecific competition is a competition of individuals of the same species competing for a limited resource, while intraspecific competition is a competition of different species competing for a limited resource.

Competition helps in structuring ecological communities and also plays an important role in character displacement.

Parasitism

Parasitism is a relationship between two organisms where one benefits and the other is harmed. The two types of parasitism are: Ectoparasite and endoparasite. A social parasite is a parasite that takes advantage of the interaction of other organisms.

Parasitism alters the behaviour and morphology of their hosts; it promotes coexistence in biodiversity; it affects the keystone species and modifies the structure of ecosystem.

Predation

Predation is an interaction between species in which one species (predator) uses another species as food (prey). It can be divided into: Carnivory, parasitism, cannibalism, herbivory.

Predation prevents a single species from becoming dominant; it also either increases or decreases species' richness; and it acts as a source of natural selection.

Mutualism

Mutualism is an interaction of two or more species where the interacting species mutually benefit from each other so much that they become completely dependent on one another. Example: Bees and flower.

Mutualism helps in moulding or structuring community towards better species interactions.

Commensalism

Commensalism is an interaction of two or more species in which one species is benefited while the other species is neutral or is not benefited. Example: Cattle egret and cattle.

It helps in determining the function and structure of populations and communities.

Saprophytism

Saprophytism is a condition of certain living organisms feeding and living on dead organic matters. Example: Molds (mushrooms).

Many micro saprotrophs and other decomposers, involving insects, snails, beetles, help in recycling valuable nutrients such as iron, calcium, potassium and phosphorous from dead organic matter which is released back into the soil to be reabsorbed by plants.

2. Adaptation in Predator Species

Based on their experience, predators also undergo certain adaptations to be an efficient hunter or killer. These adapted traits are passed down from generation to generation. **Predators** exhibit traits such as sharp teeth, claws, and venom that enhance their ability to catch food. They also possess extremely acute sensory organs that help them to find the potential prey. Depending upon the requirement that arises, predators also adapt themselves to become much more efficient. Examples of some adapted animals are:

- (a) The ability of raptors to spot potential prey from over a kilometre away.
- (b) The acute sense of smell of moles.
- (c) The ability of owls to locate mice by sound.
- (d) The ability of pit vipers to sense body heat while tracking prey.
- (e) The ability of bats and dolphins to echolocate.

Predators catch their prey either by pursuing potential prey or by ambushing them. Organisms that give chase are capable of short bursts of speed like Cheetah. Those that lie in wait tend to be camouflaged to avoid detection.

Adaptation in Prey Species

In the same way, as much as predator adapts itself to capture its prey, preys also adapt as much as possible to escape from the predators. Many, such as leaf insects, moths, a variety of frogs and small lizards, and herbivorous mammals, are cryptically coloured to make them more difficult to see.

Behaviourally, they freeze after detecting the presence of a predator. This lack of movement helps them better blend in with their background and inhibits the ability of the predator to find them. But when the predators venture too close, prey will take flight, running or flying to escape. When a chase ensues, prey will typically survive if they stay out of reach until the predator tries.

Some species take extra time by distracting the predator. Examples include moths that flash brightly coloured hind-wings, lizards that drop their tails, and insect larvae that discharge slime. Such actions surprise the predator and give the prey a few extra moments to escape.

Mimicry

Some prey exhibit bright colouration signalling as poisonous individuals. Such aposematic colouration helps prevent predation by signalling to potential predators that the vividly-coloured individual is toxic. Toxins may be manufactured within the body, as with the **red-spotted newt**, or they may be acquired passively via consumption of toxic plants, as with the **monarch butterfly**.

Not all the species that exhibit vivid colouration are truly toxic. Some have evolved patterns and colours that mimic those of toxic species. Examples of such **Batesian mimicry** include the extraordinarily polymorphic *Papilio dardanus* swallow tail butterfly in southern Africa and Madagascar. Females of this species occur in a wide variety of physical appearances, nearly all of which mimic distasteful species of the *Danaeus* and *Amauris* genera with which they co-occur.

Adaptation in Herbivory

Herbivory is the consumption of plant material by animals, and herbivores are animals adapted to eat plants. As in predator-prey interactions, this interaction drives adaptations in both the herbivore and the plant species it eats.

Adaptation in Plants

Though plants cannot move like animals, they also develop certain mechanism to escape from herbivores. For example, plants have evolved defences, including thorns and chemicals, to keep themselves away from being eaten

by herbivores. Scientists have identified thousands of plant chemical defense compounds, including familiar compounds such as nicotine and cocaine.

Adaptation in Herbivores

To counteract the adaptation of plants and maximize the nutrient intake, **herbivores** also have adapted themselves that allow them to determine which plants contain fewer defensive compounds and more high-quality nutrients.

Some insects, such as butterflies, have chemical sensors on their feet that allow them to taste the plant before they consume any part of it. Mammalian herbivores often use their keen sense of smell to detect bitter compounds, and they preferentially eat younger leaves that contain fewer chemicals.

3. The term “saprophyte” is a misnomer. By definition, “Phyte” means a plant, and bacteria and fungi are not categorized as plants. Most of the saprophytes lack chlorophyll, and therefore, cannot perform photosynthesis. Thus, they depend on the food energy they absorb from the decaying organic matters. This means that they are heterotrophs and are considered consumers in the food chain.

They are characterized by their use of a particular kind of digestion mechanism, called extra-cellular digestion. In this process, they secrete digestive substances into the surrounding environment through which they break down organic matter into simpler substances. The nutrient-rich broken organic substances are then directly absorbed through the membrane of the organism’s cells and are metabolized.

One of the most common saprophytic fungi belongs to Rhizopus family. These fungi have an extensive network of hyphae, similar to tiny roots, which grow through the organic matter. They grow in a network called a mycelium. Mycelium helps the fungus to penetrate the organic matter where the hyphae secrete digestive enzymes and absorb the resulting nutrients.

Many micro saprotrophs and other decomposers, involving insects, snails and beetles help in recycling valuable nutrients from dead organic matter which is released back into the soil to be reabsorbed by plants. For example— in a rainforest ecosystem, to promote healthy rainforest, nutrients such as iron, calcium, potassium and phosphorus are essentially required. The decomposers derive these essential nutrients from decaying organic matters and then release into the soil where the plants reabsorb it again.

4. Difference between Intraspecific and Interspecific Competition

| S.No. | Intraspecific Competition | S.No. | Interspecific Competition |
|-------|--|-------|---|
| 1. | It is a competition among the individuals of the same species. | 1. | The competition is among the members of different species. |
| 2. | The competition is for all the requirements. | 2. | The competition is for one or a few requirements. |
| 3. | The competing individuals have similar type of adaptation. | 3. | The competing individuals have different types of adaptations. |
| 4. | It is more severe due to similar needs and adaptations. | 4. | It is less severe as the similar needs are a few and the adaptations are different. |
| 5. | Example includes finding mating partners. | 5. | Example includes competition for food. |

5. Predator-prey relationships are characterized by oscillation of both predator and prey populations over a period of time. By **oscillation**, we mean there is a regular pattern of increase and decrease of populations of both predator and prey. Generally, the predator is a carnivore, while the prey is a herbivore. However, this general truth may vary depending upon the kind of predator-prey interactions. For example, parasites become predator when they feed on their host (prey); herbivores become predator when they feed on plants (prey).

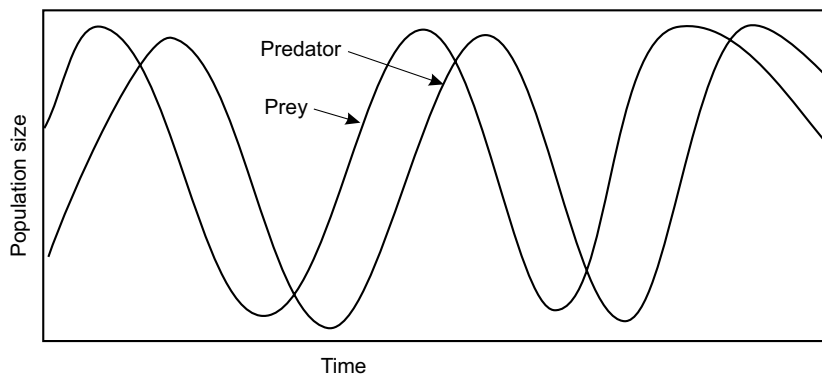

The main reason of oscillation is that as the predator population increases, it progressively consumes larger number of prey until the prey population starts to decline. Then the declining prey population no longer supports the large increasing predator population. As the prey population declines, the predator now faces a food shortage, and many of them starve or fail to reproduce. As a result, the predator population declines sharply to a point where the reproduction of prey more than balances its losses through predation. Eventually, the population of prey increases, which is followed by an increase in the population of predators. In this manner, there is a regular pattern of increase and decrease in the population of both prey and predator over a time period.

6. (a) **Predation:** It is an interaction between the two species, i.e., predator and prey, in which one species (predator) uses another species as food (prey). Examples-Lion attacking buffaloes, Herbivory: Deer eating grass.
 - (b) **Parasitism:** It describes a relationship between two organisms where one benefits and the other is harmed. Examples-A flea on a dog's skin, Tapeworms are endoparasites.
 - (c) **Commensalism:** It is an interaction of two or more species in which one species is benefited while the other species is neutral or is not benefited. Examples-crab inside oyster, cattle egrets and cattle.
 - (d) **Mutualisms:** It is an interaction of two or more species where the interacting species mutually benefit from each other. Examples-Bee and flower, Human intestine harbouring *E.coli*.
7. Interrelationship among organisms include various interactions prevalent in the environment. These include competition, commensalism, parasitism, predation and mutualism. The impact organisms have on one another also influences the environment. These interactions play a major role in evolution of the organisms. The one that survives evolves according to the environment thus leading a sustainable way paving way for evolution.

Not only do interactions create evolution but also maintain and balance the energy flow of matter by feeding on one another. This way they help in the continuity of proper functioning of food chain. For example:

Parasitism in organism promotes coexistence in biodiversity. Herbivory and carnivory impose strong selective pressures on the predators to evolve into most effective predator against the prey. Thus, evolving the two parties together resulting in coevolution. Interrelationships also help in structuring communities of organisms for a better future. This creates favourable environment for both the organisms to sustain harsh and unfavourable conditions and thrive in the ecosystem. For example:

A lichen is an organism that results from a mutualistic relationship between a fungus and a photosynthetic organism. The other organism is usually a cyanobacterium or green algae. The fungus grows around the bacterial or algal cells.

Further, the interrelationships aid in recycling valuable nutrients from dead organic matter, releasing the nutrients back into the soil to be reabsorbed by plants.

For example: Decomposers or saprophytes decay organic matters and release iron, calcium, phosphorous and other essential minerals back into the soil for the plants to reabsorb.

8. The three main ecosystem roles an organism can occupy are producers, consumers, and decomposers.

Producers can synthesize sugars for energy from an abiotic source in processes such as the following:

- Photosynthesis in plants and algae, where the energy in sunlight is absorbed and transformed into the chemical bonds of sugar.
- Chemosynthesis in deep ocean bacteria, where the oxidation of inorganic compounds exuded from hydrothermal vents act as an energy source. This is done in the absence of light.

Consumers rely on the consumption of other organisms as a source of organic compounds, other nutrients, and energy.

Herbivores, organisms which consume only plants, are known as primary consumers. Carnivores, organisms which predate on (“eat”) other animals, are known as higher level consumers (secondary, tertiary, quaternary, etc).

Decomposers obtain energy and organic compounds from decaying dead organisms, recycling nutrients (mainly nitrogen and phosphorus) back to producers in the process.

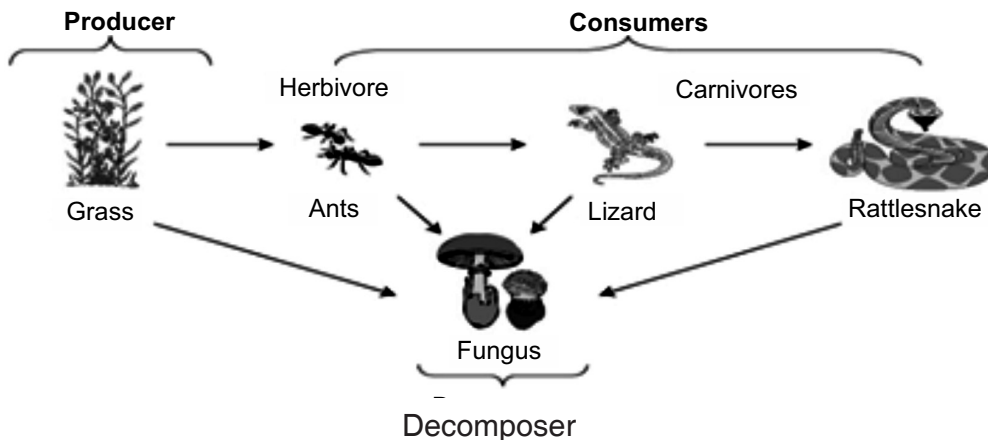

Food chains can be used to visualize the relationship of these three groups. However, ecosystems are more accurately represented by multiple combinations of food chains called a food web.

Roughly 90% of energy is lost through each connection in a food web due to heat and waste loss in organisms. Therefore, producers tend to be more abundant (in biomass) than herbivores, herbivores more abundant than carnivores, etc., in order for each group to have enough energy to sustain their populations. This produces what is known as an ecological pyramid.

1.14 ASSESSMENT METHODS

Use observation technique, question answer technique, and demonstration technique to assess the learners' achievement of learning objectives.

1.15 ASSESSMENTS

Formative Assessment

Fill in the blanks:

1. butterflies acquire toxins via consumption of plants.
2. Bats and dolphins have ability to
3. Fleas, ticks and mites are
4. affects the keystone species and modifies the structure of the ecosystem.

Ans. 1. Monarch, 2. Echolocate, 3. Ectoparasites, 4. Parasitism

Summative Assessment

Answer in one word:

1. A hawk preys on both squirrel and mice. It shows which competition?
2. Shark eating a tuna is an example of which interaction?
3. A competition where species exploits a resource?

Ans. 1. Apparent competition, 2. Carnivory predation, 3. Exploitative competition

Unit 2: Transport Across the Cell Membrane

2.1 LEARNING OBJECTIVES

| Knowledge and Understanding | Skills | Attitudes and Values |
|---|--|--|
| <ul style="list-style-type: none">• Describe and explain the processes and significance of movement in and out of the cell mentioned in the content.• Recall that the increasing size of organisms is constrained by its ability to obtain resources through diffusion across the cell surface and its ability to move substances out of cells.• Explain the movement of water between cells and solutions with different water potentials and explain the effects on plant and animal cells. | <ul style="list-style-type: none">• Apply the knowledge of hypertonic environments in food preservation by salting.• Carry out an investigation on simple diffusion by using plant tissues and non-living materials.• Research adaptations of plants and animals to salty habitats.• Interpret and present data in graphic and table form on the effects of varying concentrations of: e.g. sugar, salt on plant and animal tissues• Distinguish between endocytosis and exocytosis. | <ul style="list-style-type: none">• Appreciate the importance of movement of substances across cells.• Show concern when exposing living organisms to concentrated media. |

2.2 TEACHING AIDS

- **Visual:** Images of diffusion, osmosis and other processes in cells.
- **Audio-video:** Video showing the processes of diffusion and osmosis.

- **Vocabulary:** Some terms used such as diffusion, osmosis, hypotonic, hypertonic, isotonic, plasmolysis, phagocytosis, pinocytosis.

2.3 TEACHER'S TIP

Start the unit by introducing the learners to the various terms. Tell them about the selective plasma membrane and transport across it. Show the learners photographs of different types of transport. Using photographs, make them aware of key concepts involving diffusion and osmosis. Also make them aware of the gradients involved. Also tell them the significance of these processes.

2.4 TEACHING METHODS

Brainstorming, short lecture technique, group discussion technique, observation technique, drawing technique, field visit, and practical work.

2.5 TEACHING AND LEARNING MATERIALS

Potato tubers, pawpaw petioles, unripe pawpaw fruits, filamentous algae, onion epidermis, slides and microscopes, visking tubing, knives, potassium permanganate, methylene blue, water, sucrose solutions of varying concentrations, and animal tissues e.g. blood smear of a frog.

2.6 TEACHING METHODOLOGY

Teacher initiates the topic by introducing basic knowledge about plasma membrane and importance of movement of substances across cells. Teacher assists them to draw diagrams, make charts.

Teacher also discusses about types of the movements. Start by asking the learners to tell any of the examples they could cite.

Learners reply to the raised questions by the teacher.

Appreciating them, teacher further asks if they are aware of different types of solutions.

Learners will come up with varied answers. Some correct, some near to correct, others being irrelevant.

Teacher will not demotivate the child. But agreeing to the correct answers, dwell further in discussion with the help of examples and performing activities.

Using short lecture technique, teacher will explain diffusion and osmosis.

Teacher further explains the learners about the different factors affecting the process.

2.7 ADDITIONAL CONTENT FOR THE TEACHER

| Type of Movement | Energy Required? (Passive or Active Transport) | What Type of Particle is Moved? | What Part of the Membrane is the Particle Moving through? | How does it Work? Explain |
|-----------------------|--|--|---|--|
| Diffusion | No energy needed. Passive transport | O ₂ CO ₂ | Lipid bi-layer | Particles diffuse through the membrane until the concentrations in/out of the cell are balanced (equilibrium). |
| Osmosis | No energy needed. Passive transport | H ₂ O | Lipid bi-layer | Water moves through the membrane until concentrations in/out of the cell are at equilibrium. |
| Facilitated Diffusion | No energy needed. Passive transport | Glucose, sodium, potassium, calcium | Protein channel | Particles move from high to low concentrations through the protein channel. |
| Molecular Transport | Energy needed. Active transport | Sodium, calcium, potassium | Protein pump | The cell uses energy to pump the particles against the concentration (from low to high!). |
| Endocytosis | Energy needed. Active transport | Large molecules or clumps of material such as glucose. | The whole membrane. | The particle(s) are too big to fit through the proteins or lipids so that the cell membrane folds over the particles and then pinches off. |
| Exocytosis | Energy needed. Active transport | Large molecules, clumps of material such as waste or proteins. | The whole membrane | The membrane folds and pinches together to allow the particles to escape. |

Activity

The teacher can demonstrate this activity in the class.

Aim: To make learners understand about transport of materials across plasma membrane.

Ask the learners to make an illustrative model of mechanism of active and passive transport.

Ask each learner to make it individually and explain the process as a part of their presentation.

Ask them to use colourful balls of various sizes or glaze papers to make models.

2.8 SUMMARY

- Every cell is surrounded by cell or plasma membrane which regulates the movement or exchange of ions or molecules between the cell and its medium. This property of cell is called **cell permeability**.
- The presence of concentration and membrane potential (together called **electro-chemical** gradient) helps in the movement of substances across the membrane.
- Plasma membrane mediates transport of smaller molecules by **passive** and **active transport** whereas larger molecules are transported by **endocytosis**.
- In **passive transport**, ions/molecules move from higher concentration to lower concentration which includes diffusion and osmosis and there is no utilization of energy.
- **Simple diffusion** is the movement of small hydrophobic molecules from higher concentration to lower concentration by dissolving in phospholipid bilayer till equilibrium is reached.
- **Osmosis** is a movement of water molecules from low solute concentration to high solute concentration side (or from higher solvent concentration to lower solvent concentration).
- **Active transport** is the movement of ions/molecules from lower concentration to higher concentration. It is of two types: **Primary** and **Secondary active transport**. The former involves direct utilization of energy in the form of ATP hydrolysis while the later involves movement of molecules against concentration gradient but coupled with the movement of a second molecule in an energetically favourable direction without direct utilization of ATP. The movement may be **symport**, **uniport** or **antiport**.
- **Endocytosis** is the ingestion of large particles such as bacteria, macromolecules and fluids into the cell in the form of small vesicles. It is further

of two types, viz., **phagocytosis** (cell eating, engulfing of solid particles) and **pinocytosis** (cell drinking, uptake of liquid fluids).

2.9 WEBLINKS FOR CONTENT ENRICHMENT

- <https://www.youtube.com/watch?v=RPAZvs4hvGA>
- <http://www.bbc.co.uk/education/guides/zydsgk7/revision>
- <http://www.ncbi.nlm.nih.gov/books/NBK21525/>

2.10 LEARNERS' ACTIVITIES

Activity 1

Step 1: The teacher should ask the learners to stand in close proximity to resemble a plasma membrane. Explain them how.

Step 2: Assist them by understanding transport mechanism by throwing two balls—one big one small.

Step 3: Ask them to observe and answer which ball could pass easily and why.

Activity 2

Step 1: Assist the learners to perform activity as directed in text.

Step 2: Guide the learners to solve calculations and provide them with formulas. Further, dwell them to a class discussion on the same. Develop the understanding of selective behaviour of cell membrane.

Activity 3

Step 1: Assist the learners to perform activity as directed in the text.

Step 2: Engage the learners in a group discussion to discuss their results.

Activity 4

Step 1: Guide the learners to bring materials for experiment.

Step 2: Assist them to understand and perform the activity as directed in the procedure.

Step 3: Ask the learners to present their results and discuss the same.

Activity 5

Step 1: Guide the learners to bring materials for experiment, including graph paper.

Step 2: Assist them to understand and perform the activity as directed in the procedure.

Step 3: Ask the learners to present their results and answer the questions raised in the activity.

2.11 ANSWERS TO SELF-EVALUATION

Self-evaluation

- (i) shrinks
- (ii) diffusion
- (iii) osmosis
- (iv) Turgor pressure
- (v) higher

Self-evaluation

- (i) pinocytosis
- (ii) active transport
- (iii) antiport
- (iv) Phagocytosis
- (v) Christian de Duve

2.12 ANSWERS TO END UNIT ASSESSMENT 2

I. Choose whether the given statements are True (T) or False (F):

- | | | |
|----------|----------|----------|
| 1. True | 2. False | 3. False |
| 4. True | 5. False | 6. True |
| 7. False | 8. True | 9. False |
| 10. True | | |

II. Multiple choice questions:

- | | | |
|--------|--------|--------|
| 1. (a) | 2. (b) | 3. (b) |
| 4. (b) | 5. (a) | 6. (c) |
| 7. (c) | | |

III. Long answer type questions:

1. Transport mechanisms can be broadly classified into two types:

Passive Transport: It involves the movement of molecules along the electrochemical gradient without the use of ATP (Downhill transport). Occurs by diffusion or osmosis.

Active Transport: It drives the molecules against their electrochemical gradient by hydrolysis of ATP (Uphill transport).

Below is an account of different means of transport across the plasma membrane:

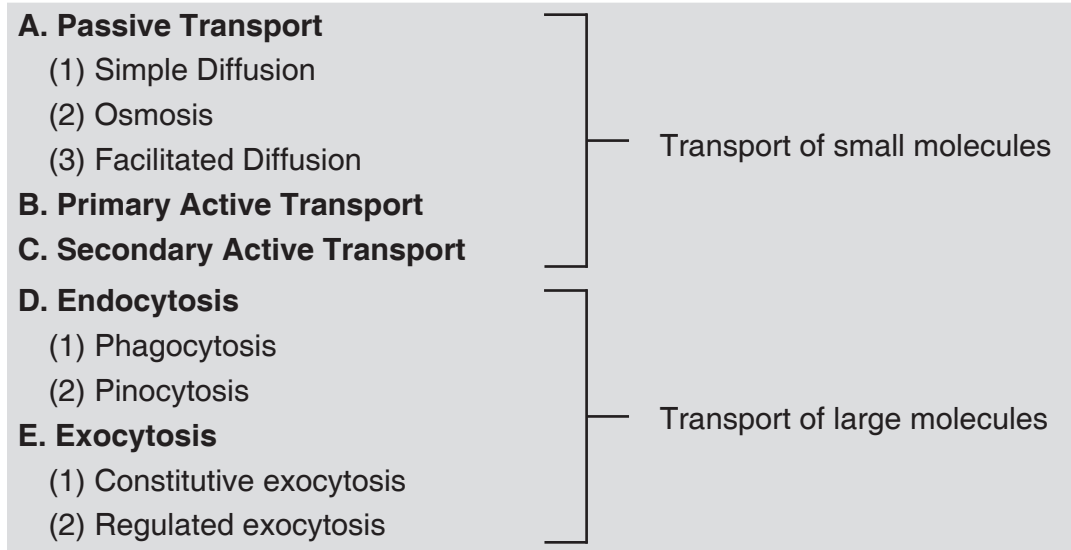

Passive Transport

Simple diffusion

It is the simplest mechanism in which a molecule dissolves in the phospholipid bilayer, diffuses across it and then dissolves in the aqueous solution present on the other side of the cell membrane. It neither requires ATP nor any protein. The direction of movement is determined by the concentration gradient (i.e., molecules flow from a region of higher concentration to a region of lower concentration) or electrical gradient. Therefore, any molecule that is soluble in the phospholipid layer is capable of crossing the plasma membrane. This is the reason why only small, relatively hydrophobic (water repelling) molecules (example—benzene), gases (O_2 , CO_2) and even small polar, uncharged molecules diffuse easily across the plasma membrane while other larger molecules are restricted.

Osmosis

In osmosis, the movement of water (solvent) occurs due to the difference of chemical potential (water potential in case of water) on the two sides. The kinetic energy or free energy possessed by the molecules of a substance is called chemical potential. The chemical potential of water is called water potential. The chemical potential of pure water (solvent) is higher than that of the same in a solution. Presence of solute particles decreases the chemical potential (free energy) of water. The lowering of chemical potential (free energy) is due to attraction and collision between solvent (water) and solute molecules. Thus, in terms of thermodynamics, '*Osmosis is the movement of water or solvent*

molecules from the region of their higher chemical potential (free energy) to the region of their lower chemical potential (free energy) across a semipermeable membrane'.

Active Transport

Active transport is the movement of ions or molecules from a region of lower concentration to higher concentration across the plasma membrane (Uphill transport). For this, the energy is provided either by another coupled reaction or by direct hydrolysis of ATP.

2. Diffusion plays an important role in living systems. Below are a few examples where its diverse significance can be understood.
 - (i) In the human body, nutrients (in the form of ions and small molecules) are absorbed from the food by the surrounding blood cells in the vessels by way of diffusion.
 - (ii) In the lungs, CO₂ diffuses out of blood in alveolar sacs whereas O₂ (present in high concentration in the inhaled air) diffuses into the cells in the blood vessels (with low O₂ concentration).
 - (iii) Cutaneous respiration (through skin) is the most common mode of respiration in lower non-chordates wherein gases directly diffuse through the air into the surface epithelium of the organisms.
 - (iv) The eyes lack a large number of blood vessels (which carry oxygen) and therefore needs an extra supply of oxygen. The atmosphere provides this extra needed oxygen, which is taken up by the eye through direct diffusion of O₂ into the cornea, the hard outer covering on the eye. In absence of diffusion, the eyes would dry out.
3. Listed below are a few examples that illustrate the importance of osmosis:
 - (i) Osmosis is of prime importance in living organism, where it influences the distribution of nutrients and the release of metabolic waste products. Living cells of both plants and animals are enclosed by a partially-permeable membrane called the cell membrane, which regulates the flow of liquids and of dissolved solids and gases into and out of the cell.
 - (ii) It helps maintain the pressure on either side of the cell membrane thereby preventing the cells to become turgid and burst or to become flaccid.
 - (iii) Plant roots absorb water and minerals from soil and take it upwards to the leaves and other plant parts which are essential for plant growth.
 - (iv) Purification of blood by kidneys also involves osmosis. Osmosis maintains the balance of inter-and intracellular fluids.

4. Significance of Active Transport in Organisms:

- (i) In the intestinal lining, glucose is absorbed by active transport from a lower concentration to a higher concentration in the cells lining the intestine.
- (ii) Na^+ and K^+ gradients established by the $\text{Na}^+ - \text{K}^+$ pump is required for the propagation of electric signals in nerves and muscles.
- (iii) Ca^{2+} ions are actively transported by Ca^{2+} pump which is required for muscle contraction.
- (iv) H^+ ions are actively pumped out of the cell lining the stomach which results in the acidity of gastric fluids which help in the digestion. H^+ ions are actively transported into the endosomes and lysosomes with the help of pumps.

Active transport is also important for the transport of nutrients, including ions, sugars, amino acids into the cells and transport of toxic substances out of the cell (e.g., ABC transporters in bacteria and eukaryotic cells).

5. When a cell is placed in a hypertonic solution, water actually flows out of the cell into the surrounding solution thereby causing the cells to shrink and lose its turgidity. Hypertonic solutions are used for antimicrobial control.

Salt and sugar are used to create hypertonic environment for microorganisms and are commonly used as food preservatives.

Salting is the preservation of food with dry edible salt. It is related to pickling (preparing food with brine, i.e., salty water). It is one of the oldest methods of preserving food, and two historically significant such foods are dried and salted cod (usually referred to as salt fish) and salt-cured meat. Salting is used because most bacteria, fungi and other potentially pathogenic organisms cannot survive in a highly salty environment, due to the hypertonic nature of salt. Any living cell in such an environment will become dehydrated through osmosis and die or become temporarily inactivated.

Salting Methods

- Cut your vegetables up in pieces before you put them into the salt water to preserve food by salt-curing. As you chop a vegetable and put it into the salt water, it makes its own juice. Nowadays, you might want to use a smaller container. Just make sure the water has plenty of salt added. Let the vegetables stand in the salt water for at least 10 days in order to “pickle.” Pickle simply means preserved in brine. Then cover tightly with a lid.
- Preserve meats by salt-curing. Rub meat completely with salt pellets and allow it to cure for 4 to 8 weeks. At the end of this time, the meat will be almost dry. It can be stored this way for a long time. This method is called “dry-curing.”
- Soak meat in a solution of brine for a period of 3 to 4 weeks. It will be ready to eat, but it won't last long this way. You can also use a syringe to inject brine

into the muscles of the meat in order to preserve the food by salt-curing. It will be ready to eat in 2 to 3 weeks. Just remember that these wet methods of salt-curing meat do not preserve it as long as the dry method does.

6. Plants in salty areas take up more salt from the soil resulting in an increase in salt concentration in the cells and thus maintaining a water potential that is more negative than that of the soil.

The difference in osmotic potential between plant cells and soil water leads to the movement of water into the cells through the cell membrane via osmosis. Water is evaporated from the leaves.

This also helps the movement of water from the roots up the stem to the leaves. Some plants restrict the opening of stomata to conserve their water in salty conditions and some turn down leaves to decrease the surface area of evaporation. Plants have glands to store the salt which burst when concentration of salt increases and cause the release of salt to the soil again. Some plants regulate salt levels by transporting sodium and chloride ions into the central vacuole. High salt concentration in the vacuole causes more water uptake and swelling. Some plants avoid salt stress by releasing leaves in which excess sodium chloride accumulates in petioles.

Animals adapt to the salty conditions very well as plants. For example, fishes in salt water intake a lot of water and reduce the loss of water by excreting less amount of urine by having a kidney with relatively few small glomeruli. Fishes also have chloride secretory cells on their gills which actively transport salts from the blood to the surroundings. Salt glands are also found in other animals inhabiting salty conditions.

Therefore, specially developed kidneys, gills, and body functions help equalizing salt concentrations across membranes through osmosis.

7. Differences between endocytosis and exocytosis:

| Endocytosis | Exocytosis |
|---|--|
| Eukaryotic cells take up macromolecules from the surrounding by endocytosis that cannot pass through the cell membrane. | Cells expel large molecules or particles that cannot pass through the cell membrane. |
| It helps to ingest molecules to the interior of the cell. | It helps in expelling molecules outside of the cell. |
| Material to be internalized is surrounded by plasma membrane which buds off inside the cell to form a vesicle containing the ingested material. | Molecules to be transported are surrounded by vesicles which move toward the cell membrane and get attached to it. Molecules are pushed off from the membrane. |
| It leads to formation of vesicles. | It leads to destruction of vesicles. |
| It can be further categorized to the following three types: Phagocytosis (Cell eating): Cell takes in bacteria or food, Pinocytosis (Cell drinking): Cell ingests a liquid material, Receptor mediated endocytosis: Specific molecules are transported, for example, low density lipoproteins (LDLs). | There is no further categorization. |
| Examples: Uptake of nutrients, food particles, proteins and specific molecules, destruction of pathogen by cells. | Examples: Secretion of digestive enzymes, antibodies, hormones, discharge of neurotransmitter from presynaptic neurons. |

2.13 ASSESSMENT METHODS

Use observation technique, question answer technique, and demonstration technique to assess the learners' achievement of learning objectives.

2.14 ASSESSMENTS

Formative Assessment

Fill in the blanks:

1. process in which cells lose water in a hypertonic solution.
2. In passive transport, ions/molecules move from concentration to concentration.
3. leads to destruction of vesicles.
4. Christian de Duve (1963) coined the term

Ans. 1. Plasmolysis, 2. higher, lower, 3. Exocytosis, 4. Endocytosis

Summative Assessment

Answer in one word:

1. When two molecules are transported in the opposite direction.
2. Wastes are eliminated by.
3. Special cells in fishes by which they actively transport salts from the blood to the surroundings.

Ans. 1. Antiport, 2. Osmosis, 3. Chloride secretory cells

Unit 3: Chromosomes and Nucleic Acids

3.1 LEARNING OBJECTIVES

| Knowledge and Understanding | Skills | Attitudes and Values |
|---|---|--|
| <ul style="list-style-type: none"> • Describe the composition of chromosomes and the structure of nucleotides. • State how nucleotides pair. • Describe the structure of DNA and RNA. • Explain that the structure of the DNA molecule is described as a ladder twisted into a spiral. • Explain the Watson-Crick hypothesis of the nature of DNA. • Outline the significance of telomeres in permitting continued replication. • Describe the nature of genes. • Describe the structure of a genetic code. | <ul style="list-style-type: none"> • Use of complimentary base pairing to write the sequence for messenger RNA and the first DNA codes for three base codon. • Draw the structure of DNA (6–10 base pair sequence). • Research on how Watson and Crick determined the nucleotide base pairing pattern. • Distinguish between RNA and DNA. | <ul style="list-style-type: none"> • Appreciate the importance of the presence of DNA in chromosomes. • Acknowledge the role of telomeres in preventing the loss of genes and its relation to the development of cancer. |

3.2 TEACHING AIDS

Visual: Images of nucleotides and base pairing.

Audio-video: Video showing Watson and Crick hypothesis of the nature of DNA.

3.3 TEACHER'S TIP

Start the unit by briefing the learners about chromosomes and its structure. DNA as the genetic material for heredity. Dwell further on structure of DNA and RNA, their similarities and dissimilarities. Teacher will clear the concepts of base pairing and nature of genes and genetic code.

3.4 TEACHING METHODS

Brainstorming, short lecture technique, group discussion technique, observation technique, drawing technique, demonstration technique, field visit, site visit and practical work.

3.5 TEACHING AND LEARNING MATERIALS

Models of DNA, illustrations, computer simulations, suitable model materials, tooth picks, ribbons, electric wires, straws of different colours, and prepared slide on mitosis.

3.6 TEACHING METHODOLOGY

Teacher initiates the topic by introducing chromosomes and its composition. Teacher assists the learners to draw diagrams, make charts of chromosome packaging in DNA.

Teacher also discusses the types of the nucleotides. Start by asking the learners to tell any of the examples they could cite.

Learners reply to the raised questions by the teacher.

Appreciating them, teacher further asks if they are aware of nucleic acids and its bases.

Learners will come up with varied answers. Some correct, some near to correct, others being irrelevant.

Teacher will not demotivate the child. But agreeing to the correct answers, dwell further in discussion.

Using short lecture technique, teacher will explain the structure of nucleic acids.

Teacher further explains the learners about the genes and genetic code.

3.7 ADDITIONAL CONTENT FOR THE TEACHER

Denaturation and Hyperchromatic Effect

An important feature of DNA duplex, is the relative ease with which the component strands can separate and rejoin. When a DNA molecule is exposed to low or high pH or high temperature, the two strands can separate due to disruption of hydrogen bonds

between the base pairs. The phenomenon is called **denaturation** or **melting**. Since an A-T base pair has only two hydrogen bonds, the area rich in A-T base pairs can undergo easy denaturation. It is called **low melting area**. The area rich in G-C base pairs is comparatively more stable because of three hydrogen bonds between the complementary bases. DNA strands separated by melting can reassociate or rejoin to form a duplex DNA by the formation of hydrogen bonds, when they are incubated at a temperature about 25°C or below.

This phenomenon is called **renaturation**. Another important feature of DNA molecule, is to absorb light energy. It is in fact the property of its individual bases. An intact DNA molecule absorb less light energy because its bases are packed in a double helix. A denatured DNA molecule absorbs more light energy, as its bases in single strand are exposed. This increase in the absorption of light occurs though the amount of DNA remains the same, is called hyperchromic effect. This effect is absent in single stranded DNA. The **hyperchromic effect** is used to identify a DNA molecule as single or double stranded in a sample.

Activity

The teacher can demonstrate this activity in the class.

Aim: To make the learners understand about Chargaff's rule.

Ask each learner to read it aloud and study the nucleotides.

Ask them to prepare beautiful charts to show their research on Chargaff's rule and complementary base pairing.

3.8 SUMMARY

- Chromosome is composed of three main components: Nucleotides, histones proteins, and non-histones proteins.
- Nucleotide is subdivided into pentose sugar, nitrogenous bases, and phosphate groups.
- The presence of DNA in chromosomes is important for three main reasons— Protection from damage, conserve space, and control of gene expression.
- Nucleotide is made up of pentose sugar, nitrogenous bases, and phosphate groups; whereas, nucleoside is made up of pentose sugar and nitrogenous bases.
- Phosphodiester bond connects the phosphate group, which is attached on 5' of one nucleotide, with the 3' carbon of another nucleotide. This bond is a strong bond. That is why DNA is a stable structure.
- Polynucleotide chains have polarity. On one end, there is a 5' carbon with a *phosphate group*. On the other end, there is a 3' carbon with a *hydroxyl group* on it.

- Chargaff's rules state that DNA of all organisms should have a 1:1 ratio of purine (A, G) and pyrimidine (T, C) bases. The specific base pairing of A-T bases and G-C bases is called complementary base pairs.
- In 1953, Watson and Crick proposed the double helix structure of DNA.
- The two strands of DNA are anti-parallel; the bases on both strands are bonded by hydrogen bonds in line with Chargaff's rules. DNA has major and minor grooves.
- DNA is also described as twisted ladder structure.
- RNA has hydroxyl group at 2' carbon of pentose sugar. It has uracil base instead of thymine.
- Unlike DNA, RNA is not the genetic material of many organisms except for few viruses.
- DNA is double stranded while RNA is normally single stranded; DNA transfer genetic material while RNA is involved directing the synthesis of proteins.
- A telomere is a region of repetitive nucleotide sequences at each of the tip of chromosomes.
- Telomere protects important genes from being deleted, and thus, allows a continued replication.
- Telomere regions are synthesized by a telomerase enzyme.
- Telomeric regions are important in ageing and cancer treatment.
- A gene codes for a specific trait.
- A particular gene can be present in two versions called alleles. When more than two versions of gene are present, it is called multiple alleles.
- Alleles can either be dominant or recessive.
- Genes duplicate themselves through the process of DNA replication.
- Genes are copied from DNA to RNA through a process called **transcription**.
- Message in the m-RNA is translated into proteins through a process called **translation**.
- Many enzymes have multiple polypeptide subunits, and each subunit is encoded by a separate gene. This relationship is called **one gene/one-polypeptide hypothesis**.
- It is the set of rules by which information encoded in genetic material (DNA or RNA sequences) is translated into proteins (amino acid sequences) by living cells.
- Out of 64 codons, 61 codons are sense codons and 3 codons are non-sense codons.
- A codon is made up of three nucleotides or triplets.
- Genetic code is almost universal; it shows degeneracy.

3.9 WEBLINKS FOR CONTENT ENRICHMENT

- <http://users.rcn.com/jkimball.ma.ultranet/BiologyPages/N/Nucleotides.html>
- <http://scienceprimer.com/nucleotides-dna>
- <http://www.dnai.org/>

3.10 LEARNERS' ACTIVITIES

Activity 1

The teacher should guide the learners to carry out the activity on their own.

Hint:

1. Let the learners know that **chromosomes** are the structures that hold genes; they are made up of strands of **DNA tightly wrapped** around histone proteins. Chromosome is basically composed of three components: (A) Nucleotides (B) Histones proteins (C) Non-histones proteins.
2. Let them briefly describe the three components of chromosomes.
3. Let them draw the structures and diagrams.
4. Then they will come to know how DNA is tightly packed in a structure called chromosomes.
5. Let the learners know the importance of chromosomes in one's body. The importance of chromosome is given in the text: Protection, conserve space, and control of gene expression.

Activity 2

The teacher should divide the class in groups of 2-3 learners each and guide them to carry out the activity as per the procedure given in the Student's Book.

Activity 3

The teacher should guide the learners to carry out the activity on their own.

Hint:

1. Let the learners know that a basic unit of **nucleotide** is made up of pentose sugar, a nitrogenous base, and a phosphate sugar. And these nucleotide sequences make DNA. The unique arrangement in DNA makes a person unique.
2. Also, let the learners know that double strands of DNA are joined together by: Hydrogen bonds and Chargaff's rules.
3. Let the learners briefly describe hydrogen bonds and Chargaff's rules with diagrams.

Activity 4

The teacher should divide the class in small groups of 3-4 learners each and guide them to carry out the activity.

Hint:

1. Let the learners thoroughly understand the structure of DNA.
2. If the school you are teaching at has plastic models (already procured or bought), then things are very simple.
3. You can allow the learners to use those plastic models to construct the structure of DNA.
4. The structure of DNA using plastic models will somehow look like the DNA structures in these pictures (depending on the type of plastic models your school has):



Figure 1



Figure 2

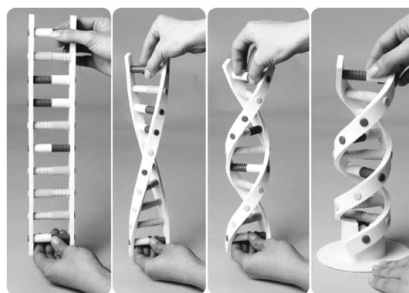

Figure 3

5. Now if you do not have any plastic models at your school, you can ask the learners to design the structure of DNA at home to bring out their creativity.
6. The simplest and the cheapest method would be to use coloured papers. Buy different types of coloured papers and cut them and label them accordingly. These are the things learners will require:
 - (a) Hard coloured papers
 - (b) Scissors
 - (c) Glue
 - (d) Markers
 - (e) Rulers
7. Learners can follow the design given in picture 3 above. Once they get the ladder shape structure, they can twist the structure in order to show the twisted structure of DNA.
8. Or learners can come out with their own creativity to design the structure of DNA. Nothing is limited if learners can use their imagination to create new things. Challenge the learners to use their imagination!

Activity 5

The teacher should divide the class into small groups and guide them to carry out the activity as per the procedure given in the Student's Book.

Hint:

1. Let the learners thoroughly know the difference between the DNA and the RNA structures. The differences are given in the text.
2. They can draw the structures of DNA and RNA.
3. And they can give the main differences in points.
4. Then allow them to present their work in front of all the learners and you.

Activity 6

The teacher should guide the learners to carry out the activity on their own.

Activity 7

The teacher should guide the learners to carry out the activity on their own.

Hint:

With four different nucleotides (A, C, G, U), a three-letter code (codon) can give 64 different possible codons (i.e. $4^3 = 64$) or $(4 \times 4 \times 4 = 64)$. These 64 possible codons are more than enough to code for the 20 amino acids found in living cells.

The answer to the question mainly has to do with the term “degeneracy” of genetic code. Here is the thing:

A codon is thought to code for a particular amino acid. That is one codon for one amino acid. But more than one codon can code for a particular amino acid, with two exceptions of AUG and UGG. This multiple coding by a single codon is called the degeneracy or redundancy of the code. Example: UUU and UUC codons code for the same specific phenylalanine amino acid. In the same way, CAU and CAC codons code for the same specific histidine amino acid.

That is the reason why 61 codons can code all these 20 standard amino acids. In other words, multiple codons code for single amino acid. Thus, we have more codons to code for less number of amino acids.

3.11 ANSWERS TO STUDENT'S BOOK SELF-EVALUATION

Self-evaluation

- (i) Gene
- (ii) adenine, guanine
- (iii) RNA

- (iv) phosphodiester bond
- (v) complementary

Self-evaluation

- (i) DNA structure
- (ii) Telomerase
- (iii) Study of telomere
- (iv) Hydrogen
- (v) RNA

Self-evaluation

- (i) mutation
- (ii) homozygous
- (iii) dominant, recessive
- (iv) start

3.12 ANSWERS TO END UNIT ASSESSMENT 3

I. Choose whether the following statements are True (T) or False (F):

1. **False;** In DNA, the Pentose sugar is deoxyribose.
2. **False;** In RNA the pentose sugar is ribose: hydroxyl group (OH) is attached at the 2' carbon position.
3. **True;** Pyrimidines are six-membered, single-ringed structures.
4. **True;** DNA contains adenine, thymine, guanine, and cytosine, while RNA has adenine, uracil, guanine, and cytosine.
5. **True;** H1 protein is loosely attached to the rest of the histone core proteins.
6. **True;** Non-histone proteins are acidic and negatively charged.
7. **True;** Purine bases use the 9th position of nitrogen to attach with 1' carbon of pentose sugar, while pyrimidine bases use the 1st position of nitrogen to attach with 1' carbon of pentose sugar.
8. **False;** Two polynucleotide chains wind around each other in a right-hand double helix.
9. **True;** UAG, UGA and UAA nucleotides are stop codons, while AUG is a start codon generally.
10. **False;** More than one codon can code for a particular amino acid, with two exceptions of AUG and UGG. This multiple coding by a single codon is called the degeneracy or redundancy of the code.

II. Multiple choice questions:

1. **(b)**; A codon is made of three nucleotides.
2. **(a)**; Newborn babies have telomeres ranging from around 8,000 to 13,000 base pairs.
3. **(c)**; Split genes are genes where exons are interrupted with introns.
4. **(b)**; Mutant gene is a gene whose nucleotide sequence has changed due to mutation.
5. **(b)**; It is through splicing mechanism that introns are removed from pre-m-RNA. Then exons are joined together to form mature m-RNA.
6. **(b)**; Recessive allele will express itself only when it occurs with other recessive allele. As long as dominant allele is present, recessive allele will not be expressed.
7. **(c)**; During DNA replication, a copy of DNA is made from a template DNA. Therefore, it is a process of copying DNA from DNA.
8. **(a)**; Nitrogenous bases are linked to one another by hydrogen bond following complementary base pairing rule. Example: A with T, C with G.
9. **(d)**; Uracil (U) is present in RNA.
10. **(c)**; A gene codes for a specific trait.

III. Long answer type questions:

1. Composition of chromosome:

Chromosome is basically composed of three components:

(A) Nucleotides: The monomers that make up Deoxyribonucleic acid (DNA) and Ribonucleic acid (RNA) are called nucleotides. Nucleotide has three components:

Pentose Sugar: Pentose sugar has five carbon atoms, which are numbered 1' to 5' respectively. In DNA, the pentose sugar is deoxyribose: a hydrogen atom (H) is attached at the 2' carbon position. In RNA the pentose sugar is ribose: hydroxyl group (OH) is attached at the 2' carbon position.

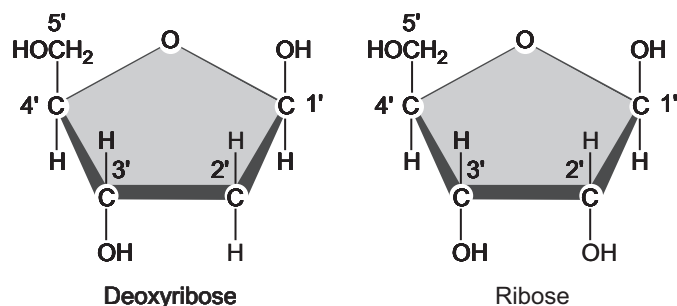

Structures of deoxyribose and ribose in DNA and RNA

Nitrogenous Bases: There are two classes of nitrogenous bases: Purines and Pyrimidines. Purines are nine-membered, double-ringed structures. In these purines, the carbons and nitrogens are numbered 1 to 9. There are two purines: Adenine (A) and Guanine (G). Pyrimidines are six-membered, single-ringed structures. The carbons and nitrogens in these pyrimidines are numbered 1 to 6. Pyrimidines are of three types: Thymine (T), Cytosine (C), and Uracil (U).

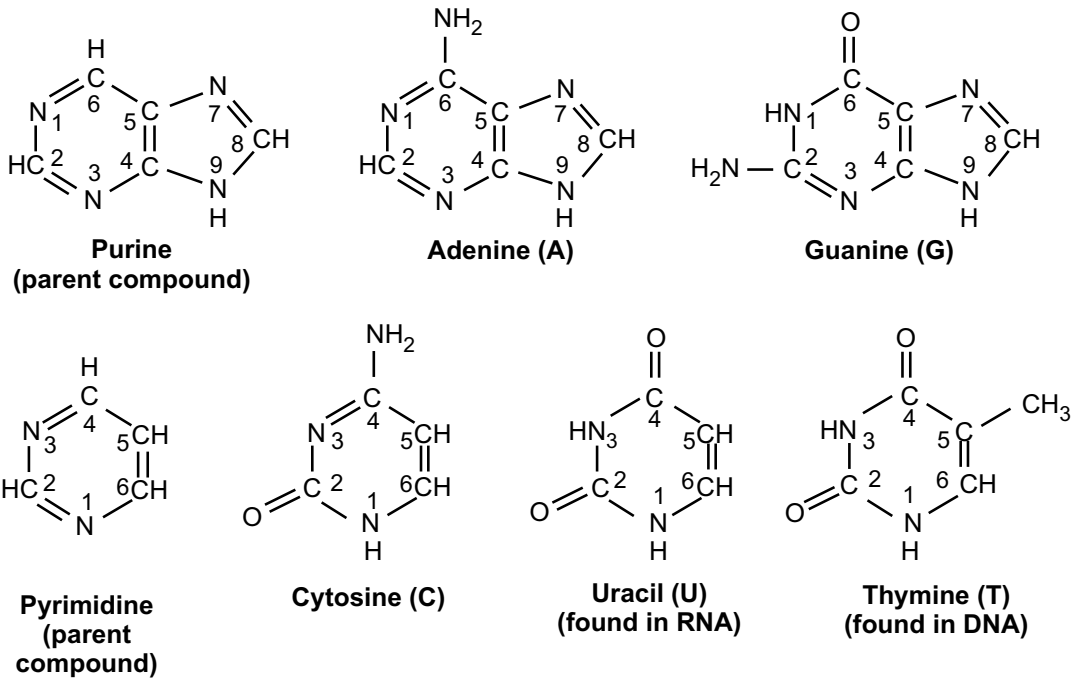

Structures of nitrogenous bases in DNA and RNA

Phosphate Group: The phosphate group (PO_4^{2-}) is attached to the 5, carbon of the sugar in both DNA and RNA. Due to this phosphate group, DNA is **negatively charged**.

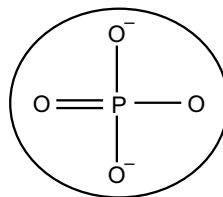

Phosphate group

(B) Histones Proteins: Histone proteins play an important role in organizing the physical structure of the chromosome. They are most abundantly found in chromatin where they are wrapped around by DNA strands. Moreover, they are small basic proteins with a net positive charge that assist their binding to the negatively charged DNA (due to phosphate groups which are negatively charged).

In eukaryotes, there are five main types of histone proteins. They are: H1, H2A, H2B, H3, and H4. H1 is loosely attached to the rest of the histone core proteins. That is why H1 can be easily separated from the rest of the histone proteins. And two each of H2A, H2B, H3, and H4 form core of eight histone proteins. These core proteins are also called histone octamers. A strand of DNA measuring 147 bp segments wraps around this histone octamers for about 1.7 times. Each nucleosome is connected by a strand of DNA called linker DNA. For example, Human linker DNA ranges from 38–53 bp long.

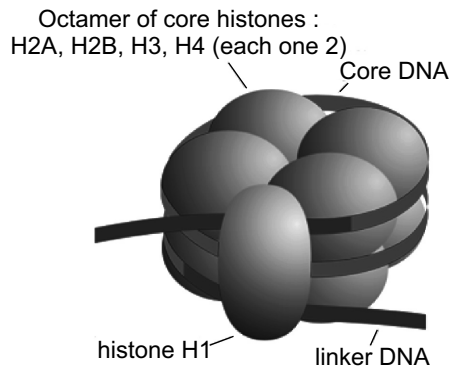

Arrangement of Histone Proteins

(C) Non-histone Proteins: Excluding histone proteins, the rest of the proteins associated with DNA come under the category of non-histone proteins. Non-histone proteins in so many ways are different from histone proteins. Some of the differences are:

- (i) The number of non-histone proteins is much lesser than histone proteins.
- (ii) Non-histone proteins are acidic proteins, which are negatively charged.
- (iii) They play an important role in the process of DNA replication, DNA repair, transcription, gene regulation, and recombination.
- (iv) They vary in number and type from cell type to cell type within an organism at different times in the same cell type, and from organism to organism.

2. The main structural differences between RNA and DNA

There are three major differences of RNA from that of DNA are:

- (i) RNA contains ribose sugar instead of 2'-deoxyribose. It means that ribose has a hydroxyl group (OH) at the 2' position, whereas, deoxyribose has hydrogen (H) at 2' position in pentose sugar.

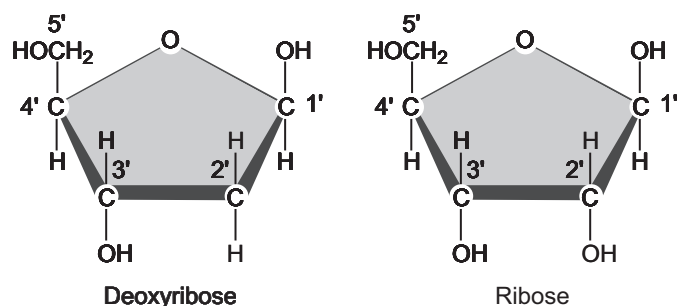

Structures of deoxyribose and ribose in DNA and RNA

- (ii) RNA has Uracil (U), whereas, DNA has thymine (T).
- (iii) Unlike DNA which consists of two polynucleotide chains, in most cases, RNA is found in a single polynucleotide chain.

3. In chromosomes, DNA is important due to the following reasons:

- (i) **Protection:** The packaging of DNA in chromosomes helps in protecting DNA from being damaged.
- (ii) **Conserve Space:** If we take the DNA from all the cells in a human body and line it up, end-to-end, it would form a strand 6000 million miles long! In order to store this very long important material, DNA molecules are tightly packed around proteins called histones to make the structures called **chromosomes**.

The packaging of DNA in chromosomes helps in conserving space in cells. Approximately, about two metres of human DNA can fit into a cell that is only a few micrometres wide.

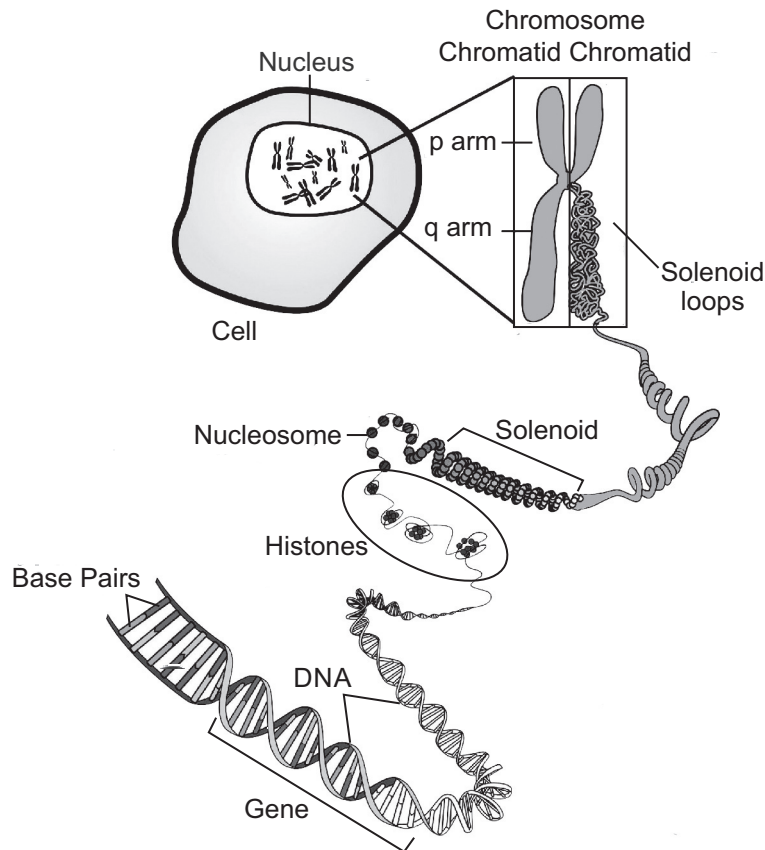

(iii) **Control of Gene Expression:** Chromatin is a complex of DNA and proteins that forms chromosomes within the nucleus of eukaryotic cells. In its extended form, chromatin looks like beads on a string under the microscope. The beads are called nucleosomes, while the link between them is a strand of DNA.

The packaging of DNA in chromatin form helps in controlling gene expression. Highly compacted chromatin is not accessible to the enzymes involved in DNA transcription, replication, or repair.

Chromatin has two main regions. The less condensed regions of chromatin are the regions where active transcription takes place. This region is called **euchromatin**. On the other hand, the condensed region of chromatin is where transcription is inactive or is being actively inhibited or repressed. This region is called **heterochromatin**.

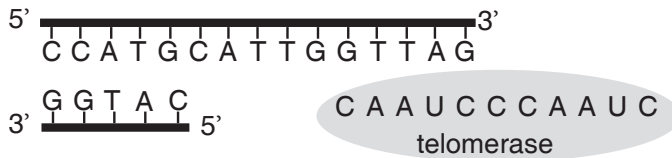

Telomerase has an associated RNA that complements the 3' overhang at the end of the chromosome.

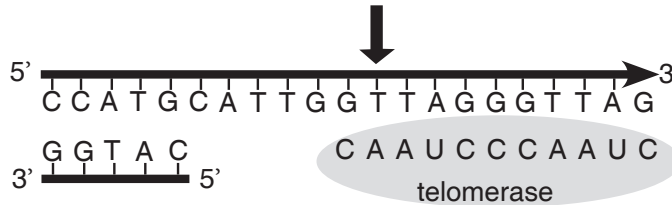

The RNA template is used to synthesize the complementary strand.

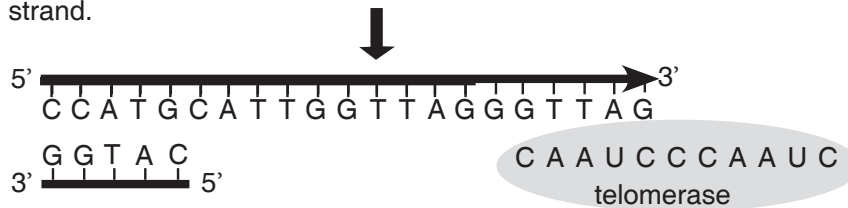

Telomerase shifts, and the process is repeated.

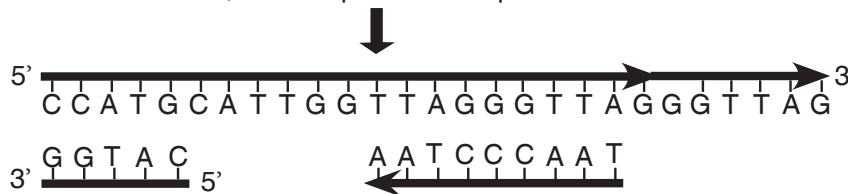

Primase and DNA polymerase synthesize the complementary strand.

Synthesis of telomeric DNA by telomerase

Telomeres and Cancer

Cancer cells are characterized by their rapid and uncontrollable division of cells. These cells have active telomerase to help them divide uncontrollably and become immortal. In the absence of telomerase, the cancer cells would become inactive and would stop dividing resulting into death of the cancer cells. Cancer therapies can take advantage of this concept by designing drugs that can inhibit telomerase activity, thereby, killing the cancer cells. Telomere biology is an important aspect of human cancer. Many scientists are hoping and working hard to understand the best way to use anti-telomerase therapy and advance the treatment of cancer.

5. The structure of genetic code is related to a series of exciting discoveries.

It was **George Gamow** (1954), a physicist, who argued that since there are only 4 bases and if they have to code for 20 amino acids, the code should constitute a combination of bases. In order to code for all the 20 amino acids, he suggested that the code should be made up of three nucleotides (**triplet code**). The permutation and combination of three nucleotides 4³ (4 × 4 × 4) would generate 64 codons. Proving that codon was triplet (i.e., three nucleotides) was quite a challenging task. But the chemical method developed by **Har Govind Khurana** for synthesizing RNA molecules with defined combinations of bases (homopolymers and copolymers), and Marshall Nirenberg's cell free system for protein synthesis finally helped the genetic code to be deciphered. In the 1968, both of them, **Marshall Nirenberg** and Hare Gobind Khurana along with Robert Hollye were awarded the Nobel Prize in Physiology and Medicine. Finally, a checker board for genetic code was prepared which is as follows.

| | | Second base | | | | |
|---------------------|---|------------------|-----|----------|----------|------------------|
| | | U | C | A | G | |
| First base (5' end) | U | UUU | UCU | UAU | UGU | U C A G |
| | | UUC | UCC | UAC | UGC | |
| | | UUA | UCA | UAA Stop | UGA Stop | |
| | | UUG | UCG | UAG Stop | UGG Trp | |
| | C | CUU | CCU | CAU | CGU | U C A G |
| | | CUC | CCC | CAC | CGC | |
| | | CUA | CCA | CAA | CGA | |
| | | CUG | CCG | CAG | CGG | |
| | A | AUU | ACU | AAU | AGU | U C A G |
| | | AUC | ACC | AAC | AGC | |
| | | AUA | ACA | AAA | AGA | |
| | | AUG Met or start | ACG | AAG | AGG | |
| | G | GUU | GCU | GAU | GGU | U C A G |
| | | GUC | GCC | GAC | GGC | |
| | | GUA | GCA | GAA | GGA | |
| | | GUG | GCG | GAG | GGG | |

Genetic Code: The first, second and third bases as read from 5' to 3' direction constitute the triplet code in RNA. The codon AUG specifies methionine and is usually the starting point for protein synthesis. The word 'stop' indicates codons serving as signals to terminate protein synthesis. For each amino acid, more than one codon have been identified. It would be clear from the Figure that while the first and second bases remain the same for a particular amino acid, the third base can be different.

6. A typical ladder has two long wooden or metal side strands or pieces between which a series of rungs or bars are set in suitable distances. In the structure of DNA, the pentose sugars and phosphate groups make up the “long two side strands or pieces” of a typical ladder. And the A-T and G-C base pairs which are bonded by hydrogen bonds that make up the “rungs or bars” of a typical ladder.

But unlike a typical ladder which is straight, the two strands of DNA are twisted into spiral. Scientists call this a double helix. DNA also folds and coils itself into more complex shapes. The coiled shape makes it very small. In fact, it is small enough to easily fit inside any of our cells. If a DNA from a cell is unfolded, it would stretch out to a length of about six feet. The structural twisted nature of DNA has been attributed to enhance its stability and strength. Thus, for these simple similarities with a typical ladder, DNA is also referred to as a twisted ladder structure.

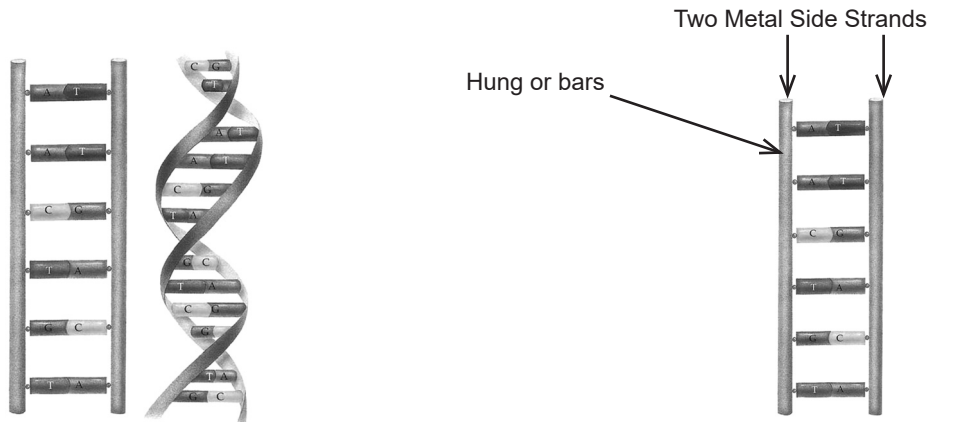

A twisted ladder DNA Structure

A typical ladder

- 7.

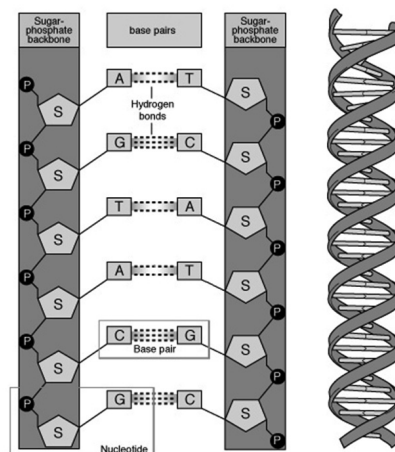

Structure of DNA having 6 base pair sequences. Here the base pairs are: A-T, G-C, T-A, A-T, C-G, and G-C.

8. The rules of base pairing (or nucleotide pairing) are:

- **A with T:** the purine **adenine** (A) always pairs with the pyrimidine **thymine** (T)
- **C with G:** the pyrimidine **cytosine** (C) always pairs with the purine **guanine** (G)

This is consistent with there not being enough space (20 Å) for two purines to fit within the helix and too much space for two pyrimidines to get close enough to each other to form hydrogen bonds between them.

Only with A & T and with C & G are there opportunities to establish **hydrogen bonds** (shown here as dotted lines) between them (two between A & T; three between C & G). These relationships are often called the rules of **Watson-Crick** base pairing, named after the two scientists who discovered their structural basis.

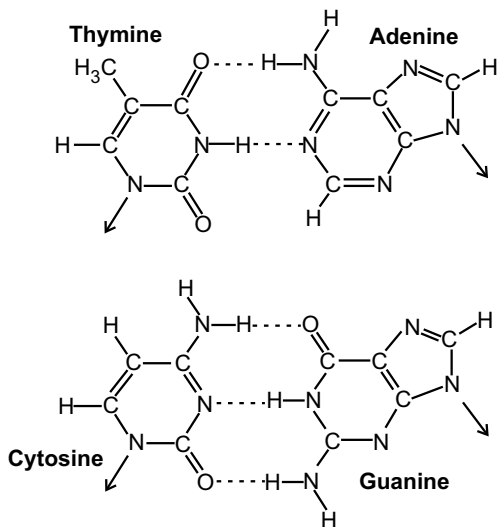

The rules of base pairing tell us that if we can “read” the sequence of nucleotides on one strand of DNA, we can immediately deduce the complementary sequence on the other strand.

The rules of base pairing explain the phenomenon that whatever the amount of adenine (A) in the DNA of an organism, the amount of thymine (T) is the same (called Chargaff’s rule). Similarly, whatever the amount of guanine (G), the amount of cytosine (C) is the same.

9. The following are some natures of genes:

- (a) A complete set of an organism’s DNA is called **genome**. A **gene** is a segment of DNA that encodes for a *particular trait*. For example—black hair, brown hair etc.
- (b) **Chromosomes** are the structures that hold genes; they are made up of strands of DNA tightly wrapped around histone proteins.
- (c) Genes are located on the chromosomes.
- (d) In the chromosome, a gene is found in a pair or alternative forms called **alleles**. An **allele** is one of two or more versions of the same gene or gene locus. Two alleles for each gene, one from each parent, are passed on to offspring. **Homozygous** pair refers to two of the same alleles and

heterozygous pair refers to two different alleles.

- (e) Each gene allele occupies a specific position in each chromosome called locus (plural- loci).
 - (f) Alleles are either **dominant** or **recessive**. Dominant allele will be expressed wherever it is present, even if it is paired with recessive allele. But recessive allele is expressed only when it is paired with another recessive allele.
 - (g) Genes duplicate themselves very accurately by DNA replication. **DNA replication** is the process of producing two identical DNA replicas from one original DNA molecule during cell cycle. It occurs in all living organisms and is the basis for biological inheritance.
- 10.**
- (i) Double helix model of DNA (Watson-Crick model of DNA)
 - (ii) (1) 2 nm (2) 3.4 nm (3) 0.34 nm (4) 2.2 nm (5) 2.83 Å (0.28 nm)
 - (iii) Three
 - (iv) Four ; A, B, C and Z DNAs.
 - (v) Z-DNA ; B-DNA.
 - (vi) 12 base pairs per turn of helix ; 4.5 nm is the length of one turn of helix ; 1.8 nm is the diameter of the molecule.

3.13 ASSESSMENT METHODS

Use observation technique, question answer technique, and demonstration technique to assess the learners' achievement of learning objectives.

3.14 ASSESSMENTS

Formative Assessment

Fill in the blanks:

1. The presence of DNA in chromosomes is important for three main reasons—
....., and
2. has major and minor grooves.
3. is a region of repetitive nucleotide sequences at each of the tip of chromosomes.

Ans. 1. Protection from damage, conserve space, and control of gene expression
2. DNA, 3. telomere

Summative Assessment

Answer in one word:

1. The flow of genetic information.
2. In RNA, adenine pairs with.
3. I_A and I_B alleles of human blood are called.

Ans. 1. Central dogma, 2. Uracil, 3. codominant alleles.

Unit 4: DNA Replication

4.1 LEARNING OBJECTIVES

| Knowledge and Understanding | Skills | Attitudes and Values |
|--|---|---|
| <ul style="list-style-type: none"> • Determine how the structure of DNA enables it to reproduce itself accurately. • State semiconservative replication as a process by which DNA unzips and each new molecule of DNA (daughter DNA) contains one intact strand from the original DNA (parent DNA) and one newly synthesised strand. • State the role of enzymes involved in replication of DNA. • List the ingredients used to make DNA in a test tube. • Describe how semi-conservative replication of DNA takes place. • State that conservative and dispersive replications are other hypothesis for DNA replication. • Explain the importance of DNA replication in organisms. | <ul style="list-style-type: none"> • Apply knowledge of complimentary base pairing in DNA to interpret Meselson and Stahl's experiment to test different hypothetical models for DNA replication using E.coli grown in a heavy nitrogen (^{15}N) medium. | <ul style="list-style-type: none"> • Appreciate the importance of proper DNA replication. • Acknowledge that improper DNA replication would result into genetic changes in the nucleus that would have both positive and negative effects on organisms. For example, changes in the metabolism of cells, variation that can result into evolution and mutations that may lead to death. |

4.2 TEACHING AIDS

Visual: Images of mitosis and meiosis.

Audio-video: Video showing cell division, replication.

4.3 TEACHER'S TIP

Start the unit by briefing the learners about DNA replication as the process by which DNA makes a copy of itself during cell division. It produces two identical replicas. This process occurs in all organisms and is the basic for biological inheritance, enzymes are used in the process of DNA replication which have specific role in replication.

4.4 TEACHING METHODS

Brainstorming, short lecture technique, group discussion technique, observation technique, drawing technique, demonstration technique, field visit, site visit and practical work.

4.5 TEACHING AND LEARNING MATERIALS

Computer animations, models and illustrations.

4.6 TEACHING METHODOLOGY

Teacher initiates the topic by introducing DNA replication as a process of DNA to reproduce itself accurately. Teacher assists them to draw diagrams, make charts to understand better.

Teacher also discusses the models of DNA replication. Start by asking the learners to tell any of the examples they could cite.

Learners reply to the questions raised by the teacher.

Appreciating them, teacher further asks if they are aware of enzymes involved in the process.

Learners will come up with varied answers. Some correct, some near to correct, others being irrelevant.

Teacher will not demotivate the child. But agreeing to the correct answers, dwell further in discussion.

Using short lecture technique, teacher will explain the replication in prokaryotes and eukaryotes.

Teacher further explains to the learners the significance of replication.

4.7 ADDITIONAL CONTENT FOR THE TEACHER

- DNA replication is **semiconservative**. Each strand in the double helix acts as a template for synthesis of a new, complementary strand.
- New DNA is made by enzymes called **DNA polymerases**, which require a template and a primer (starter) and synthesize DNA in the 5' to 3' direction.
- During DNA replication, one new strand (the **leading strand**) is made as a continuous piece. The other (the **lagging strand**) is made in small pieces.
- DNA replication requires other enzymes in addition to **DNA polymerase**, including **DNA primase**, **DNA helicase**, **DNA ligase**, and **topoisomerase**.

Differences between Leading Strand and Lagging Strand

| S.No. | Leading Strand | S.No. | Lagging Strand |
|-------|---|-------|---|
| 1. | It is continuously formed replicated strand of DNA without any gap. | 1. | It is a replicated strand of DNA which is formed by the joining of short segments called okazaki segments. |
| 2. | The growth of leading strand is in 5' – 3' direction. | 2. | Each okazaki segment grows in 5'–3' direction, but the growth of the lagging strand is in 3'– 5' direction. |
| 3. | It does not require DNA ligase for its growth. | 3. | DNA ligase is required for the formation of lagging strand from okazaki segments. |
| 4. | It requires only single RNA primer. | 4. | Initiation of each okazaki segment requires a new RNA primer. |
| 5. | Its formation is quite rapid. | 5. | Formation of lagging strand is slower. |
| 6. | Its formation begins immediately after the formation of replication fork. | 6. | Its formation begins a bit later than that of leading strand. |

Activity

The teacher can demonstrate this activity in the class.

Aim: To make the learners understand replication.

Ask each learner to bring different coloured threads and exhibit model of replication in prokaryotes and eukaryotes by pasting them on chart paper.

Ask them to research and write about the process on chart paper itself.

4.8 SUMMARY

- DNA replication is the process of producing two identical DNA replicas from one original DNA molecule.
- DNA replication plays an important role in reproduction, DNA repair and growth of organisms.
- DNA replicates semi-conservatively, where the two original strands act as template while the other two strands are newly synthesized.
- The other two models of replication are conservative and dispersive DNA replications.
- Messelson and Franklin Stahl performed the experiment to test and prove that DNA replication is semi-conservative.
- Enzymes and Proteins Required for DNA Replication are
 - ◆ DNA polymerase I and III are functionally required for replication. But DNA polymerase I, II, IV, V are involved in DNA repair.
 - ◆ DNA helicase has the role of unzipping or unwinding the double strand structure of DNA.
 - ◆ DNA gyrase serves as a main swivel that prevents supercoiling of the DNA ahead of the replication fork.
 - ◆ SSB proteins relax the tendency of the two separated DNA strands to reform double stranded DNA.
 - ◆ DNA ligase seals the nick at the end.
- The list of the ingredients to make DNA in a test tube involves : a DNA template, dNTPs, DNA polymerase I, primers, magnesium ion, and buffer solutions.
- In Prokaryotes, DNA replication starts with DNA helicase unwinding or unzipping the double stranded DNA. Replication forks are formed, then primers bind on the two separated strands of DNA. DNA polymerase III starts synthesizing new DNA strands on both the strands at 5' – 3' directions.
- The synthesis of DNA is discontinuous; and thus, produces numerous, small Okazaki fragments.
- DNA polymerases I and III have 3' – 5' exonuclease activity. Thus, they remove the primers and replace the gap with complementary nucleotides.
- In Eukaryotes, replication takes place at multiple sites of origin of replications. In yeast cells, replicators are approximately 100 bp sequences called autonomously replicating sequences (ARS).
- Many replicons are formed.
- DNA replication is initiated by multiple proteins.
- Many replication bubbles are formed.

- The main polymerase enzymes involved are: DNA polymerase α , β , δ , ϵ ; they have different roles.
- The eukaryotic cells have chromosomes 25 times longer than the prokaryotes. Prokaryotes have only one replicon. Eukaryotes have multiple replicons, which help in replicating faster than if there were only one replicon.
- The rate of replication in prokaryotes is about 1000 bp per second, whereas the rate of replication in eukaryotes is about 100 bp per second.
- There are basically four mechanisms that ensure accuracy of DNA replications: Complementary base pairing, semiconservative nature of DNA, proofreading, and mismatched DNA repair.
- Normally uncorrected mistakes in DNA replication are repaired by DNA repair mechanism. But in very rare cases, mistakes are not corrected, leading to mutation.
- On the positive side, mutation can bring species variation and evolution. On the negative side, mutation can bring defects in metabolic pathway and may also cause death.

4.9 WEBLINKS FOR CONTENT ENRICHMENT

- <https://www2.estrellamountain.edu/faculty/farabee/BIOBK/BioBookmito.html>
- <https://ghr.nlm.nih.gov/handbook/howgeneswork/cellsdivide>
- <https://www.dnalc.org/resources/3d/04-mechanism-of-replication-advanced.html>

4.10 LEARNERS' ACTIVITIES

Activity 1

The teacher should divide the class in groups of 3–4 learners each and guide them to carry out the activity.

Hint:

1. Let the learners study the semiconservative model of replication.
2. Let them also research and study other methods of replication like conservative and dispersive models of replication.
3. Once they are ready, let them give the presentations.
4. At the end, you give your suggestions on how to improve their presentations.

Activity 2

The teacher should guide the learners to carry out the activity themselves.

Activity 3

The teacher should guide the learners to carry out the activity themselves.

Hint:

1. It is true that different enzymes and proteins work together to smoothly and efficiently carry out DNA replication.
2. All the enzymes and proteins involved in DNA replication are given in the text (4.3) along with diagrams. Examples: Helicase enzyme, DNA ligase etc.
3. Let the learners know mainly about the roles of every enzyme and the timing of when they participate during DNA replication.
4. Then allow them to discuss.

Activity 4

The teacher should guide the learners to carry out the activity on their own.

Hint:

1. You can ask the learners to give their presentations by using:
 - (a) DNA models (plastic or)
 - (b) Coloured chart papers
 - (c) DNA replication animation. This animation clips can be easily downloaded from www.youtube.com. Log on to this site and just type “DNA replication” on the search button, you will find many DNA replication prepared by others.
 - (d) Pictures.
2. **For plastic model:** If the school you are teaching at has a plastic model, that is perfect. Or you can request your school to buy one. If the school has it, then you can ask the learners to use that for their presentation. It will look something like this:

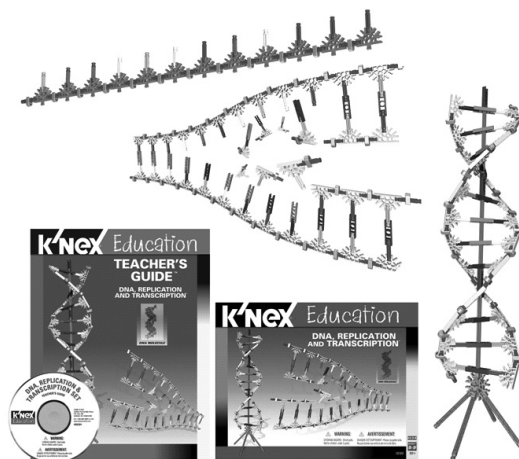

3. **For coloured chart papers:** You ask the learners to use coloured chart to show the mechanism of DNA replication. For this, you may require:
- (a) Coloured chart papers
 - (b) Scissors
 - (c) Glue
 - (d) Markers
 - (e) Thread etc.

The presentation with coloured papers will look something like this. Sorry, coloured papers are not used here.



Double-stranded DNA

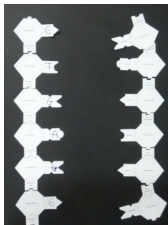

It gets separated with enzymes

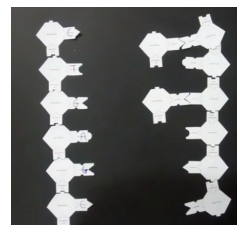

Nucleotides are added

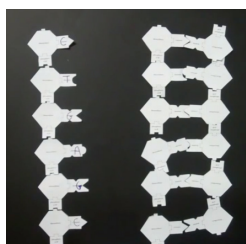

Nucleotides are added

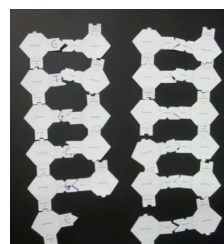

Two DNA molecules are formed at the end.

Activity 5

The teacher should guide the learners to carry out the activity on their own.

Hint:

The main points why there is difference between the rate of replication in bacterial DNA and eukaryotic DNA are given below:

| S. No. | DNA Replication in Prokaryotes | DNA Replication in Eukaryotes |
|--------|---|--|
| 1. | Single origin of replication per DNA molecule | Multiple origin of replications per DNA molecule |
| 2. | It occurs only at one point | It occurs at multiple points |
| 3. | It has one replication bubble | It has multiple replication bubbles |
| 4. | It has one replicon | It has multiple replicons |
| 5. | The rate of DNA replication is about 1000 bp per second | The rate of DNA replication is about 100 bp per second |

Significance of Multiple Replicons

In humans, the haploid genome has 24 chromosomes. These chromosomes consist of about **3 billion base pairs** (Gb) long. And eukaryotic chromosome is **25 times** longer than the prokaryotic chromosome. Moreover, the movement of replication fork is much **slower** in eukaryotes than in prokaryotes. In this kind of condition, if eukaryotic chromosome has only one origin of replication or replicator per chromosome, replication of each chromosome would take many days. So the question is how does the eukaryotic chromosome replicate faster despite having a huge amount of chromosomes?

The answer lies in two main characters of the eukaryotic chromosomes. And they are:

- (a) DNA replication is initiated at many origins of replication throughout the genome.
- (b) DNA replication is bidirectional in nature. In other words, the replication forks move in two directions at a time.

The Rate of Replication in Prokaryotes and Eukaryotes

Prokaryotes

The genome *E.coli* consists of one replicon with a size of 4.6 Mb (million base pairs, the entire genome size). The rate of each replication fork movement is about 1000 base pair (bp) per second. With this rate, *E.coli* takes about 42 minutes to replicate its entire chromosome.

Eukaryotes

The eukaryotic genome consists of multiple replicons. For example in humans, there are about 10,000–100,000 replicons for an average of 30–300 kb (1000 base pairs). And the rate of replication fork movement is about 100 bp per second. Thus, it takes about 8 hours to replicate the entire genome.

4.11 ANSWERS TO SELF-EVALUATION

Self-evaluation

- (i) Replication
- (ii) Meselson, Stahl
- (iii) Conservative, dispersive

Self-evaluation

- (i) Origin Recognition Complex
- (ii) DNA gyrase
- (iii) continuous
- (iv) 8
- (v) complex

Self-evaluation

- (i) Tay Sachs
- (ii) DNA polymerase
- (iii) Black Urine disease
- (iv) Mutation
- (v) Hydrogen

4.12 ANSWERS TO END UNIT ASSESSMENT 4

I. Choose whether the given statements are True (T) or False (F):

1. **False;** In semi-conservative replication model, two identical daughter DNA strands are formed.
2. **False;** Meselson and Stahl's Experiment proved the semi-conservative Model of DNA Replication.
3. **True;** dNTPs are the precursors for the nucleotide formation in DNA. Without these dNTPs, new DNA cannot be synthesized.
4. **False;** In Chargaff's rule of base pairing, Adenine base pairs with thymine.
5. **True;** DNA polymerase I has 3'–5' exonuclease activity and it is helpful in proofreading.
6. **False;** Tay-Sachs disease (TSD) is a fatal autosomal recessive genetic disorder.
7. **True;** Topoisomerase II acts as a swivel to prevent supercoiling of DNA.
8. **True;** Mutation provides variation that can result into beneficial evolution.
A genetic mutation is a permanent alteration in the DNA sequence that makes up a gene; this mutation is lethal.
9. **True;** Synthesis of DNA lagging strand is discontinuous, whereas synthesis of DNA in a leading strand is continuous.
10. **False;** Primer is only required once in a leading strand of DNA, while primer is required again and again in lagging strand of DNA.

II. Multiple choice questions:

1. **(d);** all the options suggest the importance of DNA replication.
2. **(c);** Meselson and Stahl conducted the experiment to prove that DNA replication takes place in a semiconservative manner.

3. **(c)**; During DNA replication, it is the enzyme DNA helicase that unwinds double stranded DNA.
4. **(d)**; DNA requires: a DNA template, dNTPs, DNA polymerase 1, primers, magnesium ions and buffer solutions.
5. **(d)**; all the options ensure accuracy of DNA replication.
6. **(a)**; mistakes not corrected by DNA repair mechanism cause mutation.
7. **(b)**; okazaki fragments are small fragments formed on the lagging strand of DNA.
8. **(b)**; The Mut family of enzymes plays an important role in mismatched repair of DNA.
9. **(a)**; It appears to perform synthesis of DNA on the lagging strand.
10. **(c)**; A protein called single-strand DNA-binding (SSB) proteins bind to each single-strand DNA and stabilise them, so that the separating two strands of DNA do not reform double stranded DNA by complementary base pairing.

III. Long answer type questions:

1. In 1958, Matthew Meselson and Franklin Stahl performed the experiment to test and prove that DNA replication is semi-conservative. In their experiment, they used two isotopic forms of nitrogen, ^{14}N (light) and ^{15}N (heavy), to distinguish newly synthesized strands of DNA from old strands.

Initially, Meselson and Stahl grew *E.coli* (bacteria) for many generations in a medium containing ^{15}N -labelled ammonium chloride ($^{15}\text{NH}_4\text{Cl}$) to incorporate this heavy isotope of nitrogen into their DNA molecule. As expected, the DNA strands in the bacteria had ^{15}N - ^{15}N (heavy) DNA.

In the second stage, they transferred the ^{15}N -labelled bacteria to a medium containing nitrogen in the normal ^{14}N form (light). Then the bacteria were allowed to reproduce for several generations.

Since, the bacteria were grown in the normal ^{14}N form, the entire newly synthesized DNA after the transfer was now labelled with ^{14}N .

Samples of *E.coli* were taken at various time periods as the bacteria continued to reproduce in the medium. The DNAs from these bacteria were extracted and analysed to determine its density. They determined the density of extracted DNAs by using equilibrium density gradient centrifugation technique. This technique uses Cesium Chloride (CsCl), a heavy metal salt that forms solutions of very high density. Thus, they analysed the extracted DNA by simply mixing it with a solution of cesium chloride and then centrifuged at high speed.

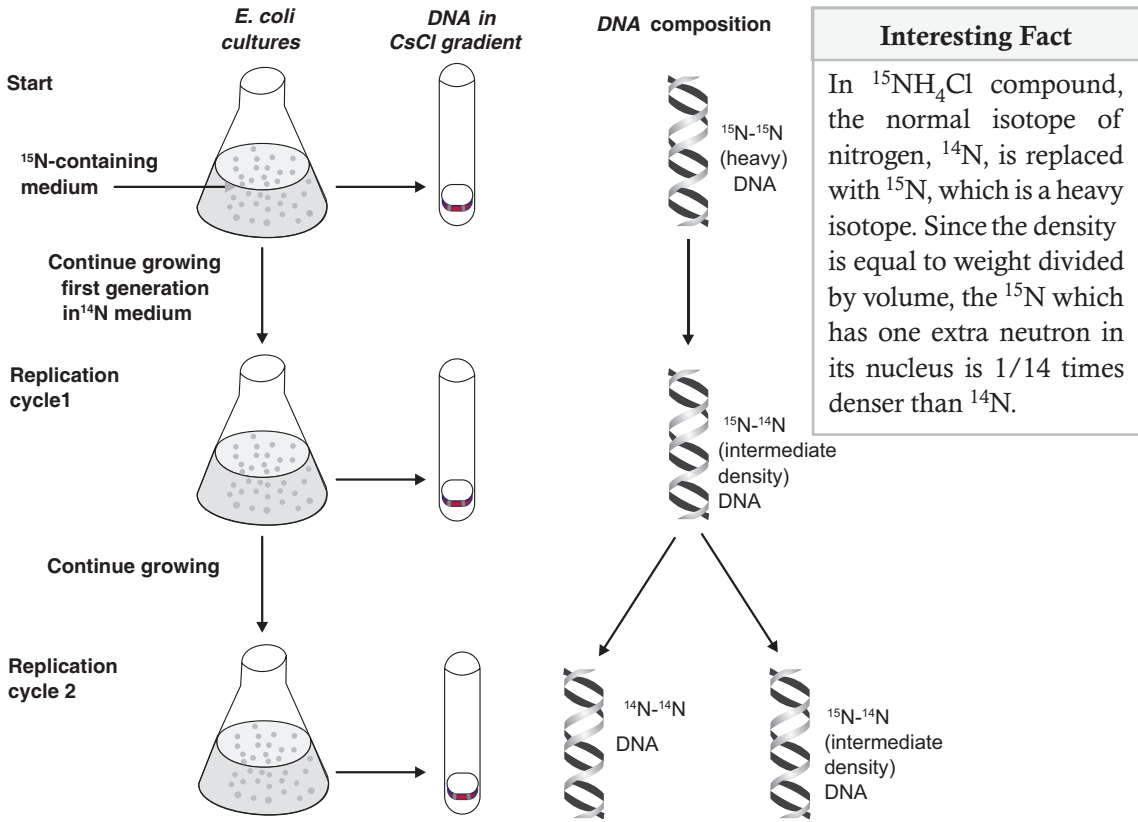

As a density gradient of cesium chloride is established by the centrifugal force, the DNA molecules float “up” and sink “down” within the gradient to reach their equilibrium density positions. The difference in density between the heavy (^{15}N) DNA and the light (^{14}N) DNA causes DNA molecules to rest at different positions by forming bands in the gradient.

Final Observations

First Generation (After One Replication Cycle)

When the observation was made after one replication cycle in the ^{14}N medium, the entire DNA had a density that was exactly intermediate between that of ^{15}N - ^{15}N DNA and that of ^{14}N - ^{14}N DNA. The intermediate composition was ^{15}N - ^{14}N DNA.

Second Generation (After Two Replication Cycles)

Again when the observation was made after two replication cycles, half of the DNA was that of intermediate density (^{15}N - ^{14}N DNA) and half was that of the density of ^{14}N - ^{14}N DNA. The observations made in this experiment exactly tested and proved the prediction of the semi-conservative model. Therefore,

through this experiment, it has been known that DNA replication follows semi-conservative model. At the same time, it disproved the claim that DNA replication follows either conservative or dispersed replication models.

2. Types of DNA Replication Models

Semi-conservative Model

In 1953, Watson and Crick proposed their classic paper postulating a double helix for DNA. A month later, they published another paper suggesting how such base-paired structures in DNA might duplicate itself. The essence of Watson and Crick suggestion is that if DNA molecule was untwisted and the two strands get separated, each strand could act as a template for the synthesis of a new complementary strand of DNA. And this new complementary strand could then be bound to the parental strand of DNA. This replication model is known as the semi-conservative model. It is because half of the parent strand of DNA is retained by newly formed daughter DNA strand.

Conservative DNA Replication Model

In this model, the two parental DNA strands come together right after replication; and as whole, these two parental DNA strands serve as template for the synthesis of completely new daughter DNA strands. As a result, one daughter DNA molecule contains parental DNA strands, while the other daughter DNA molecule contains newly synthesized DNA strands.

Dispersive DNA Replication Model

In this model, the parental double helix is broken or cleaved into double-stranded DNA that acts as templates for the synthesis of new double helix molecules. The segments then reassemble into complete DNA double helices, each with parental and daughter DNA segments interspersed. After the replication, although the two daughter DNA molecules are identical in their base-pair sequence, the parental double stranded DNA has become dispersed throughout both in the daughter DNA molecules.

3. Roles of Enzymes involved in DNA Replications

DNA Polymerase

In 1955, Arthur Kornberg and his colleagues were the first ones to identify an enzyme that could synthesize DNA. Back then this enzyme was originally called as the **Kornberg enzyme**. But now it is called as DNA polymerase I. And the term DNA polymerase by definition encompasses enzymes that catalyses the synthesis of DNA.

There are five DNA polymerases:

- (a) DNA polymerase I
- (b) DNA polymerase II
- (c) DNA polymerase III
- (d) DNA polymerase IV
- (e) DNA polymerase V

On one hand, DNA polymerase I and III are functionally required for replication. On the other hand, DNA polymerase I, II, IV, V are involved in DNA repair.

DNA Helicase

DNA helicase is an enzyme that unwinds or unzips the double stranded DNA by breaking the hydrogen bonds between the complementary bases.

The action of DNA helicase can be compared with a zipper. When we open a zip, the zipper runs on a zip and makes a Y-shape structure with the two strands of interlocking teeth. In the same way, DNA helicase unzips the double stranded DNA and form a Y-shaped fork known as a replication fork.

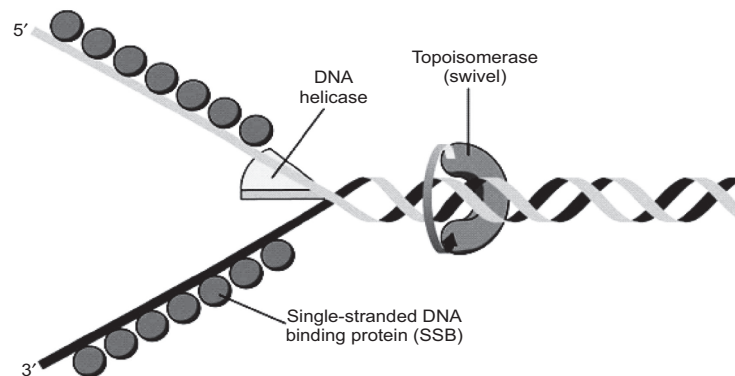

A diagram showing DNA helicase, SSB, and Topoisomerase unwinding double stranded DNA

Single-strand DNA-binding Proteins (SSB)

In DNA replication when helicase unwinds the double stranded DNA, the two separating strands of DNA have the tendency to reform or reanneal into double stranded DNA. A protein called single-strand DNA-binding (SSB) proteins bind to each single-strand DNA and stabilise them, so that the separating two strands of DNA do not reform double stranded DNA by complementary base pairing.

DNA Ligase

At the end of DNA replication right after the DNA Pol I removed and replaced all the RNA primer nucleotides with DNA nucleotides, normally as single-strand

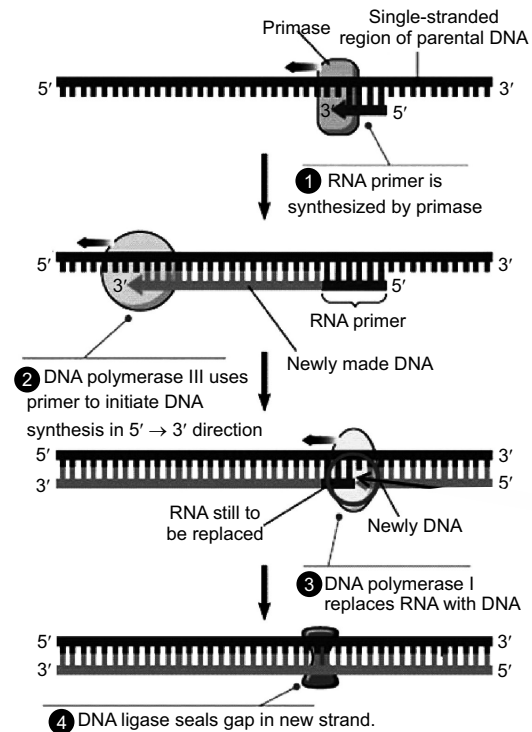

A flow diagram showing DNA ligase sealing the gap in a new DNA strand
nick (gap) is left between the two DNA fragments. This nick is the point where the sugar-phosphate backbone between adjacent nucleotides is unconnected. So what DNA ligase does is that it joins the two fragments resulting into a longer and continuous DNA strand.

Chemically, DNA ligase catalyses the formation of a phosphodiester bond between the 3'-OH and the 5'-phosphate groups on either side of a nick. As a result, it seals the nick(gap).

4. Mechanisms that Ensure Accuracy of DNA Replication

(A) Complementary Base Pairing

The nitrogen bases of DNA follow the Chargaff's rule of base pairing. In simple words, this rule says that Adenine (A) base pairs with Thymine (T); Guanine (G) base pairs with Cytosine (C). This base pairing is very strict and accurate. Thus, the complementary base pairing directs the DNA to replicate very accurately and prevents any mistake to occur.

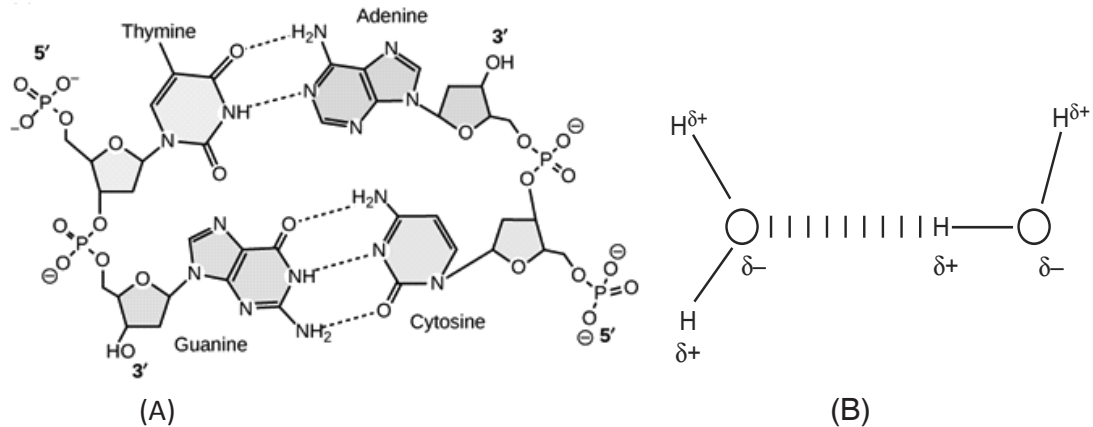

(A) Structure of DNA [See the hydrogen bonds between the four bases (T-A, G-C)]
 (B) A hydrogen bond

Base pairing between purines and pyrimidines is possible because of hydrogen bonds. We can simply define **hydrogen bond** as the **attractive force** between the hydrogen attached to an electronegative atom of one molecule and an electronegative atom of a different molecule. In the structure of DNA, both the strong electronegative atoms, oxygen (O) and Nitrogen (N), are partially negatively charged (δ^-), while the hydrogen (H) has the partial positive charge (δ^+). Hydrogen bonds or interactions play very important role in binding the two bases of the opposite strands in the DNA.

(B) Semi-conservative Nature of DNA

In DNA replication, two of the original strands of DNA act as templates for new DNA to be synthesized. So when the new strands of DNA are synthesized, they are just the complementary bases of the two original template strands of DNA. In this way, original sequence of DNA is semi-conserved with the two original strands of DNA. Thus, the semi-conservative nature of DNA makes the DNA replication highly accurate.

(C) Proofreading

DNA Pol I and DNA Pol II polymerase enzymes have 3' to 5' exonuclease activity, which means that they can remove incorrectly inserted nucleotides from the 3' end to 5' end of the DNA chain. Thus, they play an important role in proofreading mechanism. The insertion of incorrect nucleotides by both DNA Poly I and DNA Poly III occurs at a frequency of one base in a million (10^{-6}).

When incorrect nucleotides are inserted in the newly synthesized DNA, the 3'-5' exonucleases move backward and remove the incorrect nucleotide

from the newly synthesized DNA. Then they resume the forward movement and insert the correct nucleotides in place of the incorrect nucleotides. With this proofreading mechanism, the chances of error occurrence in DNA replication is reduced to one base in a billion (10^{-9}) instead of one base in a million (10^{-6}).

(D) Mismatch Repair

After DNA Replication if there are any mismatched base pairs on the newly synthesized strand, it can be corrected by methyl-directed mismatch repair. In contrast to proofreading mechanism where only one base is repaired by DNA polymerase, the mismatch repair mechanism can replace about thousand bases to make one repair. The Mut family of enzymes plays an important role in mismatched repair.

5. Importance of DNA Replication

Reproduction: One of the most fundamental properties of all living things is the ability to reproduce. It is through reproduction that parents faithfully pass on their genetic information specifying their structure and function to their young ones. At organism level, organisms reproduce either by a sexual or sexual reproduction methods. At cellular level, cells duplicate by cellular division. And at the genetic level, the genetic material duplicates by DNA replication.

Repair: DNA is the centre of instructions that govern the cell's protein production, growth, and many other activities in the cells. With this enormity of precise responsibility, any minor mistakes in the replication process can bring potentially harmful changes in the cell's behaviour or for that matter, the whole organism. Therefore, DNA employs various error repair mechanisms to ensure accurate DNA replication.

Growth: DNA Replication is required for the growth of organisms. DNA replication occurs in two different forms of cellular division. They are mitosis and meiosis. In mitosis, a single parent cell divides and gives rise to two identical daughter cells. Each of the daughter cells has the exact amount of genetic material. Example: Growth of limbs, organs, hair etc. On the other hand, in meiosis, cells divide and give rise to two haploid sex cells. Thus, DNA replication plays a vital role in both mitosis and meiosis.

6. (i) DNA Replication Fork
- (ii) (a) DNA Gyrase, (b) Lagging strand template, (c) Okazaki fragment, (d) Leading strand template
- (iii) The mechanism of DNA Replication can be clearly discussed in the following points.

1. DNA replication starts when DNA helicase unwinds or unzips the DNA at the origin of replication in both the directions.
2. The locally denatured segment of DNA is called replication bubble. The two separated parent DNA strands are called template strands.
3. A Y-shaped structure which is formed when DNA unwinds or unzips to expose the two parent single template strands for DNA replication is called as a replication fork. In most of the cases, replication forks are formed in both sides and, thus, move simultaneously in two opposite directions. In other words, the movement of replication fork is bidirectional.
4. In the next step, DNA helicase recruits DNA primase enzyme. Primase enzyme synthesizes a short RNA primer (about 5–10 nucleotides) on the two template strands through which new nucleotides are added by DNA polymerase III.
5. The denaturing or separating two strands of DNA have the tendency to reform (reanneal) double stranded DNA. A protein called single-strand DNA-binding (SSB) proteins bind to each single-strand DNA and stabilise them, so that the separating two strands of DNA do not reform double stranded DNA.
6. As the two single-strands of DNA are held in Y-shaped position and are stabilized by SSB proteins, the DNA polymerase III now comes and starts adding nucleotides by forming phosphodiester bonds at the 3'-OH of the primer.

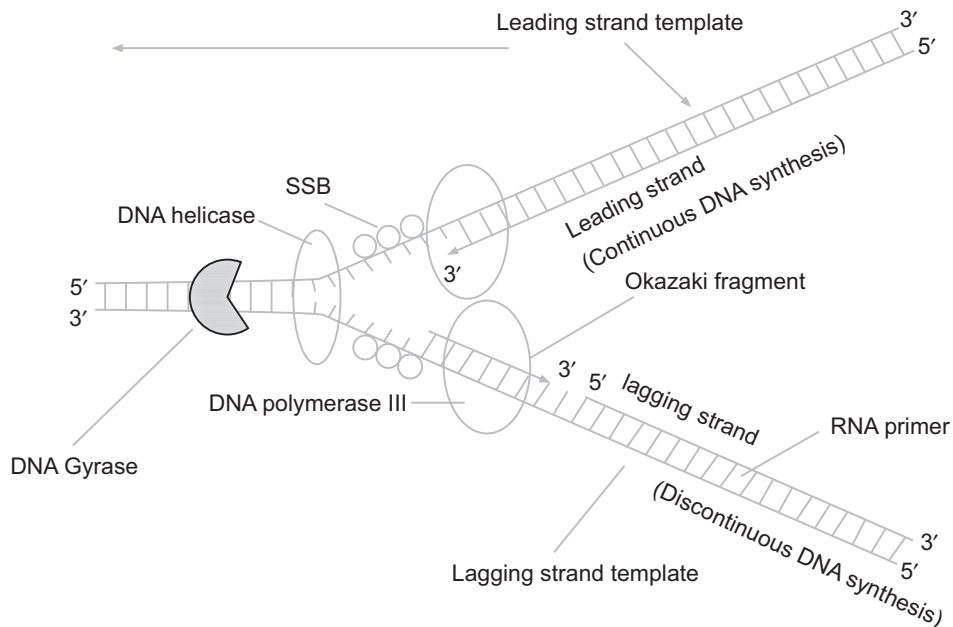

7. The DNA polymerase III can add nucleotides only in 5'–3' directions. However, the two strands of DNA run in opposite directions forming a polarity. Thus, to maintain the 5'–3' polarity of DNA synthesis on both of the two single templates, DNA is simultaneously made in opposite directions of the two template strands.
 - (a) The new DNA strand that is synthesized in the same movement of the replication fork is called the leading strand. This strand requires a single primer for the complete DNA replication.
 - (b) On the contrary, the other new DNA strand that is synthesized in the opposite direction of the movement of replication fork is called the lagging strand. This strand requires primers again and again. Therefore, the newly synthesized DNA strand is discontinuous in nature. And the newly synthesized fragments of DNA on lagging-strand are called Okazaki fragments.
 8. The unwinding of the DNA to form a replication fork creates a tension is relaxed by DNA gyrase or topoisomerase.
 9. At the end of the DNA replication, the RNA primers on the previous Okazaki fragments are removed by DNA polymerase I.
 10. After the DNA polymerase I left, a single-stranded nick is left at the site of the removal of primer. DNA ligase seals the nick. This completes the process of DNA replication.
7. To synthesize DNA, the following components are required for making DNA in a test tube.
- (i) **A DNA template:** The template (original) DNA that is to be copied. A template is a molecule which is used to make a complementary DNA molecule in the DNA synthesis. Normally, the two parental DNA strands act as DNA templates.
 - (ii) **dNTPs (deoxynucleotides):** A mixture of four deoxyribonucleoside 5'-triphosphate (dNTPs) precursors namely: dATP, dGTP, dTTP, and dCTP. These dNTPs are the precursors for the nucleotide formation in DNA. Without these dNTPs, new DNA cannot be synthesized.
 - (iii) **DNA polymerase I (DNA Pol I):** An enzyme to carry out DNA synthesis.
 - (iv) **A primer:** A primer is a short DNA sequence that will bind with the single parent DNA strand and start the DNA synthesis reaction. Without primer, the coming nucleotides cannot directly base-pair with parent DNA template.
 - (v) **Magnesium ions (Mg²⁺):** It is required for DNA polymerase activity to run optimally.
 - (vi) **Buffer:** Provides a suitable chemical environment for optimum activity and stability of the DNA polymerase.

8. Over the years, advantageous mutations, examples of which we look at later, have allowed life to develop and diversify from primitive cells into the multitude of species—including *Homo sapiens*—that exist on Earth today. If DNA replicated perfectly every time, without errors, the only life-forms existing now would be those that existed about three billion years ago: single-cell organisms. Mutations, therefore, are critical to the development of diverse life-forms, a phenomenon known as *speciation*. Mutations that allow an organism to survive and reproduce better than other members of its species are always beneficial, though a mutation that may be beneficial in some circumstances can be harmful in others. Mutations become especially important when an organism's environment is changing—something that has happened often over the course of evolutionary history.

The majority of mutations, however, are less than favourable, and this is illustrated by the relationship between mutation and certain hereditary diseases. An example is Huntington disease, a condition that strikes people in their forties or fifties and slowly disables their nervous systems. It produces shaking and a range of other symptoms, including depression, irritability, and apathy, and is usually fatal. The gene associated with Huntington's is dominant. Most hereditary diseases are, by definition, linked with a mutation. Such is the case with haemophilia, for instance (see Non-infectious Diseases), and with cystic fibrosis, a lethal disorder that clogs the lungs with mucus and typically kills the patient before the age of 30 years. Cystic fibrosis, like Huntington, occurs when a person inherits two copies of a mutated gene.

People with healthy immune systems can be exposed to certain viruses, bacteria, or parasites and have no reaction to them—but people living with HIV/AIDS can face serious health threats from what are known as “opportunistic” infections (OIs). These infections are called “opportunistic” because they take advantage of your weakened immune system, and they can cause devastating illnesses. OIs are signs of a declining immune system. Most life-threatening OIs occur when your CD4 count is below 200 cells/mm³. OIs are the most common cause of death for people with HIV/AIDS. One of the goals of HIV treatment is to lower your risk of getting OIs. Antiretroviral therapy can help by increasing your number of CD4 cells, which will help protect you from OIs.

4.13 ASSESSMENT METHODS

Use observation technique, question answer technique, and demonstration technique to assess the learners' achievement of learning objectives.

4.14 ASSESSMENTS

Formative Assessment

Fill in the blanks:

1. Mutation in causes Tay-Sachs.
2. DNA replication in occurs at multiple points.
3. The semi-conservative nature of DNA makes the DNA replication highly

Ans. 1. Hex-A Gene, 2. Eukaryotes, 3. accurate

Summative Assessment

Answer in one word:

1. What lives in the colon of human beings?
2. Pol δ synthesizes
3. Full form of MCM

Ans. 1. Esherichia coli (bacterium),
2. Lagging strand,
3. Minichromosome maintenance.

Unit 5: Cell and Nuclear Division

5.1 LEARNING OBJECTIVES

| Knowledge and Understanding | Skills | Attitudes and Values |
|--|--|---|
| <ul style="list-style-type: none"> • Describe the main stages of the cell cycle including: interphase (growth and DNA replication), mitosis and cytokinesis. • Explain what is meant by homologous pairs of chromosomes. • Explain the meaning of the terms haploid and diploid. • Describe the process of mitosis and meiosis. • Outline the significance of mitosis in cell replacement and tissue repair by stem cells. • State that uncontrolled cell division can result in the formation of a tumour. • Define meiosis as reduction division in which the chromosome number is halved from diploid to haploid. • Explain the need for reduction prior to fertilization in sexual reproduction. | <ul style="list-style-type: none"> • Interpret data related to time for different cell cycles to identify tissues from which the cells came. • Apply knowledge of mitosis to predict which set of cells came from and which part of the plant and where other cells have come from. • Make a table showing the phases of the cell cycle mentioning one important event that occurs at each phase. • Compare mitosis and meiosis. | <ul style="list-style-type: none"> • Appreciate the importance of effective cell division. • Show concern to individuals with physical disabilities like Down's syndrome. |

| | | |
|---|--|--|
| <ul style="list-style-type: none"> • Outline the role of meiosis in gametogenesis in humans and in the formation of pollen grain and embryo sacs in flowering plants. • Explain how the crossing over and random assortment of homologous chromosomes during meiosis and random fusion of gametes at fertilization lead to genetic variation, including the expression of rare recessive alleles. | | |
|---|--|--|

5.2 TEACHING AIDS

Visual: Images of mitosis and meiosis.

Audio-video: Video showing cell division.

5.3 TEACHER'S TIP

Teacher starts the unit by briefing the learners about mitosis and meiosis. Their role in living organisms. How they contribute to proper segregation of chromosomes. Conditions of haploid and diploid chromosomes and chromosome alignments at different stages of cell division. Teacher explains spindle formation, synapsis, bivalents, chiasma formation via photographs and permanent slides. The difference between the two processes of cell division is well explained.

5.4 TEACHING METHODS

Brainstorming, short lecture technique, group discussion technique, observation technique, drawing technique, demonstration technique, and practical work.

5.5 TEACHING AND LEARNING MATERIALS

Micrographs, compound microscopes, computer animations, prepared slides on root tips and cheek cells, and computer aided learning materials.

5.6 TEACHING METHODOLOGY

Teacher initiates the topic by introducing permanent slides and micrographs of stages of mitosis and meiosis. Teacher assists them to draw diagrams and make charts.

Teacher also discusses the observable features of each stage. Start by asking the learners to tell any of the feature they could cite.

Learners reply to the questions raised by the teacher.

Appreciating them, the teacher further asks if they can explain any one stage.

Learners will come up with varied answers. Some correct, some near to correct, others being irrelevant.

Teacher will not demotivate the child. But agreeing to the correct answers, dwell further in discussion.

Using short lecture technique, the teacher will explain the importance of cell cycle.

Teacher further explains the learners the different significant processes involved with mitosis and meiosis.

5.7 ADDITIONAL CONTENT FOR THE TEACHER

1. Additional information

- (a) **Mitotic Poison:** Colchicine, cyanides, calories and azides.
- (b) **Mitogenesis:** Process of inducing mitosis in a cell.
- (c) **Karyophase:** An intracellular parasite that feeds on the host cell's nucleus.
- (d) **Antephase:** Stage of the cell cycle in which the cell stores energy as ATP for use in cell division. It is in fact G_1 phase.
- (e) **Intranuclear Spindle:** In fungi and many algae, *Amoeba* etc., the nuclear envelope does not degenerate. However, polar poles may appear. An internal spindle is formed which is called intranuclear spindle. It helps in equitable distribution of chromosomes.
- (f) **Syndetic Knot:** In certain plants, all the leptotene chromosomes come in contact at one point to diverse again. The point of contact is called syndetic knot.

2. Supply a specific scientific term for each of the following:

- (a) The period between two successive mitotic divisions.
- (b) Process of cell division by which the chromosome number is halved.
- (c) Point at which two sister chromatids are held together.
- (d) Phase in the cell cycle when protein and RNA is synthesised.
- (e) Nuclear division.

- Ans.** (a) Interphase (b) Meiosis
(c) Centromere (d) G₁ phase
(e) Karyokinesis.

Activity

The teacher can demonstrate this activity in the class.

Aim: To make the learners understand cell division.

Refer to figures in text.

Ask them to prepare chart to compare mitosis and meiosis.

5.8 SUMMARY

- Karyotype is a visual representation of the chromosomes within a single cell.
- Diploid cells contain two complete sets (2n) of chromosomes. Example, skin cells. Haploid cells contain only one complete set (1n) of chromosome. Example, gametes (sperm and egg). Homologous chromosomes are pairs of chromosomes that are similar in length, gene position, and centromere location. Non-homologous chromosomes are chromosomes that contain different genes.
- A typical cell cycle consists of mitotic and interphase phases. Interphase is subdivided into G₀, G₁, S, G₂ phases. S phase is the longest phase.
- Mitosis is subdivided into prophase, prometaphase, metaphase, anaphase, and telophase.
- DNA replication takes place at S phase of interphase prior to mitosis.
- Cytokinesis is a division of cytoplasm and usually follows the process of mitosis.
- Some differentiated cells are arrested at G₀ phase; and they resume cell cycle when they receive signal to divide and repair injured tissues. Example, skin fibroblasts.
- Some cells have stem cells that are undifferentiated biological cells which can differentiate into specialized cells and continually replace the dying cells. Example, hematopoietic (blood-forming) system.
- Unrestrained, uncontrolled growth of cells in cell cycle results into a disease called cancer.
- Meiosis is divided into meiosis I and meiosis II. Meiosis I is a reduction division and is subdivided into prophase I, metaphase I, anaphase I, and telophase I. DNA replication takes place at interphase I prior to meiosis I. Synaptonemal complex is formed during prophase I. Crossing over takes place in meiosis I.
- Meiosis II is just like mitosis. There is no DNA replication. It is divided into prophase II, metaphase II, anaphase II, and telophase II.

- Meiosis is a reduction division. It reduces diploid chromosomes to four haploid daughter cells. Reduction division usually happens before sexual reproduction where haploid gametes (sperm and eggs) are formed for fertilization.
- The process of sperm formation is called spermatogenesis; while the process of egg formation is called oogenesis.
- Meiosis also reduces diploid plant into haploid gametes which eventually fuse to form zygote.
- During meiosis, paternal and maternal homologues assort independently into four daughter cells. This process adds genetic variation.
- Crossing over and random fertilization increase genetic variation in sexual life cycles.
- Improper separation of chromosomes during meiosis results into non-disjunction of chromosomes that are responsible for disease such as Down syndrome.

5.9 WEBLINKS FOR CONTENT ENRICHMENT

- <http://www.nature.com/scitable/knowledge/library/ecologists-study-the-interactions-of-organisms-and-13235586>
- <https://www.khanacademy.org/partner-content/CAS-biodiversity/>
- <http://study.com/academy/topic/interaction-among-organisms-in-the-ecosystem.html>

5.10 LEARNERS' ACTIVITIES

Activity 1

The teacher should guide the learners to perform the activity.

Hint:

There are two basic types of cells: Diploid and haploid cells. The cells which contain two complete sets ($2n$) of chromosomes are called diploid cells. These cells are formed by the fusion of two haploid gametes, one comes from the female parent and the other comes from the male parent. Example, all somatic cells are diploid cells. In contrast, cells that contain only one complete set ($1n$) of chromosome are called as haploid cells. They divide by the process of meiosis. Example is gamete cells in humans. Two separate haploid gametes, one from male parent (sperm $1n$) and another from female parent (ova $1n$), come together and fuse to form a zygote, which is a diploid ($2n$).

Generally, a cycle of reproduction consists of meiosis and fertilization. Before sexual reproduction occurs, gametes undergo meiosis and produce haploid cells. Thus, during sexual reproduction, one haploid ($1n$) gamete comes from the paternal

side and another haploid (1n) gamete comes from the maternal side; then, they both fuse to form a zygote, which is diploid (2n). The fusion of gametes to form zygote or new cell is called fertilization or syngamy.

If meiosis does not occur before sexual reproduction, the chromosome number will double up with each fertilization. And after few generations, the number of chromosomes in each cell would become impossibly large. For example in humans, in just 10 generations, the 46 chromosomes would increase to about 47104 (46×2^{10}).

Thus, it is because of meiosis (reduction division) the number of chromosomes in zygote does increase with every passing generation.

Activity 2

The teacher should guide the learners to perform the activity.

Hint:

1. The teacher should divide the class into groups of two to three learners each.
2. Provide them the permanent slides.
3. Ask them to observe the stages of mitosis and meiosis from the given slides.
4. Ask them to draw a well-labelled diagram of the structures observed.
5. Outline the differences between plant cells and animal cells.
 - Firstly, allow the learners to discuss their results in groups.
 - Secondly, give them time to clarify their doubts from you.

These are the points you are supposed to expect while observing the slides.

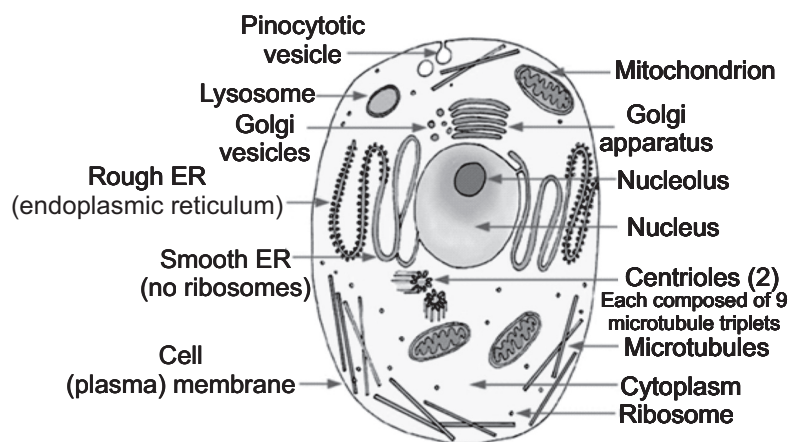

Animal Cell

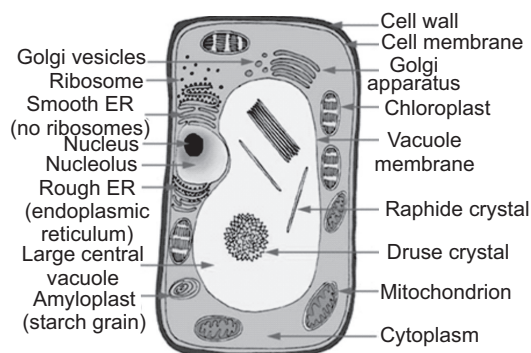

Plant Cell

Differences between animal cell and plant cell



| S. No. | Animal Cell | Plant Cell |
|--------|---|---|
| 1. | Cell wall is absent. | Cellulose cell wall is present. |
| 2. | The shape is round. | The shape is rectangular. |
| 3. | Cytoplasm is denser, more granular and occupies most of the space in the cell. | Cytoplasm is pushed to the periphery and forms a thin lining against the cell wall. |
| 4. | Vacuoles are absent. If present, they are small, temporary and concerned with excretion or secretion. | Vacuoles are large and prominent. Maybe one or more. |
| 5. | Chloroplast is absent. | Chloroplast present. |
| 6. | Centrosome is present with one or two centrioles. | Centrosome is absent but two small clear areas called polar caps are present. These participate in cell division. |
| 7. | Reserve food is stored in the form of glycogen. | Reserve food is stored in the form of starch. |



Activity 3

The teacher should guide the learners to perform the following activity.

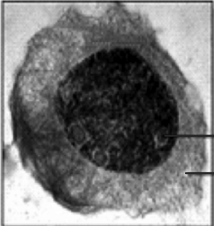
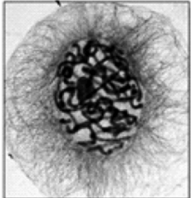
Hint:

1. Fix the permanent slides of onion root tips on the compound microscope.
2. Adjust the lens (10x, 40x etc.) to have a clear view of mitotically dividing onion root cells.
3. Identify the mitotic stage of each cell by following the criteria given in the table below:

| S. No. | Stage of Mitosis | Identifying Features | Expected Diagrams |
|--------|------------------|--|--|
| 1. | Interphase | <ul style="list-style-type: none"> • Dark nucleus • Presence of nucleolus • No condense chromosomes |  <p>Nucleus Cytoplasm</p> <p>Interphase</p> |
| 2. | Prophase | <ul style="list-style-type: none"> • No nucleolus • Condense chromosomes in the nucleus |  <p>Prophase</p> |
| 3. | Prometaphase | <ul style="list-style-type: none"> • Spindle fibres attached on the chromosomes and start aligning chromosomes at metaphase plate |  <p>Prometaphase</p> |
| 4. | Metaphase | <ul style="list-style-type: none"> • Chromosomes aligned at the metaphase plate |  <p>Metaphase</p> |

| | | | |
|----|-------------------------|---|--|
| 5. | Anaphase | <ul style="list-style-type: none"> Chromosomes are separated in two clusters towards the two poles |  <p>Anaphase</p> |
| 6. | Telophase & Cytokinesis | <ul style="list-style-type: none"> The two clusters of chromosomes have reached the poles and formed two daughter cells In cytokinesis, separation of cytoplasm has taken place |  <p>Telophase & Cytokinesis</p> |

4. Ask them to identify and note down the number of cells at their specific stages. Then fill up the table below:

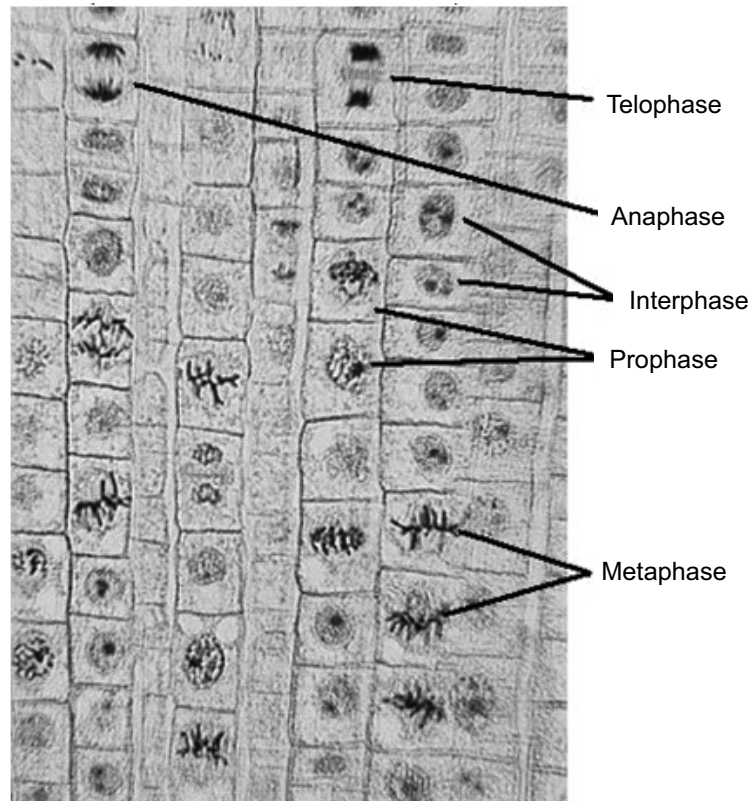

Example:

| S. No. | Stage of Mitosis | Number of Cells |
|--------|---------------------|-----------------|
| 1. | Interphase | 350 |
| 2. | Prophase | 42 |
| 3. | Metaphase | 6 |
| 4. | Anaphase | 3 |
| 5. | Telophase | 2 |
| | Total cells counted | 403 |

5. Onion takes a total time period of 12 hours (720 minutes) to complete mitosis. Now ask them to find out the time period spent by each cells at each stage (i.e., interphase, prophase, etc.) by using the given formula:

$$\text{Time for a phase} = \frac{\text{Number of cells in a stage}}{\text{Total number of cells counted}} \times 720 \text{ minutes}$$

For example: Say, 350 cells were counted at interphase stage. And the total number of cells counted was 403. Then by applying the formula, you can calculate how much time was spent by cells at interphase in 12 hours mitosis cycle.

Time for interphase = $350/403 \times 720$ minutes = 625.3 minutes

6. Ask them to calculate the time period spent by cells at different stages of mitosis and fill up the table below. Let them analyse the maximum and minimum time spent by cells in all stages of mitosis.

| Observation Table | | | | |
|-------------------|------------------|-----------------|-----------------------|------------|
| S. No. | Stage of Mitosis | Number of Cells | Time Period (Minutes) | Percentage |
| 1. | Interphase | 350 | 625.3 | 86.85 % |
| 2. | Prophase | 42 | 75 | 10.42% |
| 3. | Metaphase | 6 | 10.7 | 1.49% |
| 4. | Anaphase | 3 | 5.36 | 0.74% |
| 5. | Telophase | 2 | 3.6 | 0.5% |
| | Total | 403 | | |

Note:

1. Normally, interphase takes the longest time period in the cell cycle.
2. Ask the learners to compare their observations.

Activity 4**Hint:**

1. The teacher should divide the class into groups of three to four learners each.
2. Ask them to firstly identify the stages of meiosis from the given micrographs.
3. Secondly, ask them to outline the events in each stage of meiosis.
4. Ask them to discuss their observations among themselves.

Feedback Time:

1. Comment on the learners observation.

Note: Let the learners maintain separate notebook for class activity and bring it every day when there is activity class.

Activity 5

The teacher should guide the learners to perform the following activity.

Hint:

Normally, sex cells divide by meiosis, while somatic cells divide by mitosis. Sex cells or germ cells are the ones which carry genetic material for the next generation. Any modification in the genetic material (nucleus) of germ cells will pass down to the next generation. On the contrary, any modification in the genetic material (nucleus) of somatic cells will not pass down to the next generation.

The comparison of mitosis and meiosis is given in the following table.

Comparison of Mitosis and Meiosis

| S. No. | Property | Mitosis | Meiosis |
|--------|--------------------------|---|---|
| 1. | Occurrence | Somatic cells | Germ cells/ sex cells |
| 2. | Number of daughter cells | Two diploid cells (2n) | Four haploid cells (1n) |
| 3. | Genetic composition | <ul style="list-style-type: none"> • The two daughter cells are genetically identical to the parent cell. • It is equational division | <ul style="list-style-type: none"> • The four daughter cells are genetically different from parent cell and form each other. • It is reduction division |

| | | | |
|-----|---------------------------------|--|--|
| 4. | Number of divisions | Prophase, prometaphase, metaphase, anaphase, and telophase | Meiosis I: Prophase I, Metaphase I, Anaphase I, Telophase I Meiosis II: Prophase II, Metaphase II, Anaphase II, Telophase II |
| 5. | DNA Replication | Occurs during S phase of interphase prior to mitosis | Occurs during S phase of interphase prior to meiosis I |
| 6. | Functions in the animal body | <ul style="list-style-type: none"> • It enables multi-cellular adult to arise from zygote • It helps in production of cells in growth and repair • Asexual reproduction in some animals | <ul style="list-style-type: none"> • It produces gametes (sperms and eggs) • It reduces the number of chromosome by half from diploid (2n) to haploid(1n) • It introduces genetic variation among the gametes |
| 7. | Synapsis | It does not occur | Synapsis through synaptonemal complex |
| 8. | Crossing over | It does not occur | Crossing over occurs between two non-sister chromatids during meiosis I |
| 9. | Chiasmata | No chiasmata formation | Chiasmata, sites of crossing over, formation occurs |
| 10. | Homologs on the metaphase plate | Individual chromosomes aligned at metaphase plate | Homologous pairs of chromosomes are aligned at metaphase plate during metaphase I |
| 11. | Sister chromatids | Sister chromatids separate at anaphase | During meiosis I, the replicated chromosomes of each homologous pair move toward opposite poles at anaphase I; however, sister chromatids separate only at anaphase II |
| 12. | Cytokinesis | Cytokinesis occurs after mitosis | Cytokinesis doesn't occur after meiosis I but occurs after meiosis II |

| | | | |
|-----|--------------------------------|---|---|
| 13. | Centromeres | Division of centromeres takes place at anaphase | Division or cleavage of centromeres takes place only at anaphase II |
| 14. | Chromosomes at metaphase plate | Chromosome pairs are aligned at metaphase plate | Duplicated chromosome pairs are aligned at metaphase plate |

Activity 6

The teacher should guide the learners to perform the activity.

Hint:

- Teacher can take the learners to any research institutes where research on skin culture is carried out.
- You can ask them to use internet or library to carry out research to find out why cultured skin is grown in a medium of proteins similar to blood.
- Once they are done with their research, ask them to write a journal to summarise their research.

5.11 ANSWERS TO SELF-EVALUATION

Self-evaluation

- | | |
|----------------------|---------------|
| (i) S | (ii) nucleus |
| (iii) G ₀ | (iv) 24 hours |
| (v) uncontrolled | |

Self-evaluation (*Page 120 of Student's Book*)

- | | |
|--------------------------|------------------|
| (i) metaphase | (ii) metaphase 1 |
| (iii) reduction division | (iv) variation |
| (v) klinefelter | |

5.12 ANSWERS TO END UNIT ASSESSMENT 5

I. Choose whether the following statements are True (T) or False (F):

- | | |
|----------|----------|
| 1. True | 2. True |
| 3. False | 4. True |
| 5. True | 6. False |
| 7. True | 8. True |
| 9. False | 10. True |

II. Multiple choice questions:

1. **(d)**; four
2. **(a)**; Gametogenesis
3. **(a)**; two
4. **(d)**; four
5. **(a)**; blood cells (haematopoietic system)
6. **(b)**; non-disjunction
7. **(d)**; Condensation of chromatids takes place in prophase.
8. **(a)**; Sister chromatids separate and give rise to daughter chromosomes.
9. **(d)**; Simple explanation is given below (Example—Human beings):
Parent cell = 46 chromosomes (Diploid)
Meiosis I = 2 cells (each chromosome with sister chromatids) = $46 * 2 = 92$ chromosomes.
Meiosis II = 4 haploid cells with unreplicated chromosomes = $92/4 = 23$ chromosomes (Haploid)
10. **(a)**; Only one egg matures in oogenesis.
11. **(d)**; All of them lead to genetic variation.
12. **(d)**; None of these occurs at mitosis.
13. **(d)**; All of these cells divide by mitosis.
14. **(c)**; Gametes are sex cells which divide by meiosis.
15. **(d)**; All of them.
16. **(d)**; Both pollen grains and ova divide by meiosis, while root tips divide by mitosis.

III. Long answer type questions:

1. Cell cycle is a cyclical event of cell growth, mitosis, and cell division. All somatic cells of an organism's body divide by mitosis. The cell cycle basically consists of two phases: Mitotic Phase and Interphase.
 - (a) **Mitotic (M) Phase:** It includes mitosis and cytokinesis. Mitosis is the division of nucleus while cytokinesis is the division of cytoplasm. As result of mitotic phase, one cell divides into completely two identical daughter cells.
 - (b) **Interphase:** A typical cell spends most of its time in interphase. It accounts for about 90% of the whole cell cycle. Interphase involves growth and DNA replication processes. It is further divided into :
 - (i) **G₀:** It is a resting phase and it can be temporary or permanent.

- (ii) **G1-Phase:** It is also called first growth phase or post mitotic gap phase. During this phase, the cell grows in size and there is an active synthesis of RNA and proteins. In this phase, the cell carries out its physiological functions and prepares the machinery needed for the cell to proceed to the next stage. A large number of nucleotides, amino acids for histone synthesis and energy rich compounds are formed. Cell organelles also increase in number. However, it shows no change in its DNA content.
- (iii) **S-Phase:** It is also called synthetic phase. In this phase, DNA molecule of each chromosome replicates by the synthesis of a new DNA on the template of the existing DNA. Thus, the DNA content doubles and a duplicate set of genes are formed. Along with DNAs, chromatin fibres also replicate. As chromatin fibres are elongated chromosomes, each chromosome comes to have two chromatin threads or sister chromatids which remain attached at a common point called centromere. The cell thus retains the original diploid ($2n$) chromosome number but now has a duplicate set of genes. S-phase is also called invisible phase of mitosis, since in this phase chromosome prepares themselves for equitable distribution later on. The centriole, also divides into two centriole pairs in the cells containing the same.
- (iv) **G2-phase:** It is also called second growth phase or premitotic gap phase. The synthesis of RNA and protein continues in this phase and the cell prepares itself to go into the mitotic phase. The phase produces macromolecules for multiplication of cell organelles, spindle formation and cell growth. During G2-phase a cell contains double DNA content, i.e., $1C$ to $2C$ for haploid cells and $2C$ to $4C$ for diploid cells.

Data Related to Time for Different Cell Cycles

The time consumed by each stage in the cell cycle varies from organism to organism. In human beings, one round of cell cycle takes 24 hours. The relative time division is:

- (a) G1 phase takes about 5–6 hours.
- (b) S phase takes about 10–12 hours.
- (c) G2 phase takes about 4–6 hours.
- (d) M phase takes about less than one hour.

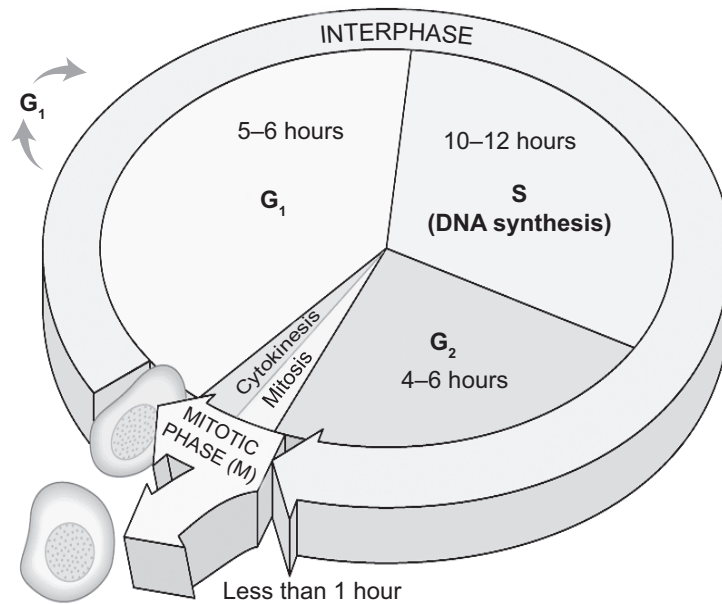

2. The chromosome pairs, one from each parent, which is similar in length, gene position, and centromere location, is called a homologous chromosome. In humans, for example, the 23 chromosome pairs are homologous chromosomes.
3. **Diploid:** The cells which contain two complete sets ($2n$) of chromosomes are called diploid cells. These cells are formed by the fusion of two haploid gametes, one comes from the female parent and the other comes from the male parent. For example, all the somatic cells are diploid cells.

Haploid: In contrast, the cells that contain only one complete set ($1n$) of chromosome are called haploid cells. Example is gamete cells in humans. Two separate haploid gametes, one from male parent (sperm, $1n$) and another from female parent (ova, $1n$), come together and fuse to form a zygote, which is a diploid ($2n$).

4. Mitosis is one of the phases of cell cycle, which normally last only about less than an hour. It is a process where a single cell divides into two identical daughter cells. And it is normally followed by cytokinesis but not always. The process of mitosis is basically divided into five phases:
 - A. Prophase
 - B. Prometaphase
 - C. Metaphase
 - D. Anaphase
 - E. Telophase

A. Prophase

 - The chromosome fibres become more tightly coiled.
 - The chromatids condense into discrete chromosome.

- Each chromosome can be seen to consist of two sister chromatids.
- Nucleolus shrinks and eventually disappears in most species.
- Two pairs of centrioles are seen. The mitotic spindle assembles outside the nucleus.
- The radial arrays of shorter microtubules are called as asters.
- In most animal cells, the centrioles are the focal points for spindle assembly. Higher plants do not have centrioles, though they do have a mitotic spindle.

B. Prometaphase

- The nuclear envelope breaks down at the end of prophase.
- The developing spindle now enters or invades the former nuclear area.
- The chromosomes have even become more condense.
- Kinetochores, a specialized multiprotein complex, bind to each centromere.
- Kinetochore microtubules extend from both the poles and bind to kinetochores of chromatids.
- Non-kinetochore microtubules originate from the two opposite poles and enter into the nuclear area where they overlap in the middle of the spindle.

C. Metaphase

- The centrosomes are now at opposite poles of the cell.
- The kinetochore microtubules from the two poles orient the chromosomes in such a way that their centromeres become aligned at the metaphase plate, an imaginary plane that is equidistant between the two poles of the spindle apparatus.

D. Anaphase

- Once the centromeres are attached to the two sister chromatids, they start separating and move towards the opposite poles. Consequently, the joined centromeres of sister chromatids separate and give rise to two daughter chromosomes.
- The separation continues until the two poles of the cell have equivalent and complete chromosomes.

E. Telophase

- The two sets of daughter chromosomes are assembled into two groups at opposite ends of the cell.

- The chromosomes begin to uncoil and assume the elongated state characteristic of interphase.
- A nuclear envelope starts forming around each group of chromosomes.
- The spindle microtubules disappear; and the nucleolus or nucleoli reform.
- At this point, nuclear division is complete and the cell now has two identical nuclei.

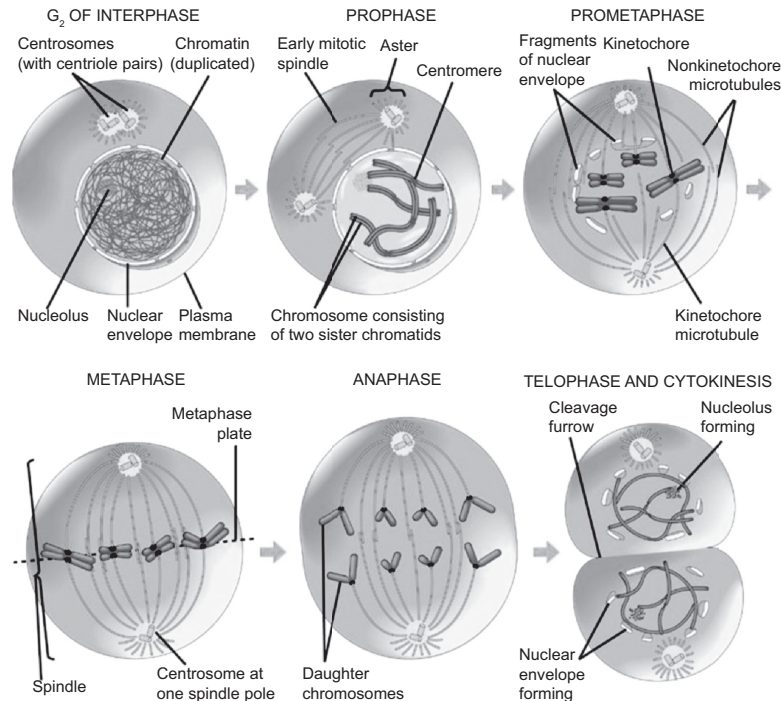

Cytokinesis is a division of cytoplasm. It compartmentalizes the two new nuclei into separate daughter cells, completing mitosis and cell division. In animal cells, cytokinesis is characterized by a constriction in the middle of the cell. The constriction continues until two daughter cells are produced. In plant cells, a new cell membrane and cell wall are assembled between the two new nuclei to form a cell plate. Cell wall material coats each side of the plate, and the result—two progeny cells.

5. Meiosis is a reduction division where the number of chromosomes are reduced to half from diploid parent cell to haploid daughter cells. It is divided into two stages: Meiosis I and Meiosis II. The process of Meiosis alternates with an interphase, which is subdivided into G₁, S, and G₂ phases. Meiosis I is further subdivided into prophase I, metaphase I, anaphase I, and telophase I.

In the same way, Meiosis II is also subdivided into prophase II, metaphase II, anaphase II, and telophase II.

Meiosis I

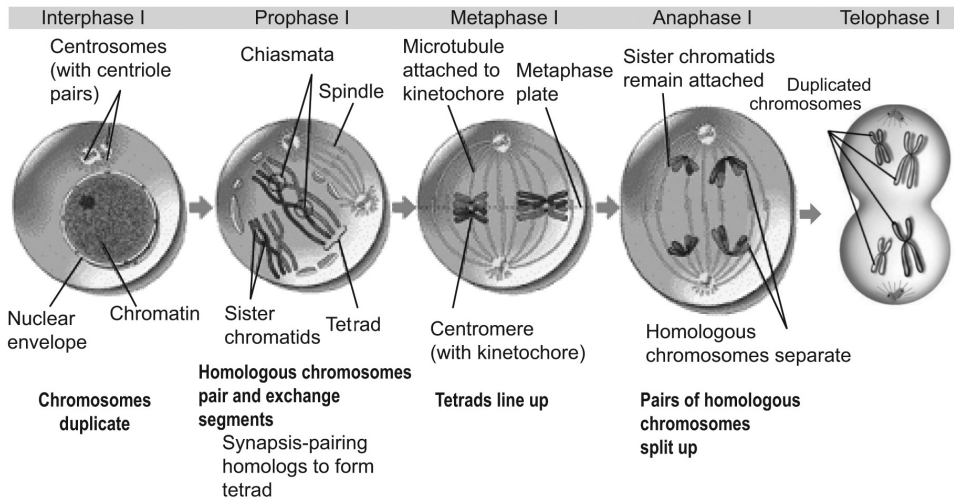

Prophase I

The DNA in prophase I coils tighter, and individual chromosomes first become visible under the light microscope as a matrix of fine threads. Since the DNA has already replicated during the S phase of interphase prior to meiosis I, each of the chromosomes actually consists of two sister chromatids joined together at their centromeres.

Pairing or synapsis

In prophase I, homologous chromosomes become closely associated in synapsis. Synapsis includes the formation of an elaborate structure called the synaptonemal complex, consisting of homologous chromosomes paired closely along a lattice or zipper-like structure of proteins between them. The components of synaptonemal complex include a meiosis-specific form of cohesin, that helps the two homologous chromosomes to be closely associated along their length.

Crossing over or recombination

Crossing over in meiosis I allows the homologous chromosomes to exchange their chromosomal material. During this, the crossing over between sister chromatids is suppressed. Reciprocal crossing over occurs only between non-sister chromatids and is controlled in such a way that each chromosome arm usually has one or a few crossovers per meiosis. In human beings, the crossovers are typically two to three in number.

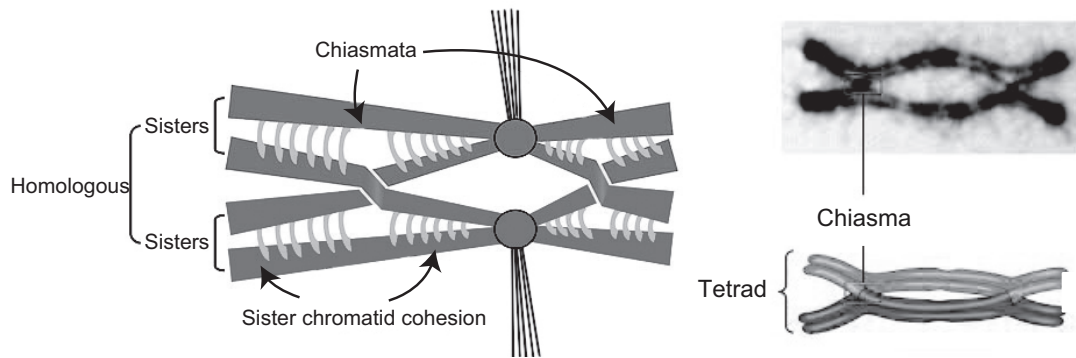

Once the crossing over process is complete, the synaptonemal complex breaks down, and the homologous chromosomes become less tightly associated. But the homologous chromosomes remain attached at one particular point called chiasmata (chiasma-singular). At this point, there are four chromatids of the two homologous chromosomes.

Two homologous chromosomes consist of two sister chromatids each. This structure of four chromatids of the two homologous chromosomes attached at chiasmata is called tetrad or bivalent. Some of the other events that occur along with synapsis are:

1. The nuclear envelope breaks down.
2. Two pairs of centrosomes migrate to opposite poles.
3. Spindle fibres formation occurs.

Metaphase I

During metaphase I, the chiasmata have moved down on the paired homologous chromosomes towards the ends. At this point, chiasmata are now called as terminal chiasmata. The terminal chiasmata hold the homologous chromosomes together so that the homologous chromosomes are now aligned at the equator of the cell. The kinetochores microtubules from the opposite poles become attached to the kinetochore of homologous chromosomes.

The attachment of kinetochore microtubules at the monopolar centromere of each homologue creates a tension on the homologous chromosomes, which are joined by sister chromatid cohesin at chiasmata.

Anaphase I

During anaphase sister chromatid cohesion is released and the homologous chromosomes are pulled apart to the opposite poles, but not the sister chromatids. Now when the spindle fibres have fully contracted, each pole has a complete haploid set of chromosomes consisting of one member of each homologous pair.

Telophase I

In telophase I, the chromosomes are segregated into two clusters at the two opposite poles. Then the nuclear membrane reforms around each daughter nucleus. At the two poles, each chromosome has sister chromatids attached to its centromere. And the interesting thing is that the sister chromatids are no longer identical because of the crossing over that had taken place in prophase I.

Cytokinesis

Cytokinesis is the process of dividing the cytoplasm and its content into two equal cells. Right after telophase I, cytokinesis may or may not occur. Meiosis I is followed by meiosis II, which occurs after an interval of variable length.

Meiosis II

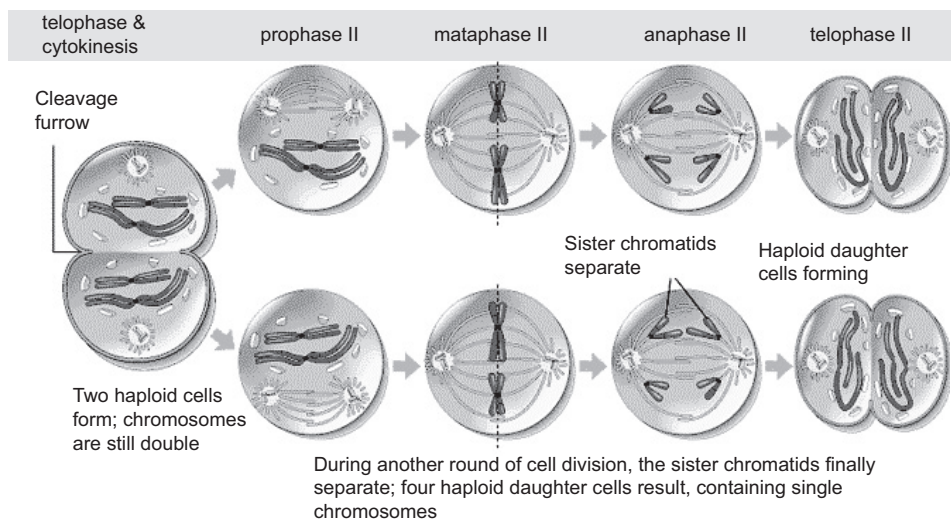

Meiosis II is like mitotic division, which results into division of two equal cells without DNA replication. Normally, the gap between meiosis I and meiosis II is interrupted by interphase. But the interphase is very brief and it does not contain S phase. Like mitosis cell division, meiosis II is also subdivided into subphases. They are: (a) Prophase II (b) Metaphase II (c) Anaphase II (d) Telophase II.

Prophase II

Prophase II is brief. In prophase II, nuclear envelope breaks down and formation of new spindle fibres takes place.

Metaphase II

In metaphase II, the kinetochore microtubules extend themselves from the two poles and bind to kinetochores of each sister chromatid. These kinetochore

microtubules start pulling the sister chromatids toward the two opposite poles. As a result, the sister chromatids are aligned at the metaphase plate.

Anaphase II

In anaphase II, as the spindle fibres contract, the cohesin complex joining the centromeres of sister chromatids is destroyed or cleaved. As a result, the centromeres are split and the sister chromatids are pulled towards the two opposite poles.

Telophase II

In telophase, the nuclear envelope reforms around the four set of haploid daughter chromosomes. Then cytokinesis follows resulting into complete four set of haploid daughter cells. These haploid daughter cells may follow different fate depending upon the organisms. In animals, these haploid daughter cells develop directly into gametes i.e. sperms and eggs. In plants, fungi, and many protists, they may divide mitotically to produce greater number of gametes.

6. In the early development of an organism, the embryonic cells rapidly proliferate and differentiate into specialized cells of adult tissues and organs. As cells differentiate from time to time, their rate of proliferation usually decreases. As a result, most cells in adult animals are arrested at the G₀ stage. Some cells at this phase may resume the cell cycle and proliferate when they receive certain signals.

Some of the differentiated cells enter the G₀ resting phase and wait for the signal to resume the cell cycle to repair injured tissue. There are numerous examples such as skin fibroblast, endothelial cells, smooth muscle cells, and liver cells. Skin fibroblasts upon receiving growth factor, skin fibroblast start secreting collagen and help in repairing cuts or wounds. Most of the fully differentiated cells no longer possess the capability of cell division. Therefore, they can be replaced by stem cells.

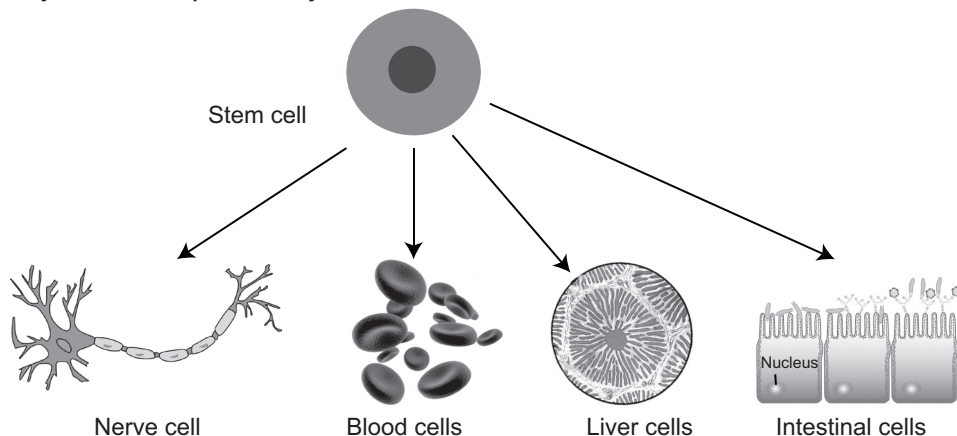

Stem cells are undifferentiated biological cells that can differentiate into specialized cells and can divide (through mitosis) to produce more stem cells. The prominent role of stem cells can be seen in—blood cells (hematopoietic system), epithelial cells of the skin, and epithelial cells lining the digestive tract. All of these cells have short life spans, and they must be replaced continually by continual cell proliferation in adult animals.

The life span of blood cells ranges from less than one day to a few months. All of these cells are derived from the same population of hematopoietic stem cells. In fact, there are more than 100 billion blood cells that are lost every day in humans. If there are no stem cells to replace the loss of these cells, human beings will not be able to survive. Hence, these cells are continually being replaced by the cells produced from hematopoietic stem cells in the bone marrow.

7. Cancer cells can be dangerous when they start behaving abnormally in the body. The main problem arises when a single cell in a tissue undergoes a process called transformation. It is a process where a normal cell is converted into a cancer cell. Normally, the body's immune system will recognize the transformed cell as a foreign invading cell and, thus, destroys it. However, if the transformed cell evades or escapes the destruction, it may proliferate and form a tumor mass of abnormal cell. Tumors can be discussed in three sub-headings:
 - (a) **Benign tumour:** The lump of the abnormal cells that remains at the original site. Most benign tumors do not cause serious problems and can be completely removed by surgery.
 - (b) **Malignant tumour:** These are abnormal cells that have become invasive enough to impair with the functions of one or more organs. An individual with a malignant tumor is said to have cancer.
 - (c) **Metastasis:** A few tumour cells may separate from the original tumour, enter blood vessels and lymph vessels, and travel to other parts of the body. In the other parts of the body, they may proliferate and form a new tumour. This spread of cancer cells to locations distant from their original site is called metastasis.
8. Generally, a cycle of reproduction consists of meiosis and fertilization. Before sexual reproduction occurs, gametes undergo meiosis and produce haploid cells. Thus during sexual reproduction, one haploid ($1n$) gamete comes from the paternal side and another haploid ($1n$) gamete comes from the maternal side; then, they both fuse to form a zygote, which is diploid ($2n$). The fusion of gametes to form zygote or new cell is called fertilization or syngamy.

If meiosis does not occur before sexual reproduction, the chromosome number would double up with each fertilization. And after few generations, the number

of chromosomes in each cell would become impossibly large. For example in humans, in just 10 generations, the 46 chromosomes would increase to about 47104 (46×210).

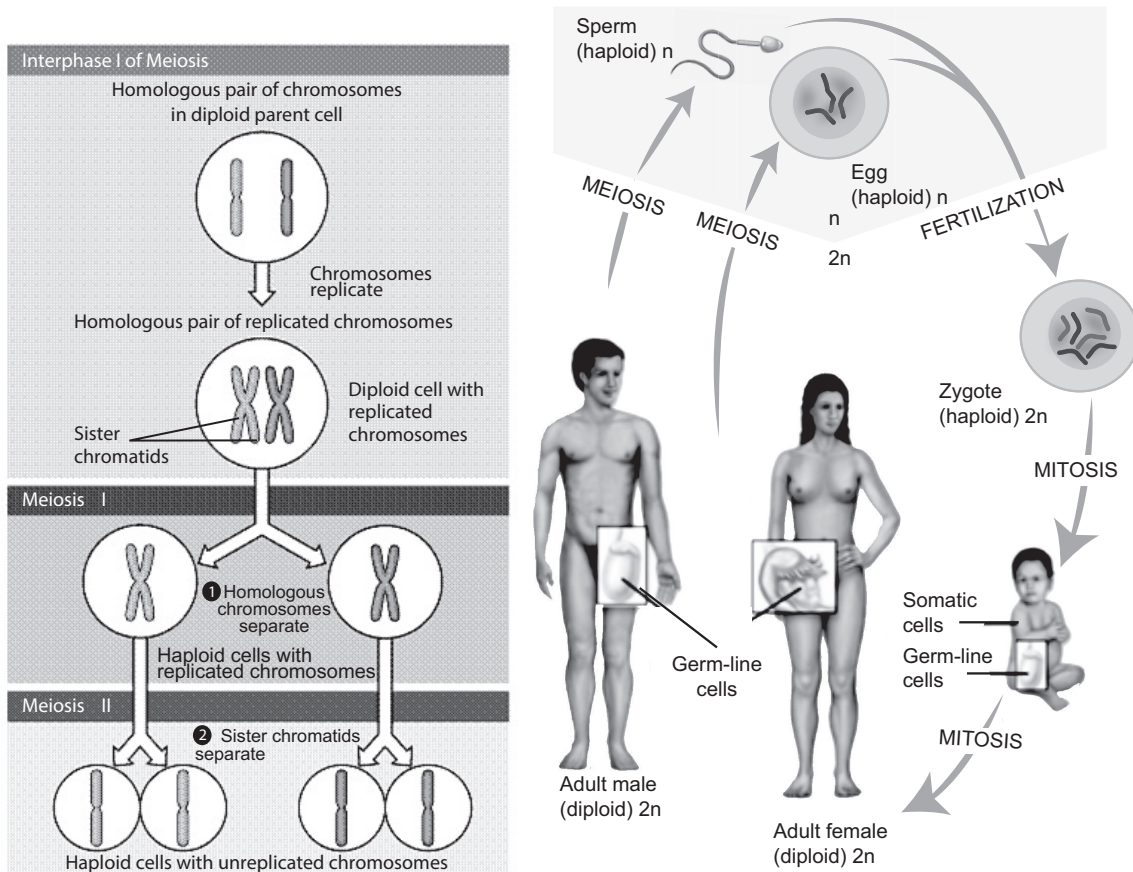

9. Cell division is the process by which a parent cell divides into two or more daughter cells. The two types of cell division are generally called mitosis and meiosis.

Significance of Mitosis in Living Organisms

In the early development of an organism, the embryonic cells rapidly proliferate and differentiate into specialized cells of adult tissues and organs. As cells differentiate from time to time, their rate of proliferation usually decreases. As a result, most cells in adult animals are arrested at the G₀ stage. Some cells at this phase may resume the cell cycle and proliferate when they receive certain signals.

Some of the differentiated cells enter the G₀ resting phase and wait for the signal to resume the cell cycle to repair the injured tissue. There are numerous examples such as skin fibroblast, endothelial cells, smooth muscle cells, and

liver cells. Skin fibroblasts upon receiving growth factor, start secreting collagen and help in repairing cuts or wounds.

Most of the fully differentiated cells no longer possess the capability of cell division. Therefore, they can be replaced by stem cells. Stem cells are undifferentiated biological cells that can differentiate into specialized cells and can divide (through mitosis) to produce more stem cells. The prominent role of stem cells can be seen in—blood cells (hematopoietic system), epithelial cells of the skin, and epithelial cells lining the digestive tract. All of these cells have short life spans, and they must be replaced continually by continual cell proliferation in adult animals.

Significance of Meiosis

Cells Undergo Reduction Division Prior to Sexual Reproduction

Generally, a cycle of reproduction consists of meiosis and fertilization. Before sexual reproduction occurs, gametes undergo meiosis and produce haploid cells. Thus during sexual reproduction, one haploid (1n) gamete comes from the paternal side and another haploid (1n) gamete comes from the maternal side; then, they both fuse to form a zygote, which is diploid (2n). The fusion of gametes to form zygote or new cell is called fertilization or syngamy. If meiosis does not occur before sexual reproduction, the chromosome number would double up with each fertilization. And after few generations, the number of chromosomes in each cell would become impossibly large. For example in humans, in just 10 generations, the 46 chromosomes would increase to about 47104 (46×2^{10}).

Role and Significance of Meiosis in Producing Gametes

Gametogenesis is a biological process by which diploid cells undergo cell division and differentiation to form mature haploid gametes. It occurs through meiosis. In humans, the male gamete (sperm) is produced by a process called spermatogenesis and the female gamete (egg) is produced by a process called oogenesis through meiotic division.

Here, gamete function takes place soon after meiosis but in plants it happens after gametophyte formation sexual reproduction of plants starts with spore formation. Sporophyte is a diploids generation of flowering plant where haploid spores are produced by meiosis which in turns undergoes mitosis to form multi-celled haploid gametophytes. These haploid gametophyte differentiate to produce gametes—sperm and egg cells. Similarly, embryo sac is formed by

reduction division. Each of the cells of embryo sac is haploid. Two of the nuclei fuse to produce diploid nucleus.

10. Gametogenesis is a biological process by which diploid cells undergo cell division and differentiation to form mature haploid gametes. It occurs through meiosis. In humans, the male gamete (sperm) is produced by a process called spermatogenesis and the female gamete (egg) is produced by a process called oogenesis through meiotic division.

Here gamete function takes place soon after meiosis but in plants it happens after gametophyte formation sexual reproduction of plants starts with spore formation. Sporophyte is a diploids generation of flowering plant where haploid spores are produced by meiosis which in turns undergoes mitosis to form multi-celled haploid gametophytes. These haploid gametophyte differentiate to produce gametes—sperm and egg cells. Similarly, embryo sac is formed by reduction division. Each of the cells of embryo sac is haploid. Two of the nuclei fuse to produce diploid nucleus.

The Role of Meiosis in Reproduction of Plants

Generally, plants reproducing sexually have life cycle consisting of two phases:

- (a) A multi-cellular gametophyte or haploid stage: It is a haploid stage with n chromosomes. It alternates with a multicellular sporophyte stage.
- (b) A multi-cellular sporophyte or diploid stage: It is a diploid stage with $2n$ chromosomes, made up of n pairs. A mature sporophyte produces spores by meiosis, a process which reduces the number of chromosomes from $2n$ to $1n$.

Alternation of generations (also known as mutagenesis) refers to the occurrence in the plant life cycle of both a multi-cellular diploid organism (sporophyte) and a multi-cellular haploid organism (gametophyte), each giving rise to the other. This is in contrast to animals, in which the only multi-cellular phase is the diploid organism (such as the human man or woman), whereas the haploid phase is a single egg or sperm cell.

In bryophytes (mosses and liverworts), the dominant generation is haploid, so that the gametophyte comprises the main plant. On the contrary, in tracheophytes (vascular plants), the diploid generation is dominant and the sporophyte comprises the main plant.

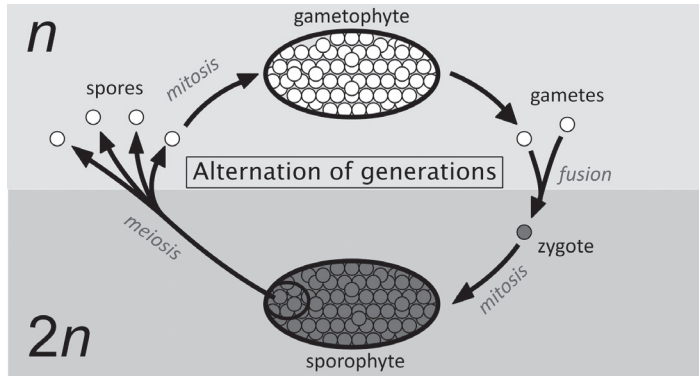

11. During crossing over, DNA segments of the two parents—paternal and maternal—are combined into a single chromosome producing recombinant chromosomes, which are non-identical with their sister chromatids. In humans, an average of one to three crossing over events occur per chromosome pair, depending on the position of their centromeres and on the size of the chromosome.

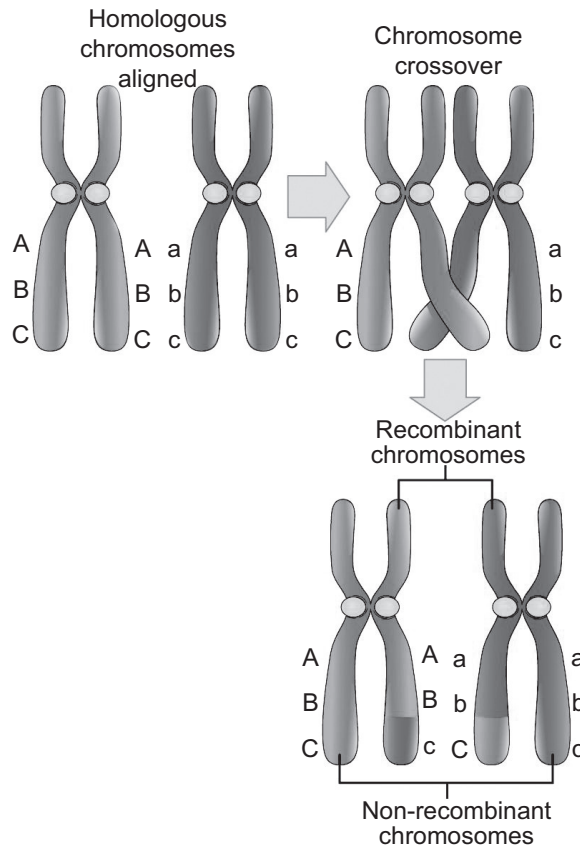

Thus, crossing over is an important event of meiosis that brings genetic variation in sexual life cycles. Besides independent assortment and crossing

over, the random fertilization during sexual reproduction also increases genetic variation in organisms. During random fertilization the male gamete and female gamete fuse to form zygote. The most interesting thing is that this zygote has the possibility of about 70 trillion diploid combinations. The number 70 trillion comes from possible combinations of male and female gametes which are $223 \times 223 = 70$ trillions. The possibility of this enormous number of combinations makes each and everyone of us unique physically and genetically.

12. (i) Anaphase I
(ii) (1) Astral pole (2) chromosome fibres or tractile fibrils (3) spindle fibre (4) constriction
(iii) Germ cells
(iv) Non-disjunction of homologous chromosomes.
13. HIV is a virus that attacks a type of white blood cell called CD4 cells. It uses their nucleus, which is an organelle, to reproduce, then it destroys the cell. Over time, your number of CD4 cells drops extremely low, leaving you open to infection. This stage of HIV is called AIDS.

Most commonly, people get or transmit HIV through sexual behaviours and needle or syringe use. HIV is not spread easily. Only certain body fluids from a person who has HIV can transmit HIV:

- Blood
- Semen (cum)
- Pre-seminal fluid (pre-cum)
- Rectal fluids
- Vaginal fluids
- Breast milk

These body fluids must come into contact with a mucous membrane or damaged tissue or be directly injected into your bloodstream (by a needle or syringe) for transmission to occur. Mucous membranes are found inside the rectum, vagina, penis, and mouth.

HIV enters the CD4 Cells and becomes a part of them. When the cell replicates using **mitosis**, more of the HIV virus is created.

HIV destroys the CD4 Cells, which makes the body vulnerable to disease.

The HIV cell's life cycle involves its binding to a CD4 cell, its fusion to the plasma membrane, then the HIV's DNA combines with the cell's nucleus. The CD4 cell reproduces, creating more HIV. The HIV leaves the cell after it is replicated, destroying the cell in the process.

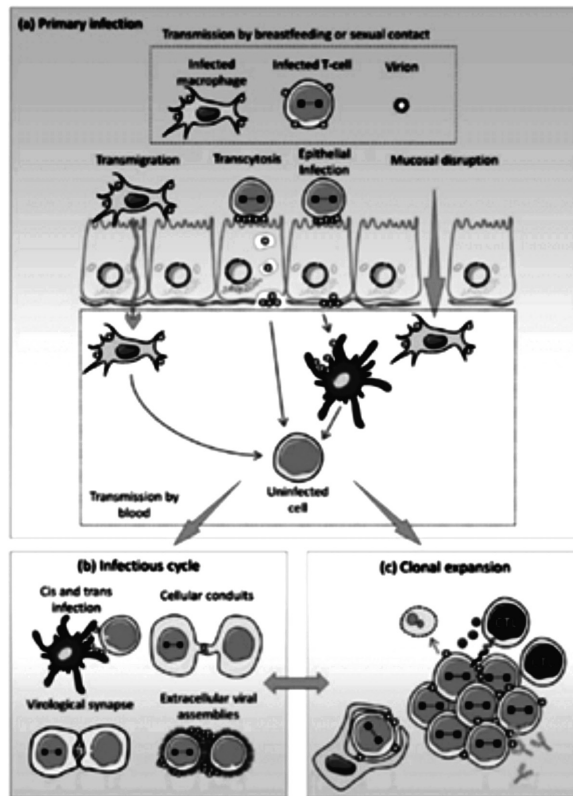

In earlier times, very little was known about how HIV is transmitted, which made people scared of those infected due to fear of contagion.

This fear, coupled with many other reasons, means that lots of people falsely believe:

- HIV and AIDS are always associated with death
- HIV is associated with behaviours that some people disapprove of (like homosexuality, drug use, sex work or infidelity)
- HIV is only transmitted through sex, which is a taboo subject in some cultures
- HIV infection is the result of personal irresponsibility or moral fault (such as infidelity) that deserves to be punished
- inaccurate information about how HIV is transmitted, creating irrational behaviour and misperceptions of personal risk.

HIV-related stigma and discrimination exist worldwide, although they manifest themselves differently across countries, communities, religious groups and individuals.

Research by the International Centre for Research on Women (ICRW) found the possible consequences of HIV-related stigma to be:

- loss of income and livelihood
- loss of marriage and childbearing options
- poor care within the health sector
- withdrawal of caregiving in the home
- loss of hope and feelings of worthlessness
- loss of reputation.

Stigma also varies depending on the dominant transmission routes in a country or region. In sub-Saharan Africa, for example, heterosexual sex is the main route of infection, which means that HIV-related stigma in this region is mainly focused on infidelity and sex work. These people are increasingly marginalised, not only from society, but from the services they need to protect themselves from HIV. Half of all new HIV infections worldwide are among people belonging to key affected populations.

5.13 ASSESSMENT METHODS

Use observation technique, question answer technique, and demonstration technique to assess the learners' achievement of learning objectives.

5.14 ASSESSMENTS

Formative Assessment

Fill in the blanks:

1. Synapsis includes the formation of an elaborate structure called the,
2. In chromosomes are pulled apart.

Ans. 1. synaptonemal complex, 2 Anaphase

Summative Assessment

Answer in one word:

1. Spread of cancer cells.
2. Female gamete is produced by

Ans. 1. metastasis, 2. oogenesis

Unit 6: Protein Synthesis

6.1 LEARNING OBJECTIVES

| Knowledge and Understanding | Skills | Attitudes and Values |
|--|--|---|
| <ul style="list-style-type: none"> • State the features of a genetic code. • State that a gene is a sequence of nucleotides that form part of a DNA molecule that codes for a specific polypeptide. • Describe how the information in DNA is used during transcription and translation to construct polypeptides. • State the roles played by mRNA, tRNA and the ribosomes in the formation of the polypeptide. • State that ribosomes provide surface area for the attachment of mRNA during polypeptide synthesis. • State that polysomes consists of up to 50 ribosomes on the same mRNA strand and that they speed up polypeptide synthesis. • Describe the way in which the nucleotide | <ul style="list-style-type: none"> • Construct a flow chart, in proper sequence, for the stages of transcription and translation. • Using the evidence, predict the effect of change in genetic code on the structure of the protein manufactured during protein synthesis. • Carry out research to find and understand better about protein synthesis and on genetic diseases. | <ul style="list-style-type: none"> • Appreciate the importance of the genetic code in determining the structure of a protein. • Agree that the way DNA code for polypeptides is central to our understanding of how cells and organisms function. • Be aware that DNA is an extremely stable molecule that cells replicate with extreme accuracy to minimise possibilities of DNA mutations. • Appreciate the role of the genetic code in determining the characteristics of an individual. |

| | | |
|--|--|--|
| <p>sequence codes for the amino acid sequence with specific reference to Hb^A (normal) and Hb^S (sickle cell) alleles for β-globin polypeptides.</p> <ul style="list-style-type: none"> • State that gene mutation is a change in the sequence of nucleotides that may result in an altered polypeptide. | | |
|--|--|--|

6.2 TEACHING AIDS

Visual: Images of protein synthesis.

Audio-video: Video showing process of translation.

6.3 TEACHER'S TIP

Teacher starts the unit by briefing the learners about genetic code and triplet codons. Teacher appreciates the importance of genetic code in determining the structure of a protein. Transcription and translation as key processes in formation of m RNA. The importance of DNA and RNA in protein synthesis and how a single change in genetic code results in diseases like Sickle cell anaemia and albinism.

6.4 TEACHING METHODS

Brainstorming, short lecture technique, group discussion technique, observation technique, drawing technique, demonstration technique, and practical work.

6.5 TEACHING AND LEARNING MATERIALS

Models, illustrations, computer animations and charts of DNA and RNA strands and amino acids.

6.6 TEACHING METHODOLOGY

Teacher initiates the topic by introducing genetic code. Ask the learners to research on the same.

Teacher also discusses the transcription process. Start by asking the learners to explain the process using aids.

Learners reply to the questions raised by the teacher.

Appreciating them, teacher further asks if they are aware of translation.

Learners will come up with varied answers. Some correct, some near to correct, others being irrelevant.

Teacher will not demotivate the child. But agreeing to the correct answers, dwell further in discussion.

Using short lecture technique, teacher will explain the importance of transcription and translation.

Teacher further explains to the learners the different effects of alteration of nucleotides.

6.7 ADDITIONAL CONTENT FOR THE TEACHER

The teacher can demonstrate these activities

Activity 1

Aim: To make the learners understand genetic code.

Ask each learner to read aloud triple codons and practise what effects it takes to decipher results.

Ask them to research and brainstorm on the possibilities of interactions and their effects.

Activity 2

Aim: To research and present the findings in journal form on how genetic drugs can be used to stop the expression of genetic diseases with specific reference to how they may interfere with activities of nucleic acids in the nucleus and the cytoplasm of the cell.

Instruction

As an example, the mechanism of action of chemotherapeutic drugs and types of the drugs that interfere with activities of nucleic acids (DNA/RNA) in the nucleus and the cytoplasm of the cell are given below. **In the same way, you can ask the students to do their research using internet or library and present their findings in journal form.**

Genetic drugs generally interfere with activities of nucleic acids (DNA/RNA) in the nucleus and the cytoplasm of the cell. Most of the anti-cancer drugs work at the level of nucleus and cytoplasm by interfering the process of DNA replication, transcription

and translation. Therefore, the best example could be chemotherapeutic drugs because all of them work at the level of nucleus and cytoplasm of the cell.

Mechanism of Action of Chemotherapeutic Drugs

Cancer is the uncontrolled growth of cells coupled with malignant behaviour: invasion and metastasis (among other features). It is caused by the interaction between genetic susceptibility and environmental factors. These factors lead to accumulations of genetic mutations in oncogenes (genes that control the growth rate of cells) and tumour suppressor genes (genes that help to prevent cancer), which give cancer cells their malignant characteristics, such as uncontrolled growth.

Most chemotherapeutic drugs work by impairing mitosis (cell division), effectively targeting fast-dividing cells. As these drugs cause damage to cells, they are termed cytotoxic. They prevent mitosis by various mechanisms **including damaging DNA and inhibition of the cellular machinery involved in cell division**. One theory as to why these drugs kill cancer cells is that they induce a programmed form of cell death known as apoptosis.

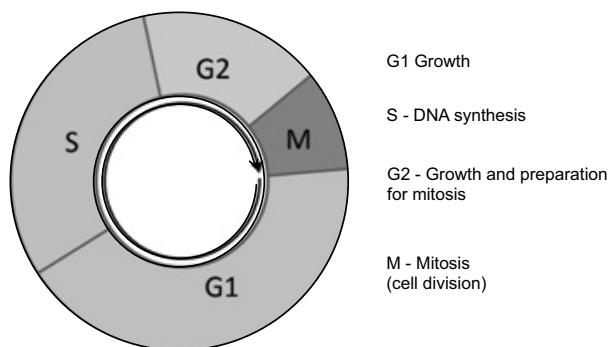

Types of Chemotherapeutics Drugs

Alkylating Agents

Alkylating agents are the oldest group of chemotherapeutics in use today. Originally derived from mustard gas used in World War I, there are now many types of alkylating agents in use. They are so named because of their ability to alkylate many molecules, including proteins, RNA and DNA. This ability to bind covalently to DNA via their alkyl group is the primary cause for their anti-cancer effects.

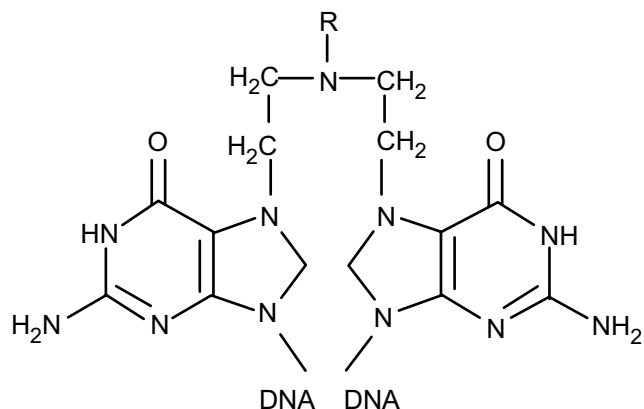

N7 interstrand crosslinked DNA

Two DNA bases that are cross-linked by a nitrogen mustard. Different nitrogen mustards will have different chemical groups (R). The nitrogen mustards most commonly alkylate the N7 nitrogen of guanine (as shown here) but other atoms can be alkylated.

DNA is made of two strands and the molecules may either bind twice to one strand of DNA (intrastrand crosslink) or may bind once to both strands (interstrand crosslink). If the cell tries to replicate crosslinked DNA during cell division, or tries to repair it, the DNA strands can break. This leads to a form of programmed cell death called apoptosis. Alkylating agents will work at any point in the cell cycle and thus are known as cell cycle-independent drugs. For this reason, the effect on the cell is dose dependent; the fraction of cells that dies is directly proportional to the dose of drug.

Examples: The subtypes of alkylating agents are the nitrogen mustards, nitrosoureas, tetrazines, aziridines, cisplatin and derivatives, and non-classical alkylating agents.

Anti-Metabolites

Anti-metabolites are a group of molecules that impede DNA and RNA synthesis. Many of them have a similar structure to the building blocks of DNA and RNA. The building blocks are nucleotides; a molecule comprising a nucleobase, a sugar and a phosphate group. The nucleobases are divided into purines (guanine and adenine) and pyrimidines (cytosine, thymine and uracil).

Anti-metabolites resemble either nucleobases or nucleosides (a nucleotide without the phosphate group), but have altered chemical groups. These drugs exert their effect by either blocking the enzymes required for DNA synthesis or becoming incorporated

into DNA or RNA. By inhibiting the enzymes involved in DNA synthesis, they prevent mitosis because the DNA cannot duplicate itself.

Also, **after misincorporation of the molecules into DNA, DNA damage can occur and programmed cell death (apoptosis) is induced.**

Unlike alkylating agents, anti-metabolites are cell cycle dependent. This means that they only work during a specific part of the cell cycle, in this case S-phase (the DNA synthesis phase). For this reason, at a certain dose, the effect plateaus and proportionally no more cell death occurs with increased doses.

Example: Subtypes of the anti-metabolites are the anti-folates, fluoropyrimidines, deoxynucleoside analogues and thiopurines.

Anti-Microtubule

Anti-microtubule agents are plant-derived chemicals that block cell division by preventing microtubule function. Microtubules are an important cellular structure composed of two proteins; α -tubulin and β -tubulin. They are hollow rod shaped structures that are required for cell division, among other cellular functions. Microtubules are dynamic structures, which means that they are permanently in a state of assembly and disassembly.

Vinca alkaloids and taxanes are the two main groups of anti-microtubule agents, and although both of these groups of drugs cause microtubule dysfunction, their mechanisms of action are completely opposite.

The vinca alkaloids prevent the formation of the microtubules, whereas the taxanes prevent the microtubule disassembly. By doing so, they prevent the cancer cells from completing mitosis. Following this, cell cycle arrest occurs, which induces programmed cell death (apoptosis). Also, these drugs can affect blood vessel growth; an essential process that tumours utilise in order to grow and metastasise.

Vinca alkaloids are derived from the Madagascar periwinkle, *Catharanthus roseus* (formerly known as *Vinca rosea*). They bind to specific sites on tubulin, inhibiting the assembly of tubulin into microtubules. The original vinca alkaloids are completely natural chemicals that include **vincristine and vinblastine**. Following the success of these drugs, semi-synthetic vinca alkaloids were produced: vinorelbine, vindesine, and vinflunine. These drugs are cell **cycle-specific**. They bind to the tubulin molecules in S-phase and prevent proper microtubule formation required for M-phase.

Taxanes are natural and semi-synthetic drugs. The first drug of their class, paclitaxel, was originally extracted from the Pacific Yew tree, *Taxus brevifolia*. Now this drug and another in this class, docetaxel, are produced semi-synthetically from a chemical found

in the bark of another Yew tree; *Taxus baccata*. These drugs promote microtubule stability, preventing their disassembly. Paclitaxel prevents the cell cycle at the boundary of G2-M, whereas docetaxel exerts its effect during S-phase. Taxanes present difficulties in formulation as medicines because they are poorly soluble in water.

Topoisomerase I and II Inhibitors

Topoisomerase inhibitors are drugs that affect the activity of two enzymes: topoisomerase I and topoisomerase II. When the DNA double-strand helix is unwound, during DNA replication or transcription, for example, the adjacent unopened DNA winds tighter (supercoils), like opening the middle of a twisted rope. The stress caused by this effect is in part aided by the topoisomerase enzymes. They produce single- or double-strand breaks into DNA, reducing the tension in the DNA strand. This allows the normal unwinding of DNA to occur during replication or transcription. Inhibition of topoisomerase I or II interferes with both of these processes.

Two topoisomerase I inhibitors, irinotecan and topotecan, are semi-synthetically derived from camptothecin, which is obtained from the Chinese ornamental tree *Camptotheca acuminata*.

Drugs that target topoisomerase II can be divided into two groups. The topoisomerase II poisons cause increased levels of enzymes bound to DNA. This prevents DNA replication and transcription, causes DNA strand breaks, and leads to programmed cell death (apoptosis). These agents include etoposide, doxorubicin, mitoxantrone and teniposide. The second group, catalytic inhibitors, are drugs that block the activity of topoisomerase II, and therefore prevent DNA synthesis and translation because the DNA cannot unwind properly. This group includes novobiocin, merbarone, and aclarubicin, which also have other significant mechanisms of action.

Cytotoxic Antibiotics

The cytotoxic antibiotics are a varied group of drugs that have various mechanisms of action. The group includes the anthracyclines and other drugs including actinomycin, bleomycin, plicamycin, and mitomycin.

Doxorubicin and daunorubicin were the first two anthracyclines, and were obtained from the bacterium *Streptomyces peucetius*. Derivatives of these compounds include epirubicin and idarubicin. Other clinically used drugs in the anthracycline group are pirarubicin, aclarubicin, and mitoxantrone.

The mechanisms of anthracyclines include DNA intercalation (molecules insert between the two strands of DNA), generation of highly reactive free radicals that damage intercellular molecules and topoisomerase inhibition.

Actinomycin is a complex molecule that intercalates DNA and prevents RNA synthesis.

Bleomycin, a glycopeptide isolated from *Streptomyces verticillus*, also intercalates DNA, but produces free radicals that damage DNA. This occurs when bleomycin binds to a metal ion, becomes chemically reduced and reacts with oxygen. Mitomycin is a cytotoxic antibiotic with the ability to alkylate DNA.

Activity 3

Aim: To carry out an investigation or simulation on the effect of change in genetic code on the structure of the protein manufactured during protein synthesis.

Hint:

Any change in the nucleotide sequence of DNA will result in a change of genetic code on m-RNA. As a result of the change in genetic code (codons), different proteins (amino acids) with different functions will be translated. The best example is Sickle-cell anaemia.

Procedure:

1. Study any genetic disease that results from change in nucleotide sequence of DNA.
2. You can study sickle-cell anaemia or albinism which is given in the text (Unit 6).
3. Find out the cause and effects, symptoms about the disease.
4. Note down your findings.

Feedback Time: Give comments on the learner's findings.

Instruction

Cause

The mutation causing sickle cell anaemia is a single nucleotide substitution (A to T) in the DNA of hemoglobin coding gene. The change in a single

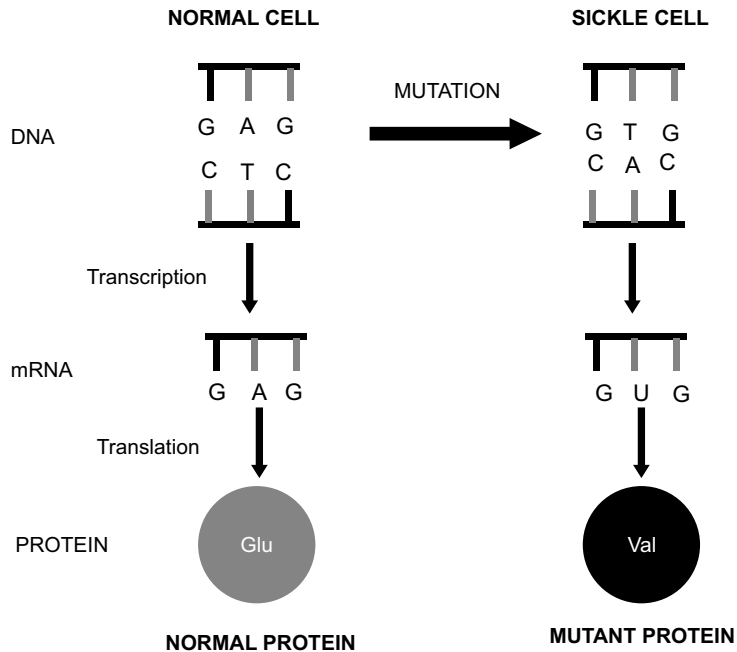

A single nucleotide substitution in hemoglobin gene resulting into replacement of glutamic acid by valine amino acid.

nucleotide is transcribed as a codon for valine amino acid (GUG) on the m-RNA instead of glutamic acid (GAG). Eventually, due to change in the codon, valine amino acid is translated instead of glutamic acid at the 6th position from N-terminus of the hemoglobin polypeptide chain. This defect form of hemoglobin in persons with sickle cell anaemia is referred to as HbS.



A diagram showing replacement of glutamine (Glu) by valine (Val) at 6th position from N-terminus in the sickled hemoglobin polypeptide.

Glutamic acid (Glu) is a hydrophilic amino acid, water loving, with a negative electric charge, while Valine (Val) is a hydrophobic amino acid, water hating, with neutral electrical charge. The amino acid valine makes the haemoglobin molecules stick together, forming long fibres which convert the normal disc-shaped of red blood cells into sickle-shaped red blood cells.

Symptoms

The sickled red blood cells are fragile and broken easily, resulting in the anaemia. Normal red blood cells normally squeeze and pass through blood capillaries smoothly. However, sickled cells are not flexible, and therefore, have the tendency to get clogged in capillaries. As a result, blood circulation is impaired and tissues become deprived of oxygen. Oxygen deprivation occurs at the extremities, the heart, lungs, brain, kidneys, gastrointestinal tract, muscles, and joints.

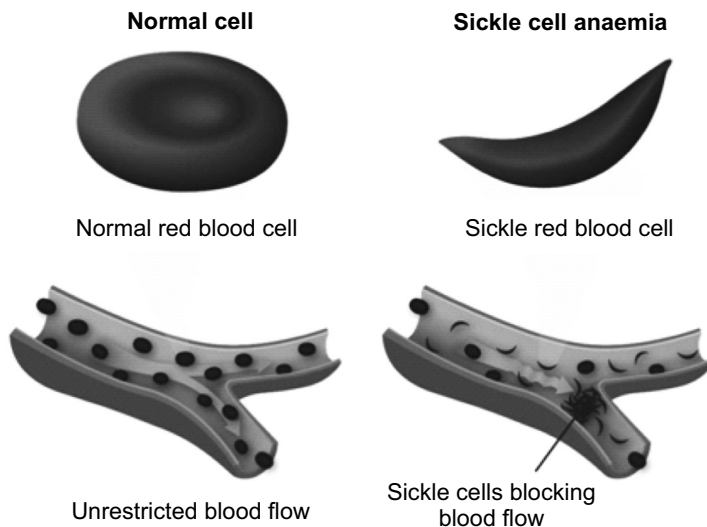

Difference between normal and sickle red blood cells.

6.8 SUMMARY

- Genetic Code is the set of rules by which information is encoded in genetic material (DNA or RNA sequences) is translated into proteins (amino acid sequences) by living cells.
- A codon is made up of three nucleotides or triplets. Out of 64 codons, 61 codons are sense codons and 3 codons are non-sense codons.
- Genetic code is almost universal; it shows degeneracy.
- It is through genetic code that the genetic information found in m-RNA is translated to mature functional proteins.
- DNA molecule is a stable structure and replicates accurately in order to avoid any mutation or change in nucleotide sequences in DNA.
- Transcription is the process of copying information from one strand of DNA into a single stranded RNA (mRNA).
- A transcription unit in DNA is composed of a promoter, RNA coding sequence, and a terminator.

- The process of transcription in bacteria includes:
 - ◆ Initiation: a process of initiating transcription where a complex of RNA polymerase with sigma factor binds at the promoter.
 - ◆ Elongation: the process in which RNA polymerase synthesizes a complementary RNA sequence of the DNA template strand.
 - ◆ Termination: the process of ending transcription; and it can be carried out either in rho dependent manner or rho independent manner.
- The process of transcription in eukaryotes involves:
 - ◆ Initiation involves a complex of RNA polymerase II and general transcription factors.
 - ◆ Elongation is similar to that of bacteria. But eukaryotic genes do not have terminator sequences.
 - ◆ The newly formed pre-m-RNA has to undergo RNA processing.
 - ◆ Translation is the production of protein molecules (polypeptides) by cellular ribosomes with the help of information present on the m-RNA.
 - ◆ The covalent linking of a specific amino acid to the 3' end of the correct t-RNA by the enzyme aminoacyl-t-RNA synthetase is called charging of t-RNA.
- Translation bacteria includes:
 - ◆ Initiation is a stage where m-RNA is bound to the ribosome and positioned itself for proper translation. It involves three steps.
 - ◆ Elongation is a stage where amino acids are sequentially joined together to form a polypeptide chain via peptide bonds.
 - ◆ Termination is the process where the newly formed polypeptide chain and the m-RNA are released from the ribosome.
 - ◆ Polyribosomes are complex of an m-RNA molecule and multiple ribosomes that are simultaneously translating it. It enables a large number of polypeptides to be produced faster and efficiently.
- Translation in eukaryotes includes:
 - ◆ Initiation differs from that of bacteria by: the first amino acid is methionine; it has 80S initiation complex; it locates start codon by scanning model for initiation.
 - ◆ Elongation is characterized by involvement of nine eukaryotic elongation factors.
 - ◆ Termination codes are recognized only by e-RF1.
 - ◆ Change in genetic code is known as mutation.

- ◆ Mutation is of two types: A base-pair substitution and base-pair insertions or deletions.
- ◆ Some mutations do not have much effect such as silent mutation. However, some mutations can have a huge effect on genetic code such as frameshift mutation.
- ◆ Any change in the nucleotide sequence of a gene can result into producing wrong or different polypeptide chain. The outcomes can be detrimental to the affected organisms.
- ◆ Example: Sickle cell anaemia; albinism.

6.9 WEBLINKS FOR CONTENT ENRICHMENT

- <http://users.rcn.com/jkimball.ma.ultranet/BiologyPages/C/Codons.html>
- <http://hyperphysics.phy-astr.gsu.edu/hbase/organic/gencode.html>
- https://www.sciencedaily.com/terms/genetic_code.htm

6.10 LEARNER'S ACTIVITIES

Activity 1

The teacher should assist the learners to perform the following activity.

Hint:

There are only four nucleotides A, U, G, and C in mature m-RNA that code for 20 amino acids. So how do only 4 nucleotides in mature m-RNA code for 20 amino acids? The answer lies in genetic code, which is important in determining the structure of proteins. With four different nucleotides, three code possibilities are given below:

- If it were one-letter code (one nucleotide specifying one amino acid), only four (4) amino acids could be encoded. This is not possible because there are 20 amino acids.
- Again if it were a two-letter code, only 16 ($4 \times 4 = 16$) amino acids could be encoded. This is also not possible because there are 20 amino acids.
- But with a three-letter code, genetic code can generate 64 ($4 \times 4 \times 4 = 64$) possible codes (codons), which is more than enough to code for the 20 amino acids found in living cells. This is possible, thus the genetic code is a triplet code, meaning a set of three nucleotides (a codon) in m-RNA code for one amino acid in a polypeptide chain.

The answer to the second question has two things:

- (a) DNA replicates accurately to minimise any mutation
- (b) DNA is extremely stable.

DNA Replicates Accurately to Minimise any Mutation

DNA molecule is a stable structure and replicates accurately in order to avoid any mutation or change in nucleotides sequences in DNA. In case of any damage in the nucleotide sequence, DNA employs different mechanisms to ensure the accuracy of DNA replication. Here are some of the important mechanisms to ensure accurate DNA replication.

- (A) Complementary Base Pairing:** The nitrogen bases of DNA follow the Chargaff's rule of base pairing. In simple words, this rule says that Adenine (A) base pairs with Thymine (T); Guanine (G) base pairs with Cytosine (C). This base pairing is very strict and accurate. Thus, the complementary base pairing directs the DNA to replicate very accurately and prevents any mistake to occur.
- (B) Semi-conservative Nature of DNA:** In DNA replication, two of the original strands of DNA act as templates for new DNA to be synthesized. So when the new strands of DNA are synthesized, they are just the complementary bases of the two original template strands of DNA. In this way, original sequence of DNA is semi-conserved with the two original strands of DNA. Thus, the semi-conservative nature of DNA makes the DNA replication highly accurate.
- (C) Proofreading:** DNA Pol I and DNA Pol II polymerase enzymes have 3'-to-5' exonuclease activity, which means that they can remove incorrectly inserted nucleotides from the 3' end to 5' end of the DNA chain. Thus, they play important role in proofreading mechanism. The insertion of incorrect nucleotides by both DNA Poly I and DNA Poly III occurs at a frequency of one base in a million (10^{-6}). With this proofreading mechanism, the chances of error occurrence in DNA replication is reduced to one base in a billion (10^{-9}) instead of one base in a million (10^{-6}).
- (D) Mismatch Repair:** After DNA Replication if there are any mismatched base pairs on the newly synthesized strand, it can be corrected by methyl-directed mismatch repair.

DNA molecule is a stable structure and replicates accurately in order to avoid any mutation or change in nucleotides sequences in DNA. In case of any damage in the nucleotide sequence, DNA employs different mechanisms to ensure the accuracy of DNA replication. Here are some of the important mechanisms to ensure accurate DNA replication.

DNA is Extremely Stable

DNA is the repository of genetic information gathered over millions of years and it is stored in a stable form inside the cell. The stability of DNA is a property critical to the maintenance of the integrity of the gene. The stability of DNA can be explained and evidently supported by the fact that DNA has been extracted from Egyptian mummies and extinct animals such as the woolly mammoth. And it can also be extracted from dried blood sample or from a single hair at a crime scene which is old enough. The stability of DNA can be attributed to important factors: Hydrogen Bonds and Base Stacking.

Hydrogen Bonds

Hydrogen bond is the attractive force between the hydrogen attached to an electronegative atom (O) of one molecule and an electronegative atom (N) of a different molecule. In the structure of DNA, the strong electronegative atom is the oxygen (O) and Nitrogen (N), while H atom has positive charge. In the structure of DNA, thymine and adenine have two hydrogen bonds; while guanine and cytosine have three hydrogen bonds. Hydrogen bonds play very important role in binding the bases of the opposite strands in the DNA. Hydrogen bonds are very weak by themselves. But in a DNA sequence, there will be thousands of these H-bonds which make DNA very stable.

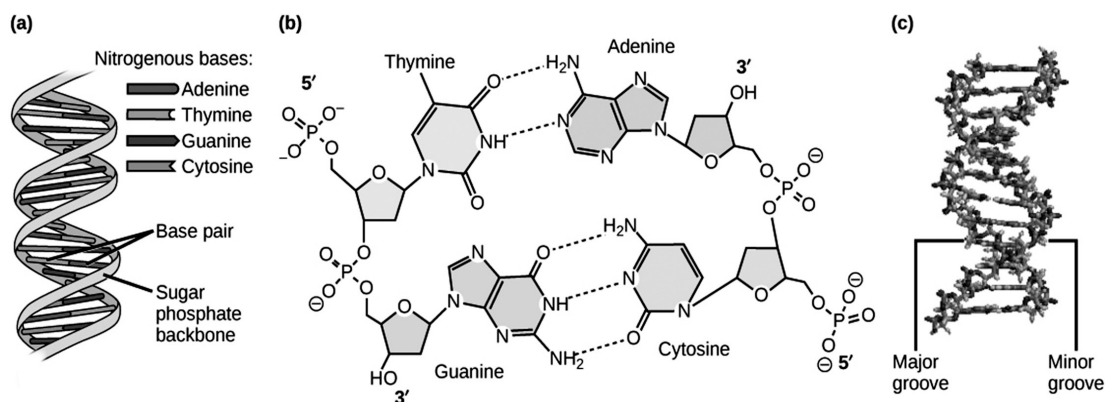

Structure of DNA [See the hydrogen bonds between the four bases (T-A, G-C)]

Base Stacking

In DNA, the stacked base pairs also attract to one another through Van der Waals forces. The energy associated with a single van der Waals interaction has small significant to the overall DNA structure. But the large amounts of these interactions help to stabilize the overall structure of the helix.

Activity 2

The teacher should divide the class into groups.

Sources required: Textbooks, video clips, animation, Internet etc.

Hint:

Some of the main differences are:

| DNA Replication | Transcription |
|--|--|
| It takes place to conserve the entire genome for next generation | RNA copies of individual genes are made for a particular purpose. For example: m-RNA is used as a message for protein synthesis. |
| Primer is required | Primer is not required |
| One strand of DNA becomes two daughter strands | RNA molecule is formed |
| Replication occurs along the two strands of DNA | It takes place only on one strand of DNA |
| It involves unwinding and splitting of the entire DNA molecule which is winded up again. | It involves unwinding and splitting of only those genes which are to be transcribed. |
| It uses DNA polymerase | It uses RNA polymerase enzymes |

Flow Chart of the Process of Transcription in Bacteria

Initiation: RNA polymerase accompanied by sigma (σ) factor binds at the promoter. Sigma factor ensures that RNA polymerase binds accurately and stably on the promoter. Then RNA polymerase unwinds DNA in the promoter region to form open promoter complex.

Elongation: Once the initiation has commenced, RNA polymerase starts elongating or adding NTPs one after the other using one of the strands of DNA as a template strand. The non-template strand is not used for elongation of RNA. Elongation of the new RNA takes place in 5' to 3' direction and follows complementary base pairing rule.

Termination: Termination of transcription is signalled by **terminator sequence** located downstream from the promoter. It can take place in two ways:

- (i) **Rho (ρ) dependent terminators:** Rho protein binds at the terminator sequence and RNA polymerase, and brings the termination of transcription.
- (ii) **Rho (ρ) independent terminators:** Rho independent terminators consist of an inverted repeat sequence that is about 16 to 20 base pairs upstream of the termination point. The inverted repeat sequence forms a **hairpin loop structure** that causes transcription to terminate.

Flow Chart of the Process of Transcription in Eukaryotes

Initiation: During initiation, the general **transcription factors** (GTFs) and RNA polymerase II bind on the promoter elements and form the preinitiation complex (PIC). In addition to GTFs and RNA polymerase II, the binding of activators to promoter elements and to enhancer elements determines the overall efficiency of transcription initiation at a particular promoter.

Elongation: RNA polymerase II, along with some of the GTFs, starts elongating the new RNA strand by adding appropriate nucleotides.

Termination: And unlike bacterial genes, eukaryotic genes do not have specific terminator sequences. The newly transcribed pre-m-RNA has to undergo modification in order to become a functional m-RNA by a process called RNA processing.

Activity 3

The teacher should assist the learners to perform the activity.

Hint:

1. Read the process of translation carefully and know all the important steps.
2. After finishing your reading, put the steps of the process of translation in separate boxes in the flow chart.
3. Start the flow chart from the production of pre-m-RNA and end with the proteins (ultimate product).

Feedback Time: Check out the learners flow charts.

Flow Chart of the Process of Bacterial Translation

The process of translation basically consists of three major stages: (1) Initiation (2) Elongation (3) Termination.

Initiation: It is the stage where m-RNA is bound to the ribosome and positioned itself for proper translation. It can be further subdivided into three steps:

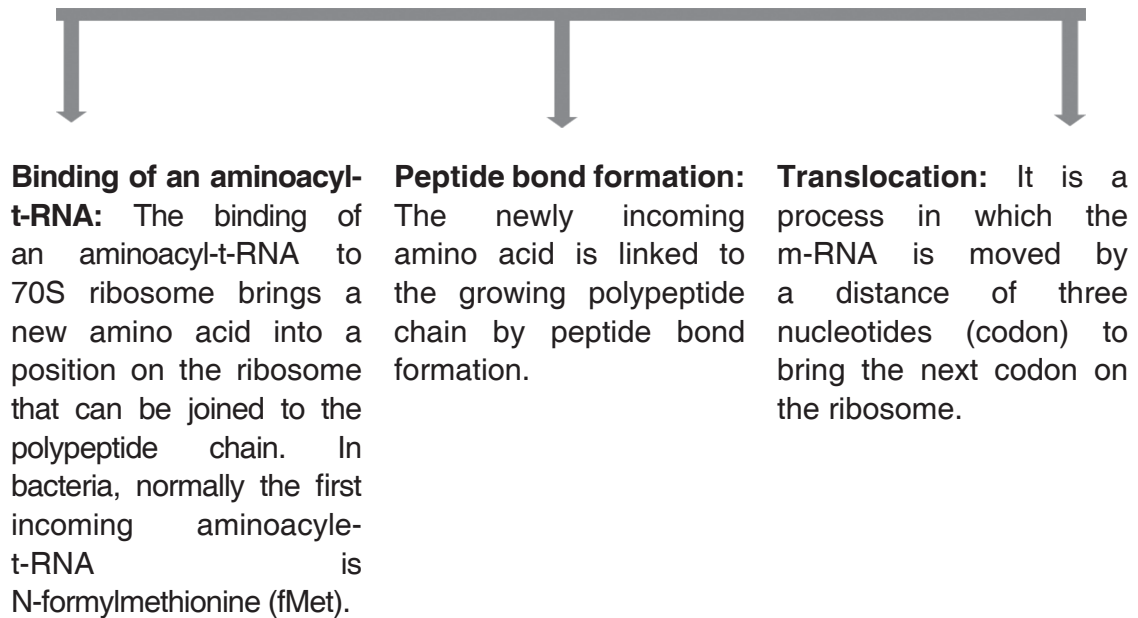
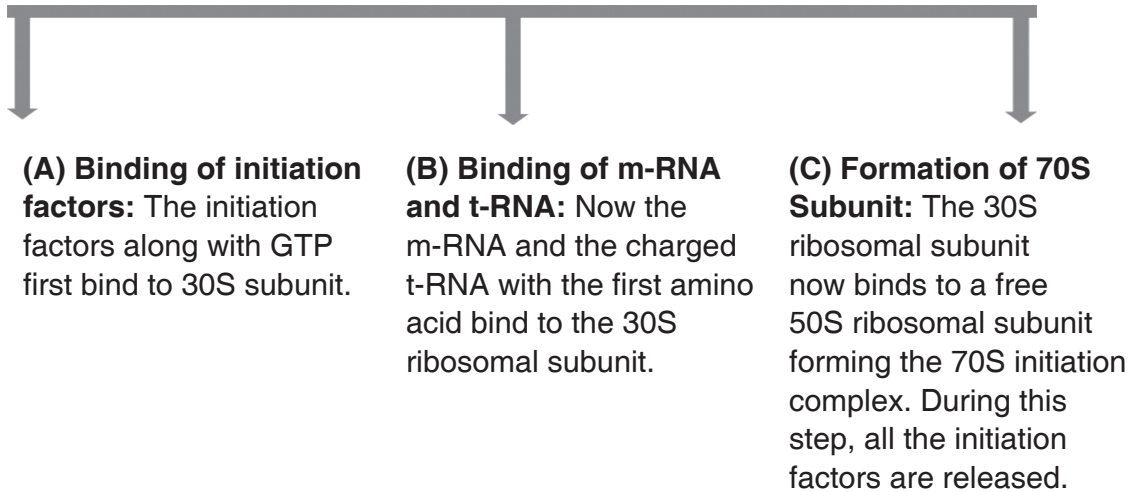

Elongation: It is the stage where amino acids are sequentially joined together to form a polypeptide chain via peptide bonds. The sequence of polypeptide chain is formed in an order specified by the arrangement of codons in m-RNA. Elongation can be subdivided into three steps:

Termination: At this stage, the newly formed polypeptide chain and the m-RNA are released from the ribosome. Termination happens when the ribosome comes across one of the stop codons (UAG, UAA, UGA) on the m-RNA. The stop codons are not recognized by any t-RNA; rather, they are recognized by release factors (RF). These release factors along with GTP bind on the stop codons and initiate the

termination process. RF1 recognizes UAA and UAG, while RF2 recognizes UAA and UGA.

Activity 4

The teacher should guide the learners to perform activity.

Hint:

1. The teacher should divide the class into groups of two to three learners each.
2. Using all the models of the components required during protein synthesis, construct a model of protein synthesis.

Note:

1. Learners should be very clear with the structure of the models you are using. Example: Structure of DNA, structure of t-RNA etc.
2. They should also be very clear about the steps of protein synthesis.

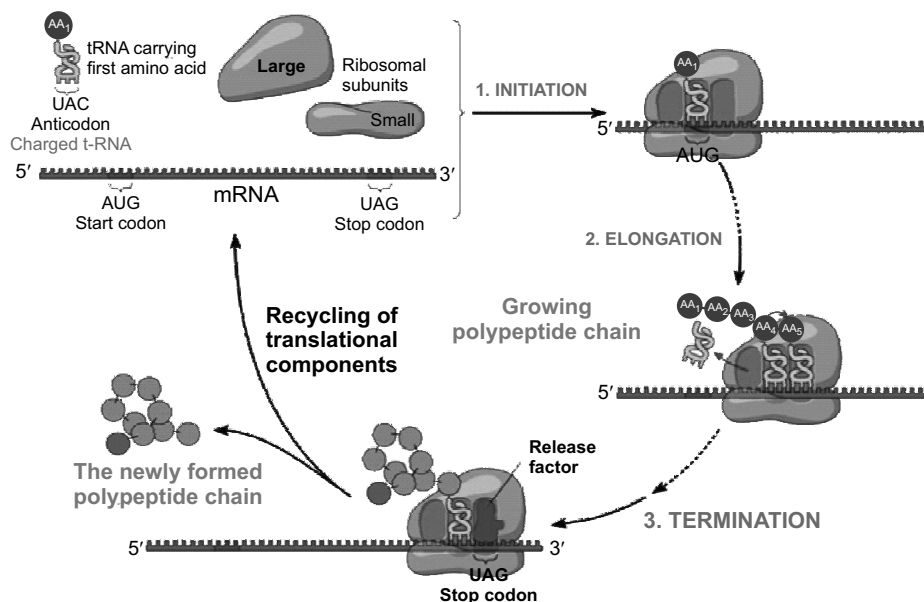

The process of Translation.

Feedback Time: Check out their work and give your comments—both positive points as well as the areas where they need to improve.

Instruction:

Instruct the learners to use chart papers or plastic models to construct the model of translation.

Activity 5

The teacher should divide the learners into groups of four learners each.

Hint:

Sickle-cell anaemia disease is caused by a single point mutation (called missense mutation) in the beta-hemoglobin gene that converts a **GAG codon (one of the single strands of DNA)** into GTG, which is transcribed into **GUG codon (m-RNA)**. This GUG codon ultimately is translated into the amino acid valine instead of glutamic acid.

1. For each base and phosphate bond, use different coloured paper.

Example:

A = Purple

C = Red

T = Blue

G = Green

U = Yellow

One phosphate bond= Green

The other phosphate bone = Blue

2. Cut the coloured papers according to the shapes given in this picture.

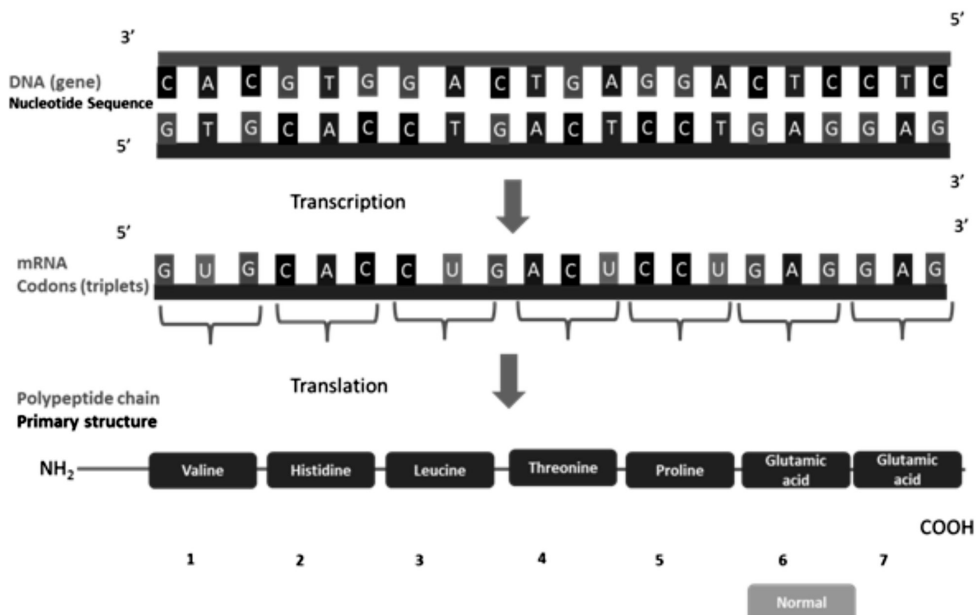

3. Now change the 6th codon in the DNA sequence from GAG into GTA. Now show that this GTA is transcribed into GUG instead of GAG as shown in the diagram below. Again show the translation of GAG codon into valine amino acid instead of glutamic acid.

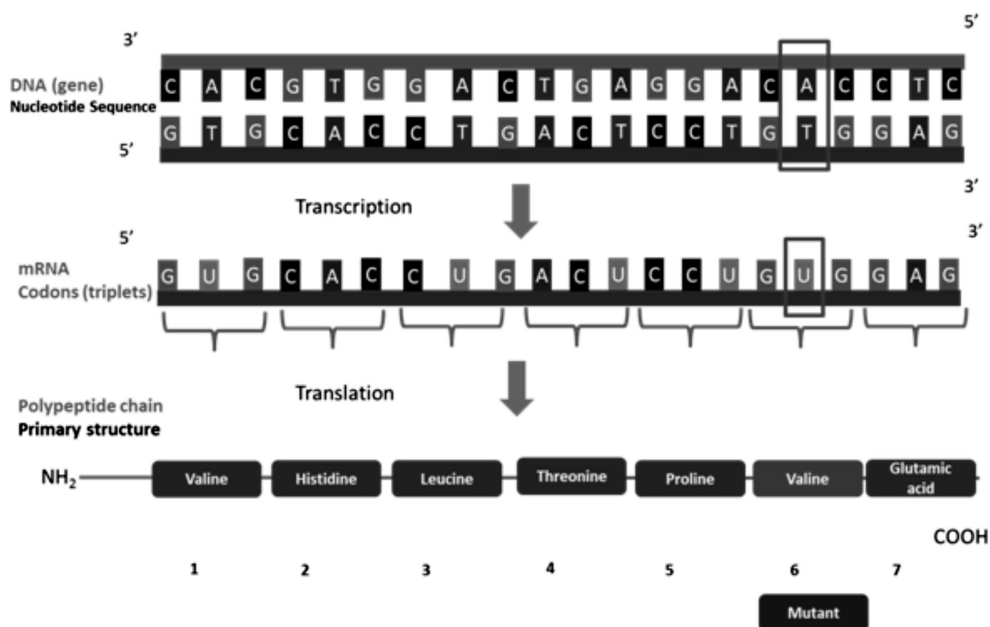

Discussion

As it is seen in the diagrams, mutation in DNA affects the transcription of m-RNA which in turn affects the protein synthesis. Here the mutation is a missense mutation, where there is a single point mutation (called missense mutation) in the beta-haemoglobin gene that converts a **GAG codon (one of the single strands of DNA)** into GTG, which is transcribed into **GUG codon (m-RNA)**. This GUG codon is ultimately translated into the amino acid valine instead of glutamic acid.

Glutamic acid (Glu) is a hydrophilic amino acid, water loving, with a negative electric charge, while Valine (Val) is a hydrophobic amino acid, water hating, with neutral electrical charge. The amino acid valine makes the haemoglobin molecules stick together, forming long fibres which convert the normal disc-shaped of red blood cells into sickle-shaped red blood cells.

Symptoms

The sickled red blood cells are fragile and broken easily, resulting in the anaemia. Normal red blood cells normally squeeze and pass through blood capillaries smoothly. However, sickled cells are not flexible, and therefore, have the tendency to get clogged

in capillaries. As a result, blood circulation is impaired and tissues become deprived of oxygen. Oxygen deprivation occurs at the extremities, the heart, lungs, brain, kidneys, gastrointestinal tract, muscles, and joints.

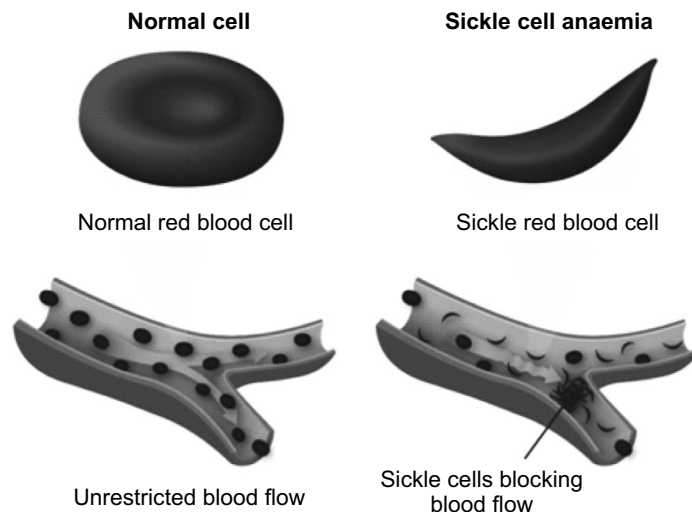

Difference between normal and sickle red blood cells.

Activity 6

The teacher should assist the learners to perform the activity.

Hint:

1. Ask the learners to read aloud different sets of genetic code.
2. Ask the learners to observe the change when there is insertion and deletion.
3. Ask the learners to correlate it with genetic code.

6.11 ANSWERS TO SELF-EVALUATION

Self-evaluation

- (i) gene
- (ii) Genetic code
- (iii) Methionine
- (iv) Hydrogen bond, base stacking

Self-evaluation

- (i) RNA
- (ii) collinear
- (iii) polycistronic
- (iv) Polyadenylation
- (v) Introns

Self-evaluation

- (i) Initiation, Elongation, Termination
- (ii) Aminoacyl-tRNA
- (iii) Polyribosome/Polysome
- (iv) 80

Self-evaluation

- (i) Valine
- (ii) Albinism
- (iii) Missense mutation, Nonsense mutation
- (iv) red blood cell

6.12 ANSWERS TO END UNIT ASSESSMENT 6

I. Choose whether the following statements are True (T) or False (F):

1. **False;** Genetic code is composed of A, C, G, and U (not T). It is because genetic code is made up of m-RNA. RNAs have U in place of T.
2. **True;** The primary role of transfer RNA (t-RNA) is to decode (translate, like an interpreter) the codons on m-RNA and use the message in codons to direct the process of synthesising polypeptide chain.
3. **True;** The primary role of messenger RNA is to carry the genetic information copied from DNA in the form of a series of codons (three- base code), each of which specifies a particular amino acid.
4. **False;** Ribosomes are made up both by proteins and RNAs.
5. **False;** TATA box is found -10 base pairs upstream from +1 start site.
6. **False;** RNA polymerases need initiation factors to initiate transcription. Example: RNA polymerase requires sigma (σ) factor to initiate transcription in prokaryotes.
7. **False;** Hairpin loop is formed in rho independent termination.
8. **True;** In eukaryotes, pre-m-RNA needs to undergo RNA processing to become functional m-RNA.
9. **True;** In prokaryotes, the first amino acid to bind at the P-site is N-formylmethionine. In contrast, in eukaryotes, the first amino acid to bind at the P-site is just methionine.

II. Multiple choice questions:

1. **(b)**; The mutation causing sickle cell anaemia is a single nucleotide substitution (A to T) in the DNA of hemoglobin coding gene. The change in a single nucleotide is transcribed as a codon for valine amino acid (GUG) on the m-RNA instead of glutamic acid (GAG).
2. **(d)**; Triplet code, almost universal, and non-overlapping all of them are the characteristic features of genetic code.
3. **(b)**; Stop codons are UAA, UAG, and UGA.
4. **(c)**; Wobble means fluctuate or unsteady.
5. **(a)**; It is only promoter which is located upstream of the bacterial start site, while the RNA- coding sequence and terminator are located downstream of the bacterial gene.
6. **(b)**; 5S molecule is synthesized by RNA polymerase III.
7. **(c)**; Sigma factor is involved in the initiation of transcription in prokaryotes.
8. **(d)**; The pre-m-RNA undergoes RNA processing; it has introns and exons as well as poly (A) tail.
9. **(c)**; Scanning model is related to initiation of transcription in eukaryotes where ribosome and other factors scan for the start codon.
10. **(c)**; In sickle cell anaemia, valine amino acid replaces glutamic acid at the 6th position from N-terminus of the haemoglobin polypeptide chain.

III. Long answer type questions:

1. The following are some characteristics of genetic code:
 - (i) The Genetic Code is a Triplet Codon: A codon consists of a group of three nucleotides. And each codon codes for a specific amino acid in a polypeptide chain with some exceptions.
 - (ii) The Genetic Code is Used without Comma: The three nucleotides in a codon are read in a continuous fashion without any comma. Examples: AUG, UAG, UGA and UAA.
 - (iii) The Genetic Code is Non-overlapping: The codons in the m-RNA sequence are read successively without overlapping.
 - (iv) The Genetic Code is Almost Universal: For many long years, it was thought that the genetic code is universal, which led us into believing that all living organisms have the same genetic code. However, recent studies have revealed that there are some organisms where there is difference in genetic

code. That is the reason why it is appropriate to use the phrase “almost universal” rather than the word “universal.”

- (v) The Genetic Code is “Degenerate”: A codon is thought to code for a particular amino acid. That is one codon for one amino acid. But more than one codon can code for a particular amino acid, with two exceptions of AUG and UGG. This multiple coding by a single codon is called the degeneracy or redundancy of the code. Example: UUU and UUC codons code for the same specific phenylalanine amino acid. In the same way, CAU and CAC codons code for the same specific histidine amino acid.
 - (vi) The Genetic Code has Start and Stop Codons: Out of 64 codons, only 61 codons are called sense codons. The other three codons are called nonsense codons or stop codons or chain-terminating codons. These three codons are UAG, UAA, and UGA; they do not specify any amino acid, and there are no t-RNAs to carry the appropriate anticodons. The AUG codon, which code for methionine, is most of the time the start codon or initiation codon for protein synthesis in both eukaryotes and prokaryotes.
 - (viii) Wobble Hypothesis: Francis Crick has pointed out that the complete set of 61 sense codons can be read by fewer number than 61 t-RNAs. The simple reason being, the pairing properties in the bases in the anticodons are wobble in nature. Here, the word “wobble” simply means “fluctuating” or “unsteady.” For example: The two different leucine codons (CUC, CUU) can be read by the same leucine t-RNA molecule, contrary to regular base-pairing rules.
2. Transcription is the process of copying information from one strand of DNA into a single-stranded RNA.

Transcription Unit in DNA

A transcription unit in DNA consists of three main regions in DNA.

- (i) **A promoter:** A promoter is a region of DNA that initiates transcription of a particular gene. There are two important sequences in the promoter that specifies the initiation of transcription. They are:
 - (a) – **35 Region or –35 Box:** It lies at –35 base pairs upstream of the +1 base pair where transcription starts. It has 5'-TTGACA-3' consensus sequence.
 - (b) – **10 Region or TATA Box:** It lies at –10 base pairs upstream from the +1 base pair where transcription starts. It has 5'-TATAAT-3' consensus sequence.

- (ii) **RNA Coding Sequence:** It is a DNA sequence that is transcribed by RNA polymerase into RNA transcript (m-RNA).
- (iii) **A terminator:** It is a DNA sequence which specifies termination of transcription.

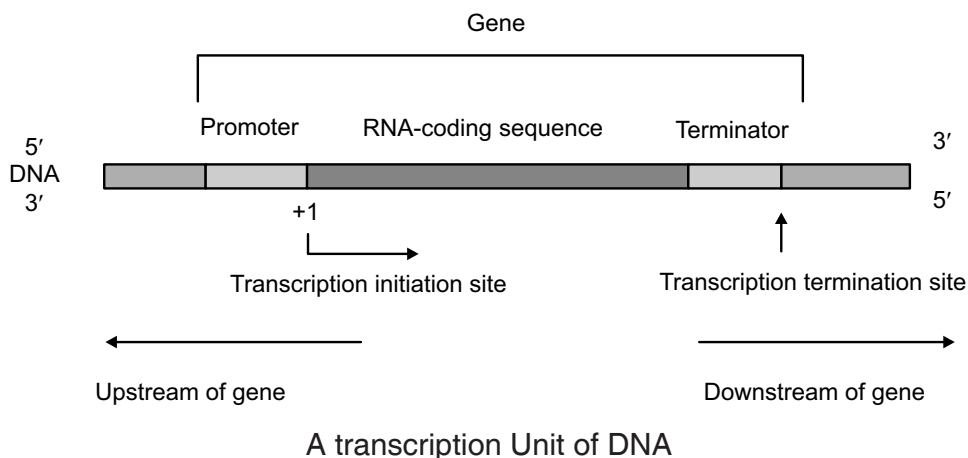

RNA Polymerase

In bacteria, RNA polymerase is the only enzyme that is responsible for catalysing the process of transcription. It is a **DNA-dependent RNA polymerase**, as it uses a DNA template strand to synthesize a new RNA chain. During transcription, it synthesizes RNA in 5' to 3' direction by using 3' to 5' strand of DNA as a template strand. The opposite 5' to 3' strand of DNA is not used during transcription and it is called as nontemplate strand.

RNA polymerase uses RNA precursors for synthesizing RNA chain. The RNA precursors are ribonucleoside triphosphates ATP, GTP, CTP, and UTP. They are collectively known as NTPs or Nucleoside triphosphate. The synthesis of RNA chain follows complementary base pairing rule i.e. A will pair with U; G will pair with C.

The Process of Transcription in Bacteria

The process of transcription is basically divided into three stages: (a) Initiation (b) Elongation (c) Termination.

- (a) **Initiation:** RNA polymerase accompanied by sigma (σ) factor binds at the promoter. Sigma factor ensures that RNA polymerase binds accurately and stably on the promoter. Then RNA polymerase unwinds DNA in the promoter region to form an open promoter complex.

- (b) **Elongation:** Once the initiation has commenced, RNA polymerase starts elongating or adding NTPs one after the other using one of the strands of DNA as a template strand. The non-template strand is not used for elongation of RNA. Elongation of the new RNA takes place in 5' to 3' direction and follows complementary base pairing rule. For example: If the DNA sequence in the DNA template is 3'-ATACTTGAACTAACTC-5', then the sequence of newly synthesized RNA will be 5'-UAUGAACUUGAUUGAG-3'.

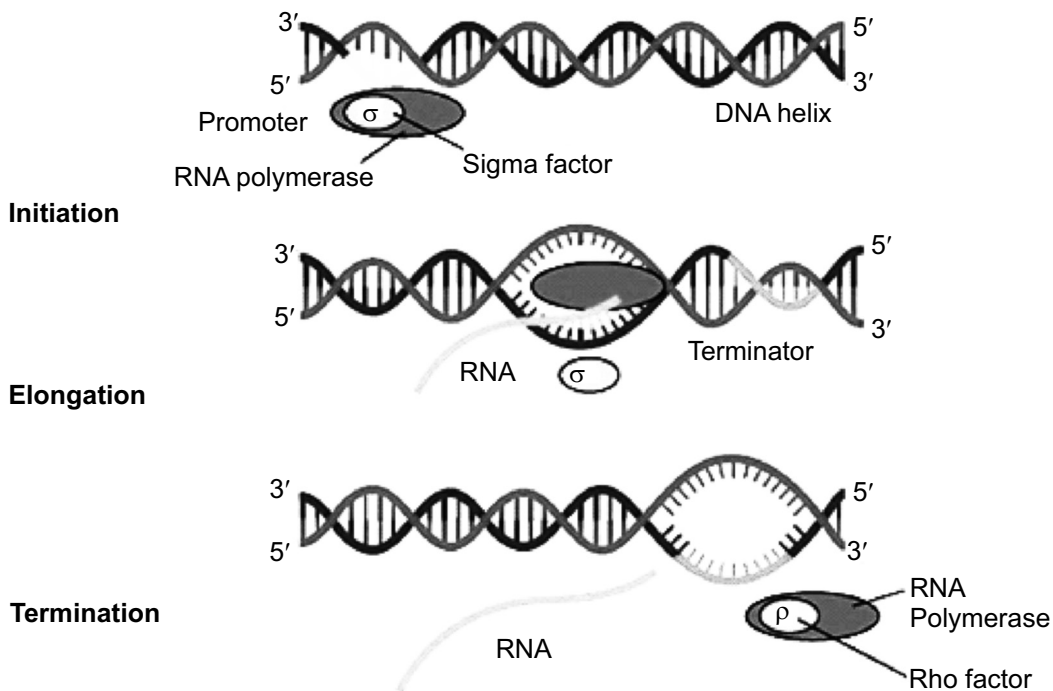

The process of transcription in bacteria.

- (c) **Termination:** Termination of transcription is signalled by terminator sequence located downstream from the promoter. It can take place in two ways:
- Rho (ρ) dependent terminators:** In this type, rho protein binds at the terminator sequence and RNA polymerase, and brings the termination of transcription.
 - Rho (ρ) independent terminators:** Rho independent terminators consist of an inverted repeat sequence that is about 16 to 20 base pairs upstream of the termination point. The inverted repeat sequence ρ forms a hairpin loop structure that causes transcription to terminate.

3.

| S. No. | Bacteria | Eukaryotes |
|--------|---|---|
| 1. | The pre-m-RNA transcript (newly made RNA) is directly functional as the m-RNA molecule. | <p>The pre-m-RNA transcript has to undergo modification before it becomes a fully functional m-RNA by a process called RNA processing.</p> <ul style="list-style-type: none"> • The pre-m-RNA has exons (expressed sequence) that are interrupted by introns (intervening sequence). These introns are removed by a mechanism called RNA splicing. • Additionally, at the 5' end of pre-m-RNA, a capping enzyme adds 7-methyl guanosine in a process called 5' capping. • Furthermore, at the 3' end of pre-m-RNA, about 50–250 adenine nucleotides [poly (A) tail] are added in a process called polyadenylation. |
| 2. | The base pairs of a bacterial gene (DNA) are collinear with the bases of the transcribed m-RNA | The base pairs of eukaryotic gene are not collinear with the bases of the transcribed m-RNA. |
| 3. | Since bacterial cell lacks nucleus, translation of m-RNA starts before the whole m-RNA has been completely transcribed. This process is called coupled transcription and translation. | The m-RNA is transcribed in the nucleus and transported to cytoplasm for translation. |
| 4. | Bacterial m-RNA is polycistronic. They contain amino acid coding information for more than one gene. | Eukaryotic m-RNA is monocistronic. |

4. Translation is the production of protein molecules (polypeptides) by cellular ribosomes with the help of information present on the m-RNA. The m-RNA and protein molecules are like two languages written with different types of letters. The language by which the information on m-RNA is written has to be translated into the language of amino acids in order to use it to direct the sequential assembly of amino acids into a polypeptide chain. That is the reason why protein synthesis is appropriately referred to as translation.

Charging of t-RNA

Prior to translation, each t-RNA molecule must be attached to the correct amino acid. Therefore, the covalent linking of a specific amino acid to the 3' end of the correct t-RNA by the enzyme aminoacyl-t-RNA synthetase is called as charging of t-RNA. An enzyme aminoacyl-t-RNA synthetase catalyzes the linking of amino acids to their corresponding t-RNAs via an ester bond, accompanied by the hydrolysis of ATP to AMP and pyrophosphate. This process is critical step in translation as it determines the accuracy of translation.

Charging of t-RNA occurs in two steps:

1. $\text{ATP} + \text{amino acid} \rightarrow \text{aminoacyl-AMP} + \text{PPi}$
2. $\text{Aminoacyl-AMP} + \text{t-RNA} \rightarrow \text{aminoacyl-t-RNA} + \text{AMP}$

The Process of Translation

The process of translation basically consists of three major stages: 1. Initiation 2. Elongation 3. Termination.

1. **Initiation:** It is the stage where m-RNA is bound to the ribosome and positioned itself for proper translation. It can be further subdivided into three steps:
 - (a) **Binding of initiation factors:** The initiation factors along with GTP first bind to 30S subunit.
 - (b) **Binding of m-RNA and t-RNA:** Now the m-RNA and the charged t-RNA with the first amino acid bind to the 30S ribosomal subunit.
 - (c) **Formation of 70s Subunit:** The 30S ribosomal subunit now binds to a free 50S ribosomal subunit forming the 70S initiation complex. During this step, all the initiation factors are released.
2. **Elongation:** It is the stage where amino acids are sequentially joined together to form a polypeptide chain via peptide bonds. The sequence of polypeptide chain is formed in an order specified by the arrangement of codons in m-RNA. Elongation can be subdivided into three steps:

- (a) **Binding of an aminoacyl-t-RNA:** The binding of an aminoacyl-t-RNA to 70S ribosome brings a new amino acid into a position on the ribosome that can be joined to the polypeptide chain. In bacteria, normally the first incoming aminoacyl-t-RNA is N-formylmethionine (fMet).
- (b) **Peptide bond formation:** The newly incoming amino acid is linked to the growing polypeptide chain by peptide bond formation.
- (c) **Translocation:** It is a process in which the m-RNA is moved by a distance of three nucleotides (codon) to bring the next codon on the ribosome.

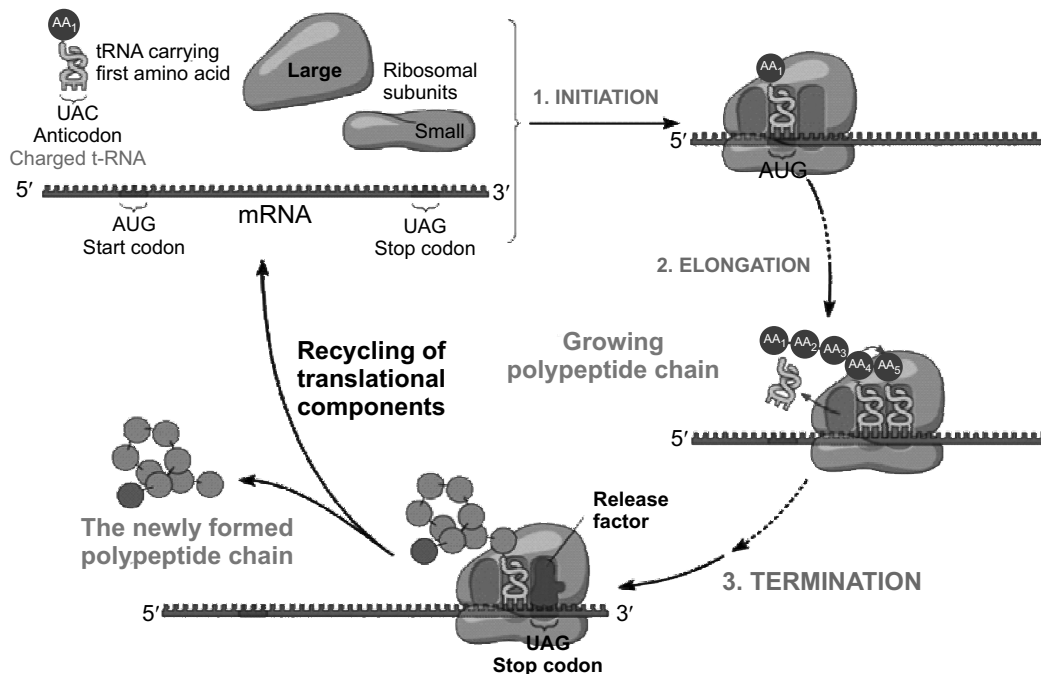

The process of Translation.

3. **Termination:** It is the process of ending translation. At this stage, the newly formed polypeptide chain and the m-RNA are released from the ribosome. Termination happens when the ribosome comes across one of the stop codons (UAG, UAA, UGA) on the m-RNA. The stop codons are not recognized by any t-RNA; rather, they are recognized by release factors (RF). These release factors along with GTP bind on the stop codons and initiate the termination process. RF1 recognizes UAA and UAG, while RF2 recognizes UAA and UGA.

5. Role of Transfer RNA

The primary role of transfer RNA (t-RNA) is to decode (translate, like an interpreter) the codons on m-RNA and use the message in codons to direct the process of synthesizing polypeptide chain. Thus, t-RNA acts as an **adaptor or intermediaries**. Since interpretation of the language between m-RNA and amino acids is involved, the process of protein synthesis is called as **translation**.

During translation, t-RNA links to a specific amino acid at its 3' end giving rise to charged aa-t-RNA, while the opposite end (anti-codon region) recognizes a particular codon in the m-RNA. Depending upon the interaction between codons in m-RNA and specific charged aa-t-RNAs, polypeptide chain (long amino acids) are synthesized during translation.

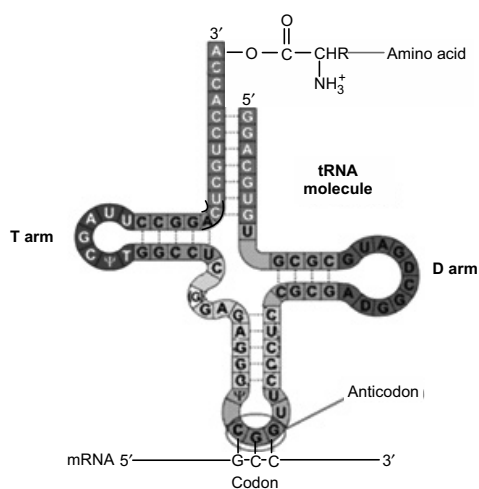

A diagram showing t-RNA molecule linking amino acid at its 3' end and codon on m-RNA at its anticodon site

Transfer RNA is composed of 73–93 nucleotides, 10 of which are modified from the standard 4 nucleotides of RNA (A, G, C, and U). Because complementary base pairing, the various t-RNAs become folded in a similar way to form a structure that can be drawn in two dimensions as a cloverleaf.

The Role of Messenger RNA

Thus, the primary role of messenger RNA is to carry the genetic information copied from DNA in the form of a series of codons (three-base code), each of which specifies a particular amino acid.

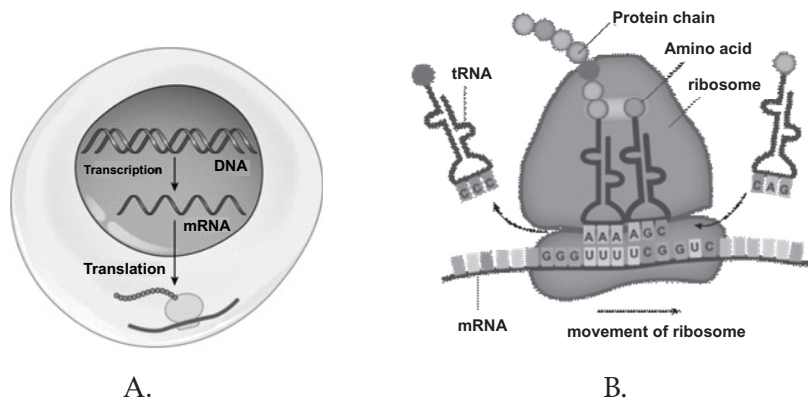

(A) A simplistic diagram representing transcription and translation.

(B) A diagram showing m-RNA carrying genetic information copied from DNA in the form of codons.

Examples: UUU, UCG codons are shown in the diagram.

The series of codons in m-RNA code for specific amino acids. For example, as shown in the diagram UUU codon will code for phenylalanine amino acid; similarly, UCG codon will code for serine amino acid. There are basically 64 codons. Out of 64 codons, 61 codons are sense codons which specify one of the 20 amino acids. On the other hand, the three codons are nonsense codons or Stop Codons and, therefore, do not specify any amino acid (For more details, refer to Genetic code topic). The sense codon AUG, which specifies Methionine, is a Start Codon. The three codons UAG, UGA and UAA are termination or stop codons.

Role of Ribosomes

Ribosomes are machines that carry our protein synthesis or translation. The main role of ribosomes is to orient the m-RNA and amino acid carrying t-RNAs in such a position that the genetic code can be read accurately and catalyse peptide bond formation.

Ribosomes are particles made up of ribosomal RNA (r-RNA) and proteins. In prokaryotes, they are present in cytoplasm, while in eukaryotes they occur both free in the cytosol and bound to membrane of the nuclear envelope. Mitochondria and chloroplast also have their ribosomes.

Generally, ribosome is composed of two dissociable subunits called the large and small subunits. In prokaryotes (bacteria), ribosome has a sedimentation coefficient of 70S; it is made up by 30S small subunit and 50S large subunit. In eukaryotes, ribosome has a sedimentation coefficient of 80S; it is made up of 40S small unit and 60S large unit.

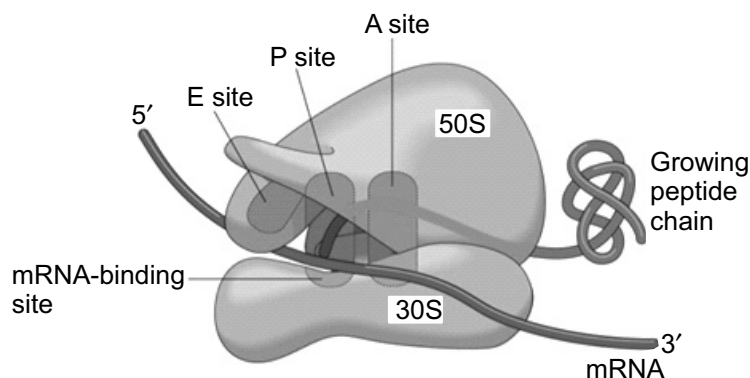

A bacterial ribosome

There are four important sites in ribosome. These four sites are particularly important during protein synthesis. These are:

- (a) **Messenger RNA-binding site:** It is the site that binds m-RNA.
- (b) **A (aminoacyl) site:** It is the site that binds each newly incoming t-RNA with its attached amino acid.
- (c) **P (peptidyl) site:** It is the site where the t-RNA carrying the growing polypeptide chain resides.
- (d) **E (exit) site:** It is the site from which t-RNAs leave the ribosome after they have discharged their amino acids.

6. Sickle Cell Anaemia

In 1910, J. Herrick first described sickle-cell anaemia. He found out that in conditions of low oxygen tension, the normal disc-shaped red blood cells of people with sickle-cell anaemia get distorted into sickle-shaped red blood cells. Sickle-cell anaemia is a genetic disease that affects haemoglobin molecules. Haemoglobin is a protein found in red blood cells, and is responsible for the transportation of oxygen through the body. Haemoglobin, the molecule affected in sickle-cell anaemia, consists of four polypeptide chains: Two α -globin polypeptides and two β -globin polypeptides-each of which is associated with a heme group (a non-protein chemical group involved in oxygen binding and added to each polypeptide after the polypeptide is synthesized).

Cause

Homozygous $\beta^A\beta^A$ people make normal **Hb-A** where the two normal α chains are encoded by the wild-type α -globin gene, while the other two normal β -chains are encoded by the normal β -globin β^A allele. A single mutation in the genes coding for the normal $\beta^A\beta^A$ haemoglobin (HB-A) results in the disease known as Sickle-Cell Anaemia.

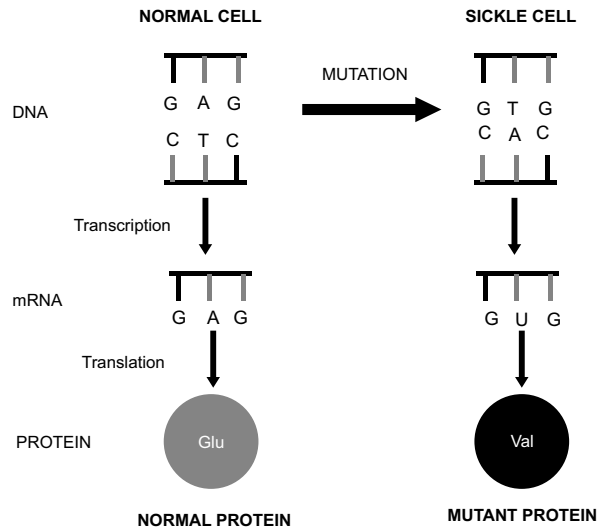

A single nucleotide substitution in haemoglobin gene resulting into replacement of glutamic acid by valine amino acid.

The mutation causing sickle cell anaemia is a single nucleotide substitution (A to T) in the DNA of hemoglobin coding gene. The change in a single nucleotide is transcribed as a codon for valine amino acid (GUG) on the m-RNA instead of glutamic acid (GAG). Eventually, due to change in the codon, valine amino acid is translated instead of glutamic acid at the 6th position from N-terminus of the haemoglobin polypeptide chain. This defect form of haemoglobin in persons with sickle cell anaemia is referred to as **HbS**.



A diagram showing replacement of glutamine (Glu) by valine (Val) at 6th position from N-terminus in the sickled hemoglobin polypeptide.

Glutamic acid (Glu) is a hydrophilic amino acid, water loving, with a negative electric charge, while Valine (Val) is a hydrophobic amino acid, water hating, with neutral electrical charge. The amino acid valine makes the haemoglobin molecules stick together, forming long fibres which convert the normal disc-shaped of red blood cells into sickle-shaped red blood cells.

Symptoms

The sickled red blood cells are fragile and broken easily, resulting in the anaemia. Normal red blood cells normally squeeze and pass through blood capillaries smoothly.

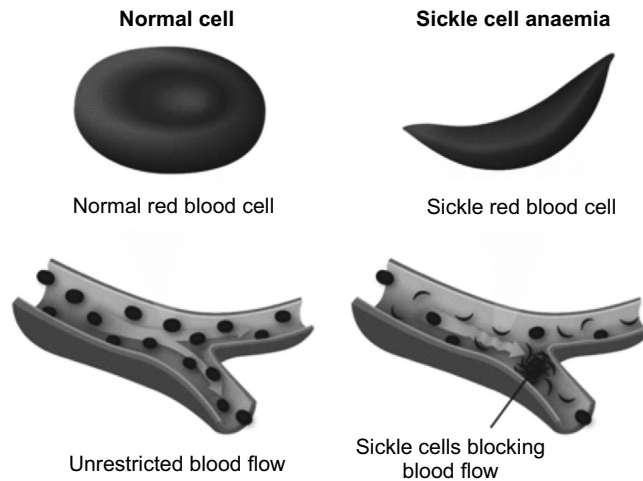

Difference between normal and sickle red blood cells.

However, sickled cells are not flexible and therefore have the tendency to get clogged in capillaries. As a result, blood circulation is impaired and tissues become deprived of oxygen. Oxygen deprivation occurs at the extremities, the heart, lungs, brain, kidneys, gastrointestinal tract, muscles, and joints.

7.

| Original Codon | Changed Codon | Amino Acid? |
|----------------|---------------|---------------|
| CUU | CUC | Leucine (Leu) |
| CUU | CUA | Leucine (Leu) |
| CUU | CUG | Leucine (Leu) |

8.

| Original Codon | Changed Codon | Amino Acid |
|----------------|---------------|---------------------|
| UUU | UUC | Phenylalanine (Phe) |
| UUU | UUA | Leucine (Leu) |
| UUU | UUG | Leucine (Leu) |

9.

| Original Codon | Changed Codon | Consequence |
|----------------|---------------|--|
| UAU | UAA | Translation will stop. UAA is a stop codon |
| UAU | UAC | It will code for tyrosine amino acid |
| UAU | UAG | Translation will stop. UAG is a stop codon |

10. **Ribosomes** are machines that carry our protein synthesis or translation. The main role of ribosomes is to orient the m-RNA and amino acid carrying t-RNAs in such a position that the genetic code can be read accurately and catalyze peptide bond formation.

Ribosomes are particles made up of ribosomal RNA (r-RNA) and proteins. In prokaryotes, they are present in cytoplasm, while in eukaryotes they occur both free in the cytosol and bound to the membrane of the nuclear envelope. Mitochondria and chloroplast also have ribosomes.

Generally, ribosome is composed of two dissociable subunits called the *large* and *small* subunits. In prokaryotes (bacteria), ribosome has a sedimentation coefficient of 70S; it is made up by 30S small subunit and 50S large subunit. In eukaryotes, ribosome has a sedimentation coefficient of 80S; it is made up of 40S small unit and 60S large unit.

There are four important sites in the ribosome. These four sites are particularly important during protein synthesis. These are:

- Messenger RNA-binding site:** It is the site that binds m-RNA.
- A (aminoacyl) site:** It is the site that binds each newly incoming t-RNA with its attached amino acid.
- P (peptidyl) site:** It is the site where the t-RNA carrying the growing polypeptide chain resides.
- E (exit) site:** It is the site from which t-RNAs leave the ribosome after they have discharged their amino acids.

11.

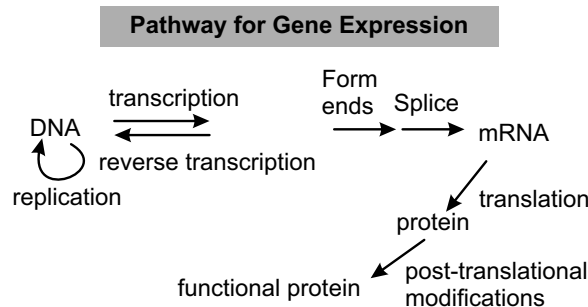

12. Mutations are changes in genetic codons caused by changes in nucleotide bases. Some mutations do not have much effect. However, some mutations can have a huge effect on genetic code, which can eventually affect the proteins they code for. The proteins produced in turn can have a profound effect on cellular and organismal function.

Mutations occur in two ways:

- A. A base-pair substitution:** It is a change from one base pair to another base pair in DNA.
- B. Base-pair insertions or deletions:** It is a change in which a base-pair is either incorrectly inserted or deleted in a codon.

(a) A Base-Pair Substitution

Consider the following changes in the DNA from

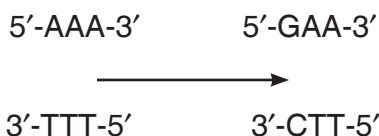

This change in base pair brings changes in the m-RNA codon from one purine to the other purine. In this case, the m-RNA codon is changed from 5'-AAA-3' (lysine) to 5'-GAA-3' (glutamic acid). This is misscuse mutation.

Now look at the changes in DNA from

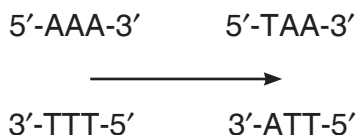

This change in base-pair in DNA results in change in m-RNA codon from 5'-AAA-3' (lysine) to 5'-UAA-3', which is a stop codon. This is a nonsense mutation. It causes premature termination of polypeptide chain synthesis, thereby releasing shorter polypeptide fragments than the normal length of polypeptide fragments during translation. These shorter fragments are often non-functional.

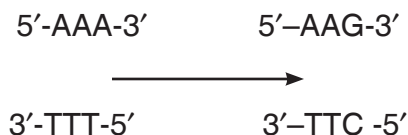

A silent mutation results from AT-to-GC transition mutation that changes the codon from 5'-AAA-3' to 5'-AAG-3'. Both of these codons

5'-AAA-3' to 5'-AAG-3' specify the same amino acid, lysine. It is worth mentioning that silent mutation often occurs by changes at the third wobble position of a codon. Refer wobble hypothesis in Genetic code.

(b) Base-Pair Insertions or Deletions

The conclusion from the above exercise is very obvious. Insertion or deletion of one or two bases changes the reading frame from the point of insertion or deletion. Insertion or deletion of three or its multiple bases insert or delete one or multiple codon hence one or multiple amino acids and reading frame remains unaltered from that point onwards, mutations are referred to as **frame-shift insertion or deletion mutations**.

- 13.** HIV causes AIDS by depleting CD4⁺ T cells. This weakens the immune system and allows opportunistic infections. T cells are essential to the immune response and without them, the body cannot fight infections or kill cancerous cells. The mechanism of CD4⁺ T cell depletion differs in the acute and chronic phases. During the acute phase, HIV-induced cell lysis and killing of infected cells by cytotoxic T cells accounts for CD4⁺ T cell depletion, although apoptosis may also be a factor. During the chronic phase, the consequences of generalized immune activation coupled with the gradual loss of the ability of the immune system to generate new T cells appear to account for the slow decline in CD4⁺ T cell numbers.

Although the symptoms of immune deficiency characteristic of AIDS do not appear for years after a person is infected, the bulk of CD4⁺ T cell loss occurs during the first week of infection, especially in the intestinal mucosa, which harbours the majority of the lymphocytes found in the body. The reason for the preferential loss of mucosal CD4⁺ T cells is that the majority of mucosal CD4⁺ T cells express the CCR5 protein which HIV uses as a co-receptor to gain access to the cells, whereas only a small fraction of CD4⁺ T cells in the bloodstream do so. A specific genetic change that alters the CCR5 protein when present in both chromosomes very effectively prevents HIV-1 infection.

HIV seeks out and destroys CCR5 expressing CD4⁺ T cells during acute infection. A vigorous immune response eventually controls the infection and initiates the clinically latent phase. CD4⁺ T cells in mucosal tissues remain particularly affected. Continuous HIV replication causes a state of generalized immune activation persisting throughout the chronic phase. Immune activation, which is reflected by the increased activation state of immune cells and release of pro-inflammatory cytokines, results from the activity of several HIV gene

products and the immune response to ongoing HIV replication. It is also linked to the breakdown of the immune surveillance system of the gastrointestinal mucosal barrier caused by the depletion of mucosal CD4⁺ T cells during the acute phase of disease.

6.13 ASSESSMENT METHODS

Use observation technique, question answer technique, and demonstration technique to assess the learners' achievement of learning objectives.

6.14 ASSESSMENTS

Formative Assessment

Fill in the blanks:

1. The formation of peptide bond is catalysed by the enzyme
2. Transfer of information from DNA to mRNA is called
3. A polysome is a row of on an mRNA chain.

Ans. 1. Peptidyl transference, 2. Transcription, 3. ribosomes

Summative Assessment

Mark the statements True (T) and False (F):

1. RNA is the genetic material in some viruses.
2. Bacterial transformation and viral infection experiments have proved that RNA is the genetic material.
3. The synthesis of RNA molecule from DNA template is called translation.
4. Protein synthesis involves three steps: initiation, elongation and termination of polypeptide chain.
5. Assembly of an amino acid chain according to the sequence of base triplets in mRNA is called transcription.

Ans. 1. True, 2. False, 3. False, 4. True, 5. False

Unit 7: Autotrophic Nutrition

7.1 LEARNING OBJECTIVES

| Knowledge and Understanding | Skills | Attitudes and Values |
|---|---|--|
| <ul style="list-style-type: none"> • State and explain the types of autotrophic nutrition. • Explain the role of light in autotrophic nutrition. • State the pigments involved in light absorption. • Recall the structure of the leaf in relation to photosynthesis. • State the sites and stages of photosynthesis in chloroplasts. • Describe the role of chloroplast pigments (chlorophyll a, chlorophyll b, carotene and xanthophylls) in light absorption in the grana. • Outline the three main stages of the Calvin cycle. • Describe and outline the conversion of the Calvin cycle intermediates to carbohydrates, lipids and amino acids and their uses in the plant cell. | <ul style="list-style-type: none"> • Use their knowledge of plant cells and leaf structure from the section on cell structure while studying photosynthesis. • Describe the relationship between the structure and function in the chloroplast, using diagrams and electron micrographs. • Interpret absorption and action spectra of chloroplast pigments. • Carry out an investigation of limiting factors. • Relate the anatomy and physiology of the leaves of C4 and CAM plants to high rates of carbon fixation and low rates of transpiration. • Apply knowledge and understanding of limiting factors to increase crop yields in protected environments, such as glasshouses. | <ul style="list-style-type: none"> • Appreciate the importance of photosynthesis as an energy transfer process that produces complex organic compounds using light energy absorbed by chloroplast pigments. • Acknowledge that environmental factors influence the rate of photosynthesis and investigation shows how they can be managed in protected environments used in crop production. |

| | | |
|---|--|--|
| <ul style="list-style-type: none"> • Explain the term limiting factor in relation to photosynthesis and the effects of the changes in the limiting factors on the rate of photosynthesis | <ul style="list-style-type: none"> • Investigate the effect of light intensity or light wavelength on the rate of photosynthesis. • Differentiate between C4, CAM and C3 plants during carbon dioxide fixation | |
|---|--|--|

7.2 TEACHING AIDS

Visual: Images of adaptations of plants.

Audio-video: Video showing cycles of dark reaction.

7.3 TEACHER'S TIP

Teacher starts the unit by briefing the learners about autotrophic organisms and how we are dependent on these for food. The different adaptations and cycles involved in complexity of photosynthesis. The role of limiting and environmental factors for preparation of food by autotrophs. Their dependence on water, light and air to conduct the process of photosynthesis and further the importance of autotrophic nutrition in nature.

7.4 TEACHING METHODS

Brainstorming, short lecture technique, group discussion technique, observation technique, drawing technique, demonstration technique, and practical work.

7.5 TEACHING AND LEARNING MATERIAL

Aquatic plants e.g. Elodea, Redox indicator (e.g. DCPIP) and a suspension of chloroplasts from crushed green leaves, test tubes, light bulbs, colour filter, charts and illustrations of the Calvin cycle and cyclic and non-cyclic photophosphorylation, syringes, leaf materials, cork borers and light gels or colour filters.

7.6 TEACHING METHODOLOGY

Teacher initiates the topic by introducing the basic knowledge of photosynthesis.

Teacher also discusses the types of photosynthesis. Start by asking the learners to tell any of the examples they could cite.

Learners reply to the questions raised by the teacher.

Appreciating them, the teacher further asks if they are aware of dark reactions.

Learners will come up with varied answers. Some correct, some near to correct, others being irrelevant.

Teacher will not demotivate the child. But agreeing to the correct answers, dwell further in discussion.

Using short lecture technique, teacher will explain the importance of autotrophic nutrition and cycles of dark reaction.

Teacher further explains the learners the different adaptations and examples related to photosynthesis.

7.7 ADDITIONAL CONTENT FOR THE TEACHER

- **Photosynthesis is an oxidation reduction** process where water is oxidised to O_2 and CO_2 is reduced to $(CH_2O)_n$.
- **The Redox Potential** of H_2O/O_2 is + 0.8 V and that of $CO_2/(CH_2O)_n$ is -0.4 V. The difference is 1.2 V per electron transferred. Redox potential is the tendency of the system (atom/molecule) to give or take up electrons. The symbol used to express the standard redox potential at pH 7 is E_0 . The compound having low redox potential tends to lose electrons and those having high redox potential gain electrons.
- **Herbicides** such as CMU (3 p.chlorophenyl 1, 1 dimethyl urea) and DCMC (3, 4- ichlorophenyl 1, 1 dimethyl urea) block electron transport between quinone (Q) to plastoquinone (PQ), during non-cyclic electron transport.
- **Quantum Yield.** Number of oxygen molecules released per photon or quantum of light is called quantum yield. Its value is 1/8 to 1/10 (10–12.5%). In other words, evolution of one molecule of oxygen or consumption/fixation of one molecule of CO_2 requires 8–10 quanta. The number of light quanta used for producing one molecule of O_2 or fixation of one molecule of CO_2 is called **quantum requirement**.
- **Chemical Coupling Hypothesis.** Synthesis of ATP is connected to liberation of energy while electrons pass down hill over the electron transport chain.
- **Chemi-Osmotic Hypothesis** (Mitchell 1961). There is accumulation of protons which pass through membrane bases ATPase (for coupling factor, elementary particle) catalysing synthesis of ATP from ADP and inorganic phosphate.
- **P-protein.** It is synthesised in companion cells (absent in gymnosperms). In sieve tube cells it has a role as defence against phloem feeding insects and sealing of damaged sieve tubes by lugging sieve plates.

- **Thylakoid Reactions.** Reactions of photochemical phase as they occur over the thylakoids.
- **Stroma Reactions.** Reactions of biosynthetic phase, as they occur in stroma.

Activity

The teacher can demonstrate this activity in the class.

Aim: To make the learners understand photosynthesis.

Refer to text and try practising cycles on boards and chart papers.

Ask each learner to read it aloud and using coloured pens make dark reaction cycles.

7.8 SUMMARY

- Organisms that are autotrophic can make their own food from inorganic substances with the help of energy.
- Photosynthesis is the process where the source of energy is light. It is carried out by green plants, algae and some bacteria.
- Photosynthesis takes place in green parts of a plant, mainly leaves. Within leaves, chloroplasts in mesophyll cells are the site of photosynthesis.
- Photosynthesis has two stages: light reaction and dark reaction. Light reaction is a photo-chemical reaction, in which light energy is absorbed by the pigments present in antenna molecules of light harvesting complex. While, in dark reaction carbon is reduced in the stroma of chloroplast.
- Chlorophyll, a molecule is the reaction centre which has two special forms PSI and PSII with absorbance maxima at 700 nm and 680 nm, respectively.
- In temperate plants, C-3 cycle takes place with the help of enzyme RUBISCO. The C-3 cycle includes: carboxylation, reduction and regeneration. In some tropical plants, C-4 cycle takes place.
- C-4 cycle includes dual carboxylation that takes place in mesophyll cells chloroplast and bundle sheath cell chloroplasts.
- Various environmental factors such as light, temperature, carbon dioxide concentration, oxygen concentration and air pollutants are responsible for the plant productivity on account of photosynthesis.

7.9 WEBLINKS FOR CONTENT ENRICHMENT

- <http://www.livescience.com/51720-photosynthesis.html>
- <https://www2.estrellamountain.edu/faculty/farabee/BIOBK/BioBookPS.html>
- <http://biology.clc.uc.edu/courses/bio104/photosyn.htm>

7.10 LEARNERS' ACTIVITIES

Activity 1

Step 1: Ask the learners to study about autotrophic nutrition.

Step 2: Ask them to make a report and present to class.

Activity 2

The teacher should guide the learners to perform the activity.

Hint:

1. Take a potted plant. Keep one in dark and other in well illuminated conditions for 24 hrs.
2. Take ethyl alcohol in a saucer pan and bring it to boil.
3. With the help of tweezers dip leaves from each plant for 30s.
4. Place them in a beaker of ethyl alcohol until they turn white.
5. Take leaves out and cover with iodine solution to test for starch

Observation

Leaf taken from well illuminated condition plant turned bluish-black while other tested negative.

Explanation

When you keep the leaves in boiling ethyl alcohol, the chlorophyll gets degraded and leaves turn white. This condition is good for testing leaves for presence of starch as green colour of chlorophyll will not hinder in positive test for starch. Iodine forms blue-black complex with starch. Leaf taken from to plant kept in well illuminated light tested positive for starch as photosynthesis takes place in presence of light; while in dark no photosynthesis takes place and no starch is formed. Therefore, leaf taken from plant kept in dark did not show colour change.

Activity 3

The teacher should assist the learners to perform the following activity.

Hint:

1. Take few fresh twigs of Elodea with one end intact and put in beaker full of water.
2. Keep an inverted funnel on the pant such that all plants are within the funnel.
3. Now take a boiling tube full of water and invert it on the funnel.
4. Add some sodium bicarbonate salt to water as source of carbon dioxide.
5. Put the whole apparatus in sunlight.

Observation

After sometime, air bubbles arise from the cut end of plant twigs and fill the test tube. If a burning splinter is brought near the filled air, it will burn faster.

Explanation

Elodea is a submerged aquatic hydrophyte with a lot of air spaces inside. When photosynthesis takes place, oxygen is released and air escapes out in the form of bubbles from the cut end. Some sodium bicarbonate salt can also be added to water (1mg/ml) as a source of carbon dioxide. After sometime, air bubbles arising from the cut end of plant twigs will fill the boiling tube.

To confirm that air accumulated is oxygen, bring a burning splinter near the filled air, it will burn faster. This proves that oxygen is released during photosynthesis by aquatic plant.

Activity 4

The teacher should guide the learners to perform the following activity.

Hint:

1. Make leaf extract by crushing 20 g leaves in 20 mL acetone.
2. Cut a vertical strip (10 cm X 2.5 cm) of Whatmann's filter paper No.1. Make it V-shaped at one end. Draw a horizontal line with a pencil (not pen) about half an inch from the bottom.
3. With the help of capillary tube load a small drop of leaf extract at the centre of pencil mark and air dry.
4. Repeat the previous step for 5–6 times.
5. Insert paper strip in chromatographic chamber pre-saturated with solvent (1:9:: benzene:petroleum ether) such that only the tip of paper is dipped in solvent. Do not dip the loaded pigment into solvent.
6. Allow it to run for a few (1–2) hours.
7. Take out the strip and mark the solvent front and different coloured separated pigments.
8. Calculate Rf value.

$$R_f = \frac{\text{Distance traveled by solute}}{\text{Distance traveled by solvent}}$$

Observation

| Colour | Pigment | Distance Travelled by Pigment | Rf Value |
|-------------------------|----------|-------------------------------|----------|
| Yellow to Yellow-orange | Carotene | | |

| | | | |
|-----------------------------|---------------|--|--|
| Yellow | Xanthophyll | | |
| Bright Green to Blue Green | Chlorophyll a | | |
| Yellow Green to Olive Green | Chlorophyll b | | |

Explanation

The leaf extract in acetone contains four dissolved pigments of chloroplasts. These pigments are separated from each other by chromatographic separation, where pigments show different solubility in the solvent. The pigment which is more hydrophilic travels the least distance on paper as compared to the pigment which is more soluble in solvent. Chlorophyll b has the least Rf value and Carotenes have highest.

Activity 5

The teacher should help the learners perform the activity.

Hint:

1. Crush the interveinal portion of leaves in chilled sucrose buffer using pestle and mortar.
2. Filter it and centrifuge the filtrate at 200–300rpm for 2–3 minutes.
3. Collect the supernatant and again centrifuge at higher speed above (5000 rpm).
4. Collect the pellet and dissolve into a small amount of buffer.
5. Take test tube and to each test tube, add sucrose buffer, chloroplast extract, DCPIP dye according to the following table and keep in different light conditions.

Observation

| S.No. | Chloroplast Suspension | Sucrose Buffer | DCPIP Dye | Light Condition | Observation and Inference |
|-------|------------------------|----------------|-----------|-----------------|--|
| 1. | 0.5 mL | 9 mL | 0.5 mL | Sunlight | Colour change from blue to green |
| 2. | 0.5 mL | 9 mL | 0.5 mL | Low light | Colour change from blue to green takes more time |
| 3. | 0.5 mL | 9 mL | 0.5 mL | Dark | Control for light |

| | | | | | |
|----|--------------------|------|--------|----------|-------------------------|
| 4. | 0.5 mL (Boiled) | 9 mL | 0.5 mL | Sunlight | Control for chloroplast |
| 5. | 0.5 mL | 9 mL | 0 | Sunlight | Reference |

Explanation

DCPIP is a blue colour dye in oxidized form. When it is reduced, it becomes colourless. In the present experiment to demonstrate Hill's reaction, DCPIP is used as an artificial acceptor of protons.

In photochemical reaction or light reaction, water splits in presence of light into oxygen, electrons and protons. These protons are ultimately accepted by NADP and reduced to NADPH. Similarly, when chloroplasts are exposed to light, photolysis of water takes place and protons produced reduce the blue coloured DCPIP dye into colourless.

Activity 6

The teacher should guide the learners to perform the following activity.

Hint:

1. Take a fresh, healthy twig with one end intact.
2. Tie it gently to a glass rod and put it into a boiling tube or jar containing water.
3. Add 0.5 g sodium bicarbonate per 500 mL of water, and keep it in a moderate light condition.
4. Note the numbers of bubbles escaping from cut end per minute.
5. Again add 0.5 g sodium bicarbonate and note the numbers of bubbles escaping from cut end per minute. Repeat this step until bubbles escaping per minute do not increase.
6. Take the set up under high light intensity and note the numbers of bubbles.

Observation

Rate of photosynthesis first increases on adding sodium bicarbonate as a source of carbon dioxide. However, after some time light becomes the limiting factor as rate does not increase further. But when the set up is taken to high sunlight, the rate of photosynthesis again shoots up.

Explanation

Photosynthesis takes place in green plants in presence of carbon dioxide, water and light. Photosynthesis takes place even at low light conditions if carbon dioxide is available. In the present experiment, the rate of photosynthesis is determined in terms of the amount of oxygen produced.

Rate of photosynthesis = No. of bubbles per unit time

As the concentration of carbon dioxide is increased, the number of bubbles also increased. But after a certain concentration of carbon dioxide, the rate of photosynthesis does not increase because light becomes a limiting factor. According to Blackman's law of limiting factor if a chemical process is affected by more than one factor, then rate of process will be determined by the factor which is nearest to minimal value. Thus when the limiting factor was overcome i.e. light was increased rate of reaction further increased.

Activity 7

Step 1: Guide the learners to bring materials.

Step 2: Assist them to understand and perform the activity as directed in the procedure.

Step 3: Ask the learners to observe and present their results.

Activity 8

The teacher should guide the learners to perform the following activity.

Hint:

1. Take out a uniform size disc from fresh leaves of spinach.
2. Take leaf disc in 0.2% sodium bicarbonate solution and a drop of liquid detergent in a syringe.
3. Plunge out air present in between tissue, such that intercellular spaces are occupied by sodium bicarbonate.
4. During this process all leaves sink.
5. Put leaf discs in a beaker containing water exposed to a lamp.
6. Count the number of leaves that float on surface at regular interval of time.
7. 50% leaves floating is calculated from a graph between the number of leaves and time.
8. Similarly, experiment is repeated on increasing light conditions.

Observation

Leaves start floating after being kept in light.

Explanation

When intercellular spaces in leaves are occupied by sodium bicarbonate, the leaf discs sink. When the apparatus is exposed to light, oxygen is produced and leaf discs float to surface. The point at which 50% of the leaf discs are floating (the median) is the point of reference for this procedure. 50% floating point can be extrapolated from graph called ET50. Similarly, this is calculated at different light intensities. Increase in

light intensity is in linear relation with increase in rate of photosynthesis, therefore a graph is plotted between light intensities and inverse of ET50 as rate of photosynthesis.

Activity 9

The teacher should assist the learners to perform the activity.

Hint:

1. Take a fresh, healthy twig of Elodea plant with one end intact.
2. Tie it gently to a glass rod and put it in a tube or jar containing water.
3. Add 0.5 g sodium bicarbonate and keep it in under a light source at a distance of 50 cm/ low light condition.
4. Note the numbers of bubbles escaping from cut end per minute.
5. Place the apparatus at distance of 30 cm from light source and count the number of bubbles evolving per minute.
6. Similarly, place the apparatus at variable distances from light source and count the number of bubbles evolving per minute.

Observation

Number of bubbles increases with increase in light intensity.

Explanation

Photosynthesis takes place in green plants in presence of carbon dioxide, water and light. Light is an important factor for the process of photosynthesis. Photosynthesis takes place even at low light conditions but rate increases when the light intensity is increased. In the present experiment, the rate of photosynthesis is determined in terms of amount of oxygen produced.

$$\text{Rate of photosynthesis} = \text{No. of bubbles per unit time}$$

Therefore, as the distance of experimental set up is decreased with respect to plant or in other words light intensity is increased, the number of bubbles produced is also increased. However, at extremely high light intensity, the rate of photosynthesis may decrease because of photo-oxidation of chlorophyll pigments.

Activity 10

The teacher should guide the learners to perform the activity.

Hint:

1. Take a fresh, healthy twig with one end intact.
2. Tie it gently to a glass rod and put it into boiling tube
3. Add 0.5 g sodium bicarbonate and keep it in moderate light condition.
4. Note the temperature and numbers of bubbles escaping from cut end per minute.
5. Heat or cool the water in boiling tube and count the number of bubbles at different temperatures.

Observation

Rate of photosynthesis increases with increase in temperature but later at very high temperature, the rate of photosynthesis decreases.

Explanation

Photosynthesis takes place in green plants in presence of carbon dioxide, water and light. In the present experiment, the rate of photosynthesis is determined in terms of amount of oxygen produced.

Rate of photosynthesis = No. of bubbles per unit time

Photosynthesis is an enzyme dependent process. At very low temperature, enzymes become inactive and at very high temperature, enzymes get denatured. Therefore, the number of bubbles first increases with increase in temperature and then decreases.

7.11 ANSWERS TO SELF-EVALUATION**Self-evaluation**

- (i) thylakoid
- (ii) xanthophyll
- (iii) 430 nm, 680 nm
- (iv) 680 nm

Self-evaluation

- (i) chloroplast, peroxisome, mitochondria
- (ii) kranz anatomy
- (iii) RuBP
- (iv) Mesophyll cells, bundle sheath cells

7.12 ANSWERS TO END UNIT ASSESSMENT 7

I. Choose whether the given statements are True (T) or false (F):

1. False
2. True
3. False
4. True
5. True
6. False

II. Multiple choice questions:

1. (a), (b), (d)
2. (c); Sugarcane is the tropical plant
3. (b)
4. (b); Bundle sheath cells show different chloroplast in C-4 plants
5. (d); During assimilation six molecules of carbon dioxide, 18 ATP are required and one molecule of glucose is produced
6. (c); they produce sugars from chemical energy which is used by other organisms. They produce food for all organisms.

III. Long answer type questions:

1. Types of Autotrophic Nutrition

Chemoautotrophic: An autotrophic nutrition where organisms get energy from oxidation of chemicals, mainly inorganic substances like hydrogen sulphide and ammonia.



Photoautotrophic: An autotrophic nutrition where organisms get energy from sunlight and convert it into usable form like sugars. Green plants and some bacteria like, green sulphur bacteria can make their own food from simple inorganic substances by a process called photosynthesis.

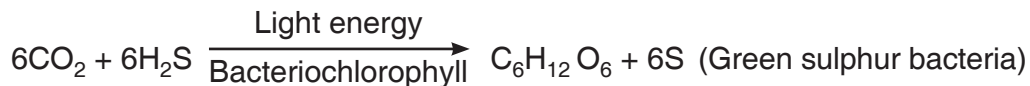

Role of Light

Light has two components: wave and particle. A wave is characterized by a wavelength, denoted by a Greek letter lambda (λ), which is the distance between two successive wave crests, and the number of wave crests that pass an observer in given time is called frequency (ν). Light is also a particle called

photon. Sunlight is like rain of photons with different frequencies. The energy content of light photon is not continuous, rather delivered in discrete packets, the quanta.

When a light photon is absorbed, an electron is excited from pigment molecule to a higher energy level (triplet state). It remains there for 10^{-9} s and then falls to ground state. Sometimes, it can emit the energy in the form of light and heat as it reaches the ground state. This process is called fluorescence. When electron remains at triplet state for more than 10^{-9} s and then comes back to ground state, the energy is lost in the form of heat and light. This happens even after the source is put off. Such a process is called phosphorescence.

2. Photosynthesis is a process by which plants and other organisms, such as algae and bacteria synthesize their own food using the energy of light for their growth and development. The food produced by plants is in the form of carbohydrates. In preliminary studies, Julius von Sachs proposed that glucose is the first product of photosynthesis. It is stored in chloroplasts within plant cells. It provides energy in the form of food to organisms that feed on plants. It has been rightly said “ALL FLESH IS GRASS”, as all organisms (herbivores, carnivores and omnivores) are directly or indirectly dependent on plants as source of energy. It is the means by which solar energy is captured by plants for use by all organisms. In 1782, Jean Senebier proved that green plants can produce oxygen in presence of light and carbon dioxide. It is the single most important biological process that can replenish oxygen which is required for existence of all other organisms. *Have you ever thought what will happen if there is no photosynthesis?* This chapter focuses on the photosynthetic machinery, the reactions in this physiochemical process and the factors affecting photosynthesis.
3. Photosynthesis occurs not only in eukaryotic organisms such as green plants but also in prokaryotic organisms like blue green algae and green sulphur bacteria. In higher plants, photosynthesis occurs in the green part of the plant. Leaves are adapted to carry photosynthesis efficiently. Most leaves are broad and flat to capture maximum light. Also, the bifacial nature of leaf allows it to collect incident light on the upper surface and diffuse light on lower surface. The photosynthetic tissue is located between upper and lower epidermis. It consists of one to three layers of compactly arranged, elongated and cylindrical palisade mesophyll cells, and loosely arranged, irregular and isodiametric spongy mesophyll cells. In monocotyledonous leaf there is no distinction of

palisade and spongy parenchyma. The mesophyll cells in leaves contain large number of chloroplasts that transform light energy into ATP and NADPH which are then used to convert CO_2 into sugars.

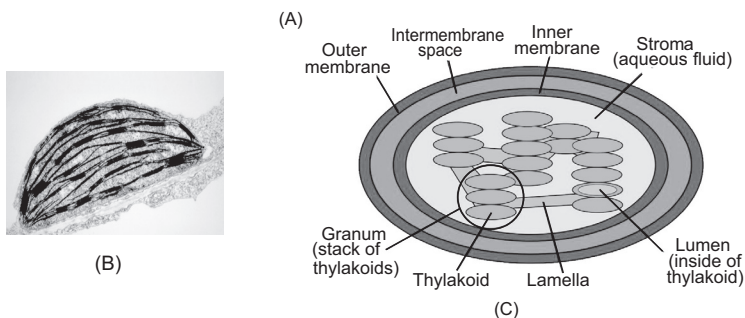
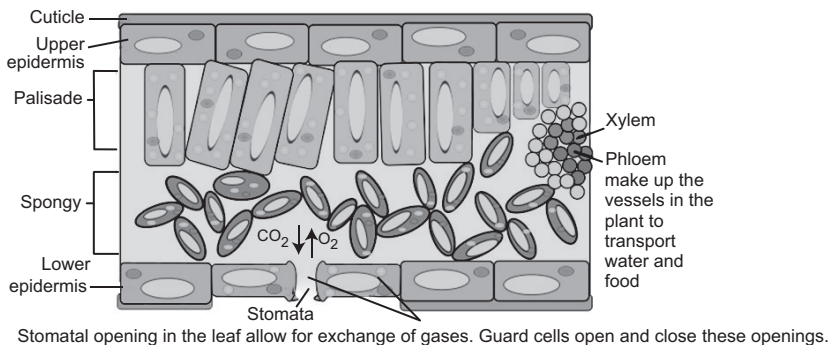

(A) Structure of leaf showing photosynthetic cells; (B) EM of chloroplast cells;
(C) Sectional view of chloroplast.

Chloroplast is the photosynthetic machinery. It is a double membrane organelle that contains a series of parallel membranes called thylakoids or lamellae, suspended in a fluid like matrix called stroma. The thylakoids are flattened discs arranged in stacks called grana. In a typical chloroplast as many as 40–60 grana may be present and each granum may contain 2–100 thylakoids. The stroma contains DNA, ribosomes, soluble proteins and enzymes, while pigments are confined to thylakoids. Thylakoids have large surface for absorption of light and the space within them 'lumen' allows rapid accumulation of protons.

4. A pigment is a substance that absorbs light of different wavelengths. Pigments are involved in absorption of light of certain wavelengths. While some wavelengths are absorbed, others are reflected or scattered, which imparts their colour. The absorbed wavelength of light has the correct energy to excite specific transitions of electrons in the pigments. Photosynthesis depends on light absorption by pigments in leaves. However, it can be carried out in isolated chloroplast but not in isolated pigments. Chlorophyll a is the major pigment involved in

trapping light energy. It is the principal pigment involved in photosynthesis. It is of universal occurrence. It is a large molecule composed of four pyrrole rings with Mg at centre, and a long hydrocarbon phytol chain. It absorbs maximum wavelengths of 430 nm and 660 nm. Chlorophyll b constitutes one-fourth of the total chlorophyll content. It has a similar structure as that of Chlorophyll a, except that the $-CH_3$ group in chlorophyll a is replaced by $-CHO$ group in chlorophyll b. It absorbs maximum wavelengths of 460 nm and 680 nm.

Carotenes are tetraterpenes or polyunsaturated hydrocarbons containing 40 carbon atoms and variable number of hydrogen atoms and no other elements. β -carotene is the common form found abundantly in orange, yellow and green fruits and vegetables. Carotenes protect plants against photo-oxidation. Xanthophylls are yellow coloured pigments. They are structurally similar to carotenes, but contain oxygen atoms. These are more common in young and etiolated leaves. Absorption and Action Spectra A plot showing absorption of light of different wavelengths of a pigment is called absorption spectrum.

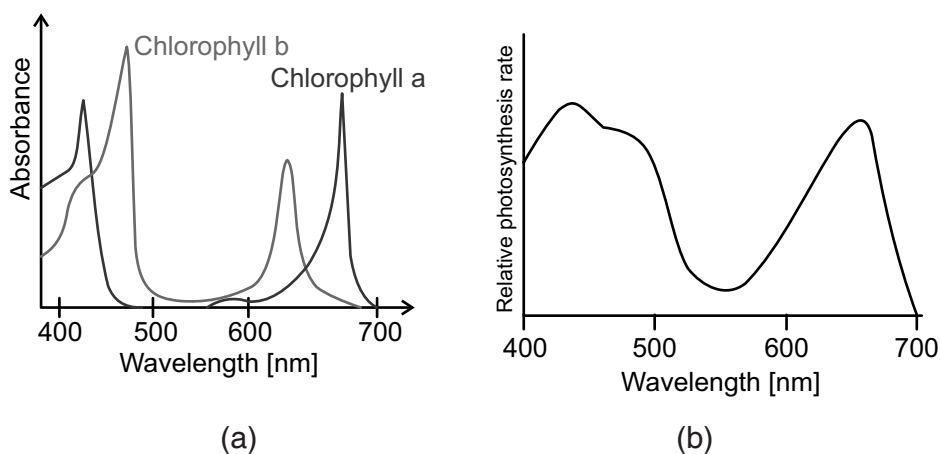

(a) Absorption spectrum of chloroplast pigments;
 (b) Action spectrum of green plants.

Each pigment absorbs a specific wavelength. We can plot an absorption spectrum showing the ability of pigments to absorb lights of different wavelengths. From Figure A, it can be concluded that Chlorophyll a and b show absorption peaks at blue and red light. On the other hand, action spectrum is the plot of graph depicting the rate of a light sensitive process at different wavelengths of light. The action spectrum of photosynthesis shows that most of the photosynthesis also takes place in blue and red light. The absorption spectrum of a pigment when compared with action spectrum of photosynthesis, gives the function

of the pigment. Therefore, it can be concluded that chlorophyll a is the chief photosynthetic pigment. The other pigments like chlorophyll b, carotenes and xanthophylls are called accessory pigments and form the antenna complex. They collect the light of different wavelengths and transfer it to reaction centre (basic model of energy transfer). This is called Light Harvesting Complex. LHC is made up of hundreds of pigment molecules bound to proteins.

5. Calvin Cycle

It is carbon assimilation process which utilizes assimilatory power generated from light reaction to produce sugars. It occurs in stroma of chloroplasts. Melvin Calvin got a Nobel Prize for his outstanding work on carbon assimilation. Melvin Calvin, Andrew Benson and James Bassham gave the Calvin cycle of dark reaction. They used autoradiography to detect path of cycle, and chromatography to separate constituents. The first product that showed radioactivity was a three carbon (3-C) compound Phosphoglyceric acid (PGA) and hence the cycle is also called C-3 cycle.

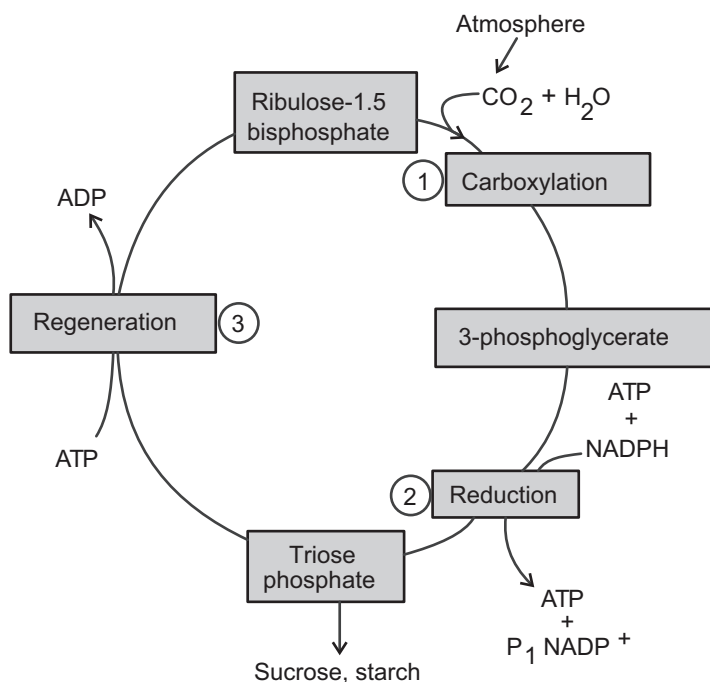

The process of carbon assimilation can be described under three stages: carboxylation, reduction and regeneration.

Carboxylation: It is the process of fixation of carbon in stable organic intermediate, phosphoglyceric acid. This reaction is catalyzed by called

RuBPCarboxylase-oxygenase (RUBISCO). Rubisco-bis-phospahte (RuBP) is the initial acceptor or substrate for dark reaction.



Reduction or Glycolytic Reversal: It is the process involving reduction of carbon. It is a multistep process that utilizes 12 ATP molecules and 12 NADPH for release of one molecule of glucose. The glucose can further be converted into starch for storage or sucrose for transport.

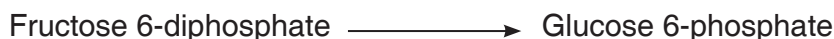
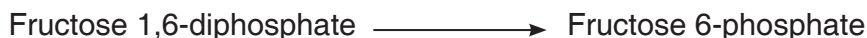
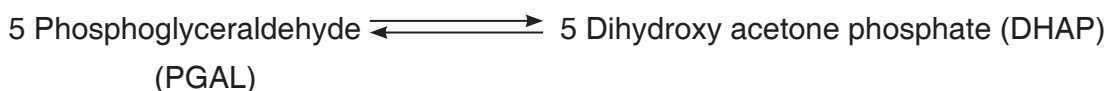
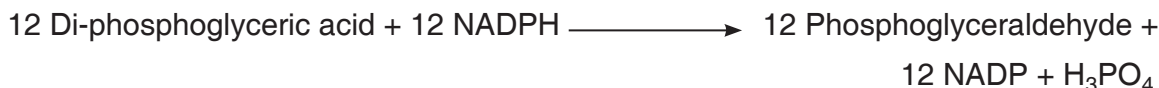

Regeneration: This process requires 6 ATP molecules to regenerate 6 molecules of RuBP, which is crucial for continuity of Calvin cycle.



During complete cycle, ATP, NADPH and CO₂ are used up. For one molecule of glucose six molecules of carbon dioxide, 18 ATP and 12 NADPH are required. The dark reaction is therefore dependent on light for the production of high amount of ATP and NADPH.

| In | Out |
|---------------------|-------------|
| Six CO ₂ | One glucose |
| 18 ATP | 18 ADP |
| 12 NADPH | 12 NADP |

Another important requirement is high concentration of CO₂. The efficiency of photosynthesis declines at low concentration of CO₂. This is because the enzyme RUBISO has low affinity with carbon dioxide as compared to oxygen. At low CO₂ concentration RUBISCO catalyzes the reaction between RuBP and oxygen. The

oxygenation of RuBP in presence of light and oxygen is called Photorespiration. It occurs in chloroplast, peroxisome and mitochondria.

It is a wasteful process as during this process carbon dioxide is released and efficiency of photosynthesis decreases.

6. The rate of photosynthesis can be influenced by many factors like number, size, orientation and age of leaf, sunlight, temperature, carbon dioxide and water. However, when several factors can affect a process, the rate of reaction is governed by the factor which is limiting. This is called Blackman's (1905) law of limiting factor.

External Factors

CO₂ concentration: Carbon dioxide is the inorganic substrate for photosynthesis. Increase in concentration up to 0.05% in atmosphere can cause an increase in CO₂ fixation. Carbon dioxide is the major limiting factor, especially in C-3 plants; C-4 plants are more productive even at low concentration of CO₂. Nevertheless, both C-3 and C-4 plants show increase in rate of photosynthesis at high CO₂ concentration and high light intensities. The fact that C-3 plants respond to higher CO₂ concentration by showing increased rates of photosynthesis leading to higher productivity has been used for some green house crops such as tomatoes and bell pepper. They are allowed to grow in carbon dioxide enriched atmosphere as in glasshouses leading to higher yields.

Light: Light is an important factor to carry out photosynthesis. It is rarely a limiting factor in nature as photosynthesis can occur even at low light intensities. There is a direct relation between light and CO₂ fixation. With increase in light intensity, the rate of photosynthesis increases. However, at higher light intensities, rate does not increase linearly but light saturation occurs. At very high light intensity, there is breakdown of chlorophyll molecules called photo-oxidation and the rate of photosynthesis decreases. The quality of light and time of exposure also governs photosynthesis. Green plants show high rate of photosynthesis at red and blue light.

Temperature: The dark reactions are dependent on temperature as they are enzymatic. Rate of photosynthesis is best at optimum temperature. Different plants have different temperature optima that also depend on their habitats.

Water: Only about 1% of water absorbed by plants is used in photosynthesis. It is an important factor for various metabolic processes in plant. Water may not have direct effect on photosynthesis even though it is one of the reactants in light reaction. In water, stress plants wilt and their stomata close. Thus, reducing availability of carbon dioxide and decreasing the rate of photosynthesis. Water

stress will also alter the hydration of enzymatic proteins, affecting their activities.

Oxygen concentration: Atmospheric oxygen content affects photosynthesis directly or indirectly. The decrease in the rate of respiration at high oxygen concentration was first observed by O. Warburg in 1920 in *Chlorella*. The phenomenon is called Warburg effect.

Chemical pollutants: Plant growth has been adversely affected by accumulation of various undesirable chemicals. Heavy metals such as lead, mercury, cadmium seem to be affecting photosynthesis through stomata closure. Air pollutants like SO₂, NO₂ and O₃ are also known to affect photosynthesis at higher concentrations.

Internal Factors

Adaptation of leaf: Leaves are arranged on plants to minimize overlapping. The shape, size, age and orientation of leaf influences the absorption of light and thus, affects photosynthesis. Most leaves are broad for more absorption of light. The anatomy of leaf is also highly specialized for absorption of light. The epidermis is transparent and also acts as convex lens to focus and intensify the light reaching mesophyll cells for maximum absorption. The palisade layer also helps in absorption of more light. Presence of hairs, salt glands and epicuticular wax increase the reflection of light and thereby reduce the absorption.

Absorption of carbon dioxide is also dependent on leaf surface area and number of stomata. Spongy parenchyma has large intercellular space so that carbon dioxide can easily diffuse. Opening and closing of stomata is yet another factor that governs photosynthesis as the exchange of gases is affected when stomata close. In some succulent plants such as *Bryophyllum*, *Kalanchoe*, stomata open during night and close during day to reduce the rate of transpiration. Such plants have special mechanism for photosynthesis called Crassulacean Acid Metabolism (CAM), where CO₂ fixation takes place in different time (day and night) as per availability of carbon dioxide and light.

7.

| Feature/Characteristic | C4 Plants | CAM Plants |
|----------------------------------|---|---|
| CO ₂ fixation pathway | via C3 and C4 cycles, spatially (C4 in the mesophyll cell then C3 in the bundle' sheath cell) | via C3 and C4 cycles, both spatially (in different parts of same cell) and temporally (C4 at night, C3 at day time) |

| | | |
|--|--|---|
| Distribution in the plant kingdom (% of plant species) | ~3% (Simpson 2010), all angiospermous including most troublesome weeds; mostly monocots (C4 grasses and sedges about 79% of all C4 plants) | ~8% (Simpson 2010), mostly succulent plants but not all succulents are CAM plants |
| Type of photosynthesis | C4 photosynthesis | CAM photosynthesis |
| CO ₂ fixation pathway | via C3 and C4 cycles, spatially (C4 in the mesophyll cell then C3 in the bundle' sheath cell) | via C3 and C4 cycles, both spatially (in different parts of same cell) and temporally (C4 at night, C3 at day time) |

| | | |
|--|--|--|
| Leaf anatomy | Generally thinner leaves closer arrangement of vascular bundles, smaller air spaces than C3; veins surrounded by thick-walled BSC further surrounded by thin-walled mesophyll cells (wreath-like arrangement of BSC is called Kranz anatomy); mesophyll cells and BSC contain chloroplasts, those of the BSC much larger | Thick and fleshy leaves, mesophyll cells having large, water-filled vacuoles |
| Stomatal movement | Stomata open at daytime, close at night | Inverted stomatal cycle (open at night, close in the day) |
| Typical Environmental/ Geographical adaptation (where most common) | Tropical or semi-tropical, high light intensity, high temperature, drought conditions | Desert or arid (xeric) habitats |

8. Comparison of C₃, C₄ and CAM plants

| C ₃ plants | C ₄ plants | CAM plants |
|---|---|---|
| Most plants | Tropical grasses like corn, sugarcane | Succulents, pineapple, agave |
| Fix carbon in Calvin cycle-attach CO ₂ to RuBP | Fix carbon in cytoplasm-attach CO ₂ to PEP | Fix carbon at night only, fix it to organic molecules |
| Enzyme-Rubisco | Enzyme-PEP-ase | Enzyme-PEP-ase |
| Most energy efficient method | 1/2 way between these two | Best water conservation |
| Loses water through photore spiration | Loses less water | Loses least water |

9. **Light:** Light is an important factor to carry out photosynthesis. It is rarely a limiting factor in nature as photosynthesis can occur even at low light intensities. There is a direct relation between light and CO₂ fixation. With increase in light intensity, the rate of photosynthesis increases. However, at higher light intensities, rate does not increase linearly but light saturation occurs. At very high light intensity, there is breakdown of chlorophyll molecules called photo-oxidation and the rate of photosynthesis decreases. The quality of light and time of exposure also governs photosynthesis. Green plants show high rate of photosynthesis at red and blue light.

Aim: To study the effect of light on the rate of photosynthesis.

Materials Required

Elodea plant, Sodium bicarbonate, water, glass jar or culture tube, glass rod, dropper, weighing balance, thread, light source metre scale.

Procedure

1. Take a fresh, healthy twig of *Elodea* plant with one end intact.
2. Tie it gently to a glass rod and put it in a tube or jar containing water.
3. Add 0.5 g sodium bicarbonate and keep it in under a light source at a distance of 50 cm/low light condition.
4. Note the numbers of bubbles escaping from cut end per minute.
5. Place the apparatus at distance of 30cm from light source and count the number of bubbles evolving per minute.
6. Similarly, place the apparatus at variable distances from light source and count the number of bubbles evolving per minute.

Observation

Number of bubbles increases with increase in light intensity.

Explanation

Photosynthesis takes place in green plants in presence of carbon dioxide, water and light. Light is an important factor for the process of photosynthesis. Photosynthesis takes place even at low light conditions but the rate increases when the light intensity is increased. In the present experiment, the rate of photosynthesis is determined in terms of amount of oxygen produced.

Rate of photosynthesis = No. of bubbles per unit time

Therefore, as the distance of experimental set up is decreased with respect to plant or in other words light intensity is increased, the number of bubbles produced also increased. However, at extremely high light intensity, the rate of photosynthesis may decrease because of photo-oxidation of chlorophyll pigments.

- 10.** Photosynthesis occurs not only in eukaryotic organisms such as green plants but also in prokaryotic organisms like blue green algae and green sulphur bacteria.

In higher plants, photosynthesis occur in the green part of the plant (Figure (i)). Leaves are adapted to carry photosynthesis efficiently. Most leaves are broad and flat to capture maximum light. Also, the bifacial nature of leaf allows it to collect incident light on the upper surface and diffuse light on lower surface. The photosynthetic tissue is located between upper and lower epidermis. It consists of one to three layers of compactly arranged, elongated and cylindrical palisade mesophyll cells, and loosely arranged, irregular and isodiametric spongy mesophyll cells. In monocotyledonous leaf there is no distinction of palisade and spongy parenchyma.

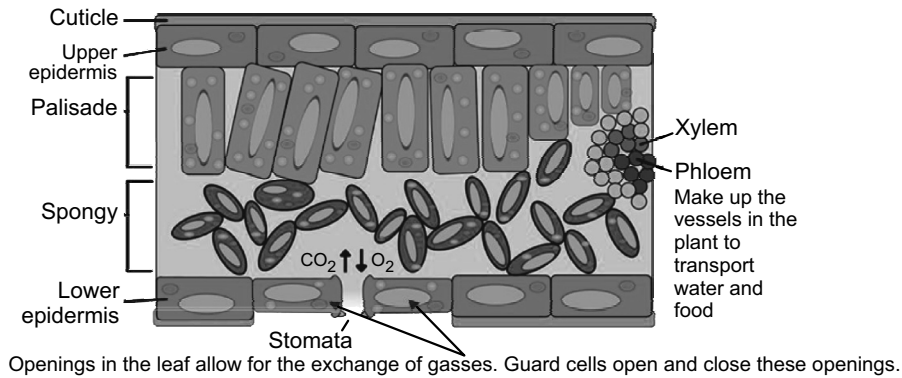

(i) Structure of leaf showing Photosynthetic cells

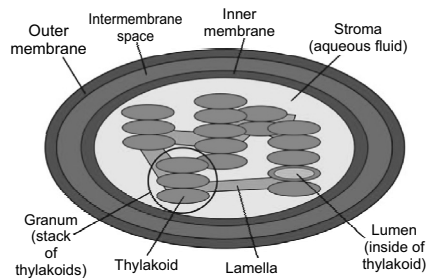

(ii) Em of Chloroplast cells

The mesophyll cells in leaves contain a large number of chloroplasts that transform light energy into ATP and NADPH which are then used to convert CO_2 into sugars.

Chloroplast is the photosynthetic machinery. It is a double membrane organelle that contains a series of parallel membranes called **thylakoids** or **lamellae**, suspended in fluid like matrix called **stroma**. The thylakoids are flattened discs arranged in stacks called **grana**. In a typical chloroplast as many as 40-60 grana may be present and each granum may contain 2-100 thylakoids. The stroma contains DNA, ribosomes, soluble proteins and enzymes, while pigments are confined to thylakoids. Thylakoids have large surface for absorption of light and the space within them '**lumen**' allows rapid accumulation of protons.

11. Autotrophic nutrition is very important. Autotrophic nutrition means that simple inorganic substances are taken in and used to synthesise organic molecules. Most producers use this nutritional method. By far, the greatest energy supply to support food chains and webs is obtained from photo-autotrophic nutrition. As is clear, a food chain is an essential part of sustenance of life on earth with one organism being eaten by another correlating to sustainability. Food chain starts with producers and producers use autotrophic nutrition to synthesise energy.

Environment can be sustained if we:

1. Use energy saving products

One of the biggest impacts on our environment is energy consumption – with workplaces consuming large amounts of resources to operate buildings, including lighting, workstations, kitchen appliances and office equipment. As an eco-conscious workplace standard, we encourage employees to conserve computer energy by switching to sleep mode when possible and shutting the device down at the end of each day.

2. Provide eco-conscious products

Across your workplace, there are many products that can be swapped for eco-friendly, recyclable varieties. For instance, eco-conscious kitchen essentials such as tea and coffee products, paper towels and cups can be supplied as well as cleaning products and eco-stationery products.

3. Participate in recycling programmes

Most workplaces require printing service which is commonly produced by printers with ink toner cartridges. By engaging in a recycling programme such as Cart Collect, your business can sustain the environment by having the cartridges recycled up to eight times. Once the cartridges are no longer recyclable, Staples 100% recycle them into our award-winning Sustainable Earth by Staples™ Calculator and Stapler products.

4. Use our own transportation

Encourage your employees to travel to and from work by foot or non-motorised transportation such as a bicycle, rollerblades or scooter if they live within a feasible distance from your workplace location. Not only is this an eco-conscious Earth Day practice – it can also add to your employee's daily exercise.

5. Keep our workstation clean

In addition to maintaining cleanliness to avoid the spread of germs in the workplace, it's important to monitor workstation appliances for dust and build-up that can occur in the filters which can result in running less efficiently. As a sustainable best practice, we recommend employees maintain a clean workstation and any other facilities that are utilised throughout the workplace.

It is photosynthesis that produces the carbohydrates that you eat and thus, provides the energy you need to live.

Another way to say this is that this carb-making process allows you to obtain the energy from the sun for use as energy in your body.

When you eat a green salad, your body is able to metabolize the carbs by breaking the bonds between the atoms that make up each carb molecule.

In this way, the stored energy is released for use by your cells. Without the energy from the foods you eat, you would not be able to move, breathe, or have a beating heart.

Whether you eat the green part of the plant, such as the stems and leaves of celery or spinach, or the fruit or roots of tomato and carrot plants, you are taking advantage of photosynthesis. It is a miraculous process that we mostly take for granted as we enjoy all of the delicious and nutritious foods it produces.

7.13 ASSESSMENT METHODS

Use observation technique, question answer technique, and demonstration technique to assess the learners' achievement of learning objectives.

7.14 ASSESSMENTS

Formative Assessment

Fill in the blanks:

1. C-4 cycle includes carboxylation.
2. is the graph plot that shows the rate of physiological activity at different wavelengths of light.

Ans. 1. dual, 2. Action spectrum

Summative Assessment

Answer in one word.

1. Wreath of bundle sheath cells around vascular bundles in leaves.
2. Complex of proteins sub-units and photosynthetic.
3. Decrease in the rate of photosynthesis beyond 680nm of light.

Ans. 1. Kranz anatomy, 2. Light harvesting complex, 3. Red drop phenomenon

Unit 8: Transport System in Plants

8.1 LEARNING OBJECTIVES

| Knowledge and Understanding | Skills | Attitudes and Values |
|--|--|---|
| <ul style="list-style-type: none"> • Recall that plants have two transport tissues: xylem and phloem. • Explain the movement of water between plant cells, and between them and their environment, in terms of water potential. • Recall the term transpiration and understand that transpiration is an inevitable consequence of gas exchange in plants. • Explain how hydrogen bonding is involved with the movement of water in the xylem by cohesion-tension in transpiration pull and adhesion to cellulose cell walls. • State that assimilates, such as sucrose and amino acids, move between sources and sinks in phloem sieve tubes. • Explain how transport systems in plants move substances from where they are absorbed or produced to where they are stored or used. | <ul style="list-style-type: none"> • Observe, draw and label, from prepared slides, plan diagrams of transverse sections of stems, roots and leaves of herbaceous dicotyledonous plants to show tissues in correct proportion. • Draw and label, from prepared slides, the cells in roots, stems and leaves using transverse and longitudinal sections. • Recognise, from prepared slides, using the light microscope to draw and label the structure of xylem vessel elements, phloem sieve tube elements and companion cells. • Relate the structure of xylem vessel elements, phloem sieve tube elements and companion cells to their functions. • Experimentally investigate and explain the factors that affect transpiration rate using simple potometers, leaf | <ul style="list-style-type: none"> • Appreciate the importance of transport systems in plants. • Acknowledge that plants do not have systems for transporting oxygen and carbon dioxide. Instead, these gases diffuse through air spaces within stems, roots and leaves. • Show resilience when setting apparatus and making observations using microscopes and solutions of different concentration to ensure improved reliability. • Show concern when selecting crop plants to reflect adaptations to environments e.g., where they grow well, and when under water or not under water stress. |

| | | |
|---|---|--|
| <ul style="list-style-type: none"> • Explain how sucrose is loaded into phloem sieve tubes by companion cells using proton pumping and the co-transporter mechanism in the cell surface membranes. • Explain mass flows in phloem sap down a hydrostatic pressure gradient from source to sink. | <p>impressions, epidermal peels, and grids for determining surface area.</p> <ul style="list-style-type: none"> • Make annotated drawings, using prepared slides of cross-sections, to show how leaves of xerophytes are adapted to reduce water loss by transpiration. • Carry out an investigation to demonstrate mass flow hypothesis. | |
|---|---|--|

8.2 TEACHING AIDS

Visual: Images of transport system.

Audio-video: Video showing transport system in plants.

8.3 TEACHER'S TIP

Teacher starts the unit by briefing the learners about why transport of water and food is necessary. Structure of transport tissues wherein xylem advocates flow of water and phloem transport of food material. How the transport mechanisms in plants transfer xylem sap with water and minerals and phloem sap with amino acids, organic food and proteins. Process of transpiration to counter water stress. Adaptations of plants, especially xerophytes to regulate water loss by transpiration. All mechanisms of transpiration, translocation, ascent of sap involves in transport mechanism through tissues and their cell types.

8.4 TEACHING METHODS

Brainstorming, short lecture technique, group discussion technique, observation technique, drawing technique, demonstration technique, and practical work.

8.5 TEACHING AND LEARNING MATERIALS

Prepared slides of cross-sections of xerophytes, simple potometers, leaf impressions, epidermal peels, grids, cut shoot, light bulb, fan, plant shoot and root from aquatic and dry environments, prepared slides of transverse sections of stems, roots and leaves of herbaceous dicotyledonous plants, prepared slides of xylem vessel elements, phloem sieve tube elements and companion cells and light microscopes.

8.6 TEACHING METHODOLOGY

Teacher initiates the topic by explaining the basics of the transport system in plants.

Teacher also discusses the types of the tissues. Start by asking the learners to tell any of the examples they could cite.

Learners reply to the questions raised by the teacher.

Appreciating them, teacher further asks if they know about ascent of sap or translocation.

Learners will come up with varied answers. Some correct, some near to correct, others being irrelevant.

Teacher will not demotivate the child. But agreeing to the correct answers, dwell further in discussion.

Using short lecture technique, the teacher will explain the importance of transport system.

Teacher further explains the learners the different adaptations and examples related to transport system.

8.7 ADDITIONAL CONTENT FOR THE TEACHER

Activity 1

Aim: Ringing Experiment

Requirements: Two twigs, razor

Procedure

Take two twigs of the plant. Remove a ring of a bark from one twig.

Remove xylem elements from another twig.

Immerse the twigs in separate beakers containing water.

Allow them to stand for sometime.

Observations: In the first twig, leaves are turgid because of continuous water flow while in second twig, leaves show wilting because water does not reach them to keep them turgid.

This demonstrates the ascent of water through xylem. As in the first twig all the tissues except xylem were injured water rose up and in another xylem was injured water did not reach the leaves.

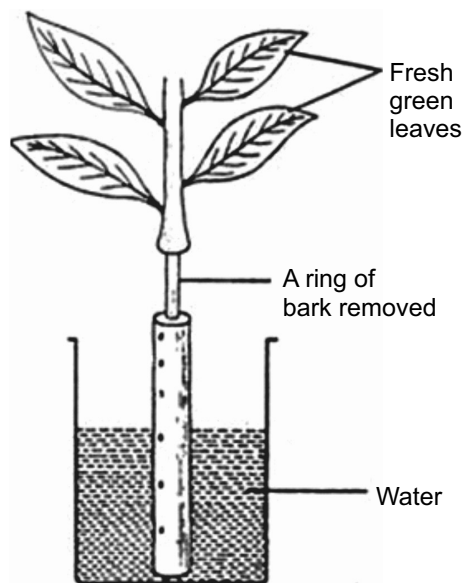

Precautions: The ringing or removal should be done while the twigs are under water.

Activity 2

Aim: Blocking xylem with wax

Requirements: Twigs, Beakers, wax

Procedure

Cut two woody stems with equal number of leaves on them.

Place the cut end of one stem in melted paraffin for an hour.

Take out the stem and allow it to solidify.

Make a fresh cut near the end of the shoot so that the cells are exposed.

Place both the stems in a beaker containing water.

Inference: The shoot that has blocked xylem vessels will wilt, whereas other shoots will not wilt.

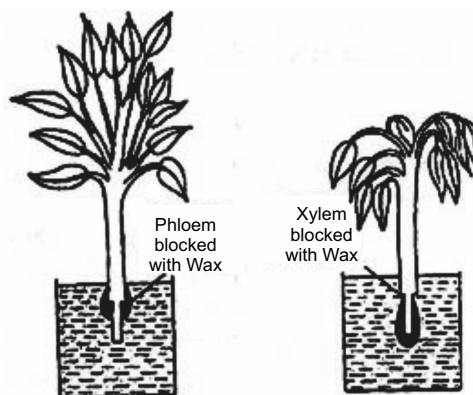

Activity 3

Aim: To study the distribution of stomata on the upper and lower surfaces of leaves.

Requirement

Leaf samples - (Hibiscus/Balsam), microscope, glass slides, cover slips, water, needle, brush, and watch glasses.

Procedure

1. Prepare thin peels of upper and lower epidermis of a grass leaf and of any two dicot leaves by tearing the leaf or with the help of a razor blade and keep the peels in separate watch glasses.
2. Mount the upper epidermal peel in a drop of water taken on a slide.
3. Carefully cover the peel with cover slip so as to avoid air bubbles.
4. Focus the peel under the high power of microscope.
5. Note the presence/absence of stomata seen in the field of the microscope.
6. Count the number of stomata seen in the microscope field.
7. Draw the figure of stomata giving details.
8. Now repeat the same with peels of lower epidermis.

Stomata are tiny microscopic structures present in leaves of all flowering plants. Number and distribution of stomata per unit area is variable in leaves of different plants. A typical stoma consists of a pair of guard cells enclosing an aperture in the centre called the stomatal aperture. Stomata perform two important functions; that of, transpiration and exchange of gases.

Activity 4

Aim: Compare the relative rates of transpiration with the surfaces of a plant (mesophyte and xerophyte) using cobalt chloride paper method.

Take two potted plants and water them. One should be a xerophyte and other a mesophyte.

Requirements: Nerium and Guava

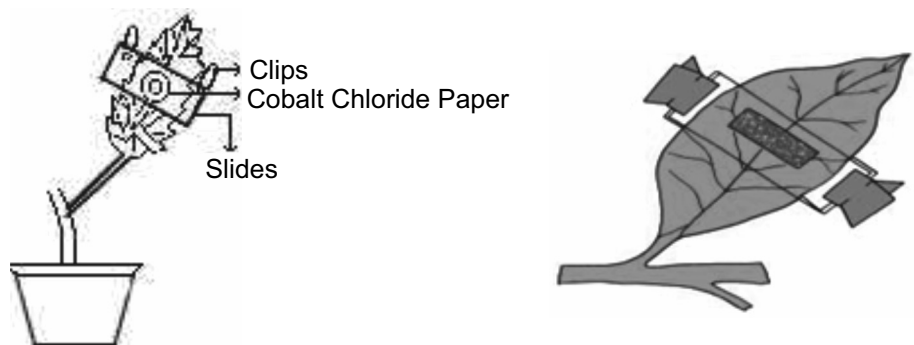

Procedure

Place Cobalt chloride strips (filter paper strips dipped in slightly acidic solution of cobalt chloride), one each on upper and lower leaf surfaces. These should be kept airtight with the leaves. When exposed, cobalt chloride treated paper changes from blue to pink.

Note down the time taken by cobalt chloride paper to change its colour. The rate of colour change is indicative of the rate of transpiration.

Cobalt chloride strips should be stored in a desiccator to avoid exposure to humidity.

Paper strips should be of uniform blue intensity.

8.8 SUMMARY

- Water is an important solvent and acts as a reagent in various chemical reactions in the plants.
- It helps to maintain the turgidity of cells and is important for growth of plants as it serves as a raw material for photosynthesis.

- Transport of water is an important process in plants and has been well understood.
- Several physical phenomena such as imbibition, diffusion, osmosis, turgor and water potential facilitate uptake of water in plants.
- Forces of cohesion and adhesion also play an important role in transport of the water upstream.
- Water enters the plants through active or passive absorption process. The upward movement of water through stem is called ascent of sap.
- Practically, most of the water absorbed by plants is lost into the atmosphere through the process of transpiration.
- A variety of internal and external stimuli govern the rate of transpiration in plants.
- Atmospheric humidity, temperature, light, wind velocity, leaf area, leaf structure and availability of water affect the process.
- Plants also take up inorganic nutrients from the soil with water. The sugars synthesized in leaves are translocated downwards, upwards and to lateral organs mostly through phloem.
- Experiments have been conducted to demonstrate the movement of food through phloem. Besides sugars that are end products of photosynthesis, amino acids are also transported through phloem.

8.9 WEBLINKS FOR CONTENT ENRICHMENT

- http://www.bbc.co.uk/schools/gcsebitesize/science/triple_aqa/transport_systems/transport_in_plants/revision/1
- <https://www.youtube.com/watch?v=bvPM6sfidY4>
- http://www.biology4kids.com/files/plants_xylemphloem.html

8.10 LEARNERS' ACTIVITIES

Activity 1

Step 1: Ask the learners to study the transport system.

Step 2: Guide them to make charts, diagrams or notes and present those to class.

Activity 2

The teacher should assist the learners to perform the activity.

Hint:

1. Take a fresh green plant.
2. Give a cut at the basal end.
3. Put the cut segment in water with natural food colours.
4. Cut a transverse section of the stem and observe under the microscope.

Results

We observe that some parts of the stem appear coloured.

This is because the water is rising through the specialized conducting tissues called the xylem.

Activity 3

The teacher should assist learners to perform the activity.

The best method by which a teacher can demonstrate that the ascent of sap takes through xylem is eosin method.

Hint:

1. Wash the roots of a small potted plant (balsam).
2. Insert the plant in the test tube filled with eosin solution.
3. Plug the mouth of the tube with cotton and fix it on a stand.
4. Observations: After few hours, we can observe that xylem strands of the root appear red.

Inference: This experiment indicates that ascent of sap occurs through xylem.

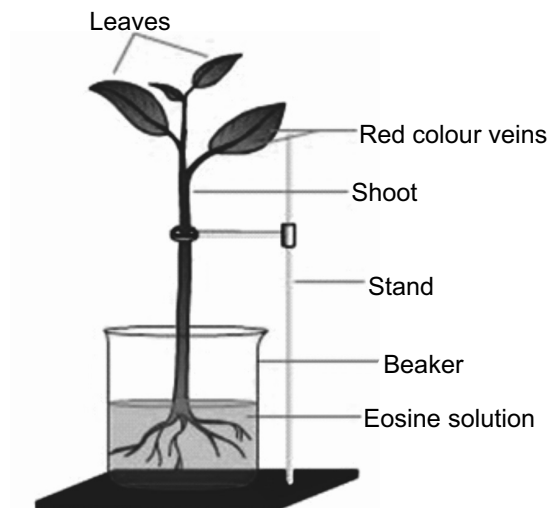

Activity 4

Step 1: Arrange permanent slide VS of leaf. Ask the learners to observe.

Step 2: Ask the learners to discuss their observations.

Activity 5

The teacher should guide the learners to perform the activity.

Hint:

Take a watered healthy plant. Cover the soil by cloth to avoid evaporation.

Place the pot on a glass plate and cover with a bell jar.

Leave the apparatus for some time and observe.

Results: Small drops of water start appearing on the inner side of bell jar due condensation of water vapour transpired from the plant.

The experiment demonstrates the phenomenon of transpiration.

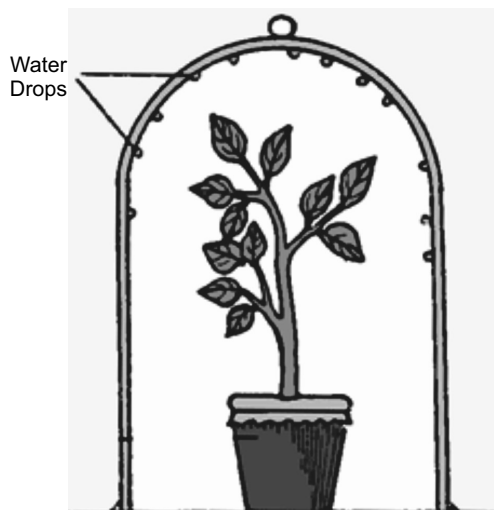

Activity 6

The teacher should introduce the learners to transpiration and perform the following activity.

Hint:

A twig of the plant is filled and sealed in one end of the photometer. The entire apparatus is filled with water so that there are no air spaces in between. The plant is exposed to different light intensities.

The drop in the level of the tube at the other end is measured at different light intensities.

Results

With the increase in light intensity, the level of the water drops indicating increase in the rate of transpiration.

8.11 ANSWERS TO SELF-EVALUATION

Self-evaluation

- (i) tracheids, vessels, parenchyma and fibres
- (ii) absorb, transport
- (iii) active and passive

Self-evaluation

- (i) VAM
- (ii) Transpiration
- (iii) Potometer
- (iv) sunken
- (v) CAM

Self-evaluation

- (i) Translocation
- (ii) leaves, other parts
- (iii) fibres
- (iv) phloem unloading

8.12 ANSWERS TO END UNIT ASSESSMENT 8

I. Multiple choice questions:

1. **(a) Stomata:** These are present on the epidermal layers having guard shaped cells. Stomata open up during the day and during this time maximum transpiration takes place.
2. **(b) root hairs:** Root hairs are epidermal extensions and these root hairs enter inside the pore spaces and act as minute capillaries and water enters through these inside the root cells.
3. **(d) both a and b:** Root pressure that is built up during the process of uptake and transpiration pull both are responsible for water uptake. The water is lost through stomata and thus, the guard cells pull up water from the adjacent cells and thus, a continuous water column is created that helps in the ascent of sap.

4. **(c) turgor pressure of guard cells:** Turgor pressure builds up in the guard cells, pushes the anticlinal walls and helps in opening and closing of stomata.
5. **(a) glucose:** It is the main product that is synthesized during photosynthesis and is stored in the leaves. From here, the glucose is translocated to other parts of the plant.
6. **(b) Diffusion:** It is the process that is involved in movement of particles from the region of higher concentration to the region of lower concentration.
7. **(a) CO₂:** Carbon-dioxide is a gas that is diffused and exchanged by stomata. Rest of the components are transported by phloem.
8. **(c) Transpiration pull:** It makes a continuous column from aerial parts to the underground zone and creates a pull for uptake of water from roots to other aerial parts of the plant.
9. **(d) Transpiration:** the process involved in loss of water vapour through stomata of all aerial parts.
10. **(a) Translocation:** Process involved in transport of food such as sugar from the source to other parts of the plant.

II. Long answer type questions:

1. Vascular system in flowering plants or angiosperms is highly evolved. It is represented by complex tissue system having xylem and phloem elements. There is a division of labour between the two tissue complexes.
Xylem is involved in uptake of water and minerals. Phloem is involved in uptake of food material. These complex tissues are composed of various cell types that play very important role in the transport of water, mineral elements and photosynthates.
2. Diffusion is controlled by various factors such as temperature, density of diffusing substances and concentration gradient. Diffusion is directly proportional to temperature. Temperature increases the average kinetic energy of particles. Greater kinetic energy leads to increased velocities and hence greater collision of particles resulting in increased rate of diffusion. High density regions also have greater rates of diffusion than low density regions. Increased number of particles per unit volume leads to a greater chance of collisions and this leads to increased rate of diffusion.

3. Water molecules possess kinetic energy. In liquid and gaseous form, they are in random motion that is both rapid and constant. The greater the concentration of water in a system, the greater is its kinetic energy or water potential. Pure water has the highest concentration of water molecules. Therefore, it has the highest water potential. When some solute is dissolved into water, the water potential of pure water decreases.
4. (i) Diffusion and Osmosis

| Diffusion | Osmosis |
|---|---|
| It is a movement of molecules from high concentration to low concentration. | It is a movement of molecules from high concentration to low concentration through semi-permeable membrane. |
| It can occur in solids, liquids, and gases. | It occurs in the liquid medium. |
| It does not require any driving force. | It occurs in response to a driving force. |

- (ii) Active and Passive Transport

| Active Transport | Passive Transport |
|--|--|
| Active Transport uses ATP to pump molecules against the concentration gradient. Transport occurs from a low concentration of solute to high concentration of solute. Requires cellular energy. | Movement of molecules down the concentration gradient. It goes from high to low concentration, in order to maintain equilibrium in the cells. Does not require cellular energy. |
| Endocytosis, cell membrane/sodium-potassium pump & exocytosis are active processes. | Diffusion, facilitated diffusion, and osmosis are passive. |
| Transports molecules through the cell membrane against the concentration gradient so more of the substance is inside the cell (i.e., a nutrient) or outside the cell (i.e., a waste) than normal. Disrupts equilibrium established by diffusion. | Maintains dynamic equilibrium of water, gases, nutrients, wastes, etc. between cells and extracellular fluid; allows for small nutrients and gases to enter/exit. No NET diffusion/osmosis after equilibrium is established. |

(iii) Osmosis and Diffusion

| Diffusion | Osmosis |
|--|---|
| Diffusion is a spontaneous movement of particles from an area of high concentration to an area of low concentration. | Osmosis is the spontaneous net movement of water across a semi-permeable membrane from a region of low solute concentration to a solution with a high solute concentration, down a solute concentration gradient. |
| Diffusion mainly occurs in gaseous state or within gas molecules and liquid molecules. (e.g., The molecules of 2 gases are in constant motion and if the membrane separating them is removed the gases will mix because of random velocities.) | It occurs when the medium surrounding the cell has a higher water concentration than the cell. The cell gains water along with important molecules and particles for growth. It also occurs when water and particles move from one cell to another. |
| Doesn't need water for movement. | Needs water for movement. |
| Perfume or air freshener where the gas molecules diffuse into the air spreading the aroma. | Movement of water into root hair cells. |

(iv) Transpiration and Evaporation

| Transpiration | Evaporation |
|--|--|
| It is a physiological process and occurs in plants. | It is a physical process and occurs on any free surface. |
| The water moves through the epidermis with its cuticle or through the stomata. | Any liquid can evaporate. The living epidermis and stomata are not involved. |
| Living cells are involved. | It can occur from both living and non-living surfaces. |

5. Transpirational pull is responsible for the ascent of water in the xylem. This ascent of water is dependent on the following physical factors:
1. Cohesion — Mutual attraction between water molecules.
 2. Surface tension — Responsible for the greater attraction between water molecules in liquid phase than in gaseous phase.
 3. Adhesion — Attraction of water molecules to polar surfaces.

4. Capillarity—Ability of water to rise in thin tubes. These physical properties give water high tensile strength, i.e., an ability to resist a pulling force and high capillarity, i.e., the ability to rise in thin tubes. The thin tubes of xylem work like capillary tubes.
6. The sugars are synthesized by the leaf cells. The high concentration of sugar in the sieve tubes attracts water through osmosis, resulting in high turgor pressure.

7.

| Apoplast | Symplast |
|---|---|
| It is the system of adjacent cell walls that is continuous throughout the plant, except at the casparian strips of the endodermis in the roots. | It is the system of interconnected protoplasts. |
| Water moves through the intercellular spaces and the walls of cells. | Water travels through the cytoplasm of cells and intercellular movement is through plasmodesmata. |
| It is a faster process of water movement and water moves through mass flow. | It is a slower process of water movement. |

8. Water molecules move from the soil into living cells of the root, and eventually into the transport cells of the xylem, known as tracheids and vessels. These xylem cells are dead and hollow, allowing rapid water transport. They also have hardened cell walls to help them resist the tendency to collapse as water is sucked through them. Both tracheids and vessels have pits on the sides of their walls, which include porous areas for side-to-side transport. Unlike tracheids, a vessel is composed of many cells stacked end-to-end, with perforations between cells, allowing for more efficient transport.

The long-distance transport of the water molecule occurs first within the xylem cells of the root, then the xylem of the stem and branch, and then into the xylem of a leaf midrib and vein. Driven by transpiration, the water molecule is pulled from the non-living tracheids and vessels of the xylem in the living cells of the leaf mesophyll (middle layer) and to the surface of mesophyll cell walls. The water molecule then evaporates into a leaf inter-cellular air space and finally out of a **stomatal** pore and into the atmosphere. Though photosynthetic action consumes some water, only a small fraction of the water that travels through the plant is used directly for the photo-synthetic reaction, which occurs in leaf mesophyll cells. Instead, most water is lost by transpiration through the stomata. Thus, a stress is created in adjacent cells that pull water from the nearest cells and hence a pressure or tension is created that draws water from the soil.

9. Phloem is a complex tissue composed of sieve tubes, companion cells, phloem fibres and phloem parenchyma.
 1. **Sieve Tubes:** A sieve tube is a series of cells joined end-to-end. The cross walls between successive cells (sieve elements) become perforated forming sieve plates. The cell walls are thin. Although the cell contents are living, the nucleus disintegrates and disappears. The lumen is filled with a slimy sap which is composed mainly of protein.
 2. **Companion Cells:** Companion Cells are specialized parenchyma cells which always appear with the sieve tube element. They are also elongated, thin-walled and there is a distinct nucleus in the cytoplasm of the companion cell. Companion cells are linked with the sieve tubes by small canals filled with cytoplasm, which are smaller than pits.
 3. **Phloem Fibres:** These cells are elongated tapering cells, found particular in the stem. They have thickened walls.
 4. **Phloem Parenchyma:** Phloem Parenchyma is living and has thin cell walls. These cells form the packing tissue between all the other types of cells.
10. Food is transported by a special mechanism called the pressure flow hypothesis. Pressure flow hypothesis is the one which explain the translocation of food molecules by phloem. The mechanism of translocation involves certain steps. As sugar is synthesized in the leaves by the process of photosynthesis, a high concentration of organic substance inside the phloem cells of the leaf creates a diffusion gradient by which more water is sucked into the cells. Sugar sources are the organs of the plant which synthesize sugars. Sugar sinks are the ones from where the sucrose is removed from the phloem. Hydrostatic pressure increases in the phloem sieve tubes, pressure flow begins and the sap moves through the phloem. Osmotic pressure at the sink is reduced. Sucrose from the phloem sap is removed and given to the cells which utilize it by converting it into energy or starch or cellulose.
11. According to the pressure flow hypothesis, food is prepared in the plant leaves in the form of glucose. Before moving into the source cells present in the phloem, the prepared food is converted into sucrose. Water moves from the xylem vessels into the adjacent phloem, thereby increasing the hydrostatic pressure in the phloem. Consequently, the sucrose moves through the sieve cells of the phloem. The sucrose already present in the sink region is converted into starch or cellulose, thereby reducing the hydrostatic pressure in the sink cells. Hence, the pressure difference created between the source and the sink cells

allows sugars to be translocated from the former to the latter. This starch or cellulose is finally removed from the sink cells through active transport.

12. Plants need some compounds like carbon dioxide through their leaves. They absorb some other materials like compounds of nitrogen, phosphorus, etc. from the soil to their roots.

If the distance between the roots and the leaves is very small, food and other materials can be transported by diffusion. But the distances between different plant parts are often quite large, as in tall trees.

So, most plants need a proper transport system to carry materials from one part to another.

It also provides mechanical support.

- 13.

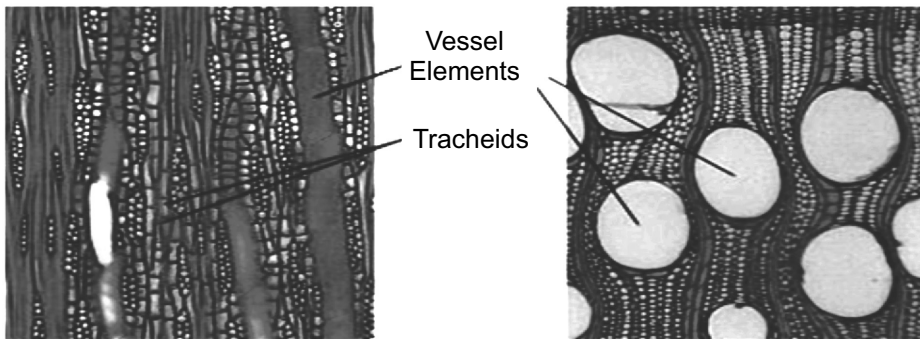

LS of Stem

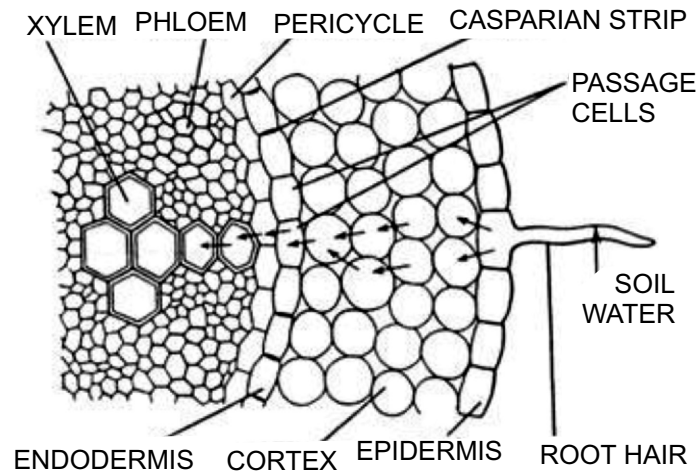

Root

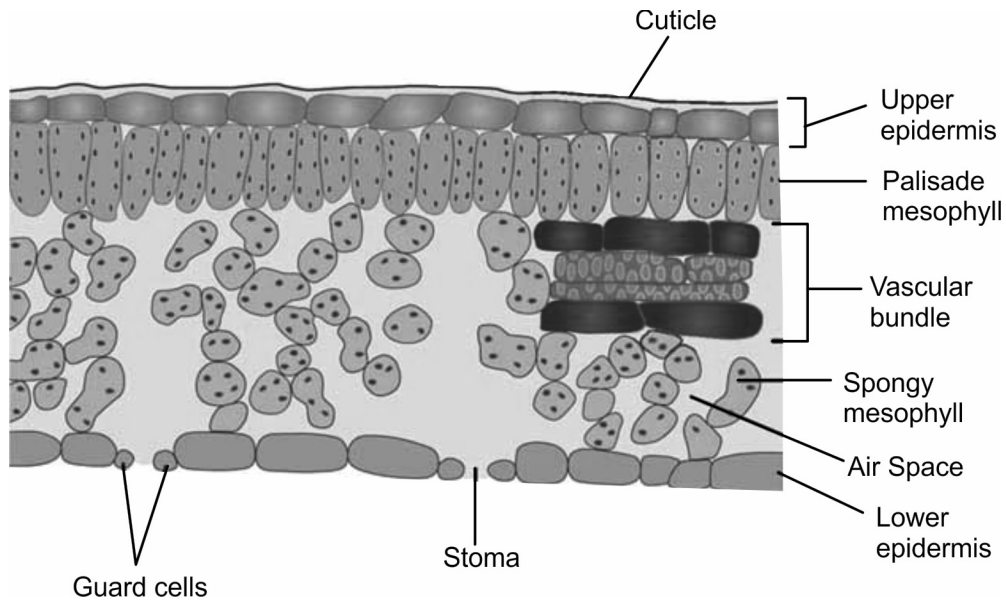

VS of Leaf

14. Forests are important carbon pools which continuously exchange CO_2 with the atmosphere, due to both natural processes and human action. Understanding forests' participation in the greenhouse effect requires a better understanding of the carbon cycle at the forest level.

Organic matter contains carbon susceptible to be oxidized and returned to the atmosphere in the form of CO_2 . Carbon is found in several pools in the forest:

- the vegetation: living plant biomass consisting of wood and non-wood materials. Although the exposed part of the plant is the most visible, the below-ground biomass (the root system) must also be considered. The amount of carbon in the biomass varies between 35 to 65 per cent of the dry weight (50 per cent is often taken as a default value).
- dead wood and litter: dead plant biomass, made up of plant debris. Litter in particular is an important source of nutrients for plant growth.
- soil organic matter, the humus. Humus originates from litter decomposition. Organic soil carbon represents an extremely important pool.

The carbon cycle (photosynthesis, plant respiration and the degradation of organic matter) in a given forest is influenced by climatic conditions and atmospheric concentrations of CO_2 . The distinction between natural and human factors influencing plant growth is thus sometimes very difficult to make.

The increase of CO_2 in the atmosphere has a "fertilizing effect" on photosynthesis and thus, plant growth. There are varying estimates of this effect: + 33 per cent, + 25 per cent, and + 60 percent for trees, + 14% for pastures and crops (IPCC, 2001). This explains present regional tendencies of enhanced forest growth

and causes an increase in carbon absorption by plants. This also influences the potential size of the forest's carbon pool.

In the context of global change, attention has been focused on the increases in CO₂ and temperature, as well as a reduction in the global solar irradiance. In this chapter, we have explored how components of global change such as CO₂, temperature and radiation will affect water uptake by plants. Focus is on how aquaporins will respond to these environmental factors in order to maintain water balance in plants according to the water demand. Plant growth may be stimulated directly by increasing CO₂ concentration, through enhanced photosynthesis, or, indirectly, through induced plant water consumption. However, the fine regulation of aquaporins, also involved in CO₂ transport through membranes are crucial in the control of H₂O and CO₂ diffusion. Raised temperatures may benefit some crops but disadvantage others through increased evapotranspiration and thermal damage. However, in general, plants can develop different adaptive mechanisms in order to avoid water-deficit stress and excess transpiration modulating the hydraulic conductance, which involve the expression and activity of aquaporins. In the same way, the response of plants to the amount of perceived radiation affects water balance.

15. A. Upper epidermis B. Palisade mesophyll
C. Spongy mesophyll D. Lower epidermis
E. Stoma F. Guard cells

8.13 ASSESSMENT METHODS

Use observation technique, question answer technique, and demonstration technique to assess the learners' achievement of learning objectives.

8.14 ASSESSMENTS

Formative Assessment

1. Several physical phenomena such as,,, and facilitate uptake of water in plants.
2. What is the ascent of sap?

Ans. 1. imbibition, diffusion, osmosis, turgor and water potential
2. Water enters the plants through an active or passive absorption process. The upward movement of water through the stem is called ascent of sap.

Summative Assessment

Answer in one word.

1. Pressure flow hypothesis proposed by
2. Phloem transport is

Ans. 1. Munch, 2. bidirectional

Unit 9: Gas Exchange in Animals

9.1 LEARNING OBJECTIVES

| Knowledge and Understanding | Skills | Attitudes and Values |
|--|---|---|
| <ul style="list-style-type: none"> • Describe the tracheal system of insects and relate to its function. • Describe the structure of the gills in relation to function. • Explain the significance of counter current flow in bony fish. • Describe the mode of gaseous exchange in amphibians. • Describe the structure of the human gas exchange system. • Describe the distribution of tissues within the trachea, bronchi, bronchioles and alveoli and relate each tissue to its function. • Explain the mechanism of ventilation in humans. • Explain the process of gas exchange in alveoli with emphasis on diffusion. • Describe the role of the brain in controlling gas exchange in humans. | <ul style="list-style-type: none"> • Dissect an insect, fish and a small mammal to study gaseous exchange organs. • Relate the structure of gas exchange organs to function. • Differentiate between the gaseous exchange in bony fish and that in cartilaginous fish. • Interpret a graph of human lung volumes measured with a spirometer. • Calculate the volume of air in the lungs and in the alveoli. • Analyse and interpret data from a spirometer. • Search and use data to calculate pulmonary ventilation and alveolar ventilation. | <ul style="list-style-type: none"> • Appreciate the similarities and differences in gas exchange surfaces of animals. • Appreciate the role of the brain in controlling gas exchange. |

| | | |
|---|--|--|
| <ul style="list-style-type: none"> • Define terms related to the lung capacities (tidal, reserve volume, vital capacity, residual volume, and dead air space). • Describe how a spirometer can be used to measure vital capacity, tidal volume, breathing rates, and oxygen uptake. | | |
|---|--|--|

9.2 TEACHING AIDS

Visual: Images of gaseous exchange of organisms.

Audio-video: Video showing mechanism of ventilation.

9.3 TEACHER'S TIP

Teacher starts the unit by briefing the learners about the need for gaseous exchange. From prior knowledge we know that there are special organs in different organisms to respire as fishes have gills, humans have lungs. Similarly, gaseous exchange occurs in insects with specialised organs. Dwell on the respiratory surfaces and mechanism of breathing in different organisms. Correlation of gaseous exchange in different organisms and then with the human gaseous exchange system. Controlling the ventilation rate in humans and capacities of lungs. Teacher can also state the role of nervous system in controlling breathing.

9.4 TEACHING METHODS

Brainstorming, short lecture technique, group discussion technique, observation technique, drawing technique, demonstration technique, and practical work.

9.5 TEACHING AND LEARNING MATERIALS

Models, computer simulations and illustrations, live specimens of animals (locust/cockroach, tilapia, frog/toad, rat/rabbit), spirometer (or model of a spirometer), and spirometer traces for analysis.

9.6 TEACHING METHODOLOGY

Teacher initiates the topic by introducing the basic vocabulary about gaseous exchange. Organs involved in gaseous exchange.

Teacher also discusses the respiration in insects and fishes. Start by asking the learners to tell any of the respiratory organs.

Learners reply to the questions raised by the teacher.

Appreciating them, the teacher further asks if they are aware of ventilation mechanisms. Learners will come up with varied answers. Some correct, some near to correct, others being irrelevant.

Teacher will not demotivate the learner. But agreeing to the correct answers, dwell further in discussion.

Using a short lecture technique, the teacher will explain the importance of gaseous exchange.

Teacher further explains the learners the different mechanisms in insects, humans and fishes.

9.7 ADDITIONAL CONTENT FOR THE TEACHER

- **CRD.** Chronic respiratory disease.
- **COPD.** Chronic obstructive pulmonary diseases, e.g., asthma, chronic bronchitis, emphysema, etc.
- **Snoring.** A rough rattling inspiratory noise produced by vibration of uvula or sometimes of vocal cords during sleep. It is due to partial blockage of upper respiratory tract by the tongue, leading to turbulence in the air flow. Snoring is also called **Sleep Apnoe Syndrome (SAS)**.
- **Yawning.** A prolonged inspiration through widely opened mouth producing an exaggerated depression of the lower jaw. May be stimulated by drowsiness or fatigue. Low oxygen tension in the blood may cause yawning.
- **Sneezing.** Spasmodic contraction of muscles of expiration forcefully expels air through the nose and mouth. An irritation may stimulate the nasal mucosa to cause sneezing.
- **Hiccough.** Spasmodic contraction of the diaphragm followed by a spasmodic closure of the glottis produces a sharp **inspiratory sound**. Usually, an irritation of the sensory nerve endings of digestive tract causes hiccough.
- **Coughing.** Preceded by a long-drawn and deep inspiration that is followed by a complete closure of the glottis resulting a **forcible expiration** suddenly pushes glottis open and sends a blast of air through the upper respiratory passages. The stimulus for this reflex act could be a foreign body lodged in the larynx, trachea or epiglottis.
- **Respiratory Pigments.** (i) **Hemoglobin.** Iron containing pigment, occurs in the plasma of some annelids (e.g., earthworm, Nereis) and in RBCs of all

vertebrates. (ii) **Hemocyanin** copper containing pigment, occurs in the plasma of crustaceans (e.g., prawn, some snails (e.g., Pila) and cephalopods (e.g., Sepia). (iii) **Hemoerythrin**. Iron containing pigment, occurs in blood cells of some annelids (e.g., polychaeta Magelona). (iv) **Chlorocruorin**. Iron containing pigment, occurs in plasma of some annelids (e.g., polychaete Sabella) (v) **Pinnaglobin**. Manganese containing pigment, occurs in the plasma of some molluscs (e.g., Pinna) (vi) **Echinochrome**. Iron containing pigment, occurs in the coelomic fluid of some echinoderms (e.g., sea urchin) (vii) **Vanadium**. Vanadium containing pigment, occurs in many tunicates (= Urochordates).

- **Hemoglobin of Muscles**. Refers to the muscle protein **myoglobin** that helps to store oxygen temporarily in the muscles.
- **Diving Mammals**. Diving mammals (e.g., seals, whales) stay under water for a long time, because they can store oxygen in the blood and muscles. They have comparatively more blood and more oxygen storing protein, the **myoglobin** in the muscles than other mammals. They also have a larger spleen that releases blood when a dive begins. Their heart rate and oxygen consumption decrease during dive to conserve oxygen.
- **Foetus Hemoglobin**. The haemoglobin of a foetus has a higher affinity for oxygen than the mother's haemoglobin. After birth, foetal haemoglobin is gradually replaced by adult haemoglobin.
- **Human Skin** may also be considered a respiratory organ, as it eliminates some carbon dioxide in the sweat.
- **Severe Acute Respiratory Syndrome (SARS)**. A communicable disease of respiratory system caused by Human coronavirus (HCV) characterised by cold, dry cough, headache, high fever and hypoxia followed by muscular stiffness and bodily discomfort.
- **Pasteur Effect**. When oxygen is added to an anaerobic cell using glucose at a high rate glucose consumption declines significantly.

Activity

The teacher can demonstrate this activity in the class.

Aim: To make the learners understand breathing.

Refer to text and make the learners read.

Ask each learner to choose one topic and present in class.

Ask them to research and brainstorm on the same.

9.8 SUMMARY

- Aerobic animals require a continuous supply of oxygen for metabolic processes and also removal of metabolic waste (CO_2) from its body.
- This is achieved by developing a complex system of gas exchange in every animal.
- Gaseous exchange takes place by the process of diffusion where it moves from a place of higher concentration to a place of lower concentration.
- Small invertebrates like insects have a vast network of 'tubes' made of chitin called the tracheal system spread all over their body which is used for exchange of gases.
- The tubes or trachea branches and interbranches to form fine tubes called tracheoles innervating tissues at cellular level. Air enter and leaves through openings called spiracles.
- In aquatic animals like fish and some amphibian larvae exchange of gases takes place through special structures called gills.
- Gills can be external or internal depending on its location in the body. Gills are highly vascular, thin and always ventilated with water.
- A holobranch or complete gill refers to a branchial arch and the lamellae on both anterior and posterior faces of its septum. A gill arch with lamellae on only one face is a hemibranch.
- Ventilation of gills in fish is achieved by the coordinated action of the buccal cavity and the operculum or gill cover.
- Countercurrent mechanism of gas exchange is present in gills of teleost. It is a very efficient mechanism of gas exchange and almost 85% of oxygen is extracted from water.
- Amphibians can respire through skin (cutaneous respiration), gills or the lungs.
- Exchange of gas in the skin, gills or the lungs takes place by diffusion of gas (O_2) from air or water to the blood capillaries in the skin or the septal walls of faveoli.
- In humans, exchange of gases takes place through the lungs. The lungs are elastic structures. The lungs, the airways leading to them, and the chest structures responsible for movement of air into and out of the lungs.
- The conducting zone of the airways consists of the trachea, bronchi, and terminal bronchioles. The respiratory zone of the airways consists of the alveoli, which are the sites of gas exchange.

- The alveoli are lined mostly by type I cells along with some type II cells, which produce surfactant.
- The lungs are covered by pleura and between the two pleural layers is an extremely thin layer of intrapleural fluid.
- During inspiration, the contractions of the diaphragm and inspiratory intercostal muscles increase the volume of the thoracic cage causing atmospheric air to rush into the lungs.
- During expiration, the inspiratory muscles cease contracting, allowing the elastic recoil of the chest wall and lungs to return them to their original between-breath size resulting in air moving out of the lungs through the nose.
- The vital capacity is the sum of resting tidal volume, inspiratory reserve volume, and expiratory reserve volume.
- Gases diffuse from a region of higher partial pressure to a region of lower partial pressure. Exchange of gases in lungs and tissues takes place through the process of diffusion because of the differences in partial pressures of gases.
- There is net diffusion of oxygen from alveoli to blood and of carbon dioxide from blood to alveoli when systemic venous blood flows through the pulmonary capillaries.
- In certain conditions like when the alveolus capillary surface area is decreased or when the alveolar walls thicken inadequate gas exchange between alveoli and pulmonary capillaries may occur.

9.9 WEBLINKS FOR CONTENT ENRICHMENT

- <http://www.slideshare.net/acloving/gas-exchange-in-animals-by-madeleine>
- https://en.wikipedia.org/wiki/Gas_exchange
- <http://www.shmoop.com/animal-movement/animal-respiration.html>

9.10 LEARNERS' ACTIVITIES

Activity 1

The teacher asks the learners to observe their breath.

Hint:

Air breathing animals (aerobic) requires a continuous supply of oxygen for various metabolic activities. They also require continuous removal of carbon dioxide formed as a by-product of these metabolic activities. This process of gas exchange is vital for their survival. This continuous 'exchange' of oxygen and carbon dioxide with the animal and the environment is known as **gas exchange**. For a surface to be able to exchange gases in living system, it should be moist, have large surface area, and

highly vascular i.e., richly supplied with blood vessels. Exchange of gases through the biological membrane occurs by a process known as **diffusion**. Diffusion is a movement of gas molecules from a region of higher concentration to a region of lower concentration.

Activity 2

The teacher should guide the learners to perform the activity.

Hint:

The tracheal system is easily identified by its silvery appearance due to entrapped air in it. The following diagram may be useful in locating the tracheal system correctly in cockroach and locust.

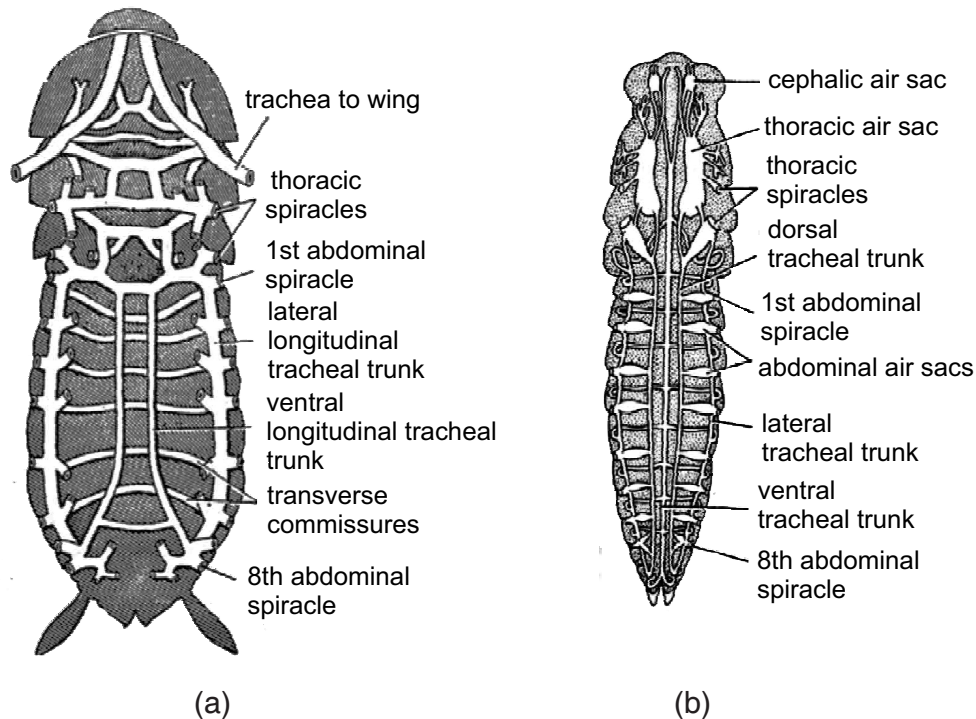

Tracheal system in (a) cockroach (*Periplaneta americana*) and (b) Grasshopper

Activity 3

The teacher should guide the learners to perform the following activity.

Hint:

In freshwater fish, the gills lie in a branchial chamber covered by a bony operculum. Most fish have five pairs of gills. The operculum is important in adjusting the pressure of water inside of the pharynx to allow proper ventilation of the gills. Follow the textbook for further details. The teacher should help the learners in dissecting out the gills and observing and identifying different parts.

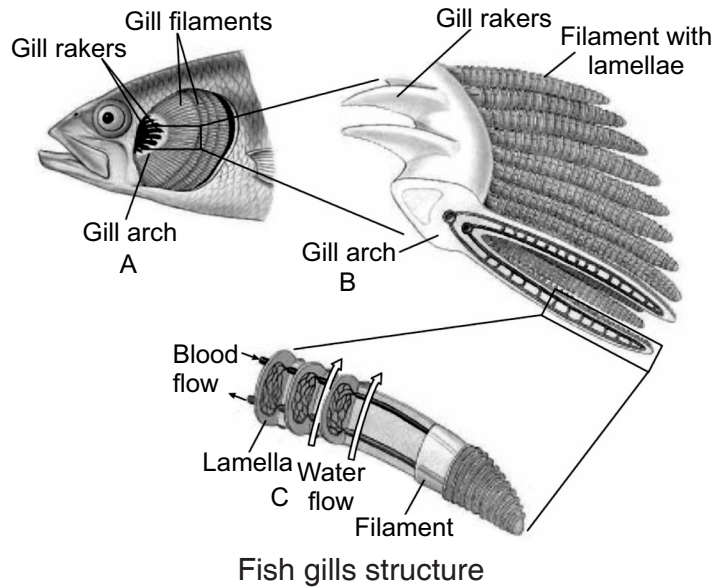

Fish gills structure

Activity 4

The teacher should assist the learners to perform the activity.

Hint:

Learners should observe how the fish opens and closes its mouth and opercular chamber in a coordinated way to achieve ventilation. They can also count the number of times this cyclic closing and opening happens in a minute and report in their record book. The path of the movement of water can be explained by the teacher by using simulation and diagrams.

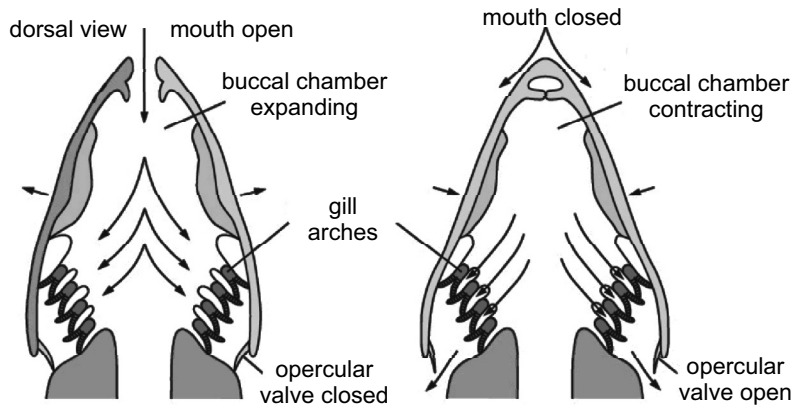

Gill ventilation in fish

Ventilation in frogs is achieved by movement of the buccal chamber. The alternate enlargement and relaxation of the buccal chamber must be observed by the learners and reported. They can record the number of times this happens in a minute and draw a representative diagram of the same.

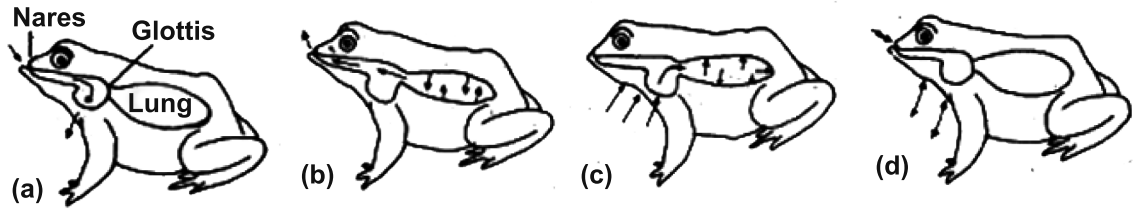

Lungs ventilation in frog.

Activity 5

The teacher should guide the learners to perform the activity.

Hint:

The learners should be explained the difference between the countercurrent and concurrent flow and also the advantages of counter current flow over the other using animations diagrams and videos.

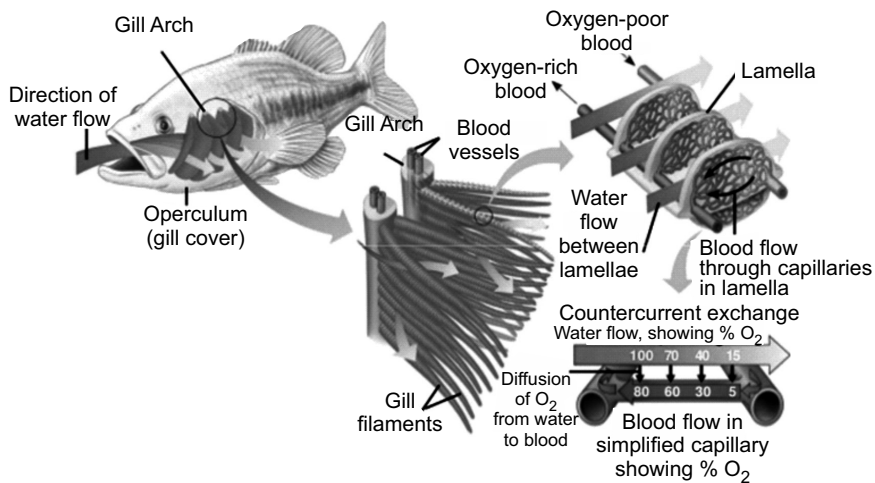
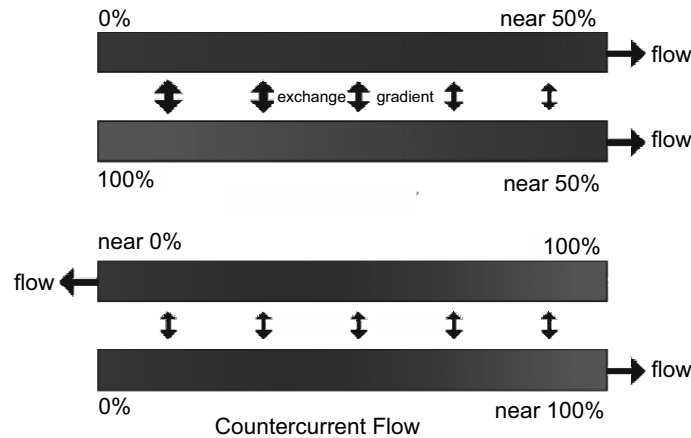

Countercurrent flow mechanism in fish gills

Activity 6

The teacher should guide the learners to perform the activity.

Hint:

The respiratory or gas exchange organs in frogs are the skin and lung. Learners should be explained the difference between the two taking help from the text. The nature of the respiratory surface i.e., smooth, moist and highly vascular nature can be explained by making the learners actually touch and observe in vitro. Finally, learners can be asked for the difference between the two. The nature of mouth closing and opening for ventilation should be observed.

Activity 7

The teacher should guide the learners to perform the activity.

Hint:

The aim of the experiment is to make the learners aware of the morphology and anatomy of the human respiratory system. Videos and animation of the lungs and the associated organs downloaded from the internet may be helpful in making the learners understand the actual 3D structure of the lungs. Animation on the alveoli and the exchange of gases can give a better understanding of the complex process of gas exchange involving diffusion.

After studying the videos and animations, the learners should be able to make clay models of the respiratory system and distinguish different parts.

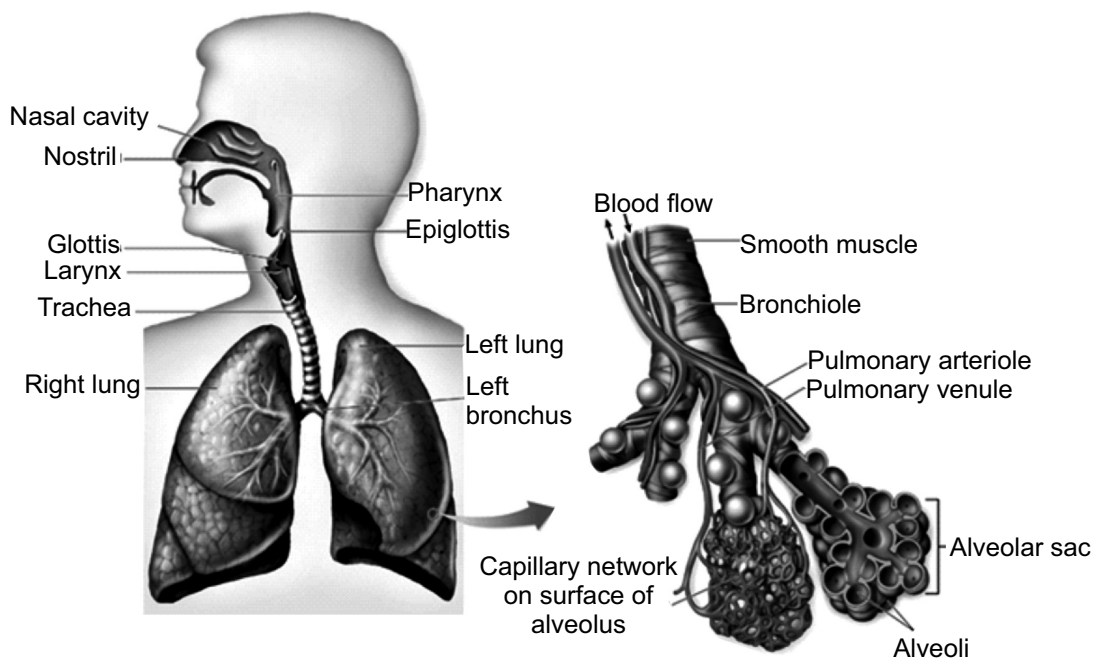

Structure of lungs in humans.

Activity 8

The teacher should guide the learners to solve the following questions on their own.

Hint:

$$\begin{aligned}\text{Pulmonary ventilation (ml/min)} &= \text{Tidal volume} \times \text{Respiratory rate} \\ (\text{ml/breath}) & \qquad \qquad (\text{breath/min}) \\ &= (550 - 185) \times 17 \text{ ml/min} \\ &= 365 \times 17 \text{ ml/min} \\ &= 6205 \text{ ml/min}\end{aligned}$$

$$\begin{aligned}\text{Alveolar ventilation (ml/min)} &= (\text{Tidal volume} - \text{Dead space}) \times \text{Respiratory rate} \\ (\text{ml/breath}) & \qquad \qquad (\text{ml/breath}) \qquad \qquad (\text{breath/min}) \\ &= (550 - 185) \times 17 \text{ ml/min} \\ &= 365 \times 17 \text{ ml/min} \\ &= 6205 \text{ ml/min}\end{aligned}$$

(i) $PV = 550 \times 17 = 9350 \text{ ml/min}$

$$MV = (550 - 185) \times 17 = 365 \times 17 = 6205 \text{ ml/min}$$

(ii) $PV = 600 \times 15 = 9000 \text{ ml/min}$

$$MV = (600 - 195) \times 15 = 405 \times 15 = 6075 \text{ ml/min}$$

(iii) $PV = 550 \times 20 = 11000 \text{ ml/min}$

$$MV = (550 - 175) \times 20 = 375 \times 20 = 7500 \text{ ml/min}$$

Activity 9

The teacher should guide the learners to perform the activity.

Hint:

The aim of this experiment is to make the learners understand the basic principle behind the working of a Spirometer. Learners must be given prior information about the instrument by the teacher. Spirometers are used to measure the amount of air that fits in your lungs and how much air you normally inhale and exhale. Learner must also be given theoretical explanations about the different lung volumes and capacity. This is essential for better understanding of the experiment. Once that is done, the experiment can be performed under the supervision of a teacher.

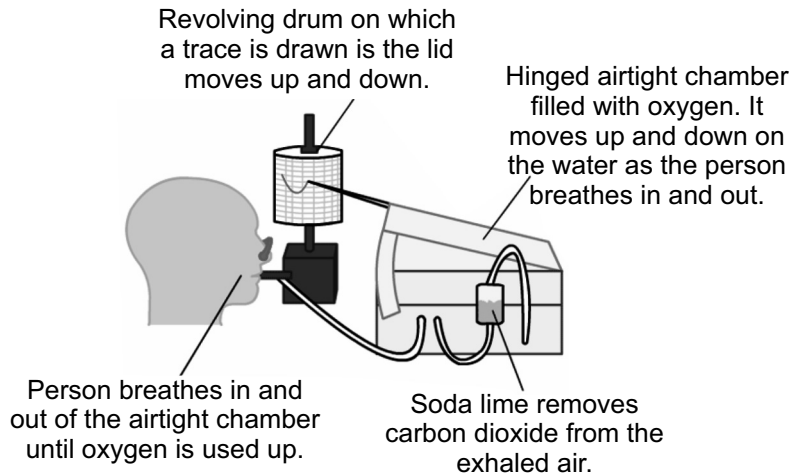

The principle behind a spirometer.

Activity 10

The teacher should assist the learners to solve the following on their own.

Hint:

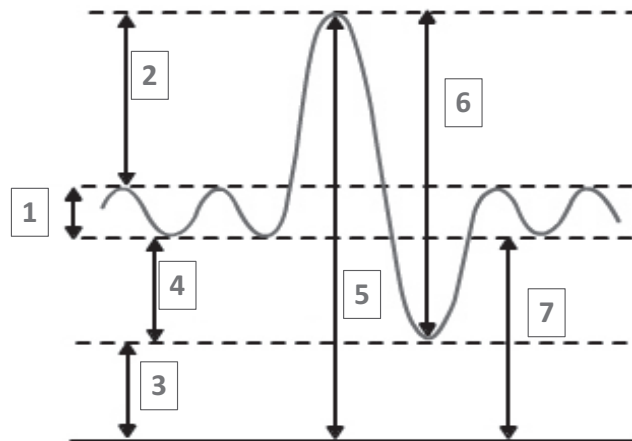

Ans.

- 1 = Tidal Volume
- 2 = Inspiratory Reserve Volume
- 3 = Residual Volume
- 4 = Expiratory Reserve Volume
- 5 = Total Lung Capacity
- 6 = Vital Capacity
- 7 = Functional Residual Capacity

Activity 11

Teacher must make sure that learners have studied the role of brain in controlling the gas exchange system in humans from the textbook.

Hint:

Groups of learners can be made and each group representing an area of the respiratory centre in the brain. Now each group can give a presentation (either orally or with the help of slide) on the role of each part. Animations and videos can be downloaded from the internet for better understanding of the learner and the teacher can show them in the class.

9.11 ANSWERS TO SELF-EVALUATION

Self-evaluation

- (i) Oxygen and carbon dioxide
- (ii) Countercurrent mechanism
- (iii) cartilaginous
- (iv) insects
- (v) rhythmic contraction, relaxation of body wall

Self-evaluation

- (i) cutaneous
- (ii) lungs
- (iii) faveoli

Self-evaluation

- (i) alveoli
- (ii) tracheae
- (iii) epithelium, supporting lamina propria
- (iv) type I alveolar cells, type II alveolar cells

Self-evaluation

- (i) vital capacity
- (ii) breathing
- (iii) inhalation

Self-evaluation

- (i) Spirometer
- (ii) medulla oblongata, pons
- (iii) Apneustic area

9.12 ANSWERS TO END UNIT ASSESSMENT 9

I. Choose whether the following statements are True or False (F):

1. **True;** Insects have a specialised system of 'tubes' called the tracheal system for exchange of gases.
2. **False;** Normally there is no active ventilation in most treacheates.
3. **True;** Gills are more developed in fishes. Fish gills consist of thousands of highly specialised gill lamellae enclosed in a gill cavity.
4. **True;** Amphibians use the moist skin, gills or the lungs for gas exchange.
5. **False;** Modern amphibians rely heavily on cutaneous respiration.
6. **True;** Most adult amphibians have lungs for breathing air.
7. **True;** Internal (tissue) respiration is the exchange of gases between blood in systemic capillaries and tissue cells. In this step, the blood loses O₂ and gains CO₂.
8. **True;** Alveoli are the thin membrane respiratory sacs in lungs through which exchange of gases takes place.
9. **True;**
10. **False;** The sum of inspiratory reserve volume, tidal volume, and expiratory reserve volume is called as Vital capacity.

II. Long answer type questions:

1. Insects have a specialised system of 'tubes' called the tracheal system for exchange of gases. This system consists of a vast network of cuticular (*i.e.*, made of chitin, a long-chain polymer of an n-acetyl glucosamine) tubes penetrating to almost each individual cells of the body. This system serves two functions: it brings air into the body, and also distributes it to the cells. This pattern of tracheal system is very much similar to the system of blood vessels in higher animals.

Air enters the tracheal system of the animal through special openings called spiracles. These are present mostly on the lateral side of the animal. These are usually guarded by valves, operated by muscles and sometimes provided with filters. Tracheal tubes are invaginations (infoldings) of the body surface. Thus, their walls are similar in structure and composition to the general body surface (integuments) of the animals. Sometimes larger tracheas have thickenings called taenidia. These are spiral cuticular layers which give strength and elasticity. The tubes become progressively smaller and thinner to form tracheoles or air capillaries. The smaller tubes may have incomplete taenidial support.

They have a diameter of less than 1 μm (1 $\mu\text{m} = 1 \times 10^{-6}$ m). Tracheoles are the most important physiological unit of this gas exchange system. It is because they make numerous close contacts with the individual cells for gas exchange to take place. They sink into cell's plasma membrane bringing oxygen very close to the mitochondria of the cells.

Mechanism of Ventilation in Insects

Normally there is no active ventilation in most tracheates (i.e., animals possessing trachea). Many of the tracheates (like onychophora, myriapoda, and insect larvae and pupae) depend on simple diffusion of gases in the air tubes. But ventilation and control of direction and volume of the air flowing through the system is present in adult insects. This is because adult insects are larger and so have higher metabolic rate which demands more oxygen. The spiracles and air sacs help the insect in ventilation and creating unidirectional flow of air. In grasshopper, thoracic spiracles are used for inspiration while abdominal spiracles are used for expiration. This creates a unidirectional flow of air. Air sacs greatly increase the efficiency of ventilation. These are balloon-like structures of the trachea with a variety of sizes and shapes. Active ventilation is brought about by rhythmic contraction and relaxation of body walls. This forces the air movement in and out of the tracheal system. Dorso-ventral flattening of abdomen is observed in grasshopper and beetles.

2. Gills are typical respiratory organs of aquatic animals, including fishes. Gills range in shape and size. It may be finger like projections or simple epithelial extensions. Gills are more developed in fishes. Fish gills consist of thousands of highly specialised gill lamellae enclosed in a gill cavity. The gill cavity is covered by an operculum and continuously ventilated by flowing water. Respiration through gills is also known as branchial respiration. All gill surfaces are provided with a dense network of thin capillary vessels and supported by skeletal elements called the branchial arches.

Types of Gills

Gills can be of two types:

External gills: These gills are exposed to the environment and not enclosed within a pouch or cavity. They are found in the larvae of many vertebrates, including lungfishes, actinopterygians, and amphibians.

Internal gills: Gills are covered and protected laterally by soft skin folds, like the interbranchial septum in cartilaginous fishes, or by a firm operculum in many bony fishes. They are found within pharyngeal gills slits or pouches of most cartilaginous and bony fishes. In cartilaginous fishes, the gills are found

on the lateral side of the branchial arch. Gills are usually five pairs in number. They are located in vertical, anteroposteriorly compressed branchial chambers or gill pouches. Each branchial pouch is separated from each other by a stout interbranchial septum. This septum is made up of fibro-muscular tissue with blood vessels.

A branchial pouch communicates to exterior with the help of narrow external branchial aperture or gill slits. Each gill has a central partition called the interbranchial septum. Within this septum, a stiff structure called gill ray gives support to the gills. This septum is covered on each face by primary lamellae or gill filaments. Gill filaments are series of raised thin, highly vascular horizontal lamellar folds of the interbranchial septum. The primary lamellae are again made up of standing rows of secondary lamellae. Water flows across their sides to irrigate the gills.

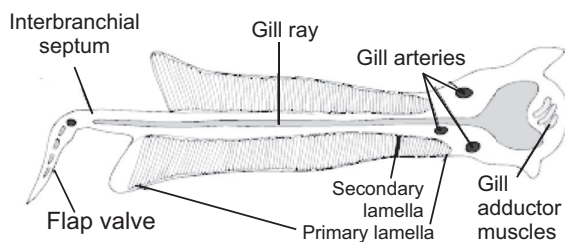

(a)

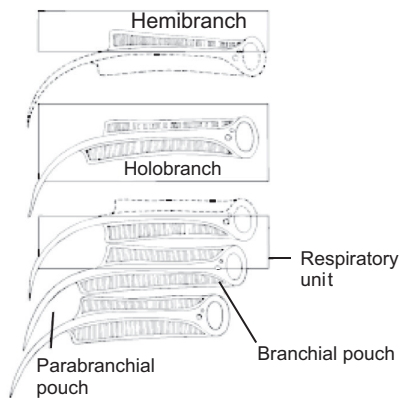

(b)

When gill lamellae are present on both anterior and posterior sides of a septum, it is called a holobranch or complete gill. However, when lamellae is present on only one face, it is called a hemibranch. Facing plates of lamellae on adjacent gills constitute a respiratory unit. A branchial pouch therefore consists of posterior hemibranch of one gill and anterior hemibranch of the succeeding gill. The pharyngeal structural region in bony fishes is almost similar to that of cartilaginous fishes. The gill/branchial chamber on each side is covered by a fold of integument called the operculum (gill covering). It is supported by

four opercular bones. The operculum protects the branchial arches and its gill lamellae and also helps in gill ventilation. There are five pairs of gill pouches and four pairs of holobranches or complete gills. In cross section, each gill is V-shaped and composed of primary lamellae (gill filaments) that are subdivided into secondary lamellae and supported on a branchial arch.

3. Significance of countercurrent mechanism in bony fishes

- A larger difference in PO_2 (i.e., partial pressure of O_2 ; the pressure of a specific gas in a mixture is called its partial pressure) can be maintained across the exchange surface. The larger the difference, the more the exchange of gases; thus, allowing more transfer of gas.
- The system is so efficient that in some teleost 85% of oxygen may be extracted from water passing over the gills using this system.
- This type of exchanger is also found in temperature control system of cold arctic animals, in air bladders of fish and even in the kidneys of vertebrates.
- A few fish have some warm tissues. For example, Tuna have warm muscles, eyes, and brains. This is only possible because of a countercurrent blood supply to selected tissues.

4. Amphibians use the moist skin, gills or the lungs for gas exchange (Figure 9.8). Gas exchange occurring through the skin is known as cutaneous respiration. In some larval Salamanders and adults, external gills are also used for respiration. Modern amphibians rely heavily on cutaneous respiration. Sometimes, they develop accessory skin structures to increase the surface area available for gas exchange.

The amphibian skin is thin, moist, and rich supplied with capillaries making it best suited for gas exchange by diffusion.

In aquatic amphibians, pharyngeal slits often persist with internal gills. Feathery external gills are often present especially among larval amphibians.

Most adult amphibians have lungs for breathing air. Normally, the respiratory surface within the lungs on the anterior region is more developed than the posterior along the inner walls. The inner surface of lungs forms partitions and divide to increase the surface area for gas exchange. Such a surface is called septal. The interconnecting septa divide the internal wall into compartments called faveoli. These faveoli open into the central chamber within each lung. Faveoli differ from the alveoli of mammalian lungs. Alveoli are found at the end of a highly branched tracheal system but faveoli are not. Faveoli are internal subdivisions of the lung wall that open into a common central chamber. Inspired air travels along the trachea into the central lumen of the lung and from here diffuses into the surrounding faveoli. Capillaries located within the thin septal walls of the faveoli take up oxygen and give up carbon dioxide.

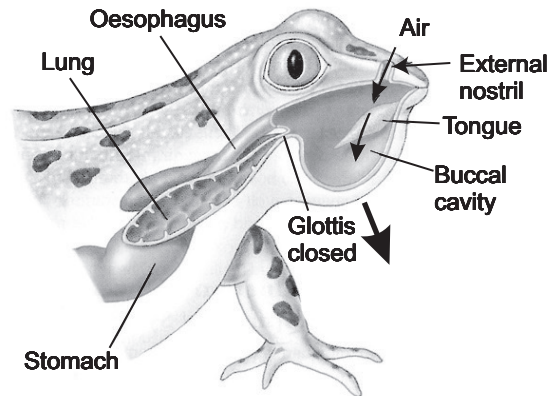

5. Air is inhaled through the nose into the pharynx (throat). Pharynx is a common passage for both air and food. The pharynx branches into two tubes, the oesophagus or food pipe and the larynx. The larynx is a part of the airways and it houses the vocal cords. The nose, mouth, pharynx, and larynx are also called the upper airways. The larynx opens into a long tube, the trachea. The trachea then branches into two bronchi, the right primary bronchus enters the right lung and the left primary bronchus enters the left lung. The walls of the trachea and bronchi contain cartilage, which supports them and gives them their characteristic cylindrical shape. The right primary bronchus is more vertical, shorter, and wider than the left. Within each lung, the bronchi branches continuously into narrower, shorter, and more numerous tubes, more than 20 generations of branching.

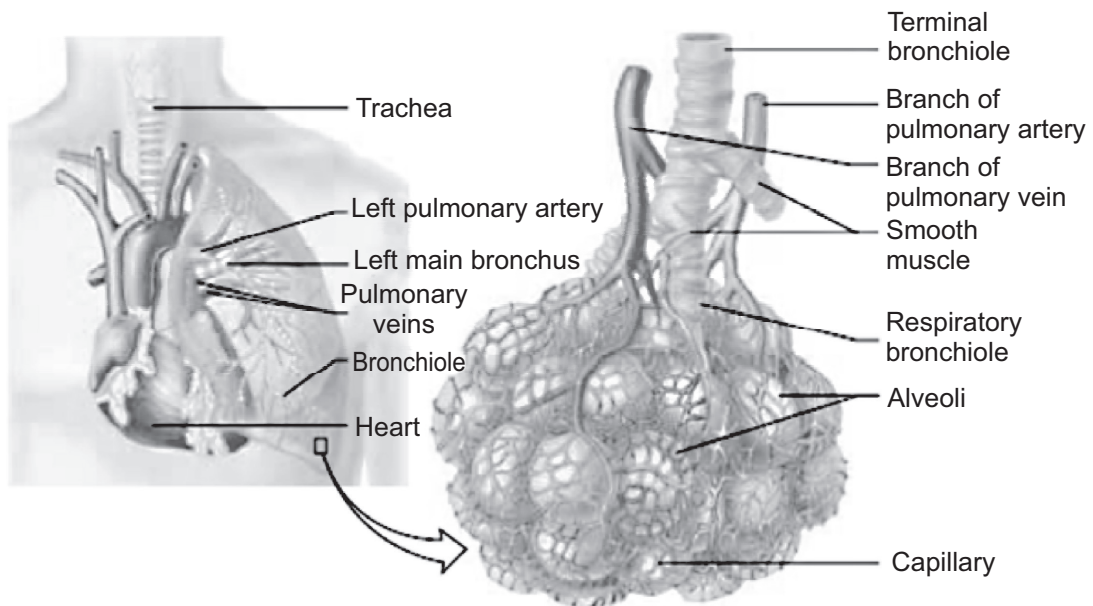

(a)

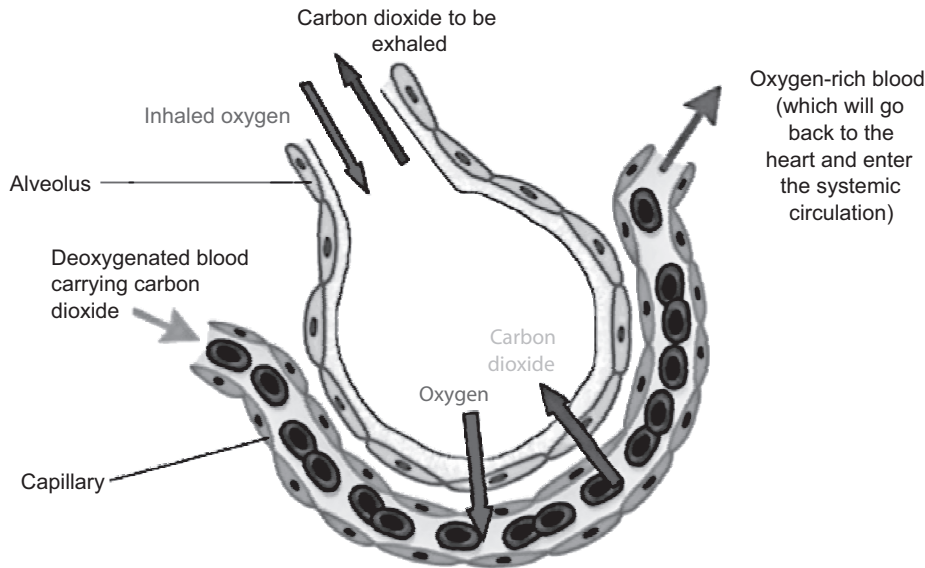

(b)

The primary bronchi divide to form smaller bronchi which are known as the secondary (lobar) bronchi, one for each lobe of the lung. The secondary bronchi continue to branch, forming still smaller bronchi called tertiary (segmental) bronchi. Tertiary bronchi divide to form smaller bronchioles. Bronchioles are without cartilage. Alveoli (explained later) first begin to appear in them attached to their walls. Alveoli normally form grapelike clusters terminally. The airways are surrounded by smooth muscle whose contraction or relaxation can alter the airway radius. Bronchioles in turn branch repeatedly, and the smallest ones branch into even smaller tubes called terminal bronchioles. This extensive branching from the trachea resembles an inverted tree and is sometimes commonly referred to as the bronchial tree.

The lung is a paired cone-shaped organ in the thoracic cavity. The lungs extend from the diaphragm to just slightly superior to the clavicles (collarbone). They are guarded by the ribs anteriorly and posteriorly. The mid region of left lung also has concavity called the cardiac notch, in which the heart lies. This makes the left lung about 10% smaller than the right lung. Each lung is divided into several lobes; three lobes in right and two in left lungs. Tiny air containing sacs called alveoli (singular, alveolus) arranged like bunch of grapes at the end of each bronchioles are the respiratory unit of the lungs.

Alveoli are approximately 300 million in number in an adult and are the actual sites for gas exchange. Each lung is enclosed and protected by a double-layered serous membrane called the pleural membrane. It consists of two layers: the

outer parietal pleura and the deeper visceral pleura. The space between the two is called the pleural cavity and contains a small amount of lubricating fluid secreted by the membranes. The important function of this pleural fluid is to reduce the friction between the membranes during breathing movement.

6. Functions of Tissues within the Gas Exchange System

The respiratory system consists of four main layers

- (i) The respiratory mucosa (epithelium and supporting lamina propria)
- (ii) Submucosa
- (iii) Cartilage and/or muscle layer
- (iv) Adventitia

Trachea

The trachea is a wide flexible tube. The respiratory mucosa and submucosa are adapted to warm and moisten the air, and to trap particles in mucous. It consists of pseudostratified columnar, ciliated epithelium with mucous secreting goblet cells. It has twenty C-shaped rings of hyaline tracheal cartilage which supports the trachea and keeps its lumen open. The gaps between the rings of cartilage are filled by a bundle of smooth muscle (trachealis muscle) and fibroelastic tissue. These structures together give flexibility for ventilation. Adventitia is the outermost fibroelastic connective tissue layer. The respiratory mucosa is made up of the epithelium and supporting lamina propria. The epithelium is tall columnar pseudostratified with cilia and goblet cells. Lamina propria lies underneath the epithelium. It contains elastin and has a supporting role. Blood vessels warm the air. The sub-mucosa contains mixed sero-mucous glands. The watery secretions from the serous glands humidify the inspired air. The mucous, together with mucous from the goblet cells traps particles from the air which are transported upwards towards the pharynx by the cilia on the epithelium. This helps to keep the lungs free of particles and bacteria. There are lots of seromucous glands in the submucosa layer.

The epithelial surfaces of the airways up to the end of the respiratory bronchioles have cilia that constantly beat toward the pharynx. They also contain mucous secreting glands.

This mucous keeps the lungs clear of particulate matter and the many bacteria that enter the body on dust particles. Macrophages present in the airways and alveoli also protect against infection.

Bronchi

Bronchi have the same basic structure as trachea. A few differences are respiratory epithelium are less tall than that of trachea and contains fewer goblet cells. Lamina propria has more elastic tissue. Muscularis mucosae begin to appear lamina propria and submucosa. There are fewer submucosal glands and cartilage is in plates. There is less cartilage in the tertiary bronchi, It does not completely encircle the lumen.

Bronchioles

The tertiary bronchi branch into bronchioles. They have a diameter of 1mm or less, and the wall structure changes. There is no cartilage and no glands. The ring of smooth muscle is arranged in discrete bundles with a variety of organisations. The epithelium is made up of ciliated columnar cells in larger bronchioles, or non-ciliated in smaller bronchioles. There are no goblet cells, but there are cells called Clara cells. These are secretory cells and they secrete one of the components of surfactant.

Terminal Bronchioles

The final branches of the bronchioles are called terminal bronchioles. These have a layer of smooth muscle surrounding their lumens. Stimulation of the vagus nerve (parasympathetic) causes the smooth muscle to contract, and reduce the diameter of the terminal bronchioles. Small sacs are found extending from the walls of the terminal bronchi called respiratory bronchioles. These are lined by a ciliated cuboidal epithelium, and some non-ciliated cells called clara cells. The respiratory bronchi have a few single alveoli of their walls.

Alveoli

The alveoli are the sites of gas exchange with the blood. The wall of the air-facing surface(s) are lined by type I alveolar cells which is a one cell thick, continuous layer of flat epithelial cells. Type II alveolar cells are thicker specialized cells producing a detergent-like substance called surfactant and they are interspersed between type I cells. In some of the alveolar walls, pores are present which permit the flow of air between alveoli.

The alveolar walls contain capillaries and a very small interstitial space, made of interstitial fluid and a loose meshwork of connective tissue. However, the interstitial space is absent altogether at most places and the basement membranes of the alveolar-surface epithelium and the capillary-wall endothelium fuse. As a result, the blood within an alveolar-wall capillary is separated from the air within the alveolus by an extremely thin barrier around 0.2 μm . The branching of bronchioles and the vast number of alveoli collectively increases the respiratory surface area to as much as 80 square metres. The extensive surface area of alveoli in contact with capillaries and the thin barrier results in the rapid exchange of large quantities of oxygen and carbon dioxide by diffusion.

7. Inspiration (inhalation or breathing in) is the movement of air from the external environment through the airways into the alveoli during breathing. Expiration (exhalation) is movement in the opposite direction. An inspiration and an expiration constitute a respiratory cycle.

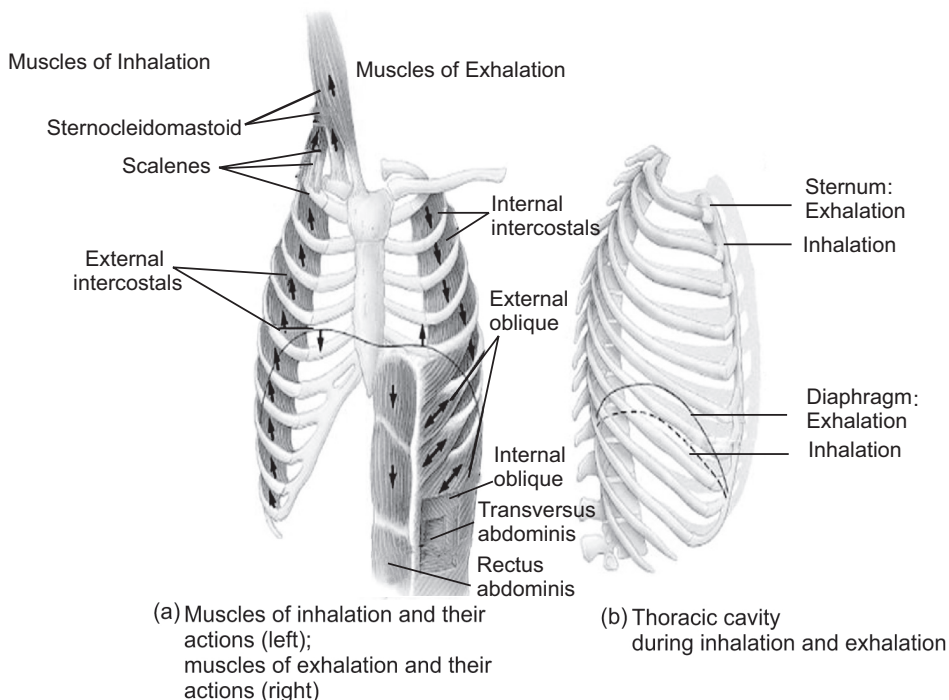

Inhalation: Air will move into the lungs when air pressure inside the lungs is less than that of outside (atmospheres). Expansion of the lungs increases the volume and so the pressure inside the lungs decreases. Expansion of the lungs during normal quiet inhalation is achieved by contraction of the diaphragm and external intercostals which are the main muscles of inhalation (Figure 9.14). The diaphragm is the dome-shaped skeletal muscle that forms the floor of the thoracic cavity. Contraction of the diaphragm causes it to flatten, lowering its dome. This increases the vertical diameter of the thoracic cavity. Around 75% of air enters the lungs by this action. Also, contraction of the external intercostals elevates the ribs resulting in an increase in the volume of the chest cavity. About 25% of the air that enters the lungs during normal quiet breathing is due to this action. As the volume of the lungs increases and the pressure inside the lungs (alveolar or intra-pulmonic pressure) decreases and atmospheric air rushes into the lungs.

Exhalation: On the other hand if the volume of the lungs decreases, pressure inside the lungs increases. As a result, air rushes out of the lungs resulting in exhalation or expiration. However, normal exhalation during quiet breathing, unlike inhalation, is a passive process because no muscular contractions are involved. Exhalation results from elastic recoil of the chest wall and lungs. Elastic recoil is the natural tendency of the chest wall and the lungs to spring back

after they have been stretched. The inspiratory muscles relax with the start of exhalation. Diaphragm and external intercostal muscles also relax, resulting in decrease in volume of the lungs, causing air to move out of the lungs. Interestingly, exhalation becomes an active process (requiring energy supply) only during the time of forced exhalation (for example during heavy exercise etc). During these times, the muscles of exhalation are the abdominals and internal intercostals muscles which contract to increase pressure in the abdominal region and thorax.

8. Alveoli are the respiratory units of lungs. The alveolar and capillary walls together form the respiratory membrane. The exchange of gases in the alveoli and between the air spaces in the lungs and the blood takes place by diffusion across this respiratory membrane. The pressure of a specific gas (x) in a mixture is called its partial pressure (P_x). The difference in partial pressures determines the movement of O_2 and CO_2 between the atmosphere and lungs, between the lungs and blood, and between the blood and body cells. Gas diffuses across a permeable membrane from an area where its partial pressure is higher to the area where its partial pressure is low and the rate of diffusion is directly proportional to the difference in partial pressure.

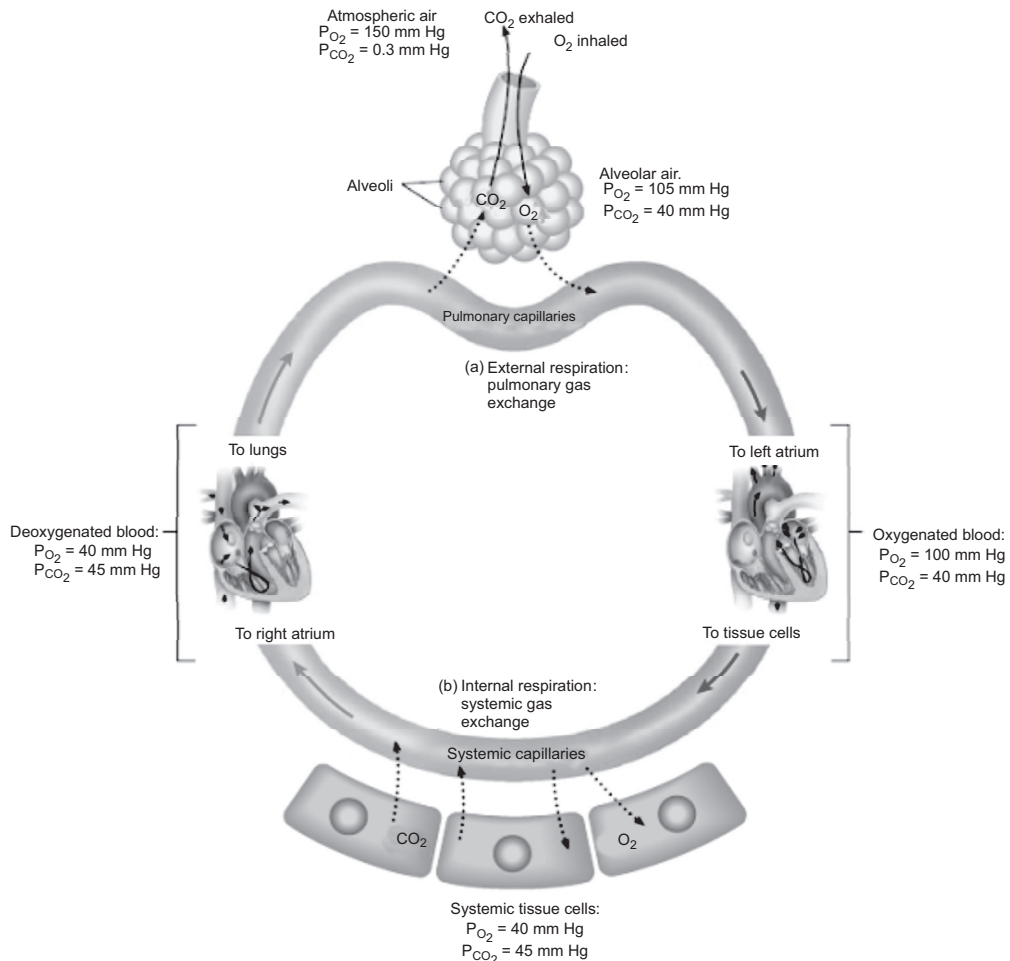

External respiration or pulmonary gas exchange is the diffusion of O_2 from air in the alveoli of the lungs to blood in pulmonary capillaries and the diffusion of CO_2 in the opposite direction. In this process, blood picks up O_2 from alveolar air and unloads CO_2 into alveolar air as it flows through pulmonary capillaries. In a resting person, PO_2 is 105 mmHg in the alveolar air which is higher than that of blood in pulmonary capillaries, where it is only 40 mmHg. This results in diffusion of O_2 from alveolar air into pulmonary capillaries. However, CO_2 diffuses in the opposite direction because the PCO_2 of deoxygenated blood is 45 mmHg in a resting person, and the PCO_2 of alveolar air is 40 mmHg. Hence, carbon dioxide diffuses from deoxygenated blood into the alveoli until the PCO_2 of the blood decreases to 40 mmHg.

As result of this diffusion, the capillary blood PO_2 rises while its PCO_2 falls. This process of diffusion continues as long as there is difference in partial pressure of the two gases between the two sides. An equilibrium is reached well before the end of the capillaries because blood flow in the capillaries is slow and gas exchange is rapid. Oxygenated blood now leaves the pulmonary capillaries to return to the heart from where it is pumped into the systemic arteries. The exchange of O_2 and CO_2 between systemic capillaries and tissue cells is called internal respiration or systemic gas exchange.

9. The respiratory centre is the cluster of neurons located bilaterally in the medulla oblongata and pons of the brain stem. It can be divided into three areas on the basis of their functions
 1. The medullary rhythmicity area in the medulla oblongata:
 - Controls the basic rhythm of respiration.
 - There are inspiratory and expiratory areas.
 - Nerve impulses generated in the inspiratory area establish the basic rhythm of breathing during quiet breathing by causing contraction of external intercostal muscle.
 - The neurons of the expiratory area remain inactive during quiet breathing. However, during forceful breathing nerve impulses from the inspiratory area activate the expiratory area.
 - Impulses from the expiratory area cause contraction of the internal intercostal and abdominal muscles, which decreases the size of the thoracic cavity and causes forceful exhalation.
 2. The pneumotaxic area in the pons:
 - Transmits inhibitory impulses to the inspiratory area.
 - The major effect of these nerve impulses is to help turn off the inspiratory area before the lungs become too full of air.

- In other words, the impulses shorten the duration of inhalation. When the pneumotaxic area is more active, breathing rate is more rapid.
3. The apneustic area in the lower pons:
- This area sends stimulatory impulses to the inspiratory area that activate it and prolong inhalation.
 - The result is a long, deep inhalation.
 - When the pneumotaxic area is active, it overrides signals from the apneustic area.
10. (i) **Tidal volume:** It is the volume of air entering the lungs during a single inspiration during normal quiet breathing. It is about 500 ml. It is approximately equal to the volume leaving on the subsequent expiration.
- (ii) **Inspiratory reserve volume:** The maximal amount of air that can be increased above the resting tidal volume during deepest/forced inspiration is termed the inspiratory reserve volume. It is about 3000 ml in average adult males which is sixfold greater than resting tidal volume and 1900 ml in average adult females.
- Expiratory reserve volume:** The 500 ml of air inspired with each resting breath adds to and mixes with the much larger volume of air already in the lungs, and then 500 ml of the total is expired. However, through maximal active contraction of the expiratory muscles i.e., forced expiration, it is possible to expire much more of the air remaining after the resting tidal volume has been expired; this additional expired volume is termed the expiratory reserve volume (about 1500 ml).
- (iii) **Vital capacity:** It is the maximal volume of air that a person can expire after a maximal inspiration. It is a useful clinical measurement for detecting various respiratory system related conditions. It is the sum of inspiratory reserve volume, tidal volume, and expiratory reserve volume (4800 ml in males and 3100 ml in females).
- (iv) **Residual volume:** Even after a maximal active expiration, approximately 1000 ml of air still remains in the lungs. This is because the subatmospheric intrapleural pressure keeps the alveoli slightly inflated, and some air also remains in the noncollapsible airways. This volume, which cannot be measured by spirometry, is called the residual volume and amounts to about 1200 ml in males and 1100 ml in females.
- (v) **Dead Space** refers to the conducting airways which have a volume of about 150 ml. Exchanges of gases with the blood does not occur in this 150 ml of the airways. It occurs only in the alveoli. Since these airways do not permit gas exchange with the blood, the space within them is termed

the anatomic dead space. Thus, the volume of fresh air entering the alveoli during each inspiration equals the tidal volume minus the volume of air in the anatomic dead space.

11. The spirometer is an apparatus for measuring inspired and expired volumes during breathing and the respiratory rate. The record is called a spirogram.

Use of Spirometer to Measure Ventilation Rate

The lung volumes and capacities can be measured by routine spirometry. A typical spirometer is a tube like instrument with an open end called the mouthpiece. The *spirometer* consists usually of a water-filled tank with a bell shaped floating device. A tube connects the air space within the spirometer with the airways of the person whose lung volume is being measured. A counterweight is placed on the bell. The position of the bell indicates how much air is in the spirometer and is calibrated in volume units. A person under the test blows air into it after deep breath. Usually, the airway through the nose is shut or blocked using a clip so that air can only enter or leave through the mouth. Inhalation is recorded as an upward deflection, and exhalation is recorded as a downward deflection. The bell on the spirometer rises when the person blows into the device (expiration), and falls during inspiration. If the spirometer is equipped with a recording device (*spirograph*), it can also be used for graphic measurement of the total ventilation per unit time. Based upon the reading indicated corresponding to each breathing in or out, an expert physician can diagnose the health of the person's lungs and detect disorder if any. Nowadays, the instrument is integrated with a computer system to accurately monitor the readings and give instant results. Using the spirometer to obtain readings.

- (i) One learner holds the bottle to keep it from flipping over. Another learner inhales normally and then exhales the air normally into the tubing connected to the spirometer. Note: Do not blow out all the "extra" air in your lungs.
- (ii) Note the amount of air you exhaled, remembering that each line on the bottle represents a half litre, starting from the top down.
- (iii) Record this volume, it is your "tidal volume." The tidal volume is the amount of air that you normally breathe in and out.
- (iv) Refill the bottle with water and reinsert the tubing. One learner holds the bottle while another takes a few normal breaths initially. This is to get a good reading in the next step. Then inhale as much air as you can and exhale this air into the end of the tubing outside of the water.
- (v) Again note the amount of air you exhaled by looking at the lines on the soda bottle.

- (vi) This volume is your “inspiratory reserve.” The inspiratory reserve is the amount of air that your lungs can hold in.
- (vii) Refill the bottle with water and reinsert the tubing. One student holds the bottle while the other take a few normal breaths to get himself back to a normal breath. Then exhale as much air as you can into the end of the tubing outside of the water.
- (viii) Note the amount of air you exhaled by looking at the lines on the soda bottle.
- (ix) This is your “expiratory reserve.” The expiratory reserve is the amount of air that your lungs can blow out after a normal breath.

12.

- Vital capacity = inspiratory reserve volume + tidal volume + expiratory reserve volume

$$= 2500 \text{ ml} + 550 \text{ ml} + 1450 \text{ ml} = 4500 \text{ ml}$$
- Alveolar ventilation (ml/min) = (Tidal volume – Dead space) × Respiratory rate

$$\frac{\text{ml}}{\text{breath}} \qquad \qquad \qquad \frac{\text{ml}}{\text{breath}} \qquad \qquad \qquad \frac{\text{breath}}{\text{min}}$$

$$= (550 - 185) \times 17 \text{ ml/min} = 365 \times 17 \text{ ml/min} = 6205 \text{ ml/min}$$

13. In order to carry on photosynthesis, green plants need a supply of carbon dioxide and a means of disposing of oxygen. In order to carry on cellular respiration, plant cells need oxygen and a means of disposing of carbon dioxide (just as animal cells do). Unlike animals, plants have no specialized organs for gas exchange. Each part of the plant takes care of its own gas exchange needs. Although plants have an elaborate liquid transport system, it does not participate in gas transport.

The exchange of oxygen and carbon dioxide in the leaf (as well as the loss of water vapour in transpiration) occurs through pores called stomata.

Normally stomata open when the light strikes the leaf in the morning and close during the night.

Carbon dioxide is a greenhouse gas which plays a major role in global warming. Our planet has become at risk over the past century because of escalated use of fossil fuels and higher carbon dioxide levels than people have ever seen. There is a scientific evidence that climate change is happening, yet some people doubt that global warming even exists.

Some people believe that global warming is a myth, they don't believe the environment is in danger. Global warming is not just a theory, it is real, and it is happening now. The temperature of the Earth is rising, the ozone layer is decreasing, we are trapping increased heat in the atmosphere and sooner or later a number of animal species will become extinct and human health will be

at risk. Across the globe there have been increases in droughts, hurricanes, floods and unusual weather occurrences that hurt crops, destroyed homes, and have taken lives. There are a group of scientists that meet in London to discuss the Earth and what is in store for the future of the planet. The Planet Under Pressure Conference (PUP) has concluded that the Earth is coming to the point where a recovery from global warming will not be possible. They believe that by 2100 the temperature will rise by 6 degrees Celsius (42.8 degrees F) if gases continue to rise without control. This would result in the loss of ice sheets and rainforests. The tropical rainforests produce 40% of the world's oxygen. Losing the rainforests would take a major toll on environment and human health. Another effect is the threat to coral reef development. The Great Barrier Reef is home to over 350 species of coral, 1,800 species of fish, and also home to hundreds of sharks, sponges, and even dolphins and whales. Some species would probably go extinct because of the Earth changing and their habitat and source of food disappearing.

Global warming would not only affect the animals on Earth but also the humans. Greenland's ice caps would also increase in the speed in which they are melting, raising the sea level by 23 feet and swallowing some of the land on the coasts of several continents. Grass has been seen growing on Antarctica where the ice has melted away. The world will see a dramatic change over the next 100 years unless we try to make changes and do our part to conserve the planet.

9.13 ASSESSMENT METHODS

Use observation technique, question answer technique, and demonstration technique to assess the learners' achievement of learning objectives.

9.14 ASSESSMENTS

Formative Assessment

Fill in the blanks:

1. is the sum of vital capacity and residual volume.
2. refers to the conducting airways which have a volume of about 150 ml.

Ans. 1. Total lung capacity, 2. Dead Space

Summative Assessment

Answer in one word.

1. Result in a long, deep inhalation, part of the brain.
2. Neural activity is primarily controlled by neurons in the.

Ans. 1. apneustic area in the lower pons, 2. medulla oblongata.

Unit 10: Smoking and Related Diseases

10.1 LEARNING OBJECTIVES

| Knowledge and Understanding | Skills | Attitudes and Values |
|--|--|--|
| <ul style="list-style-type: none">• Describe the effects of tar and carcinogens in tobacco smoke on the gas exchange system.• Describe the signs and symptoms of lung cancer and chronic obstructive pulmonary diseases (COPD).• Describe the effects of nicotine and carbon monoxide on the cardiovascular system.• Explain how tobacco smoking contributes to atherosclerosis and coronary heart disease. | <ul style="list-style-type: none">• Interpret photographs to differentiate healthy lungs from infected lungs.• Interpret data linking cigarette smoking to disease and early death.• Observe and interpret research statistics linking to tobacco smoking. | <ul style="list-style-type: none">• Evaluate the epidemiological and experimental evidence linking cigarette smoking to disease and early death.• Influence the campaign against cigarette smoking. |

10.2 TEACHING AIDS

Visual: Images of healthy and unhealthy lungs.

Audio-video: Video showing smoking and related diseases.

10.3 TEACHER'S TIP

Teacher starts the unit by briefing the learners about tobacco leaves that contain toxins which are harmful for human health. Teacher also discusses the dangerous chemical in tobacco smoke and how it affects our body and brain.

10.4 TEACHING METHODS

Brainstorming, short lecture technique, group discussion technique, observation technique, drawing technique, demonstration technique, and practical work.

10.5 TEACHING AND LEARNING MATERIALS

Charts, cured tobacco leaves, computer simulations, and smoking machine or video clip.

10.6 TEACHING METHODOLOGY

Teacher initiates the topic by introducing dangers of smoking.

Teacher also discusses the passive smoking. Start by asking the learners to tell any of the diseases they know that occur because of smoking.

Learners reply to the questions raised by the teacher.

Appreciating them, teacher further asks if they are aware of the effects of tobacco.

Learners will come up with varied answers. Some correct, some near to correct, others being irrelevant.

Teacher will not demotivate the child. But agreeing to the correct answers, dwell further in discussion.

Using short lecture technique, teacher will explain the diseases such as atherosclerosis.

Teacher further explains the learners the different ways smoking kills.

10.7 ADDITIONAL CONTENT FOR THE TEACHER

Diseases and health problems caused by smoking:

- **Cancers** of the lung, throat, mouth, tongue, nose, oesophagus, pancreas, stomach, liver, kidney, bladder, ureter, ovary, and bone marrow. Smoking-related cancers accounted for about 13% of all cancer cases in 2010.
- **Heart disease.** Around 30% of all cases of heart disease in those under 65 years are due to smoking.
- **Chronic obstructive pulmonary disease (COPD)** includes emphysema and small airways disease.
- **Chronic bronchitis** is a recurring cough together with frequent and increased phlegm. It occurs in about half of all heavy smokers.
- **Stroke.** Smokers under 65 years are around three times more likely to have a stroke than non-smokers of the same age.
- **Type 2 diabetes**, and higher risks for diseases associated with diabetes in people with Type 1 or Type 2 diabetes.
- **Eye diseases**, such as macular degeneration and cataracts.
- **Lower fertility** in women.
- **Periodontitis**, a dental disease that affects the gum and bone that supports the teeth.
- **Respiratory symptoms** including shortness of breath and coughing. These symptoms occur in both child and adult smokers.
- **Problems during pregnancy** including restricted foetal growth and low birth weight, ectopic pregnancy, complications that can lead to bleeding in

pregnancy and the need for caesarean section delivery, and shortened time in the womb and preterm delivery. Smoking during pregnancy also causes death in early infancy (particularly from Sudden Infant Death Syndrome), reduced lung function in childhood, and oral clefts (e.g., harelip) in infants.

- **Erectile dysfunction.** Men who smoke increase their risk of impotence, and may have reduced semen volume, sperm count and sperm quality.
- **Tuberculosis** disease and death.
- **Asthma.** Smokers with asthma have poorer asthma control, faster decline in lung function, more airway inflammation, and get less benefit from some asthma medications, compared to non-smokers with asthma.

Activity

The teacher can demonstrate this activity in the class.

Aim: To make learners understand the dangers of smoking

Ask each learner to read about it and see the photographs of smokers.

Ask them to research and present a report on smokers.

10.8 SUMMARY

- Smoking harms nearly every bodily organ and organ system in the body and diminishes person's health and smokers are more likely than non-smokers to develop heart disease, stroke, and lung cancer.
- Smoking is a leading cause of lung cancer and death from cancer.
- It causes stroke and coronary heart disease, which are among the leading causes of death in the United States.
- Atherosclerosis and coronary heart disease results damaging of blood vessels and make them thick and grow narrow, when a clot blocks the blood flow to part of brain or when a blood vessel in or around your brain bursts, it causes a stroke.
- Chronic Obstructive Pulmonary Disease (COPD) is a chronic inflammatory lung disease caused by smoking which damage the airways and the small air sacs (alveoli) found in the lungs. Emphysema and Chronic bronchitis condition also contributed to COPD which obstruct the airways of lung.
- People with COPD are at higher risk of developing heart disease, lung cancer and a variety of other conditions. They suffer from breathing difficulty, sudden lose weight and feel low energy.
- Cigarette smoking and tobacco smoking contain a number of harmful and carcinogenic chemicals like:
- Nicotine — not carcinogenic but highly addictive. Smokers find it very hard to quit because they are hooked on the nicotine. Nicotine is an extremely fast-acting drug. It reaches the brain within 15 seconds of being inhaled. Nicotine

is used as a highly controlled insecticide. Exposure to sufficient amounts can lead to vomiting, seizures, depression of the CNS (central nervous system), and growth retardation.

- Carbon Monoxide — a poisonous gas with no smell or taste. The body finds it hard to differentiate carbon monoxide from oxygen and absorbs it into the bloodstream. Carbon monoxide decreases muscle and heart function, it causes fatigue, weakness, and dizziness. It is especially toxic for babies still in the womb, infants and individuals with heart or lung disease.

10.9 WEBLINKS FOR CONTENT ENRICHMENT

- <http://patient.info/health/smoking-the-facts>
- <http://kidshealth.org/en/teens/smoking.html>
- <http://www.webmd.com/smoking-cessation>.

10.10 LEARNERS' ACTIVITIES

Activity 1

The teacher should assist the learners in performing the activity.

Hint:

1. Boil tobacco leaves in water to get the extract
2. Cool down the water
3. Spray the obtained extract on the infested plants
4. Observe the effect of extract on Aphids
5. Make observation table

Observation: Aphids will die because of the toxic effect of tobacco.

Conclusion: Tobacco is really harmful for every living organism. Not only humans, it's even harmful for tiny insects.

Activity 2

The teacher should guide the learners to perform activity on their own.

Hint:

1. Take a plastic bottle
2. Make a hole near its base and close it with a pen with its lid.
3. Fill the tap water in the water bottle to 3/4.
4. Make a hole in the cap of the water bottle and put the tip of the cigarette in the hole.

5. Screw up the cap back to the bottle.
6. Light up the cigarette with a match stick.
7. Slowly open lid of the pen and let the water come out through the hole.
8. As the water comes out, it sucks the smoke in which results filling of the bottle completely with smoke.
9. Remove the cap and close the bottle mouth with tissue paper and put rubber band over it.
10. Blow up the smoke through bottom opening to expel the smoke out leaving only tar inside.
11. When smoke passes through the tissue paper, tar sticks to it.
12. Observe the tissue paper which contains the dangerous chemical nicotine and sticky brown chemical tar.

Observation: you will see a sticky brown compound 'tar' on the tissue paper. Tar makes coatings on the lung, and hinders the oxygen exchange that makes person's breathing difficult. It leads to cancer also in the alveoli.

Activity 3

Step 1: Teacher should assist the learners to perform activity as directed with a friend.

Step 2: Engage the learners in a group discussion to discuss the steps to control the use of tobacco.

Activity 4

Step 1: The teacher should arrange for audio-visual display exhibiting dangers of smoking.

Step 2: Engage the learners in a group discussion to discuss.

10.11 ANSWERS TO SELF-EVALUATION

Self-evaluation

- (i) Carbon monoxide
- (ii) Nicotine
- (iii) benzo (a) pyrene
- (iv) carcinogenic
- (v) increases

10.12 ANSWERS TO END UNIT ASSESSMENT 10

I. Choose whether the following statements are True (T) or False (F):

1. **True;** it is equally harmful for non-smokers when they inhale smoke indirectly.
2. **True;** Nicotine causes desensitization of brain that badly affects taste and olfactory senses.
3. **True;** Because smoke contains numerous irritants that cause irritation of eyes.
4. **True;** Nicotine gets absorbed in the blood very fast.
5. **True;** Because cigarette smoking contains a highly addictive chemical nicotine. Addicted smokers need enough nicotine over a day to 'feel normal' – to satisfy cravings or control their mood.
6. **True;** Nicotine is an extremely fast-acting drug. Addicted smokers need enough nicotine over a day to 'feel normal' – to satisfy cravings or control their mood.
7. **True;** Smoking damages blood vessels and make them thicken and grow narrower which causes heart attack when a clot blocks the blood flow.
8. **True;** Teens get easily attracted to the brands which are being advertised and they want to try the popular brands.
9. **False;** the number of smokers who die of smoking-related diseases is closer to three out of ten.
10. **True;** because the smoke paralyzes the cilia that line your breathing system.

II. Multiple choice questions:

1. **(d);** Smoking is very harmful for health and affects every organ of the body. It leads to heart, respiratory disease along with lung cancer.
2. **(c);** Atherosclerosis is a heart disease where, cholesterol accumulates and stick around the wall of arteries. It interrupts the blood flow and causes heart attack or stroke.
3. **(d);** Chronic obstructive lung disease i.e., COPD includes both conditions Chronic bronchitis (It develops a chronic cough and sputum production) as well as emphysema (impairing airflow out of your lungs). Both conditions cause shortness of breath.
4. **(c);** Chronic Obstructive Pulmonary Disease i.e., Chronic lung disease.

5. **(c)**; Emphysema is a condition in which the air sacs (alveoli) at the end of the smallest air passages (bronchioles) of the lungs are destroyed due to smoking. It includes bursting of alveoli as well as impairing of air flow.
6. **(a)**; Carcinogens are cancer causing agents.
7. **(b)**; Because emphysema includes decrease in the surface area of gas exchange in the alveoli.
8. **(d)**; Water pollution does not cause lung diseases. COPD is mainly caused by smoke, whether it is produced by cigarette or burning of the fuel and wood.
9. **(d)**; Retinoblastoma is cancer of eye which cannot be linked with lung disease.
10. **(b)**; Smoker's cough is the attempt to clear out the sputum from the airway passage.

III. Long answer type questions:

1. The most damaging components of tobacco smoke are:
 - (i) **Tar** is the collective term describing toxins produced by smoking cigarettes and the coating they place on the lungs. Tar is sticky and brown, and stains teeth, fingernails and lung tissue. Tar contains the carcinogen benzo(a) pyrene. When inhaled, these toxins form a particulate matter that coats lungs much the same way that soot from log fires coats chimneys. But unlike chimneys, which are made of stone or brick, human lungs are made of thin, delicate tissue not intended for toxic smoke intake.
 - (ii) **Nicotine** is the addictive drug in tobacco smoke that causes smokers to continue to smoke and affects the brain activity. Addicted smokers need enough nicotine over a day to 'feel normal'—to satisfy cravings or control their mood.
 - (a) Brain is made up of billions of nerve cells. They communicate by releasing chemical messengers called neurotransmitters. Each neurotransmitter is like a key that fits into a special "lock," called a receptor, located on the surface of nerve cells. When a neurotransmitter finds its receptor, it activates the receptor's nerve cell.
 - (b) The nicotine molecule is shaped like a neurotransmitter called acetylcholine. Acetylcholine and its receptors are involved in many functions, including muscle movement, breathing, heart rate, learning, and memory. They also cause the release of other neurotransmitters and hormones that affect your mood, appetite, memory, and more. When nicotine gets into the brain, it attaches to acetylcholine receptors and mimics the actions of acetylcholine. Nicotine also activates areas of the brain that are involved in producing the feelings of pleasure

and reward. Recently, scientists discovered that nicotine raises the levels of a neurotransmitter called dopamine in the parts of the brain that produce the feelings of pleasure and reward. Dopamine, which is sometimes called the pleasure molecule, is the same neurotransmitter that is involved in addictions to other drugs such as cocaine and heroin. Researchers now believe that this change in dopamine may play a key role in all addictions.

(iii) **Carbon monoxide (CO):** This odourless gas is fatal in large doses because it takes the place of oxygen in the blood. It is also called 'Silent killer'. Each red blood cell contains a protein called haemoglobin that transports oxygen molecules around the body. However, carbon monoxide binds to haemoglobin better than oxygen. In response, the body makes more red blood cells to carry the oxygen it needs, but it makes the blood thicker. This means that when the body demands more oxygen during exercise, less oxygen reaches the brain, heart, muscles and other organs.

2. The effects of tobacco smoke on the respiratory system include:

- Irritation of the trachea (windpipe) and larynx (voice box)
- Reduced lung function and breathlessness due to swelling and narrowing of the lung airways and excess mucus in the lung passages
- Impairment of the lungs' clearance system, leading to the build-up of poisonous substances, which results in lung irritation and damage
- Increased risk of lung infection and symptoms such as coughing and wheezing
- Permanent damage to the air sacs of the lungs

Smoking can cause lung disease by damaging your airways and the small air sacs (alveoli) found in your lungs

- Lung diseases caused by smoking include COPD, which includes emphysema and chronic bronchitis
- Cigarette smoking causes most cases of lung cancer
- In condition of asthma, tobacco smoke can trigger an attack or make an attack worse
- Smokers are 12 to 13 times more likely to die from COPD than non-smokers.

3. Smoking harms nearly every bodily organ and organ system in the body and diminishes a person's health and smokers are more likely than non-smokers to develop heart disease, stroke, and lung cancer. 'Smoke-free' campaigns are run to encourage people to change their behaviour.

The campaigns are aimed at:

- Making people aware of the health dangers of smoking
 - Stopping young people from taking up smoking
 - Encouraging smokers to try and quit, and to do so in the most effective way
 - Encouraging people to stop smoking in their homes and family cars—emphasising how it affects children.
4. Lung cancer is strongly correlated with cigarette smoking, with about 90% of lung cancers arising as a result of tobacco use. The risk of lung cancer increases with the number of cigarettes smoked over time.

The most common symptoms of lung cancer are:

- A cough that does not go away or gets worse
- Chest pain that is often worse with deep breathing, coughing, or laughing
- Hoarseness
- Weight loss and loss of appetite
- Coughing up blood or rust-coloured sputum (spit or phlegm)
- Shortness of breath
- Feeling tired or weak
- Infections such as bronchitis and pneumonia that don't go away or keep coming back
- New onset of wheezing

If lung cancer spreads to distant organs, it may cause:

- Bone pain (like pain in the back or hips)
- Nervous system changes (such as headache, weakness or numbness of an arm or leg, dizziness, balance problems, or seizures), from cancer spread to the brain or spinal cord
- Yellowing of the skin and eyes (jaundice), from cancer spread to the liver
- Lumps near the surface of the body, due to cancer spreading to the skin or to lymph nodes (collections of immune system cells), such as those in the neck or above the collarbone

Chronic Obstructive Pulmonary Disease (COPD) is a chronic inflammatory lung disease that causes obstructed airflow from the lungs. COPD is always caused by smoking. Over time, breathing tobacco smoke irritates the airways and destroys the stretchy fibres in the lungs. It usually takes many years for the lung damage to start causing symptoms, so COPD is most common in people who are older than 60. Other things that may put you at risk include breathing chemical fumes, dust, or air pollution over a long period of time. Second hand smoke also may damage the lungs.

The main symptoms are:

- A long-lasting (chronic) cough
- Breathing difficulty, especially during physical activities
- Cough
- Sputum production
- Wheezing
- Blueness of the lips or fingernail beds (cyanosis)
- Frequent respiratory infections
- Lack of energy.

As COPD gets worse, you may be short of breath even when you do simple things like get dressed or fix a meal. It gets harder to eat or exercise, and breathing takes much more energy. People often lose weight and get weaker. People with COPD are at increased risk of developing heart disease, lung cancer and a variety of other conditions.

Emphysema and Chronic bronchitis are the two most common conditions that contribute to COPD. It causes airway obstruction in the lungs.

5. Both carbon monoxide and Nicotine along with other carcinogens affect brain and heart. They too increase the risk of developing cardio vascular diseases, which includes coronary heart disease and stroke.
 - The carbon monoxide in tobacco smoke reduces the amount of oxygen in blood. This means the heart has to pump harder to supply the body with the oxygen it needs.
 - The nicotine in cigarettes stimulates the body to produce adrenaline, which makes heartbeat faster and raises the blood pressure, making heart work harder.
6. Atherosclerosis (Artherosclerosis) and Coronary Heart Disease (CHD): Atherosclerosis (or arteriosclerotic vascular disease) is a condition where the arteries become narrowed and hardened due to an excessive build up of plaque around the artery wall. The disease disrupts the flow of blood around the body, posing serious cardiovascular complications. The plaque clogs up the artery, disrupting the flow of blood around the body. This potentially causes blood clots that can result in life-threatening conditions such as heart attack, stroke and other cardiovascular diseases is the usual cause of heart attacks, strokes, and peripheral vascular disease — what together are called “cardiovascular disease.” Carbon monoxide exposure has been implicated in the process of atherosclerosis. Coronary Heart disease, where platelets: components in the

blood—stick together along with proteins to form clots which can then get stuck in the plaque in the walls of arteries and cause heart attacks. The most common symptoms of coronary artery disease are angina (say “ANN-juh-nuh” or “ann-JY-nuh”) and shortness of breath when exercising or doing other vigorous activity. Women are somewhat more likely than men to have other symptoms like nausea and back or jaw pain.

7. Cigarette Smoking to Disease and Early Death

Cigarette smoking began en masse in the beginning of the twentieth century, and doctors started noticing a huge increase in cases of lung cancer from 1930 onwards, and by 1950s it was declared an epidemic. For comparison, in 1912 there were 374 lung cancer cases, and now there are over 35,000 deaths a year, an increase of nearly 100 times.

The correlation between lung cancer and cigarette smoking is plain in the chart— it shows the 20 year ‘lag’ between the rise of cigarettes and the rise of lung cancer. Epidemiological data links smoking and cancer, and up to 50% of smokers may die of smoking-related diseases.

One third of cancer deaths are as a result of cigarette smoking, and a quarter of smokers die of lung cancer. Chronic obstructive pulmonary disease is very rare in non-smokers, less than 10% of victims are non-smokers, and less than 2% of people with emphysema are non-smokers. One fifth of smokers suffer from emphysema, and as a result deaths from pneumonia and influenza are twice as high amongst smokers.

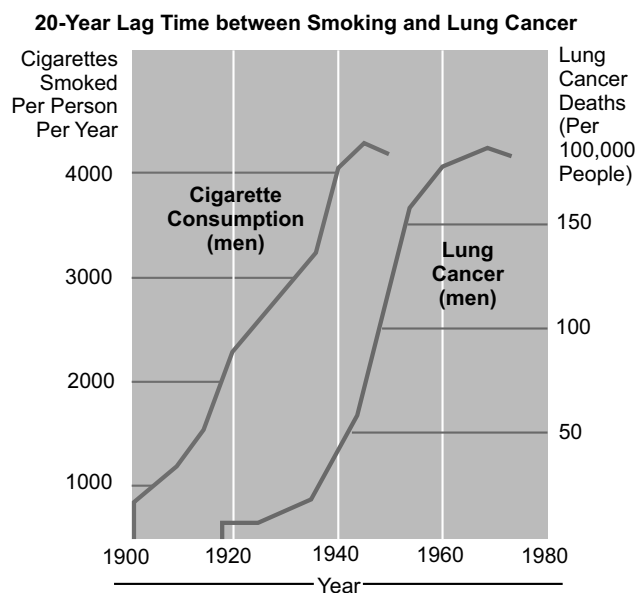

8. “Smoking is injurious to health”. We have heard this after and still what we correlate it with is whether a girl is smoking or a boy is consuming cigarette.

The disparity of gender which governs the acceptance of smoking is way too orthodox to compare to the effects of smoking.

Although smoking may seem to give pleasure, there are numerous disadvantages that outweigh the positive effects.

The habit of smoking cigarettes, marijuana or cigars, is one which has developed in many people. Perceptions about smoking are diverse; some people say it helps them relax, while others insist that it keeps them warm and keeps their weight in check.

There are different opinions about the effects of smoking.

Smoking puts a lot of strain on the heart; a smoker’s blood pressure and heart rate are increased ultimately causing the heart to work a lot harder than it should. Other negative effects include damage to the body’s respiratory system, infertility, foul breath, stained teeth and fingers, dry cough, black lips, and a chain of cancers some of which include lung and throat and stomach cancer.

Marijuana also known as weed is perceived by its users to have no negative side effects and to cure certain diseases. However, the findings of one study prove that marijuana smokers are three times more likely to develop cancer of the head or neck than non-smokers.

Tobacco use contributes to vast number diseases that can sometimes lead to death. Many consider the positive effects of smoking to be worthwhile. However, it is the negative effects, most of which are long-term that are not immediately noticed and can end up eating away from the inside out.

Most people know that smoking causes cancer, heart disease, and other major health problems. Smoking during pregnancy causes additional health problems, including premature birth (being born too early), certain birth defects, and infant death.

- Smoking makes it harder for a woman to get pregnant.
- Women who smoke during pregnancy are more likely than other women to have a miscarriage.
- Smoking can cause problems with the placenta—the source of the baby's food and oxygen during pregnancy. For example, the placenta can separate from the womb too early, causing bleeding, which is dangerous to the mother and baby.

- Smoking during pregnancy can cause a baby to be born too early or to have low birth weight—making it more likely that the baby will be sick and have to stay in the hospital longer. A few babies may even die.
 - Smoking during and after pregnancy is a risk factor of Sudden Infant Death Syndrome (SIDS). SIDS is an infant death for which a cause of the death cannot be found.
 - Babies born to women who smoke are more likely to have certain birth defects, like a cleft lip or cleft palate.
9. Although approximately 70 per cent of smokers say they want to quit, only about 3% annually are able to do so. Behavioural economics goes a long way in explaining why: the costs of trying to quit are both large and immediate, while the benefits seem too distant to be a good motivator.

But behavioural economics also suggests how to design incentive programmes to help.

Behaviour plays an important role in people's health (for example, smoking, poor diet, lack of exercise and sexual risk-taking can cause a large number of diseases). In addition, the evidence shows that different patterns of behaviour are deeply embedded in people's social and material circumstances, and their cultural context.

Interventions to change behaviour have enormous potential to alter current patterns of disease. A genetic predisposition to disease is difficult to alter. Social circumstances can also be difficult to change, at least in the short to medium term. By comparison, people's behaviour — as individuals and collectively — may be easier to change. However, many attempts to do this have been unsuccessful, or only partially successful.

Social and economic conditions can prevent people from changing their behaviour to improve their health, and can also reinforce behaviours that damage it.

Health inequalities are the result of a set of complex interactions, including:

- the long-term effects of a disadvantaged social position
- differences in access to information, services and resources
- differences in exposure to risk
- lack of control over one's own life circumstances
- a health system that may reinforce social and economic inequalities.

These factors all affect people's ability to withstand the stressors — biological, social, psychological and economic — that can trigger ill health. They also affect the capacity to change behaviour.

10. Differentiate

(i) Differences between emphysema and chronic bronchitis

| S. No. | Emphysema | S. No. | Chronic Bronchitis |
|--------|--|--------|---|
| 1. | It is a condition in which the air sacs (alveoli) at the end of the smallest air passages (bronchioles) of the lungs are destroyed as a result of damaging exposure. | 1. | Chronic bronchitis is inflammation of the lining of the bronchial tubes, which carry air to and from the air sacs (alveoli) of the lungs. |
| 2. | This causes destruction of the fragile walls and elastic fibres of the alveoli. Small airways collapse when you exhale, impairing airflow out of your lungs. | 2. | In this condition, bronchial tubes become inflamed and narrowed and your lungs produce more mucus, which can further block the narrowed tubes. It develops a chronic cough and sputum production. |

(ii) Differences between atherosclerosis and coronary heart disease

| S. No. | Atherosclerosis | S. No. | Coronary heart disease |
|--------|--|--------|--|
| 1. | A disease in which plaque builds up inside your arteries. Arteries are blood vessels that carry oxygen-rich blood to your heart and other parts of your body. | 1. | In this condition the hard cholesterol substances (plaques) are deposited within a coronary artery. |
| 2. | Plaque is made up of fat, cholesterol, calcium, and other substances found in the blood. Over time, plaque hardens and narrows your arteries. This limits the flow of oxygen-rich blood to your organs and other parts of your body. | 2. | The plaques in the coronary arteries can lead to the formation of tiny clots that can obstruct the flow of blood to the heart muscle. |
| 3. | Atherosclerosis can lead to serious problems, including heart attack, stroke, or even death. | 3. | It produces symptoms and signs of CAD, including chest pain (angina pectoris), heart attack (myocardial infarction), and sudden death. |

11. (a) A is healthier than B.
- (b) B is a tar coated lung.

10.13 ASSESSMENT METHODS

Use observation technique, question answer technique, and demonstration technique to assess the learners' achievement of learning objectives.

10.14 ASSESSMENTS

Formative Assessment

Fill in the blanks:

1. COPD:
2. can cause unsightly yellow-brown stains on fingers and teeth.
3. Depression of the CNS (central nervous system) is caused by

Ans. 1. Chronic Obstructive Pulmonary Disease, 2. Tar, 3. nicotine

Summative Assessment

1. Distinguish and comment on emphysema and chronic bronchitis.
2. People with COPD are also likely to experience episodes.

Ans. 1. **Emphysema** is a condition in which the air sacs (alveoli) at the end of the smallest air passages (bronchioles) of the lungs are destroyed as a result of damaging exposure.

Chronic bronchitis is inflammation of the lining of the bronchial tubes, which carry air to and from the air sacs (alveoli) of the lungs.

2. Exacerbations.

Unit 11: General Principles of Homeostasis

11.1 LEARNING OBJECTIVES

| Knowledge and Understanding | Skills | Attitudes and Values |
|---|---|--|
| <ul style="list-style-type: none"> • Explain the significance of a constant internal environment. • State the factors that must be kept constant in the internal environment of the body. • Discuss the role of the negative feedback mechanism. • Explain the feedback mechanism in relation to the endocrine and nervous system. • Identify the main internal and external causes of change in the internal environment. • Describe the formation, composition and movement of tissue fluid in relation to blood and lymph. | <ul style="list-style-type: none"> • Relate organisms' ways of life to their environmental conditions. • Carry out research on homeostasis and deduce the findings. | <ul style="list-style-type: none"> • Appreciate the importance of maintaining a constant internal environment. • Appreciate the adaptations of animals to different environmental conditions in relation to homeostasis. |

11.2 TEACHING AIDS

Visual: Images of homeostasis.

Audio-video: Video showing feedback mechanisms of homeostasis.

11.3 TEACHER'S TIP

Start the unit by briefing the learners by the significance of constant internal environment. Listing the factors which must be kept constant to maintain homeostasis such as glucose, temperature, pH, water, ions, gases and fluid pressure. Role of feedback mechanisms in regulating homeostasis with both positive and negative feedback mechanisms. The need of maintaining homeostasis and the casual changes in environment.

11.4 TEACHING METHODS

Brainstorming, short lecture technique, group discussion technique, observation technique, drawing technique, demonstration technique, field visit, site visit and practical work.

11.5 TEACHING AND LEARNING MATERIALS

Charts and computer aided materials and rubber tubes.

11.6 TEACHING METHODOLOGY

Teacher initiates the topic by giving activity of homeostasis in human body. Ask them to think and perform the activity.

Teacher also discusses the factors to maintain constant. Ask the learners to tell something about it if they know.

Learners reply to the teacher.

Appreciating them, further ask if they are aware of role of homeostasis and feedback mechanisms.

Learners will come up with varied answers. Some correct, some near to correct, others being irrelevant.

Teacher will not demotivate the child. But agreeing to the correct answers, move further in discussion.

Using short lecture technique, teacher will explain the causes of changes in internal environment.

The teacher also explains the process of formation of tissue fluids.

11.7 ADDITIONAL CONTENT FOR THE TEACHER

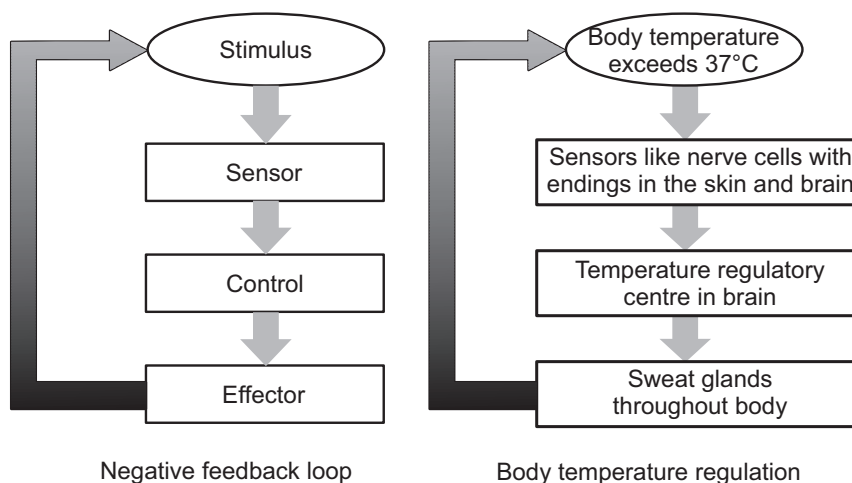

11.8 SUMMARY

- Homeostasis is the ability of a living body to maintain a relatively stable internal environment.
- Homeostasis is an important characteristic of living things requiring continuous adjustments due to the changes occurring in internal and external environment.
- Variables that must be kept constant and regulated to the normal level (set points) in a body are temperature, glucose, pH, water, ions, respiratory gases and osmotic pressure of body fluids.
- Homeostatic control mechanisms have three interdependent components: receptor, integration centre and effectors.
- Negative feedback occurs when the response to a stimulus reduces the original stimulus.
- Positive feedback occurs when the response to a stimulus increases the original stimulus.
- The nervous system controls the activities of body parts quickly to external and internal stimuli.
- The endocrine system regulates body activities slowly with long lasting effects.
- The hypothalamus is a part of brain and link the nervous system and endocrine system.
- The homeostatic mechanisms are altered or interrupted based on internal (genetic) and external (lifestyle choices and environmental exposures) factors.
- Interstitial/tissue fluid is formed from blood plasma and it surrounds and bathes the cells in tissue spaces.
- Tissue fluid provides nutrients and removes waste products from the cells of the body.
- Tissue fluid is formed due to the pressure difference in flow of the blood through the blood capillaries.
- Tissue fluid contains sugars, salts, fatty acids, amino acids, coenzymes, ions, hormones, neurotransmitters, as well as metabolic waste products from the cells in a water medium.
- Tissue fluid moves from tissue spaces to lymph vessels (lymph), to lymph nodes and finally returns to the blood.
- Adaptation is a feature/characteristic of an animal which enables it to survive in its habitat.
- Different organisms have adapted to distinct habitats and environmental conditions. Three categories of adaptations are structural, physiological and behavioural. Each type of adaptation has its own survival value.

11.9 WEBLINKS FOR CONTENT ENRICHMENT

- <http://www.britannica.com/science/homeostasis>
- <https://www.khanacademy.org/partner-content/mit-k12/mit-k12-biology/v/homeostasis>
- <http://study.com/academy/lesson/what-is-homeostasis-definition-examples-quiz.html>

11.10 LEARNERS' ACTIVITIES

Activity 1

The teacher should ask the learners to use internet (Google or Yahoo links) and library to find information regarding homeostasis. Guide them to prepare the collected material in a proper format and present their findings in class. Questions can be asked regarding homeostasis and its examples.

Activity 2

The teacher should guide the learners to form small groups in the class and discuss diabetes and high blood pressure. Ask them to write the causes and symptoms of above conditions in activity notebook.

Activity 3

The teacher should divide the class into four groups and ask each group to draw the charts/diagrams related with negative feedback mechanisms. Each group can represent one example like temperature, blood glucose, etc. Guide the learners to collect material from books/ internet sources such as images/pictures. Well presented charts regarding the mechanism/s can be pasted in the classroom.

Activity 4

The teacher should ask the learners to collect the required material. The teachers should guide the learners to perform the activity.

Hint:

Rubber tube should not be very thick, and cleaned properly. Holes should be very small. Do not collect water for initial 2–3 seconds flowing from the holes except at the last end as the whole tube should have water before collection in beakers. This is necessary to reduce chances of difference in volume occurring due to incoming of more water from the end (high pressure) near to the tap. Measurement and observations should be done carefully.

The end near to water tap is high pressure end (similar to arterial end in which the blood is pumped by the heart) and other end is low pressure (similar to venous end of blood capillaries). Volume of water expelled from the holes (similar to water and solutes coming out at the arterial end) near to high pressure should be more.

Activity 5

The teacher should guide the learners about various adaptations of animals such as why birds have feathers (help in flight), body colour and pattern of tiger skin (camouflage with its surroundings), body shape of fishes (streamline shape helps in swimming), hunting pattern of lions (hunting in groups helps in easy catching of prey) etc. If possible, teacher can click photographs. Ask the learners to give a report about field trip, including different animals found on land, water and other places.

11.11 ANSWERS TO SELF-EVALUATION

Self-evaluation

- (i) pH 7.0, pH 7.8
- (ii) Homeostasis
- (iii) glands
- (iv) Negative feedback
- (v) Negative feedback, Positive feedback

Self-evaluation

- (i) encystment
- (ii) Dolphin
- (iii) Heredity, Lifestyle
- (iv) the walls of capillaries
- (v) Arctic fish

11.12 ANSWERS TO END UNIT ASSESSMENT 11

I. Choose whether the following statements are True (T) or False (F):

1. **True;** A living body ensures stable internal conditions in order to survive, grow and develop. The homeostatic mechanisms are inevitable for proper functioning of the body.
2. **True;** All living organisms have an ability to maintain stable internal conditions. It requires continuous adjustments to the changes occurring in both internal and external environment. This self regulating property of living beings to maintain a constant internal environment is termed as 'homeostasis'

3. **True;** Blood pressure is the measure of the force of blood pushing against blood vessel walls. The heart pumps blood into the arteries (blood vessels), which carry the blood throughout the body.
4. **False;** The nervous system controls the activities of body parts by reacting quickly to external and internal stimuli. The endocrine system regulates those activities slowly but its effects are long lasting.
5. **True;** Organisms living in various habitats need different adaptations in order to maintain homeostasis. The animals adapt to such changes in their environment which threatens their chances of survival.
6. **False;** Physiological adaptations are related to the working of an organism's metabolism. These adaptations enable the organism to regulate their bodily functions, such as breathing and temperature, and perform special functions like excreting chemicals as a defence mechanism.
7. **True;** These chemical messengers are known as hormones which regulate body activities.
8. **False;** The thick fur (and fat layer beneath) on the skin insulates the body and prevents heat loss.
9. **True;** Whales are endothermic and can survive in different water temperatures.
10. **False;** Colonial habit is an adaptation to obtain food and survive predation.
11. **False;** Camel's hump stores fats which gets metabolized during long periods when camel do not eat.

II. Multiple choice questions:

1. **(b);** Production of milk (lactation) occurs in nursing mother by the action of baby sucking. It stimulates hypothalamus which produce oxytocin (a hormone) and sends it to the posterior pituitary gland. This stimulates milk letdown. More the baby suckles, more the milk is produced.
2. **(b);** Glucagon increases the level of blood glucose by converting stored glycogen into glucose.
3. **(d);** Stimulus is received by receptor which transmit the signal to control the centre which further signals to effectors for response.
4. **(a);** Blood glucose levels are maintained by insulin and glucagon which functions in opposite. Insulin is released when glucose level are high while in low blood glucose, glucagon is released.
5. **(c);** Nervous system controls body activities rapidly and endocrine system regulates the activities slowly but long lasting.

6. **(c)**; Homeostasis maintain constant internal conditions by keeping the fluctuating factors within tolerable limits.
7. **(d)**; Blood contains red blood cells, platelets and plasma proteins which remain within the blood capillaries and only plasma gets exuded in the tissue spaces.
8. **(a)**; “Thermostat” or hypothalamus is a part of nervous system (brain) which controls key homeostatic processes such as regulation of body temperature.
9. **(c)**; Parathyroid hormone is released from parathyroid glands while Calcitonin is released from thyroid gland.
10. **(c)**; An increase in vasopressin will increase the fluid volume by acting on kidneys which helps in retention of water and reduction of urine output.

III. Long answer type questions:

1. All living organisms have an ability to maintain stable internal conditions. It requires continuous adjustments to the changes occurring in both internal and external environment. This self-regulating property of living beings to maintain a constant internal environment is termed as ‘homeostasis’ (‘homeo’, “similar,” and ‘stasis’, “stable”). Homeostasis is a key concept in the understanding of biological mechanisms that play an important role in survival of individual cells, to an entire body.

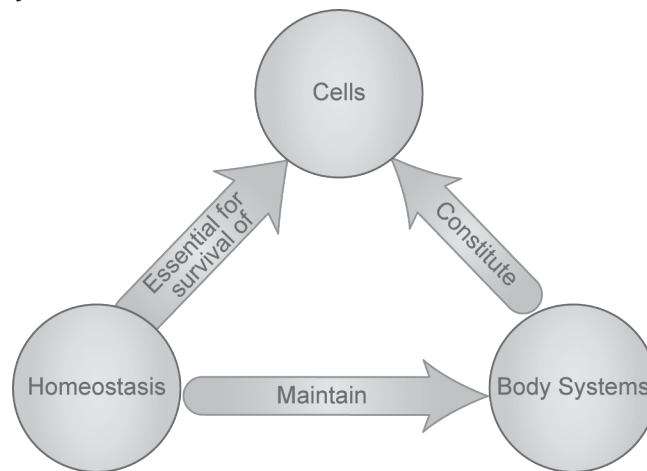

A living body ensures stable internal conditions in order to survive, grow and develop. The homeostatic mechanisms are inevitable for proper functioning of the body. Many systems of the body operate together to maintain a steady state. The cells, tissues, and organs may perform very different functions; however, all the cells in the body are similar in their metabolic needs. Homeostasis continuously provides the necessary ingredients of survival, for example, oxygen

and nutrients to cells and thus, to complete body. The metabolic activities and cellular processes can continue even though the external environment fluctuates substantially. Therefore, the regulation of an optimal internal environment enables an organism to live in wider range of environmental conditions.

2. Homeostasis can be considered as dynamic equilibrium rather than a constant, unchanging state. The body mechanisms maintain various fluctuating physical and chemical variables within tolerable limits. These important variables include temperature, glucose, pH, water, ions, respiratory gases and osmotic pressure of body fluids among others. Some principal homeostatic mechanisms in humans to the kept constant are as follows:

- The maintenance of a steady body temperature involves mechanisms such as sweating or shivering. These mechanisms occur whenever the internal body temperature becomes high or low.
- The human body constantly works to maintain a normal glucose level in blood. When glucose levels are high, a hormone called insulin is released by beta cells of the pancreas. Insulin stimulates the conversion of glucose as insoluble glycogen by the body cells. This lowers the glucose concentration in the blood. A condition called as diabetes occurs due to the deficiency of insulin in the body, due to which glucose level of blood increases. When the blood glucose levels are low, another hormone known as glucagon is released by the alpha cells of pancreas. Glucagon breaks down stored glycogen in the form of glucose. The addition of glucose in blood returns the body glucose levels to normal.
- Whenever the water content of the blood and lymph fluid gets low, it is restored initially by extracting water from the cells. Also, the throat and mouth becomes dry. These symptoms of thirst motivate humans to drink water.
- When high amount of salt and ions are present in the body, the kidneys produce concentrated urine. This process removes extra amount of salt and ions while conserving water, and returns the body to normal metabolic range. In contrast, when the salt and ions concentration is low in the human body, kidneys produce dilute urine and conserve salt and ions.
- A change in breathing and heart rate occurs in humans due to various activities like exercise. As a result, the amount of carbon dioxide produced and oxygen demand in the body increases. The heart rate increases so that the blood flows rapidly to the tissues to fulfill the oxygen requirement and remove the carbon dioxide from the cells. Also, the speed and depth of breathing increases. The body work to normalize breathing and heart rate when activity stops.

- The pH of the blood is regulated at 7.365 (a measure of alkalinity and acidity). The tolerable lower and upper limit for a human body is about pH 7.0 and pH 7.8, respectively. To prevent a change in the pH, all body fluids, including cell cytoplasm are buffered (buffer is a chemical or a combination of chemicals) absorbing either hydrogen ions (H⁺) or hydroxide ions.
3. Negative feedback consists of reducing the output or activity of any system or organ back to its normal range of functioning. This change either raises or lowers the variable to its normal set point automatically by counteracting. Here, negative means 'opposite, not bad'. This can be understood by the controlling process that regulates blood pressure. Blood pressure is the measure of the force of blood pushing against blood vessel walls. The heart pumps blood into the arteries (blood vessels), which carry the blood throughout the body. Whenever the blood pressure increases, the blood vessels can sense the resistance of blood flow against the walls. The blood vessels act as the receptors and relay the change to the brain. The brain acts as control centre and transmit the signal to the heart and blood vessels, both of which act as the effectors. The heart rate would decrease as the blood vessels increase in diameter, known as vasodilation. This change would cause the blood pressure to fall back to its normal range. The opposite would happen when blood pressure decreases, leading to vasoconstriction (decrease in diameter of blood vessel) .

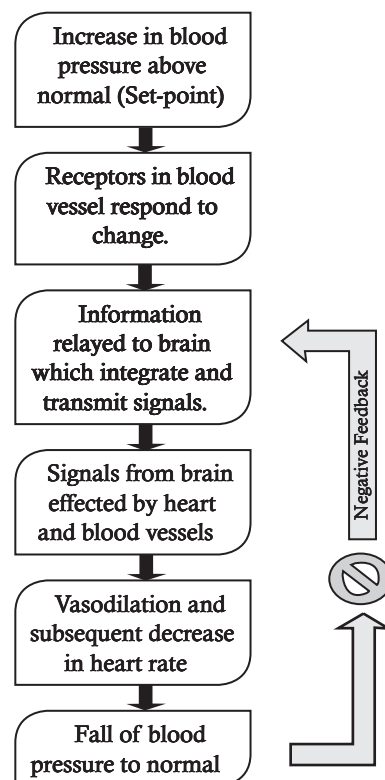

Several factors/conditions interfere with the normal process of regulation of blood pressure. Smoking, obesity, high salt concentration in diet, alcohol consumption, stress, hormonal disorders affect the heart and blood vessels. This leads to high blood pressure or hypertension which cause the heart to work harder to pump blood in the body. This can further damage the heart, blood vessels and other organs. Negative feedback mechanisms are most common in living organisms, working in a specific manner.

4. In the human body, all the organs and organ systems are controlled by nervous and endocrine systems. The nervous system controls the activities of body parts by reacting quickly to external and internal stimuli. The endocrine system regulates those activities slowly but its effects are long lasting. The hypothalamus is a part of the brain (nervous control center) located just above the brain stem and consists of a group of neurons that forms the primary link between the nervous system and the endocrine system. This small part of the brain is responsible for regulating many key body processes, including internal body temperature, hunger, thirst, blood pressure, and daily body rhythms.

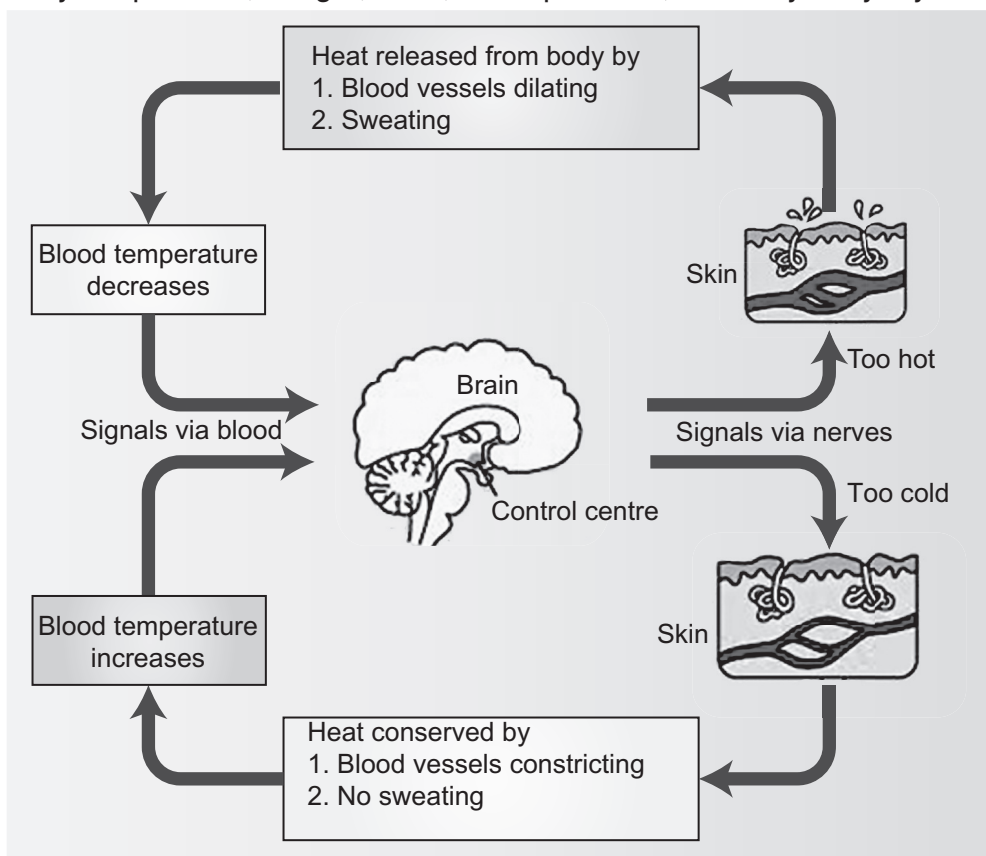

Nervous system consists of receptive nerve cells which transmit the signal to the brain which in turn command the effector nerve cells, muscles and glands to respond. For instance, humans maintain a constant body temperature, usually about 37.4°C . It increases during the day by about 0.8°C and decrease slightly during sleeping. The core body temperature is usually about $0.7\text{--}1.0^{\circ}\text{C}$ higher than skin or axillary temperature. A change in temperature is sensed by receptors found in the skin, veins, abdominal organs and hypothalamus. The receptors

in the skin provide the sensation of cold and transmit this information to brain. The brain process and commands for the vasoconstriction of blood vessels in the skin and limb. This drops the surface temperature, providing an insulating layer (fat cell) between the core temperature and the external environment. The major adjustment in cold is shivering to increase the metabolic heat production. On the contrary, if the body temperature rises, blood flow to the skin increases, maximizing the potential for heat loss by radiation and evaporation.

The endocrine system consists of glands which secrete hormones into the bloodstream. Each hormone has an effect on one or more target tissues. In this way, it regulates the metabolism and development of most body cells and its systems through feedback mechanisms, mostly negative. For example, when blood calcium becomes too low, calcium-sensing receptors in the parathyroid gland become activated. This results in the release of Parathyroid Hormone (PTH), which acts to increase blood calcium by release from the bones. This hormone also causes calcium to be re-absorbed from urine and the gastrointestinal tract. Calcitonin, released from the thyroid gland function in reverse manner, i.e., decreasing calcium levels in the blood by causing more calcium to be fixed in bones. Both the nervous and endocrine system of the human body coordinate to ensure a balance between fluid gained and fluid loss. The ADH (Anti-diuretic Hormone) or vasopressin is the principal compound that controls water balance by decreasing water output by the kidney. Vasopressin is formed in the hypothalamus and get stored in the posterior pituitary (a part of endocrine system). If the body becomes fluid-deficient, osmoreceptors (monitor blood plasma osmolality) in the hypothalamus signals for the release of vasopressin from posterior pituitary. An increase in the secretion of vasopressin causes retention of fluid by the kidneys and subsequent reduction in urine output. Conversely, if fluid levels are excessive, release of vasopressin is suppressed resulting in less retention of fluid and resulting increase in the volume of urine produced.

5. Homeostasis is maintained through a series of control mechanisms. When homeostatic process is interrupted, the body can correct or worsen the problem, based on certain influences. There are internal and external causes influencing the body's ability to maintain homeostatic balance.

Internal Causes:

Heredity Genetic/Reproductive: A variety of diseases and disorders occurs due to the change in the structure and function of genes. For example, cancer can be genetically inherited or can be induced due to a gene mutation from an

external source such as UV radiation or harmful drugs. Another disorder, Type 1 diabetes, occurs due to the lack or inadequate production of insulin by the pancreas to respond to changes in a person's blood glucose level.

External Causes

Lifestyle Nutrition: A diet lacking specific vitamin or mineral leads to the cellular malfunction. A menstruating woman with iron deficiency will become anaemic. As iron is required for haemoglobin, an oxygen transport protein present in red blood cells, the blood of an anaemic woman will have reduced oxygen-carrying capacity.

Physical Activity: Physical activity is essential for proper functioning of our cells and bodies. Adequate rest and exercise are examples of activities that influence homeostasis. Lack of sleep causes ailments such as irregular cardiac (heart) rhythms, fatigue, anxiety and headaches. Overweight and obesity are related to poor nutrition and lack of physical activity greatly affects many organ systems and their homeostatic mechanisms. It increases a person's risk of developing heart disease, Type 2 diabetes, and certain forms of cancer.

Mental Health: Both the physical and mental health is inseparable. Negative stress (also called distress) leads to thoughts and emotions harmful for homeostatic mechanisms in the body.

6. The blood supplies nutrients and essential metabolites to the cells of a tissue and collects back the waste products. This exchange of respective constituents between the blood and tissue cells occurs through *interstitial fluid or tissue fluid* formed by the blood. The fluid occupies the spaces between the cells known as tissue spaces. It is the main component of the extracellular fluid, which also includes plasma and transcellular fluid. On an average, a person has about 10 litres of interstitial fluid making 16% of the total body weight.

Formation

The formation of the tissue fluid is based on the difference in pressure of flowing (Starling's law) of blood through capillaries. A hydrostatic pressure is produced at the arterial end of blood capillaries which is generated by the heart. This results in expulsion of water and other solutes (known as plasma) from capillaries except blood proteins (like serum albumin). This retention of solutes in capillaries creates water potential. The osmotic pressure (water moves from a region of high to low concentration) tends to drives water back into the capillaries in an attempt to reach equilibrium. At the arterial end, the hydrostatic pressure is greater than the osmotic pressure, so the net movement favours

water along with solutes being passed into the tissue fluid. At the venous end, the osmotic pressure is greater, so the net movement favours tissue fluid being passed back into the capillary. The equilibrium is never attained because of the difference in the direction of the flow of blood and the solutes imbalance created by the net movement of water.

Composition

As the blood and the surrounding cells continually add and remove substances from the interstitial fluid, its composition continually changes. Water and solutes can pass between the interstitial fluid and blood via diffusion across gaps in capillary walls called intercellular clefts; thus, the blood and interstitial fluid are in dynamic equilibrium with each other. Generally, tissue fluid consists of a water solvent containing sugars, salts, fatty acids, amino acids, coenzymes, hormones, neurotransmitters, as well as metabolic waste products from the cells. Not all of the contents of the blood pass into the tissue, which means that tissue fluid and blood are not the same. Red blood cells, platelets, and plasma proteins cannot pass through the walls of the capillaries. The resulting mixture that does pass through is, in essence, blood plasma without the plasma proteins. Tissue fluid also contains some types of white blood cells, which help to combat infection.

Movement

To prevent a buildup of tissue fluid surrounding the cells in the tissue, the lymphatic system plays an important role in its transport. Tissue fluid can pass into the surrounding lymph vessels where it is then considered as lymph. The lymphatic system returns protein and excess interstitial fluid to the blood circulation. Thus, it is transported through the lymph vessels to lymph nodes and ultimately with blood in the venous system, and tends to accumulate more cells (particularly, lymphocytes) and proteins.

7. Every organism has certain features or characteristics which enables it to live successfully in its particular habitat. These features are called adaptations, and the organism is said to be adapted to its habitat. Organisms living in various habitats need different adaptations in order to maintain homeostasis. The animals adapt to such changes in their environment which threatens their chances of survival. The main threats are temperature, lack of water and food. Besides the environmental threats, many animals also need to be able to defend themselves from predators and pathogens. Different organisms have adapted to the great diversity of habitats and distinct conditions in the environment.

Although, the adaptations are many and varied, they can be categorized into mainly three types: Structural, physiological and behavioural.

Structural Adaptations

Structural (or morphological) adaptations are the physical features of the organism. It includes shapes or body covering as well as its internal organisation. Microscopic organisms which include protozoans and bacteria employ encystment (a state of suspended form, separated by the outside world by a solid cell wall) to surpass hostile conditions for long periods of time, even millions of years. Larger animals like polar bears are well adapted for survival in the cold climate of Arctic region. They have a white appearance to camouflage from prey on the snow and ice. Also, polar bear have thick layers of fat and fur, for insulation against the cold and a greasy coat which sheds water after swimming.

Dolphins are fish-like mammals have streamlined shape and fins instead of legs. They also have blowholes on the tops of their heads for breathing, rather than their mouth and nose. Desert animals like camels have many adaptations that allow them to live successfully in hot and dry conditions. They have long eyelashes and nostrils that can close and open to prevent entry of sand. Thick eyebrows shield the eyes from the desert sun. Camels store fat in the hump which can be metabolised for energy. A camel can go a week or more without water, and they can last for several months without food. Their huge feet help them to walk on sand without sinking into it. Similarly, the long necks of giraffes allow them to feed among treetops and spot predators. Also, they have tough and long tongues (upto 18 inches) enabling to pull leaves from branches without being hurt by the thorns. Spotted coat camouflages giraffes among the trees. In tropical areas, natural radiators are an efficient way of lowering the body's temperature: for instance, the ears of the elephant and the rabbit are full of blood vessels, helping the animal cool its body in the heat. Rabbits living in Arctic areas have smaller ears.

Physiological Adaptations

Physiological adaptations are related to the working of an organism's metabolism. These adaptations enable the organism to regulate their body functions, such as breathing and temperature, and perform special functions like excreting chemicals as a defence mechanism (Sea stars). Chameleon (a reptile) changes colour or body markings in order to blend into its surroundings. Marine mammals such as whales are endothermic/warm blooded (able to maintain a constant

body temperature). They cope with the temperature changes during migration over large distances and can spend time in arctic, tropical and temperate waters. In opposite, Arctic fish (cold-blooded animals) lives easily in temperatures lower to sub-zero level. Such temperatures results in the formation of ice crystals in the organism's cells that may cause irreversible damage and ultimately, death. However, arctic fishes living in the same freezing waters survives due to an antifreeze protein in the blood that prevents ice crystals formation in their cells and maintains metabolic functions.

Behavioural Adaptations

Behavioural adaptations are learned that help organisms to survive. The whales produce sounds that allow them to communicate, navigate and hunt prey. Bears hibernate or 'sleep' through the coldest part of the year. Bryozoans are water dwelling small individual animals found in colonies in high numbers on the continental shelf in New Zealand. These animals band together for collecting food and survive predation. Penguins are the flightless birds found in the oceans around Antarctica. During extreme winter, Emperor penguins show social behaviour by huddling together in groups comprising several thousand penguins to stay warm.

8. Homeostasis is the process by which the body maintains normal conditions for things like temperature, heart rate and growth rate. Environmental pollution can dramatically affect homeostasis because chemical pollutants can behave like hormones, the molecules that organs use to "talk" to each other. Homeostasis can be affected in many ways. These include direct damage to the organs involved in maintaining homeostasis, mimicry of hormones that control homeostasis, and deficiencies in vitamins that are needed to maintain healthy organs. Disruption of homeostasis by environmental pollution can result in cancer, neurological diseases and breathing problems. Organisms need to be able to maintain nearly constant internal environments in order to survive, grow and function effectively. Homeostatic mechanisms resist the changes to the organism's internal environment. These complex mechanisms are specific to each individual factor, and act via one of two distinct pathways: positive and negative feedback. In the yeast species, Internal pH, water potential and temperature are among the many factors whereby homeostatic maintenance is vital for normal cell function.

Cells depend on the body environment to live and function. Homeostasis keeps the body environment under control and keeps the conditions right for cells to

live and function. Without the right body conditions, certain processes (e.g., osmosis) and proteins (e.g., enzymes) will not function properly.

Living cells depend on the movement of chemicals around the body. Chemicals such as oxygen, carbon dioxide and dissolved food need to be transported into and out of cells. This is done by the processes of diffusion and osmosis, and these processes depend on the body's water and salt balance, which are maintained by homeostasis.

Cells depend on enzymes to speed up the many chemical reactions that keep the cell alive and make it do its job. These enzymes work best at particular temperatures, and so again homeostasis is vital to cells as it maintains a constant body temperature.

11.13 ASSESSMENT METHODS

Use observation technique, question answer technique, and demonstration technique to assess the learners' achievement of learning objectives.

11.14 ASSESSMENTS

Formative Assessment

Fill in the blanks:

1. mechanisms are inevitable for proper functioning of the body.
2. The human body constantly works to maintain a normal level in blood.
3. In the human body, all the organs and organ systems are controlled by and systems.

Ans. 1. homeostatic, 2. glucose, 3. nervous, endocrine

Summative Assessment

Answer in one word:

1. Responds to the command of the control centre by either opposing or enhancing the change.
2. A feature or characteristic of an organism which helps in its survival in a particular habitat.
3. A response system which amplifies the change in the variable.

Ans. 1. Effector, 2. Adaptation, 3. Positive feedback

Unit 12: Regulation of Glucose

12.1 LEARNING OBJECTIVES

| Knowledge and Understanding | Skills | Attitudes and Values |
|--|---|--|
| <ul style="list-style-type: none"> • Describe the role of hormones in sugar regulation. • Describe the detailed structure of a liver lobule and the Islet of Langerhans. • Explain the negative feedback mechanism in the process of blood glucose control. • Discuss the causes and effects of blood sugar imbalances in the body. • Describe the functions of the liver and pancreas in the regulation of glucose in the body. • Describe the three main stages of cell signalling in control of blood glucose by adrenaline as follows: <ul style="list-style-type: none"> ◆ Hormone-receptor interaction at the cell surface. ◆ Formation of cyclic AMP that bind to kinase protein. ◆ An enzyme cascade involving activation of enzymes by phosphorylation to amplify the signal. | <ul style="list-style-type: none"> • Test coloured water (simulated urine) for glucose. • Relate the structure of the liver and the pancreas to their functions. • Relate the microstructure of the liver and the pancreas to sugar regulation. • Make research using internet or articles on the role of adrenaline in the control of blood sugar. | <ul style="list-style-type: none"> • Appreciate the importance of a controlled diet for diabetics. • Assist diabetics and people having hypertension in coping with their situation. |

| | | |
|--|--|--|
| <ul style="list-style-type: none"> • Explain the principles of the operation of dip sticks and biosensors for quantitative measurements of glucose in the blood and urine. • Explain how urine analysis is used in diagnosis with reference to glucose, protein and ketones. | | |
|--|--|--|

12.2 TEACHING AIDS

Visual: Images of human excretory system.

Audio-video: Video of structure of human excretory system.

12.3 TEACHER'S TIP

Start the unit by briefing the learners with the importance of glucose. Explain the glucose as the main source of energy and then explain the structural component of glucose and glycogen. After that, discuss the role of liver and pancreas in glucose regulation.

12.4 TEACHING METHODS

Brainstorming, short lecture technique, group discussion technique, observation technique, drawing technique, demonstration technique, field visit, site visit and practical work.

12.5 TEACHING AND LEARNING MATERIALS

Charts/illustrations, computer aided study materials, microscopes and accessories.

12.6 TEACHING METHODOLOGY

Teacher initiates the topic by explaining the importance of glucose.

Teacher also discusses the role of liver and pancreas in glucose regulation. Ask the learners to tell something about it if they know.

Learners reply to the teacher.

Appreciating them, further ask if they are aware of the role of insulin and glucagon.

Learners will come up with varied answers. Some correct, some near to correct, others being irrelevant.

Teacher will not demotivate the child. But agreeing to the correct answers, move further in discussion.

Using short lecture technique, teacher will explain the homeostatic control of blood glucose level.

The teacher also explains the diabetes and its types.

The teacher also explains the monitoring of glucose level.

The teacher asks the learners if they know about glucose test and explains how it is done through an activity.

Perform all activities as directed in the text explaining the key concepts and engaging the learners to participate in discussions and brainstorm on various issues such as diabetes.

12.7 ADDITIONAL CONTENT FOR THE TEACHER

Plasma contains glucose (0.1 per cent) as blood sugar. Usually, blood glucose level is about 80–100 mg per 100 ml of blood 12 hours after a normal meal. But its concentration rises more soon after a carbohydrate rich diet. If blood glucose level exceeds 180 mg per 100 ml, it starts appearing in urine. This condition is called **glucosuria**. Fasting glucose is 70–110 mg/dl (decilitre). The glucose level after breakfast or post prandial (PP) is 110–140 mg/dl. If it is higher, it causes **diabetes mellitus (hyperglycemia)**, and its low level causes **hypoglycemia** (i.e., less amount of glucose in the blood).

Regulation of Blood Glucose Levels: Insulin and Glucagon

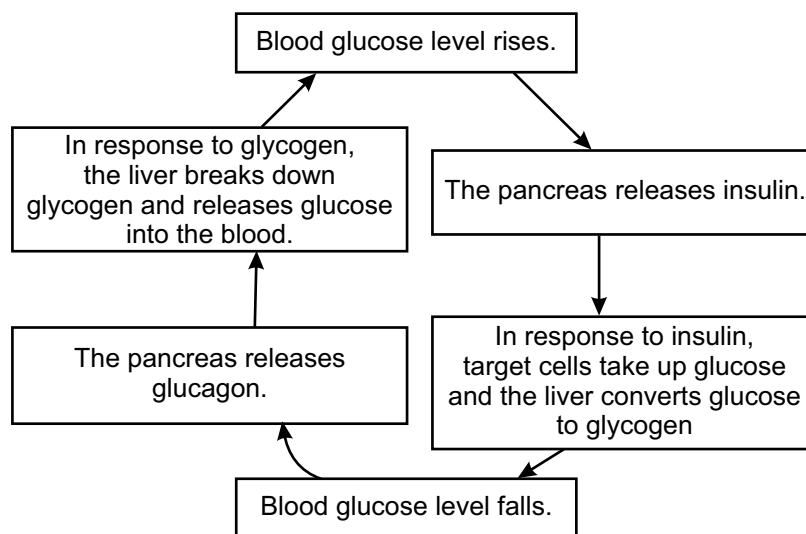

Activity

The teacher can demonstrate this activity in the class.

Aim: Make a chart showing diabetes mellitus.

Ask the learners to make a chart showing causes of diabetes.

Ask the learners to include how to monitor blood glucose level in blood.

Ask the learner to present this chart in the class.

Ask the learners to discuss the chart with the rest of the learners.

12.8 SUMMARY

- Glucose is the universal fuel which provides energy to all the living cells.
- Glucose is converted to glucose-6-phosphate with the help of enzyme glucokinase in liver and hexokinase in most cells, which help the cells to retain glucose.
- One molecule of glucose yields 38 molecules of ATP.
- Polysaccharides of glucose viz. cellulose, chitin are important structural component of plants and animal cells.
- Excess glucose in the body is stored in the form of glycogen through glycogenesis.
- When the blood glucose level falls, glycogen breaks down into glucose through glycogenolysis.
- Pancreas and liver are the main organs responsible for regulation of blood glucose level.
- Pancreas secretes insulin and glucagon hormones responsible for glucose regulation.
- Exocrine pancreas release digestive enzymes including trypsin, chymotrypsin, amylase and lipase.
- The islet of langerhans is the endocrine component of pancreas and secretes insulin (by beta cells), glucagon (by alpha cells), somatostatin (by delta cells) and pancreatic poly-peptide (by F cells).
- Liver is a vital organ of our body which performs various functions ranging from protein synthesis to detoxification of drugs.
- Liver lobes are composed of small units, known as liver lobules.
- Insulin stimulates rapid glucose uptake by cells, promote glycogenesis while inhibiting glycogenolysis and gluconeogenesis resulting in decreasing blood glucose level.
- Glucagon activates enzyme glycogen phosphorylase and initiates glycogenolysis in the liver and muscle cells.
- In liver cells glucagon increase the rate of amino acid uptake and converts it into glucose.

- Blood glucose level regulation by insulin and glucagon is an excellent example of negative feedback mechanism where the effect of one hormone stimulates the other hormone and vice versa.
- Hormonal regulation of glucose is a three-step process which involves hormone-receptor interaction followed by activation of second messenger, cAMP and a series of enzyme cascade.
- Hyperglycemia is a condition when the blood glucose level rises higher than the normal level.
- Hypoglycemia is the condition when the serum glucose level is below 70 mg/dL.
- Diabetes mellitus is a chronic condition associated with abnormally high levels of glucose in the blood.
- The concentration of insulin increase in the blood (hyperinsulinemia) as more and more insulin is secreted by beta cells in response to decrease sensitivity by cells. This condition is known as insulin resistance.
- Blood glucose monitoring is a very important exercise to keep the glucose level checked and avoid various harmful consequences of high blood sugar due to diabetes mellitus.
- Urine analysis of glucose, ketone bodies and protein, blood glucose test, glucose tolerance test and acetone breath test.

12.9 WEBLINKS FOR CONTENT ENRICHMENT

- <http://hyperphysics.phy-astr.gsu.edu/hbase/organic/sugar.html>
- <https://www.nlm.nih.gov/medlineplus/ency/article/003482.htm>
- <https://www.virginiamason.org/whatarenormalbloodglucoselevels>

12.10 LEARNERS' ACTIVITIES

Activity 1

The teacher should take the learners to a nearby hospital to notice patients and their behaviour.



Hint:

In the hospital, patients are generally given glucose by drip instead of food because, the drip directly deposits the glucose into the blood stream and hence the body cells get it in matter of minutes, but if it is given through food the glucose's energy would reach the body parts only after the digestion process and this will take a longer time.

A glucose intravenous solution is provided to patients in a bottle lying hanging from a stand, will boost the energy system of a person. Glucose is the most predominant monosaccharide in our body and one of the sources of energy. So when the body needs glucose in cases where there is low blood glucose levels (hypoglycemia, severe hunger, etc), then a drip (intravenous) is given rather than an oral dose, because it goes directly into the blood stream and boosts rapidly the body's system.

Glucose drip is essentially sugar water. Therefore, it gives your body energy to

- (a) Replace the lost blood
- (b) Keep the body hydrated
- (c) Give the body energy it needs to heal.

Activity 2

The teacher should guide the learners to perform the activity.

Hint:

Other than liver and pancreas, Adrenal glands and Anterior pituitary also help in glucose regulation.

- (a) Adrenal glands: responsible for the secretion of Cortisol and Epinephrine
- (b) Anterior pituitary: secrete Adrenocorticotrophic hormone and Growth hormone

Activity 3

The teacher should provide the learners a compound light microscope and permanent slides of transverse section of liver and pancreas.

The teacher should guide the learners to perform the activity on their own.

Hint:

Place the permanent slide under the light microscope and observe the slide under low magnification followed by higher magnification.

Try to observe the liver lobules and islet of langerhans and draw your observation on your record.

Discuss the structure and relate the observed structure with the function of liver and pancreas.

Note: Care should be taken while focusing the slide under the microscope. Focusing should be done starting from the lower magnification to avoid any unwanted damage to the lens.

Activity 4

The teacher should divide the whole class into groups of 4–5 learners and assist them to perform the activity.

Hint:

1. Discuss the mechanism of glucose regulation within the group.
2. Each group prepares a PowerPoint presentation using internet and available resources.
3. Give the presentation in front of teacher in the classroom.

Activity 5

The teacher should guide the learners to perform the activity.

Hint:

1. The teacher should divide the class into different groups of 4–5 learners.
2. Using internet, find research papers on the role of adrenaline in regulating blood glucose level.
3. Each group studies and discuss a particular research paper.
4. Make PowerPoint presentation of the research paper.
5. Show the presentation in presence of the teacher.

Activity 6

The teacher should assist the learners in performing the activity.

Hint:

1. The teacher should divide the class into different groups of 4–5 learners.
2. Draw the diagram of the negative feedback mechanism of glucose regulation on the chart paper.
3. Illustrate the effect of various hormones on each step.
4. Try to highlight the important steps which can cause or effect the blood sugar balance.

Discussion:

Discuss the different causes and effects of hyperglycemia and hypoglycemia.

Activity 7

The teacher should assist the learners to perform the activity.

Hint:

1. The teacher should divide the class into different groups of 4-5 learners.
2. Using internet, each group study the different symptoms and causes of diabetes mellitus.
3. Each group prepares a PowerPoint presentation and present in front of your teacher in the class.

Discussion:

1. Discuss presentation in the class.

Activity 8

The teacher should guide the learners to perform the activity.

Hint:

1. Wash your hands with soap and water and dry them properly.
2. Prepare the blood glucose meter with the test strip according to the manufacturer's instructions.
3. Use the lancet device to prick the side of your fingertip with a lancet.
4. Place a drop of blood onto the correct part of the test strip.
5. The strip will draw up the blood into the meter and show a digital reading of the blood glucose level within seconds.
6. Note the reading.
7. Use a clean cotton to apply pressure to the fingertip for a few moments until the bleeding stops.
8. Discuss the reading with your concerned teacher.

**Discussion:**

In general, a fasting blood glucose reading (taken before a meal) should be between 72 mg/dL to 126 mg/dL. And a blood glucose reading 2 hours after a meal should be between 90 mg/dL to 180 mg/dL.

Precautions:

1. Make sure the lancelet is properly sterilized.
2. Insert the test strip properly.

Activity 9

The teacher should guide the learners to perform the activity.

Hint:

1. Take 5 ml (one teaspoon) of Benedict's solution in test tube.
2. Holding the test tube with the holder, heat it over a spirit lamp till the Benedict's Solution boils without overflowing.
3. Drop 8 to 10 drops of urine into the boiling Benedict's solution.
4. After again boiling the mixture, let it cool down.
5. Observed the colour change in the mixture.

Discussion:

1. Note down the colour of the mixture after cooling.
2. The colour of the mixture serves as a guide to the amount of sugar in the urine:
 - ✓ Blue – sugar absent;
 - ✓ Green – 0.5% sugar;
 - ✓ Yellow – 1% sugar;
 - ✓ Orange – 1.5% sugar;
 - ✓ Red brown/Red ppt. – 2 % or more sugar.

Precautions:

1. Care should be taken while heating the Benedict's solution.
2. Use disposable gloves while handling the urine sample.
3. Result should be noted only when the solution cold to the room temperature.

Note: Coloured water sample can be used instead of the urine sample to avoid the cases of infection.

Activity 10

The teacher should guide the learners to perform the activity.

Hint:

1. The teacher is to provide a test tube containing coloured water to learners.
2. Write down approximate concentration of glucose depending on the colour of the water.
3. Explain your result.

Discussion:

1. The colour of the water serves as a guide to the amount of sugar in the simulated urine:
 - ✓ Blue – sugar absent;
 - ✓ Green – 0.5% sugar;
 - ✓ Yellow – 1% sugar;
 - ✓ Orange – 1.5% sugar;
 - ✓ Red brown/Red ppt. – 2 % or more sugar.

12.11 ANSWERS TO SELF-EVALUATION**Self-evaluation**

- (i) Glycogen
- (ii) 38
- (iii) left, right, caudate, quadrate
- (iv) Ilets of langerhans

Self-evaluation

- (i) Banting and Best
- (ii) alpha
- (iii) adrenaline
- (iv) Cortisol
- (v) Adenylate cyclase
- (vi) Glucagon

Self-evaluation

- (i) ~70 mg/dL
- (ii) Insuline dependent diabetes mellitus
- (iii) controlled
- (iv) glucose oxidase, hexokinase
- (v) glycosuria

12.12 ANSWERS TO END UNIT ASSESSMENT 12

I. Choose whether the following statements are True (T) or False (F):

1. **True;** Excess glucose in blood is converted into glycogen through glycogenesis in liver.
2. **False;** Trypsin digests proteins not carbohydrates. Amylase is a carbohydrate digesting enzyme.
3. **True;** Bile salt is secreted to bile duct which empties into intestine and helps in digestion.
4. **True;** Glucagon activates glycogenesis in liver and muscle cells and reduces the blood glucose level.
5. **False;** Type II diabetes is caused due to reduced sensitivity of insulin and not due to insufficient insulin secretion.
6. **True;** Type I diabetes mellitus is caused due to insufficient insulin production by the beta cells or absence of beta cells in the pancreatic islet.
7. **True;** The excess Acetyl-CoA formed during lipid metabolism is converted to ketone bodies.
8. **True;** Due to insulin resistance developed in receptor cells, beta cells secrete large amount of insulin which leads to increase in concentration of insulin in blood.
9. **False;** Glycogenolysis is the breakdown of glycogen to glucose.
10. **True;** cAMP is a second messenger compound present inside the cells which is activated by the binding of hormones to its receptor.

II. Multiple choice questions:

1. **(c);** Ribose is formed glucose through Pentose Phosphate Pathway (PPP).
2. **(c);** Overall, 38 molecules of ATP (2 from glycolysis, 2 from Krebs cycle and 34 from oxidative phosphorylation) are produced during the metabolism of a single molecule of glucose.
3. **(a);** Central vein lies in the centre of the liver lobule surrounded by six portal triads.
4. **(c);** Delta cells secrete Somatostatin which regulates both alpha and beta cells.
5. **(b);** Gluconeogenesis is the process of biosynthesis of glucose from non-carbohydrates source like amino acids, pyruvate etc.
6. **(b);** Insulin increases the glucose uptake by body cells.
7. **(d);** The ketone bodies are acetoacetic acid (diacetic acid), hydroxybutyric acid and acetone.

8. **(c)**; GLUT1, GLUT3 and SGLUT2 are all glucose transporter proteins. GLUT5 is responsible for fructose transportation.
9. **(a)**; Glycogen phosphorylase is responsible for glycogenolysis, Glucosidase is glycogen debranching enzyme while Glucose phosphatase convert glucose-6-phosphate back to glucose. Glucose oxidase oxidise glucose to form gluconic acid and H₂O₂ which react with chromogen to give colour to the test.
10. **(d)**; Hypoglycemia is a condition of low blood sugar when the blood sugar level falls below 70 mg/dL.

III. Long answer type questions:

1. Glucose is one of the most important carbohydrates molecules in our body. Body requires glucose to carry out some of its most important functions. Glucose is synthesized in green plants, from carbon dioxide, CO₂ and water, H₂O with the help of energy from sunlight. This process is known as photosynthesis. The reverse of the photosynthesis reaction i.e., breakdown of glucose in the presence of oxygen to form carbon dioxide and water releasing the energy, is the main source of power for all the living organisms. The excess glucose in plants is stored in the form of starch which serves as foods for various animals.

Glucose as Energy Source

Almost 80 per cent of carbohydrates in our food are converted to glucose during digestion in the alimentary canal. Fructose and galactose is the other main product of carbohydrates digestion. After absorption from the alimentary tract, fructose and galactose are converted into glucose in the liver. And therefore, glucose constitutes more than 95 per cent of all the carbohydrates circulating in the blood.

Body cells require glucose continuously for its various metabolic activities. These cells directly absorb glucose from the blood. Once inside the cells, glucose combines with a phosphate moiety to form Glucose-6-phosphate with the help of enzyme glucokinase in liver and hexokinase in most other cells. This phosphorylation reaction is irreversible and helps to retain the glucose inside the cells. However, in liver cells, renal tubular epithelial cells and intestinal epithelial cells, an enzyme glucose phosphatase converts the glucose-6-phosphate back to glucose.

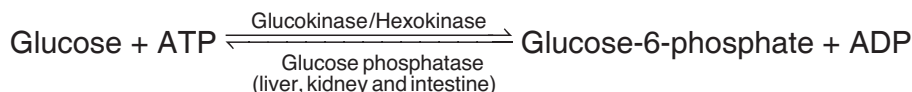

Complete oxidation of one molecule of glucose into carbon dioxide and water inside the cells produce as many as 38 molecules of ATP (2 from glycolysis, 2 from Krebs cycle and 34 from oxidative phosphorylation).

Glucose as Structural Component

As we discussed above, glucose is the main source of energy in all the living cells. Besides being regarded as the universal fuel, glucose also acts as the source of carbon for all the carbon containing compounds of the body. For example, ribose, a pentose monosaccharides used in the synthesis of nucleotides and nucleic acids is synthesized from glucose through Pentose Phosphate Pathway (PPP). Other important compounds include, glycoprotein, a protein with oligosaccharide chains (glycans) covalently attached to their polypeptide side chain; proteoglycans, a special class of glycoproteins which contain about 95% polysaccharide (glycosaminoglycans) and 5% protein and various other polysaccharides like cellulose, chitin, glycogen etc.

- Negative feedback is an important regulatory mechanism for physiological function in all living cells. It occurs when a reaction is inhibited by increase concentration of the product. Regulation of blood glucose level is an excellent example of homeostatic control through negative feedback mechanism.

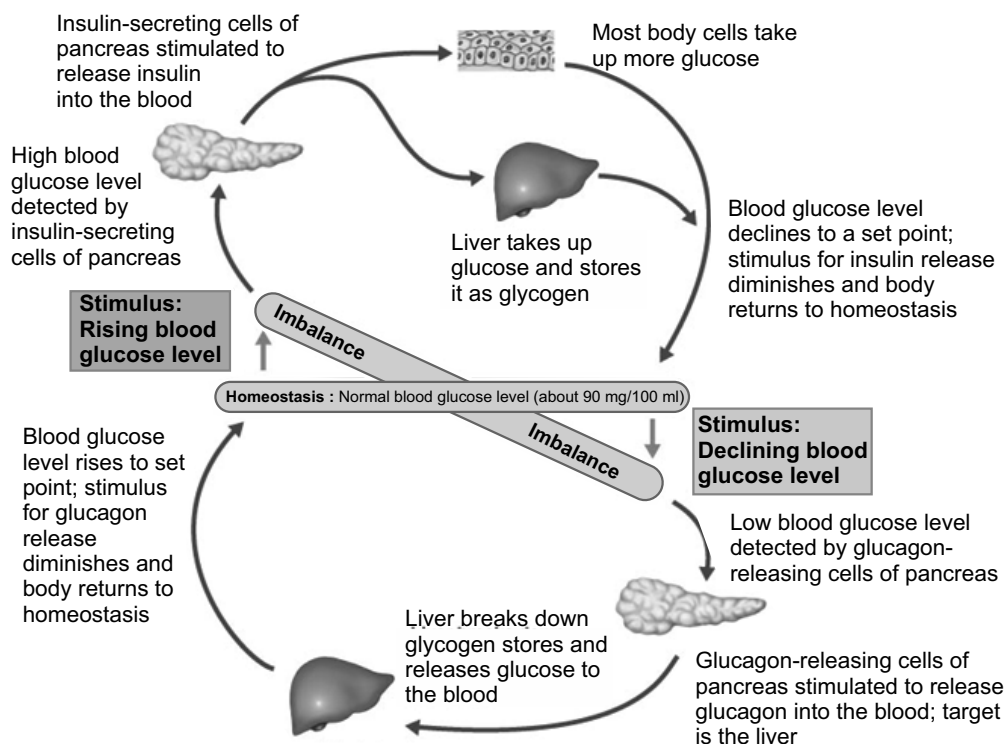

Negative feedback regulation of blood glucose level by insulin and glucagon.

Response to an Increase in Blood Glucose

When there is an increase in blood glucose level, the beta cells of the pancreatic islets of langerhans increase the release of insulin into the blood. Insulin binds to receptors on the cell membrane and stimulates the cell to increase the number of glucose transporters. As the number of transporters increased, more glucose is transported into cells. This led to a decrease in blood glucose level. Besides, insulin also stimulates glycogenesis and glycolysis while inhibiting glycogenolysis, gluconeogenesis, lipolysis etc. which all contributes in reducing blood glucose levels.

Response to a Decrease in Blood Glucose

As the blood glucose level drops, the alpha cells of pancreas islets increase the secretion of glucagon. Glucagon activates enzyme glycogen phosphorylase in the liver and muscle cells which start glycogenolysis. It also promotes gluconeogenesis, lipid metabolism etc. The overall effect of glucagon is increase in the concentration of blood glucose.

3. Pancreas is an elongated, tapered organ, located in the abdominal region, behind the stomach and next to the duodenum - the first part of the small intestine. The right side of the organ, called the head, is the widest part of the organ and lies in the curve of the duodenum. The tapered left side which extends slightly upward is the body of the pancreas. The tail of the pancreas ends near the spleen.

Structure and Function of Pancreas

Pancreas has two main functional components:

1. The Exocrine cells, the acini - cells that release digestive enzymes into the gut via the pancreatic duct. These enzymes include trypsin and chymotrypsin to digest proteins; amylase for the digestion of carbohydrates; and lipase to break down fats. The pancreatic duct joins the common bile duct to form the ampulla of Vater in the duodenum. The pancreatic juices and bile (from gall bladder) released into the duodenum help the body to digest fats, carbohydrates as well as proteins.
2. The Endocrine pancreas – highly vascularized groups of cells known as the Islets of Langerhans within the exocrine tissue constitute the endocrine pancreas. The human pancreas has 1-2 millions islets of Langerhans. It contains four different types of cells which are distinguished from one another by their morphology and staining characteristics;
 - **Alpha cells:** Which secrete glucagon, constitute about 25 per cent of all the cells of islet of langerhans.
 - **Beta cells:** The most abundant of the islet cells constituting about 60% of the cells. It releases insulin and amylin (a hormone with unknown function, secreted in parallel to the insulin).

- **Delta cells:** Constitute about 10 per cent of total cells and secrete somatostatin which regulates both the alpha and beta cells.
- **F cells or PP cells:** It is present in small number and secretes a polypeptide known as pancreatic polypeptide which inhibits the digestive enzymes produced by the exocrine pancreas.

Insulin and glucagon are the major hormones responsible for the regulation of blood glucose. Both insulin and glucagon are secreted by the pancreas, and are referred to as pancreatic endocrine hormones.

Insulin

Insulin is released in response to increase in the concentration of blood glucose. In the blood, it circulates entirely in an unbound form with plasma half-life of about 6 minutes. Only a small portion of the insulin binds with the receptors of the target cells while the rest is degraded by the enzyme insulinase, mainly in liver and to a lesser extent in kidney and muscles.

Function of Insulin

The level of glucose in the blood increases rapidly after meal with high carbohydrates content which stimulate the pancreatic beta cells to increase secretion of insulin. Insulin in turn increases the rate of glucose uptake, storage and utilization by almost all tissues of the body mainly in muscles, adipose tissue and liver. Other important function of insulin includes,

- Insulin promotes glycogenesis by activating enzyme glycogen synthase.
- Insulin inactivates liver phosphorylase, the key enzyme of glycogenolysis.
- Insulin promotes lipid synthesis by increasing the conversion of excess glucose into fatty acids in the liver. These fatty acids are transported as triglycerides to the adipose tissue where it is deposited as fat.
- Insulin inhibits the enzymes responsible for gluconeogenesis in the liver.
- Insulin promotes protein synthesis by increasing the rate of transcription and translation. It also stimulates transport of many amino acids into the cells.
- Insulin inhibits breakdown of lipids and proteins.

Glucagon

Glucagon is secreted by the alpha cells of the pancreatic islets in response to low blood glucose levels and to events whereby the body needs additional glucose, such as in response to vigorous exercise. The effect of glucagon in regulating blood glucose level is exactly opposite of insulin.

Functions of Glucagon

1. Glycogenolysis: The most important function of glucagon is activation of glycogen phosphorylase enzyme responsible for degradation of glycogen to glucose-6-phosphates. The glucose-6-phosphate is then dephosphorylated to form glucose and finally released into the blood stream. The activation of glucose phosphorylase enzymes by glucagon involves the following steps;
 - (a) Glucagon activates the adenylyl cyclase in the hepatic cell membrane to form cyclic adenosine monophosphate (cAMP).
 - (b) The cAMP activates protein kinase regulator protein, which in turns activates protein kinase.
 - (c) Protein kinase activates phosphorylase b kinase.
 - (d) Finally, the phosphorylase b kinase converts phosphorylase b into phosphorylase a (glycogen phosphorylase) which starts glycogenolysis.
 2. Gluconeogenesis: In the liver cells, glucagon increases the rate of amino acid uptake and conversion into glucose.
 3. Glucagon activates adipose cell lipase enzyme which stimulates lipids metabolism.
 4. Glucagon also inhibits the storage of triglycerides in the liver by preventing the liver from removing fatty acids from the blood.
 5. Glucagon also enhances the strength of the heart; increases blood flow in some tissues, especially the kidneys; enhances bile secretion; and inhibits gastric acid secretion.
4. Our body obtains glucose from various foods. It can also synthesis glucose in the liver and muscles from other compounds like pyruvate, lactate, glycerol, and glucogenic amino acids. The blood carries glucose to all the cells in the body where it is metabolized to produce energy. Blood sugar levels keep on fluctuating throughout the day increasing after meals, stimulants such as caffeine and nicotine, or under stressful experiences and decreasing in between meals, or as the effects of stimulants wear off. When the blood glucose level rises beyond the normal value, the condition is known as hyperglycemia. On the other hand, hypoglycemia or low blood sugar is the condition in which the blood glucose level is below normal (~70 mg/dL).

Hyperglycemia

High blood glucose level can be caused due to various reasons like,

1. **Carbohydrates:** Eating food containing too many carbohydrates. The body of a person cannot process high levels of carbohydrates fast enough to convert it into energy.

2. **Insulin control:** The pancreas of the individual unable to produce enough insulin.
3. **Stress:** Stress stimulates the secretion of certain hormones like cortisol and epinephrine etc. which increases the blood glucose level.
4. **Low levels of exercise:** Daily exercise is a critical contributor to regulating blood sugar levels.
5. **Infection, illness, or surgery:** With illness, blood sugar levels tend to rise quickly over several hours.
6. **Other medications:** Certain drugs, especially steroids, can affect blood sugar levels.

A high blood sugar level can be a symptom of diabetes. If hyperglycemia persists for several hours, it can lead to dehydration. Other symptoms of hyperglycemia includes dry mouth, thirst, frequent urination, blurry vision, dry, itchy skin, fatigue or drowsiness, weight loss, increased appetite, difficulty breathing, dizziness upon standing, rapid weight loss, increased drowsiness and confusion, unconsciousness or coma.

Hypoglycemia

Hypoglycemia is generally defined as a serum glucose level below 70 mg/dL. Symptoms typically appear when the blood glucose levels reach below 60 mg/dL and levels below 50 mg/dL can be fatal.

Common causes of low blood sugar include the following:

1. Overmedication with insulin or antidiabetic pills
2. Use of alcohol
3. Skipped meals
4. Severe infection
5. Adrenal insufficiency
6. Kidney failure
7. Liver failure etc.

Common symptoms of hypoglycemia include trembling, clammy skin, palpitations (pounding or fast heart beats), anxiety, sweating, hunger, and irritability. If the brain remains deprived of glucose for longer period, a later set of symptoms can follow like difficulty in thinking, confusion, headache, seizures, and coma. And ultimately, after significant coma or loss of consciousness, death can occur.

5. Diabetes mellitus (commonly referred to as diabetes) is a chronic condition associated with abnormally high levels of sugar in the blood due to impaired

carbohydrate, fat, and protein metabolism. It can be due to absence or insufficient production of insulin by the pancreas, or inability of the body to properly use insulin. It is generally characterized by hyperglycemia, glycosuria (glucose in urine), polyuria (large volume of urine), polydipsia (excessive thirst) and polyphagia (excessive appetite). There are two types of diabetes mellitus – Type I is caused by lack of insulin secretion and Type II is caused by reduced sensitivity of target cells to insulin.

Type I Diabetes

It is known as insulin dependent diabetes mellitus (IDDM) and caused due to insufficient insulin production by the beta cells of pancreatic islet of Langerhans or due to absence of the beta cells itself. Since the pancreas makes very little or no insulin at all, glucose cannot get into the body's cells and remain in the blood leading to hyperglycemia. The concentration of blood glucose level can be as high as 300 – 1,200 mg/dL. The symptoms of Type I diabetes includes

1. Loss of glucose in urine; due to increase blood glucose concentration beyond 180 mg/dL,
2. Dehydration; due to osmotic loss of water from cells and inability to reabsorb water in kidney),
3. Tissue injury; due to damages blood vessels in many tissues,
4. Metabolic acidosis; due to increased fat metabolism,
5. Depletion of body's protein; due to increased protein metabolism.

Type II Diabetes

Also known as non-insulin dependent diabetes mellitus (NIDDM), it is caused due to the inability of cells to take up glucose from the blood. It can be either due to defective insulin receptors over cell surfaces or abnormality of blood plasma protein, amylin. It is associated with increase concentration of insulin (hyperinsulinemia) in blood due to increase secretion by the beta cells in as the insulin sensitivity of cells decreases, a condition known as insulin resistance. Type II diabetes are more common and account for almost 80–90 per cent of the total diabetes mellitus cases.

The symptoms of type II diabetes include

1. Obesity, especially accumulation of abdominal fat;
2. Fasting hyperglycemia;
3. Lipid abnormalities such as increased blood triglycerides and decreased blood high-density lipoprotein-cholesterol; and
4. Hypertension.

Another form of diabetes is the diabetes insipidus which is caused due to hyposecretion of ADH (antidiuretic hormone or vasopressin) by hypothalamus. It is characterized by excretion of large quantity of dilute urine (>5 litres per day). There is no increase in the blood glucose level.

6. Urine analysis can be used to test pH, protein, glucose, ketones, occult blood, bilirubin, urobilinogen, nitrite, leukocyte esterase etc. in the urine sample. It is one of the most important diagnostic procedures for various body disorders. For example, a simple test for glucose in urine can be used to diagnose diabetes mellitus. Generally, healthy persons do not lose glucose in their urine whereas a person with diabetes mellitus loses small to large quantities of glucose in their urine. Generally, a single test doesn't give a reliable result. Therefore, it becomes necessary to carry out multiple urine analysis for different compounds like proteins and ketone bodies to confirm a disorder.

The urine analysis can be simply carried out using a dipstick that is specific for a particular test. A dipstick or the reagent strips is a narrow strip of plastic with small pads attached to it. Each pad contains specific reagents for a different reaction, thus allowing for the simultaneous determination of several compounds. The colours generated on each reagent pad vary according to the concentration of the analytes present.

The glomerular filtrate of a normal kidney contains little amount of low-molecular weight protein. Most of these proteins get reabsorbed in the tubules with less than 150 mg being excreted through urine per day. Therefore, the abnormal increase in the amounts of protein in the urine, Proteinuria, can be an important indicator of renal diseases. There are certain physiologic conditions such as exercise and fever that can lead to increased protein excretion in the urine in the absence of renal disease.

Proteinuria is a symptom of chronic kidney disease (CKD), which can be due to diabetes, high blood pressure, and diseases that cause inflammation in the kidneys. Therefore, urine analysis for protein is part of a routine medical assessment for everyone. If CKD is not checked in time, it can lead to end-stage renal disease (ESRD), when the kidneys completely stop functioning. A person with ESRD requires a kidney transplant or regular blood-cleansing treatments called dialysis to further sustain.

Ketones, or ketone bodies are formed during lipid metabolism. One of the intermediate products of fatty acid breakdown is acetyl CoA. If the lipid metabolism and carbohydrate metabolism are in balanced, Acetyl-CoA enters the citric acid cycle (Krebs cycle) where it reacts with oxaloacetate to form citrate. When carbohydrate is not available in the cells, all available oxaloacetate

get converted to glucose and so none is available for condensation with acetyl CoA. As such, Acetyl-CoA cannot enter the Krebs cycle and is diverted to form ketone bodies.

The ketone bodies are acetoacetic acid (diacetic acid), hydroxybutyric acid and acetone. Acetyl-CoA is first converted to acetoacetic acid which later gets converted to other two ketones through the following reaction:

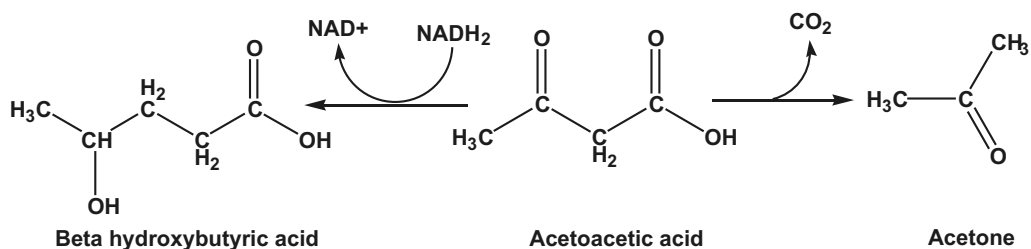

Hydroxybutyric acid is formed by reversible reduction, and acetone is formed by a slow spontaneous decarboxylation. Acetoacetic acid and hydroxybutyric acid are normal fuels of respiration and are important sources of energy. In fact, the heart muscle and the renal cortex prefer to use acetoacetate instead of glucose. The odour of acetone may be detected in the breath of an individual who has a high level of ketones in the blood because acetone is eliminated through lungs.

7. Glucose intolerance, reduced sleep efficiency, and disturbed circadian rhythmicity occur in ageing. In normal young subjects, glucose regulation is modulated by sleep and circadian rhythmicity. To examine age-related alterations in the temporal pattern of glucose tolerance and insulin secretion, eight moderately overweight healthy older men, eight weight-matched young men, and six young lean men were studied during constant glucose infusion for 53 h. Levels of glucose, insulin, C-peptide, and growth hormone (GH) were measured every 20 min. Rates of insulin and GH secretion were calculated by deconvolution. In older volunteers, sleep was shallow and more fragmented than in young subjects but was nevertheless associated with robust glucose elevations. However, post-sleep increases of insulin secretion were markedly dampened. During wakefulness, the normal morning-to-evening increase in glucose was preserved in the elderly, but insulin secretion failed to increase proportionately. Thus, decreased glucose tolerance in ageing is associated with insulin resistance and also with a relative insensitivity of the beta-cell to the modulation of glucose regulation by sleep and circadian rhythmicity.

In a healthy person, blood glucose levels are restored to normal levels primarily through the actions of two pancreatic hormones, namely insulin and glucagon.

If blood glucose levels rise (for example, during the fed or absorptive state, when a meal is digested and the nutrient molecules are being absorbed and used), the beta cells of the pancreas respond by secreting insulin. Insulin has several notable effects: (1) it stimulates most body cells to increase their rate of glucose uptake (transport) from the blood; (2) it increases the cellular rate of glucose utilization as an energy source; (3) it accelerates the formation of glycogen from glucose in liver and skeletal muscle cells; and (4) it stimulates fat synthesis (from glucose) in liver cells and adipose (fat) tissue. These effects collectively cause a decrease in blood glucose levels back to normal levels.

If blood glucose levels fall below normal levels (for instance, during the post-absorptive or fasting state, when nutrients from a recently ingested meal are no longer circulating in the blood, or during starvation), insulin secretion is inhibited and, at the same time, the alpha cells of the pancreas respond by secreting glucagon, a hormone that has several important effects: (1) it accelerates the breakdown of glycogen to glucose in liver and skeletal muscle cells; (2) it increases the breakdown of fats to fatty acids and glycerol in adipose tissue and, consequently, the release of these substances into the blood (which cells can thus use for energy); and (3) it stimulates liver cells to increase glucose synthesis (from glycerol absorbed from the blood) and glucose release into the blood. These effects collectively cause an increase in blood glucose levels back to normal levels.

In addition to insulin and glucagon, there are several other hormones that can influence blood glucose levels. The most important ones are epinephrine, cortisol, and growth hormone, all of which can increase blood glucose levels.

Glucose levels above or below the normal range are indicative of the presence of disease states. For example, elevated glucose levels are present in diabetes mellitus, Cushing's syndrome, liver disease, and hyperthyroidism, while decreased glucose levels are present in Addison's disease, hyperinsulinism, and hypothyroidism.

The most prevalent of these diseases is diabetes mellitus. There are two types of this disease: Type I (insulin-dependent or juvenile-onset) diabetes mellitus, and Type II (noninsulin-dependent or maturity-onset) diabetes mellitus. In Type I diabetes, pancreatic beta cells are destroyed by an erroneous attack by the body's own immune system, and thus insulin secretion is reduced to negligible levels. In Type II diabetes, insulin secretion is not reduced; however, there is a reduced sensitivity of target cells to insulin, a phenomenon known as insulin resistance.

8. Adrenaline, a natural stimulant created in the kidney's adrenal gland, travels through the bloodstream and controls the functions of the autonomous nervous system, including the secretion of saliva and sweat, heart rate and pupil dilation. The substance also plays a key role in the human flight-or-flight response.

Glucagon and epinephrine are the most important hormones which trigger the breakdown of glycogen. Epinephrine is released in response to rigorous muscular activity from the adrenal medulla and stimulates the breakdown of glycogen in muscle to a larger extent than in the liver. The liver cells are more responsive towards glucagon. Both epinephrine and glucagon can bind to common receptors and through a series of other enzymes; activate the enzyme glycogen phosphorylase necessary to initiate glycogenolysis.

The whole process of signal transduction epinephrine and glucagon can be divided into three main steps

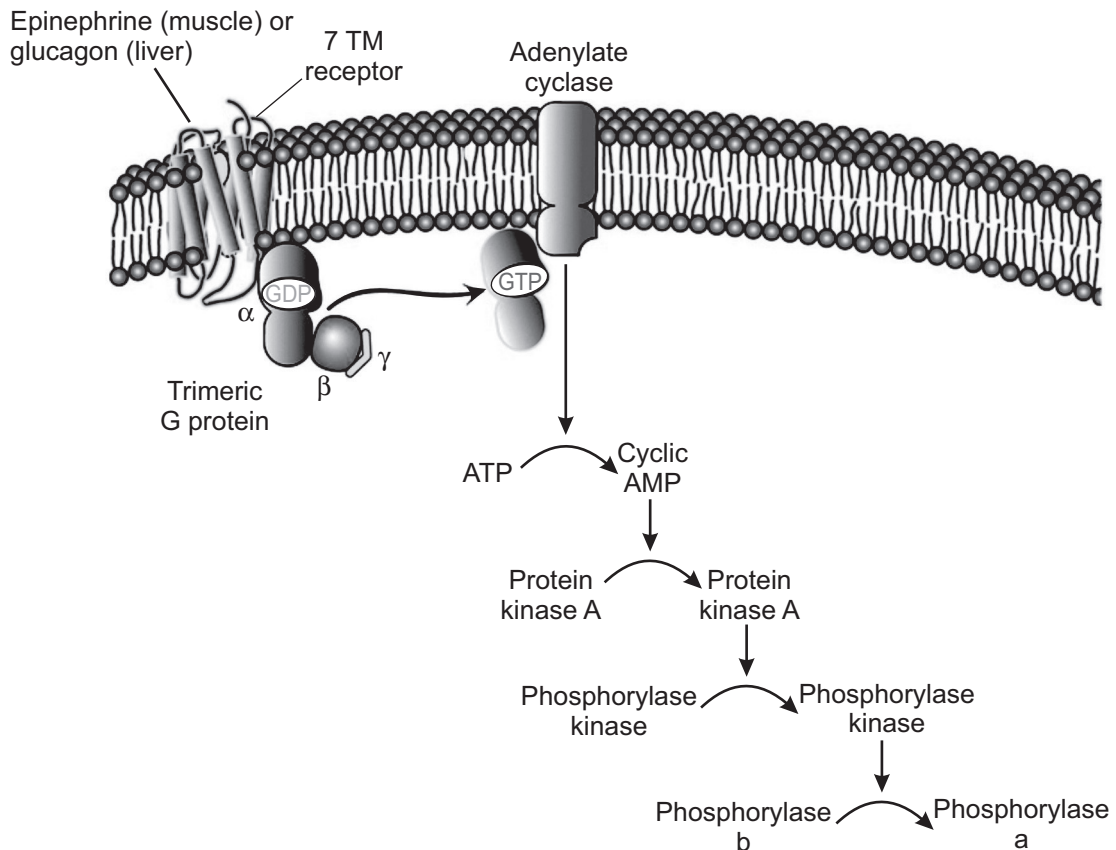

1. Hormone-receptor interaction at the cell surface: The hormone epinephrine and glucagon act as a ligand and bind to specific receptors known as 7TM, found in the plasma membranes of muscle and liver cells. The binding activate the alpha-subunit of the Gs protein.
2. Formation of cyclic AMP that bind to kinase protein: The activated alpha-subunits of Gs protein activate the adenylate cyclase, a transmembrane protein. Adenylate cyclase catalyzes the formation cyclic AMP (cAMP) which acts as the second messenger in the signal transduction pathways.
3. Activation of an enzyme cascade by phosphorylation and amplification of the signal: As level of cyclic AMP increase in the cytoplasm, it binds to the regulatory subunits of protein kinase A and activates protein kinase A. The activated protein kinase A phosphorylates and activates another enzyme phosphorylase kinase which finally activates glycogen phosphorylase and initiates the glycogenolysis.

Once activated, cyclic AMP cascade can highly amplify the effects of hormones through the number of enzymes. Therefore, binding of a small number of hormone to cell-surface receptors can lead to the release of a very large number of sugar molecules.

12.13 ASSESSMENT METHODS

Use observation technique, question answer technique, and demonstration technique to assess the learners' achievement of learning objectives.

12.14 ASSESSMENTS

Formative Assessment

Fill in the blanks:

1. Glucose + ATP gives
2. The process of biosynthesis of glycogen from glucose with the help of enzyme glycogen synthase is known

Ans. 1. Glucose-6-phosphate + ADP, 2. glycogenesis.

Summative Assessment

1. A protein with oligosaccharide chains (glycans) covalently attached to their polypeptide side chain.
2. cells contain various enzymes which help in the regulation of blood glucose.
3. It can be an important indicator of renal diseases.

Ans. 1. glycoprotein, 2. Hepatocytes, 3. Proteinuria

Unit 13: Regulation of Temperature

13.1 LEARNING OBJECTIVES

| Knowledge and Understanding | Skills | Attitudes and Values |
|---|--|--|
| <ul style="list-style-type: none"> • Explain the importance of temperature regulation. • Describe the morphological, physiological and behavioural adaptations to temperature changes in the environment. • Describe the responses to cold and hot conditions by endothermic and ectothermic animals. • Explain the role of the brain and thermo receptors in temperature regulation. • Describe the different processes in which plants minimise overheating. | <ul style="list-style-type: none"> • Interpret data related to the effects of temperature on animal behaviour. • Interpret and list the adaptive features shown by plants inhabiting extreme cold and hot environments. • Research using internet the role of brain in temperature regulation. • Design and investigate the effect of temperature. | <ul style="list-style-type: none"> • Acknowledge the importance of maintaining fairly constant temperatures for efficient metabolism. |

13.2 TEACHING AIDS

Visual: Images of adaptations of plants and animals to regulate temperature.

Audio-video: Video of animals competing with temperature changes.

13.3 TEACHER'S TIP

Start the unit by briefing the learners by stating the importance of temperature regulation for especially warm blooded organisms. Also, how and what changes organism goes through while competing with these temperature differences to survive. Teacher can ponder questions to motivate the learners to know about organisms. Introduce interesting facts, activities to dwell interest of the learners in lesson.

13.4 TEACHING METHODS

Brainstorming, short lecture technique, group discussion technique, observation technique, drawing technique, demonstration technique, field visit, site visit and practical work.

13.5 TEACHING AND LEARNING MATERIALS

Charts and graphs for temperature regulation in different animals, and computer aided materials.

13.6 TEACHING METHODOLOGY

Teacher initiates the topic by investigating the effect of temperature on enzyme activity. Teacher also discusses the homeostasis and temperature regulation through the medium of activity. Ask the learners to discuss the results of experiment.

Learners reply to the teacher

Appreciating them, further ask if they are aware of adaptations of temperature changes in environment.

Learners will come up with varied answers. Some correct, some near to correct, others being irrelevant.

Teacher will not demotivate the child. But agreeing to the correct answers, move further in discussion

Teacher will ask for examples

Using short lecture technique, teacher will explain about temperature regulation illustrating examples.

The teacher also explains the role of brain in temperature regulation.

13.7 ADDITIONAL CONTENT FOR THE TEACHER

Endothermic: Animal maintains a constant body temperature despite changes in the environment.

Ectothermic: Animal maintains body temperature by getting heat from its environment.

Estivation: Animals become inactive in summer; high temperatures, low water.

Hibernation: Animals become inactive in winter; cold temperatures, low food.

Seed dispersal: Seed design allows it to travel to new locations.

Activity

The teacher can demonstrate this activity in the class.

Aim: To make learners aware of adaptations.

Refer to text and ask the learners to collect pictures of different adaptations exhibited by plants and animals. Ask them to paste on chart papers and label it.

Ask each learner to read it aloud and tell 2 lines about each picture.

13.8 SUMMARY

- Endotherms or warm-blooded animals are those animals that actively maintain a stable body temperature by generating heat.
- Ectotherms or cold-blooded animals are those animals whose body temperature depends on their surrounding environment.
- Ectotherms can conserve more energy while endotherms use their energy to maintain body temperature, hence remain active even in wide temperature changes.
- All the enzymes have an optimum range of temperature beyond which they cease to function.
- Temperature is one of the most important factors which directly or indirectly influences the distribution of organisms to a large extent.
- Temperature above or below the limits of tolerance can have various effects on the animal's body including cells, metabolism, reproduction etc.
- Bergmann's rule states that animals living in the colder climates tend to be larger than those living in warmer climates.
- According to Allen's rule, animals living in the colder climates have more rounded and compact form which is achieved by reducing the size of the body extremities i.e., ears, limbs, tails etc.
- The countercurrent heat exchanger is generally located in body extremities like limbs, neck, gills, which are directly in contact to the external environment and helps to conserve or lose body heat.
- Desert dwelling mammals and birds have specialized kidneys with long loops of Henle compared to animals that live in aquatic environments and less arid regions.

- Hibernation is the state of dormancy during the cold conditions, i.e., winter.
- Aestivation or summer dormancy is a state of animal dormancy, characterized by inactivity and a lowered metabolic rate, in response to high temperatures and arid conditions.
- Torpor is the state of decreased physiological activity in an animal, usually by a reduced body temperature and metabolic rate.
- Thermogenesis or mechanisms of heat production, such as shivering and chemical thermogenesis, are strongly inhibited when exposed to hot temperature.
- Ectotherms depend more on their behaviour to regulate their body temperature.
- Ectoderms can adjust metabolism and other essential rate functions so that reaction rates remain relatively constant even when body temperatures vary. This process is known as acclimatization or temperature compensation.
- A thermoreceptor is a sensory receptor which is basically the receptive portion of a sensory neuron that converts the absolute and relative changes in temperature to nerves impulses.
- The hypothalamus is a small, but extremely important part of the brain that acts as the link between the endocrine and nervous systems of the body.
- The primary motor centre for shivering is excited by the cold signals from skin and spinal cord and depress by heat.
- All animals have a preferred range of temperature conditions at which it functions most optimally.
- Changes in temperature conditions affect the normal behavioural adaptations of the animals.
- Plants also depend on enzymes catalyzed chemical reactions for their growth and development.
- The process of evaporation of water from the leaves and stem of plants to the surrounding environment is known as transpiration.
- The stomata are specialized cells in the leaves which can open or close, limiting the amount of water vapour that can evaporate.
- Temperature affects the photosynthesis, respiration, germination as well as pollination of plants.
- Plants adapted to hot and dry climate have reduced leaves and longer roots.
- The large waxy coated leaves of plants in tropical rainforest are waterproof and help in losing water more easily.
- Small, low growing mosses, grasses, and sedges are the characteristics of extremely cold region like tundra.

13.9 WEBLINKS FOR CONTENT ENRICHMENT

- <http://hyperphysics.phy-astr.gsu.edu/hbase/thermo/heatreg.html>
- http://tle.westone.wa.gov.au/content/file/ea6e15c5-fe5e-78a3-fd79-83474fe5d808/1/hum_bio_science_3a.zip/content/003_homeostasis/page_06.htm
- <http://study.com/academy/lesson/homeostasis-and-temperature-regulation-in-humans.html>

13.10 LEARNERS' ACTIVITIES

Activity 1

The teacher should guide the learners to perform the following activity.

Hint:

1. Pour some water into the water baths and set the temperature at 37°C and 60°C.
2. Make a starch solution by adding 1g of cornstarch to 10 ml of distilled water. Pour the mixture into 50 ml of boiling water and stir until the solution becomes transparent.
3. Prepare amylase solution by adding 2 ml of saliva to 12 ml of water.
4. Take three test tubes and label as Ice, 37°C and 60°C.
5. Add 4 ml of the starch solution and 4 ml of amylase solution in the three test tubes.
6. Immediately place one test tube in the ice, one in the water bath at 37°C and other at 60°C.
7. Incubate the test tubes for 15 minutes.
8. Take 4 drops of samples from each test tube on a glass plate.
9. Add 1 drop of iodine to each sample.
10. Note the time taken for the iodine to turn yellow from blue.

Discussion:

Amylase is an enzyme that hydrolyzes starch into its components i.e., glucose. Iodine turns blue when it comes into contact with starch, but it stays yellow in the presence of glucose. Therefore, faster the iodine turns yellow from its blue colour, the faster amylase works on the starch.

Note: the time taken for different samples and discuss the result with your teacher.

Precautions:

1. The temperature of the water baths should be properly set.
2. Starch solution should be homogenous.
3. Time should be noted carefully.

Activity 2

The teacher should guide the learners to perform the following activity.

Hint:

1. Using internet, find the photographs of animals living in different temperature conditions like arctic, snow covered mountains, forest, deserts, sea etc.
2. Print the pictures and paste it in your scrapbook.
3. Write down different morphological, physiological and behavioural adaptations of the animal which helps it to live in the particular environment.

Discussion:

Submit your scrapbook to your teachers and discuss various adaptations of your collections.

Note: Encourage them to collect pictures from different temperature zones.

Activity 3

The teacher should assist the learners to do activity.

Hint:

1. Divide the class into groups of 3–4 learners.
2. Select an animal to study the temperature regulation mechanism.
3. Study different morphological, physiological and behavioural adaptation of the animals in different temperature.
4. Make a PowerPoint presentation and present it in the class.

Significance

Ask your teacher to give different endothermic and ectothermic animals to different groups of the class. Share your findings with other groups.

Activity 4

The teacher should guide the learners to perform the activity.

Hint:

1. Divide the class into groups of 3-4 learners.
2. Study the role of hypothalamus and different thermoreceptors in thermoregulation.
3. Make a PowerPoint presentation and present it in the class.

Significance

Discuss your presentation with your teacher and seek suggestions for any improvement.

Description/Inference

Explain the mechanism of temperature regulation from the textbook to the students.

Activity 5

The teacher should guide the learners to perform the activity.

Hint:

1. Cut the transparent plastic pipe longitudinally into two equal halves.
2. Place one end of the metal rod on a hot plate and the other end in ice to form a continuous thermal gradient.
3. Over top the metal rod, place the long half cylinder clear plastic pipe and seal the ends with cotton.
4. Release some 5-10 crickets/cockroaches into the tunnel.
5. Observe the behaviour of the animals inside the tunnels.
6. Remove the hot plates and ice from the ends of the metal rods.
7. Observe the change in the behaviour of the animals.

Discussion:

1. Observe whether the animals all seek out a preferred temperature or do they remain dispersed.
2. Note down the temperature of the point of the tunnels where the animals aggregate.
3. Discuss your result with your concerned teacher.

Activity 6

The teacher should guide the learners to perform the activity.

Hint:

1. Divide the class into groups of 2 learners each.
2. Each group selects a plant grown in extreme cold and hot environments.
3. One learner studies the plant adapted to hot while the other learner study the plant grown in cold climate.
4. Point out various adaptive features of the plants.
5. Make a PowerPoint presentation and present it in the class.

Significance

Ask your teacher to give different plants to different groups of the class. Share your findings with other groups.

13.11 ANSWERS TO SELF-EVALUATION**Self-evaluation**

- (i) Diapause
- (ii) Darker
- (iii) Bergmann's rule
- (iv) Fur coat and blubber
- (v) Increase

Self-evaluation

- (i) Insulation
- (ii) Ectotherm
- (iii) Nociceptors
- (iv) Hypothalamus
- (v) Large leaves, drip tips, waxy surface
- (vi) save water loss

13.12 ANSWERS TO END UNIT ASSESSMENT 13**I. Choose whether the following statements are True (T) or False(F):**

- | | |
|----------|-----------|
| 1. True | 2. True |
| 3. True | 4. True |
| 5. True | 6. False |
| 7. False | 8. True |
| 9. True | 10. False |

II. Multiple choice questions:

1. (c)
2. (a)
3. (c)
4. (a)
5. (c); Torpor is the reduced state of metabolism which lasts for a few hours while prolonged state of torpor becomes aestivations.
6. (a); Reptiles depend on external temperature for their body heat therefore, lizards are often seen basking in sun during winter.
7. (b); According to Allen's rule, animals living in the colder climates have more rounded and compact form which is achieved by reducing the size of the body extremities i.e. ears, limbs, tails etc.
8. (c); Heat production by metabolic processes in response to environmental temperature with the purpose of protecting the organism from cold exposure and buffering body temperature from environmental temperature fluctuations is known as adaptive thermogenesis.
9. (c); The waxy coating discourages the growth of bacteria and fungi on the leaves.
10. (d); The opening of the stomata and hence the transpiration rate of plants depends on environmental conditions such as light, temperature, the level of atmospheric CO₂ and relative humidity.
11. (a); The increased thyroxine level in the blood increases the rate of cellular metabolism throughout the body and hence, increases heat production.

III. Long answer type questions:

1. Besides water, our body consists of many inorganic and organic compounds, including proteins, lipids, carbohydrates etc. Among these, proteins are the most important compounds and are regarded as "workhorse" molecules of life, taking part in essentially every structure and activity of life. Proteins make up about 75 per cent of the dry weight of our bodies and serve four important functions;
 - (a) They are nutritious.
 - (b) They also form the structural components of our body, including skin, hair etc. They are building materials for living cells, appearing in the structures inside the cell and within the cell membrane.
 - (c) As haemoglobin, Hb they carry oxygen to all the body organs and

- (d) They function as biological catalysts as enzymes facilitating and controlling various chemical reactions of our body.

Protein molecules are often very large and are made up of hundreds to thousands of amino acid units. They are of varying shapes and sizes. For examples, keratins, a protein in hair and collagen in tendons and ligaments linear chains of amino acids. Other proteins called globular proteins, fold up into specific shapes and often more than one globular unit are bound together. Enzymes are globular proteins. Despite being large, enzymes typically have a small working region, known as active site which acts as the binding site of ligands. The shape of globular proteins is held together by many forces, including highly resistant strong covalent bonds. However, there are also many weak forces, like hydrogen bonds, which are susceptible to pH, osmolarity and temperature changes.

Since the function of enzymes is attributable to its shape, small changes in the shape can greatly reduce its function. Every enzyme has an optimal temperature at which it works best and this temperature is approximately the normal body temperature of the body. Therefore, in order to ensure the optimal function of the enzymes within, the core body temperature needs to be maintained more or less constant. If the body temperature falls below the normal value, the enzymes catalyzed reactions of the animal will be slowed. Similarly, too much rise in body temperature might result in enzyme denaturation and hence, reduce catalytic activities.

Rise in body temperature also reduces the oxygen carrying capacity of haemoglobin. Increasing temperature weakens and denatures the bond between oxygen and haemoglobin which in turn decreases the concentration of the oxyhemoglobin. This can lead to hypoxia – a condition in which tissues receive insufficient oxygen supply from the blood.

2. Morphological Adaptations

- (a) **Body size and shape:** Ectotherms or cold-blooded animals whose body temperature depends on the temperature of external environments are usually smaller in size compared to endotherms or warm blooded animals. For instance, compare the size of elephant, blue whales and crocodiles or snakes. Within the same species, the individuals living in the colder climates tend to be larger than those living in warmer climates. This is known as Bergmann's rule. For example, whitetail deer in the southern part of the United States have a smaller body size than those of the northern states or the far northern states.
- (b) **Body Extremities:** According to Allen's rule, the animals living in the colder climates have more rounded and compact form. This is achieved

by reducing the size of the body extremities i.e., ears, limbs, tails etc. On the other hand, the animals living in the warmer climates have longer body extremities. For instance, compare the size of the ear of Arctic fox with that of the Desert fox. Longer body extremities increase the surface to volume ratio of the desert fox which enables them to lose heat more easily. Most cold-blooded organisms have either an elongated or a flat body shape. For example, fishes, snakes, lizards, and worms have long and slender body form which ensures rapid heat up and cool down processes. Both Bergmann's rule and Allen's rule depend on simple principle that "*the ratio of surface area to volume of an object is inversely proportional to the volume of the object*". In other words, the smaller an animal, the higher the surface area-to-volume ratio. Higher surface area-to-volume ratio ensures these animals to lose heat relatively quickly and cool down faster, so they are more likely to be found in warmer climates. Larger animals, on the other hand, have lower surface area-to-volume ratios and lose heat more slowly, so they are more likely to be found in colder climates.

- (c) **Insulation:** All the marine mammals have a thick insulating layer of fat known as Blubber, just beneath the skin. It covers the entire body of animals such as seals, whales, and walruses (except for their fins, flippers, and flukes) and serves to store energy, insulate heat, and increase buoyancy. Thickness of blubber can range from a couple of inches in dolphins and smaller whales, to 4.3 inches in polar bears to more than 12 inches in some bigger whales. To insulate the body, blood vessels in blubber constrict in cold water. Constriction of the blood vessels reduces the flow of blood to the skin and minimizes the heat loss. In such animals, skin surface temperature is nearly identical to the surrounding water, though at a depth of around 50 mm beneath the skin, the temperature is the same as their core temperature. Some marine mammals, such as polar bears and sea otters, have a thick fur coat, as well as blubber, to insulate them. The blubber insulates in water while fur insulates in the air or terrestrial environment. The feathers of the birds also function in insulating the body from cold temperature.

Physiological Adaptations

- (a) **Evaporation:** In a colder region, i.e., when the surrounding environment of the animal is cooler than the body temperature, conduction and radiation are the main ways an animal dissipates heat. However, in warmer region, the air temperature is often higher than the animal's body temperatures, so the only physiological thermoregulatory mechanism available is evaporation. Animals use three evaporative cooling techniques that include sweating, panting, and saliva spreading.

- (i) **Sweating:** It is the loss of water through sweat glands found in the skin of mammals. The number of sweat glands can vary from none in whales, few in dogs to numerous in humans. Most small mammals do not sweat because they would lose too much body mass if they did. For example, in a hot desert the amount of water a mouse would lose through sweating to maintain a constant body temperature would be more than 20% of its body weight per hour, which could be lethal for the animal. Therefore, smaller mammals use other techniques to cool down their body. On the other hand, sweating is an important thermoregulatory mechanism for primates, including humans. An adult human can lose as much as 10–12 litres of water per day through sweating.
 - (ii) **Panting:** It is rapid, shallow respiration that cools an animal by increased evaporation from the respiratory surfaces. It is a common thermoregulatory technique used by small animals like dogs and rodents to lose heat.
 - (iii) **Saliva spreading:** It is a means of thermoregulation used by marsupials. Under extreme heat, saliva will drip from animal's mouth and is then wiped on its fore and hind legs. This technique induces the cooling effect of evaporation by wetting the fur. However, since the animal cannot spread saliva while moving, they need to adapt other evaporative techniques during such situations.
- (b) **Counter current mechanism:** As mentioned above, in addition to its role in the transport of oxygen and food, circulatory system of our body is responsible for distribution of heat throughout the body. This is true in case of both endotherms and ectotherms. In endotherms, most of the body heat is generated in the brain, liver, heart and skeletal muscles. This heat is transported to other parts of the body through blood. On the other hand, in ectotherms, the circulatory system help in transporting heat from skin to other body parts. The countercurrent heat exchanger is generally located in body extremities like limbs, neck, gills, which are directly in contact to the external environment. In colder region, when the warm blood flows through the arteries, the blood gives up some of its heat to the colder blood returning from the extremities in the veins running parallel to the arteries. Such veins are located in the deeper side of the body and carry the warm blood to the heart and most of the body heat is retained. Such mechanism can operate with remarkable efficiency. For instance, a seagull can maintain a normal temperature in its torso while standing with its unprotected feet in freezing water. When the external temperature is higher than the body

temperature and heat loss is not a problem, most of the venous blood from the extremities returns through veins located near the surface. If the core body temperature becomes too high, the blood supply to the surface and extremities of the body is increased enabling heat to be released to the surroundings.

- (c) **Hyperthermia:** Hyperthermia is a condition of having the body temperature greatly above the normal. Although all the endotherms can maintain a constant body temperature, some are able to raise their body temperature as a way to decrease the amount of water and energy used for thermoregulation. For example, camels and gazelles can increase their body temperature by 5–7°C during the day when the animal is dehydrated. Hyperthermia helps in saving water by letting their body temperature increase instead of using evaporative cooling to keep it at a constant temperature.
- (d) **Water retention:** Human body obtains about 60 per cent of the water it needs from ingested liquid, 30 per cent from ingested food, and 10 per cent from metabolism, while rodent adapted to arid conditions obtains approximately 90 per cent from metabolism and 10 per cent from ingested food. The predaceous marsupial *Mulgara* can go its whole life without ingesting water but by obtaining water from the food they eat and from metabolism. The fawn hopping mouse eats seed, small insects, and green leaves for moisture, and *Kowaris* eat insects and small mammals to obtain water. These animals have specialized kidneys with extra microscopic tubules to extract most of the water from their urine and return it to the blood stream. And much of the moisture that would be exhaled in breathing is recaptured in the nasal cavities by specialized organs. Many desert dwelling insects tap plant fluids such as nectar or sap from stems, while others extract water from the plant parts they eat, such as leaves and fruit. The abundance of insects permits insectivorous birds, bats and lizards to thrive in the desert. Elf owls survive on katydids and scorpions. Pronghorns can survive on the water in cholla fruits. Kit foxes can satisfy their water needs with the water in their diet of kangaroo rats, mice, and rabbits, along with small amounts of vegetable material.
- (e) **Excretion:** As mentioned above, desert dwelling mammals and birds have specialized kidneys with long loops of Henle compared to animals that live in aquatic environments and less arid regions. A longer tubules help in reabsorbing most of the water from their urine and return it to blood stream. As a result, the urine becomes highly concentrated. In these animals, most of

the water in the faeces gets reabsorbed in the alimentary canals and colon. Camels produce dryer faeces than other ruminants. For example, sheep produce faeces with 45 per cent water after 5 days of water deprivation, while camels produce faeces with 38 per cent water even after 10 days of water deprivation. The ability to excrete concentrated urine and dry faeces is an important adaptation to arid conditions. Desert rodents can have urine five times as concentrated as that of humans.

Behavioural Adaptations

Behavioural adaptations are used to reduce the amount of heat gain or loss by animals, and, thereby reducing the amount of energy and water to maintain the body temperature. Ectoderms or cold blooded animals rely on its behaviour to maintain a favourable body temperature.

Regulation of Temperature

- (a) **Nocturnality:** It is the simplest form of behavioural adaptation characterized by activity during the night and sleeping during the day. As such, nocturnal animals avoid direct exposure to heat of the day, thereby preventing loss of water needed for evaporative cooling. The night temperatures are generally 15–20°C colder than the daytime, so they require much less energy and water to regulate their body temperature. Most of the desert animals like quoll, bilby, and the spinifex hopping mouse, are nocturnal. Other large animals like lions prefer to hunt at night are to conserve water. Crepuscular animals are those animals that are mainly active during twilight (i.e., the period before dawn and that after dusk). Examples include hamsters, rabbits, jaguars, ocelots, red pandas, bears, deer, moose, spotted hyenas etc. Many moths, beetles, flies, and other insects are also crepuscular in habit. These crepuscular animals take advantage of the slightly cooler mornings and evenings to escape the daytime heat, and to evaporate less water.
- (b) **Microhabitat:** Among the diurnal animals (animals which are mainly active during the day and rest during night), the use of microhabitat like burrows, shade is another type of behavioural adaptation to avoid the daytime heat. Fossorial animals (digging animals), such as mulgaras, spent much of their time below ground eating stored food. Lizards and snakes seek a sunny spot in the morning to warm up their body temperatures more quickly and remain in shade when the temperature rises.
- (c) **Migration:** It is the physical movement of animals over a long distance from one area to another. It is found in all major animal groups, including birds, mammals, fish, reptiles, amphibians, insects,

and crustaceans. Many factors like climate, food, the season of the year or mating could lead to migration. It helps the animals in avoiding the extreme environmental conditions by moving to more favourable places. For example, many migratory birds like arctic tern (*Sterna paradisaea*) migrate to north-south, with species feeding and breeding in high northern latitudes in the summer, and moving some hundreds of miles south during the winter to escape the extreme cold of north. Monarch butterflies spend the summer in Canada and the Northern America and migrate as far south as Mexico for the winter.

- (d) **Hibernation and Aestivation:** Warm blooded animals which do not migrate generally survive the extreme cold condition of winter by sleeping. Hibernation is the state of dormancy during the cold conditions, i.e. winter. During hibernation, body temperature drops, breathing and heart rate slows, and most of the body's metabolic functions are put on hold in a state of quasi-suspended animation. This allows them to conserve energy, and survive the winter with little or no food. Many insects spend the winter in different stages of their lives in a dormant state. Such phenomenon is known as diapause. During diapauses, insect's heartbeat, breathing and temperature drop. Some insects spend the winter as worm-like larvae, while others spend as pupae. Some adult insects die after laying their eggs in the fall and eggs hatch into new insects in the spring when the food supply and temperature become favourable. Aestivation or summer dormancy on the other hand, is a state of animal dormancy, characterized by inactivity and a lowered metabolic rate, in response to high temperatures and arid conditions. It allows an animal to survive the scarcity of water or food as aestivating animal can live longer off its energy reserves due to the lowered metabolism, and reduced water loss though lowered breathing rates. Lung fishes, toad, salamander, desert tortoise, swamp turtles are some of the other non-mammalian animals which undergo aestivation.
- (e) **Social behaviour:** Among all the adaptations, living together is one of the most important adaptations of the animal kingdom. Animals can derive a lot of benefit from spending time with other members of the same species like finding food, defense against predators and care for their young. For example, emperor penguins can survive the harsh Antarctica winter huddling together in groups that may comprise several thousand penguins. Huddling greatly reduces the surface area of the group compared to individuals and a great deal of warmth

and body fat is conserved. Many social mammals, including many rodents, pigs and primates survive extreme cold by huddling together in groups.

- (f) **Locomotion:** Different types of locomotion require varying amount of energy. Many mammals like kangaroo, hares hop, which is an energy efficient type of locomotion. When animals go from walking to running, there is an increasing energy cost; however, once kangaroos start moving, there is no additional energy cost. This is because when a kangaroo lands, energy is stored in the tendons of its hind legs which is used to power the next hop.

3. Endotherms' Response to Temperature Changes

Endothermic organism can maintain relatively high body temperatures within a narrow range. Since most of the body heat is produced as a result of various metabolic activities, thermoregulation in endotherms depends on food and water availability. For example, bear undergoes hibernation during the winter because there is no sufficient food during the cold season. On the other hand, in arid environment like deserts, many desert animals are nocturnal to avoid the extreme daytime heat to avoid the loss of water through evaporation.

Response to Hot Temperature

When the body temperature increases in response to the external temperature, the body's temperature control system uses three important mechanisms to reduce the body heat. These are:

- (a) **Vasodilation:** The blood vessels in skin become intensely dilated due to the inhibition of the sympathetic centres in the posterior hypothalamus that cause vasoconstriction. Vasodilation increases the rate of blood flow to the skin and as a result, the amount of heat transfer from the core of the body increases tremendously.
- (b) **Sweating:** As discussed in the previous section, sweating is an important adaptation to loss of body heat through evaporative cooling. An increase in 1°C in body temperature causes enough sweating to remove ten times the basal rate of body heat production.
- (c) **Decrease in heat production:** As mentioned above, metabolic activities of the body are the main source of body heat. The mechanisms that cause excess heat production, such as shivering and chemical thermogenesis, are strongly inhibited when exposed to hot temperature.

Response to Cold Temperature

In response to cold temperature, the temperatures control system performs exactly opposite mechanism to that performed in hot temperature. These are:

- (a) **Vasoconstriction:** The blood vessels in the skin constrict under the influence of posterior hypothalamic sympathetic centres which reduce the blood flow to the skin.
- (b) **Piloerection:** Piloerection means hairs “standing on end”. Sympathetic stimulation causes the arrector pili muscles attached to the hair follicles to contract, which brings the hairs to an upright stance. The upright projection of the hairs allows them to entrap a thick layer of air next to the skin which acts as insulator, so that transfer of heat to the surroundings is greatly depressed.
- (c) **Increase in heat production (thermogenesis):** Endothermic metabolic rates are several times higher than those of ectotherms. The metabolic heat production of endotherms is regulated in response to fluctuations in the environment temperature. This phenomenon is known as adaptive thermogenesis or facultative thermogenesis. It can be defined as “*Heat production by metabolic processes in response to environmental temperature with the purpose of protecting the organism from cold exposure and buffering body temperature from environmental temperature fluctuations*”. Under cold temperature stress, heat production by the metabolic activities increased tremendously by promoting shivering, sympathetic excitation of heat production, and thyroxine secretion. These mechanisms will be discussed later. Extreme shivering can increase the temperature four to five times the normal production.

Ectotherms' Response to Temperature Changes

Ectotherms cannot maintain stable body temperature and their body temperature relies on the external temperature. They depend more on energy assimilation rather than utilizing it for temperature regulation. Therefore, ectotherms regulate their body temperature behaviourally and by cardiovascular modulation of heating and cooling rates. At the same time, metabolism and other essential rate functions are regulated so that reaction rates remain relatively constant even when body temperatures vary. This process is known as acclimatization or temperature compensation. For example, many fish adjust metabolic capacities to compensate for seasonal variation in water temperature with the result that metabolic performance remains relatively stable throughout the year. Reptiles often regulate their body temperature to different levels in different seasons to minimize the behavioural cost of thermoregulation. At the same time, tissue metabolic capacities are adjusted to counteract thermodynamically-induced changes in rate functions.

Response to Hot Temperature

When the external temperature increases, ectotherms protect their bodies from overheating using various mechanisms. These are:

- (a) **Use of microhabitat:** Under extreme heat conditions, many ectotherms like lizards and snakes prefer to stay in shade, either beneath the rocks, crevices or underground burrows. Amphibians and fishes enter cold water when their body temperature increases.
- (b) **Acclimatization:** If a salamander living at 10°C is exposed to 20°C, its metabolic rate increases rapidly. But if the exposure to the higher temperature lasts for several days, the animal experiences a compensating decrease in the metabolic rate. This decrease in the metabolic rate is due to acclimatization. The higher metabolic rate is due to the increase in the enzymes activity with temperature. However, with prolonged exposure to the condition, the metabolic rates decrease to prevent excessive energy loss. Ectotherms also exhibit acclimatization of temperature tolerance range with animal acclimated to high temperature are able to tolerate higher temperature than those exposed only to low temperature. Similarly, cold acclimated animals have better tolerance to low temperature than high temperature acclimated animals.

Response to Cold Temperature

Ectotherms response to cold temperature is exactly opposite to the response shown when exposed to hot temperature. That is:

- (a) **Basking to sun:** When the body temperature of the ectotherms becomes colder than the normal, the animals either bask to sunlight to warm up their body or move to a warmer place. Under extreme cold conditions, all the metabolic activities may cease and the animals enter the state of torpor (reduced metabolic activities).
- (b) **Cold acclimatization:** Decrease in the temperature results in reduced metabolic rate. Therefore, as a compensatory measures to meet the required body metabolism, the cold acclimatization of ectotherms is characterized by increase in concentration of various metabolic enzymes. There is also significant increase in the mitochondria and capillaries concentration in the skeletal muscle. This increases the ATP production through aerobic respiration in these tissues. Therefore, in those animals which have prolonged exposure to cold temperature, there may be increase in the locomotion, though the basal rates of metabolism remain below the warm acclimated animals.

4. Thermoreceptors

A thermoreceptor is a sensory receptor which is basically the receptive portion of a sensory neuron that converts the absolute and relative changes in temperature, primarily within the innocuous range to nerves impulses. Thermoreception is the sense by which an organism perceives the temperature of the external and internal environment from the information supply by thermoreceptors. In vertebrates, most of the thermoreceptors are found in skins which are actually free nerve endings. Deep body thermoreceptors are also found mainly in the spinal cord, in the abdominal viscera, and in or around the great veins in the upper abdomen and thorax region. Mammals have at least two types of thermoreceptors – the warm receptors, those that detect heat or temperatures above normal body temperature and cold receptors, those that detect cold or temperatures below body temperature. The warm receptors are generally unmyelinated nerves fibres, while cold receptors have thinly myelinated axons and hence, faster conduction velocity. Increasing body temperature results in an increase in the action potential discharge rate of warm receptors while cooling results in decrease. On the other hand, cold receptors' firing rate increases during cooling and decreases during warming. Another type of receptor called nociceptor, detects pain due to extreme cold or heat which is beyond certain threshold limits. A specialized form of thermoception known as distance thermoreception is found in some snakes like pit viper and boa, use a specialized type of thermoreceptor which can sense the infrared radiation emitted by hot objects. The snake's face has a pair of holes, or pits, lined with temperature sensors. These sensors indirectly detect infrared radiation by its heating effect on the skin inside the pit which helps them to locate their warm blooded prey. The common vampire bat may also have specialized infrared sensors on its nose.

Hypothalamus

The hypothalamus is a very small, but extremely important part of the brain that acts as the link between the endocrine and nervous systems of the body. The hypothalamus plays a significant role in the endocrine system and is responsible for maintaining the body's homeostasis by stimulating or inhibiting many key processes, including heart rate and blood pressure, body temperature, fluid and electrolyte balance, appetite and body weight, glandular secretions of the stomach and intestines, production of substances that influence the pituitary gland to release hormones and sleep cycles.

Thermoregulation—Role of Hypothalamus

Thermoregulation is carried out almost entirely by nervous feedback mechanisms, and almost all these operate through temperature-regulating

centres located in the hypothalamus. The hypothalamus contains a large number of heat-sensitive as well as cold-sensitive neurons which act as thermoreceptor, sensing the temperature of the brain. The posterior hypothalamus region contains the thermoregulatory centre which integrate the signals from all the thermoreceptors found in skin, deep organs and skeletal muscles, as well as from the anterior hypothalamus and control the heat-producing and heat-conserving reactions of the body.

5. Like all the other living organisms, plants depend on enzymes catalyzed chemical reactions for their growth and development. For example, plants synthesize their own food from water and carbon dioxide using sunlight through photosynthesis. The process of photosynthesis involves a series of complex enzyme system and other proteins. Therefore, along with carbon dioxide, water, light, nutrients and humidity, temperature is also one of the limiting factors for growth and development of plants.

Unlike animals, plants remain fixed in a particular site and absorb heat from the sunlight. The excess heat from the body is released to the surrounding through radiation and evaporation. The process of evaporation of water from the leaves and stem of plants to the surrounding environment is known as transpiration. It occurs through the stomata, a small opening located on the underside of the leaves. The stomata are specialized cells in the leaves which can open or close, limiting the amount of water vapour that can evaporate. Higher temperature causes the opening of stomata whereas colder temperature causes the opening to close. The opening of the stomata and hence the transpiration rate of plants depend on environmental conditions such as light, temperature, the level of atmospheric CO₂ and relative humidity. Higher relative humidity leads to more opening, while higher CO₂ levels lead to closing of stomata. Under high environmental temperature, the plant body gets heat up. In order to cool down, the plant increases its transpiration rate. The evaporative loss of water from the plant's body lowers the temperature.

Besides transpiration, many plants have different adaptations that help them survive in extreme temperature conditions ranging from hot and arid deserts to cold and snow covered mountains. These adaptations make it difficult for the plant to survive in a different place other than the one they are adapted to. This explains why certain plants are found in one area, but not in another. For example, cactus plants, adapted to desert conditions can't survive in the Arctic.

Effect of Temperature Changes on Plants

The most obvious effect of temperature on plants is changes in the rate of photosynthesis and respiration. Both process increases with rise in the

temperature upto a certain limit. However, increase in temperature beyond the limits, the rate of respiration exceeds the rate of photosynthesis and the plants productivity decreases.

Another important effect of temperature is during the process of germination of seeds. Like most other processes it also depends on various factors including air, water, light, and, of course, temperature. In many plant species, germination is triggered by either a high or low temperature period that destroys germination inhibitors. This allows the plant to measure the end of winter season for spring germination or end of summer for fall germination. For example, winter adapted plant seeds remain dormant until they experience cooler temperature. Temperature of 4°C is cool enough to end dormancy for most cool dormant seeds, but some groups, especially within the family Ranunculaceae and others, need conditions cooler than -5°C. On the other hand, some plants like Fire poppy seeds will only germinate after hot temperatures during a forest fire which cracks their seed coats. The fire does not cause direct germination, rather weakens the seed coat to allow hydration of the embryo. Pollination is another phenological stage of plants sensitive to temperature extremes across all species. Since pollination is carried out by pollinators like honey bees, butterflies etc. any factor, including temperature that affect these pollinator, will certainly affect the process.

6. Homeostasis is the process through which an organism maintains certain internal conditions, such as a human body's internal mechanisms maintaining body temperature at a specific level to prevent over or under heating; this process is important because it makes it possible for cells and organs to function properly. For example, certain parts of the human body cease to function if they become too hot or too cold; this is why it is possible for people to freeze to death or die from overheating.

Temperature regulation is an important body function for warm-blooded animals, because it allows them to live in any climate and to survive in places where the climate fluctuates seasonally. Homeostasis is important not only in regulating temperature but in performing tasks, such as digestion and elimination of waste. When an animal's kidneys filter its liquid intake and triggers the elimination of waste in the form of urine, that animal's body is performing a natural, involuntary function that helps regulate the amount of potentially toxic or otherwise harmful materials in the body. Homeostasis is important all the way down to the cellular level; without proper homeostasis, cells cannot perform essential tasks such as osmosis, which is a process of water passing through a cell's membrane.

7. Heat Adapted Plants

In extremely hot and dry desert region with annual rainfall averaging less than 10 inches per year, and having a lot of direct sunlight shining on the plants,

the main strategy for the survival of the plants is to avoid extensive water loss through transpiration. Therefore, in such region many plants called succulents, like cactus can store water in their stems or leaves. Some plants are leafless or have small seasonal leaves that only grow after rains. These leafless plants conduct photosynthesis in their green stems. Leaves are often modified into spines to discourage animals from eating plants for water. Also, waxy coating on stems and leaves help reduce the water loss. Other plants have very long root systems that spread out wide or go deep into the ground to absorb water.

On the other hand, in hot and humid tropical rainforest, the abundance of water can cause problems such as promoting the growth of bacteria and fungi which could be harmful to plants. Heavy rainfall also increases the risk of flooding, soil erosion, and rapid leaching of nutrients from the soil. Plants grow rapidly and quickly use up any organic material left from decomposing plants and animals. The tropical rainforest is very thick, and not much sunlight is able to penetrate to the forest floor. However, the plants at the top of the rainforest in the canopy must be able to survive the intense sunlight.

Therefore, the plants in the tropical rainforest usually have large leaves with drip tips and waxy surfaces that allow water to run off easily. Some plants grow on other plants to reach the sunlight. Similarly, in aquatic plants adapted to live in water, the leaves are very large, fleshy and waxy coated. Increased surface area makes plants to lose excess water while the shiny wax coating discourages the growth of microbes. The roots and stems are reduced immensely since water, nutrients, and dissolved gases are absorbed from the water directly through the leaves.

Cold Adapted Plants

In extremely cold region like tundra which is characterized by a permanently frozen sub-layer of soil called permafrost, the drainage is poor and evaporation slow. With the region receiving very little precipitation, about 4 to 10 inches per year usually in the form of snow or ice, plant life is dominated by small, low growing mosses, grasses, and sedges. Plants are darker in colour, some even red which helps them absorb solar heat. Some plants are covered with hair which helps keep them warm while others grow in clumps to protect one another from the wind and cold. In a slightly warmer temperate forest, with temperature varying from hot in the summer to below freezing point in the winter, many trees are deciduous, that is they drop their leaves in the autumn to avoid cold winter, and grow the new ones in spring. These trees have thin, broad, light-weight leaves that can capture a lot of sunlight to make a lot of food during the warm weather, and when the weather gets cooler, the broad leaves cause too much

water loss and can be weighed down by too much snow, so the trees drop their leaves. They usually have thick bark to protect against cold winters.

8. Thermoregulation is a process that allows your body to maintain its core internal temperature. All thermoregulation mechanisms are designed to return your body to homeostasis. This is a state of equilibrium.

A healthy internal body temperature falls within a narrow window. The average person has a baseline temperature between 98°F (37°C) and 100°F (37.8°C).

Hyperthermia is elevated body temperature due to failed thermoregulation that occurs when a body produces or absorbs more heat than it dissipates. Extreme temperature elevation then becomes a medical emergency requiring immediate treatment to prevent disability or death.

Internal thermoregulation contributes to animal's ability to maintain homeostasis within a certain range of temperatures. As internal body temperature rises, physiological processes are affected, such as enzyme activity. Although enzyme activity initially increases with temperature, enzymes begin to denature and lose their function at higher temperatures (around 40-50°C for mammals). As internal body temperature decreases below normal levels, hypothermia occurs and other physiological processes are affected. There are various thermoregulation mechanisms that animals use to regulate their internal body temperature.

Thermoregulation in organisms runs along a spectrum from endothermy to ectothermy. Endotherms create most of their heat via metabolic processes, and are colloquially referred to as "warm-blooded." Ectotherms use external sources of temperature to regulate their body temperatures. Ectotherms are colloquially referred to as "cold-blooded" even though their body temperatures often stay within the same temperature ranges as warm-blooded animals.

Ectothermic cooling

- Vaporization:
 - ◆ Evaporation of sweat and other body fluids.
- Convection:
 - ◆ Increasing blood flow to body surfaces to maximize the heat loss.
- Conduction:
 - ◆ Losing heat by being in contact with a colder surface. For instance:
 - (i) Lying on cool ground.
 - (ii) Staying wet in a river, lake or sea.
 - (iii) Covering in cool mud.
- Radiation:
 - ◆ releasing heat by radiating it away from the body.

Ectothermic heating (or minimizing heat loss)

- Convection:
 - ◆ Climbing to higher ground up trees, ridges, rocks.
 - ◆ Entering a warm water or air current.
 - ◆ Building an insulated nest or burrow.
- Conduction:
 - ◆ Lying on a hot surface.
- Radiation:
 - ◆ Lying in the sun (heating this way is affected by the body's angle in relation to the sun).
 - ◆ Folding skin to reduce exposure.
 - ◆ Concealing wing surfaces.
 - ◆ Exposing wing surfaces.
- Insulation:
 - ◆ Changing shape to alter surface/volume ratio.
 - ◆ Inflating the body.

To cope with low temperatures, some fish have developed the ability to remain functional even when the water temperature is below freezing; some use natural anti-freeze or anti-freeze proteins to resist ice crystal formation in their tissues. Amphibians and reptiles cope with heat loss by evaporative cooling and behavioural adaptations. An example of behavioural adaptation is that of a lizard lying in the sun on a hot rock in order to heat through conduction.

Endothermy - Evaporation of water, either across respiratory surfaces or across the skin in those animals possessing sweat glands, helps in cooling body temperature to within the organism's tolerance range. Animals with a body covered by fur have limited ability to sweat, relying heavily on panting to increase evaporation of water across the moist surfaces of the lungs and the tongue and mouth. Mammals like cats, dogs and pigs, rely on panting or other means for thermal regulation and have sweat glands only in foot pads and snout. The sweat produced on pads of paws and on palms and soles mostly serves to increase friction and enhances grip. Birds also avoid overheating by gular fluttering, flapping the wings near the gular (throat) skin, similar to panting in mammals, since their thin skin has no sweat glands. Down feathers trap warm air acting as excellent insulators just as hair in mammals acts as a good insulator. Mammalian skin is much thicker than that of birds and often has a continuous layer of insulating fat beneath the dermis. In marine mammals, such as whales, or animals that live in very cold regions, such as the polar bears, this is called blubber. Dense coats found in desert endotherms also aid in preventing heat gain such as in the case of the camels.

13.13 ASSESSMENT METHODS

Use observation technique, question answer technique, and demonstration technique to assess the learners' achievement of learning objectives.

13.14 ASSESSMENTS

Formative Assessment

Fill in the blanks:

1. All marine animals have a thick layer of insulating fat known as
2. are those animals that are mainly active during twilight.
3. is a condition of low body temperature.

Ans. 1. Blubber, 2. Crepuscular animals, 3. Hypothermia

Summative Assessment

Answer in one word:

1. Heat production in response to environment temperature by metabolic processes.
2. State of decreased physical activity in an animal.
3. Temperature compensation is also called.

Ans. 1. Adaptive thermogenesis, 2. Torpor, 3. Acclimatization

Unit 14: Behaviour and Responses in Mammals

14.1 LEARNING OBJECTIVES

| Knowledge and Understanding | Skills | Attitudes and Values |
|---|---|---|
| <ul style="list-style-type: none"> • State the different types of behaviour. • Recall that the nervous system is responsible for co-ordinating behaviour. • Explain the different types of behaviour in terms of stimulus, receptor, nerves and effectors. • Explain how the types of behaviour result from sequential responses. • Give examples of imprinting and understand its significance. • Explain the value of habituation. • Define the terms: conditioning, habituation, survival, courtship behaviour and migration. • Discuss the advantages and disadvantages to organisms living in societies. • Describe how birds and mammals maintain their territory. • Explain the significance of behavioural rhythms. • Discuss the advantages of bird migration | <ul style="list-style-type: none"> • Apply knowledge of reflex actions to describe the components of a reflex arc and explain the different reflex behaviours. • Distinguish between simple reflex actions and a fixed action pattern. • Analyse the forms of conditioning. • Analyse the contribution of innate behaviour and learned behaviour to an animal's overall behaviour and survival. • Distinguish between classical and operant conditioning. • Analyse the significance of latent learning. • Relate learning and response to survival in the environment. • Distinguish between migration and dispersion. | <ul style="list-style-type: none"> • Appreciate the importance of animal welfare. • Value the causes and effects of bird and other animal migration. • Show concern for the behaviour of animals in societies. • Acknowledge the need for a territory by some animals for their continued survival. • Show concern for the importance of conditioned reflex in relation to survival. |

14.2 TEACHING AIDS

Visual: Images of behaviour of animals.

Audio-video: Video of animals exhibiting behaviour and responses.

14.3 TEACHER'S TIP

Start the unit by briefing the learners by stating the different types of behaviour exhibited by animals. Also, give examples of animals and their behaviour. Describe the different types of behaviour. The responses of animals differ too. There are many animals and many responses like courtship, territoriality, learning which help them sustain their life.

14.4 TEACHING METHODS

Brainstorming, short lecture technique, group discussion technique, observation technique, drawing technique, demonstration technique, field visit, site visit and practical work.

14.5 TEACHING AND LEARNING MATERIALS

Online sources, charts and diagrams for animal behaviour and migration.

14.6 TEACHING METHODOLOGY

Teacher initiates the topic by introducing the behaviour of animals and their responses through the medium of activity. Ask the learners to discuss the examples.

Learners reply to the teacher.

Appreciating them, further ask if they are aware of responses of animals which they see usually.

Learners will come up with varied answers. Some correct, some near to correct, others being irrelevant.

Teacher will not demotivate the child. But agreeing to the correct answers, move further in discussion.

Teacher will ask for examples.

Using short lecture technique, teacher will explain the different responses such as learning, habituation, courtship, animal migration and so forth.

The teacher also use examples to explain each.

14.7 ADDITIONAL CONTENT FOR THE TEACHER

Activity

The teacher can demonstrate this activity in the class.

Aim : To make the learners aware of responses.

Refer to the text and ask the learners to collect pictures of different responses exhibited by animals. Ask them to paste on chart papers and label it.

Ask each learner to read it aloud and tell 2 lines about each picture.

14.8 SUMMARY

- Genetically programmed behaviours like physical traits such as body colour and wing venation.
- The most basic unit of innate behaviour is a simple reflex arc.
- Animal recognizes a stimulus and continues until all parts of the behaviour have been performed.
- **Courtship behaviour:** Males and females of a species carry out this behaviour before mating.
- **Territoriality:** Exclusive use of fixed space, which entails obtaining, defending, or advertising occupancy of the space. Mark the territories using pheromones, visual and auditory signals.
- **Ritualized aggression:** To intimidate intruders and defend their territories, but without engaging in fights which are expensive in terms of energy and the risk of injury.
- **Dominance hierarchy:** Linear or nearly linear ranking exists, with each animal dominant over those below it and submissive to those above it in the hierarchy.
- Biological Rhythms are the repeating patterns of biochemical, physiological, and behavioural processes.
- Migration is movements of animals away from and back to their place of origin.
- Behavioural changes occur through practice or experience related to learning.
- Habituation is a form of learning in which an organism decreases or ceases to respond to a stimulus after repeated presentations.
- Imprinting is a permanent attachment.
- Conditioning is a particular stimulus or a particular response linked to a reward or punishment.
- Latent learning is a form of learning that is not immediately expressed in an overt response.
- Social Behaviour is the action directed by an individual towards a member of its species. It includes competitive behaviour such as fighting, threat and submission and co-operative interactions like parental care and mating.

- **Group selection:** People who support and help one another may have an advantage over the groups whose members are selfish.
- **Kin selection:** Favours the reproductive success of an organism's relatives, even at a cost to the organism's own survival and reproduction.

14.9 WEBLINKS FOR CONTENT ENRICHMENT

- <http://www.sciencedirect.com/science/journal/00033472>
- https://en.wikibooks.org/wiki/Animal_Behavior

14.10 LEARNERS' ACTIVITIES

Activity 1

Teachers guide the learners to perform activity.

Activity 2

The teacher should guide the learners to perform the activity.

Hint:

1. Take some moist soil with woodlice and place it on paper.
2. Place an earthworm near the light source.

Discussion:

1. Note the activity of woodlice and earthworm.
2. Discuss how animals orient in both activities.

Taxis: It is a movement directly toward (positive) or away from (negative) a stimulus. A klinotaxis involves side-to-side motions of the head or body with successive comparison of stimulus intensity as the animal moves forward. A tropotaxis requires bilateral input from paired sensory receptors so that the signal is equalized in both receptors. Stimulus intensity increases with movement toward the source and decreases with movement away from the source. For example: Movement of cockroaches away from a light source.

Kinesis: It is a change in the speed of movement (orthokinesis) or a change in the rate of turning (klinokinesis) which is directly proportional to the intensity of a stimulus. Input from only a single sensory receptor is necessary. A kinesis is non-directed orientation, that is, the animal exhibits a "random walk". Example: Locomotion of woodlice in relation to humidity. With increased humidity, there is an increase in the percentage time that the woodlice will remain stationary.

Activity 3

The teacher should assist the learners in understanding behaviour.

Hint:

1. Make a list of innate and learned behaviours.
Innate behaviour is also known as inherited behaviour.

Discussion

Note the points related to both behavioural types.

Innate behaviour, also known as inherited behaviour, is genetically programmed. Individuals inherit a suite of behaviours just as they inherit physical traits such as body colour and wing venation.

Example: Reflex arc and Fight and fear situation

Learning, or learned behaviour, takes place when behaviour changes through practice or experience. It allows an animal to adapt to change, an ability that is important for animals with long life spans.

Example: Horses or cows disregarding noisy cars and scarecrow habituation to crows.

Trainer is teaching the actions to dogs.

Relation between mother and newborn.

Activity 4

The teacher should guide the learners to perform the activity.

Hint:

1. Make a group of 4 or 5 learners.
2. Discuss the Pavlov's experiment.
3. Write down the interpretation of the experiment.

Classical conditioning is a learning process in which an innate response to a potent stimulus comes to be elicited in response to a previously neutral stimulus; this is achieved by repeated pairings of the neutral stimulus with the potent stimulus. Eventually, the animal learns to respond to the stimulus even in the absence of a reward or punishment. The scientist Ivan Pavlov conducted a famous experiment on classical conditioning in which he trained a dog to salivate at the sound of a bell.

Activity 5

The teacher should assist the learners to perform activity.

Hint:

1. Collect information on the latent learning behaviour.
2. Write down the points related to latent learning.

Discussion:

Discuss the significance of latent learning.

Latent learning is a form of learning that is not immediately expressed in an overt response; it occurs without any obvious reinforcement of the behaviour or associations that are learned. Latent learning implies that learning can take place without any behavioural changes being immediately present.

Example: A rat completes a maze several times, without an incentive. The rat learns the maze very slowly. When food is placed at the end of the maze, the rat completes the maze very quickly, demonstrating that latent learning had occurred and a cognitive map of the maze was informed.

Activity 6

The teacher should guide the learners to understand activity.

Hint:

1. Research on the animals that live in their territories.
2. Study how they maintain their territories.
3. Write down the points about them.

Territoriality refers to the exclusive use of fixed space, which entails obtaining, defending, or advertising occupancy of the space. Animals divide geographical area around them into four broad regions:

1. Total range (entire area covered)
2. Home range (large area for all activities – feeding, sex and roaming are done)
3. Territory (small area within home ranges, driving away intruders and visited in days)
4. Core area (within territory but much smaller)

Functions of Territoriality

1. Well shaped aggregation of local population.
2. Well defined area for parental care.
3. Limitation of breeding population and control beyond carrying capacity.

4. Adequate food.
5. Reserve of unmated males and females for prompt replacement.
6. Reduction in rate of contracting parasites or diseases.
7. Helps intending against predator and share resources.
8. Collectively defending nests and young from predators.
9. Porters separate after breeding for short periods.

Example: Wolves maintain their territories in which they hunt and live. These areas are aggressively defended against other group members. The male cougar has a large territory that may overlap with the territories of several females but is defended against other males. Responding to scent marks, the inhabitants of the overlapping ranges also avoid each other, except for breeding.

Activity 7

Teacher asks the learners to perform activity.

Activity 8

The teacher should guide the learners to perform activity.

Hint:

1. Research on the migratory birds.
2. Note the activities which the migratory birds do.
3. Write down the advantages of the migration.

Advantages of Migration

- Animals remain in favourable conditions e.g. avoid cold/ extremes.
- Parents and offspring grow larger and therefore have a high survival rate, they leave more offspring.
- The population has a constant supply of food.
- Migration may lead to the colonization of a new area.
- Reduces the cases of diseases as the disease doesn't always have a host in the area.
- Reduces the effects of predation habitats that have abundant food sources year-round also attract a greater number of predators that can threaten nests.
- Birds that migrate to different habitats can escape that onslaught of predators, giving their young a better chance of reaching maturity.
- Because many different populations often meet at the "breeding grounds", migration increases genetic diversity as they often breed with individuals from a different population.

Feedback Time:

1. Ask your concerned teacher to comment on your presentation.
2. Most probably, your teacher will ask you to improve in certain areas.
3. Note those points of improvements and incorporate them in the next presentation.

14.11 ANSWERS TO SELF-EVALUATION**Self-evaluation**

- (i) Fixed action pattern
- (ii) Kinesis
- (iii) Imprinting
- (iv) Operant
- (v) Insight learning
- (vi) Operant conditioned

Self-evaluation

- (i) Higher
- (ii) Noisy, prolonged, ferocious
- (iii) Scent marking
- (iv) Threatens
- (v) Despotic

Self-evaluation

- (i) diversity
- (ii) Biological clocks
- (iii) Hibernation, migration

14.12 ANSWERS TO END UNIT ASSESSMENT 14**I. Choose whether the following statements are True or False:**

1. **True;** Behaviour is an external response directed internally.
2. **False;** It is operant conditioning behaviour.

3. **True;** It is a learning process in which an innate response to a potent stimulus comes to be elicited in response to a previously neutral stimulus; this is achieved by repeated pairings of the neutral stimulus with the potent stimulus.
4. **True;** It is a learning process in which an innate response to a potent stimulus comes to be elicited in response to a previously neutral stimulus; this is achieved by repeated pairings of the neutral stimulus with the potent stimulus.
5. **False;** It is a change in the speed of movement (orthokinesis) or a change in the rate of turning (klinokinesis) which is directly proportional to the intensity of a stimulus.
6. **False;** Animals migrate to other places with more suitable conditions of temperature, food, more favourable living or breeding places and hibernation.
7. **False;** When you touch a hot object, you quickly pull your hand away using the withdrawal reflex action.
8. **True;** Animals use pheromones, visual and auditory signals.
9. **False;** It is a form of learning that is not immediately expressed in an overt response; it occurs without any obvious reinforcement of the behaviour or associations that are learned.

II. Multiple choice questions:

1. **(a);** Learning is a form that is not immediately expressed.
2. **(d);** A fight or flight response mobilizes the body for greater activity like it increases heart rate and blood pressure. Body is being prepared to fight or run from danger.
3. **(c);** Courtship behaviour is the behaviour that males and females carry out before mating.
4. **(d);** Territorial behaviour of animals provides shelter, food and breeding.
5. **(a);** Migration is periodic movement of animals from one place to another.
6. **(c);** It is a form of learning in which an animal, at a specific critical time of its life, forms a social attachment to another animal. It is shown by newborn baby for mother.
7. **(b);** Animals marks their territory with the help of pheromones, visual and auditory signals.
8. **(a);** Hamilton gave a rule for the altruistic behaviour where evolutionary strategy which favours the reproductive success of an organism's relatives, even at a cost to the organism's own survival and reproduction.

9. (a); Habituation is a simple form of learning in which an organism decreases or ceases its response to a stimulus after repeated presentations. It is progressive decrease of the amplitude or frequency of a motor response to repeated sensory stimulation that is not caused by sensory receptor adaptation or motor fatigue.

III. Long answer type questions:

1. Behavioural activities are divided into two groups: Innate and Learned

Innate Behaviour (Simple Response)

Innate behaviour, also known as inherited behaviour, is genetically programmed. Individuals inherit a suite of behaviours just as they inherit physical traits such as body colour and wing venation. In general, innate behaviours will always be:

- (a) Heritable—encoded in DNA and passed from generation to generation
- (b) Intrinsic—present in animals raised in isolation from others
- (c) Stereotypic—performed in the same way each time by each individual
- (d) Inflexible—not modified by development or experience
- (e) Consummate—fully developed or expressed at first performance

Learned Behaviour

Learning, or learned behaviour, takes place when behaviour changes through practice or experience. Learning allows an animal to adapt to change, an ability that is important for animals with long life spans. In general, learned behaviours will always be:

- (a) Not heritable — acquired only through observation or experience
- (b) Extrinsic — absent in animals raised in isolation from others
- (c) Permutable — pattern or sequence may change over time
- (d) Adaptable — capable of modification to suit changing conditions
- (e) Progressive — subject to improvement or refinement through practice

2. Behaviour can be defined more precisely as an internally directed system of adaptive activities that facilitate survival and reproduction. A stimulus is an environmental change that directly influences the activity of an organism. Behaviour is a result of sensory and motor integration in an organism i.e., nervous system includes sensory cells detects changes in environment. Nerve cells transmits and integrates information, chemical messengers transmits information into body and muscle cells translate information into action. Orientation behaviours are coordinated movements (walking, flying, swimming, etc.) that occur in response to an external stimulus. These behaviours have adaptive value for survival by helping the organism to locate (or avoid) the

source of a stimulus. The simplest behaviours involve input from only a single sensory receptor whereas more advanced behaviours require bilateral input from a pair of receptors.

3. Fixed Action Pattern (FAP) is a sequence of coordinated movements that are performed together as a “unit” without interruption. Each FAP is triggered by a unique stimulus variously known as a sign stimulus, a key stimulus, or a releaser. A praying mantis striking at prey is a typical example. The releaser for this FAP is any movement by a small (prey-sized) object within striking distance. Once initiated, the mantis cannot change direction in mid-strike or abort the mission if the prey escapes. Other common examples of FAPs include courtship displays, hunting or food gathering, nest-building activities, and attack or escape movements. Unlike simple reflexes, FAPs may involve a whole-body response and often require a threshold level of internal readiness (drive).
4. **Reflex arc:** When you touch a hot object, you quickly pull your hand away using the withdrawal reflex. Reflex action is different from fixed action pattern. Firstly, reflex action is a simple motor action, stereotype and repeatable but fixed action is complex motor act, involving a specific temporal sequence of component acts. Secondly, reflex is elicited by a sensory stimulus and the strength of the motor action being graded with intensity of the stimulus while fixed action patterns are generated internally or elicited by a sensory stimulus. This stimulus acts as a trigger, causing release of coordinated motor act. Action may be graded in intensity and it may be contingent on the type of sensory stimulus but maintain its basic pattern. Most insects have simple “startle” reflexes triggered by small disturbances as well as more comprehensive “escape” reflexes triggered by larger disturbances.

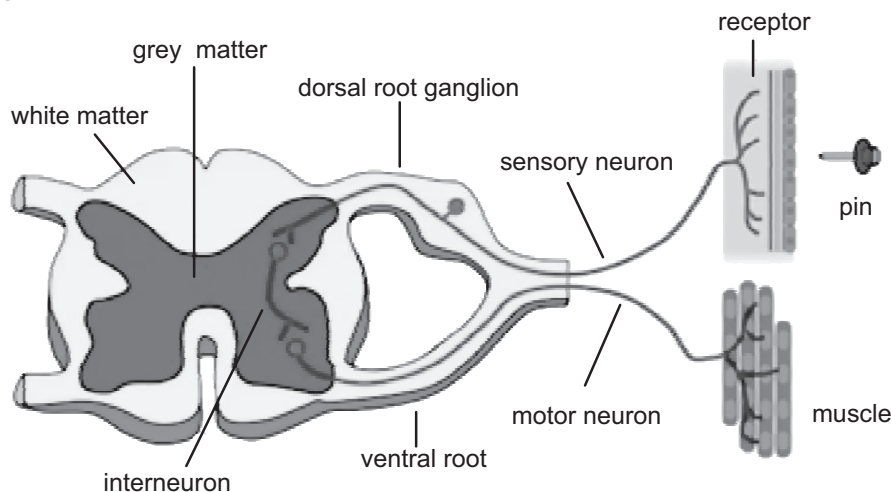

5. Reflex action is different from fixed action pattern. Firstly, reflex action is a simple motor action, stereotype and repeatable but fixed action is complex motor act, involving a specific temporal sequence of component acts. Secondly, reflex is elicited by a sensory stimulus and the strength of the motor action being graded with intensity of the stimulus while fixed action patterns are generated internally or elicited by a sensory stimulus. This stimulus acts as a trigger, causing release of coordinated motor act. Action may be graded in intensity and it may be contingent on the type of sensory stimulus but maintain its basic pattern. Most insects have simple “startle” reflexes triggered by small disturbances as well as more comprehensive “escape” reflexes triggered by larger disturbances.
6. Learning that a particular stimulus or a particular response is linked to a reward or punishment is called conditioning.

Classical Conditioning

It is a learning process in which an innate response to a potent stimulus comes to be elicited in response to a previously neutral stimulus; this is achieved by repeated pairings of the neutral stimulus with the potent stimulus. Eventually, the animal learns to respond to the stimulus even in the absence of a reward or punishment. The scientist Ivan Pavlov conducted a famous experiment on classical conditioning in which he trained a dog to salivate at the sound of a bell.

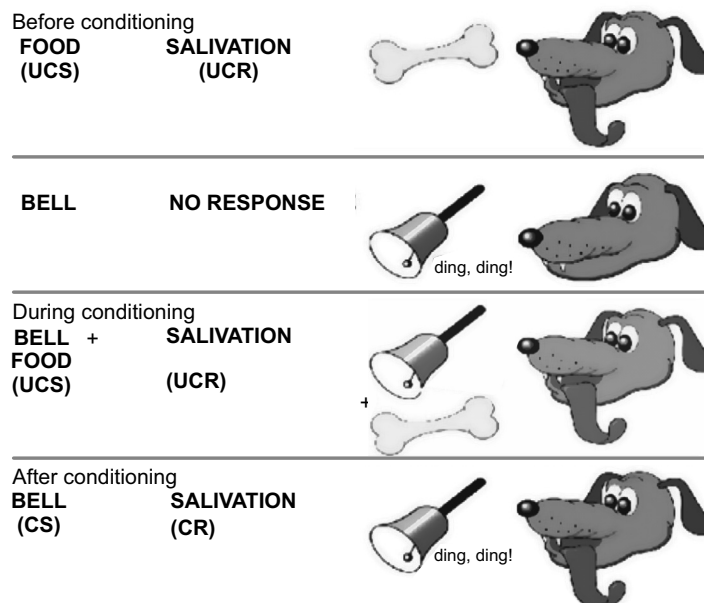

Operant Conditioning (Learning by Trial and Error)

An animal learns to associate one of its own behavioural acts with a positive or negative effect. The animal tends to repeat the response if it is rewarded, but avoids the response if it is harmed. For example, predators quickly learn to associate certain kinds of prey with painful experiences. A coyote may learn the hard way not to attack a porcupine nose-first. Learning by trial and error often reinforces behaviours that are important to survival. In this, an animal receives a reward for making a particular response. Motivation is an internal need that causes an animal to act, and is necessary for learning to take place. Example: Learning to ride a bike or birds using different materials to build a nest until it is just right

7. (a) **Imprinting:** It is a form of learning in which an animal, at a specific critical time of its life, forms a social attachment to another animal. During this brief interval, the animal acquires an indelible memory of certain salient stimuli in its “home” environment (taste of the host plant, smell of the nest site, etc.). This memory is retained throughout life and recalled later when needed. Example: Relation between mother and newborn. Behavioural imprinting acts as an instinct for survival in newborns. The offspring must immediately recognize its parent, because threatening events, such as the attack by a predator or by other adults could occur just after hatching. Thus, imprinting is very reliable to induce the formation of a strong social bond between offspring and parent, even if it is the wrong one. Birds learn the characteristics of their siblings, which later on will influence their mating preferences as adults.
- (b) Learning that a particular stimulus or a particular response is linked to a reward or punishment is called conditioning.

Classical Conditioning

It is a learning process in which an innate response to a potent stimulus comes to be elicited in response to a previously neutral stimulus; this is achieved by repeated pairings of the neutral stimulus with the potent stimulus. Eventually, the animal learns to respond to the stimulus even in the absence of a reward or punishment. The scientist Ivan Pavlov conducted a famous experiment on classical conditioning in which he trained a dog to salivate at the sound of a bell.

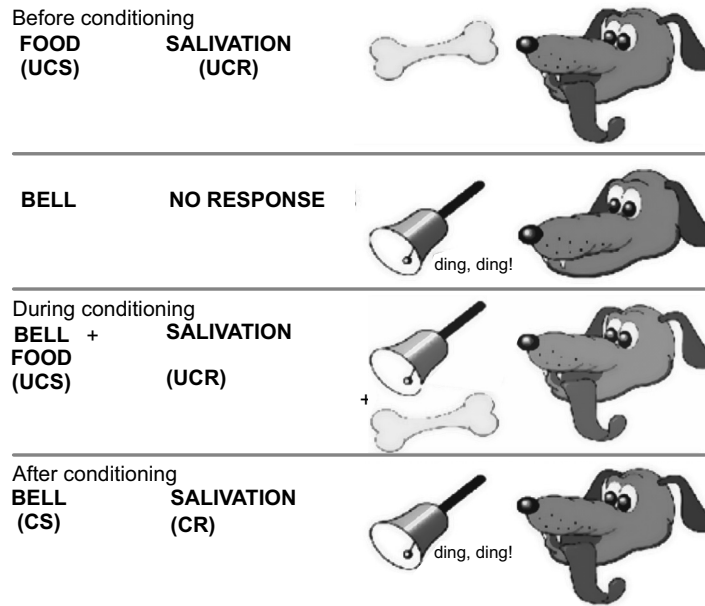

Operant Conditioning (Learning by Trial and Error)

An animal learns to associate one of its own behavioural acts with a positive or negative effect. The animal tends to repeat the response if it is rewarded, but avoids the response if it is harmed. For example, predators quickly learn to associate certain kinds of prey with painful experiences. A coyote may learn the hard way not to attack a porcupine nose-first. Learning by trial and error often reinforces behaviours that are important for survival. In this, an animal receives a reward for making a particular response. Motivation is an internal need that causes an animal to act, and is necessary for learning to take place. Example: Learning to ride a bike or birds using different materials to build a nest until it is just right.

- (c) **Habituation:** A simple form of learning in which an organism decreases or ceases its response to a stimulus after repeated presentations. It is progressive decrease of the amplitude or frequency of a motor response to repeated sensory stimulation that is not caused by sensory receptor adaptation or motor fatigue. Habituation provides an important mechanism for filtering sensory information, as it allows filtering out irrelevant stimuli and thereby focusing on important stimuli, a prerequisite for many cognitive tasks. Example: Horses or cows disregarding noisy cars and scare crow habituation to crows.
- (d) The natural world isn't always as pleasant a place as you might see in cartoons. It can be cutthroat, painful, and at times it is difficult for animals

to survive. Human activity has made all this the harder, as territories and ecosystems of plants and animals get destroyed, and natural patterns disrupted. For animals to live long enough to have young and continue their species, they often need clever strategies. Those strategies are called **survival skills**. Survival skills are the techniques animals use to stay alive and safe. They include everything from protecting territories, using camouflage, teamwork, sharing resources, fleeing from danger, and methods of scaring and intimidating enemies.

In this lesson, we're going to talk about a few of the most important common survival skills. We'll talk about some of the basics that animals need to survive: finding food, marking territories, defending resources, and avoiding dangers.

- (e) **Courtship:** It is the behaviour that males and females of a species carry out before mating. It communicates to each of the potential mates that the other is not a threat. It also reveals information to each animal that the species, gender, and physical condition of the other are suitable for mating. Courtship allows one or both sexes to select a mate from several candidates.
 - (f) Behaviour can be defined more precisely as an internally directed system of adaptive activities that facilitate survival and reproduction. A stimulus is an environmental change that directly influences the activity of an organism. Behaviour is a result of sensory and motor integration in an organism i.e., nervous system includes sensory cells that detect the changes in environment. Nerve cells transmit and integrate information; chemical messengers transmit information into body and muscle cells translate information into action.
 - (g) It is termed the periodic movements of animals away from and back to their place of origin. It is done annually. Animals migrate to other places with more suitable conditions of temperature, food, more favourable living or breeding places and hibernation. Example: African antelopes migrate seasonally to avoid drought. Fur seals and many whales make ocean voyages of thousands of miles to their breeding grounds, the former coming ashore on islands. Little brown bat live on trees in warm weather, but in cold weather they migrate to caves for warmer conditions.
8. Territoriality refers to the exclusive use of fixed space, which entails obtaining, defending, or advertising occupancy of the space. Animals divide geographical area around them into four broad regions:

- (a) Total range (entire area covered).
- (b) Home range (large area for all activities – feeding, sex and roaming is done).
- (c) Territory (small area within home ranges, driving away intruders and visited in days).
- (d) Core area (within territory but much smaller).

Sizes of Territories

This varies from species to species depending on body size, group size, and habitat and food requirement. Size of territory depends on size and diet of the animals. Larger species have larger territories e.g., wildebeest, zebras. Predators have larger territories than plant eaters. Territories are smaller when food is found in abundance and distribution is not spread far. Territorial animals patrol its outer limits.

Functions of Territoriality:

- (a) Well shaped aggregation of local population.
- (b) Well defined area for parental care.
- (c) Limitation of breeding population and control beyond carrying capacity.
- (d) Adequate food.
- (e) Reserve of unmated males and females for prompt replacement.
- (f) Reduction in rate of contracting parasites or diseases.
- (g) Helps intending against predators and share resources.
- (h) Collectively defend nests and young from predators.
- (i) Porters separate after breeding for short periods. Example: Wolves maintain territories in which they hunt and live. These areas are aggressively defended against other group members. The male cougar has a large territory that may overlap with the territories of several females but is defended against other males. Responding to scent marks, the inhabitants of the overlapping ranges also avoid each other, except for breeding.

9. Causes of Migration:

- External pressures like temperature, drought, food shortage. For example, most of the mule deer of Yellow stone Park, migrate between summer and winter pastures, but those living near hot springs, where grazing is available all year, do not.
- Physiological and environmental changes. Example: Birds migrate due to cycle of enlargement of the reproductive organs in spring and their reduction

in fall. Variation in day length is the chief external stimulus for this cycle: light received by the eye affects production of a hormone by the anterior pituitary gland, which stimulates growth of the reproductive organs.

Effects of Migration

- Migration increases diversity in the gene pool of the population.
- Migration increases competition for resources, habitat and breeding places.
- Migratory animals acting as vectors for disease, nutrients and energy, and other materials such as seeds across habitat or ecosystem boundaries.

10. (a) **Classical Conditioning:** It is a learning process in which an innate response to a potent stimulus comes to be elicited in response to a previously neutral stimulus; this is achieved by repeated pairings of the neutral stimulus with the potent stimulus. Eventually, the animal learns to respond to the stimulus even in the absence of a reward or punishment. The scientist Ivan Pavlov conducted a famous experiment on classical conditioning in which he trained a dog to salivate at the sound of a bell.

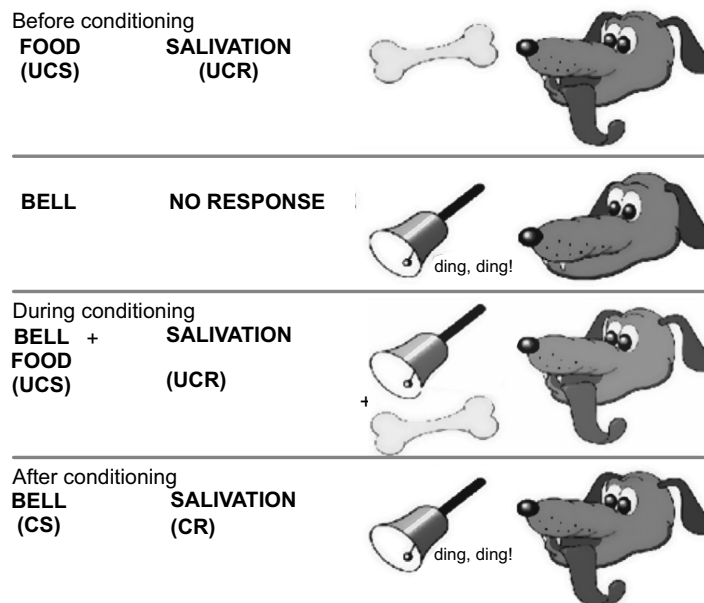

Operant Conditioning (Learning by Trial and Error)

An animal learns to associate one of its own behavioural acts with a positive or negative effect. The animal tends to repeat the response if it is rewarded, but avoids the response if it is harmed. For example, predators quickly learn to associate certain kinds of prey with painful experiences. A coyote may learn the hard way not to attack a porcupine nose-first. Learning by trial

and error often reinforces behaviours that are important for survival. In this, an animal receives a reward for making a particular response. Motivation is an internal need that causes an animal to act, and is necessary for learning to take place. Examples: Learning to ride a bike, or birds using different materials to build a nest until it is just right.

(b) Migration and Dispersal are different from each other. Migration is the movement of large number of species from one place to another like bird migration. While dispersal is the spreading of individuals away from others, often parents or siblings, which are left behind in original areas, for example: mammals move away from their social groups.

- 11.** It is a form of learning that is not immediately expressed in an overt response; it occurs without any obvious reinforcement of the behaviour or associations that are learned. Latent learning implies that learning can take place without any behavioural changes being immediately present. This means that learning can be completely cognitive and not instilled through behavioural modification alone. This cognitive emphasis on learning was important in development of cognitive psychology. Latent learning can be a form of observational learning (i.e., learning through observing the behaviour of others), though it can also occur independently of any observation.

Example: A rat completes a maze several times, without an incentive. The rat learns the maze very slowly (Figure 14.9). When food is placed at the end of the maze, the rat completes the maze very quickly, demonstrating that latent learning had occurred and a cognitive map of the maze was informed.

- 12. Behavioural Rhythms:** They are periodic biological fluctuations in an organism that corresponds to, and is in response to, periodic environmental change. These rhythms are the repeating patterns of biochemical, physiological, and behavioural processes. They are found in most living things, including plants, animals and many microorganisms.

These rhythms allow the animals of different species to share the same food sources without direct competition because some animals are active only during hours of darkness (i.e., they are nocturnal) while others are active only during the day (diurnal). The advantage of having a built-in method of responding to light and darkness, rather than relying on actual changes in light as a cue, is that, in effect, the organism is prevented from “sleeping late” and missing the optimal time of day for foraging.

Most common biological rhythm is the circadian rhythm (circa- about plus dian-day). The circadian rhythm is a rest-activity cycle that is centered on light, meaning when a preset amount of light occurs, an animal will be active, and at another time the animal will rest. Humans are active when there is a lot of light, which is usually during the day and rest when there is less light, usually at night. These circadian rhythms control the core human body temperature, sleep wake cycle and secretion of hormones.

Hibernation and migration are the examples of biological rhythms.

Examples: Ground squirrels gather rations and pack on fat reserves in the fall in preparation for cold winters spent underground.

Moose reproductive cycles match the birth of fawns in the spring to the rich emergence of forage at that time.

Human core body temperature cycles with a low during the middle of their sleep cycle and highs around lunch time and early evening.

13. There are many things one can do to help a friend or the beloved one who has been diagnosed with HIV:

- **Talk:** Be available to have an open, honest conversation on HIV. Follow the lead of the persons who are diagnosed with HIV. They may not always want to talk about it, or may not be ready. They may want to connect with you in the same ways they did before being diagnosed. Do things you did together before their diagnosis; talk about the things you talked before their diagnosis. Show them that you see them as the same person and that they are more than their diagnosis.
- **Listen:** Being diagnosed HIV is life-changing news. Listen to your beloved ones and offer your support. Reassure them that HIV is a manageable health condition. There are medicines that can treat HIV and help them stay healthy.
- **Learn:** Educate yourself about HIV: what it is, how it is transmitted, how it is treated, and how people can stay healthy while living with HIV. Having a solid understanding of HIV is a big step forward in supporting your beloved ones. This website is a good place to begin to familiarize yourself with HIV. Have these resources available for your newly diagnosed friends if they want them. Knowledge is empowerment, but keep in mind that your friend may not want the information right away.
- **Encourage treatment:** Some people who are recently diagnosed may find it hard to take that first step to HIV treatment. Your support and assistance

may be helpful. By getting linked to HIV medical care early, starting treatment with HIV medication (called antiretroviral therapy or ART), adhering to medication, and staying in care, people with HIV can keep the virus under control, and prevent their HIV infection from progressing to AIDS. Encourage your friends or beloved ones to get into treatment as soon as possible and help them find an HIV care provider. Use the HIV Testing and Care Services Locator to find a provider.

- **Support medication adherence:** It is important for people living with HIV to take their HIV medication every day, exactly as prescribed. Ask your beloved ones what you can do to support them in establishing a medication routine and sticking to it. Also, ask what other necessities they might have and how you can help them stay healthy. Learn more about treatment adherence.
- **Get support:** Take care of yourself and get support if you need it. Turn to others for any questions, concerns, or anxieties you may have so that the persons who are diagnosed can focus on taking care of their own health.

14.13 ASSESSMENT METHODS

Use observation technique, question answer technique, and demonstration technique to assess the learners' achievement of learning objectives.

14.14 ASSESSMENTS

Formative Assessment

Fill in the blanks:

1. Innate behaviours are adaptations that have an history.
2. Rat competing maze is example of

Ans. 1. Phylogenetic, evolutionary, 2. Latent learning

Summative Assessment

Answer in one word:

1. Classical condition is shown by
2. Movement directly toward (positive) or away from (negative) a stimulus.

Ans. 1. Pavlov's experiment, 2. Taxis

Unit 15: Immune System, Vaccination and Antibiotics

15.1 LEARNING OBJECTIVES

| Knowledge and Understanding | Skills | Attitudes and Values |
|--|---|--|
| <ul style="list-style-type: none"> • State the origin and describe the mode of action of phagocytes. • Describe the modes of action of B-lymphocytes and T-lymphocytes. • Explain the meaning of the term immune response, making reference to the terms antigen, self and non-self. • Explain the role of memory cells in long-term immunity. • Distinguish between active and passive, natural and artificial immunity and explain how vaccination can control disease. • Explain the role of antibodies in allergies. • Distinguish between generalised and localised allergic reactions. • Discuss the causes, symptoms and treatment of asthma and hay fever. • Discuss the reasons why vaccination programmes have eradicated smallpox but not measles, TB, malaria or cholera. • Define antibiotic as a substance produced by one microorganism that is capable of destroying or inhibiting the growth of another microorganism. • Explain how antibiotics work. • Explain the reasons for antibiotic resistance. | <ul style="list-style-type: none"> • Recognise phagocytes and lymphocytes under a light microscope. • Relate the molecular structure of antibodies to their functions. • Interpret the differences between cellular responses and humoral responses. • Carry out research and be able to present the findings on the reasons for antibiotic resistance in the treatments of infections. | <ul style="list-style-type: none"> • Support and promote national immunisation days. • Support and have sympathy for asthmatic patients. |

15.2 TEACHING AIDS

Visual: Images of immunity.

Audio-video: Video showing the process of vaccination.

15.3 TEACHER'S TIP

Start the unit by briefing the learners by stating the different types of agents which affect the health of organism. Aware them of immune responses and line of defence in body. Interpret the differences between cellular responses and humoral responses. Introduce the term 'immunity' and its type. State how vaccination and breastfeeding account to sustainable disease prevention. Talk about allergy and vaccination and diseases like asthma, hay fever. Effective use of antibiotics and their role.

15.4 TEACHING METHODS

Brainstorming, short lecture technique, group discussion technique, observation technique, drawing technique, demonstration technique, field visit, site visit and practical work.

15.5 TEACHING AND LEARNING MATERIALS

Microscopes, prepared slides of white blood cells, and statistics on disease occurrence.

15.6 TEACHING METHODOLOGY

Teacher initiates the topic by introducing the phagocytes and their mechanism. Ask the learners to discuss the examples.

Learners reply to the teacher.

Appreciating them, further ask if they are aware of immune responses.

Learners will come up with varied answers. Some correct, some near to correct, others being irrelevant.

Teacher will not demotivate the child. But agreeing to the correct answers, move further in discussion.

Teacher will explain immunity, its types and vaccination.

Using short lecture technique, teacher will explain the different diseases as asthma.

The teacher also tells about antibiotics.

15.7 ADDITIONAL CONTENT FOR THE TEACHER

Monoclonal Antibodies

Monoclonal antibodies are highly specific for specific antigens and are produced by fusing normal antibody producing cells with cells from cancerous tumours. For the production of monoclonal antibodies, mouse/rat/ some other animal is injected with specific antigen (against which the antibodies are required). The animal starts developing antibodies against the antigen in B lymphocyte cells in spleen. Then the spleen of animal is removed and its B lymphocyte cells are isolated. The cells producing bone marrow cancer (myeloma cells) are also isolated. The two types of cells (i.e., myeloma cells and antibody producing B lymphocyte cells) are made to fuse in cultures. The fused cells are called **hybridomas**. The hybridoma cells are allowed to multiply and each clone is tested for its ability to produce desired antibody. The clones which produce desired antibody are cultured for large scale production of monoclonal antibodies. Monoclonal antibodies are used for diagnosis of some specific diseases and as immunosuppressives drugs for patients with kidney transplantation.

Activity

The teacher can demonstrate this activity in the class.

Aim: To make the learners aware of vaccination.

Refer to text and ask the learners to collect pictures of different vaccines. Ask them to paste on chart papers and label them along with their diseases.

Ask each learner to read it aloud and tell the history of vaccination.

15.8 SUMMARY

- Immune system has the capacity to kill cells, it is very important for it to make a distinction between self and non-self.
- Whenever there is a failure in distinguishing self from non-self, auto-immune diseases develop such as multiple sclerosis, rheumatoid arthritis.
- Mounting of a successful immune response depends on a number of cells and chemical mediators, defect in any component can lead to immunodeficiency state such as absence of mature *T lymphocytes* in Di George syndrome.
- Immune system has two main parts, innate and adaptive.
- Two branches of the immune system collaborate with each other to make a highly effective immune response.
- Innate system is present at birth, comes into operation immediately upon infection, relies on barriers such as skin and mucous membranes, phagocytes and NK cells, and lacks memory.

- Adaptive system is acquired by 6 months after birth, takes time to mount an immune response, relies on B and T lymphocytes and has memory.
- Adaptive or acquired immunity is of two types, humoral and cell mediated.
- Humoral immunity generates specific antibodies against pathogens present in blood.
- Cell mediated immunity generates cyto-toxic chemicals to lyse infected cells.
- Antibodies neutralize toxins and help in eliminating microbial organisms.
- Antibodies are of five types IgM, IgG, IgA, IgE and IgD.
- There are two types of T lymphocytes: helper T lymphocytes and Tc lymphocytes.
- T lymphocytes recognize antigen of the pathogen in association with MHC.
- Helper T lymphocytes actively secrete a number of cytokines which affect the activity of macrophages, B lymphocytes and Tc cells converting the latter into CTL.
- CTLs, macrophages and NK cells secrete cytotoxic chemicals onto cells having intracellular pathogen causing cell death.
- Vaccinations can be Active or Passive.
- Active vaccination is achieved either by natural infection or by immunization with live attenuated or killed infectious organisms.
- Passive immunization is achieved by introduction of preformed antibodies.
- Generation of memory cells during first encounter with the infectious agent produces a secondary response with a high intensity.
- Vaccination programmes for a number of diseases have been very successful, though for some diseases, effective vaccines are not available yet.
- Although active vaccines have helped eradicate a number of diseases, they pose a serious threat in immunodeficient individuals.
- Passive immunization is chosen in cases of emergency or immunodeficiency.
- Allergies, also termed hypersensitive responses, which are potentially damaging to the tissues, are produced by the body to seemingly non-pathogenic substances in the environment.
- Allergies are broadly classified into four types: class I mediated by IgE; class II mediated by IgG or IgM; class III by activation of complement by immune complexes; class IV cell mediated (esp. macrophages) hypersensitivity.
- Type I allergies are seen in hay fever, asthma, and food allergies; type II allergies are seen in blood transfusion reactions; type III allergies are seen after insect bite or serum sickness after antitetanus injection; type IV allergies are seen in contact dermatitis, graft rejection.

- When the hypersensitive reactions are limited to specific target tissue or organ, it is called localized reaction as seen in hay fever and asthma. However, when a large number of organs become simultaneously affected upon entry of allergen directly into the bloodstream absorbed from the gut, it results in generalized reaction with fatal consequences.

Symptoms and treatment

- Type I hypersensitive reactions are mediated by heparin released by mast cells and epinephrine can reverse these effects in generalized reactions while antihistamines are used for localized reactions.
- In all other cases of allergies involving drug, food item, blood transfusion, anti-toxin antiserum, the best strategy is to immediately discontinue the use of such agents.
- Antibiotics are drugs used extensively by doctors to treat bacterial infections. Mortality rate due to bacterial infections has declined drastically since the use of antibiotics started.
- A number of soil microbes produce a large variety of chemicals to inhibit other organisms growing in their surroundings and provide a rich source of antibiotics.
- Antibiotics either kill bacteria by inhibiting their cell wall synthesis or slowing their growth by affecting DNA replication or RNA/ protein synthesis.
- Different antibiotics show different specificities, some antibiotics working against a number of bacteria, while others being more specific.
- Prolonged and overuse of antibiotics has led to evolution of different mechanisms by which bacteria have become resistant to commonly used antibiotics such as development of enzyme beta lactamase to break down beta lactam ring, actively move the drug out of the cell (efflux), change its cell wall permeability etc.

15.9 WEBLINKS FOR CONTENT ENRICHMENT

- <http://www.sciencedirect.com/science/journal/10747613>
- <http://www.journals.elsevier.com/immunity>

15.10 LEARNERS' ACTIVITIES

Activity 1

The teacher should guide the learners to perform the following activity.

Hint:

(i) The slide shows a number of different types of cells. (ii) and (iii) These cells differ in their size, staining properties and presence or absence of nucleus. (iv) Very small

cells are the most numerous. (v) These cells are called red blood cells. (vi) Large cells are less numerous and are called white blood cells as they don't contain red pigment. (vii) All white blood cells are not alike. Lymphocytes have a large nucleus with very little cytoplasm. Neutrophils have a multi-lobed nucleus. Monocytes are large, with lot of cytoplasm and kidney shaped nucleus. (viii) Stain indicates the size and shape of the nucleus.

Activity 2

The teacher should guide the learners to perform the following activity.

Hint:

- (i) Humoral branch of immunity recognizes the pathogen by membrane bound antibodies called B-cell receptors.
- (ii) In cell mediated branch of immunity, Phagocytes have receptors on their cell membrane which can recognize molecules present on the microbial pathogens and T lymphocytes recognize antigen in association with MHC.
- (iii) The two branches are interconnected at many points: (a) antibodies of humoral immunity promote phagocytosis of pathogens by phagocytes. (b) helper T lymphocytes help B lymphocytes in not only making greater amounts of antibody but also in making different types of antibodies and memory cells.

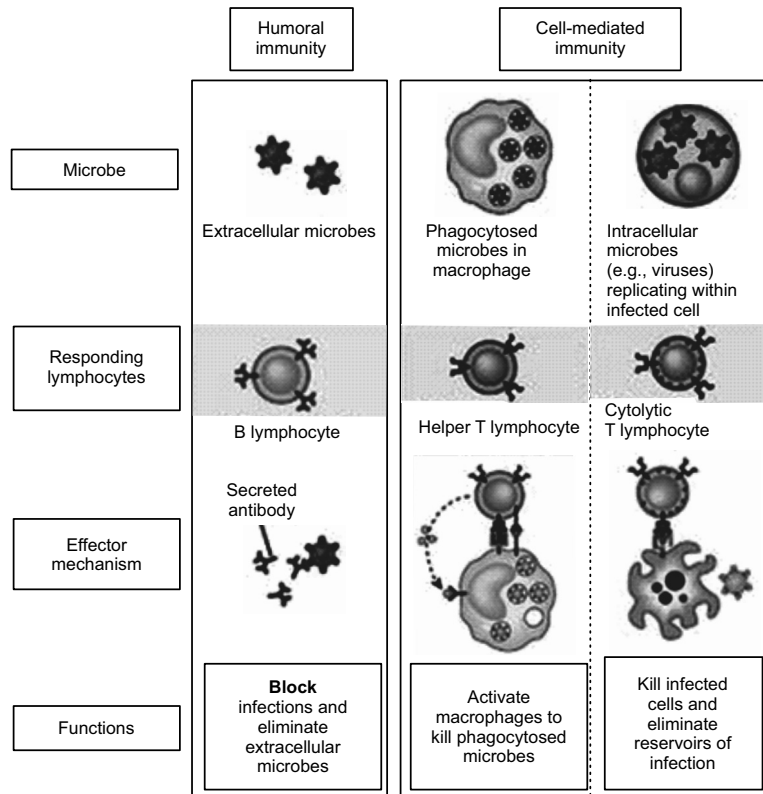

- (iv) These two branches are connected to innate immunity at many points:
- NK cells of innate immunity are helped by antibodies of humoral immunity in their target cell recognition.
 - Phagocytes of innate immunity show enhanced phagocytosis of antibody-tagged microbes.
 - Cytokines secreted by helper T lymphocytes enhance the killing capacity of phagocytes.
 - Phagocytes and NK cells of innate immunity take part in cell mediated killing of pathogens and in this process they are assisted by antibodies.

Activity 3

The teacher should guide the learners to perform the following activity.

Hint:

Vaccines have saved millions of lives world over but the vaccination programmes have met with greater success wherever undertaken nationwide, on sustained basis with high implementation rates.

Stable small pox vaccine was perfected by 1940 and in 1959, World Health Assembly adopted the goal to eradicate small pox and by 1980, it has been eradicated globally owing to sustained efforts of vaccination programmes.

Measles vaccines have averted nearly 17.1 million deaths between 2000 and 2014. It continues to kill about 400 children each day, mainly in Africa and Asia. In 2014, more than 60% of the 21.5 million children who were not vaccinated against measles live in only six countries: India, Nigeria, Pakistan, Indonesia, Ethiopia and the Democratic Republic of Congo. As measles is highly contagious, transmission is higher in densely populated areas with low levels of hygiene. Also, it requires boosters which may be difficult in countries with poor infrastructure. Unwillingness on the part of parents to vaccinate their children may further decrease the efficacy of the vaccination programme. As long as it is present in one area, unvaccinated children in any country are at risk people travelling from one area to the other carry and thus transmit the infection to new locations.

Malaria: In 2015, there were 214 million malaria cases and estimated 438000 malaria deaths (compared to 839000 deaths in 2000). Increased prevention and control measures have led to a 60% reduction in mortality rates. Malaria cases are rather high in Sub-Saharan Africa.

Tuberculosis vaccination has been quite effective in infants and young children but with variable efficacy in adults.

Activity 4

The teacher should guide the learners to perform the following activity.

Hint:

World Immunization Week is observed by WHO from 24th to 30th April every year to have campaigns for spreading awareness of the importance of vaccinations in eradicating these deadly diseases as well as to provide vaccinations worldwide.

Participation in awareness campaigns should be encouraged. Learners should collect information on the spread and control of these diseases, realize the importance of maintaining hygienic conditions and good nutritional status. Learners can educate the general public about the need of vaccination clarifying the myths against vaccinations. The following information can be shared through awareness campaigns.

Tuberculosis: It is a bacterial, highly infectious disease, causing a lot of mortality worldwide; common symptoms include cough, shortness of breath, low-grade fever, fatigue, weight loss. It is spread through the air when a person with untreated pulmonary TB coughs or sneezes. When a person with TB is not taking proper treatment, he may not only spread the disease to others but he may also become severely ill or die. The most important way to stop the spread of TB for TB patients is to cover the mouth and nose when coughing and to take the full course of the medicine as prescribed.

Measles: It is a highly contagious disease caused by a virus and is normally passed through direct contact and through the air. The virus spreads throughout the body, causing high fever, runny nose, cough watery eyes and small white spots inside the cheeks in the initial stage. After several days, a rash erupts on the face and upper neck, spreading to hands and feet. The rash lasts for 5-6 days. Most measles related deaths are caused by complications associated with the disease such as blindness, encephalitis, severe diarrhoea, ear infections or pneumonia. Severe measles is more likely among poorly nourished young children, especially with insufficient vitamin A, or with weak immune system.

The best strategy is prevention through routine vaccination of children and increasing awareness of people through mass campaigns, to indicate that vaccine is safe, effective and inexpensive.

Cholera: It is caused by ingestion of highly infectious bacteria through contaminated food or water and produces sudden onset of watery diarrhoea with or without vomiting that may lead to death in a few hours as a result of dehydration and circulatory collapse. With proper treatment, mortality is greatly reduced.

The best strategy is prevention and hence the need to highlight the importance of proper water management, with sufficient sanitation and providing adequate safe drinking water, through awareness campaigns. In the event of a potential cholera outbreak, oral cholera vaccines need to be used to avoid casualties though the protection conferred is for small duration.

Activity 5

The teacher should guide the learners to follow the instruction of activity and do it on their own.

Hint:

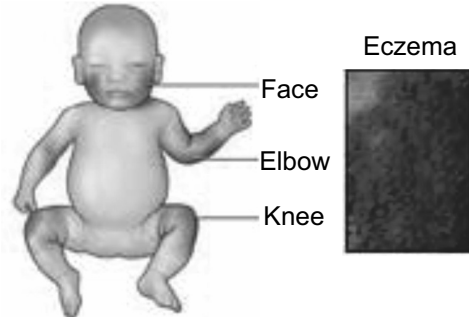

Allergic reaction to food

The Big Eight: Most Common Food Allergies

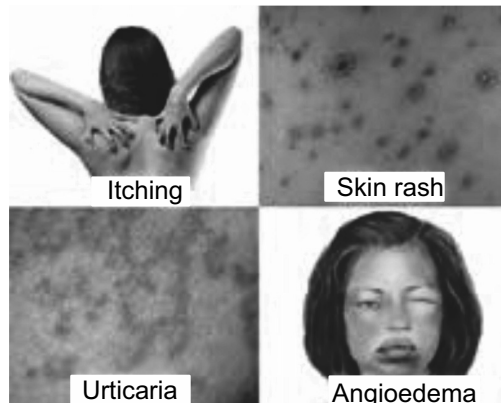
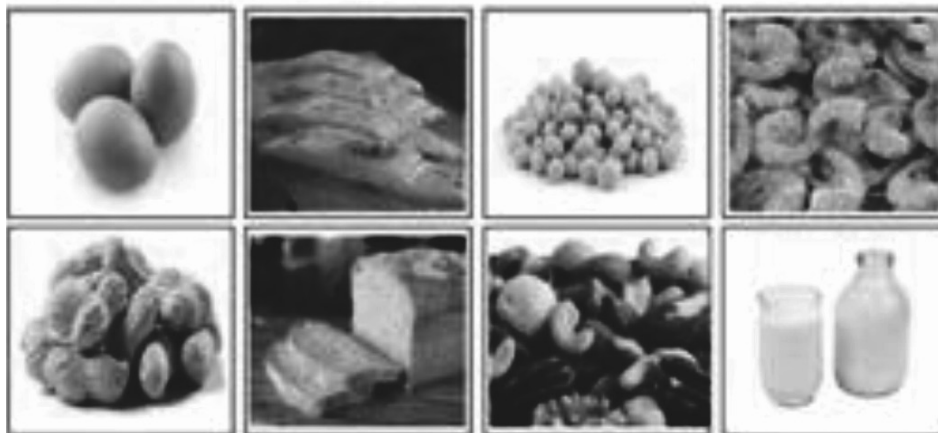

Allergic reaction to penicillin



Allergic reaction to sting of bee



An asthmatic child using inhaler

- (a) Some people are allergic to seemingly harmless substances in the environment. Therefore, upon second exposure to such commonly found allergens such as pollen, dust etc., their mast cells release histamine and other chemicals responsible for these symptoms.
- (b) Some people are allergic to certain food items. Therefore, upon second exposure to the same food item may produce a generalized allergic reaction, leading to a fall in blood pressure and laboured breathing due to contraction of bronchioles. Since it can be potentially fatal, a warning is put on the label.
- (c) As penicillin can elicit generalized allergic reaction in some individuals, which is potentially fatal, a test dose is always injected in the skin to check if the person is allergic or not.

Activity 6

The teacher should ask the learner to perform activity individually.

Hint:

| Disease | Initial Antibiotics Used | Resistance Acquired |
|-----------------------|--|--|
| Shigella Dysentery | Beta Lactams (ampicillin amoxicillin), Quinolones (ciprofloxacin) Macrolides (Azithromycin); others: sulphonamides, tetracycline | Sulfonamides, tetracyclines, ampicillin |
| Pneumonia | Macrolides (Azithromycin, erythromycin), Tetracyclines (doxycycline), ephalosporins (cefuroxime), Penicillins (amoxicillin, ampicillin), Vancomycin, Quinolones (ciprofloxacin) | Macrolides(azithromycin), amoxicillin, methicillin, cephalosporins |
| Tuberculosis | Quinolones, Isoniazid, Rifampicin, Pyrazinamide, Ethambutanol, Streptomycin | Quinolones, kanamycin, amikacin, isoniazid, rifampicin |

As the use of antibiotics has increased, it has also led to the evolution of resistance in a number of microbial pathogens with the result that earlier antibiotics are no longer effective in treating a disease. Resistance may have developed by a number of mechanisms for example,

- (a) Production of enzyme beta lactamase that breaks down beta- lactam ring of antibiotics such as penicillin and cephalosporin, for example, Escherichia coli, Salmonella, Shigella, Vibrio cholerae
- (b) Mutation in a gene leading to the formation of an altered protein which does not bind penicillin
- (c) Altered cell wall permeability confers resistance to tetracyclines, quinolones, penicillin, e.g., Pseudomonas aeruginosa, E. coli, Klebsiella pneumoniae
- (d) Creating a barrier of biofilm, where bacteria are not attacked by the host's immune system as seen in Salmonella
- (e) A gene can produce a product that can pump out the antibiotic as in Staphylococcus against erythromycin
- (f) Some bacteria show alteration in ribosome structure so that protein synthesis is not affected.

Activity 7

Hint:

The teacher should guide the learner to perform the activity on their own.

- (i) **Tuberculosis** is a major killer, causing 2 to 3 million deaths annually.
Measles is a leading cause of death. In 2014 alone, there were 114900 measles death globally.
Smallpox was responsible for 300–500 million deaths during the 20th century.
Cholera is responsible for 28000 to 142000 deaths per year worldwide.
- (ii) **Medical science** has contributed a lot in reducing the mortality caused by these diseases due mainly to vaccines and antibiotics.
- (iii) It has been completely successful in eliminating smallpox from the world; mortality due to measles has declined drastically by 79%. Tuberculosis and cholera are still posing a big challenge to medical science for various reasons such as non-availability of sufficient medicines, limited infrastructure, unwillingness on the part of parents to get their children vaccinated and not taking full course of the prescribed medication coupled with high rate of transmission in densely populated regions.

- (iv) Our immune system defends us against microbial pathogens, by increasing numbers of different cell types, and by producing various chemical molecules for example, proliferation of lymphocytes and phagocytes and secretion of antibodies, cytokines, complement factors. All these processes are energy dependent and occur efficiently only under good nutritional status. It is for this reason, that malnourished children suffer more from these diseases as they cannot mount an effective immune response.
- (v) **Cholera** is a waterborne disease and spreads by contaminated food and water. Tuberculosis and measles are also very infectious and spread through air and contact. By providing safe drinking water and maintaining good sanitary conditions, suffering and mortality can be greatly reduced.

15.11 ANSWERS TO SELF-EVALUATION

Self-evaluation

- (i) IgM
- (ii) T lymphocyte
- (iii) IgG
- (iv) Adaptive

Self-evaluation

- (i) Vaccination
- (ii) Toxin
- (iii) Generalized allergic reaction
- (iv) Hay fever
- (v) *Penicillium notatum*

15.12 ANSWERS TO END UNIT ASSESSMENT 15

I. Choose whether the given statements are True (T) or False (F):

1. **True;** innate immunity is present at birth.
2. **False;** as breast milk contains IgA type of antibodies.
3. **True;** as antibodies can tag the microbial agents and bind to phagocytes.
4. **False;** as antibiotics cure the disease by either killing or slowing the growth of bacteria.
5. **True;** as initially this disease was curable, but gradually the bacterium acquired resistance to a number of antibiotics.
6. **False;** as hay fever is a localized allergic reaction involving upper respiratory tract.
7. **True;** as memory cells are already primed and upon second exposure to the same antigen grow bigger in size and start secreting antibody.

- 8. True;** as preformed antibodies are administered to neutralize the toxin with no stimulation of immune system.
- 9. False;** Immune system has two main parts, innate and adaptive.
- 10. True;** as intact cell wall is important for survival of bacteria.

II. Multiple choice questions:

- 1. (d);** recognition of antigen by receptors on B-lymphocytes.
- 2. (b);** as IgG type of antibodies can cross placenta
- 3. (a);** as B-lymphocytes grow in size, acquire Golgi apparatus and transform into actively secreting plasma cells.
- 4. (c);** as histamine causes decrease in blood pressure and respiratory problem due to constriction of bronchioles
- 5. (b);** as tetracycline binds to 30S ribosomal sub-unit preventing bacterial protein synthesis
- 6. (b);** is correct as in the absence of thymus, mature T cells don't form
- 7. (b);** as Rheumatoid arthritis is an auto-immune disease
- 8. (c);** as live attenuated pathogens by changing to virulent form can actually cause disease.
- 9. (b);** it is the reaction of the cells and fluids of the body to the presence of a substance.
- 10. (c);** as by employing various strategies bacteria have evolved resistance to a number of antibiotics leaving many diseases untreatable.

III. Long answer type questions:

1. When a blood smear is prepared, two types of cells can be identified: small, very numerous, without nucleus called red blood cells (RBC) because they contain red pigment, haemoglobin for oxygen transport and large, less numerous, with darkly staining nucleus called white blood cells (WBC), because they do not contain red pigment. Among the WBCs, different cell types can be distinguished: (i) Phagocytes, which include neutrophils (having single, multi-lobed, nucleus) and monocytes (having kidney-shaped nucleus) with a moderate amount of cytoplasm, and (ii) Lymphocytes, with a very large, darkly staining nucleus occupying the entire volume of the cell, with very little cytoplasm.

Phagocytes, which include both neutrophils and macrophages, play an important role in innate immunity. They can identify foreign invading pathogens, discriminate them from cells of the body, and internalize them by throwing

pseudopodia around them. Once within the phagocytes, pathogens are digested by a number of hydrolytic enzymes, thus freeing the body of disease-causing germs. Phagocytes also help in removing old, dead cells as well as cancerous cells.

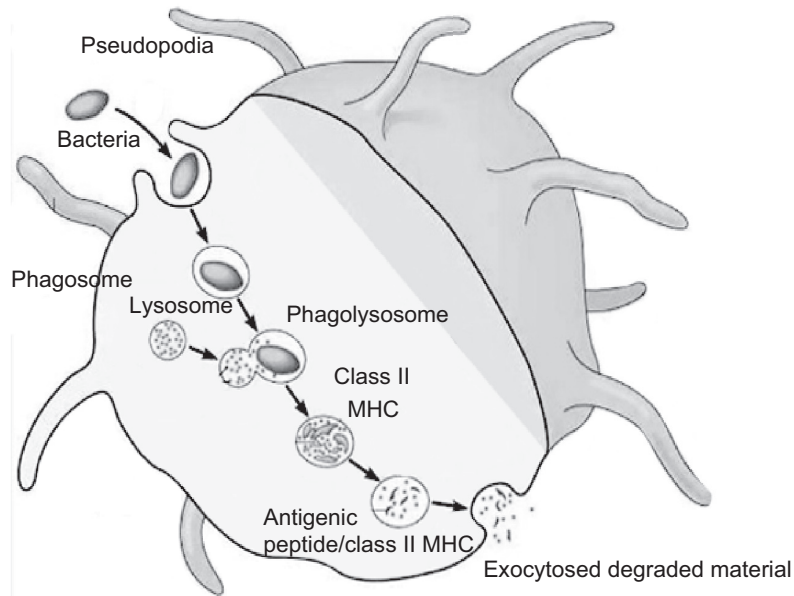

2. Antibodies are immunoglobulins, designated as Ig. Different types of antibodies, secreted by B-lymphocytes are written as IgM, IgG, IgA, IgE and IgD. These antibodies are capable of recognising over a million different antigens and confer protection in a number of ways. Functions performed by antibodies are: (i) Antibodies bind to toxins produced by bacteria that cause infection like diphtheria or tetanus, effectively nullifying them. (ii) By attaching to microbial pathogens, antibodies promote their clearance by phagocytes manifold. (iii) Antibodies form a covering on bacteria and viruses, not allowing them to gain entry into tissues. Bacteria and viruses, thus having being coated, are eliminated by beating of cilia present on the epithelial cells in the respiratory tract or by peristalsis of the gastrointestinal tract. (iv) Antibody, esp. of the IgG type, is highly mobile, capable of leaving circulation and reaching skin where it can neutralize surface bacteria. This antibody can also pass through the placenta reaching the developing foetus, providing it some protection against infections. (v) Antibody, esp. of the IgA type, is found in large amounts in mother's milk, and helps protect the newborn against infections during the first months of life when infant's immune system is not fully functional. (vi) Antibody of the IgE type, plays an important role against parasitic infections, though it is also responsible for the allergic reactions to various allergens in the environment and will be described later in detail.

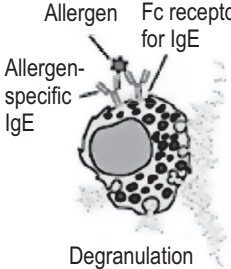
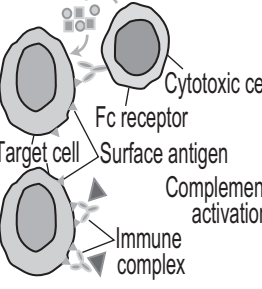
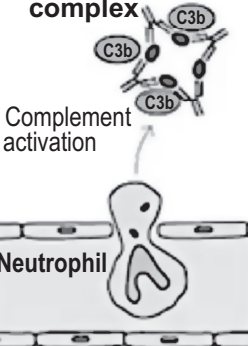
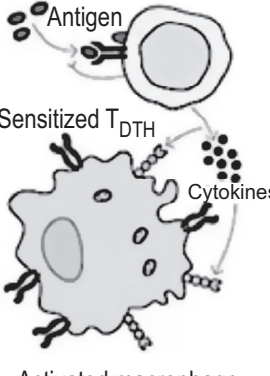
| | | | |
|--|---|--|---|
|  <p>Allergen Fc receptor for IgE Allergen-specific IgE Degranulation</p> <p>Type I</p> | <p style="text-align: center;">ADCC</p>  <p>Cytotoxic cell Fc receptor Target cell Surface antigen Complement activation Immune complex</p> <p>Type II</p> | <p style="text-align: center;">Immune complex</p>  <p>Complement activation C3b C3b C3b Neutrophil</p> <p>Type III</p> |  <p>Antigen Sensitized T_{H1} Cytokines Activated macrophage</p> <p>Type IV</p> |
| IgE mediated Hypersensitivity | IgG mediated Cytotoxic Hypersensitivity | Immune Complex Mediated Hypersensitivity | Cell Mediated Hypersensitivity |
| Ag induces crosslinking of IgE bound to mast cells and basophils with release of vasoactive mediators | Ab directed against cell surface antigens mediates cell destruction via complement activation or ADCC | Ag-Ab complexes deposited in various tissues induce complement activation and an ensuing inflammatory response mediated by massive infiltration of neutrophils | Sensitized T _{H1} cells release cytokines that activate macrophages or TC cells which mediate direct cellular damage |
| Typical manifestations include systemic anaphylaxis and localized anaphylaxis such as hay fever, asthma, hives, food allergies, and eczema | Typical manifestations include blood transfusion reactions, erythroblastosis fetalis, and autoimmune hemolytic anaemia | Typical manifestations include localized Arthus reaction and generalized reactions such as serum sickness, necrotizing vasculitis, glomerulonephritis, rheumatoid arthritis, and systemic lupus erythematosus | Typical manifestations include contact dermatitis, tubercular lesions and graft rejection |

Types of Hypersensitive responses

3. (a) Phagocytes, which include both neutrophils and macrophages, play an important role in innate immunity. They can identify foreign invading pathogens, discriminate them from cells of the body, and internalize them by throwing pseudopodia around them. Once within the phagocytes, pathogens are digested by a number of hydrolytic enzymes, thus freeing the body of disease-causing germs. Phagocytes also help in removing old, dead cells as well as cancerous cells.
- (b) Lymphocytes, with a very large, darkly staining nucleus occupying the entire volume of the cell, with very little cytoplasm. Generation of memory cells upon first exposure to infectious agent is seen in primary response. Primary response leads to the generation of activated lymphocytes of the B- or T- type as well as memory cells. This response is not only weak in intensity but also takes a long time to initiate.

- (c) Response produced by the body upon invasion of a foreign substance, especially infectious microbes and toxins produced by them and is protective in nature.

4. Humoral Immunity: B lymphocytes

Humoral immunity was discovered by Emil Behring and Shibasaburo Kitasato in 1890. This proved to be a landmark experiment and it earned von Behring Nobel Prize in Medicine. This experiment showed two important things: one, that following infection or immunization, substances appeared in serum that have the capacity to protect against the infective agent; this laid the foundation of humoral branch of immunity; second, that immunity could be transferred from immunized to non-immunized organism; this laid the foundation of strategy of passive immunization. Generation of humoral response involves:

- (a) Activation of B-lymphocytes
- (b) Conversion of B-lymphocytes into plasma cells
- (c) Secretion of antibodies
- (d) Functions performed by antibodies

B-lymphocytes, 6 micrometre in size, having a darkly staining, large nucleus, and very little cytoplasm, bear receptors on their surface which recognize and bind antigens on microbial organisms. Binding of receptors leads to activation of B-lymphocytes, which undergo a number of mitotic divisions producing two kinds of cells, effector cells called plasma cells and memory cells.

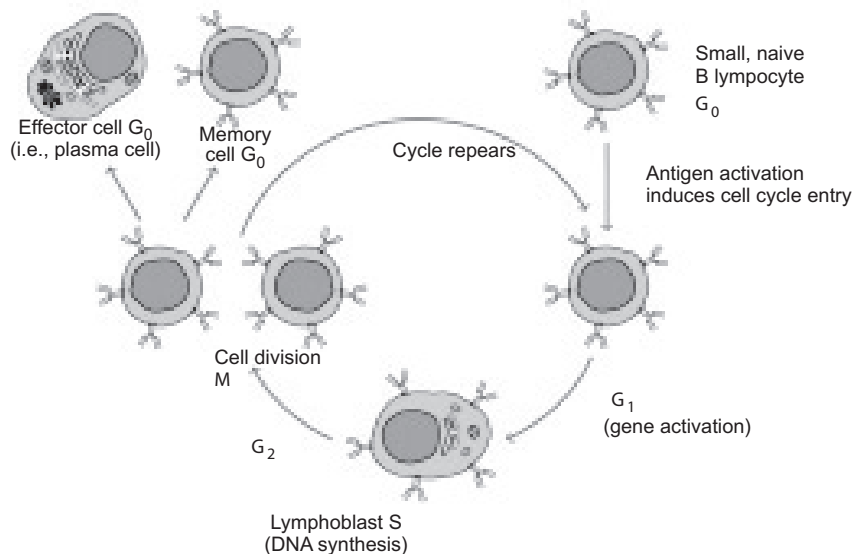

Effector cells or plasma cells, about 15 micrometre in size, with a large amount of cytoplasm having Golgi apparatus and endoplasmic reticulum, represent the end stage B-lymphocytes, which do not further divide but actively secrete antibody

molecules at a high rate. Antibodies are, proteins, called immunoglobulins, designated as Ig.

Different types of antibodies, secreted by B-lymphocytes are written as IgM, IgG, IgA, IgE and IgD. These antibodies are capable of recognising over a million different antigens and confer protection in a number of ways. Functions performed by antibodies are:

- (i) Antibodies bind to toxins produced by bacteria that cause infection like diphtheria or tetanus, effectively nullifying them.
- (ii) By attaching to microbial pathogens, antibodies promote their clearance by phagocytes manifold.
- (iii) Antibodies form a covering on bacteria and viruses, not allowing them to gain entry into tissues. Bacteria and viruses, thus having being coated, are eliminated by beating of cilia present on the epithelial cells in the respiratory tract or by peristalsis of the gastrointestinal tract.
- (iv) Antibody, esp. of the IgG type, is highly mobile, capable of leaving circulation and reaching skin where it can neutralize surface bacteria. This antibody can also pass through the placenta reaching the developing foetus, providing it some protection against infections.
- (v) Antibody, esp. of the IgA type, is found in large amounts in mother's milk, and helps protect the newborn against infections during the first months of life when infant's immune system is not fully functional.
- (vi) Antibody of the IgE type, plays an important role against parasitic infections, though it is also responsible for the allergic reactions to various allergens in the environment and will be described later in detail.

Cell-Mediated Immune Response: T Lymphocyte

Though antibody molecules are highly specific and confer high degree of protection to the body against toxins and microbes present in blood and extra-cellular fluids, they are not able to neutralise those pathogens which live within the cells e.g. viruses, malarial parasite, some bacteria such as *Salmonella*, *Mycobacterium* etc., Therefore, in order to protect the body from intra-cellular infectious organisms as well as to eliminate cancerous cells, body mounts cell-mediated immune response.

Generation of cell-mediated immune response:

1. Recognition and binding of antigens by T-lymphocytes, macrophages, neutrophils, and natural killer cells (NK). These cells differ in the way they bind antigens. T-lymphocytes recognize and bind antigens only in association with another set of proteins called major histocompatibility complex (MHC). Macrophages, neutrophils and NK cells can bind to antibody-tagged cells.

2. T lymphocytes are of two types, helper T lymphocytes and Tc cells. Helper T lymphocytes play an important role in both humoral and cell-mediated immunity by secreting important cytokines.
 3. Activation of the above mentioned cells (appearance of granules in T-lymphocytes and macrophages which are normally agranulocytes). T-lymphocytes get transformed into cytotoxic T lymphocytes, or CTL.
 4. Secretion of cytotoxic chemicals/cytokines, perforins, granzymes, interferon gamma and tumour necrosis factor in the vicinity of cells carrying intracellular pathogens.
 5. Cytotoxic chemicals/cytokines cause target cell destruction.
5. Memory cells are long lived, retain the same receptors as the original B-lymphocyte and can get activated upon second exposure to the same infectious agent to give rise to a heightened response.

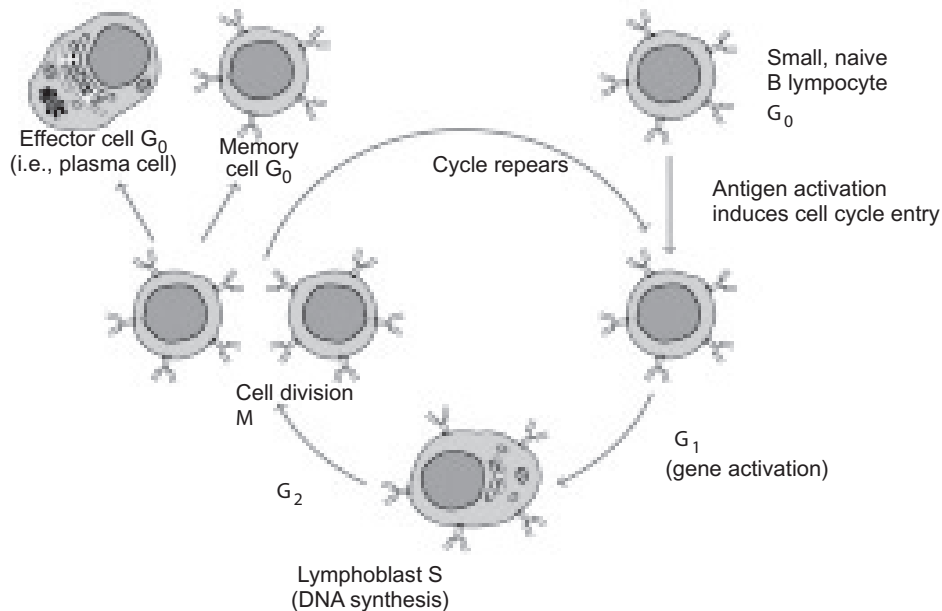

Generation of memory cells upon first exposure to infectious agent is seen in primary response. Primary response leads to the generation of activated lymphocytes of the B- or T- type as well as memory cells. This response is not only weak in intensity but also takes a long time to initiate.

However, upon second exposure to the same infectious agent, the immune response generated is faster and greater in intensity due to the already existing memory cells, and is called secondary response. It is the genesis of heightened immune response upon second exposure that laid the foundation of all active vaccination programmes.

6. (a) Active Immunity

- (i) It is produced due to contact with pathogen or its antigen.
- (ii) Immunity is not immediate. A time lapse occurs for its development.
- (iii) It lasts for a sufficiently long period, may be lifelong.
- (iv) Antibodies are produced by the body in response to pathogen or antigen.
- (v) Side effects are very few.

Passive Immunity

- (i) It is produced due to antibodies obtained from outside
- (ii) Immunity develops immediately
- (iii) It lasts for a few days
- (iv) Antibodies are obtained from outside
- (v) At times the body reacts to the introduction of antisera. It is called serum sickness.

<http://www.majordifferences.com/2014/04/difference-between-active-and-passive.html#.WMON4NR97Wc>

(b)

| Generalized Allergic Reaction | Localized Allergic Reaction |
|---|---|
| Very severe, multi-organ response, can be fatal, if not treated urgently. | Mild response, restricted to a target tissue or organ, generally not fatal. |
| Contraction of smooth muscles of bronchioles causing breathing problems. | Watery eyes, running nose, sneezing when allergen inhaled. Upper respiratory tract affected (Hay fever) or lower respiratory tract affected (Asthma). |
| Dilation of blood vessels decreasing blood pressure resulting in shock and collapse. | Small blood vessels begin to leak blood into tissue causing sudden and dramatic drop in blood pressure. |
| May be caused by penicillin, antitoxins, sting from bee, wasp, ant. | May be caused by pollen, dust, fumes, insect products. |
| Immediate administration of epinephrine can restore blood pressure and relax smooth muscles for normal breathing. | Use of anti-histamines relieves the symptoms. |

7. First exposure to allergen leads to the formation of IgE type of antibodies which bind to mast cells present in large numbers throughout the body. Second exposure to the same allergen causes cross-linking of IgE molecules on the already sensitized mast cells, leading to their degranulation and release of substances stored in their granules such as histamine, heparin, proteases, etc. Principal effects seen are vasodilation and smooth muscle contraction (Figure 15.6). Vasodilation decreases blood pressure and contraction of smooth muscles of bronchioles affects respiration. **Hay fever** occurs upon inhaling certain allergens in the air leading to watery eyes, running nose, sneezing and coughing, involving mainly upper respiratory tract.

Asthma involves lower respiratory tract when histamine released from mast cells causes contraction of bronchioles. Mucus accumulates in the air sacs, causing respiratory problems and the characteristic wheezing sound. It can prove fatal if left untreated for too long. Allergens generally responsible for this reaction are pollens, dust, fumes, insect products, or viral antigens.

Epinephrine helps in generalized reaction by relaxing the smooth muscles for respiration to restore and reducing vascular permeability so that blood pressure can normalize improving cardiac output. Antihistamines are used to relieve the symptoms of asthma and hay fever.

8. Though smallpox has been successfully eradicated, eradication of other diseases such as measles, tuberculosis, cholera and malaria has not been so successful. Success of smallpox vaccine was due mainly to the fact that pox virus did not mutate and the same vaccine could be used everywhere and the vaccine was highly effective. On the other hand, though measles vaccination has decreased death rates drastically, its total eradication has not been achieved so far due to several reasons. The disease is highly infectious, and spreads very fast. As long as it is present in one area, unvaccinated children in any country are at risk. For measles, boosters are required, difficult to achieve in poor countries, parents' decision not to vaccinate their children due to fear or other misconceived notions has also made the vaccination programme less effective.

Effective vaccine against cholera has not been available for two major reasons: (a) Immunity conferred by the vaccine is not long lasting; (b) Cholera is a toxin-mediated disease while protective immune mechanism is antibacterial rather than antitoxic. Oral cholera vaccines have become available recently.

Tuberculosis is a major killer, causing 2 to 3 million deaths annually. According to WHO reports, nearly one-third of the world's population is currently infected with TB. Today, the only approved tuberculosis vaccine is bacilli Calmette-Guerin (BCG) which was started in 1921. Though it is quite effective in infants and young children, in adults, its efficacy is variable. Many boosters are also

being developed, MVA85A, being the most advanced boost available. BCG vaccine has not been modified since 1921 and that may also be one reason why it is not so effective. That bacteria may have changed through evolution is suggested by their evolution of resistance to a number of known antibiotics. A lot of effort is being devoted, but proving difficult as the bacterium lives within the cells and lack of suitable animal model for developing and testing human tuberculosis vaccine is posing a big challenge. In Africa, coinfections of human immunodeficiency virus and TB have led to increases in the incidence rate of TB.

9. The word 'antibiotics' is derived from the Greek word "anti" meaning against and "bios" life. Antibiotics are a class of chemicals produced by bacteria or fungi in order to inhibit the growth of other organisms in their vicinity so that competition for limited resources can be minimized. The first antibiotic, penicillin, was discovered by Alexander Fleming in 1928. Since then antibiotics have found great use in medicine. Though they are not effective against viruses, they are used to treat a number of bacterial infections.

A large number of antibiotics have been discovered from a variety of organisms, broadly belonging to two categories: bactericidal, which kill the bacteria and bacteriostatic, which slow down their growth and reproduction. Bactericidal antibiotics prevent the formation of cell wall while bacteriostatic antibiotics interfere with some aspect of bacterial metabolism, affecting either protein or RNA synthesis or DNA replication. They must work together with the immune system to remove microorganisms from the body. High concentrations may also be bactericidal. As the use of antibiotics has increased, it has also led to the evolution of resistance in a number of microbial pathogens with the result that earlier antibiotics are no longer effective in treating a disease. Resistance may have developed by a number of mechanisms e.g.,

- (a) Production of enzyme beta lactamase that breaks down beta-lactam ring of antibiotics such as penicillin and cephalosporin.
- (b) Mutation in a gene leading to the formation of an altered protein which does not bind penicillin.
- (c) Altered cell wall permeability confers resistance to tetracyclines, quinolones, penicillin.
- (d) Creating a barrier of biofilm, where bacteria are not attacked by the host's immune system as seen in Salmonella.
- (e) A gene can produce a product that can pump out the antibiotic as in Staphylococcus against erythromycin.
- (f) Some bacteria show alteration in ribosome structure so that protein synthesis is not affected.

10.

| S. No. | Humoral Immunity | S. No. | Cellular Immunity |
|--------|---|--------|---|
| 1. | Targets extra-cellular infectious agents in blood or tissue fluids | 1. | Targets Intra-cellular infectious agents and Cancer cells |
| 2. | Recognition of antigen by receptors on B-lymphocytes | 2. | Recognition of antigens-MHC by Tc lymphocytes and antibody-tagged cells by phagocytes and NK cells |
| 3. | Activation and proliferation of B-lymphocytes forming plasma cells and memory cells | 3. | Activation and proliferation of Tc lymphocytes forming CTL and memory cells Activation of Phagocytes and NK cells |
| 4. | Secretion of antibodies | 4. | Secretion of cyto-toxic chemicals |
| 5. | Clearance of infectious agent | 5. | Lysis of infected or cancerous cells |

11. As the use of antibiotics has increased, it has also led to the evolution of resistance in a number of microbial pathogens with the result that earlier antibiotics are no longer effective in treating a disease. Resistance may have developed by a number of mechanisms for example.

- (i) Production of enzyme beta lactamase that breaks down beta-lactam ring of antibiotics such as penicillin and cephalosporin.
- (ii) Mutation in a gene leading to the formation of an altered protein which does not bind penicillin.
- (iii) Altered cell wall permeability confers resistance to tetracyclines, quinolones, penicillin.
- (iv) Creating a barrier of biofilm, where bacteria are not attacked by the host's immune system as seen in Salmonella.
- (v) A gene can produce a product that can pump out the antibiotic as in Staphylococcus against erythromycin.
- (vi) Some bacteria show alteration in ribosome structure so that protein synthesis is not affected.

12. When an HIV infection occurs, measurable HIV antibodies are produced in response to antigens within a week or two of exposure.

The antibodies are generated in response to different viral antigens: the p24 antigen, which is generally the first to appear; and the gp120 and gp41 antigens, which are both found on the surface of the virus.

Once infected, the antibodies persist for life and provide the traditional target for HIV antibody tests (including commercially available in-home tests).

Fourth-generation combination tests are now capable of detecting both HIV antibodies and p24 antigen, providing speedier, more accurate confirmation of a person's HIV status.

Antibodies have the potential to block HIV-1 replication through multiple pathways, and they exert immune pressure on the virus that leads to escape. Neutralizing antibodies (NAbs) bind cell-free virus and prevent the virion from infecting the host target cells, thereby disrupting subsequent rounds of replication. HIV-1 specific antibodies can also complex with the Fc γ receptor to counter HIV-1 through effector cell mechanisms—a process that has the potential to contain cell–cell HIV-1 spread. It is not possible to predict which of these antibody mechanisms will be most effective in containing HIV-1 because the relative contribution of cell-free versus cell–cell spread in HIV-1 transmission and pathogenesis are not well defined. Thus, the ability of antibodies to block HIV-1 infection by each of these pathways is the topic of intense study.

15.13 ASSESSMENT METHODS

Use observation technique, question answer technique, and demonstration technique to assess the learners' achievement of learning objectives.

15.14 ASSESSMENTS

Formative Assessment

Fill in the blanks:

1. is chosen in cases of emergency or immunodeficiency.
2. class 1 allergy is mediated by

Ans. 1. Passive immunization, 2. IgE

Summative Assessment

Answer in one word:

1. Full form of IgG
2. Five types of antibodies

Ans. 1. Immunoglobins, 2. IgM, IgG, IgA, IgE and IgD

Unit 16: Human Reproductive System and Gametogenesis

16.1 LEARNING OBJECTIVES

| Knowledge and Understanding | Skills | Attitudes and Values |
|---|---|--|
| <ul style="list-style-type: none"> • Describe the structure of human male and female reproductive systems. • State where female and male gametes are produced. • Describe the histology of mammalian ovary and testis. • Outline gametogenesis in a male and a female human as a process involving mitosis, growth, meiosis and maturation. • Explain how spermatozoa are produced. • Explain how oocytes are produced. • Explain the significance of gametogenesis. | <ul style="list-style-type: none"> • Relate the histology of the testis and ovary to their functions. • Analyse and interpret chart diagrams of spermatogenesis and oogenesis. • Prepare slides well to study the structure of gametes. • Research about gametes and their formation and deduce their findings. | <ul style="list-style-type: none"> • Appreciate the significance of the process of gametogenesis at puberty as a key characteristic of sexual maturity. • Acknowledge the relevance of meiosis during gametogenesis as an essential tool in maintaining the diploid condition after fertilisation. |

16.2 TEACHING AIDS

Visual: Images of gamete formation.

Audio-video: Video showing process of gametogenesis.

16.3 TEACHER'S TIP

Start the unit by briefing the learners by stating the different types of gametes. Tell them how reproduction is an essential asset for passing generation. Reproduction in humans involves two gametes and their fusion. State the role of mitosis and meiosis

while learning reproduction. State the process of gametogenesis for production of gametes. Spermatogenesis occurs in males produces male gametes and oogenesis occurs in females produces females gametes.

16.4 TEACHING METHODS

Brainstorming, short lecture technique, group discussion technique, observation technique, drawing technique, demonstration technique, field visit, site visit and practical work.

16.5 TEACHING AND LEARNING MATERIALS

Illustrations and computer aided study materials, prepared slides of testis and ovarian tissue, sperm and egg, microscopes, and small mammals (rat/rabbit/guinea pig).

16.6 TEACHING METHODOLOGY

Teacher initiates the topic by introducing importance of reproduction and showing photographs of reproductive organs. Ask them to identify organs.

Learners reply to the teacher.

Appreciating them, further ask if they are aware of hormones and glands in male and female reproduction.

Learners will come up with varied answers. Some correct, some near to correct, others being irrelevant.

Teacher will not demotivate the child. But agreeing to the correct answers, move further in discussion.

Teacher will explain about gametogenesis.

Using short lecture technique, teacher will explain about gamete formation in males and females.

16.7 ADDITIONAL CONTENT FOR THE TEACHER

- **Aristotle (384–322 BC):** Studied the embryonic development of the chick and of many other animals. He is regarded as the ‘Father (Founder) of Embryology.’
- **Amniocentesis:** A technique of drawing amniotic fluid and testing it to find out the disorders and sex of the foetus.
- **Circumcision:** A religious rite in Muslims and Jews, in which a part or all of the prepuce is cut-off.
- **Cryptorchidism:** A condition in which testes are unable to descend in scrotal sacs.

- **Ectopic Pregnancy:** Impregnation of ovum outside the uterus (in fallopian tube, cervix, ovary).
- **Leeuwenhock (1632–1723):** Discovered human spermatozoa in 1675 in the semen with self-designed microscope.
- The cavity of uterus can expand 500 times during pregnancy, from 10 cm³ to 5,000 cm³.
- **Twins:** (i) **Fraternal Twins (Dizygotic or Nonidentical Twins).** Two offspring that have developed in the uterus at the same time but are the result of independent fertilization of two ova. (ii) **Monozygotic Twins (Identical Twins).** Two offspring developed from a single fertilized ovum. At an early stage, the zygote (fertilised ovum) separates into two independent cells that develop into offspring of the same sex with identical characteristics. (iii) **Siamese Twins (united Twins).** Named after Chang and Eng born in Siam (Thailand). Their parents were Chinese. Siamese twins were joined in a small area. Now modern surgical techniques have made it possible to separate infants.
- **Free Martin:** A sexually undeveloped female calf twined with a male.
- **Foetus:** It is the unborn young one of a viviparous animal after it has taken form in the uterus. In human beings, it represents the product of conception from the end of the eighth week to the moment of birth.

Types of Placenta

1. On the basis of foetal membranes involved:

- (i) **Yolk sac placenta:** Develops from yolk sac and chorion, e.g., metatherian mammals (Kangaroo, Opossum).
- (ii) **Chorio-allantoic placenta:** Derived from allantois and chorion, e.g., most eutherian mammals.
- (iii) **Chorionic placenta:** Formed from chorion, e.g., human beings.

2. On the basis of Histology. Six tissue barriers in placenta are (a) Endothelium of foetal blood vessels (b) Foetal connective tissue (c) Trophoblast (d) Uterine epithelium (e) Uterine connective tissue and (f) Endothelium of maternal blood vessels. There are five histological types of placenta found in animals:

- (i) **Epitheliochorial placenta:** All the six tissue barriers (layers) of the placenta are present.
- (ii) **Syndesmochorial placenta:** Uterine epithelium is absent; with five placental barriers e.g., cow, goat, buffalo, camel and giraffe.
- (iii) **Endotheliochorial placenta:** Uterine epithelium and uterine connective tissue are absent; with four placental barriers e.g., dog, cat, lion, tiger, bear and mangoos.

- (iv) **Haemochorial placenta:** All the three uterine tissue barriers (uterine epithelium, uterine connective tissue and endothelium of maternal blood vessels) are absent; with three placental barriers, e.g., lemur, apes and men.
- (v) **Haemoendothelial placenta:** All the three uterine tissue barriers and two foetal tissue barriers (foetal connective tissue and trophoblast) are absent; only one placental barrier e.g., rat, rabbit and guinea pig.

Activity

The teacher can demonstrate this activity in the class.

Aim: To make the learners aware of vaccination.

Refer to text and ask the learners to write different hormones and glands used during reproduction and state their functions.

Ask each learner to read it aloud and share with the class.

16.8 SUMMARY

- Human male reproductive system carries out the functions of spermatogenesis i.e., formation of functionally active, motile sperms along with seminal plasma.
- The system comprises male sex organs i.e., testes (paired organ) and scrotum, a series of ducts that help in transportation and maturation of spermatozoa and the accessory glands which secrete the essential components of semen plasma.
- The temperature of testes is maintained 2°C – 3°C below the core body temperature which provides favourable environment of spermatogenesis.
- The male reproductive ducts include vasa efferentia, vasa deferentia, epididymis, ejaculatory ducts and urethra primarily.
- The accessory glands of reproduction in human reproductive system are seminal vesicles, prostate gland, urethral (Littre's) glands and bulbourethral (Cowper's) glands.
- Human female reproductive system is designated to carry out the functions of ovulation, carry male and female gametes, fertilization, gestation and childbirth.
- Human female reproductive system consists of female sex organs-ovaries, duct system-oviducts or the uterine/fallopian tubes, uterus, cervix, vagina, the external genitalia – vulva and a pair of mammary glands.
- Ovaries produce female gametes-ova. They contain ovarian follicles at various stages of development. An ovarian follicle consists of ovum surrounded by granulosa cells and other layers for protection and nutrition.

- Oviducts transfer ovum from ovary to the uterus and serve as the site of fertilization. Each oviduct is divided into an infundibulum, ampulla, isthmus and uterine parts.
- Uterus is a hollow organ that serves as the site of implantation and nourishment of the embryo till birth. It consists of three parts – fundus, body and cervix. The inner lining is called endometrium.
- Cervix and vagina form the birth canal.
- External genitalia or vulva consists of mons pubis, clitoris, labia majora, labia minora and perineum.
- Glands include lesser vestibular and greater vestibular glands and a pair of mammary glands. Mammary glands function in the production of milk for the young one.
- Menstrual cycle consists of three phases: menstrual, proliferative and secretory in the uterus, corresponding to follicular, ovulation and luteal phases of ovarian cycle.
- The onset of menstrual cycle at puberty is termed menarche and end is called menopause.
- The menstrual cycle is governed by hormones.
- The process of formation of haploid male gametes or spermatozoa from diploid reproductive cells in males is called spermatogenesis.
- The complete process of spermatogenesis is broadly divided into two parts: (i) Formation of spermatids and (ii) Spermiogenesis or spermatoleosis.
- Spermatid formation is further divided into three phases as multiplication, growth and maturation phase.
- Spermiogenesis is the process of series of changes to transform a non-motile spermatid into motile, functional spermatozoa.
- Oogenesis is the formation of haploid ovum from diploid undifferentiated germ cells in the ovary.
- Oogenesis is completed in three phases of discontinuous steps.
- Proliferative or multiplication phase involves proliferation of oogonial cells by mitosis.
- Growth phase is all about growth and differentiation of primary oocyte and development of mature ovarian follicle.
- Maturation phase provides time for the oocyte to undergo two meiotic divisions to produce functional haploid ovum.

16.9 WEBLINKS FOR CONTENT ENRICHMENT

- https://en.wikipedia.org/wiki/Sexual_reproduction
- <http://www.reproduction-online.org/>

16.10 LEARNERS' ACTIVITIES

Activity 1

Teacher will guide the learners to look into books and internet and revise the knowledge of reproduction.

Activity 2

The teacher should guide the learners to perform the activity.

Hint:

In male rat: cut through the scrotum carefully to reveal the testis and also observe other internal structures viz. Epididymis, vas deferens, seminal vesicles, prostate gland and seminiferous tubules.

In female rat: locate the urethral and vaginal openings on the ventro-posterior side of the body, under the tail, just posterior to the last pair of teats. Also observe other reproductive organs i.e. Uterus, Ovaries, Oviducts and Vagina.

Activity 3

The teacher should assist the learners in identifying and labelling the following activity.

Hint:

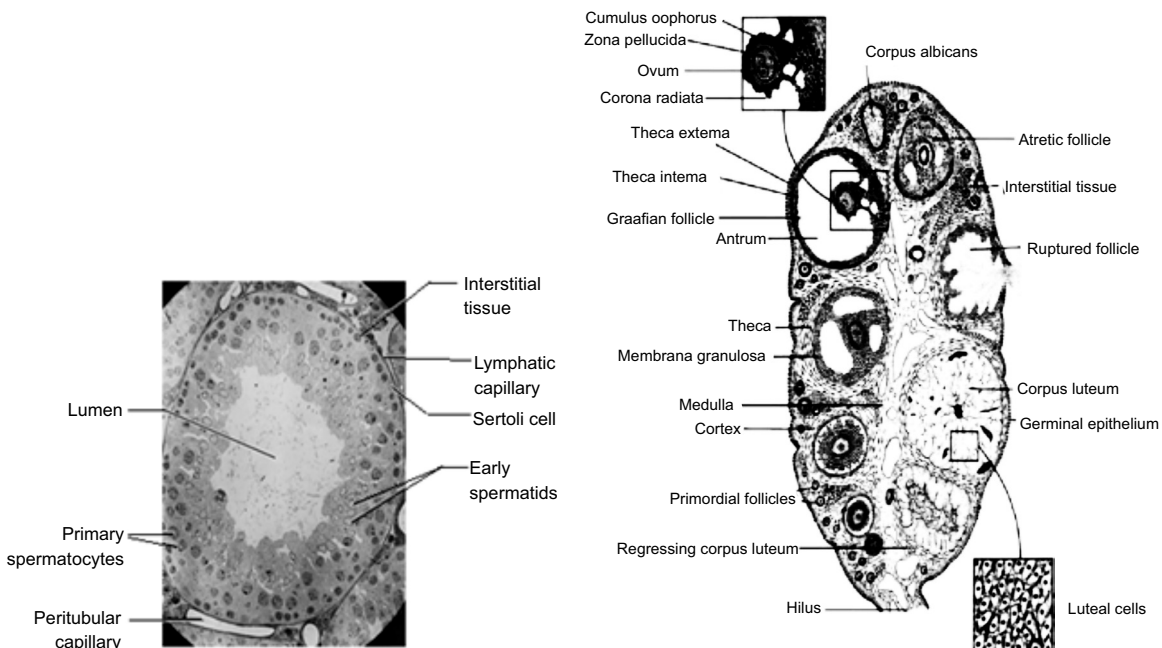

Activity 4

The teacher should make the learners able by introducing the topic in the class.

Hint: study, and using diagrams, compute the number of chromosomes.

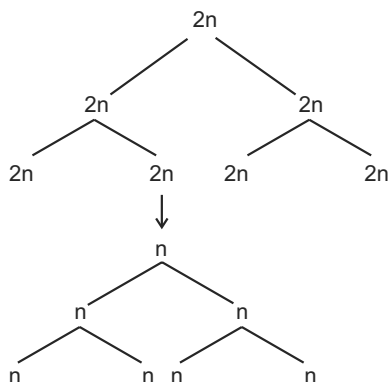

Activity 5

The teacher should guide the learners to perform the activity on their own.

Hint:

| Differences between Spermatogenesis and Oogenesis | | | |
|---|---|---------------|--|
| S. No. | Spermatogenesis | S. No. | Oogenesis |
| 1. | It occurs in the testis | 1. | It occurs in the ovaries |
| 2. | The whole process is completed in the testes so that mature spermatozoa are released from the testes. | 2. | The process gets completed in the oviduct i.e. oocytes at metaphase-II stage are released from the ovaries |
| 3. | Equal meiotic divisions occur | 3. | Unequal meiotic divisions occur |
| 4. | No polar body is formed | 4. | Polar bodies are formed at each meiotic division |
| 5. | One spermatogonium produces four functional spermatozoa | 5. | One oogonium produces only one functional ovum |
| 6. | A primary spermatocyte undergoes first meiotic division to produce two secondary spermatocytes | 6. | A primary oocyte undergoes first meiotic division to produce one secondary oocyte and one polar body |
| 7. | A secondary spermatocyte further divides by meiosis-II to produce two spermatids | 7. | A secondary oocyte undergoes meiosis-II to produce one ootid and one polar body |
| Similarities between Spermatogenesis and Oogenesis | | | |
| 1. Both the processes start with diploid cells and result in formation of haploid gametes. | | | |
| 2. Both the processes are completed in three phases i.e. multiplication phase, growth phase and maturation phase. | | | |

Activity 6

The teacher should guide the learners to perform the following activity on their own

Hint:

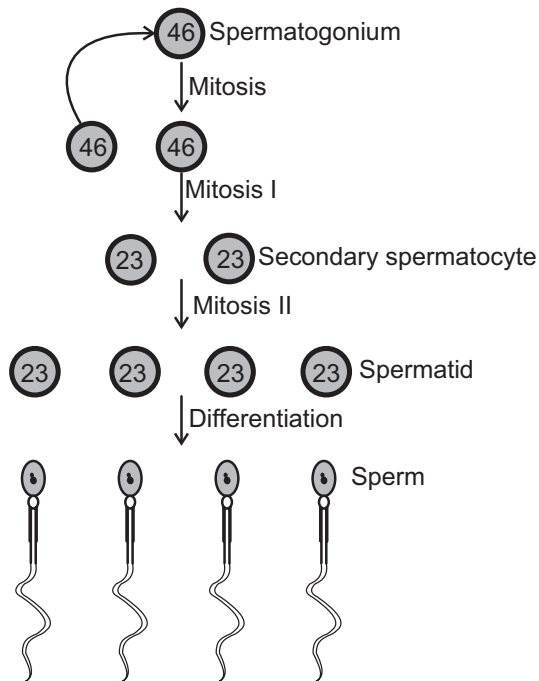

16.11 ANSWERS TO SELF-EVALUATION

Self-evaluation

- (i) scrotum, testes
- (ii) sertoli cells
- (iii) Vasa efferentia, vasa deferens
- (iv) Seminal vesicles

Self-evaluation

- (i) oxytocin
- (ii) mesovarium, suspensory ligament, uteroovarian ligament
- (iii) estrogen, progesterone and relaxin
- (iv) Mammary ampulla

Self-evaluation

- (i) proliferation, growth and differentiation, and maturation
- (ii) sperm, ovum
- (iii) Sertoli
- (iv) Graafian follicle

16.12 ANSWERS TO END UNIT ASSESSMENT 16

I. Choose whether the following statements are True or False:

1. **False;** Germinal vesicle is the nucleus of the ovum.
2. **True;** Urethral gland is also called as glands of Littre on the name of Alexis Littre.
3. **False;** Proliferation phase involves only mitotic divisions of germ cells/ oogonia.
4. **True.**
5. **False;** Testosterone is synthesized from Leydig or interstitial cells.

II. Fill in the blanks:

1. Bulbo-urethral gland
2. Scrotum or Scrotal sac
3. Relaxin
4. fallopian tube/ oviduct
5. progesterone
6. menarche
7. gubernaculum
8. testosterone

III. Long answer type questions:

1. The process of oogenesis occurs in the ovaries. The three phases of proliferation, growth and maturation occur in discontinuous steps.
 - (a) **Proliferative or Multiplication phase:** During early foetal development, certain cells within the germinal epithelium of the ovary become enlarged. These cells proliferate by mitosis, producing undifferentiated germ cells called eggmothercells or oogonia ($2n$). The oogonia divide mitotically to produce groups of oogonia, termed follicles. About two million oogonia are formed within each foetal ovary; no more oogonia are added after birth.

- (b) **Growth and differentiation phase:** During this long phase, which may last upto years, one cell in a follicle prepares for the formation of ovum. It starts meiotic division but gets arrested at prophase-I stage and is called primary oocyte. The remaining cells of the follicle lose the potential to become primary oocyte and are known as the follicular cells or granulosa cells. These follicular cells serve to protect and nourish the primary oocyte. The complete follicle with a primary oocyte surrounded by a layer of follicular cells is called the primary or the ovarian follicle

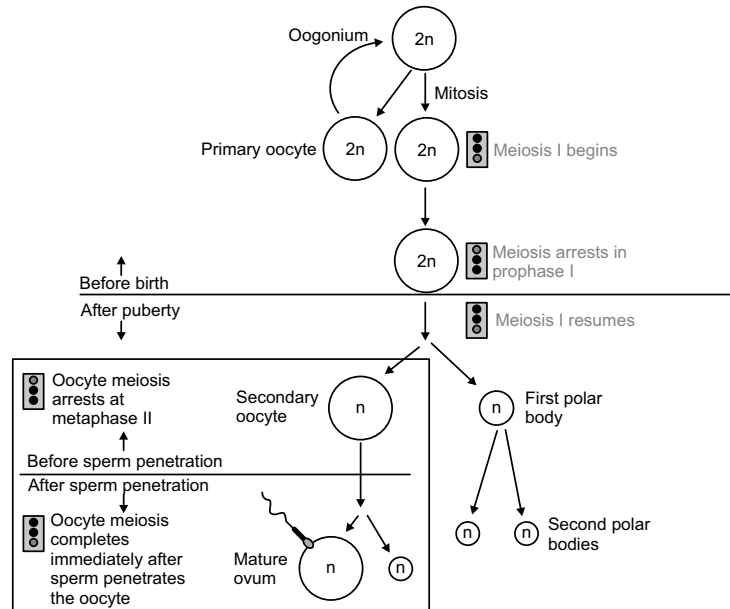

Schematic representation of oogenesis

- (c) **Maturation phase:** At puberty, only one of the primary oocytes resumes division per menstrual cycle, alternately in each ovary. The tertiary follicle matures into a Graafian follicle, within which the primary oocyte divides to form two very unequal cells – a large secondary oocyte (n) and a very small 1st polar body or polocyte (n). The 1st polar body may further be divided into two polar bodies. However, the secondary oocyte again gets arrested at metaphase stage of meiosis-II and is released from the ovary during ovulation. It waits in the oviduct for the sperm to arrive. If fertilization occurs, sperm entry into the secondary oocyte marks the resumption of meiosis. The 2nd maturation division (meiosis-II) again divides the secondary oocyte into two unequal daughter cells – a large ootid and a very small 2nd polar body. The ootid undergoes maturation into

a functional haploid ovum. A thin vitelline membrane develops outside the plasma membrane of the ovum that protects and nourishes the latter.

Thus, from one oogonium (egg mother cell), one ovum and three polar bodies are formed. The ovum is the functional female gamete while the polar bodies take no part in reproduction and soon degenerate. The formation of polar bodies only helps the egg to get rid of one set of chromosomes and still enables the ovum to retain most of the cytoplasm and food for the future embryo. In case fertilization does not occur, the secondary oocyte undergoes degeneration and is driven out of the body.

2.

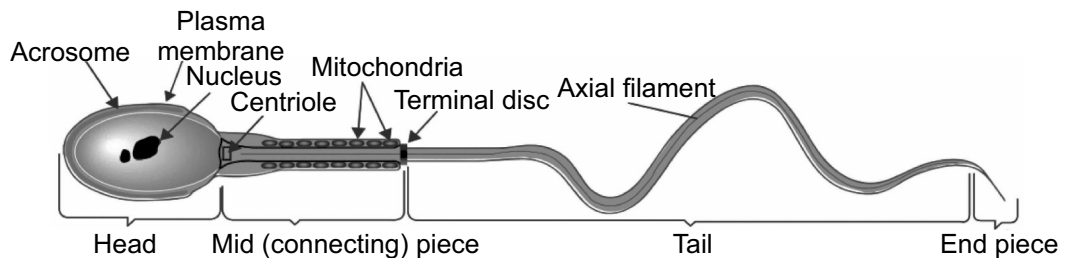

3. The male reproductive accessory glands in human are:

- (i) **Seminal Vesicles:** The secretion of the seminal vesicle contains fructose and prostaglandins. Fructose provides energy to the sperm and prostaglandins aids to the movement of sperm toward the egg by stimulating muscular contractions within the female reproductive organs. The other constituents of seminal vesicles' secretion include potassium, bicarbonate, acid-soluble phosphate and proteins.
- (ii) **Prostate Gland:** Prostatic secretion is composed of citric acid and acid phosphatase mainly. Citric acid is used for production of ATP through Krebs' cycle. Besides these two components, several proteolytic enzymes, fibrinolysin, hyaluronidase, prostate-specific antigen pepsinogen, lysozyme are also present in prostate secretion.
- (iii) **Urethral or Littre's glands:** Their secretion is clear, watery, and rich in mucoproteins. It constitutes primarily the pre-sperm fraction which is emitted prior to the spermatozoa at the time of ejaculation.
- (iv) **Bulbo-urethral or Cowper's gland:** The secretion provides mucous and viscous fluid that helps in lubrication of penis and lining of urethra. It provides alkaline environment that protects the passing spermatozoa by neutralizing acids from urine in the urethra. It also contains sialic acid, galactose, galactosamine, galacturonic acid and a methyl pentose.

4. The testes are surrounded by serous sheath called as tunica vaginalis, anteriorly and laterally. Behind tunica vaginalis is present a thick, white, fibrous capsule called as tunica albuginea. Interior to it lies the tunica vasculosa, which is rich in vascular supply. Posteriorly, the tunica albuginea thickens greatly and is projected into the interior of the testis as the Corpus Highmori or mediastinum testis. The testes are held in position by mesenteries called as mesorchium.

The ducts, blood & lymphatic vessels and nerves enter or leave the testis through the mediastinum. The connective tissue septa, called as septula testis (singular-septum of testis) radiate from mediastinum into the testis. These septulae subdivide the interior of the testis into a number of pyramidal lobules called as the testicular lobules. Each testicular lobule further contains several sperm producing convoluted tubules known as the seminiferous tubules (semin = seed; fer = to carry). The seminiferous tubules contain specialized epithelial cells, the spermatogenic cells and the supporting cells, also known as the sertoli cells. Sertoli cells provide support and nourishment, help in cell to cell communication, secrete inhibin and androgen binding protein etc. These are surrounded and supported by intertubular connective tissue which is rich in blood vessels and groups of epithelial cells, known as the Leydig cells (also called as the interstitial cells or interstitial endocrinocytes). The leydig cells produce androgen and the male sex hormone, testosterone.

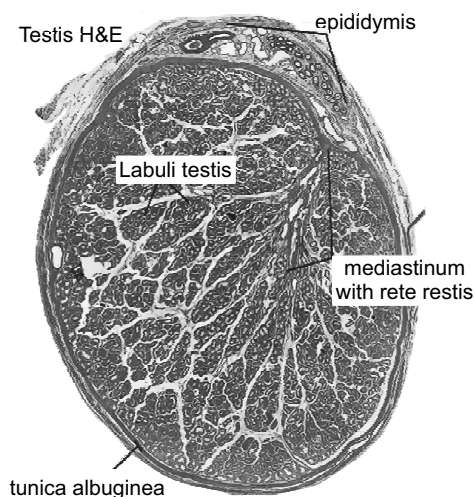

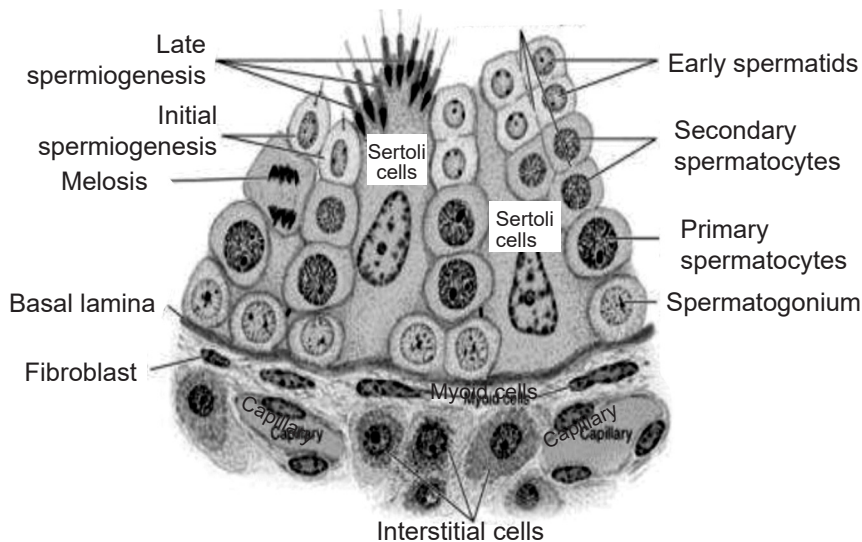
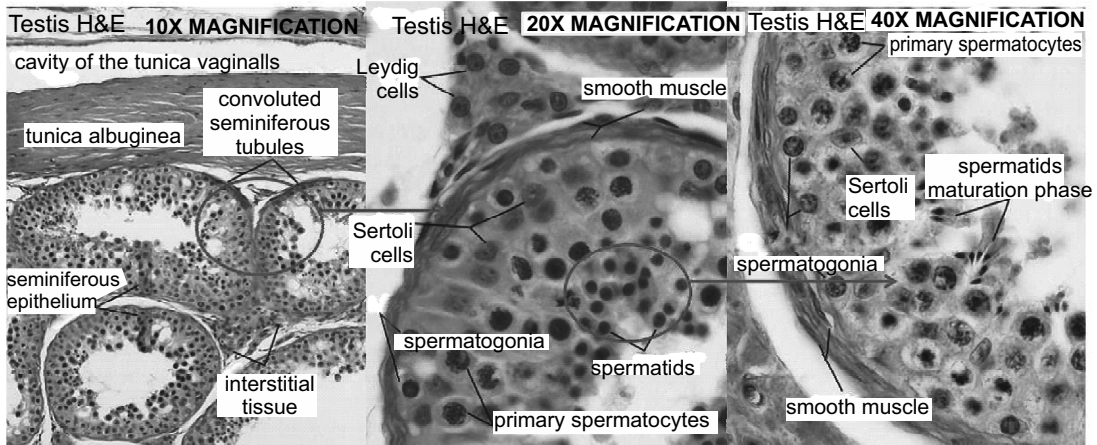

5. The human female reproductive system consists of the primary sex organs or the gonads (ovaries), the genital ducts (oviducts or the uterine/fallopian tubes, uterus, cervix and vagina) and the external genitalia, along with a pair of mammary glands.

Ovaries (singular: Ovary, Latin: Ovarium, literally meaning 'egg' or 'nut')—the primary sex organs in females are egg-shaped, paired structures, located in the upper pelvic cavity, one on either side of the uterus in front of the ureter, embedded in the connective tissue matrix called ovarian fossa. A single ovary is about 2 to 4 cm long, 2 cm wide and 1.5 cm thick and weighs about 15 grams.

Female Reproductive Ducts

Oviducts/uterine ducts/fallopian ducts: function to transfer the ovum from the ovary to the uterus and serve as the site of fertilization of the male and female gametes. Each oviduct, 10 – 12 cm long, can be divided into four continuous regions as

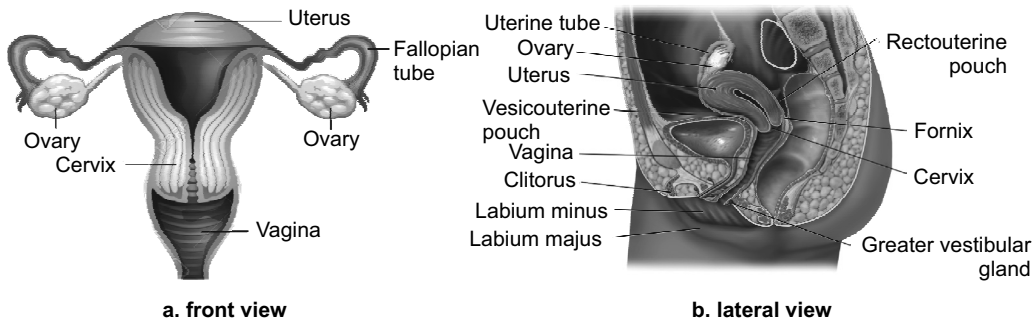

An overview of human female reproductive system

- **Infundibulum:** Closest to the ovary, opens into the peritoneal cavity, serve to receive the ovum released by the ovary during ovulation.
- **Ampulla:** The widest and major part of the tube, the site of fertilization
- **Isthmus:** The narrower part, that links to the uterine wall
- **Interstitial** or the intramural or the uterine part – that lies within the uterine wall

Uterus: Also known as hystera or metra or womb is an ‘inverted pear’-shaped, muscular, hollow (uterine cavity lies within), hormone-responsive organ that serves to house, nourish and protect the growing foetus till birth. Anatomically, the uterus consists of three parts:

- **Fundus:** The dome shaped part above the openings of the uterine parts of the fallopian tubes
- **Corpus uteri or the ‘body’:** The main centrally expanded portion cervix–the inferior narrow portion that opens into the vagina

Cervix: It is the narrow cartilaginous terminal part of the uterus that joins the anterior wall of vagina. A narrow, constricted region, about 1 cm long called isthmus joins the uterus with the cervix. The cervical canal or the cavity of the cervix communicates with the uterus internally by an aperture called internal os and with the vagina by external os. Cervix and vagina together form the birth canal; during childbirth, it dilates widely to allow the baby to pass through.

Vagina: It is a distensible, muscular tube, about 10 cm long, which extends from vulva (external genitalia) to the uterus. The vaginal opening on the vulva is termed the vaginal orifice. The orifice is partially covered by a membrane called hymen that ruptures during the first act of intercourse. However, it may get ripped off during some strenuous activities like sports, disease, injury, sudden fall or jolt, insertion of vaginal tampon, masturbation or a medical examination.

Vagina serves as a receptacle for the male copulatory organ during sexual intercourse, provides a passageway for the menstrual flow and forms part of the birth canal during childbirth.

External Genitalia

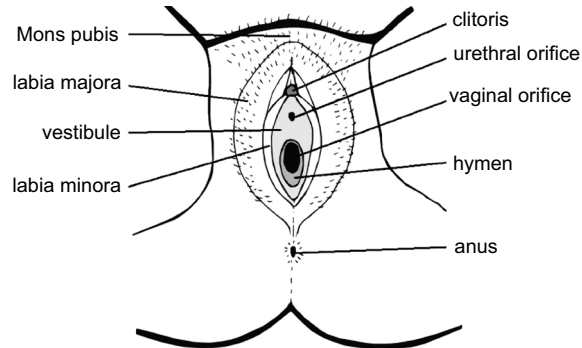

The external genitalia in human female

Clitoris is considered homologous to penis of males, though it is much reduced in size and has no passage inside. It is hooded by another fold of skin called the prepuce of clitoris homologous to glans penis. The clitoris is richly innervated with sensory nerve endings, and is sensitive to touch contributing to a female's sexual arousal.

6. A typical human ovary is composed of connective tissue called stroma, wrapped by a layer of cuboidal cells called germinal epithelium. Germinal epithelium is further covered by a layer of flattened cells called tunica albuginea. The stroma is divided into two zones: an outer dense cortex and a less dense inner medulla. The medulla consists of loose connective tissue, blood vessels, lymphatics, smooth muscle fibres and nerves. The cortex consists of rounded structures called ovarian or the Graafian follicles, at various stages of development. Each follicle consists of a large ovum surrounded by several layers of follicular or granulosa cells.

A fully grown ovarian or the Graafian follicle typically consists of:

- An oocyte (15-30 μm wide) with a nucleus called the germinal vesicle, bounded by vitelline membrane which is further surrounded by zona pellucida.
- Surrounding the zona pellucida is present membrane granulosa, consisting of granulosa cells or the follicular cells. The granulosa cells lying in close vicinity of the oocyte may become elongated to form the corona radiata.

- Membrana granulosa is further covered on the outside by theca interna and theca externa.
- A cavity called follicular antrum/cavity filled with a fluid, the liquor folliculi.
- The oocyte anchors to the wall of the follicle by a thin layer of follicle cells called cumulus ophorus, which nourishes the oocyte.

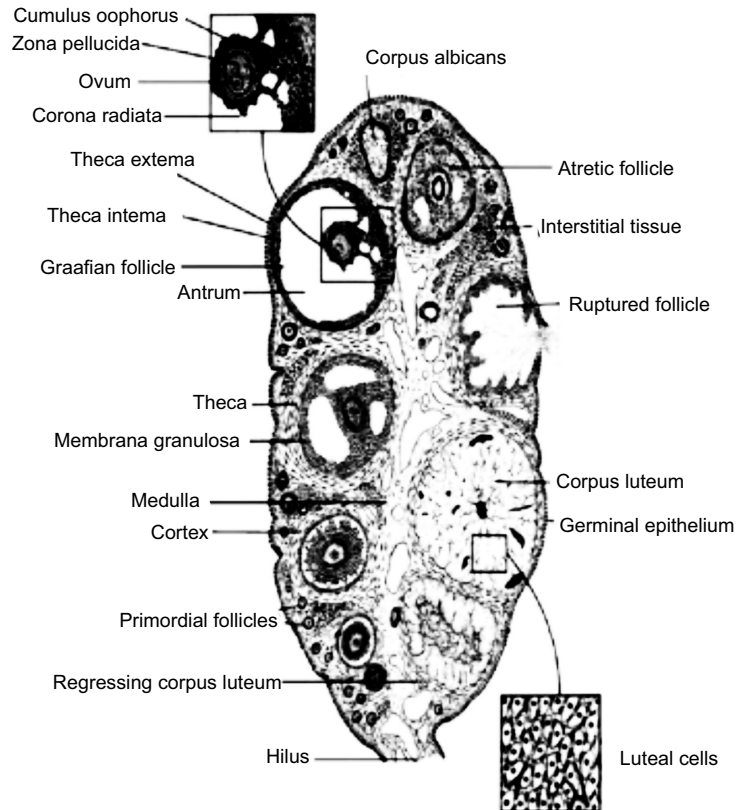

Diagrammatic view of the cross section of a human Ovary. Ovarian follicles can be seen at various stages of development.

7. Corpus luteum (Latin means “yellow body”; plural: corpora lutea) is a temporary endocrine structure that develops from degenerating cells of the ovarian follicle after the release of ovum, under the influence of LH. It produces large amounts of progesterone.

The Luteinizing hormone (LH) secreted by the anterior lobe of pituitary stimulates the development of corpus luteum from degenerating cells of the ovarian follicle after ovulation. Corpus luteum secretes large amounts of progesterone and some estrogen.

If the oocyte is fertilized, the corpus luteum continues to proliferate and increases hormone production. By the end of the third month of pregnancy, luteal cells occupy a large part of the ovary and keep releasing progesterone. However, by the end of the fourth month, they regress slowly.

If the oocyte is not fertilized, the corpus luteum degenerates in 10–12 days after ovulation. It is visible only in the form of a white scar, the corpus albicans, on the outside of the ovary.

8. Gametes are the reproductive cells used during sexual reproduction to produce a new organism called a zygote. The gametes in males and females are different. The male gamete is called sperm. The female gamete is called an egg or ova. The eggs or ova are produced in the ovaries. The sperms are produced in the testes.
9. Significance of gametogenesis Spermatogenesis and oogenesis are both forms of gametogenesis, in which a diploid gamete cell produces haploid sperm and egg cells, respectively.

The process of formation of sperms is called spermatogenesis. It occurs in the semi-niferous tubules of the testes.

The process of formation of a mature female gamete (ovum) is called oogenesis. It occurs in the ovaries (female gonads).

Significance of Spermatogenesis:

- During spermatogenesis, one spermatogonium produces four sperms.
- Sperms have half the number of chromosomes. After fertilization, the diploid chromosome number is restored in the zygote. It maintains the chromosome number of the species.
- During meiosis I crossing over takes place which brings about variation.
- Spermatogenesis occurs in various organisms. Thus, it supports the evidence of the basic relationship of the organisms.

Significance of Oogenesis:

- One oogonium produces one ovum and three polar bodies.
- Polar bodies have small amount of cytoplasm. It helps to retain sufficient amount of cytoplasm in the ovum which is essential for the development of early embryo. Formation of polar bodies maintains half number of chromosomes in the ovum.
- During meiosis first crossing over takes place which brings about variation.
- Oogenesis occurs in various organisms. Therefore, it supports the evidence of basic relationship of the organisms.

10. (i) Human spermatozoa
(ii) (1) Plasma membrane (2) Acrosome (3) Nucleus (4) Head (5) Neck (6) Middle piece (7) Mitochondria (8) Tail.
(iii) (7) Provide energy for swimming (8) Help in swimming
(iv) Sperm lysins
(v) Helps in the penetration of sperm into the ovum.
11. Reproduction is a natural process. Still, people take reckless measures to ensure it's a son! To begin with, they use unsafe methods of abortion to get around the anti-abortion laws of Pakistan, after they figure out it's a girl in the womb. If a mother's child comes in danger with it, so be it! A girl should not be allowed in this world.

Technically speaking, it takes an X and Y (XY) to make the revered sex-male. And while the X factor, women (XX) have only X chromosomes to contribute in any case, it's the man (XY) whose contribution or non-contribution of Y chromosome that can end up to make a baby girl or a baby boy. Which chromosome combines with which one, it's God's work, who's planned for all lives to come in this world, if we really are desperate to play the blame game here and express our anger on someone, then it has got to be the man.

The repercussions of the genocide moved civil society organizations (CSOs) and NGOs to emerge which aimed at helping to address social needs.

Save the Children

Save the Children has been in Rwanda for many years and is most known for helping to trace parents or relatives of children who had been separated from their families during the genocide. Save the Children is mainly working in Burera, Gicumbi, Ruhango and Rubavu.

World Concern International

World Concern is dedicated to tackling poverty and suffering in the world's poorest countries. Here in Rwanda, it works in the following sectors: health, HIV and AIDS, livelihoods, and primary education which are implemented in Gakenke, Huye, Nyaruguru and Gisagara.

10,000 women programme

10,000 Women is a five-year initiative that provides business and management education to underserved female entrepreneurs in developing and emerging markets. This programme is designed to drive greater shared economic growth which will eventually lead to stronger healthcare, education as well as greater

prosperity in the communities where it operates. Rwanda is one country that is benefiting from this programme.

16.13 ASSESSMENT METHODS

Use observation technique, question answer technique, and demonstration technique to assess the learners' achievement of learning objectives.

16.14 ASSESSMENTS

Formative Assessment

Fill in the blanks:

1. Surgical removal of testis is called
2. is the bilateral ligation of vas deferens as a contraceptive.

Ans. 1. Castration, 2. Vasectomy

Summative Assessment

Answer in one word:

1. Presence of more than the normal number of breasts.
2. Failure to achieve and/ or maintain the erection for coitus.

Ans. 1. Hypermastia, 2. Impotence

Unit 17: Genetics

17.1 LEARNING OBJECTIVES

| Knowledge and Understanding | Skills | Attitudes and Values |
|---|--|---|
| <ul style="list-style-type: none"> • Explain the terms gene, locus, allele, dominant, recessive, co-dominant, linkage, test cross, F1 and F2, phenotype, genotype, homozygous and heterozygous. • Explain how to conduct a test cross. • Explain why monohybrid ratios of 1:2:1 occur. • Describe an example of inheritance involving multiple alleles. • Explain the effect of lethal genes on phenotype ratios. • Give a genetic explanation of Mendelian dihybrid inheritance. • Explain the use of test crosses to determine unknown genotypes in studies of dihybrid inheritance. • Explain the significance of recombination. | <ul style="list-style-type: none"> • Analyse various patterns of inheritance. • Use genetic diagrams to solve problems involving monohybrid and dihybrid crosses, including those involving autosomal linkage, sex linkage, and codominance, multiple alleles and gene interactions. (The term epistasis does not need to be used: knowledge of the expected ratio for various types of epistasis is not required. The focus is on problem solving). • Use the complete and accurate format to show a genetic cross and the results of a simple monohybrid cross. • Use genetic diagrams to solve problems involving test crosses. • Use the chi-squared test to test the significance of the differences between observed and expected | <ul style="list-style-type: none"> • Appreciate the roles of genes in determining the phenotype and patterns of inheritance. |

| | | |
|--|---|--|
| <ul style="list-style-type: none"> • Explain how sex is determined in humans and the role of sex related Y genes in determining sex. • Describe how non-disjunction can affect the distribution of sex chromosomes in gametes and offspring. • Explain why linked genes do not show independent assortment. • Explain how crossover values can be used to make a chromosome map. | <p>results (the formula for the chi-squared test will be provided.). (See mathematical requirements)</p> <ul style="list-style-type: none"> • Demonstrate monohybrid and dihybrid inheritance. • Interpret Pedigree charts. | |
|--|---|--|

17.2 TEACHING AIDS

Visual: Images of crosses.

Audio-video: Video showing process Mendelian cross.

17.3 TEACHER'S TIP

Start the unit by briefing the learners by stating the learners about genetics. Introducing the vocabulary words and making them understand. Stating importance of genetics and how and why Mendel is considered father of genetics. Practice crosses on charts, using illustrative tools to make study interesting and fun. Introducing genetic disorders and how pedigree affects people.

17.4 TEACHING METHODS

Brainstorming, short lecture technique, group discussion technique, observation technique, drawing technique, demonstration technique, field visit, site visit and practical work.

17.5 TEACHING AND LEARNING MATERIALS

Online resources, CDs, simulations, diagrams, charts, micrographs, pedigree charts, illustrations, different plant seeds (e.g., beans and peas), animals, and money coins.

17.6 TEACHING METHODOLOGY

Teacher initiates the topic by introducing the mendelian experiments and crosses. Asking them to state genotypes and phenotypes of different crosses.

Learners reply to the teacher.

Appreciating them, further ask if they are aware of co-dominance, multiple alleles and lethal alleles.

Learners will come up with varied answers. Some correct, some near to correct, others being irrelevant.

Teacher will not demotivate the child. But agreeing to the correct answers, move further in discussion.

Teacher will explain them further the linkage and crossing over.

Using short lecture technique, teacher will explain the different genetic diseases.

The teacher also tells about pedigree.

17.7 ADDITIONAL CONTENT FOR THE TEACHER

Chromosome Theory of Inheritance

Chromosomal theory of inheritance was expanded by Morgan, Sturtevant and Bridges. The salient features of chromosome theory of inheritance are as follows:

1. The male and female gametes (sperm and ovum) act as bridge between one generation and the next. The two must carry all the hereditary characters.
2. Both the sperm and egg contribute equally in the heredity of the offspring. The sperm provides only nuclear part to the egg during fertilization. As such hereditary characters are governed by nuclear materials.
3. Nucleus contains chromosomes. Therefore, chromosomes must carry the hereditary traits.
4. Every chromosome or chromosome pair has a definite role in the development of an individual.

Loss of a complete or part of the chromosome produces structural and functional deficiency in the organism.

5. Like the hereditary traits the chromosomes retain their number, structure and individuality throughout the life of an organism and from generation to generation. The two neither get lost nor mixed up. They behave as units.
6. Both chromosomes as well as genes occur in pairs in the somatic or diploid cells.

7. A gamete contains only one chromosome of a type and only one of the two alleles of a trait.
8. The paired condition of both chromosome as well as Mendelian factors is restored during fertilization.
9. Genetic homogeneity and heterogeneity, dominance and recessiveness can be suggested by chromosomal type and behaviour.
10. Homologous chromosomes synapse during meiosis and then separate or segregate independently into different cells which establishes the quantitative basis for segregation and independent assortment of hereditary factors.
11. In many organisms, sex of an individual is determined by specific chromosomes called sex chromosomes.

Activity

The teacher can demonstrate this activity in the class.

Aim: To make the learners aware of crosses.

Refer to text and ask the learners to perform different crosses. Ask them to paste on chart papers and explain them.

17.8 SUMMARY

- Inheritance/heredity is the phenomenon of transmission of traits from parents to offspring.
- Mendel conducted breeding experiments in garden pea to study inheritance pattern of several traits. He found that first generation progeny always exhibited one of the parental traits (dominant) while second generation progeny exhibited both the forms of trait dominant and recessive in 3 : 1 ratio, popularly known as phenotypic monohybrid ratio. He postulated that there are two factors for each trait, the factors segregate (principle of segregation) at the time of gamete formation and reunite in zygote.
- Mendel's factors are now known as gene, two alternate forms are known as alleles. Mendel also devised the test cross which helps us differentiate pure dominant form from the hybrid dominant form. Chi-square test is used to analyze genetic data when observed data has deviation from expected value. We can find out whether there is significant deviation from expected value or not.
- Mendel carried out dihybrid cross where parent plants differ in contrasting form of two traits. He found that F₁ plants exhibited dominant form of both traits and F₂ plants exhibited four types of phenotypes (two parental types and two new

recombinants) in the dihybrid ratio of 9 : 3 : 3 : 1. He concluded that the factors of different traits segregate and assort independently in the gametes (principle of independent assortment). Mendel's factors or genes are found to be located on chromosomes.

- In population, there can be more than two alleles (multiple allele), although a particular individual will have two alleles. Sometimes both the alleles are equally expressed (co-dominance) as in ABO blood type. There can be incomplete dominance where one form is not completely dominant. Also, sometimes allele is lethal which leads to the death of the individual. Also, one gene may influence the expression of another gene. It leads to variation in Mendelian ratio.
- The genes located on the same chromosomes, inherit together the phenomenon is called as linkage. The genes located on the same chromosome occasionally assort independently via the physical phenomenon known as crossing over. The frequency of crossing over increases as distance between gene loci on the chromosome increases, so frequency of recombinant will vary. It also helps in finding distance between gene loci (chromosome map).
- Sex determination in humans is determined by the presence of Y chromosome. The "Y" chromosome plays an important role in determining maleness. It has gene testis determining factor (TDF) which initiates the sequence of events required to differentiate primordial gonadal tissue into testis.
- The genes located on sex chromosome (X and Y chromosome), demonstrates sex linkage. The inheritance of such traits depends on the sex of the individual.
- The genetic diseases may happen due to changes in genes or chromosomes on which genes are located. The inheritance of genetic disease caused by genes can be traced by pedigree analysis which involves collection of information about the expression of particular genetic trait in the family's history.

17.9 WEBLINKS FOR CONTENT ENRICHMENT

- <https://www.ndsu.edu/pubweb/~mcclean/plsc431/mendel/mendel1.htm>
- <http://knowgenetics.org/mendelian-genetics/>
- <http://www.ncbi.nlm.nih.gov/books/NBK22098/>

17.10 LEARNERS' ACTIVITIES

Activity 1

Teacher ask the learners to wonder the questions and analyze them.

Activity 2

Teacher ask the learners to answer the questions.

Activity 3

The teacher should guide the learners to perform the following activity.

Hint:

Problem A

If trait follows Mendelian pattern of inheritance, then F1 plants should express dominant form of trait, thus would be round.

While F2 plants should express dominant and recessive forms of traits in the ratio of 3 :1 so round and wrinkled seeds would be in the ratio of 3 :1.

Problem B

Demonstration of monohybrid inheritance

In monohybrid cross, ratios are observed in 4 (3 : 1). So let's assume colour trait in beads is following Mendelian pattern. You are provided with F2 progeny i.e., beads in the pouch.

- Open pouch containing beads of two different colours.
- Count total number of beads (let's assume it is 64).
- Divide total number of beads with 4 ($T/4 = z$, $64/4 = 16$).
- Differentiate beads according to their colour and count them respectively (let's assume it 47 red and 17 yellow).
- Divide each number obtained in the previous step with value "z" and make a ratio ($47/16$ and $17/16$ so ratio would be 2.9 : 1.1).
- Yes, the ratio is according to Mendelian ratio 3 : 1.
- It indicates that the particular trait is following Mendelian pattern.

Activity 4

The teacher should guide the learners to perform the activity.

Hint:

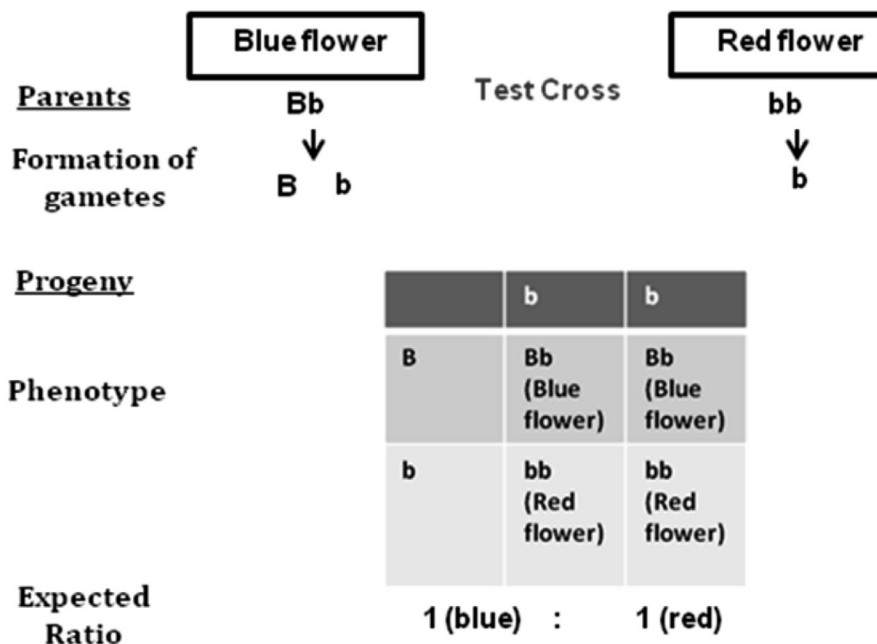

Calculation of chi-square value from the data

| Number of classes/ phenotype | Observed number (o) | Expected number (e) | Deviation (d) = (o-e) | d^2 | $\chi^2 = d^2/e$ |
|---------------------------------|---------------------|---------------------|-----------------------|-------|------------------|
| Blue | 245 | 250 | -5 | 25 | 0.1 |
| Red | 255 | 250 | +5 | 25 | 0.1 |
| Total | | | | | 0.2 |

Degree of Freedom

$$D = n - 1$$

(Where n is total number of classes)

$$D = 2 - 1 = 1$$

Probability of deviation calculation can be calculated by using probability table where in left column degree of class (D) is written and on right row (top most) probabilities are mentioned. At degree of freedom 1 (black arrow), summation of chi-square 0.2 value (red box) shows p value as 0.70-0.50 (blue oval) or 70 to 50%. It indicates that deviation is by chance. There is no significant difference between observed and expected value. Hence, the given cross follows test cross ratio (1:1).

| Degrees of Production | Probability | | | | | | | | | | | |
|-----------------------|------------------|------|------|------|------|-------|-------|-------|--------------|-------|-------|--|
| | 0.95 | 0.90 | 0.80 | 0.70 | 0.50 | 0.30 | 0.20 | 0.10 | 0.03 | 0.01 | 0.001 | |
| → 1 | 0.004 | 0.01 | 0.06 | 0.15 | 0.45 | 1.07 | 1.14 | 2.71 | 3.64 | 6.64 | 10.83 | |
| 2 | 0.10 | 0.21 | 0.45 | 0.71 | 1.39 | 2.41 | 3.22 | 4.00 | 5.99 | 9.21 | 13.82 | |
| 3 | 0.35 | 0.56 | 1.01 | 1.42 | 2.37 | 3.04 | 4.54 | 6.25 | 7.82 | 11.34 | 14.27 | |
| 4 | 0.71 | 1.06 | 1.65 | 2.20 | 3.35 | 4.88 | 5.99 | 7.78 | 9.49 | 13.28 | 18.47 | |
| 5 | 1.14 | 1.61 | 2.34 | 3.00 | 4.35 | 6.06 | 7.29 | 9.24 | 11.07 | 15.09 | 20.52 | |
| 6 | 1.43 | 2.20 | 3.07 | 3.88 | 5.35 | 7.23 | 8.56 | 10.64 | 12.59 | 16.81 | 22.46 | |
| 7 | 2.17 | 2.81 | 3.82 | 4.07 | 6.35 | 8.38 | 9.80 | 12.02 | 14.07 | 18.48 | 24.32 | |
| 8 | 2.73 | 3.42 | 4.59 | 5.52 | 7.34 | 9.52 | 11.03 | 13.36 | 15.51 | 20.09 | 26.12 | |
| 9 | 3.32 | 4.17 | 5.38 | 6.39 | 8.34 | 10.06 | 12.24 | 14.58 | 16.22 | 21.67 | 27.88 | |
| 10 | 1.94 | 4.86 | 6.18 | 7.27 | 9.34 | 11.78 | 13.44 | 15.93 | 18.31 | 23.21 | 29.50 | |
| | Non-significance | | | | | | | | Significance | | | |

Activity 5

The teacher should guide the learners to perform the following activity.

Hint:

Demonstration of dihybrid inheritance

In dihybrid, ratios are observed in 16. So let's assume colour trait and size traits in beads are following Mendelian pattern. You are provided with F₂ progeny i.e., beads in the pouch.

- Open pouch containing beads of two different colours and different sizes.
- Count total number of beads (let's assume it is 96).
- Divide total number of beads with 16 ($T/16 = h$, $96/16 = 6$).
- Differentiate beads according to their colour and size and count them respectively.
 - ◆ Red and large sized beads are 54,
 - ◆ red and small sized are 18,
 - ◆ green and large sized are 18 and
 - ◆ green and small sized are 6.
- Divide each number obtained in the previous step with value "h" i.e., 6 and ratio will be 9:3:3:1.
- The observed ratio is in accordance with the Mendelian dihybrid ratios.

Activity 6

The teacher should guide the learners to make a genetic diagram on their own.

Hint:

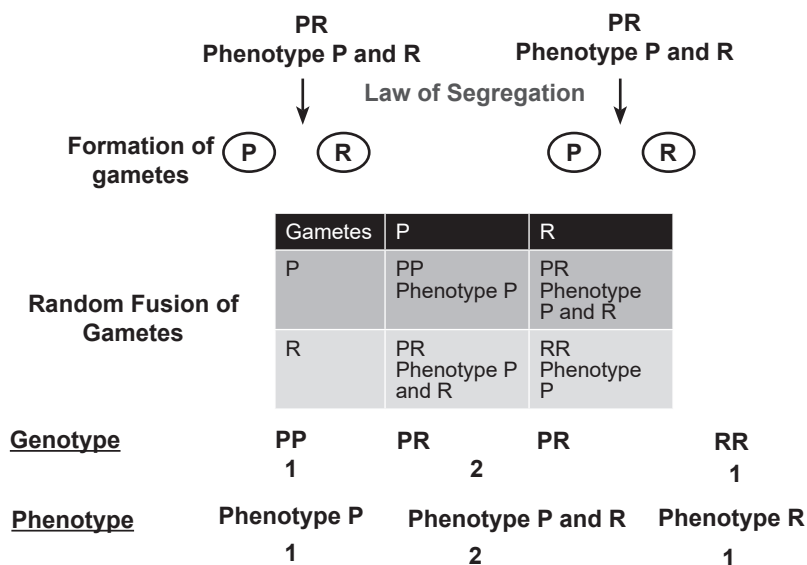

Activity 7

The teacher should guide the learners to solve genetic problem.

Hint:

- (a) It could be the case of lethal allele where in monohybrid ratio gets changed from 3:1 to 2:1 as lethal allele in homozygous combination is lethal while in heterozygous individuals it gives yellow phenotype.
- (b) The genotype of mice with yellow coat colour would be heterozygous “Yy”.

Activity 8

The teacher should guide the learners to perform the activity.

Hint:

Yes, here gene C and gene P have interaction as the product of gene C and gene P are responsible for the formation of colour.

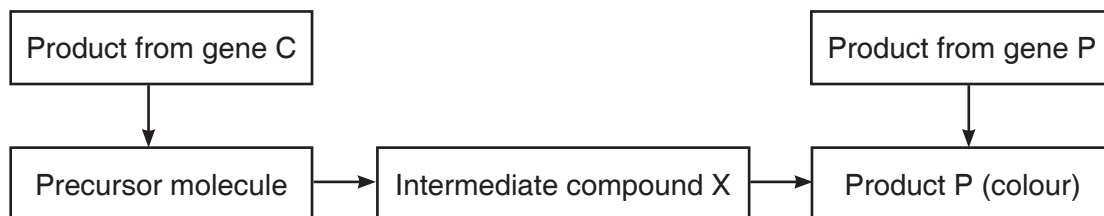

If gene C is present in recessive form, then there will be no formation of intermediate compound X.

In that case whether the other gene Q is present in dominant form but there will be no formation of product P. It is the case of gene interaction where interaction among two genes is required to make a product P.

Activity 9

The teacher should guide the learners to perform the activity.

Hint:

Affected person X^cY \times Homozygous unaffected female (XX)

Chromosomes segregation in the gametes

Female gametes

| | | Male gametes | |
|----------------|---|--------------------------|--------------------------|
| | | X | X |
| Female gametes | X | XX^c Carrier female | XX^c Carrier female |
| | Y | XY Normal male | XY Normal male |

The chances of progeny being affected would be nil.

Although the daughters would be carrier so in next generation, they would pass the trait to half of their sons.

Activity 10

The teacher should guide the learners to perform the activity.

- (a) It indicates that the trait is recessive as affected individuals have unaffected parents.

It can be sex-linked trait also as affected father has transferred the trait to his grandson via daughter.

- (b) Colour-blindness, Hemophilia (sex-linked recessive)

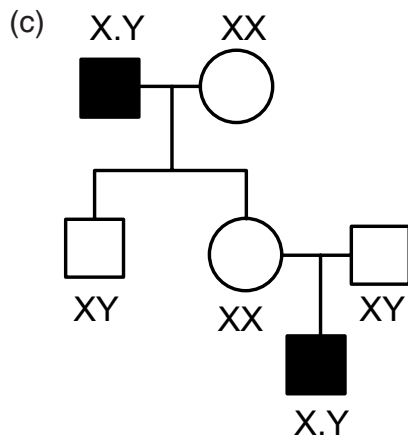

- (d) If affected male marries a carrier woman, what are the ratios of their progeny being affected and unaffected?

F1 red-eye female flies (XX^w) \times F1 red-eye male flies (XY)

Chromosomes segregation in the gametes

| | | Female gametes | |
|-------------------------------|-----|------------------------|--------------------------|
| | | Gametes | X |
| F2 generation Male gametes | X | XX Red-eye female | XX^w Red-eye female |
| | Y | XY Red-eye male | X^wY White-eye male |

There are fifty per cent chances of their progeny being affected with the disease.

17.11 ANSWERS TO SELF-EVALUATION

Self-evaluation

- (i) Test cross
(ii) GJ Mendel
(iii) 17
(iv) Phenotype

Self-evaluation

- (i) Linkege
(ii) Incomplete dominance
(a) is both as expressed
(b) is dominant/recessive
(c) is progeny in between the two
(iii) 3:1
(iv) 8

Self-evaluation

- (i) (c), Inheritance of a condition like phenylketonuria and autosomal recessive trait.
(ii) Huntington's

- (iii) there are 45 chromosomes
- (iv) Chromosome non-disjunction

17.12 ANSWERS TO END UNIT ASSESSMENT 17

I. Choose whether the following statements are True or False:

1. **False;** as traits are passed on from both the parents to offsprings. The progeny gets one chromosome from father and one from the mother.
2. **False;** in the monohybrid cross between tall and dwarf plants, second generation (F₂) plants include both tall and dwarf plants in the ratio of 3 (tall): 1 (dwarf).
3. **True;** in co-dominance, both the alleles of gene are equally expressed. For example, MN individual expresses both M as well as N alleles, thus have both M and N glycoprotein on their RBC plasma membrane.
4. **False;** not always as cross-over event can separate genes located on the same chromosome. The frequency of cross-over event increases as distance between the genes increases.
5. **True;** Y chromosomes determines the maleness in humans so XXY individual will be male although he suffers from Klinefelter syndrome. XO is female but she suffers from Turner syndrome. It indicates that for the normal functioning of male and female reproductive system, normal complement of chromosomes XY and XX is required respectively.
6. **False;** as recessive individual will have genotype “aa” for the particular disease so genotype “aa” can never come from one affected (“aa”) genotype and unaffected homozygous parents (“AA”).
7. **False;** the frequency of crossing over decreases when the genes are closely apart.
8. **True;** white-male eyes drosophila were observed by T. H. Morgan. Later he indicated that white-eyes colour trait is sex-linked.
9. **True;** In pedigree analysis, the dominant traits are observed every generation as dominant trait is expressed in heterozygous individual as well.
10. **True;** Non-disjunction of chromosomes where chromosomes fail to move during anaphase stage can happen at meiosis or mitosis.

II. Multiple choice questions:

1. **(b);** working with pure lines which were true for particular trait helped him to concentrate on that trait. It was one of the reasons for his success.

2. **(a)**; F1 generation which means filial comes from latin word progeny and one indicates first.
3. **(a)**; Garden pea generates large number of progeny which enable Mendel to makes quantitative records of the offspring obtained from breeding experiments.
4. **(b)**; the factors or alleles of gene for particular trait segregate at the time of fertilization so a gamete has one number of alleles for a particular gene.
5. **(a)**; The Phenotypic Mendelian monohybrid ratio is 3:1 while genotypic ratio is 1:2:1.
6. **(b)**; when dominant allele is not completely dominant and recessive allele is not completely recessive. The trait is partially expressed.
7. **(b)**; Dihybrid cross is the cross between two plants with two pair of contrasting traits.
8. **(b)**; Test cross is cross between F1 hybrid with recessive parent.
9. **(a)**; Genetic makeup of Klinefelter syndrome is 44 autosomes and XXY.
10. **(a)**; Huntington's disease in humans is the example of autosomal dominant genetic disease.

III. Long answer type questions:

1. **Gene:** Gene is the entity/unit which has the information for particular trait. For example: in garden pea, gene for stem height has information for height whether it would be long or small.

Locus: The position of gene on chromosome constitutes its loci/locus.

Allele: The alternate forms of genes are known as Alleles. A pair of alleles for each trait is present in the zygote of an organism. For example: in garden pea, true breeding tall parent plants have two similar alleles (TT).

Dominant Allele: In individual, out of two alleles for the particular trait, only one allele is expressed. The expressed allele is known as dominant. For example, allele (T) for tallness is expressed in F1 individuals (Tt), dominant allele. Dominant allele is generally referred by capital alphabet.

Recessive Allele: In individual, out of two alleles for the particular trait one allele is under-expressed. The under-expressed allele is known as recessive. For example, allele (t) for shortness is not expressed in F1 individuals (Tt), recessive allele. Recessive allele is generally referred by small alphabet.

Co-dominant: It's a phenomenon when both alleles present in an individual, are equally expressed. For example, in humans, blood cells express both the alleles M and N (alternate form of gene encoding Red blood cell membrane protein) when present together.

Linkage: The genes are said to be linked when present on the same chromosome and inherited together as unit.

Test Cross: It is cross between hybrid forms (dominant phenotype) with other parent with recessive form of particular trait (homozygous recessive). It is generally used to identify the genotype of hybrid form.

F1: F symbolized filial, which means “progeny” in latin. F1 is the filial generation first, produced by cross between parent individuals.

F2: F2 is the filial generation second, produced by cross between F1 individuals

Phenotype: The morphological appearance for particular trait constitutes its phenotype. For example: In the cross between tall and dwarf parent plants, F1 plants are tall. Tallness is their phenotype. In F2 plants, tall and dwarf plants are obtained in ration of 3 : 1, it is phenotypic ratio.

Genotype: The combination of allele for particular trait in an individual constitutes its genotype. For example: In the cross between tall and dwarf parent plants, F1 plants are Tt. “Tt” constitute their genotype for the trait stem height. Similarly, F2 plants are tall and dwarf. But genotype of all tall F2 plants is not same, one third are pure (TT) while two third are hybrid (Tt). So genotypically F2 ratio is 1 : 2 : 1.

Homozygous: When in an individual, two alleles for a particular trait are alike, then the individual is considered homozygous for the particular trait. For example, parent plants Tall and Dwarf plants are homozygous for stem height.

Heterozygous: When in an individual, two alleles for a particular trait are different, then the individual is considered heterozygous for the particular trait. For example, F1 plants are genotypically “Tt”. They are heterozygous for stem height.

2. **Test Cross:** It is cross between hybrid forms (dominant phenotype) with other parent with recessive form of particular trait (homozygous recessive). It is generally used to identify the genotype of hybrid form. The progenies are observed. If all progeny demonstrates only dominant form of trait, thereby indicating that unknown genotype must be homozygous for the particular trait. Or If F1 progeny shows both dominant and recessive form of trait in the ratio of 1 : 1 indicating that unknown genotype must be heterozygous for the particular trait. There can be two possible genotypes of an unknown dominant phenotype as illustrated below.

Possibility 1. If the unknown is homozygous yellow (YY) then crossing with green recessive (yy) gives all yellow offspring (i.e., all Yy) as shown below:

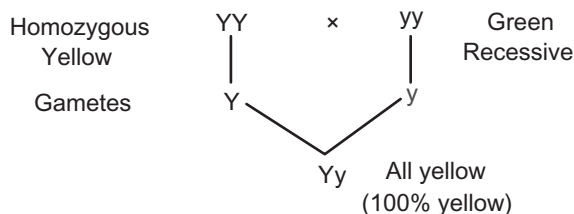

Possibility 2. If the unknown is heterozygous yellow (Yy), then crossing with green recessive results in 50% yellow (Yy) and 50% green (yy) progeny as shown below:

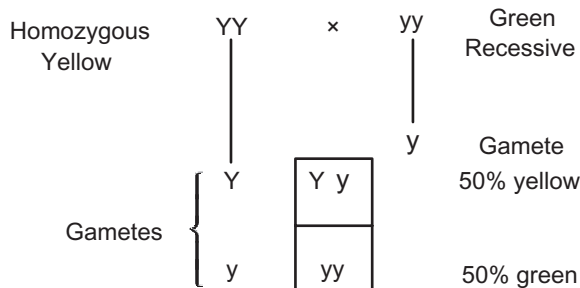

In case of a double heterozygous, i.e., heterozygous yellow and round (Yy Rr) crossed with double recessive, i.e., recessive green and wrinkled (yy rr) the ratio will be 1 : 1 : 1 : 1.

- 3. Monohybrid Cross:** *'It is a cross between two individuals of a species which is made to study the inheritance of a single pair of factors or genes of a trait.'* A ratio among the offspring of F₂ generation of a monohybrid cross is called a **'monohybrid ratio.'** It is usually 3 : 1 (phenotypic ratio) or 1 : 2 : 1 (genotypic ratio), in which 1/4 individuals carry the recessive trait, 1/4 pure dominant and 1/2 have impure dominant trait.

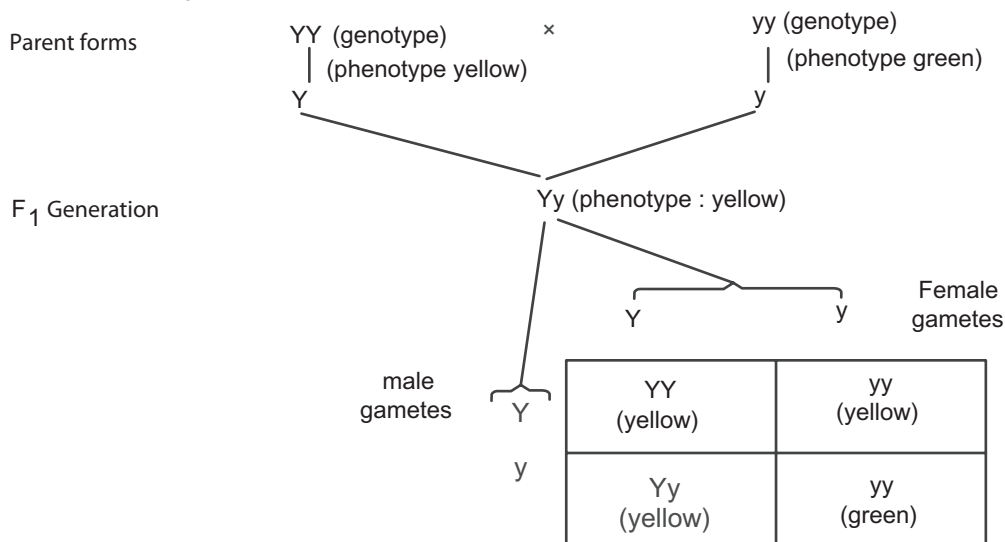

F₂ Generation
 Phenotypic ratio :: 3 yellow (1 YY and 2 Yy) : 1 green (yy)
 Genotypic ratio :: 1 : 2 : 1 (1YY : 2Yy : 1yy)

- 4.** It is well established that there are two alleles for a single gene. However, sometimes in a population there can be more than two alleles for a certain gene which can be illustrated by the ABO blood group system. In ABO blood group

system there are three alleles I^A , I^B and I^O in the population. The alleles decide the type of glycoprotein found on the surface of erythrocytes (red blood cells). There are four blood types phenotype as depicted in table 1. The Individual with blood group A express A type of glycoprotein while the individual with blood group B express B type of glycoprotein. The individual with blood group AB expresses both types of glycoprotein while O type individual contains neither A or B.

Alleles I^A and I^B are dominant to I^O so A type individuals can have $I^A I^A$ or $I^A I^O$ genotype. Similarly, B type can have $I^B I^B$ or $I^B I^O$ genotype. Alleles I^A and I^B are co-dominant, so when present together in AB, individuals are expressed together. Alleles I^O is recessive so O type individuals are recessive homozygous $I^O I^O$. ABO Blood type example demonstrates unique combination of multiple alleles as well as co-dominance.

Table 1: The ABO blood type in human population

| Individual blood type | Phenotype (type of glycoprotein) | Allele present (Genotype) |
|-----------------------|-------------------------------------|------------------------------|
| A | A | $I^A I^A / I^A I^O$ |
| B | B | $I^B I^B / I^B I^O$ |
| AB | A and B both | $I^A I^B$ |
| O | None | $I^O I^O$ |

5. Sometimes genes have serious effect on development, and physiology of the organism in such a way that organism is unable to survive. Such genes are known as lethal genes. The particular allele responsible for death of the organism is known as lethal alleles. Lethal allele can be dominant or recessive. For example: The dominant allele C in chicken has serious effect in development of the organism and results in following phenotype:

Aberrant form “creepers” in Heterozygous individual (Cc)

Completely “lethal” in homozygous dominant (CC).

When two heterozygous creeper individuals are mated, progeny are obtained in phenotypic ratio of 2 (Creeper): 1(Normal) instead of 3 : 1 monohybrid Mendelian ratio.

Mendel observed similar results when he analyzed results of dihybrid cross for the other pair of traits as well. The dihybrid results did not contradict monohybrid results, the round seeds and wrinkled seeds as well as yellow and green seeds were in ratio of 3 : 1. He hypothesized dihybrid cross event as two independent monohybrid cross events.

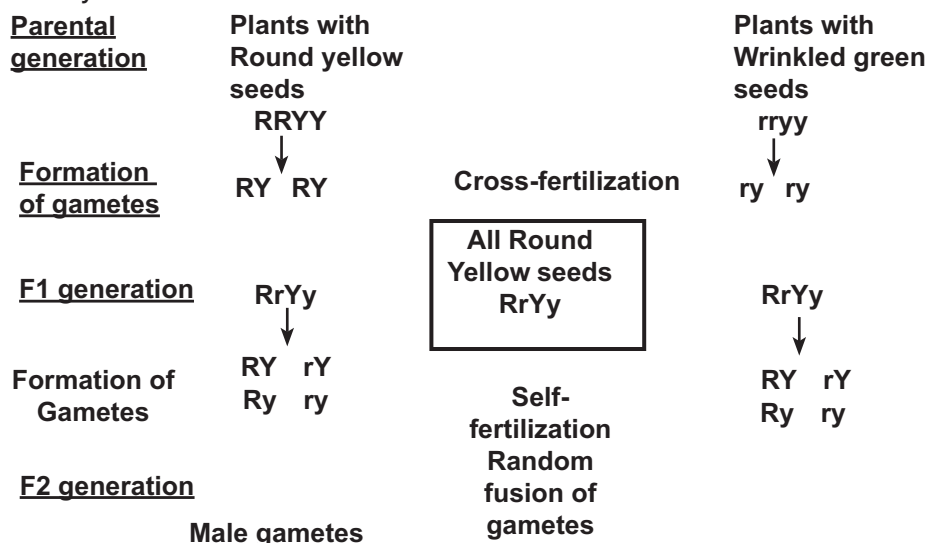

| | | Male gametes | | | |
|----------------|----|----------------------------|----------------------------|-------------------------------|------------------------------|
| | | RY | Ry | rY | ry |
| Female gametes | RY | RRYY (Round and yellow) | RRYy (Round and yellow) | RrYY (Round and yellow) | RrYy (Round and yellow) |
| | Ry | RRYy (Round and yellow) | RRyy (Round and green) | RrYy (Round and yellow) | rrYy (Round and green) |
| | rY | RrYy (Round and yellow) | RrYy (Round and yellow) | rrYY (wrinkled and yellow) | rrYy (Round and yellow) |
| | ry | RrYy (Round and yellow) | Rryy (Round and green) | rrYY (wrinkled and yellow) | rryy (wrinkled and green) |

7. Test cross can be used to differentiate genotype of dihybrid organisms (whether it is homozygous and heterozygous for the traits) if phenotypically same for a traits. For example: plants with similar phenotype rounded seed shape and yellow seed colour can have different genotype RRYY or RrYy. So the genotype of such plants can be identified by test cross. So plant with unknown

genotype is crossed with plant with recessive form of both the traits. There are two possibilities 1. If progeny plants are observed in phenotypic dihybrid test ratio 1 (round and yellow):1 (round and green):1 (wrinkled and yellow):1 (wrinkled and green), then the parent plant must have heterozygous genotype for both the traits.

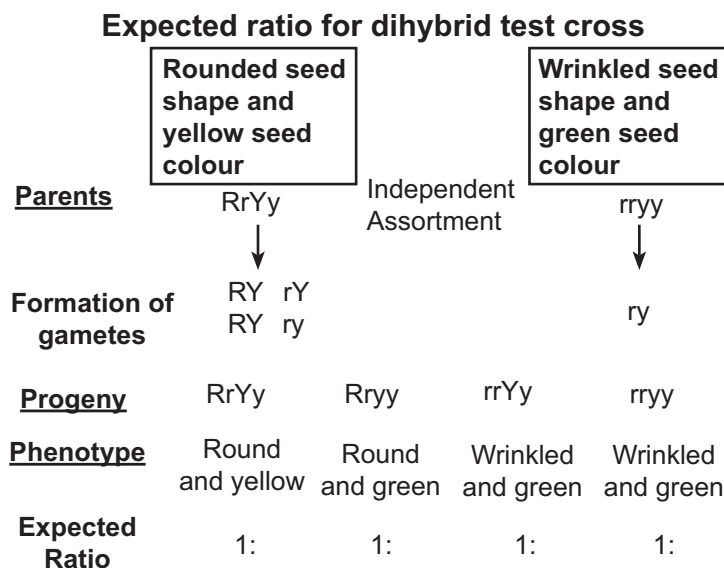

8. Significance of Recombination

- The major significance is generation of variations. Due to crossing over, genes even on the same chromosome can be assorted differently. It leads to variations in the progeny. The variations are very useful in nature as it provides raw material on which natural selection can act.
- The frequency of crossing over becomes higher with increase in physical distance between gene loci. So recombinant frequency between two genes can be used to determine distance between genes, hence it helps to create chromosome map.

9. Sex Determination in Humans

In humans and other placental mammals, male and female differ in their chromosome complement. Generally, there are two types of chromosomes, autosomes and sex chromosomes. Generally, in one sex (mostly female), both the sex-chromosomes are alike/homomorphic (XX) and in other sex (male) there are two different/heteromorphic sex chromosomes (XY). As the females are homomorphic (44 autosomes and XX) so female produces single type of ovum containing 22 autosomes and one X chromosome while males are heteromorphic (44 autosomes and XY) so male produces two types of

sperm, one containing 22 autosomes and an X chromosome while other with 22 autosomes and a Y chromosome. It is the Y chromosome which determines the sex of the individual. Y chromosome has Testis-determining factor (TDF) gene which produces testis determining factor which causes primordial gonadal tissue in developing foetus to differentiate into testis. In the absence of TDF, tissue differentiates into ovaries. So

- Individuals with Y chromosome are genetically male.
- Individuals without Y chromosome are genetically female.

So the sex in human is determined at the moment of conception or fertilization of male (sperms) and female gamete (ovum). If ovum gets fertilized by sperm containing an X-chromosome, then resulting zygote will have two XX chromosomes and will develop into female.

But if ovum gets fertilized by sperm containing a Y-chromosome, then resulting zygote will have two XY chromosomes and will develop into male. So biologically, father is responsible for sex of the child.

Evidence for Role of Y Chromosomes in Sex Determination in Humans

The early evidence for the role of Y chromosome in sex determination is provided by certain individuals with chromosome number abnormality i.e. Turner syndrome and Klinefelter syndrome which are caused by non-disjunction of sex chromosomes in meiosis.

Turner syndrome: Here, individuals have 45 chromosomes in contrast to normal complement of 46 chromosomes. The Turner individuals have chromosome complement 45 (XO) and are sterile female. They tend to have short height; fail to develop secondary sexual characters and immature internal sex organs.

It indicates presence of two X chromosomes is not important at least in female sex determination obviously it is essential for proper development of female.

Klinefelter syndrome: Here individuals have 47 chromosomes in contrast to normal complement of 46 chromosomes. The Klinefelter individuals have chromosome complement 47 (XXY) and sterile male. They tend to have underdeveloped testis, taller than the average male, breast development.

It indicates that despite the presence of two XX chromosomes, the sex of the individual is male. Thus, the presence of Y chromosome determines maleness.

10. Chromosome non-disjunction is the failure of the homologous chromosomes to separate at anaphase at the time of cell division. The phenomenon was first observed by C. Bridges in *Drosophila*. It involves autosomes or sex chromosomes. Generally, two sex chromosome synapse at the time of meiosis and segregate equally in the gametes so gametes have single sex chromosomes.

If synapsed sex chromosomes fail to separate, then one type of gamete receives both sex chromosomes while other receives none.

For example: If non-disjunction of sex chromosomes happens in egg formation, then one egg will receive both X chromosomes while other receives none in contrast to equal distribution of sex chromosomes. The fusion of the egg with normal sperm with single chromosome X or Y leads to individuals with XXX (super-female), XXY (Klinefelter syndrome), XO (Turner syndrome) and YO (lethal phenotype).

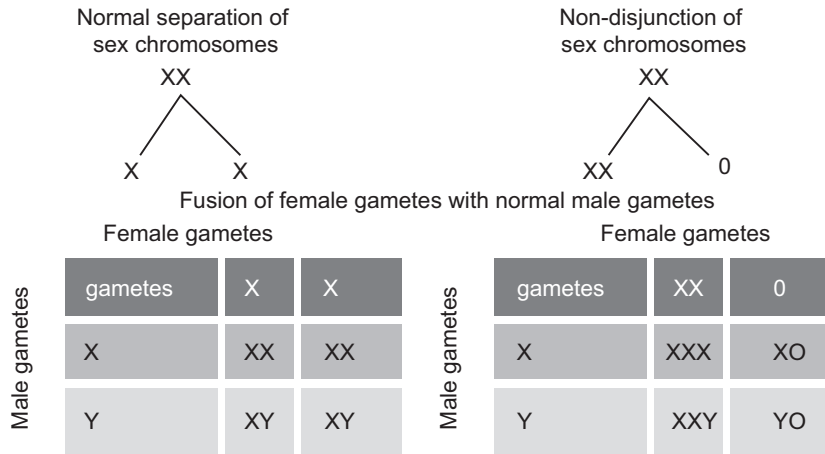

Normal separation : Normal sex chromosomes distribution in individuals
 Non-disjunction : Abnormal sex chromosomes distribution in individuals

11. Linked genes are located on the same chromosome, and so they do not assort independently during gamete production in meiosis. The law of independent assortment applies only to genes located on different chromosomes, since there is a 50% chance that a chromosome inherited from the father will be passed on to a gamete, and 50% chance that the homologous chromosome inherited from the mother will be passed on to the same gamete. However, this law does not apply to genes located on the same chromosome, since these are passed on to gametes together. However, keeping in mind the chances of recombination during crossing over, the farther apart the two loci of the genes are, the less likely the two traits are to be inherited together.
12. A chromosome map is the linear arrangement of genes in the chromosome with their relative distance. It is based on fact that the frequency of crossing over between two genes is directly proportional to the physical distance between the two. Therefore, the distance between genes is indicated by percentage of crossing over (recombinant frequency). The distance unit is map unit or 1cM (centi-Morgan, in honour of T. H. Morgan), so When 1% recombinant frequency is observed between two genes, then genes are said to be 1 map unit apart.

T. H. Morgan and Sturtevant carried out extensive work in drosophila in finding recombination frequency between different genes and based on recombination data, they generated chromosome map.

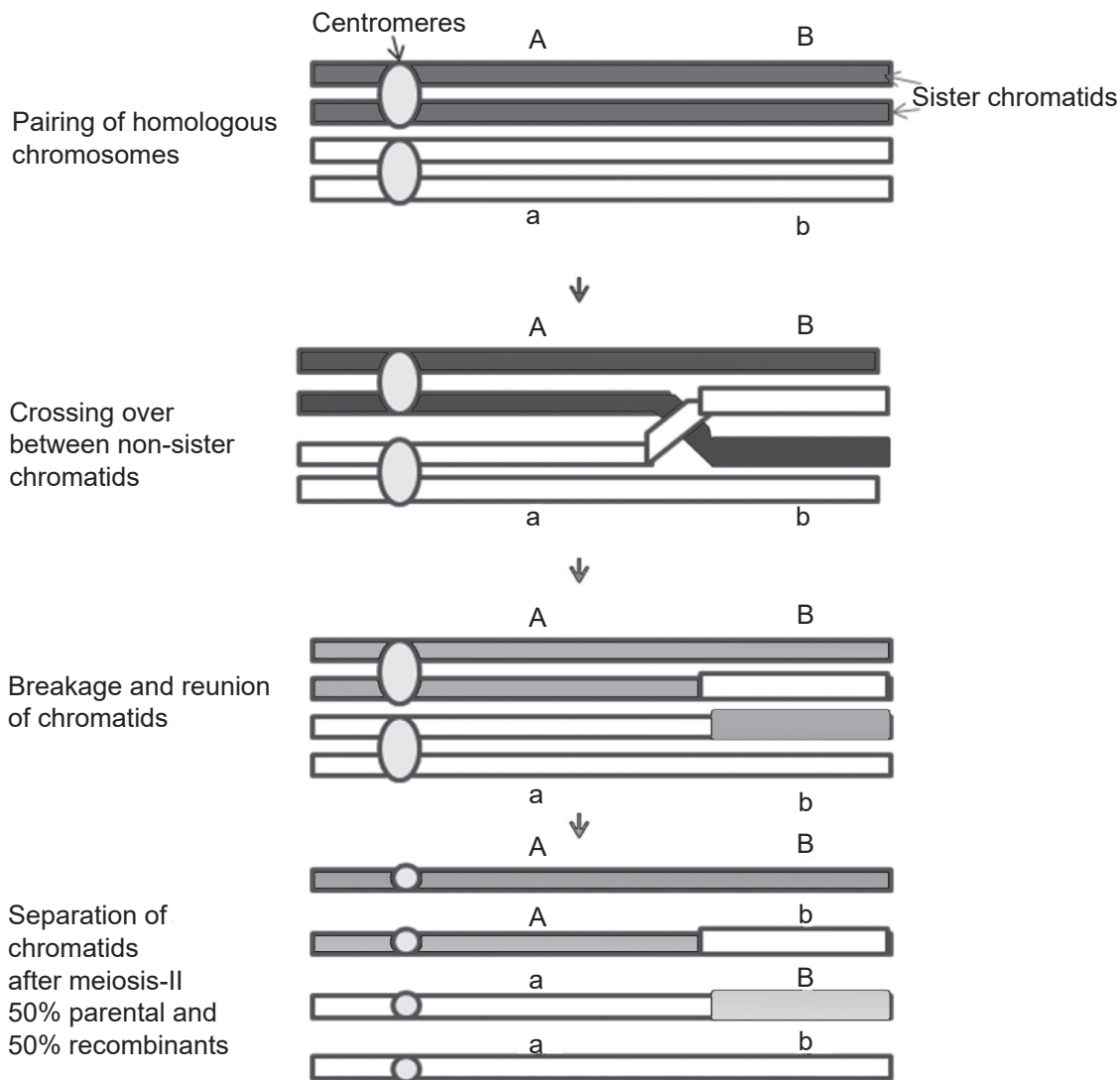

A and a alleles of gene A while B and b are alleles of gene B. In recombinant chromatids allele "A" combine with "b" allele while "a" combine with "b".

For example: if recombination frequency between two genes A and B is 3% or 3 map unit. If distance between B and C is 10 map unit and distance between A and C is 7 map unit. Then we can make chromosome map based on the information of recombination frequency. There are three possibilities:

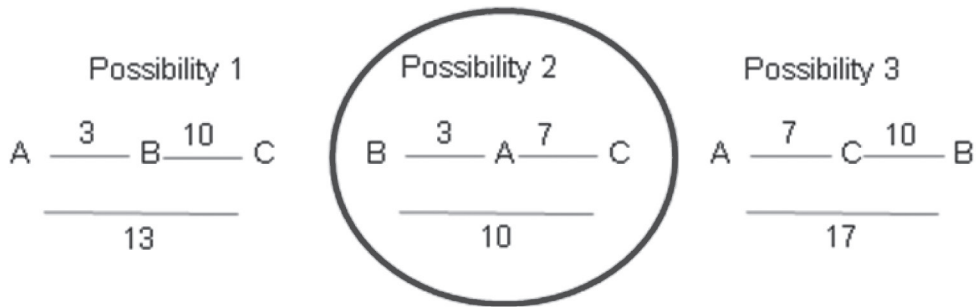

But based on the information, possibility B represents the actual order of genes. At the same time, we should remember even when genes are very far, there are 100% chances of crossing over but recombinant frequency will not exceed more than 50% only because with increased distance, double or multiple cross events happen which cancel the effect of single cross over.

- 13.** Genetic research is a complicated thing. The scientists understand how the genes function and how they affect human health; however, the diseases that are triggered by genetic factors do not always function “by the rule” except for a few disorders which are directly caused by genetic abnormalities and mutations such as Marfan syndrome (genetic disorder of the connective tissue resulting in abnormal height and limb length), Huntington disease (neurodegenerative disorder), Niemann-Pick disease (metabolic disorder), Roberts syndrome (very rare prenatal retardation), Lesch-Nyhan syndrome (rare genetic mutation causing build-up of uric acid in body fluids) and many others. People with certain genes are at increased risk of conditions associated with those particular genes. In other words, you are more likely to be affected by diseases which are inheritable and conditions that run in your family although they are not directly inherited. And the list of conditions that can be influenced by genetic factors are virtually countless. Genetic researches help identify diseases and health problems that are more likely to be influenced by genetic factors as well as to assess the risk of a particular disease in an individual. These researches are known as genetic tests. When a genetic test confirms a high risk of certain condition, an expert in the field determines preventive measures to reduce the risk of that particular disease. Genetic testing is very reliable; however, it cannot tell you for sure whether you will develop a particular disease or not.

Healthy people have been intrigued by the possibility that genetic testing may tell them more about what the future may hold and then using that knowledge improves their health.

There is now very reliable evidence that certain gene variants confer a high risk of developing breast, ovarian or bowel cancer. In these instances, high levels

of surveillance coupled with medical interventions such as surgery could detect cancer early or prevent cancer.

In the future, people who do not have any reason to believe they are at increased risk to develop cancer may choose to have genomic sequencing so they can learn more about their risk and take appropriate actions to reduce it.

But there are a number of genetic variants with only limited evidence to suggest a connection between the gene and the development of disease.

Using genetic testing for predictive purposes comes with a number of ethical dilemmas.

The NIH recently announced funding of research programmes to investigate the use of genomic sequencing in the screening of newborns. As well as diagnosing conditions affecting these babies sooner, genomic sequencing can also predict the development of rare inherited adult onset conditions such as some cancers.

This is the information that some healthy, high-risk adults prefer not to know, while others cope by learning as much as possible.

There is currently no consistent view on how inadvertent predictive testing (or incidental findings, which may or may not have health implications some time in the future) should be managed, particularly when testing would be performed at birth or during pregnancy.

17.13 ASSESSMENT METHODS

Use observation technique, question answer technique, and demonstration technique to assess the learners' achievement of learning objectives.

17.14 ASSESSMENTS

Formative Assessment

Fill in the blanks:

1. is linear arrangement of genes in chromosome.
2. Chromatids which participate in crossing over generate

Ans. 1. Chromosome map, 2. Recombinant chromatids

Summative Assessment

Answer in one word:

1. Chromosome theory of inheritance was given by
2. Morphological appearance for particular trait constitutes

Ans. 1. Sutton and Boveri, 2. Phenotype

Unit 18: Mutations

18.1 LEARNING OBJECTIVES

| Knowledge and Understanding | Skills | Attitudes and Values |
|---|--|--|
| <ul style="list-style-type: none"> • Define mutation. • Describe types of mutation and causes of mutations. • Explain the significance of mutations. • Explain that gene mutation occurs by substitution, deletion, inversion and insertion of base pairs in DNA. Outline how such mutations may affect the phenotype. • Explain that the environment may affect the phenotype. • Outline the effects of mutant alleles on the phenotype in the following human conditions: albinism, sickle cell anaemia, haemophilia and Huntington's disease. • Explain the relationship between genes, enzymes and phenotypes with respect to the gene for tyrosinase involved in the production of melanin. • Explain how a change in the base sequence of the gene for haemoglobin results in abnormal haemoglobin and sickle-shaped red blood cells. | <ul style="list-style-type: none"> • Make a chart illustrating and summarising different kinds of gene and chromosomal mutations. • Distinguish between gene and chromosomal mutation. • Use a thin clay log composed of different colours to represent different chromosomes. • Manipulate the clay to show how an inversion can occur. • Use internet to search simulations of mutations and deduce the findings. | <ul style="list-style-type: none"> • Appreciate that mutations can bring about change in the genetic constitution of an organism and that these may or may not result in evolution. |

18.2 TEACHING AIDS

Visual: Images of mutations

Audio-video: Video showing the examples of mutations.

18.3 TEACHER'S TIP

Start the unit by briefing the learners by stating the introduction of mutation. Explain the different types of mutation, how are they produced, their effect on phenotype and what role environment plays in the production of a phenotype. Discuss that the mutations are helping us not only to understand evolutionary process better, but also find the ways of treating cancer.

18.4 TEACHING METHODS

Brainstorming, short lecture technique, group discussion technique, observation technique, drawing technique, demonstration technique, field visit, site visit and practical work.

18.5 TEACHING AND LEARNING MATERIALS

Online resources, CDs, computer simulations, diagrams, charts, micrographs, clay logs, and illustrations.

18.6 TEACHING METHODOLOGY

Teacher initiates the topic by introducing the mutations and asking if they know about it. Learners reply to the teacher.

Appreciating them, further ask if they are aware of the causes and effects of mutations. Learners will come up with varied answers. Some correct, some near to correct, others being irrelevant.

Teacher will not demotivate the child. But agreeing to the correct answers, move further in discussion.

Teacher will explain them further the types of mutations.

Using short lecture technique, teacher will explain the significance of mutations.

18.7 ADDITIONAL CONTENT FOR THE TEACHER

The term 'mutation' was introduced by **Hugo De Vries** (1846–1935), a Dutch botanist. He described the sudden changes appearing in the evening primrose, *Oenothera lamarckiana*, during breeding experiments, as mutation.

Later, it was found that the changes observed by him, in this plant, were in reality phenotypic expression of genetic recombinations and not mutations (i.e., structural

changes in genes or chromosomes). De Vries proposed '**mutation theory of evolution**' in his book '*The Mutation Theory*' published in 1903. He highlighted the possibility of sudden large heritable changes occurring in germplasm of the organism leading to evolution. This is in contrast of Darwin's view that small continuous variations (recombinations) were responsible for evolution.

Activity

The teacher can demonstrate this activity in the class.

Aim: To make the learners aware of mutations.

Refer to the text and ask the learners to know different diseases. Ask them to write on chart papers and explain them.

18.8 SUMMARY

I. Mutation, types and their effects on phenotype:

- Mutation is any permanent change in the genetic material of an organism. Somatic mutations are not passed to offspring whereas germinal mutations are heritable.
- Point mutations refer to changes occurring in single nucleotides.
- Substitution of one base by another may lead to silent (no change), missense (altered codon) or non-sense (stop codon). Change is confined to single codon.
- Altered codons lead to the incorporation of a different amino acid altering the function of the protein. Examples are seen in diseases like sickle cell anaemia, haemophilia, and albinism.
- Insertion or deletion of a base changes the frame of reading the genetic code, resulting in frame shift mutations. Genetic code being comma-less, addition or deletion of one base alters all subsequent codons, coding for a sequence of amino acids which are totally different from the original sequence.
- Chromosomal mutations refer to changes in structure or number of chromosomes.
- Chromosome breakages can cause deletion (loss of genetic material), duplication (gain of genetic material), inversion (fusion of broken segments in opposite orientation) or translocation (fusion of a part of one chromosome to another, non-homologous chromosome).
- Non-disjunction of chromosomes can lead to monosomy ($2n-1$) or trisomy ($2n + 1$). Example of monosomy is Turner's syndrome and example of trisomy is Down's syndrome.
- Addition of haploid sets to the chromosome complement of a cell can change the ploidy level creating triploid, tetraploid individuals. This can occur whenever two sperms happen to fertilise a single ovum, creating a triploid situation or a diploid egg is fertilised by a diploid sperm (all chromosomes fail to disjoin). This has given rise to newer varieties of plants such as seedless bananas.

II. Causes of mutations:

- Chance effects like mistakes during DNA replication, hydrolysis.
- Ionizing radiation for example X rays, protons, neutrons and alpha, beta and gamma rays emitted by radioactive elements have high energy and can penetrate the tissues causing damage to DNA in a number of ways depending on the dose.
- Non-ionizing radiation; for example, UV rays don't penetrate tissues because of low energy but are strongly absorbed by nitrogenous bases, esp. thymine, causing the formation of thymine dimers. This makes them highly mutagenic and excessive exposure to solar radiation can lead to development of skin cancers.
- Chemical mutagens belong to two classes: one which produces mutations in replicating and non-replicating DNA for example alkylating agents, nitrous acid and the other produces mutations only in replicating DNA for example acridine dyes, base analogs.
- These chemicals generally produce mutations by altering base pair affinities.
- A number of common chemicals routinely encountered in environment such as bromine, pesticides, food additives, etc., may work the same way and thus potentially carcinogenic.
- A number of these chemicals have found in treating cancers.

III. Effect of environment on the phenotype:

- Phenotype of any organism is the result of interaction of genotype and environment.
- Interaction may be due to the effect of temperature on enzyme activity.
- Effect of mutant allele can be minimized by modifying the environment for example, children born with phenylketonuria may lead a nearly normal life if fed on diet free of phenylalanine.

IV. Significance of mutation:

- Majority of new mutations are generally deleterious, resulting in disease, some mutations are adaptive for example, sickle cell allele conferring protection against malaria.

18.9 WEBLINKS FOR CONTENT ENRICHMENT

- <http://learn.genetics.utah.edu/content/variation/mutation>
- <http://www.yourgenome.org/facts/what-is-a-mutation>
- <https://ghr.nlm.nih.gov/handbook/mutationsanddisorders/genemutation>

18.10 LEARNERS' ACTIVITIES

Activity 1

Teacher ask the learners to perform activity as directed.

Activity 2

Teacher ask the learners to perform activity in groups as directed.

Activity 3

The teacher should divide the learners into group of four each.

Hint:

DNA sequences of different human protein.

For example, DNA sequences of haemoglobin beta chain gene is

GTGCATCTGACTCCTGAGGAGAAGTCTGCCGTTACTGCCCTGTGGGGCAAGGTGAACGTG

Now we will incorporate different point mutation such as substitution mutation, deletion and insertion and try to ascertain their effect on primary sequence of amino acid in protein.

| | | Second base | | | | |
|---------------------|---|---------------------|-----|----------|----------|---|
| | | U | C | A | G | |
| First base (5' end) | U | UUU | UCU | UAU | UGU | U |
| | | UUC | UCC | UAC | UGC | C |
| | | UUA | UCA | UAA Stop | UGA Stop | A |
| | | UUG | UCG | UAG Stop | UGG Trp | G |
| | C | CUU | CCU | CAU | CGU | U |
| | | CUC | CCC | CAC | CGC | C |
| | | CUA | CCA | CAA | CGA | A |
| | | CUG | CCG | CAG | CGG | G |
| | A | AUU | ACU | AAU | AGU | U |
| | | AUC | ACC | AAC | AGC | C |
| | | AUA | ACA | AAA | AGA | A |
| | | AUG Met or start | ACG | AAG | AGG | G |
| | G | GUU | GCU | GAU | GGU | U |
| | | GUC | GCC | GAC | GGC | C |
| | | GUA | GCA | GAA | GGA | A |
| | | GUG | GCG | GAG | GGG | G |
| | | Third base (3' end) | | | | |

1. First transcribe the given DNA sequence into mRNA sequence.

Conversion to mRNA: change the sequence to mRNA form by changing T with U

GUGCAUCUGACUCCUGAGGAGAAGUCUGCCGUUACUGCCCUGUGGGGCAAGGUGAACGUG

- Translate mRNA sequence into amino acids with the help of genetic code table.
Val-His-Leu-Thr-Pro-Glu-Glu-Lys-Ser-Ala-Val-Thr-Ala-Leu-Trp-Gly-Lys-Val-Asn-Val

For Substitution Mutation

- Now randomly decide any nucleotide to mutate of given DNA sequence. (Choose by your favourite number, your birthday date..... completely random). Suppose we mutate nucleotide number 14. Consider it **mutation 1**

GTGCATCTGACTCCTGAGGAGAAGTCTGCCGTTACTGCCCTGTGGGGCAAGGTGAACGTG

- Now Roll the tetrahedron dice and look for the new nucleotide. (lets assume its A)

- Note down nucleotide and replace the original nucleotide C with new nucleotide A.

GTGCATCTGACTCATGAGGAGAAGTCTGCCGTTACTGCCCTGTGGGGCAAGGTGAACGTG

- Transcribe the new sequence into mRNA sequence.

GUGCAUCUGACUCAUGAGGAGAAGUCUGCCGUUACUGCCCUGUGGGGCAAGGUGAACGUG

- Translate into protein sequence

Val-His-Leu-Thr-His-Glu-Glu-Lys-Ser-Ala-Val-Thr-Ala-Leu-Trp-Gly-Lys-Val-Asn-Val

- Record your observation for mutation 1.
- Repeat it thrice (for three mutation) from step 5 to 7, randomly choose any nucleotide to mutate and observation is recorded. **The observation will indicate different types of point substitution mutation.**

| Mutation | DNA sequence | mRNA sequence | Change in Protein | Type of Mutation |
|---------------------------|---|---|--|-----------------------|
| No Mutation | No change | No change | Same protein | No mutation |
| Mutation at site ----- | Change in triplet code of original sequence | Change in triplet code of original sequence | Same protein | Silent mutation |
| Mutation at site ----- | Change in triplet code of original sequence | Change in triplet code of original sequence | Different amino acid but chemically similar to original amino acid | Conservative mutation |

| | | | | |
|---------------------------|--|---|--|----------------------------------|
| Mutation at site ----- | Change in triplet code of original sequence | Change in triplet code of original sequence | Different amino acid | Non- conservative mutation |
| Mutation at site ----- | Change in triplet code of original sequence, stop codon | Change in triplet code of original sequence, stop codon | No amino acid and termination of protein synthesis | Non-sense mutation |

For Deletion Mutation

10. Now randomly decide any nucleotide to delete of given DNA sequence. Suppose we mutate nucleotide number 10. Consider it **deletion mutation**.

GTGCATCTGATCCTGAGGAGAAGTCTGCCGTTACTGCCCTGTGGGGCAAGGTGAACGTG

11. Transcribe the new sequence into mRNA sequence.

GUGCAUCUGAUGAUGAGGAGAAGUCUGCCGUUACUGCCCUGUGGGGGCAAGGUGAACGUG

12. Translate into protein sequence,

Val-His-Leu-Ile-Met-Arg-Arg-Ser-Leu-Pro-Leu-Leu-Pro-Cys-Gly-Ala-Arg-STOP

13. Such mutation is a frame shift which tends to change the entire framework.

For Insertion Mutation

14. Similarly, randomly decide addition of any single nucleotide to the given DNA sequence. Suppose we add at site 20. Consider it **Insertion mutation**.

GTGCATCTGACTCCTGAGGATGAAGTCTGCCGTTACTGCCCTGTGGGGCAAGGTGAACGTG

15. Transcribe the new sequence into mRNA sequence.

GUGCAUCUGACUCAUGAGGAUGAAGUCUGCCGUUACUGCCCUGUGGGGGCAAGGUGAACGUG

16. Translate into protein sequence

Val-His-Leu-Thr-His-Glu-Asp-Gly-Val-Cys-Arg-tyr-Cys-Pro-Val-Gly-Gln-Gly-Gly-Arg

17. Such mutation is frame shift which tends to change the entire framework.

Activity 4 (Page 464 of Student's Book)

The teacher should divide the class into group of four learners each.

Hint:

Just consider thin log as single chromosomes, assemble five different colours to represent as gene such as A, B, C, D and E.

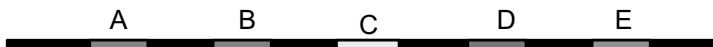

Break the thin log at two sites

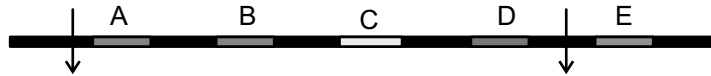

Reunion the broken parts in inverse manner.

The order of genes after reunion of fragments would be D-C-B-A-E. Its immediate effect is change in position.

Activity 5

The teacher should divide the class into group of four learners each

Hint:

1. In log, make 5 round shaped beads of red colour clay and number it 1 to 5.
2. Now consider the beads as gene and log as chromosome.
3. First in the log, try to change any bead. Break it by deleting some part of clay material from it; it will represent deletion from the gene which disrupts the entire structure of the gene.
4. Paste some extra clay to it. It will represent addition in the gene which disrupts the entire structure of the gene.
5. Replace the clay with same colour clay; it will represent substitution replacement with same or conservative mutation.
6. Replace the clay with different colour clay; it will represent substitution replacement with non-conservative mutation.
7. Note down your observation according to following table:

| | Effect on beads (Gene) | Effect on chromosome (log) |
|--|------------------------|--|
| Replacement with same colour clay | No effect | No effect |
| Replacement with different colour clay | Change in Gene | Only localised effect, entire log remains unaffected |
| Insertion | Change in Gene | Only localised effect, entire log remains unaffected |
| Deletion | Change in Gene | Only localised effect, entire log remains unaffected |

8. Now take the log, do the following changes
 - (a) cut the log.
 - (b) cut the log at two sites and paste it in opposite orientation.

- (c) Add the clay beads of same colour.
- (d) Add the clay beads of different colour.
- (e) Note down your observation according to following table:

| | Effect on beads (Gene): number | Effect on chromosome (log) : size |
|---|-----------------------------------|--------------------------------------|
| Cut the log (Deletion) | Deletion of genes | Size becomes small |
| Cut the log at two sites and paste in opposite manner (Inversion) | Position of genes change | Size remains unaffected |
| Add the beads of same colour (duplication) | Gene duplication | Size becomes bigger |
| Add the beads of different colours (translocation) | Position of genes change | Size remains unaffected |

Activity 6

The teacher should divide class into group of four learners each.

Hint:

1. The sample chart is given below, Patient is III-5, fifth person in generation-III in given pedigree.

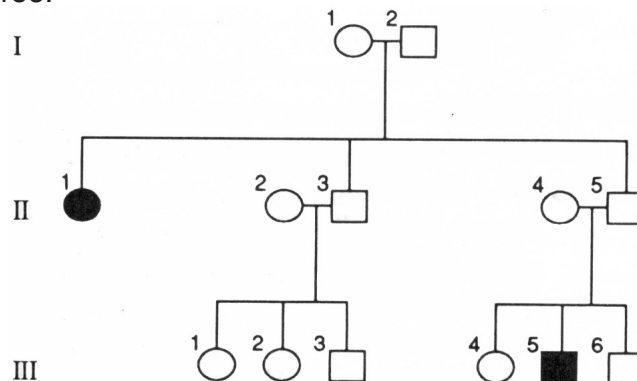

2. The notable points are: Observe the following points
 - Trait skips generation.
 - Affected person has unaffected parents.
 - Trait randomly happens in both the sexes.
3. The inheritance pattern is recessive autosomal.
4. Based on the effect of mutation on phenotype, tabulate effect of sickle cell anaemia on the affected offspring in comparison with offspring without disease.

| | |
|---|---|
| Offspring with Sickle Cell Anaemia | |
| Shape of RBC | Sickle shaped |
| Hb level | Very low |
| Flow in blood vessels | Blockage of small blood vessels leading to swelling of hands and feet |
| Effect on different organs | Tissue and organ damage |
| Overall physiology | Overall function gets disturbed leading to delayed growth |

18.11 ANSWERS TO SELF-EVALUATION

Self-evaluation

- (i) Silent, missense, nonsense
- (ii) Monosomy, trisomy
- (iii) Physical mutagen or chemical mutagens
- (iv) inversion

Self-evaluation

- (i) (a) valine is coded in place of glutamine
- (b) addition of CAG repeats
- (c) trisomy of chromosome number
- (d) DOPA is not converted to melanin.
- (ii) Rapid rate of mutation

18.12 ANSWER TO END UNIT ASSESSMENT 18

I. Choose whether the given statements are True (T) or False (F):

1. **True:** Mutations can broadly be categorized as somatic and germ-line, depending on whether mutation occurs in a somatic cell or gamete.
2. **False:** Whenever breaks occur in chromosomes, their structures change.
If a chromosome or set of chromosomes shows more than one break followed by reunion, chromosomal rearrangements are formed.

3. **True:** Induced mutation happens due to mutagens (agents that induce mutations). It can be physical mutagens or chemical mutagens.
4. **True:** Removal of amino group from a base is called deamination.
Deamination of cytosine produces uracil. As uracil is not a normal base for DNA, repair system can correct the change.
5. **True:** Albinism is caused by an autosomal recessive mutation. Tyrosine is converted to DOPA by the enzyme tyrosinase and DOPA is converted to melanin, the pigment which gives colour to the skin.
6. **True:** Haemophilia is of two types: haemophilia A and haemophilia B. Though both types occur due to a defect in blood clotting process, the two are a result of mutations in different genes.
7. **False:** It is the close interaction between genotype and environment that determines the phenotype shown by any individual.
8. **False;** Sickle cell anaemia is due to a recessive autosomal-linked allele. The effected individual must have both effected alleles to express the disease.
9. **False;** Mutagens are agents which cause change in DNA sequences. For example, radiations and chemicals.
10. **True;** Rapid rate of mutation in bacteria has helped them to evolve resistance not only to our immune system but also to various antibiotics. Thus, treatment against diseases caused by these microbial organisms is becoming increasingly difficult.

II. Multiple choice questions:

1. **(b)**
2. **(c);** Sickle cell anaemia results because of substitution mutation as there is replacement of A nucleotide with T nucleotides in the sixth codon of beta chain of haemoglobin resulting in change in aminoacid.
3. **(a);** Purine (adenine) replacement by purine (guanine) and pyrimidine replacement by pyrimidine is known as transition. Transversion is replacement of purine by pyrimidine. Frame shift mutation is insertion or deletion of nucleotides which tend to change the framework of nucleotides. Transcription is the process of formation of mRNA from DNA.
4. **(b);** UV rays are not ionizing radiation. Ionizing radiations are the ones which carry enough energy to penetrate and free the electrons from the molecules. X-rays, Cosmic rays and alpha rays are ionizing radiations.

5. **(a)**; as Nitrous acid can cause deamination of cytosine and adenine in the replicating as well as non-replicating DNA. Acridine dyes and bromouridine can effect only replicating DNA.
6. **(c)**; Although our phenotype is governed by our genotype, environment also plays a very important role. It is the close interaction between genotype and environment that determines the phenotype shown by any individual. This can be appreciated by many examples.
7. **(d)**; Duplication is a type of chromosome structure mutation as number of chromosome remains unaffected. Aneuploidy, polyploidy and trisomy are the types of chromosome number mutation.
8. **(c)**; Haemophilia is due to sex-linked recessive gene mutation while other diseases happen due to abnormality in chromosome number where more than one gene get effected.
9. **(d)**; Thymine dimers are caused by UV rays.
10. **(b)**; A mutation that causes the change in one amino acid with chemically similar amino acid is known as conservative mutation.

III. Long answer type questions:

1. Mutation is the sudden change in the genetic material of an individual. It occurs when a DNA gene is damaged or changed in such a way as to alter the genetic message carried by that gene. Several sudden mutations were observed, for example, Ancon sheep is a short legged variety which appeared suddenly in 1791 and hornless cattle developed from horned cattle in 1889.
2. There are two types of mutations. These are:
 - (i) Gene or point mutations
 - (ii) Chromosomal mutations
 - (i) Gene or point mutations:** Gene or point mutations involve single nucleotides and can occur by one of the following mechanisms:

Substitution is the replacement of one base by another. One purine replaced by another purine or pyrimidine replaced by another pyrimidine is called transition.

Silent mutation, when the triplet codon continues to code for the same amino acid because genetic code is degenerate, or the amino acid substituted has similar chemical property causing no change in the function of the protein or the change has occurred in non-coding region of DNA.

Missense mutation, when substitution of a base produces a codon that causes incorporation of a different amino acid. If the amino acid added is chemically similar to the original amino acid, it is called conservative missense mutation; but if the amino acid added is chemically dissimilar, it is called non-conservative missense mutation.

Nonsense mutation, when substitution of a base leads to the formation of a stop codon, terminating protein synthesis at that point. Polypeptide thus formed is incomplete and hence non-functional.

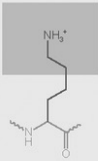
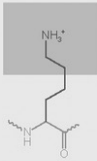
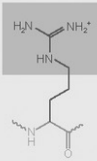
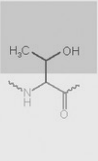
| | Point mutations | | | | |
|---------------|---|---|-------------|--|---|
| | No mutation | Silent | Nonsense | Missense | |
| | | | | conservative | non-conservative |
| DNA level | TTC | TTT | ATC | TCC | TGC |
| mRNA level | AAG | AAA | UAG | AGG | ACG |
| protein level | Lys | Lys | STOP | Arg | Thr |
| |  |  | |  |  |
| | | | | basic | polar |

Frame-shift mutation, here insertion or deletion of bases alters the reading frame of the genetic code which is comma-less, causing the different sequence of amino acids being coded from the point of mutation onwards.

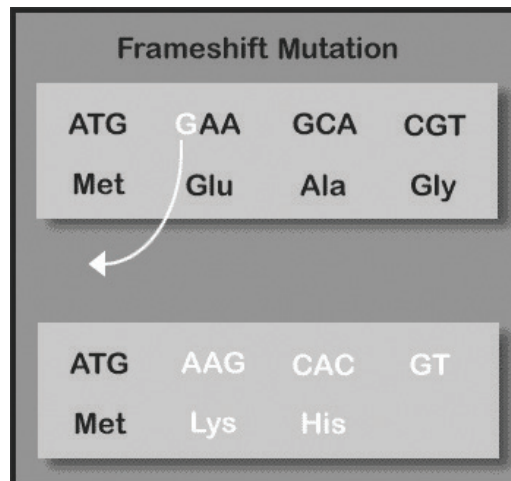

- (ii) **Chromosomal mutations:** Whenever breaks occur in chromosomes, their structures change. If a chromosome or set of chromosomes shows more than one break followed by reunion, chromosomal rearrangements are formed. If a break occurs in a chromosome followed by loss of the fragment, it is called deletion, resulting in loss of genetic information. On the other hand, if a segment occurs more than once, it results in gain of genetic information and is called duplication. If a chromosome breaks at two points and fuses again but in reverse order, there is no loss or gain of genetic information but it alters the sequence of genes in the chromosome and is called inversion.

Chromosomal Mutations

- Deletion
- Duplication
- Inversion
- Translocation

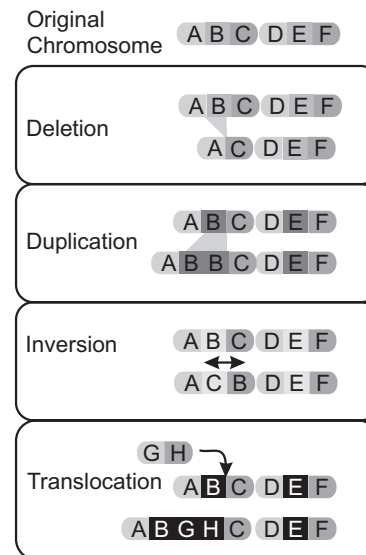

Causes of mutations

- (i) Random mutations can occur spontaneously due to chance as:
- (a) **DNA replication errors:** Normally each base exists in its more stable keto form and is responsible for the normal Watson-Crick base pairing of T with A and C with G. However, under certain physiological conditions, rare imino and enol forms (tautomers) of the bases are present, leading to altered base pairing affinities.

If by chance, there is looping out of DNA from the template strand, it may be missed by DNA polymerase, resulting in deletion mutation. Similarly, if additional, untemplated base is synthesised by DNA polymerase, addition mutation results.

(b) Spontaneous chemical changes include depurination and deamination: When bond breaks between the base and the deoxyribose sugar, purine is removed from the DNA, resulting in an apurinic site. Thousands of purines are lost in each mammalian cell cycle. If these apurinic sites are not repaired, DNA polymerase will not be able to add a complementary base and will dissociate from the DNA.

Removal of amino group from a base is called deamination. Deamination of cytosine produces uracil. As uracil is not a normal base for DNA, repair system can correct the change. However, if not corrected, adenine will pair up with uracil, ultimately, causing a change from C-G to T-A, a transition mutation.

DNA also contains small amounts of 5-methylcytosine (5mC) in place of normal base cytosine. Deamination of 5mC produces thymine, a normal base in DNA and hence not corrected. Therefore, 5mC results in C-G to T-A transitions.

(ii) Induced mutation happens due to mutagens (agents that induce mutations). It can be physical mutagens or chemical mutagens.

MUTAGENS

Physical Factors

High temperature
Various types of radiation
X-rays

UV radiation
Ionization radiation
(Alpha, beta and gamma
Cosmic radiation)

Chemical Factors

1. pH changes
2. Certain chemicals aflatoxin (produced by molds)
benzene
chloroform
pesticides
colchicine
ozone
some food additives (nitrites etc.)
mustard gas (nerve gas)

(a) Radiation: H. J. Muller was the first to show, in 1927, that mutation can be induced by X ray treatment. High energy rays collide with atoms and cause the release of electrons, leaving positively charged free radicals or ions. These ions, in turn, collide with other molecules, causing release of further electrons. Thus, as the rays pass through the tissue, they leave a core of ions along its entire track. This process of ionization can occur by background radiation or be induced by machine-produced X rays, protons, and neutrons, as well as by alpha, beta, and gamma

rays released by radioactive isotopes of the elements. Ultraviolet rays, though have less energy, can raise electrons in the outer orbitals to higher energy level called excitation. When molecules contain atoms either in ionic state or excited state, they become chemically less stable and thus more prone to change, making radiation as powerful mutagens. Energy of X rays can also cause physical breaks in chromosomes, thus resulting in the loss of chromosome segments or changes in chromosome structure (deletion, duplication, inversion, translocation).

Mutational effect of ultra violet (UV) radiation was demonstrated by Edgar Altenburg in 1928. UV rays are strongly absorbed by pyrimidines, especially thymine, leading to the formation of thymine dimers. Thymine dimers interfere with DNA replication and DNA repair mechanism, causing mutation in DNA.

The damage by radiation has been shown in Figure.

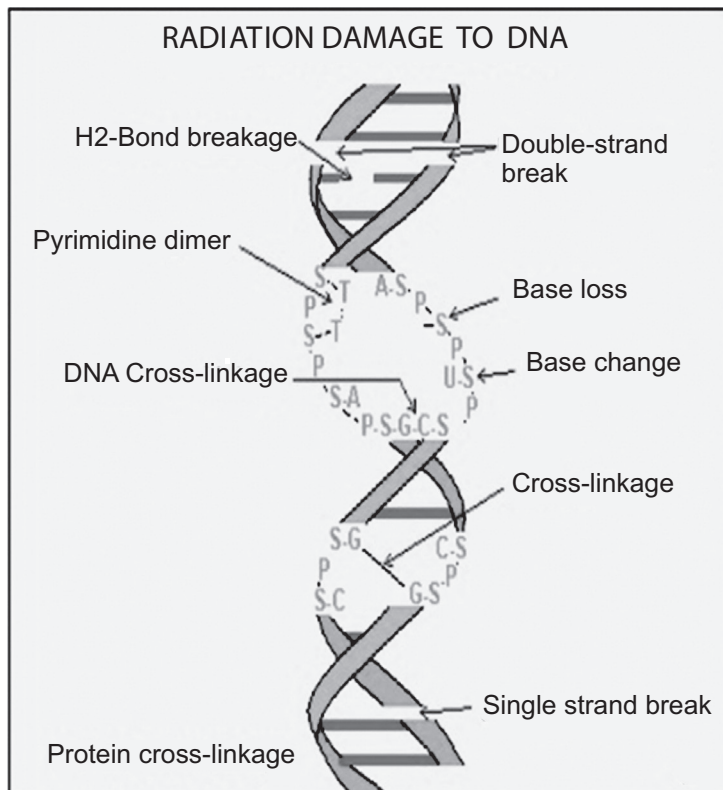

Physical Mutagens

Radiation was the first mutagenic agent known; its effects on genes were first reported in the 1920's.

Radiations are of two types.

- i. EM radiations
- ii. Ionizing radiations

Since radiation affects large segments of chromosome at the same time, a number of characters get altered simultaneously, but molecular details cannot be studied.

(b) **Chemical:** C. Auerbach first discovered the mutagenic effects of mustard gas and related compounds during World War II. Bhopal gas tragedy in India in December 1984 resulted in the death of 2500–6000 individuals, affecting adversely 200,000 people. Tragedy occurred with the release of methyl iso cyanate (MIC) in the form of gas and more than 21 chemicals in the MIC storage tank. A number of tests provided evidence that MIC is capable of inducing chromosomal damage.

People working in nickel and asbestos refineries, rubber industry, leather industry, coal tars, wood dust are routinely exposed to a number of mutagenic and potentially carcinogenic agents.

3. Significance of mutations

Although the term mutation was not used by Mendel, he was able to deduce that genetic characters are controlled by unit factors that exist in pairs in individual organisms and if two unlike unit factors exist in the same individual, one unit factor is dominant to the other, which is called recessive. Later studies revealed the true nature of these unit factors which are now called genes. As seen in the sections above, mutations have played very important roles as discussed below.

- (i) **Role in disease:** As studied in earlier sections, mutations have been responsible for a number of diseases such as sickle cell anaemia, haemophilia, Huntington disease, and albinism. Each individual has tumour suppressor genes and mutation in any of these genes can lead to the development of tumours.
- (ii) **Role in evolution:**
 - (a) Mutations play the most important role of creating new alleles. If there were no different alleles, all individuals would be homozygous at all loci. Presence of different alleles in individuals of a population is responsible for the diversity seen in any population. For example, blood group alleles IA, IB and IO. So mutation can bring about a change in genetic constitution of an organism. So mutations bring genetic polymorphism in population which may or may not lead to evolution.
 - (b) Furthermore, it has been observed that certain African countries show higher incidence of sickle cell allele as compared to other regions. Sickle cell allele somehow confers protection against malaria and hence occurs with higher frequency in those regions where malaria is prevalent. Individuals homozygous for sickle cell allele do not survive as oxygen transport to tissues is affected and individuals homozygous for the normal allele may suffer from malaria. Hence, mutant allele in this case happens to confer an advantage in the heterozygous condition.

- (c) Mutations have another very important consequence. Rapid rate of mutation in bacteria and viruses has helped them evolve resistance not only to our immune system but also to various antibiotics. Thus, treatment against diseases caused by these microbial organisms is becoming increasingly difficult.
- (iii) **Role in genetic research:** Humans have around 20,000 genes. Although scientists know the functions of a number of genes, vast majority of the genes have still not been assigned function. To study the function of a gene, researchers induce mutations in specific genes and look for possible effects. Thus, induced mutagenesis is helping us gain insight into genetics of cell cycle control points and hence the cells becoming cancerous. Cytogenetic studies have revealed a high degree of correlation between chromosomal rearrangements and leukaemias.
- (iv) **Mutations** play an important role in agriculture as well by providing diversity of alleles which may confer stress resistance, yield and regional adaptability.
4. (i) **Gene or point mutations:** Gene or point mutations involve single nucleotides and can occur by one of the following mechanisms:
- Substitution** is the replacement of one base by another. One purine replaced by another purine or pyrimidine replaced by another pyrimidine is called transition.
- Deletion:** Whenever breaks occur in chromosomes, their structures change. If a chromosome or set of chromosomes shows more than one break followed by reunion, chromosomal rearrangements are formed. If a break occurs in a chromosome followed by loss of the fragment, it is called deletion, resulting in loss of genetic information.
- Inversion:** On the other hand, if a segment occurs more than once, it results in gain of genetic information and is called duplication. If a chromosome breaks at two points and fuses again but in reverse order, there is no loss or gain of genetic information but it alters the sequence of genes in the chromosome and is called inversion.
- If breaks occur in non-homologous chromosomes, and the broken fragment from one joins another non-homologous chromosome, it results in translocation, altering linkage relationships.
- Whenever number of chromosomes gets changed, it results in numerical changes in chromosomes. It happens due to non-disjunction failure of homologous chromosomes to segregate at anaphase that leads to monosomy ($2n - 1$) and trisomy ($2n + 1$).

Effects of Mutations on Phenotypes

Spontaneous or induced mutagens cause changes in genotype which influence the phenotype.

The phenotype can be physiological, morphological, biochemical, anatomical etc. So let's think of effect of mutation on phenotype.

A gene represents the smallest unit that can code for protein. Gene is made up of DNA consisting of four nucleotides present in a particular sequence, which, when read in triplet codons, code for a particular amino acid sequence of a protein. Proteins play a number of important functions in the body, such as enzymes, hormones, structural etc. Whenever nucleotide sequence in DNA changes, it can lead to alteration in amino acid sequence affecting the function of the protein.

For example:

Albinism is caused by an autosomal recessive mutation. Tyrosine is converted to DOPA by the enzyme tyrosinase and DOPA is converted to melanin, the pigment which gives colour to the skin.



Melanin absorbs light in the ultraviolet (UV) range and protects the skin against UV radiation from the sun. If a mutation occurs in the gene responsible for production of tyrosinase, tyrosine cannot be converted to DOPA and melanin cannot be produced. Therefore, people with such a mutation have white skin, white hair and red eyes and are very sensitive to light.

Sickle-cell anaemia is a disease which is caused due to synthesis of abnormal haemoglobin, the protein present in red blood cells for transporting oxygen. This disease was first studied by J. Herrick, who found that red blood cells in patients suffering from the disease have the following characteristics:

- Lose their characteristic disc shape, become sickle-shaped whenever oxygen tension becomes low.
- Rupture very easily thus causing anaemia.

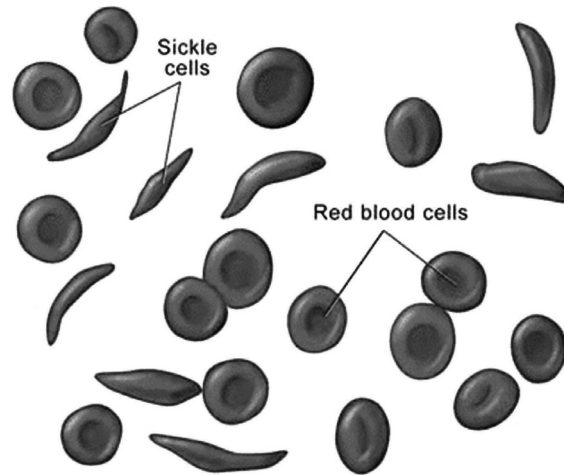

It has also been found that sickle cells don't easily squeeze through the capillaries as they are not flexible. This leads to blockage of capillaries, not letting blood flow into tissues depriving them of oxygen and ultimately causing tissue damage.

Thus, people suffering from sickle cell anaemia can have a number of health problems like heart failure, pneumonia, paralysis, kidney failure, abdominal pain, etc. Survival rate of such patients is very low. Disease occurs in a milder form and is known as sickle cell trait wherein patients shows some symptoms in areas of low oxygen tension but do survive.

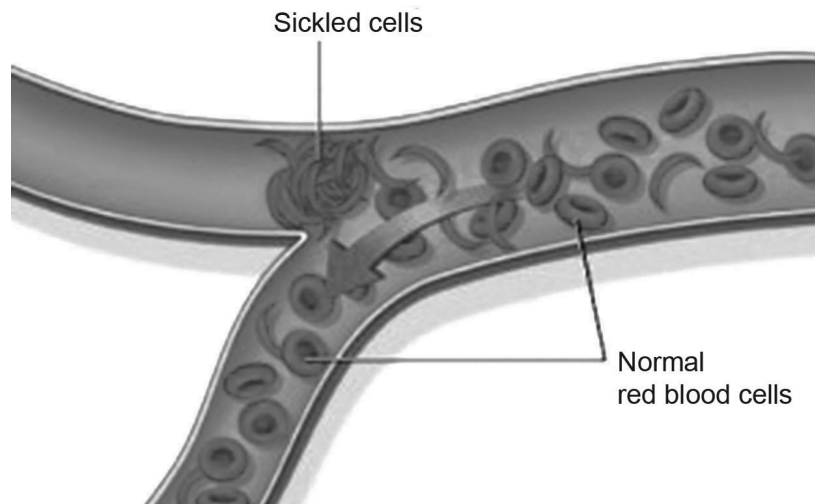

Haemophilia normally, we find that after minor injury or prick, bleeding automatically stops after a brief period. Excessive bleeding is prevented by the presence of clotting factors which work in a cascade-like fashion. However, there are individuals who continue to bleed for long periods of time even with minor bruises and may also show spontaneous bleeding. This bleeding disorder is called haemophilia. Haemophilia is of two types: haemophilia A and haemophilia B. Though both types occur due to a defect in blood clotting process, the two are a result of mutations in different genes. Haemophilia A (also called classical haemophilia) is more common, occurring with a frequency of 1 in 4000 males, and is due to deficiency of blood clotting factor VIII. Haemophilia B (also known as Christmas disease) is less common, occurring with a frequency of 1 in 20,000 males, and is due to deficiency of blood clotting factor IX. As the gene F8, coding for factor VIII and gene F9, coding for factor IX are present on X chromosome, a single copy of either of the mutant genes can cause this disorder in males whereas females will show the disorder only when homozygous for the mutant alleles. This accounts for the higher frequency of the disorder seen in males in the population.

Huntington disease: All individuals have Huntington gene which codes for huntington protein. Although it is synthesized by all cells, its critical function is seen in the brain where it interacts with other proteins in the nerve cells. Addition of CAG repeats in Huntington gene in excess of the normal number increases the number of glutamines in the protein, causing misfolding of the protein and a mutant phenotype. This protein accumulates in nerve cells, causing extensive damage. Symptoms include involuntary movements and progressive central nervous system degeneration. Although Huntington disease is found to be due to autosomal, dominant allele, expression of this allele begins only by the age of thirty years by which time the parents have already passed on the gene to their offspring.

5. It is not always true that phenotype is completely reflected by genotype. Although our phenotype is governed by our genotype, environment also plays a very important role. It is the close interaction between genotype and environment that determines the phenotype shown by any individual. This can be appreciated by the following examples.
 - (a) A person who has normal genes for making haemoglobin but lacks sufficient iron in the diet develops anaemia. Phenotype of this individual can be reversed by including sufficient iron in the diet.
 - (b) Individual with normal genes can make adequate amounts of thyroid hormone, thyroxine; yet, in the absence of sufficient dietary iodine, he may develop hypothyroidism.

- (c) Surrounding temperature can have an important influence on phenotype of individuals by affecting kinetic energy of reacting substances. Plant evening primrose shows red flowers when grown at 23°C and white flowers when grown at 18°C. Siamese cats and Himalayan rabbits show white fur on all parts except nose, ears and paws, as the wild type enzyme responsible for pigment production is functional at the lower temperature present in extremities, but it loses its catalytic activity at the slightly higher temperature found in the rest of the body.

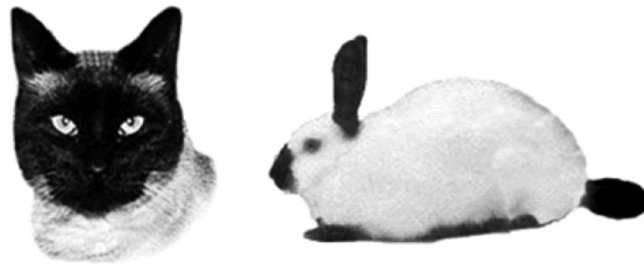

- (d) Individuals who are born with a deficiency of phenylalanine hydroxylase enzyme needed to convert phenylalanine to tyrosine, concentration of phenylalanine builds up in the body, especially in the brain causing neurological damage. Phenylalanine-free diet allows them to lead a nearly normal life, without showing the effects of mutation.
- (e) Every day, we are exposed to a large number of chemicals in our environment such as food additives, colouring agents in food items, textile dyes, cosmetics, pesticides, industrial compounds. Some of these chemicals have mutagenic effects, and can cause genetic diseases.
6. Albinism is caused by an autosomal recessive mutation. Tyrosine is converted to DOPA by the enzyme tyrosinase and DOPA is converted to melanin, the pigment which gives colour to the skin.

Melanin absorbs light in the ultraviolet (UV) range and protects the skin against UV radiation from the sun. If a mutation occurs in the gene responsible for production of tyrosinase, tyrosine cannot be converted to DOPA and melanin cannot be produced. Therefore, people with such a mutation have white skin, white hair and red eyes and are very sensitive to light.

Sickle-cell anaemia is a disease which is caused due to synthesis of abnormal haemoglobin, the protein present in red blood cells for transporting oxygen. This disease was first studied by J. Herrick, who found that red blood cells in patients suffering from the disease have the following characteristics:

- Lose their characteristic disc shape, become sickle-shaped whenever oxygen tension becomes low
- Rupture very easily thus causing anaemia.

It has also been found that sickle cells don't easily squeeze through the capillaries as they are not flexible. This leads to blockage of capillaries, not letting blood flow into tissues depriving them of oxygen and ultimately causing tissue damage.

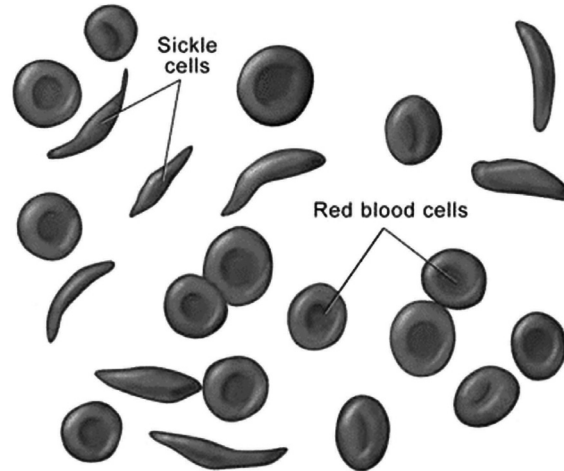

Haemophilia normally, we find that after minor injury or prick, bleeding automatically stops after a brief period. Excessive bleeding is prevented by the presence of clotting factors which work in a cascade-like fashion. However, there are individuals who continue to bleed for long periods of time even with minor bruises and may also show spontaneous bleeding. This bleeding disorder is called haemophilia. Haemophilia is of two types: haemophilia A and haemophilia B. Though both types occur due to a defect in blood clotting process, the two are a result of mutations in different genes.

Huntington disease: All individuals have Huntington gene which codes for huntingtin protein. Although it is synthesized by all cells, its critical function is seen in the brain where it interacts with other proteins in the nerve cells. Addition of CAG repeats in Huntington gene in excess of the normal number increases the number of glutamines in the protein, causing misfolding of the protein and a mutant phenotype. This protein accumulates in nerve cells, causing extensive damage. Symptoms include involuntary movements and progressive central nervous system degeneration. Although Huntington disease is found to be due

to autosomal, dominant allele, expression of this allele begins only by the age of thirty years by which time the parents have already passed on the gene to their offspring.

7. A **gene** represents the smallest unit that can code for protein. Gene is made up of DNA consisting of four nucleotides present in a particular sequence, which, when read in triplet codons, code for a particular amino acid sequence of a protein. Proteins play a number of important functions in the body, such as **enzymes**, hormones, structural etc. Whenever nucleotide sequence in DNA changes, it can lead to alteration in amino acid sequence affecting the function of the protein.

Albinism is caused by an autosomal recessive mutation. Tyrosine is converted to DOPA by the enzyme **tyrosinase** and DOPA is converted to melanin, the pigment which gives colour to the skin.

Melanin absorbs light in the ultraviolet (UV) range and protects the skin against UV radiation from the sun. If a mutation occurs in the gene responsible for production of tyrosinase, tyrosine cannot be converted to DOPA and melanin cannot be produced.

8. Work of L. Pauling showed that normal people made one type of protein haemoglobin, while people suffering from sickle cell anaemia had another type of haemoglobin and people with sickle cell trait had 1:1 mixture of two types of haemoglobins. Thus, it was hypothesized that people with sickle cell trait were heterozygous, carrying two different alleles and making two types of haemoglobins, Hb-A and Hb-S; normal people were homozygous and making one type of haemoglobin, Hb-A and people with sickle cell anaemia were homozygous, making one type of haemoglobin, Hb-S.

Haemoglobin consists of four polypeptide chains, two alpha and two beta, each of which is associated with a heme group to bind oxygen. V. M. Ingram on comparing the amino acid sequence of Hb-A and Hb-S found that while beta polypeptide of Hb-A had glutamic acid (with a negative electric charge) at the sixth position, beta polypeptide of Hb-S had valine (with no electric charge) at the same position. This substitution of amino acids causes the beta polypeptides to fold up in a different way causing sickling of red blood cells.

9. Gene mutation vs chromosome mutation

| | | | | | |
|---------|-------------|-------|-------|-------------|-------------------------|
| | Thr | Pro | Glu | Glu | beta ^A chain |
| | . . . A C T | C C T | G A G | G A G . . . | beta ^A gene |
| Codon # | 4 | 5 | 6 | 7 | |
| | . . . A C T | C C T | G T G | G A G . . . | beta ^S gene |
| | Thr | Pro | Yal | Glu | beta ^S chain |

| Gene mutation | Chromosome mutation |
|--|--|
| Change in nucleotide sequence in a single gene thus affecting functioning of a single gene | Change in either structure, gene arrangement or number of chromosomes thus affecting functioning of a number of genes at the same time |
| Leads to creation of new alleles Can sometimes be corrected | Leads to creation of altered karyotype Cannot be corrected |
| Can be either substitution or frame-shift mutation | Can be either deletion, duplication, inversion or translocation, or numerical changes |
| Example includes sickle cell anaemia, albinism | Example includes Turner's and Down syndrome |

10. Learners should attempt this question on their own.

18.13 ASSESSMENT METHODS

Use observation technique, question answer technique, and demonstration technique to assess the learners' achievement of learning objectives.

18.14 ASSESSMENTS

Formative Assessment

Fill in the blanks:

1. Lack of iron causes
2. Haemophilia occurs by substitution of single nucleotide in

Ans. 1. Anaemia, 2. Beta S chain in 6th amino acid.

Summative Assessment

Answer in one word:

1. An autosomal recessive disorder.
2. When substitution of a base leads to formation of stop codons.

Ans. 1. Albinism, 2. Nonsense mutation