

---

# **Mathematics**

**Senior 2  
Teacher's Guide**

---

© 2020 Rwanda Education Board (REB)

All rights reserved

This book is property of the Government of Rwanda.  
Credit must be given to REB when the content is quoted.

---

# Contents

Introduction.....	1
Preparation to teach and the teaching processes.....	13
Assessment and evaluation methods.....	31
Content Maps.....	35
<b>Unit 1: Indices and surds .....</b>	<b>46</b>
1.1 Indices.....	47
1.2 Standard form.....	52
1.3 Surds.....	53
Answers.....	58
<b>Unit 2: Polynomials.....</b>	<b>61</b>
2.1 Introduction to polynomials.....	62
2.2 Operations on polynomials .....	63
2.3 Identities.....	67
2.4 Quadratic identities .....	69
2.5 Perfect squares.....	72
Answers.....	73
<b>Unit 3: Simultaneous linear equation, Inequalities .....</b>	<b>79</b>
3.1 An equation in two variables .....	80
3.2 Solving simultaneous equations .....	81
3.3 Comparison method.....	85
3.4 Cramer's Rule.....	85
3.5 Forming and solving simultaneous equations.....	87
3.6 Inequalities .....	87
Answers.....	92
<b>Unit 4: Multiplier for proportional change .....</b>	<b>96</b>
4.1 Proportions .....	97
4.2 Expressing ratios in their simplest forms.....	98
4.3 Multiplier for proportional change .....	99
4.4 Calculation of proportional change using multiplier .....	100
Answers.....	100

<b>Unit 5: Thale’s theorem .....</b>	<b>102</b>
5.1 Midpoint theorem.....	103
5.2 Thale's theorem .....	105
5.3 The converse of Thale's theorem .....	106
Answers.....	107
<b>Unit 6: Pythagoras theorem.....</b>	<b>108</b>
6.1 Pythagoras’ theorem .....	109
6.2 Proof of Pythagoras' theorem .....	110
6.3 Pythagorean triples.....	111
6.4 Applying Pythagoras' theorem in real life situations .....	112
Answers.....	114
<b>Unit 7: Vectors .....</b>	<b>115</b>
7.1 Concept of a vector, definition and properties.....	116
7.2 Vectors in a Cartesian plane .....	117
7.3 Operations on vectors.....	119
7.4 Position vectors .....	121
7.5 Multiplication of a vector by a scalar .....	121
7.6 Magnitude of a vector.....	122
Answers.....	124
<b>Unit 8: Parallel and orthogonal projections.....</b>	<b>131</b>
8.1 Definition of parallel projection of a point on a line .....	133
8.2 Projections .....	133
8.3 Orthogonal projections .....	136
Answers.....	139
<b>Unit 9: Isometries.....</b>	<b>140</b>
9.1 Introduction to isometries .....	141
9.2 Central symmetry.....	141
9.3 Reflection .....	143
9.4 Reflection on the cartesian plane.....	143

9.5 Rotation.....	144
9.6 Locating an image given the object, centre and angle of rotation.....	146
9.7 Translation .....	147
9.8 Composite translation.....	148
Answers.....	150

**Unit 10: Statistics (Grouped data)..... 159**

10.1 Grouped data.....	160
10.2 Data presentation .....	161
10.3 Measure of central tendency .....	163
10.4 Reading and interpreting statistical graphs.....	164
Answers.....	165

**Unit 11: Tree and venn diagram..... 176**

11.1 Introduction .....	177
11.2 Tree diagrams and total number of outcomes .....	178
11.3 Determining probability using tree and Venn diagrams .....	179
11.4 Mutually exclusive events .....	181
11.5 Independent events .....	182
Answers.....	184



# PART 1

## SECTION 1: INTRODUCTION

### 1.1 Organization of the book

This teacher's guide is organised into two main sections. **Part 1** is the general introduction section detailing pedagogical issues.

The main elements of Part 1 are:

- **Section 1: Introduction-** it gives a brief overview of the structure of the syllabus, background to the new curriculum, rationale for teaching mathematics, types of competences and their acquisition, crosscutting issues to be addressed during learning, special needs education and inclusivity.
- **Section 2: Preparation for teaching and the teaching process-** it highlights the importance attitude necessary for effective teaching/learning of mathematics, philosophy of teaching mathematics, teaching/learning resources, teaching/learning methods and how to plan for teaching.
- **Section 3: Assessment and evaluation methods-** it gives an overview of types of assessment, record keeping and how to report the learners performance to parents.
- **Section 4: Content map:** it gives a brief highlight in tabular form how

each unit has addressed the various aspects required in the Senior 2 Mathematics Competence-based Curriculum

**Part 2** gives the details of the expected learning units as organised in the learner's book. The main elements of Part 2 are:

- **Unit heading** – this is accompanied by some text in the learner's book to motivate the learners. In addition, the total number of lessons per unit is given.
- **Key Unit Competence:** This is the competence which will be achieved once students have met all the learning objectives in the unit.
- **Outline of the main sections in the unit** – is a quick summary of the subtopics covered under the unit.
- **Learning Objectives:** The content in this area is broken down into three categories of learning objectives, that is, knowledge and understanding; skills; attitudes and values.
  - **Knowledge and understanding:** As in the existing curriculum, knowledge and understanding is very important.
  - **Skills:** It is through the skills that students apply their learning and engage in higher

order thinking. These skills relate to the upper levels of Bloom's taxonomy and they lead to deep rather than surface learning.

- **Attitudes and values:** Truly engaging with the learning requires appropriate attitudes and values that relate to the unit.
- **Links to other subjects:** It is important for learners to gain an understanding of the interconnections between different subjects so that learning in each subject is reinforced across the curriculum. This platform does exactly that. It prepares the teacher to pass this information to the learners so that they are aware!
- **Assessment Criteria:** This is meant to evaluate whether learners have succeeded in achieving the Key Unit Competence(s) intended. This section will help the teacher in assessing whether the unit objectives have been met.
- **Background information:** This is the introduction part of the unit. It aims at giving insights to the teacher on the subject matter.
- **Additional information for the teacher:** This section gives more information than what the syllabus recommends for purposes of preparing the teacher to answer tough questions from learners.

- **Learning Activities:** These are given per lesson and have these sub-sections:
  - Lesson titles.
  - Specific objectives of the lesson
  - Materials and learning resources.
  - Teaching guidelines.
  - Suggested teaching/learning approach.
  - Generic competencies covered.
  - Cross-cutting issues covered.
  - Special needs and multi-ability learning.
  - Formative assessment.
  - Extended exercises/activities for fast learners and remedial (reinforcement) exercises/activities for slow learners.
  - Answers to all exercises.

These are repeated across all lessons until the end of the unit followed by the answers or tips on the end of Unit Test questions.

## 1.2 The Structure of the syllabus

Mathematics subject is taught and learned at both at O and A-levels as a **core subject**. At every grade, the syllabus is structured in **Topic Areas**, and then further broken down into **Units**. The units have the following elements:

- Unit is aligned with the Number of Lessons.
- Each Unit has a Key Unit Competency whose achievement is



pursued by all teaching and learning activities undertaken by both the teacher and the learners.

- Each Unit Key Competency is broken into three types of Learning Objectives as follows:
  - *Type I*: Learning Objectives relating to knowledge and understanding. These are associated with Lower Order Thinking Skills or **LOTS**.
  - *Type II and Type III*: These learning objectives relate to acquisition of skills, Attitudes and Values. They are associated with Higher Order Thinking Skills or **HOTS**.
    - These learning objectives are actually considered to be the ones targeted by the present reviewed syllabus.
- Each unit has a content area which indicates the scope of coverage of what a teacher should teach and learner should learn in line with stated learning objectives.
- Each Unit suggests Learning Activities that are expected to engage learners in an interactive learning process as much as possible (learner-centered and participatory approach).
- Finally, each unit is linked to other subjects, its assessment criteria and the materials (or Resources) that are expected to be used in teaching and learning process.

In all, the mathematics syllabus for ordinary level Senior 2 has three Topic

Areas namely:

- Algebra (proportions reasoning)
- Geometry
- Statistics and probability.

The topic areas are subdivided into 11 units namely:

1. Indices and surds
2. Polynomials
3. Simultaneous linear equation, Inequalities
4. Multiplier for proportional change
5. Thale's theorem
6. Pythagoras' theorem
7. Vectors
8. Parallel and orthogonal projections
9. Isometries
10. Statistics (grouped data)
11. Tree and venn diagram and sample space

### 1.3 Background Information on new curriculum

The aim of a competence-based curriculum is to develop in the learners competences that will enable them interact with the environment in more practical ways.

It is against this background that the Mathematics syllabus for O level was reviewed to ensure that it is responsive to the needs of the learner with a shift from knowledge-based learning to competence-based learning.

Competence-based learning refers to systems of instruction, assessment, grading, and academic reporting that are based on students demonstrating that they have acquired and learned the prerequisite knowledge, skills and attitudes as they progress through their education. Apart from being integrative, the newly revised syllabus guides the interaction between the teacher and the learner in the learning process. It further puts greater emphasis on skills a learner should acquire during each unit of learning. As a competency-based syllabus, it elaborates on the three aspects of **knowledge, skills** and **attitudes** in mathematics.

## 1.4 Rationale of Teaching and Learning Mathematics

### Mathematics and Society

Mathematics plays an important role in society through abstraction and logic, counting, calculation, measurement, systematic study of shapes and motion. It is also used in natural sciences, engineering, medicine, finance, and social sciences. The applied mathematics like statistics and probability play an important role in game theory, in the national census process, in scientific research, etc. In addition, some cross-cutting issues such as financial awareness are incorporated into some of the mathematical units to improve social and economic welfare in Rwanda society.

Mathematics is key to the Rwandan education ambition of developing a

knowledge-based and technology-led economy since it provide to learners all required knowledge and skills to be used in different learning areas. Therefore, Mathematics is an important subject as it supports other subjects. This new curriculum will address gaps in the current Rwanda Education system that lacks appropriate skills and attitudes provided by the current education system.

## 1.5 Types of Competences and their acquisition

Competencies are statements of the characteristics that students should demonstrate which indicate they are prepared and have the ability to perform independently in professional practice. The two types of competencies envisaged in this curriculum are **basic** and **generic** competences.

### (a) Basic competences

Basic competences are addressed in the stated broad subject competences and in objectives highlighted year on year basis and in each of units of learning. They include:

#### **Literacy**

- Reading a variety of texts accurately and quickly.
- Expressing ideas, messages and events through writing legible texts in good hand-writing with correctly spelt words.
- Communicating ideas effectively through speaking using correct phonetics of words.
- Listening carefully for understanding

and seeking clarification when necessary.

### **Numeracy**

- Computing accurately using the four mathematical operations.
- Manipulating numbers, mathematical symbols, quantities, shapes, and figures to accomplish a task involving calculations, measurements, and estimations.
- Use numerical patterns and relationships to solve problems related to everyday activities like commercial context and financial management.
- Interpreting basic statistical data using tables, diagrams, charts, and graphs.

### **ICT and digital competences**

- Locating, extracting, recording and interpreting information from various sources.
- Assessing, retrieving and exchanging information via internet or cell phones.
- Using cell phones and internet for leisure and for money transactions.
- Using computer keyboard and mouse to write and store information.
- Using information and communication technologies to enhance learning and teaching (all subjects).

### **Citizenship and national identity**

- Relating the impact of historical events on past and present national and cultural identity.

- Understanding the historical and cultural roots of Rwandan society and how the local infrastructure functions in relation to the global environment.
- Demonstrating respect for cultural identities and expressing the role of the national language in social and cultural context.
- Advocating for the historical, cultural and geographical heritage of the nation within the global dimension.
- Showing national consciousness, a strong sense of belonging and patriotic spirit.
- Advocating for a harmonious and cohesive society and working with people from diverse cultural backgrounds.

### **Entrepreneurship and business development**

- Applying entrepreneurial attitudes and approaches to challenges and opportunities in school and in life.
- Understanding the obligations of the different parties involved in employment.
- Planning and managing micro projects and small and medium enterprises.
- Creation of employment and keeping proper books of accounts.
- Risk-taking in business ventures and in other initiatives.
- Evaluating resources needed for a business.

## **Science and technology**

- Apply scientific skills to solve practical problems encountered in everyday life including efficient and effective performance of a given task.
- Develop a sense of curiosity, inquisitiveness and research to explain theories, hypotheses and natural phenomena.
- Reason deductively and inductively in a logical way.
- Use experimentation to draw appropriate conclusions.

### **(b) Generic competences**

The generic competencies are competences that must be emphasized and reflected in the learning process. They are briefly described below and teachers must ensure that learners are engaged in tasks that help them to acquire the competences.

1. **Critical thinking and problem solving skills:** The acquisition of such skills will help learners to think imaginatively, innovatively and broadly and be able to evaluate and find solutions to problems encountered in their surroundings.
2. **Creativity and innovation:** The acquisition of such these skills will help learners to take initiatives and use imagination beyond knowledge provided in classroom to generate new ideas and construct new concepts.
3. **Research skills:** This will help learners to find answers to ques-

tions based on existing information and concepts and use it to explain phenomena from gathered information.

#### 4. **Communication in official languages:**

Teachers, irrespective of being language teachers should ensure the proper use of the language of instruction by learners (which is English at O- level). The teachers should communicate clearly and confidently and convey ideas effectively through spoken and written English by applying appropriate grammar and relevant vocabulary.

#### 5. **Cooperation, inter-personal management and life skills:**

This will help the learner to cooperate in a team in whatever task assigned and to practice positive ethical moral values and while respecting rights, feelings and views of others. Perform practical activities related to environmental conservation and protection. Advocate for personal, family and community health, hygiene and nutrition and responding creatively to a variety of challenges encountered in life.

6. **Lifelong learning:** The acquisition of such skills will help learners to update knowledge and skills with minimum external support. The learners will be able to cope with evolution of knowledge advances for personal fulfillment in areas that are relevant to their

improvement and development.

### **Broad mathematics competences**

During and at the end of learning process, the learner can:

1. Use correctly specific symbolism of the fundamental concepts in Mathematics.
2. Develop clear, logical, creative, and coherent thinking.
3. Apply acquired knowledge in Mathematics in solving problems encountered in everyday life.
4. Use the acquired concepts for easy adaptation in the study of other subjects.
5. Deduce correctly a given situation from a picture and / or a well-drawn out basic mathematical concepts and use them correctly in daily life situations.
6. Read and interpret a graph.
7. Use acquired mathematical skills to develop work spirit, team work, self-confidence and time management without supervision.
8. Use ICT tools to explore Mathematics (examples: calculators, computers, mathematical software).

### **Mathematics and developing competences**

The national policy documents based on national aspirations identify some 'basic Competencies' alongside the 'Generic Competencies' that will develop higher

order thinking skills and help student learn subject content and promote application of acquired knowledge and skills. Through observations, constructions, hand-on, using symbols, applying, and generalizing mathematical ideas and presentation of information during the learning process, the learner will not only develop deductive and inductive skills but also acquire cooperation and communication, critical thinking and problem solving skills. This will be realized when learners make presentations leading to inferences and conclusions at the end of learning unit. This will be achieved through learner group work and cooperative learning that in turn will promote interpersonal relations and teamwork.

The acquired knowledge in learning Mathematics should develop a responsible citizen who adapts to scientific reasoning and attitudes and develops confidence in reasoning independently. The learner should show concern of individual attitudes, environmental protection and comply with the scientific method of reasoning. The scientific method should be applied with the necessary rigour, intellectual honesty to promote critical thinking while systematically pursuing the line of thought.

### **1.6 Cross-cutting issues to be addressed during learning**

These emerging issues need to be incorporated in the learning process. Each of the cross-cutting issues has its own important programme of learning reflecting key national priorities. This

learning is integrated into the syllabuses of subjects across the curriculum rather than each issue having a dedicated timetable slot of its own. Because of this integration, the learning activities in the units of subjects across the curriculum incorporate all the learning associated with the cross-cutting issues. The eight cross-cutting issues are:

(a) ***Peace and Values Education***

The need for Peace and Values Education in the curriculum is obvious. Peace is clearly critical for society to flourish and for every individual to focus on personal achievement and his or her contribution to the success of the nation. Values education forms a key element of the strategy for ensuring young people recognize the importance of contributing to society, working for peace and harmony and being committed to avoiding conflict.

(b) ***Financial Education***

Financial education makes a strong contribution to the wider aims of education. It makes learning relevant to real life situations. It aims at a comprehensive financial education program as a precondition for achieving financial inclusion target and improves the financial capability of Rwandans. Financial education has a key role of not only improving knowledge of personal but also

transforming this knowledge into action. It provides the tools for sound money management practices on earnings, spending, saving, borrowing and investing. Financial education enables people to take appropriate financial services both formal and informal that are available to them and encourages financial behaviours that enhance their overall economic well-being.

(c) ***Standardization Culture***

Standardisation Culture develops learners' understanding of the importance of standards as a pillar of economic development and in the practices, activities, and lifestyle of the citizens. It is intended that the adoption of standardization culture should have an impact upon health improvement, economic growth, industrialization, trade, and general welfare of the people. While education is the foundation and strength of our nation, standards are one of the key pillars of sustainable economic development.

(d) ***Genocide Studies***

Genocide Studies provides young people with an understanding of the circumstances leading to the genocide and the remarkable story of recovery and re-establishing national unity. Genocide Studies helps

learners to comprehend the role of every individual in ensuring nothing of the sort ever happens again.

The intent of a cross-cutting curriculum around the topic of genocide is to fight against genocide, genocide denial, and genocide ideology; and to equip students with a more fundamental and comprehensive understanding of the genocide, thereby preventing further human rights violations in the future and enabling Rwanda's population of young people to more competently and thoughtfully enter the workforce. So, it needs to be emphasized.

(e) ***Environment and sustainability***

The growing awareness of the impact of the human race on the environment has led to recognition of the need to ensure our young people understand the importance of sustainability as they grow up and become responsible for the world around them. Hence, Environment and Sustainability is a very important cross-cutting issue. Learners need basic knowledge from the natural sciences, social sciences, and humanities to understand

and interpret principles of sustainability. They also need skills and attitudes that will enable them in their everyday life to address the environment and climate change issue and to have a sustainable livelihood.

(f) ***Gender education***

There is a strong moral imperative to accord every individual their basic human rights and gender inequality results in women and girls being treated less favourably than men. A strongly negative impact of unequal treatment, which affects the nation as a whole, is the fact that it results in women being held back and their talents and abilities not being fully realised. With a good understanding of the principles of Gender Equality, it is intended that future generations will ensure that the potential of the whole population is realised.

(g) ***Comprehensive sexuality education (HIV/AIDS, STI, Family planning, Gender equality and reproductive health)***

Comprehensive sexuality education, which is age appropriate, gender sensitive and life skills based can provide young people with the knowledge and skills to make informed decisions about their sexuality and

life style. Preparing children and young people for the transition to adulthood has been one of humanity's greatest challenges with human sexuality and relationships at its core. Few young people receive adequate preparations for their sexual lives. This leaves them potentially vulnerable to coercion, abuse and exploitation. Unintended pregnancy and sexually transmitted infections (STIs) including HIV/AIDS. Many young people approach adulthood faced with conflicting and confusing messages about sexuality and gender. This is often exacerbated by embarrassment, silence, disapproval and open discussion of sexual matters by adults (parents, teachers) at very time when it is most needed.

Comprehensive sexuality education supports a rights-based approach in which values such as respect, acceptance tolerance, equality, empathy and reciprocity are inextricably linked to universally agreed human rights. A clear message concerning these dangers and how they can be avoided, from right across the curriculum, is the best way to ensure that young people understand the risks and know how to stay healthy.

#### (h) **Inclusive Education**

Inclusive education involves ensuring all learners are engaged in education and that they are welcomed by other students so that everyone can achieve their potential. Inclusive practice embraces every individual regardless of gender or ability including those with learning difficulties and disabilities. The almost focus of inclusive curriculum is on ensuring participation in education of learners with different learning styles and other difficulties. To be successful, it entails a range of issues including teacher's positive attitudes, adapting the learning resources, differentiation of teaching and learning methods and working together. Overall, the benefits of an inclusive curriculum extend to all learners.

### **1.7 Special needs education and inclusivity**

All Rwandans have the right to access education regardless of their different needs. The underpinnings of this provision would naturally hold that all citizens benefit from the same menu of educational programs. The possibility of this assumption is the focus of special needs education. The critical issue is that we have persons/ learners who are very different in their ways of living and learning as opposed to the majority. The difference can either be emotional,



physical, sensory and intellectual learning challenges traditionally known as mental retardation. These learners equally have the right to benefit from the free and compulsory basic education in the nearby ordinary/mainstream schools. Therefore, the schools' role is to enrol them and set strategies to provide relevant education to them. The teacher therefore is requested to consider each learner's needs during teaching and learning process. Assessment strategies and conditions should also be standardised to the needs of these learners. Also, ensure that you include learners with special educational needs in classroom activities as much as possible.

The special needs children can fall in any of the following common categories:

- Physical difficulties
- Visual difficulties
- Hearing difficulties
- Mental difficulties
- Genocide traumatized learners

The teacher should identify such cases and help facilitate the affected learners learning. For example, learners with visual and hearing difficulties should sit near the teacher's table for easy supervision and assistance. The following are some suggestions on how to support special needs children in your class.

### ***(a) Learners with physical difficulties***

In this group of learners, the affected areas are normally some body parts,

especially the limbs. There may be partial or total loss of use of the limbs. In case the legs are affected, the learners will need assistance during activities that involve movement. This could be during a nature walk and other activities that learners have to stand for some reason. The teacher should organize for the learner's ease of movement around. The learner should also be given time to catch up with the others.

In case the hands are affected, the learners should be given more time to finish their work. In both cases, the learners should not be pressurized to do things that can cause injury or ridicule.

### ***(b) Learners with visual difficulties***

These learners normally have problems with their eyesight. They should sit in a position where they are able to see the chalkboard without straining

**Note:** The learner could be longsighted or short sighted.

The material to be observed should be brought to appropriate position where the learners can be able to see. The magnifying lens can be used where necessary. The teacher should use large diagrams, charts and labels. In some cases, the learners can be allowed to touch and feel whatever they are looking at. Other learners can assist by reading aloud. The lighting system in the classroom can also be improved.

The teacher should read aloud most of the things he/she writes on the chalkboard.

### **(c) Learners with hearing difficulties**

The affected part in this case is the ear. The learner should have **hearing aids**. The teacher should use as many visual aids as possible. They should also project their voice and always talk while facing the learners. Use of gestures and signs while talking helps the learner figure out what the teacher is saying as well.

### **(d) Learners with speech difficulties**

A common example in a normal class is the **stammerer**. They always speak with many difficulties. The teacher should be patient with them and encourage such learners to express themselves in their own way. Such learners should be given more written exercises.

### **(e) Learners with mental difficulties**

The teacher should try to identify the nature and level of the mental difficulty. Learners with mental difficulties should then be given special assistance and attention at an individual level. They can be given special tests or assessments. In general, all the learners with difficulties should be reinforced promptly. This

encourages and motivates them. The teacher and the rest of the class should never ridicule learners with any of the difficulties. Note that generally, people with any kind of disability can be very sensitive to any kind of negative comments or criticism.

*Remind them that ‘**Disability is not inability**’.*

The teacher should avoid giving privileges where the learners do not deserve them. Treat them fairly but not with undue favours. In extreme cases, it can be recommended for the learners to join a special school.

### **(f) Genocide traumatized learners**

Studies have shown that learners from families that were affected by genocide suffer post-traumatic stress disorder (PTSD). As such, they need to be treated as a special case. As a teacher, you need to be careful when dealing with such learners. In addition, the teacher needs to be in control especially when the topic under discussion touches on genocide issues. Any language that may elicit emotional reactions from learners either by fellow learners or by the teacher him or herself should be avoided.

## Section 2: Preparing to teach and the teaching process

### 2.1 Important attitudes in learning Mathematics

Attitude refers to the orientation of the mind with regard to a thing or a person. It determines one's behaviour or reaction to the thing or person. In a classroom situation, the attitudes of the teacher and the learners determine the level and effectiveness of the interactions between them, which in turn affect learning. Good attitudes in the learners and teachers is particularly important in the delivery of a competence based curriculum that require high level interactions and cooperation between learners, as they use discovery approach to acquire knowledge and competences, with the teacher as the facilitator.

The following is an overview of some of the learners and teachers attitudes that are necessary for effective teaching/learning of mathematics.

#### (a) In learners

There are certain useful attitudes, which the teacher should help develop in the learners as they carry out investigations in Mathematics. Mathematics as a problem solving discipline is expected to make an impact on a learner's general behaviour.

The nature of the scientific method demands learners to be honest with themselves as they record results and make unbiased conclusions. They should be aware of the danger involved in generalising out of limited information.

They should be open-minded and able to distinguish between propaganda and truth.

Some of the attitudes that learners should develop include:

- **Responsibility** – A learner should be responsible enough to effect tasks apportioned and take good care of apparatus during and after an investigation.
- **Cooperation** – Learners will often be working in groups while carrying out investigations and need therefore to cooperate with all other members of the group.
- **Curiosity** – Learners should have a curious attitude as they observe things and events around them. This is the first step towards solving a problem.
- **Self-confidence** – Learners should have the will to attempt to solve a problem. The feeling of self-confidence can be strengthened in young learners if they experience many small successes that win approval and encouragement from the teacher. The problems that learners attempt to solve should not be so difficult that they lead to frustration.
- **Honesty** – As they make observations, record, analyse results and draw conclusions.
- **Patience** – Learners should be patient for the results of an experiment

that may take time to manifest.

- **Practical approach** to problem solving. Learners should seek answers to their questions and problems by carrying out investigations wherever possible.

## (b) In Teachers

A good teacher should make the following capabilities:

- Engage students in variety of learning activities.
- Apply appropriate teaching and assessment methods.
- Adjust instructions to the level of the learner.
- Creativity and innovation.
- Makes connections/relations with other subjects.
- Show a high level of knowledge of the content.
- Develop effective discipline skills manage adequately the classroom
- Good communicator.
- Guide and counsellor.
- Passion for children teaching and learning.

## 2.2 Philosophy of teaching Mathematics

In the teaching of Mathematics, two definite approaches or techniques have been used. The first is the **passive traditional** approach also known as the **teacher centred approach** where the teacher is the central figure around whom all other things revolve. In this setup, the teacher talks and issues command. The learners sit and listen.

The teacher treats the learners like an 'empty pot' waiting for information to be poured into it. A small amount may enter, some will stay in while the rest evaporates. The teacher-centred approach does not support competence curriculum implementation. In the second approach, which we call the dynamic or **activity-oriented** approach and which is being advocated for, the learners are active participants in the learning process. They are the doers and the materials and apparatus they work with are the tellers. The teacher's role is that of a guide and facilitator in the learning process. Mathematics is a practical subject and learners understand it best by doing.

## (a) Learner's role in learning Mathematics

Learning takes place only when the learner has internally digested and assimilated the material to be learnt. As such, learning is a highly personal and individual process. It therefore means that a learner must be actively engaged in the learning exercise.

For active participation in learning, the learner must:

- a. Develop the curiosity, powers of observation and enquiry by exploring the local environment.
- b. Raise questions about what is observed.
- c. Suggest solutions to those questions and carry out investigations to search for answers.
- d. Manipulate a variety of materials in

search of patterns and relationships while looking for solutions to problems.

The competence-based approach considers the learning process to involve the construction of meaning by learners. Simply, it emphasizes the need for children to think about mathematical activity in order to make sense of and understand the mathematics concepts being introduced. In this new dispensation, learners are in the driver's seat, which implies they will construct their knowledge by posing questions, planning investigation, conducting their own experiments, analysing and communicating results. More specifically, when engaging in inquiry, learners will describe objects and events, ask questions, construct explanations, test those explanations against current knowledge, and communicate their ideas to others. By so doing, the learners will take ownership of the learning process.

Learners' activities are indicated against each learning unit reflecting their appropriate engagement in the learning process. Even though they do not necessarily take place simultaneously in each and every Mathematics lesson and for all levels, over time learners get involved in the following activities:

- Observing and where possible, handling and manipulating real objects.
- Pursuing questions which they have identified as their own even if introduced by the teacher;
- Taking part in planning investigations with appropriate controls to answer

specific questions.

- Using and developing skills of gathering data directly by observation or measurement and by using secondary sources.
- Using and developing skills of organizing and interpreting data, reasoning, proposing explanations, making predictions based on what they think or find out.
- Working collaboratively with others, communicating their own ideas and considering others' ideas.
- Expressing themselves using appropriate mathematical terms and representations in writing and talk.
- Engaging in lively public discussions in defense of their work and explanations.
- Applying their learning in real-life contexts.
- Reflecting self-critically about the processes and outcomes of their inquiries.

During this reciprocal interaction, what learners will acquire is not only content knowledge, but a number of skills including how to approach a problem, identify important resources, design and carry out hands-on investigations, analyze and interpret data, and, perhaps most importantly, recognize when they have answered the question or solved the problem.

### **(b) Teacher's role in learning and teaching**

The teacher is one of the most important resources in the classroom. The

teacher's role is central to the successful implementation of the learning programme in the school. The role of the teacher will remain critical however, instead of being the "sage on the stage", the teacher will rather be "**the guide on the side**" who acts as facilitator in a variety of ways which include:

- Encouraging and accepting student autonomy and initiative.
- Using raw data and primary sources, along with manipulative, interactive, and physical materials.
- Using cognitive terminology such as classify, analyse, predict, and create when framing tasks.
- Allowing student responses to drive lessons, shift instructional strategies, and alter content.
- Familiarizing themselves with students' understandings of concepts before sharing their own understandings of those concepts.
- Encouraging students to engage in dialogue, both with the teacher and one another.
- Engaging students in experiences that pose contradictions to their initial hypotheses and then encouraging discussion.
- Providing time for students to construct relationships and create metaphors.
- Nurturing students' natural curiosity.
- Organising the classroom to create a suitable learning environment.
- Preparing appropriate materials for

learning activities.

- Motivating learners to make them ready for learning.
- Coordinate learners' activities so that the desired objectives can be achieved.
- Assessing learners' activities and suggest solutions to their problems.
- Assist learners to consolidate their activities by summarising the key points learnt.

From time to time, the teacher should interact with the learners individually or in groups to diagnose their weaknesses and frustrations, appraise their efforts, imagination and excitement. This will assist and guide them in the task of learning. The teacher must make an effort to teach learners how to team up but still have each learner directly involved in working with materials, consulting with the teacher and with fellow learners. Remember that whatever you do during the class, the interests of the learner remain paramount! Therefore the teacher should allow and encourage the learners to:

- Explore their local environment.
- Ask questions about things and events.
- Make observations.
- Perform simple investigations research and experiments to seek answers to their questions.
- Talk to each other and to the other learners about their experiences, interests, problems, successes and even frustrations.
- Play and make models of things

that interest them.

There is no doubt that scientific knowledge is increasing at such a rapid rate that it is impossible for any teacher to teach, or any child to learn, all the information available on any particular topic, within the time allocated. As an alternative, we should take on a strategy that is practical and time saving. It involves equipping the learners with skills, which they can use to find out information, and solutions to problems in Mathematics and in their daily lives. We therefore advocate the teaching of Mathematics as a process, combined with providing basic Mathematical facts, which are appropriate in content to the age and stage of mental development of children under your charge. The mathematical skills that the teacher must endeavor to introduce and promote in his /her learners include:

*observing, comparing, classifying (sorting), recording, predicting, experimenting, measuring, controlling variables, collecting data, recognizing patterns and relationships, analysing and interpreting data, making conclusions (inferring) and communicating.*

These skills, used in conjunction with the introduction of basic mathematical facts will form a firm foundation that learners can build more as they learn both inside and outside of school.

Education at school is about children learning. The process of organizing learners' learning to achieve the aims and objectives of the curriculum involves bringing together the needs and characteristics of the learners. To do this, the skills, knowledge and experience

of the teacher are all required within a given situation.

## 2.3 Teaching resources

These refer to things that the teacher requires during the teaching process. They include:

- The classroom.
- Textbooks.
- Wall charts and wall maps.
- Materials and apparatus.
- Various tools and equipment.
- Mathematical models.
- Resource persons.
- Social facilities such as health centres, other learning institutions, community organisations, etc.
- Enterprises such as agricultural farms, industries, among others.

### (a) Classroom as a learning environment

Classroom generally refers to the place where learning takes place. Learners learn from everything that happens around them, such as the things that they hear, see, touch, taste, smell and play with. It is therefore important for the teacher to make his classroom an attractive and stimulating environment. This can be done by:

- Carefully arranging the furniture and desks.
- Putting up learning and teaching aids on the walls. Examples are wall charts or pictures or photographs.
- Displaying models.
- Providing objects for play for example toys.
- Having a display corner in the

classroom where learners display their work.

- Securing a storage area.

The materials in the classroom should get the learners thinking and asking questions about what is around them and encourage them to do worthwhile activities.

### ***Classroom organization***

A well organised classroom is an asset to good Mathematics teaching but there is no one correct style to suit all classrooms and situations. However, the teacher should consider the following factors when organising the classroom:

- a. Furniture should be well arranged so as to allow free movement of learners and the teacher.
- b. Set a corner for storing materials so as not to obstruct learners or distract them.
- c. The number of learners in the class and their ages.
- d. Learners should be reasonably spread out so that they do not interfere with one another's activities.
- e. The series of lessons or activities going on for a number of days or weeks such as individual or group work or whole class.
- f. Classroom itself, that is, positions of windows, doors such that learners face the lighted areas of the room.
- g. Personal preferences. But these should be in the interest of the learners especially where you normally stand, you should be able

to communicate with all learners, and also have a general view of all learners in the class.

### ***Grouping learners for learning***

Most of the Mathematical activities are carried out in groups and therefore the teacher should place 2 or 3 desks against each other and then have a group of learners sitting around those desks.

In certain activities, the teacher may wish to carry out a demonstration. In this case, the learners should be sitting or standing in a semicircle, or arranged around an empty shape of letter "U" such that each learner can see what the teacher is doing clearly and without obstruction or pushing. If the learners are involved in individual work, each learner can work on the floor or on the desk or a portion of the desk if they are sharing. In this case, they need not face each other.

Grouping learners for learning has increasingly become popular in recent years. In fact, the shift from knowledge-based to competence curriculum will make grouping the norm in the teaching process. Grouping learners can be informed by one or all of the following:

- a. Similar ability grouping.
- b. Mixed ability grouping.
- c. Similar interests grouping.
- d. Needs grouping.
- e. Friendship grouping.
- f. Sex grouping.

Grouping learners in a mathematics class has several advantages that



includes:

- a. The individual learner's progress and needs can easily be observed.
- b. The teacher-learner relationship is enhanced.
- c. A teacher can easily attend to the needs and problems of a small group.
- d. Materials that were inadequate for individual work can now easily be shared.
- e. Learners can learn from one another.
- f. Cooperation among learners can easily be developed.
- g. Many learners accept correction from the teacher more readily and without feeling humiliated when they are in a small group rather than the whole class.
- h. Learners' creativity, responsibility and leadership skills can easily be developed.
- i. Learners can work at their own pace.

The type of "grouping" that a teacher may choose depends on:

- a. The topic or task to be tackled.
- b. The materials available.
- c. Ability of learners in the class (fast, average, slow).

However, the teacher must be flexible enough to adjust or change his/her type of grouping to cope with new situations.

There is no fixed number of learners that a group must have. This again will be dictated by such factors as the task to be done, the materials, characteristics

of learners in your class, size and the space available. However, groups should on average have between **four to five learners**. You can also resort to pair work depending on the nature of the content being taught at the time.

There is no one method or approach to teaching that is appropriate to all lessons. A teacher should, therefore, choose wisely the method to use or a combination of methods depending on the nature of the topic or subtopic at hand.

### **(b) Apparatus and materials**

For learners to study mathematics through the activity method, a number of materials and apparatus are required. The important role played by materials in learning has been felt for centuries. This is noted for instance in the old Chinese proverb that says:

- *What I hear I forget*
- *When I see I remember*
- *When I do I understand*

Since Mathematics is largely a practical subject, materials help the teacher to convey his/ her points, information or develop skills, simply and clearly, and to achieve desired results much faster.

Most of the materials that a teacher requires for Mathematical activities and calculations can be collected from the local environment.

Many others can be improvised while some will have to be purchased. Whether collected, improvised or purchased, there are certain materials that are valuable to have around almost

all the time. These include:

- **Tools:** Knife, hammer, chisel, screwdriver, saw, magnifiers, machetes, strings, cloth, scissors, paper glue etc.
- **Containers:** Tins, gourds, bottles, coconut shells, jars, shells, calabashes a cartons etc.
- **Powders:** Salt, sugar, flour, soap, powder, ash etc.
- **Liquids:** Water, kerosene, methylated spirit, used engine oil, cooking oil, ink etc.
- **Colors:** for example, from flowers, leaves roots and stems, charcoal and chalk.
- **Soils:** Clay, loam, sand and gravel.

Others include pieces of wood and sticks of various sizes, wires, ropes, nails, pins, thorns, grass stalks, growing plants like peas, beans, maize, seeds and cuttings of various plants.

The teacher should organise a place within the school for the proper storage of mathematical materials and in labelled boxes.

Encourage learners to collect and bring as many materials and apparatus to the school as they can. This will continuously replenish your materials and apparatus collection.

### **Improvisation**

If each learner is to have, a chance of experimenting, cheap resources must be made available. Expensive, complicated apparatus may not always be available in most schools. Such sophisticated equipment made by commercial manufacturers are usually expensive and majority of schools cannot afford

them. The teacher is therefore advised to improvise using locally available materials as much as possible.

### **Timing of topics and the local weather pattern**

The collection of mathematical data in handling topics like probability and statistics are done at particular specific weather condition than at other times. For example, when collecting data on different makes of vehicles that pass through a particular route, the weather and other physical conditions must be put constant and into consideration for accuracy and to avoid biasness. Certain insects appear only during the dry weather while others emerge with the onset of the rains. Nature walks and visits are best done when the weather is sunny and dry. The teacher should therefore think ahead while making the scheme of work so that the prevailing weather pattern is considered. This will ensure that suitable activities for learning mathematics are planned for with the weather in mind.

However, a good scheme of work should be sufficiently flexible to cope with unexpected situations and can be altered or modified to suit certain circumstances.

### **(c) Mathematical Kit**

A Mathematical kit is a special box containing materials, apparatus, and equipment necessary to conduct any mathematical operations and the performance of specific tasks. The content of the mathematical kit depends on the curriculum requirements per level. Most Mathematical kits are commercially available and target particular levels of learners. However,

the teacher is encouraged to come up with a kit based on the specific unit and syllabus requirements.

Some of the materials within a mathematical kit includes:

- Dice
- Playing cards
- Blackboard; - ruler, Set square, Divider, Compass
- Meter rule
- Calculator
- Number cards etc.

### **Mathematical set**

It is important for every learner to have a mathematical set containing at least; protractor, compass, set squares, rulers, divider, pencil, sharpener and eraser. The learner needs these materials especially during mathematical and geometrical constructions.

#### **(e) Resource persons**

A resource person refers to anybody with better knowledge on a given topic area. Examples include health practitioners such as doctors, nurses and laboratory technologists, agricultural extension officers, environmental specialists among others. Depending on the topic under discussion, the teacher can organize to invite a resource person in that area to talk to learners about the topic. The learners should be encouraged to ask as many questions as possible to help clarify areas where they have problems.

#### **(f) Models**

A model refers to a three-dimensional representation of an object and is usually much smaller than the object. Several models are available commercially in shops. Examples include model of the

heart, skin, lungs, eye, and ears, among others. These can be purchased by schools for use during mathematical operations.

## **2.5 Teaching methods**

There is a variety of possible ways in which a teacher can help the learners to learn. These include :

- (a) Direct exposition
- (b) Discovery or practical activity
- (c) Group, class or pair discussion
- (d) Project method
- (e) Educational visit/ field trips
- (f) Teacher demonstration
- (g) Experimentation/ Research

The particular technique that a teacher may choose to use is influenced by several factors such as:

- The particular group of learners in the class.
- The skills, attitudes and knowledge to be learned.
- Learning and teaching aids available. The local environment.
- The teacher's personal preference.
- The prevailing weather.
- The requirements of mathematical syllabus.

#### **(a) Direct exposition**

This is the traditional way of teaching whereby the teacher explains something while the learners listen. After the teacher has finished, the learners may ask questions. However, remember that in competence-based curriculum, this technique should be used very minimally.

#### **(b) Guided Discovery**

In this technique, the teacher encourages learners to find out answers to problems

by themselves. The teacher does this by:

- Giving learners specific tasks to do.
- Giving learners materials to work with.
- Asking structured or guided questions that lead learners to the desired outcome.

Sometimes learners are given a problem to solve and then left to work in an open-ended manner until they find out for themselves.

With the introduction of the new curriculum, this is the preferred method of teaching.

### **(c) Group or class discussion or pair work**

In this technique, the teacher and learners interact through question and answer sessions most of the time. The teacher carefully selects his questions so that learners are prompted to think and express their ideas freely, but along a desired line of thought. Discussion method should take learners from known to unknown in a logical sequence; and works well with small groups of learners. The disadvantage of this method is that some learners maybe shy or afraid to air their opinions freely in front of the teacher or their peers. This may give them more confident learners a chance to dominate the others. However, the method should be embraced as it intends to eliminate the lack of confidence in learners. Further, it is hoped that it will help improve interpersonal and communication skills in learners.

### **(d) Project method**

In this approach, the teacher organizes and guides a group of learners or the whole class to undertake a

comprehensive study of something in real life over a period of time such as a week or several weeks.

Learners using the project method of studying encounter real life problems which cannot be realistically brought into a normal classroom situation. A project captures learners' enthusiasm, stimulates their initiative and encourages independent enquiry. The teacher, using the project method, must ensure that the learners understand the problem to be solved and then provides them with the necessary materials and guidance to enable them carry out the study.

#### *Disadvantages*

If a project is not closely supervised, learners easily get distracted and therefore lose track of the main objective of their study. Studying by the project method does not work well with learners who have little or no initiative.

### **(e) Educational visits and trips/ nature walks**

This is a lesson conducted outside the school compound during which a teacher and the learners visit a place relevant to their topic of study. An educational visit/nature walk enables learners to view their surroundings with a broader outlook that cannot be acquired in a classroom setting. It also allows them to learn practically through first-hand experience. In all "educational visit/nature walk lessons", learners are likely to be highly motivated and the teacher should exploit this in ensuring effective learning. However, educational visits are time consuming and require a lot of prior preparation for them to succeed. They can also be expensive to undertake especially when learners have to travel

far from the school.

### **(f) Demonstration lessons**

In a demonstration, the teacher shows the learners an experiment, an activity or a procedure to be followed when investigating or explaining a particular problem. The learners gather around the teacher where each learner can observe what the teacher is doing. It is necessary to involve the learners in a demonstration, for example by:

- Asking a few learners to assist you in setting up the activity.
- Requesting them to make observations.
- Asking them questions as you progress with the demonstration.

This will help to prevent the demonstration from becoming too teacher-centred.

### **When is a demonstration necessary?**

A teacher may have to use a demonstration, for example when:

- The experiment/procedure is too advanced for learners to perform.
- The experiment/ procedure is dangerous.
- The apparatus and materials involved are delicate for learners to handle.
- Apparatus and equipment are too few.

## **2.6 Planning to teach**

The two most important documents in planning to teach are the schemes of work and the lesson plan.

### **(a) Schemes of work**

A scheme of work is a collection of related units and subunits drawn from the syllabus and organized into lessons week by week for every term. It is also a forecast or plan that shows details under these sub-headings:

#### **Date**

Refers to the date of the day when the lesson will be taught.

#### **Week**

Refers to the week in the term e.g. 1, 2, 3, etc.

#### **Unit title**

This specifies the title of the unit from which the lesson is derived.

#### **Lesson title and evaluation**

Refers to the lesson being taught in that week e.g. lesson 1, 2, 3 and 4, etc, and the type of evaluation to be carried out.

#### **Learning Objectives**

Specifies what learners are expected to achieve at the end of the lesson.

#### **Teaching methods, and techniques and evaluation procedures**

Indicates the methods and techniques to used in the teaching/learning process and how evaluate.

#### **Learning resources and references**

*Resources* refers to any materials that will be used by the learner and the teacher for learning and teaching.

*References* are books or other materials that will be consulted or used in the teaching process. Books that learners will use should also be shown here; indicating the actual pages.

#### **Observations**

This should be a brief report on the progress of the lesson planned in the scheme of work. Such reports could include 'taught as planned'. 'Not taught due to abrupt visit by County Director of Education.' 'Children did not follow the lesson, it will be repeated on... (Specific date).

The following is a sample of the scheme of work.

## Unit Plan/Scheme of work

**Academic Year:** 2017  
**Subject:** Mathematics

**Term:** 1  
**Teacher's Name:** Mr. Alexie

**School:** Kigali Senior School  
**Class:** Senior 2

**Number of period per week:** 6

Dates	Unit title	Lesson title and evaluation	Learning objectives (copied or adapted from the syllabus depending on the bunch of lesson) + Key unit competence	Teaching methods & techniques and evaluation procedures	Resources & References	Observations
Week 1 Sept 4 <sup>th</sup> to 8 <sup>th</sup> 2017	<b>Unit 8:</b> Parallel and Orthogonal projections	<b>Lesson 1:</b> Definition of parallel projection <b>(1 periods)</b>	<p><b>Knowledge and Understanding:</b></p> <ul style="list-style-type: none"> <li>Define parallel projection</li> </ul> <p><b>Skills:</b></p> <ul style="list-style-type: none"> <li>Constructing parallel projections of points on a given line.</li> </ul> <p><b>Attitudes and Values:</b></p> <ul style="list-style-type: none"> <li>Show the importance of parallel projection in various situations.</li> </ul>	<ul style="list-style-type: none"> <li>Guided discovery</li> <li>Individual work</li> <li>Pair work</li> <li>Class discussions</li> <li>Presentations</li> <li><b>Practical activities</b></li> </ul> <p>Question and answer</p>	<p>Rulers, pencils rubbers, mirror, pair of compasses Manila paper</p> <p>Mathematics for Rwanda Schools Students Book 2 Page 139 - 141</p> <p>Mathematics for Rwanda Schools Teacher's Guide 2 Page - -----</p>	<p>Comment on the effectiveness of the teaching process based on your evaluation of the lesson. For example, a few learners had challenges drawing perfect parallel lines. They were given more practice exercise as homework – I will assess and discuss it with them assessed before the next lesson.</p>
	<b>Lesson 2:</b> Properties of parallel projection <b>(1 period)</b>		<p><b>Knowledge and Understanding:</b></p> <ul style="list-style-type: none"> <li>Identify properties of parallel projection.</li> </ul> <p><b>Skills:</b></p> <ul style="list-style-type: none"> <li>Constructing parallel projections of points on a given line.</li> </ul> <p><b>Attitudes and Values:</b></p> <p>Be accurate in constructing images of objects under parallel projection.</p>	<ul style="list-style-type: none"> <li>Guided discovery</li> <li>Individual work</li> <li>Pair work</li> <li>Class discussions</li> <li>Presentations</li> <li>Practical activities</li> <li>Question and answer</li> </ul>	<p>Rulers, pencils rubbers, mirror, pair of compasses Manila paper</p> <p>Mathematics for Rwanda Schools Students Book 2 Page 139 - 141</p> <p>Mathematics for Rwanda Schools Teacher's Guide 2 Page - -----</p>	

				<p><b>Lesson 3:</b> Parallel projection of a line segment on a line <b>(2 period)</b></p>	<p><b>Knowledge and Understanding:</b></p> <ul style="list-style-type: none"> <li>Identify the image of figures under parallel projection.</li> </ul> <p><b>Skills:</b></p> <ul style="list-style-type: none"> <li>Construct the parallel projection of a line segment on a line.</li> </ul> <p><b>Attitudes and Values:</b></p> <p>Be accurate in constructing the parallel projection of a line segment on a line.</p>	<ul style="list-style-type: none"> <li>Guided discovery</li> <li>Individual work</li> <li>Pair work</li> <li>Class discussions</li> <li>Presentations</li> <li>Practical activities</li> <li>Question and answer</li> </ul>	<p>Rulers, pencils rubbers, mirror, pair of compasses Manila paper</p> <p>Mathematics for Rwanda Schools Students Book 2 Page 139 - 141</p> <p>Mathematics for Rwanda Schools Teacher's Guide 2 Page - -----</p>	
			<p><b>Lesson 4:</b> Parallel projection of geometrical figures on a line <b>(2 periods)</b></p>	<p><b>Knowledge and Understanding:</b></p> <ul style="list-style-type: none"> <li>Identify the image of figures under parallel projection.</li> </ul> <p><b>Skills:</b></p> <ul style="list-style-type: none"> <li>Construct the parallel projection of geometrical figures on a line.</li> </ul> <p><b>Attitudes and Values:</b></p> <ul style="list-style-type: none"> <li>Be accurate in constructing the parallel projection of geometrical figures on a line.</li> </ul> <p>Show the importance of parallel projection in various situations.</p>	<ul style="list-style-type: none"> <li>Guided discovery</li> <li>Individual work</li> <li>Pair work</li> <li>Class discussions</li> <li>Presentations</li> <li>Practical activities</li> <li>Question and answer <ul style="list-style-type: none"> <li><u>Formative assessment</u></li> </ul> </li> </ul> <p>Testing Exercise to be done individually.</p>	<p>Rulers, pencils rubbers, mirror, pair of compasses Manila paper</p> <p>Mathematics for Rwanda Schools Students Book 2 Page 139 - 141</p> <p>Mathematics for Rwanda Schools Teacher's Guide 2 Page - -----</p>		

<p>Week 2 Sept 11<sup>th</sup> to 15<sup>th</sup> 2017</p>	<p><b>Lesson 5:</b> Definition of orthogonal projection and its properties (1 periods)</p>	<p><b>Knowledge and Understanding:</b></p> <ul style="list-style-type: none"> <li>Define orthogonal projection</li> <li>State the properties of orthogonal projection</li> </ul> <p><b>Skills:</b></p> <ul style="list-style-type: none"> <li>Draw orthogonal projection of a point on a line.</li> </ul> <p><b>Attitudes and Values:</b> Show the importance of parallel projection in various situations.</p>	<ul style="list-style-type: none"> <li>Guided discovery</li> <li>Individual work</li> <li>Pair work</li> <li>Class discussions</li> <li>Presentations</li> <li>Practical activities</li> <li>Question and answer</li> </ul>	<p>Rulers, pencils rubbers, mirror, pair of compasses Manila paper</p> <p>Mathematics for Rwanda Schools Students Book 2 Page 139 - 141</p> <p>Mathematics for Rwanda Schools Teacher's Guide 2 Page - -----</p>	
	<p><b>Lesson 6:</b> Orthogonal projection of a line segment on a line (2 periods)</p>	<p><b>Knowledge and Understanding:</b></p> <ul style="list-style-type: none"> <li>Identify the image of figures under orthogonal projection.</li> </ul> <p><b>Skills:</b></p> <ul style="list-style-type: none"> <li>Construct the orthogonal projection of a line segment on a line.</li> </ul> <p><b>Attitudes and Values:</b> Be accurate in constructing the orthogonal projection of a line segment on a line.</p>	<ul style="list-style-type: none"> <li>Guided discovery</li> <li>Individual work</li> <li>Pair work</li> <li>Class discussions</li> <li>Presentations</li> <li>Practical activities</li> <li>Question and answer</li> </ul>	<p>Rulers, pencils rubbers, mirror, pair of compasses Manila paper</p> <p>Mathematics for Rwanda Schools Students Book 2 Page 139 - 141</p> <p>Mathematics for Rwanda Schools Teacher's Guide 2 Page - -----</p>	





## **(b) Lesson plan**

A lesson plan is a detailed outline of how the teacher intends to carry out a specific lesson.

### **Important sub-headings of a Lesson Plan**

#### **1. Administrative details**

Date..... Subject.....

Class.....Teacher

Time..... Roll.....

#### **2. Unit title**

The name of the unit as in the syllabus.

#### **3. Key unit competence**

This is/are the competence(s) that the learner is expected to achieve at the end of the unit.

#### **4. Lesson title**

The content area to be taught in the lesson.

#### **5. Instructional Objectives**

These represent what the teacher anticipates learners to achieve by the end of the lesson. Objectives should be clear and specific. They should also be stated in behavioural terms, that is, in a way that the outcome can be seen, displayed or measured. In mathematics, one should distinguish between knowledge, skill and attitude objectives.

#### **6. Learning/teaching resources**

Any materials and apparatus that the learners and the teacher will use during the lesson.

#### **7. References**

Any resources consulted or used by the

teacher to prepare the lesson as well as any books that the learners will use during the lesson.

#### **8. Introduction**

This is the start of the lesson. The teacher should motivate the learners by creating learning situations that interest learners e.g. posing a problem, telling an amusing but relevant story or episode, showing an object or picture that arouse their interest. The introduction should link what the learners have already learnt with what they are going to learn.

#### **9. Presentation/lesson development**

This should mainly include the activities that learners and the teacher will perform in order to achieve the stated objectives; as well as the questions that learners will answer as they do the various activities.

It is convenient to distinguish between the learners' and teacher's activities under two columns.

#### **10. Summary/conclusion: (Consolidation)**

This is the step in which the lesson activities are tied up or consolidated to emphasise the main points, summarize the lessons or make conclusions. The summary should correspond to the objectives stated for that lesson.

#### **11. Comments/self-evaluation:**

Teacher should write remarks on whether the objectives were achieved or not and what he or she intends to do to improve on the weak points noted during the lesson.

This teacher's book has been written to help you guide learners to learn mathematics in the most enjoyable and captivating manner. You are reminded to always arouse the curiosity of learners as you teach. Some things that you may do before you go for a lesson include:

- Go through the expected learning outcomes – this should help guide the manner of teaching.
- Read through the unit for the lesson in advance to get an overview of the content required.
- Form a mental picture of the teaching situation and the ways in which you will interact with

learners when dealing with the suggested activities.

- Collect the materials that will be needed during the lesson in advance.
- In some cases, try out the suggested activities/experiments in advance to avoid embarrassments like - the experiment failing to work during the lesson.

**Remember:** The suggested teaching activities in this book are just a guide. You may not need to follow them to the letter! Feel free to incorporate other innovative teaching methods that will help in delivering the intended content optimally.

See a sample lesson plan next page

## SAMPLE LESSON PLAN

Term	Date	Subject	Class	Unit No.	Lesson No.	Duration	Class size
3	2/10/16	Mathematics	S2	10	1 of 6	40 min	40
Type of special educational needs to be catered for in this lesson and number of learners in each category				1 learners has speech challenges i.e. stammers and inaudible voice. 2 learners are short sighted.			
Unit title:		Statistics (grouped data)					
Key unit competence		To be able to collect, represent and to interpret grouped data					
Title of the lesson		Definition and examples of grouped data.					
Instructional objectives		By practically organising discrete data into classes, learners should be able to define grouped data and represent it in a frequency distribution table correctly.					
Plan for this class inside/outside		Inside the classroom Working in pairs					
Learning materials for all learners		Mathematics dictionaries, rulers, pencils, calculators,					
References		Mathematics for Rwanda schools SB2 (pages 181-185) and TG2 (pages 132 -145)					

Timing for each step	Description of teaching and learning activity		Generic competences and cross cutting issues to be addressed in this lesson
	Teacher activities	Learner activities	
	By working in groups when performing learning activities, learners to define grouped data and represent such data in a frequency distribution table		
Introduction (5 minutes)	<p>Guiding learners to carry out activity 10.1 on grouping data into classes.</p> <p>Guiding learner's where necessary on how to generate classes and place data into appropriate classes</p>	<p>Carrying out the task in the activities 10.1 on filling data in a frequency distribution table, participating in the discussions and answer questions in the activities</p>	<p>Communication skills will be enhanced as learners discuss and present their results to the class.</p>
Development of the lesson (30 min)	<p>Guiding learners to carry out activity 10.2 finding the range, class width and number of classes and preparing a frequency distribution table for the data.</p> <p>Facilitates a class discussion on the results presented by all the groups.</p> <p>Using the class discussion to help learners clearly understand to understand the terms and range, class width and number of classes and how to determine them appropriately for any given data, and to .</p> <p>Supervising, and guiding learners as they do Questions 1 and 2 in Exercise 10.1 in the learner's book page 183.</p>	<p>Learners practically doing activity 10.2 in the learners book by finding the range of the data given, grouping it into classes of size 10 and determine the frequency of each class.</p> <p>Learners suggesting and brainstorming on the most suitable definition of range, class limits and grouped data.</p> <p>Each group to present its findings to the rest of the class and participate in the whole class discussion.</p> <p>Learners doing Questions 1 and 2 in Exercise 10.1 given in the learner's book page 183</p>	<p>Critical thinking and problem solving skills will be enhanced as learners do activity 10.2 when determining the classes and placing data into the appropriate classes.</p> <p>Inclusivity, harmony, tolerance and humility will be enhanced as the learners work together in the activities.</p> <p>The group with the two shortsighted learners to be located near the chalkboard</p> <p>The learner with the speech problems to be given the task of recording data in his group</p>
Conclusion (3 min)	<p>Teacher summarizes main teaching points, highlights key points of the lesson, gives practice exercises on identification of types of data. Fast learners can be assigned a research activity to identify more types of data</p>	<p>Learners ask question for further clarification and information then take notes</p>	<p>Communication and writing skills will be enhanced as learners answer questions and take notes.</p>
Teacher self evaluation (2 min)	Teacher to evaluate him/herself based on whether the lesson objectives has been met and act accordingly		

## Section 3: Assessment and evaluation methods

Assessment is the process of evaluating the teaching and learning processes through collecting and interpreting evidence of individual learner's progress in learning and to make a judgment about a learner's achievements measured against defined standards. Assessment is an integral part of the teaching and learning processes. In the new competence-based curriculum assessment must also be competence-based; whereby a learner is given a complex situation related to his/her everyday life and asked to try to overcome the situation by applying what he/she learned.

### 3.1 Types of assessment

The two types of assessment that will be employed in the new curriculum is **formative** and **summative** assessment.

#### (a) Formative and continuous assessment (assessment for learning)

Formative or continuous assessment involves formal and informal methods used by schools to check whether learning is taking place. When a teacher is planning his/her lesson, he/she should establish criteria for performance and behaviour changes at the beginning of a unit. Then at the end of every unit, the teacher should ensure that all the learners have mastered the stated key unit competencies basing on the criteria stated, before going to the next unit. The teacher will assess how well each learner masters both the subject matter and the

generic competencies described in the syllabus and from this, the teacher will gain a picture of the all-round progress of the learner. The teacher will use one or a combination of the following:

- Observation to judge the extend of skills acquisition
- Written tests
- Oral questions
- Project work
- Attitude change – this can be done by asking probing questions and checking body language as learners respond to the questions.

#### (i) Written tests

Under this, learners are given questions or tasks and are required to respond in writing. Examples of written tests are: short answer type questions, structured type questions, filling blanks, multiple choice questions, true-false questions and matching items.

#### (ii) Practical work or Activity

In this category, learners are required to perform a task or solve a problem practically. The teacher then assesses the finished work by looking at the materials used, procedures followed, whether it works or not or whether it is finished. He or she then awards marks accordingly.

#### (iii) Observation

This involves the teacher observing learners as they perform a practical task to assess acquisition of skills and attitude

change. The teacher checks ability of the learner to measure, classify, communicate findings, etc. He or she also assesses the learner's curiosity, patience, team and co-operation spirit among others.

**(iv) Oral questions or interviews**

Asking learners questions which require a verbal response such as naming parts of human body, a system or short explanations of a process such as digestion can also be used to assess a learner's level of competence.

**(v) Drawing**

This involves asking learners to draw something they have observed or learnt about. They can also collect data and draw graphs and interpret the graph and give conclusions. This helps to assess their skill in communication through recording.

**(vi) Project work**

In a project, learners undertake a comprehensive study of something in real life over a period of time such as several weeks or even months after which they present a report. In project work, let learners begin from planning stage (come up with a schedule of events), execute the plan, analyse the results and look back ( reflect on the challenges encountered during the project and come up with solutions to those challenges (problem-solving skills).

A teacher can use one or several of these assessment methods depending on the subtopic being studied or the purpose for which assessment is required.

**When should the teacher assess learning progress?**

The teacher should decide whether to assess learners at the end of the lesson or at any other appropriate time when enough content has been covered. The general criteria to use to gauge learner achievement in the various generic competency areas is given in the table below.

Name of Learner	COMM	I&C	CT	RS	LL	PS	C&I
A	Red	Blue	Yellow	Blue	Red	Green	Yellow
B	Yellow	Red	Blue	Yellow	Blue	Red	Blue
C	Green	Blue	Red	Yellow	Blue	Red	Yellow
D	Yellow	Green	Yellow	Red	Yellow	Yellow	Green
E	Red	Blue	Yellow	Blue	Yellow	Red	Blue
F	Blue	Yellow	Red	Yellow	Blue	Green	Red
G	Yellow	Green	Blue	Yellow	Red	Blue	Green

**KEY:** Red – Poor  
 Blue – Average  
 Green – Good  
 Yellow – Excellent

COMM – Communication in English  
 I & C – Interpersonal skills & Co-operation  
 CT – Critical Thinking  
 RS – Research Skills  
 LL – Life long skills  
 PS – Problems solving skills  
 C & I – Creativity & Innovation

Allocate marks for each colour and calculate the marks that the learner has attained. Grade the learners based on how they have scored here and in the various tests given to assess skills acquisition and attitude change.

## **b) Summative assessment (assessment of learning)**

When assessment is used to record a judgment of a competence or performance of the learner, it serves a summative purpose. Summative assessment gives a picture of a learner's competence or progress at any specific moment. The main purpose of summative assessment is to evaluate whether learning objectives have been achieved and to use the results for the ranking or grading of learners, for deciding on progression, for selection into the next level of education and for certification. This assessment should have an integrative aspect whereby a student must be able to show mastery of all competencies.

It can be internal school based assessment or external assessment in the form of national examinations. School based summative assessment should take place once at the end of each term and once at the end of the year. School summative assessment average scores for each subject will be weighted and included in the final national examinations grade. School based assessment average grade will contribute a certain percentage as teachers gain more experience and confidence in assessment techniques and in the third year of the implementation of the new curriculum it will contribute 10% of the final grade, but will be progressively increased. Districts will be supported to continue their initiative to organize a common test per class for all the schools to evaluate the performance and the achievement level of learners in individual schools. External summative assessment will be done at the end of S3.

## ***Item writing in summative assessment***

Before developing a question paper, a plan or specification of what is to be tested or examined must be elaborated to show the units or topics to be tested on, the number of questions in each level of Bloom's taxonomy and the marks allocation for each question. In a competency based curriculum, questions from higher levels of Bloom's taxonomy should be given more weight than those from knowledge and comprehension level.

Before developing a question paper, the item writer must ensure that the test or examination questions are tailored towards competency based assessment by doing the following:

- Identify topic areas to be tested on from the subject syllabus.
- Outline subject matter content to be considered as the basis for the test.
- Identify learning outcomes to be measured by the test.
- Prepare a table of specifications.
- Ensure that the verbs used in the formulation of questions do not require memorization or recall answers only but testing broad competencies as stated in the syllabus.

## ***Structure and format of the examination***

There will be one paper in Mathematics at the end of Secondary 3. The paper will be composed by two sections, where the first section will be composed with

short answer items or items with short calculations which include the questions testing for knowledge and understanding, investigation of patterns, quick calculations and applications of Mathematics in real life situations.

The second section will be composed with long answer items or answers with simple demonstrations, constructions, calculations, simple analysis, interpretation and explanations. The items for the second section will emphasize on the mastering of Mathematics facts, the understanding of Mathematics concepts and its applications in real life situations. In this section, the assessment will find out not only what skills and facts have been mastered, but also how well learners understand the process of solving a mathematical problem and whether they can link the application of what they have learned to the context or to the real life situation. The Time required for the paper is three hours (3 hrs).

The following topic areas have to be assessed: algebra; metric measurements (money & its application); proportional reasoning; geometry; statistics and probability. Topic areas with more weight will have more emphasis in the second section where learners should have the right to choose to answer 3 items out of 5.

### **3.2 Record Keeping**

This is gathering facts and evidence from assessment instruments and using them to judge the student's performance by assigning an indicator against the set criteria or standard. Whatever assessment procedures used shall

generate data in the form of scores which will be carefully be recorded and stored in a portfolio because they will contribute for remedial actions, for alternative instructional strategy and feed back to the learner and to the parents to check the learning progress and to advice accordingly or to the final assessment of the students.

This portfolio is a folder (or binder or even a digital collection) containing the student's work as well as the student's evaluation of the strengths and weaknesses of the work. Portfolios reflect not only work produced (such as papers and assignments), but also it is a record of the activities undertaken over time as part of student learning. Besides, it will serve as a verification tool for each learner that he/she attended the whole learning before he/she undergoes the summative assessment for the subject.

### **3.4 Reporting to parents**

The wider range of learning in the new curriculum means that it is necessary to think again about how to share learners' progress with parents. A single mark is not sufficient to convey the different expectations of learning, which are in the learning objectives. The most helpful reporting is to share what students are doing well and where they need to improve.



# CONTENT MAP

	Unit 1: Indices and surds	Unit 2: Polynomials	Unit 3: Simultaneous Linear equations and inequalities	Unit 4: Multiplier for Proportional	Unit 5: Thale's theorem
<b>Number of periods</b>	18	30	30	12	12
<b>Introduction</b>	Writing numbers in short form in the index notation and vice versa.	Defining a polynomial and, giving its general form, identify the degree and types of polynomials	Defining and illustrating simultaneous equations, Identifying situations that lead to simultaneous equations.	Reviewing definition and properties of proportions.	Reviewing ratios and drawing of line segments
<b>Classroom organization</b>	<ul style="list-style-type: none"> <li>Working in pairs</li> <li>Small groups,</li> <li>Whole class orientation</li> <li>Individual work when doing assignments.</li> </ul>	<ul style="list-style-type: none"> <li>Working in pairs</li> <li>Small groups,</li> <li>Whole class orientation</li> <li>Individual work when doing assignments.</li> </ul>	<ul style="list-style-type: none"> <li>Working in pairs</li> <li>Small groups,</li> <li>Whole class orientation</li> <li>Individual work when doing assignments.</li> </ul>	<ul style="list-style-type: none"> <li>Working in pairs</li> <li>Small groups,</li> <li>Whole class orientation</li> <li>Individual work when doing assignments.</li> </ul>	<ul style="list-style-type: none"> <li>Working in pairs</li> <li>Small groups,</li> <li>Whole class orientation</li> <li>Individual work when doing assignments.</li> </ul>
<b>Equipment Required</b>	<ul style="list-style-type: none"> <li>Wall charts showing rules of indices</li> <li>Text books</li> </ul>	<ul style="list-style-type: none"> <li>Text books</li> <li>Calculators</li> <li>Access to Internet</li> </ul>	<ul style="list-style-type: none"> <li>Graph/squared papers</li> <li>Pencils and rulers</li> <li>Text books</li> </ul>	<ul style="list-style-type: none"> <li>Textbook</li> <li>Coins, bills, receipt papers,</li> <li>Calculators</li> </ul>	<ul style="list-style-type: none"> <li>Textbook</li> <li>Geometrical set</li> <li>Rulers</li> </ul>
<b>Activities</b>	<p><b>Activities:</b></p> <ul style="list-style-type: none"> <li>In pairs, writing numbers in index notation and vice versa.</li> <li>In pairs, establishing, proving and applying the laws of indices.</li> <li>In pairs, solving simple equations involving indices.</li> <li>In pairs, discovering how to write numbers in standard form.</li> <li>In pairs, distinguishing surds from perfect roots.</li> </ul>	<p><b>Activities:</b></p> <ul style="list-style-type: none"> <li>Working in groups classify polynomials based on the number of terms.</li> <li>In pairs identifying like and unlike terms then adding and subtracting polynomials.</li> <li>In pairs evaluating polynomials by substituting given values.</li> </ul>	<p><b>Activities</b></p> <ul style="list-style-type: none"> <li>In pairs describing and forming simultaneous equations from given situations.</li> <li>Individually solving simultaneous equations graphically.</li> <li>Individually illustrating the solutions of different types of simultaneous equations and using the observations to classify these equations.</li> <li>In pairs solving simultaneous equations using substitution, elimination, graphical, comparison and Cramer's rule.</li> </ul>	<p><b>Activities:</b></p> <ul style="list-style-type: none"> <li>In groups reviewing the properties of proportions learnt in S1</li> <li>In pairs expressing ratios in the simplest form</li> <li>In pairs determining the multiplier for percentage increase or decrease</li> <li>In pairs calculating percentage change.</li> </ul>	<p><b>Activities on:</b></p> <ul style="list-style-type: none"> <li>Individually constructing triangles and trapezia, and locating midpoints to establish the midpoint theorem.</li> <li>Individually constructing triangles and trapezia, and parallel lines through them to establish Thale's theorem and its converse.</li> </ul>

<p>Competences practiced</p>	<ul style="list-style-type: none"> <li>• In pairs, simplifying surds, performing addition, subtraction, multiplication and division of surds.</li> <li>• In pairs, establishing the denominator</li> <li>• In pairs using estimation, factorisation and long division methods to find square roots of numbers</li> </ul>	<ul style="list-style-type: none"> <li>• In pairs multiplying and dividing polynomials.</li> <li>• In pairs proofing whether given algebraic equations are identities.</li> <li>• In pairs factorising polynomials.</li> <li>• In pairs expanding and factorising quadratic expressions</li> </ul>	<ul style="list-style-type: none"> <li>• In pairs solving compound inequalities and representing solutions on a number line.</li> <li>• In pairs solving simultaneous linear inequalities. and representing solutions on a number line.</li> <li>• Individually solving real life problems using inequalities.</li> </ul>		
<p>Competences practiced</p> <ul style="list-style-type: none"> <li>• Writing numbers in index notation</li> <li>• Application of laws of indices</li> <li>• Solving simple equations of involving indices.</li> <li>• Performing arithmetic operations on surds</li> <li>• Rationalising the denominator</li> <li>• Finding roots of numbers.</li> </ul>	<ul style="list-style-type: none"> <li>• Addition, subtraction, multiplication and division of polynomials.</li> <li>• Getting the numerical value of polynomials</li> <li>• Expanding and factorising polynomials</li> </ul>	<ul style="list-style-type: none"> <li>• Forming simultaneous equations from given situations.</li> <li>• Solving simultaneous equations using substitution, elimination, graphical, comparison and Cramer's rule.</li> <li>• Solving compound inequalities and representing solutions on a number line.</li> <li>• Solving simultaneous linear inequalities and representing solutions on a number line.</li> <li>• Solving real life problems using inequalities.</li> </ul>	<ul style="list-style-type: none"> <li>• Solving problems involving properties of proportions</li> <li>• Expressing ratios in the simplest form</li> <li>• Determining the multiplier for percentage increase or decrease</li> <li>• Calculating percentage change.</li> </ul>		<ul style="list-style-type: none"> <li>• Solving triangles using the midpoint theorem.</li> <li>• Solving triangles and trapezia, using Thale's theorem and its converse.</li> </ul>

Language practiced	<ul style="list-style-type: none"> <li>• Reading instruction in the activities</li> <li>• Discussion in pairs./groups</li> <li>• Writing observations.</li> <li>• Presentation of activity findings, observation and results.</li> <li>• Reading and interpreting mathematical problems</li> </ul>	<ul style="list-style-type: none"> <li>• Reading instruction in the activities</li> <li>• Discussion in pairs./groups</li> <li>• Writing observations.</li> <li>• Presentation of activity findings, observation and results.</li> <li>• Reading and interpreting mathematical problems</li> </ul>	<ul style="list-style-type: none"> <li>• Reading instruction in the activities</li> <li>• Discussion in pairs./groups</li> <li>• Writing observations.</li> <li>• Presentation of activity findings, observation and results.</li> <li>• Reading and interpreting mathematical problems</li> </ul>	<ul style="list-style-type: none"> <li>• Reading instruction in the activities</li> <li>• Discussion in pairs./groups</li> <li>• Writing observations.</li> <li>• Presentation of activity findings, observation and results.</li> <li>• Reading and interpreting mathematical problems</li> </ul>	<ul style="list-style-type: none"> <li>• Reading instruction in the activities</li> <li>• Discussion in pairs./groups</li> <li>• Writing observations.</li> <li>• Presentation of activity findings, observation and results.</li> <li>• Reading and interpreting mathematical problems</li> </ul>
Vocabulary acquisition	<ul style="list-style-type: none"> <li>• New terminologies on indices including index notation, surds, standard form, surds, and rationalisation of surds</li> </ul>	<ul style="list-style-type: none"> <li>• New terminologies on polynomials eg. monomials, binomials, homogeneous, and identities and factorisation</li> </ul>	<ul style="list-style-type: none"> <li>• New terminologies including simultaneous equations, compound inequalities</li> </ul>	<ul style="list-style-type: none"> <li>• New terminologies such as ratios in simplest form, multiplier for decrease/increase.</li> </ul>	<ul style="list-style-type: none"> <li>• New terminologies including midpoint theorem, Thale's theorem, and converse</li> </ul>
Numeracy	<ul style="list-style-type: none"> <li>• Writing numbers in index notation</li> <li>• Solving simple equations of involving indices.</li> <li>• Performing arithmetic operations on surds</li> <li>• Rationalising the denominator</li> <li>• Finding roots of numbers.</li> </ul>	<ul style="list-style-type: none"> <li>• Addition, subtraction, multiplication and division of polynomials.</li> <li>• substitution to get the numerical value of polynomials</li> <li>• Expanding and factorising polynomials</li> </ul>	<ul style="list-style-type: none"> <li>• Solving simultaneous equations using substitution, eliminations</li> <li>• Solving compound inequalities</li> <li>• Solving simultaneous linear inequalities.</li> <li>• Solving real life problems using inequalities.</li> </ul>	<ul style="list-style-type: none"> <li>• Solving problems involving properties of proportions</li> <li>• Expressing ratios in the simplest form</li> <li>• Determining the multiplier for percentage increase or decrease</li> <li>• Calculating percentage change.</li> </ul>	<ul style="list-style-type: none"> <li>• Solving triangles using the midpoint theorem.</li> <li>• Solving triangles and trapezia, using Thale's theorem and its converse.</li> </ul>

Study skills	<ul style="list-style-type: none"> <li>Research skills acquired through searching for information on dices from reference books, dictionary and Internet.</li> <li>Discussion as a study skill is acquired when performing activities in pairs and groups</li> </ul>	<ul style="list-style-type: none"> <li>Research skills acquired through searching for information on dices from reference books, dictionary and Internet</li> <li>Discussion as a study skill is acquired when performing activities in pairs and groups</li> </ul>	<ul style="list-style-type: none"> <li>Research skills acquired through searching for information on dices from reference books, dictionary and Internet</li> <li>Discussion as a study skill is acquired when performing activities in pairs and groups.</li> </ul>	<ul style="list-style-type: none"> <li>Research skills acquired through searching for information on dices from reference books, dictionary and Internet</li> <li>Discussion as a study skill is acquired when performing activities in pairs and groups.</li> </ul>	<ul style="list-style-type: none"> <li>Research skills acquired through searching for information on dices from reference books, dictionary and Internet</li> <li>Discussion as a study skill is acquired when performing activities in pairs and groups.</li> </ul>
Revision	<ul style="list-style-type: none"> <li>Revision exercises provided (exercises and unit test)</li> </ul>	<ul style="list-style-type: none"> <li>Revision exercises provided (exercises and unit test)</li> </ul>	<ul style="list-style-type: none"> <li>Revision exercises provided (exercises and unit test)</li> </ul>	<ul style="list-style-type: none"> <li>Revision exercises provided (exercises and unit test)</li> </ul>	<ul style="list-style-type: none"> <li>Revision exercises provided (exercises and unit test)</li> </ul>
Assessment	<p>Formative assessment on:</p> <ul style="list-style-type: none"> <li>Writing numbers in index notation</li> <li>Solving simple equations of involving indices.</li> <li>Performing arithmetic operations on surds</li> <li>Rationalising the denominator</li> <li>Finding roots of numbers.</li> <li>Unit Test</li> </ul>	<p>Formative assessment on:</p> <ul style="list-style-type: none"> <li>Addition, subtraction, multiplication and division of polynomials.</li> <li>substitution to get the numerical value of polynomials</li> <li>Expanding and factorising polynomials</li> <li>Unit Test</li> </ul>	<p>Formative assessment on:</p> <ul style="list-style-type: none"> <li>Solving simultaneous equations using substitution, eliminations</li> <li>Solving compound inequalities</li> <li>Solving simultaneous linear inequalities.</li> <li>Solving real life problems involving inequalities.</li> <li>Unit Test</li> </ul>	<p>Formative assessment on:</p> <ul style="list-style-type: none"> <li>Solving problems involving properties of proportions</li> <li>Expressing ratios in the simplest form</li> <li>Determining the multiplier for percentage increase or decrease</li> <li>Calculating percentage change.</li> <li>Unit Test</li> </ul>	<p>Formative assessment on:</p> <ul style="list-style-type: none"> <li>Solving triangles using the midpoint theorem.</li> <li>Solving triangles and trapezia, using Thale's theorem and its converse.</li> <li>Unit Test</li> </ul>
Learning outcomes	<p>Ability to:</p> <ul style="list-style-type: none"> <li>Write numbers in index notation</li> <li>Solve simple equations of involving indices.</li> <li>Perform arithmetic operations on surds</li> <li>Rationalise the denominator</li> <li>Find roots of numbers.</li> </ul>	<p>Ability to:</p> <ul style="list-style-type: none"> <li>Add, subtract, multiply and divide polynomials.</li> <li>substitute numerical values in polynomials</li> <li>Expand and factorise polynomials</li> </ul>	<p>Ability to:</p> <ul style="list-style-type: none"> <li>Solve simultaneous equations using substitution, eliminations</li> <li>Solve compound inequalities</li> <li>Solve simultaneous linear inequalities.</li> <li>Solve real life problems involving inequalities.</li> </ul>	<p>Ability to:</p> <ul style="list-style-type: none"> <li>Solve problems involving properties of proportions</li> <li>Express ratios in the simplest form</li> <li>Determine the multiplier for percentage increase or decrease</li> <li>Calculate percentage change.</li> </ul>	<p>Ability to:</p> <ul style="list-style-type: none"> <li>Solve triangles using the midpoint theorem.</li> <li>Solve triangles and trapezia, using Thale's theorem and its converse.</li> </ul>

# CONTENT MAP

	Unit 6: Pythagoras' theorem	Unit 7: Vectors	Unit 8: Parallel and orthogonal projection	Unit 9: Isometries	Unit 10: Statistics
<b>Number of periods</b>	12	18	12	30	30
<b>Introduction</b>	<ul style="list-style-type: none"> <li>Review of features of a right angled triangle</li> </ul>	<p>Demonstrating and defining a vector:</p> <ul style="list-style-type: none"> <li>Working in pairs</li> <li>Small groups,</li> <li>Whole class orientation</li> <li>Individual work when doing assignments.</li> </ul>	<p>Review of construction of parallel lines</p> <ul style="list-style-type: none"> <li>Working in pairs</li> <li>Small groups,</li> <li>Whole class orientation</li> <li>Individual work when doing assignments.</li> </ul>	<p>Definition of the terms isometry and transformation</p> <ul style="list-style-type: none"> <li>Working in pairs</li> <li>Small groups,</li> <li>Whole class orientation</li> <li>Individual work when doing assignments.</li> </ul>	<p>Introduction of grouped data</p> <ul style="list-style-type: none"> <li>Working in pairs</li> <li>Small groups,</li> <li>Whole class orientation</li> <li>Individual work when doing assignments.</li> </ul>
<b>Classroom organization</b>	<ul style="list-style-type: none"> <li>Working in pairs</li> <li>Small groups,</li> <li>Whole class orientation</li> <li>Individual work when doing assignments.</li> </ul>	<ul style="list-style-type: none"> <li>Working in pairs</li> <li>Small groups,</li> <li>Whole class orientation</li> <li>Individual work when doing assignments.</li> </ul>	<ul style="list-style-type: none"> <li>Working in pairs</li> <li>Small groups,</li> <li>Whole class orientation</li> <li>Individual work when doing assignments.</li> </ul>	<ul style="list-style-type: none"> <li>Working in pairs</li> <li>Small groups,</li> <li>Whole class orientation</li> <li>Individual work when doing assignments.</li> </ul>	<ul style="list-style-type: none"> <li>Working in pairs</li> <li>Small groups,</li> <li>Whole class orientation</li> <li>Individual work when doing assignments.</li> </ul>
<b>Equipment Required</b>	<ul style="list-style-type: none"> <li>Wall charts right angled triangles</li> <li>Text books</li> <li>Squared paper</li> </ul>	<ul style="list-style-type: none"> <li>Text books</li> <li>Graph papers, pencils and rulers</li> <li>Access to Internet</li> </ul>	<ul style="list-style-type: none"> <li>Geometrical set</li> <li>Pencils and rulers</li> <li>Text books</li> </ul>	<ul style="list-style-type: none"> <li>Geometrical set</li> <li>Pencils and rulers</li> <li>Graph papers</li> <li>Text books</li> </ul>	<ul style="list-style-type: none"> <li>Geometrical set</li> <li>Pencils and rulers</li> <li>Graph papers</li> <li>Text books</li> </ul>
<b>Activities</b>	<p>Activities:</p> <ul style="list-style-type: none"> <li>Individually using squares to establish the relationship between the lengths of the three sides of a right angled triangle</li> <li>In pairs establishing whether using triangles to proof Pythagoras theorem analytically</li> <li>In pairs identifying pythagorean triples</li> </ul>	<p>Activities:</p> <ul style="list-style-type: none"> <li>Individually plotting points on Cartesian plane and joining them to demonstrate vectors</li> <li>In pairs establishing whether given vectors are equivalent or not.</li> <li>Individually locating midpoints of vectors in a Cartesian plane.</li> </ul>	<p>Activities</p> <ul style="list-style-type: none"> <li>Individually drawing parallel lines</li> <li>In pairs constructing the parallel projection of a point on a line</li> <li>In pairs constructing the orthogonal projection of plane shapes on a line</li> </ul>	<p>Activities:</p> <ul style="list-style-type: none"> <li>Individually researching the definition of the terms isometry and transformation</li> <li>In pairs constructing the central symmetry of figures,</li> <li>Individually observing the properties of the reflected image in a mirror symmetry</li> <li>In pairs performing reflection of figures in a cartesian plane</li> </ul>	<p>Activities on:</p> <ul style="list-style-type: none"> <li>In pairs constructing frequency distribution table for grouped data</li> <li>Individually representing data in histogram,, frequency polygon,, pie chart,</li> <li>Individually drawing cumulative frequency curves</li> <li>Individually determining range, and calculating arithmetic mean, mode and media of grouped data</li> </ul>

	<ul style="list-style-type: none"> <li>In group identify situations real life involving the use of Pythagoras theorem</li> </ul>	<ul style="list-style-type: none"> <li>In pairs adding, subtracting vectors band multiplying them with scalars by construction.</li> <li>In pairs adding, column vectors in a Cartesian plane.</li> <li>Individually determining the magnitude of a vector by construction and use of Pythagoras theorem</li> </ul>		<ul style="list-style-type: none"> <li>In pairs performing rotation of figures in a cartesian plane through various angles</li> <li>In pairs establishing congruence between the object and image in a rotation</li> <li>Locating centre and angle of rotation given the object and image.</li> <li>Performing translation of figures in the cartesian plane.</li> <li>Performing composite transformations of figures in the cartesian plane.</li> </ul>	<ul style="list-style-type: none"> <li>In pairs reading and interpreting statistical graphs frequency</li> </ul>
<p>Competences practiced</p>	<ul style="list-style-type: none"> <li>Proofing Pythagoras theorem</li> <li>Applying Pythagoras theorem to solve triangles</li> </ul>	<ul style="list-style-type: none"> <li>Drawing vectors in a Cartesian plane</li> <li>Adding, subtracting vectors band multiplying them with scalars by construction.</li> <li>Determining whether given vectors are equivalent or not.</li> <li>Determining midpoints of vectors using formula</li> <li>Adding, column vectors in a Cartesian plane.</li> </ul>	<ul style="list-style-type: none"> <li>Constructing parallel lines</li> <li>Constructing the parallel projection of a point on a line</li> <li>Constructing the orthogonal projection of plane shapes on a line</li> <li>Constructing the orthogonal projection of a point on a line</li> <li>Constructing the orthogonal projection of plane shapes on a line</li> </ul>	<ul style="list-style-type: none"> <li>Constructing the central symmetry of figures,</li> <li>Performing reflection of figures in a cartesian plane.</li> <li>Rotating of figures in a cartesian plane through various angles</li> <li>Locating centre and angle of rotation given the object and image.</li> <li>Performing translation of figures in the cartesian plane.</li> <li>Performing composite transformations of figures in the cartesian plane.</li> </ul>	<ul style="list-style-type: none"> <li>Constructing frequency distribution table for grouped data</li> <li>Representing data in histogram,, frequency polygon,, pie chart,</li> <li>Drawing cumulative frequency curves</li> <li>Determining range, and calculating arithmetic mean, mode and media of grouped data</li> <li>Reading and interpreting statistical graphs frequency</li> </ul>

Language practiced	<ul style="list-style-type: none"> <li>• Reading instruction in the activities</li> <li>• Discussion in pairs./groups</li> <li>• Writing observations.</li> <li>• Presentation of activity findings, observation and results.</li> <li>• Reading and interpreting mathematical problems</li> </ul>	<ul style="list-style-type: none"> <li>• Reading instruction in the activities</li> <li>• Discussion in pairs./groups</li> <li>• Writing observations.</li> <li>• Presentation of activity findings, observation and results.</li> <li>• Reading and interpreting mathematical problems</li> </ul>	<ul style="list-style-type: none"> <li>• Reading instruction in the activities</li> <li>• Discussion in pairs./groups</li> <li>• Writing observations.</li> <li>• Presentation of activity findings, observation and results.</li> <li>• Reading and interpreting mathematical problems</li> </ul>	<ul style="list-style-type: none"> <li>• Reading instruction in the activities</li> <li>• Discussion in pairs./groups</li> <li>• Writing observations.</li> <li>• Presentation of activity findings, observation and results.</li> <li>• Reading and interpreting mathematical problems</li> </ul>	<ul style="list-style-type: none"> <li>• Reading instruction in the activities</li> <li>• Discussion in pairs./groups</li> <li>• Writing observations.</li> <li>• Presentation of activity findings, observation and results.</li> <li>• Reading and interpreting mathematical problems</li> </ul>
Vocabulary acquisition	<ul style="list-style-type: none"> <li>• Terminologies including Pythagoras theorem and Pythagorean triple</li> </ul>	<ul style="list-style-type: none"> <li>• Reading instruction in the activities</li> <li>• Discussion in pairs./groups</li> <li>• Writing observations.</li> <li>• Presentation of activity findings, observation and results.</li> <li>• Reading and interpreting mathematical problems</li> </ul>	<ul style="list-style-type: none"> <li>• Reading instruction in the activities</li> <li>• Discussion in pairs./groups</li> <li>• Writing observations.</li> <li>• Presentation of activity findings, observation and results.</li> <li>• Reading and interpreting mathematical problems</li> </ul>	<ul style="list-style-type: none"> <li>• Reading instruction in the activities</li> <li>• Discussion in pairs./groups</li> <li>• Writing observations.</li> <li>• Presentation of activity findings, observation and results.</li> <li>• Reading and interpreting mathematical problems</li> </ul>	<ul style="list-style-type: none"> <li>• Reading instruction in the activities</li> <li>• Discussion in pairs./groups</li> <li>• Writing observations.</li> <li>• Presentation of activity findings, observation and results.</li> <li>• Reading and interpreting mathematical problems</li> </ul>
Numeracy	<ul style="list-style-type: none"> <li>• Applying Pythagoras theorem to solve triangles</li> </ul>	<ul style="list-style-type: none"> <li>• Adding, subtracting vectors and multiplying them with scalars by calculation</li> <li>• Determining whether given vectors are equivalent or not.</li> <li>• Determining midpoints of vectors using formula</li> <li>• Adding column vectors using formula.</li> </ul>	<ul style="list-style-type: none"> <li>• Constructing the parallel projection of a point on a line</li> <li>• Constructing the orthogonal projection of plane shapes on a line</li> <li>• Constructing the orthogonal projection of a point on a line</li> <li>• Constructing the orthogonal projection of plane shapes on a line</li> </ul>	<ul style="list-style-type: none"> <li>• Constructing the central symmetry of figures,</li> <li>• Performing reflection of figures in a cartesian plane.</li> <li>• Rotating of figures in a cartesian plane through various angles</li> <li>• Locating centre and angle of rotation given the object and image.</li> <li>• Performing translation of figures in the cartesian plane.</li> <li>• Performing composite transformations of figures in the cartesian plane.</li> </ul>	<ul style="list-style-type: none"> <li>• Constructing frequency distribution table for grouped data</li> <li>• Representing data in histogram,, frequency polygon,, pie chart,</li> <li>• Drawing cumulative frequency curves</li> <li>• Determining range, and calculating arithmetic mean, mode and media of grouped data</li> <li>• Reading and interpreting statistical graphs frequency</li> </ul>

Study skills	<ul style="list-style-type: none"> <li>Research skills acquired through searching for information on dices from reference books, dictionary and Internet.</li> <li>Discussion as a study skill is acquired when performing activities in pairs and groups</li> </ul>	<ul style="list-style-type: none"> <li>Research skills acquired through dices from reference books, dictionary and Internet</li> <li>Discussion as a study skill is acquired when performing activities in pairs and groups</li> </ul>	<ul style="list-style-type: none"> <li>Research skills acquired through searching for information on dices from reference books, dictionary and Internet</li> <li>Discussion as a study skill is acquired when performing activities in pairs and groups.</li> </ul>	<ul style="list-style-type: none"> <li>Research skills acquired through searching for information on dices from reference books, dictionary and Internet</li> <li>Discussion as a study skill is acquired when performing activities in pairs and groups.</li> </ul>	<ul style="list-style-type: none"> <li>Research skills acquired through searching for information on dices from reference books, dictionary and Internet</li> <li>Discussion as a study skill is acquired when performing activities in pairs and groups.</li> </ul>
Revision	<ul style="list-style-type: none"> <li>Revision exercises provided (exercises and unit test)</li> </ul>	<ul style="list-style-type: none"> <li>Revision exercises provided (exercises and unit test)</li> </ul>	<ul style="list-style-type: none"> <li>Revision exercises provided (exercises and unit test)</li> </ul>	<ul style="list-style-type: none"> <li>Revision exercises provided (exercises and unit test)</li> </ul>	<ul style="list-style-type: none"> <li>Revision exercises provided (exercises and unit test)</li> </ul>
<b>Assessment</b>	<p>Formative assessment on:</p> <ul style="list-style-type: none"> <li>Applying Pythagoras theorem to solve triangles</li> <li>Identifying pythagorean triples</li> <li>Solving real life problems using Pythagoras theorem</li> <li>Unit Test</li> </ul>	<p>Formative assessment on:</p> <ul style="list-style-type: none"> <li>Adding, subtracting vectors band multiplying them with scalars by construction.</li> <li>Determining whether given vectors are equivalent or not.</li> <li>Determining midpoints of vectors using formula</li> <li>Adding, column vectors in a Cartesian plane.</li> <li>Unit Test</li> </ul>	<p>Formative assessment on:</p> <ul style="list-style-type: none"> <li>Constructing the parallel projection of a point on a line</li> <li>Constructing the orthogonal projection of plane shapes on a line</li> <li>Constructing the orthogonal projection of a point on a line</li> <li>Constructing the orthogonal projection of plane shapes on a line</li> <li>Unit Test</li> </ul>	<p>Formative assessment on:</p> <ul style="list-style-type: none"> <li>Constructing the central symmetry of figures,</li> <li>Performing reflection of figures in a cartesian plane.</li> <li>Rotating of figures in a cartesian plane through various angles</li> <li>Locating centre and angle of rotation given the object and image.</li> <li>Performing translation of figures in the cartesian plane.</li> <li>Performing composite transformations of figures in the cartesian plane.</li> <li>Unit Test</li> </ul>	<p>Formative assessment on:</p> <ul style="list-style-type: none"> <li>Constructing frequency distribution table for grouped data</li> <li>Representing data in histogram,, frequency polygon,, pie chart,</li> <li>Drawing cumulative frequency curves</li> <li>Determining range, and calculating arithmetic mean, mode and media of grouped data</li> <li>Reading and interpreting statistical graphs frequency</li> <li>Unit Test</li> </ul>



<p><b>Learning outcomes</b></p>	<p>Ability to:</p> <ul style="list-style-type: none"> <li>• apply Pythagora's theorem to solve triangles.</li> </ul>	<p>Ability to:</p> <ul style="list-style-type: none"> <li>• Add, subtracting vectors and multiply them with scalars by calculation</li> <li>• Determine whether given vectors are equivalent or not.</li> <li>• Determine midpoints of vectors using formula</li> <li>• Add or subtract column vectors</li> </ul>	<p>Ability to:</p> <ul style="list-style-type: none"> <li>• Construct the parallel projection of a point on a line</li> <li>• Construct the orthogonal projection of plane shapes on a line</li> <li>• Construct the orthogonal projection of a point on a line</li> <li>• Construct the orthogonal projection of plane shapes on a line</li> </ul>	<p>Ability to:</p> <ul style="list-style-type: none"> <li>• Construct the central symmetry of figures,</li> <li>• Perform reflection, rotation and translation of figures.</li> <li>• Locate mirror line, centre and angle of rotation given the object and image.</li> <li>• Perform composite transformations of figures in the cartesian plane.</li> </ul>	<p>Ability to:</p> <ul style="list-style-type: none"> <li>• Represent grouped data in frequency distribution table histogram,, frequency polygon,, pie chart,</li> <li>• Drawing cumulative frequency curves</li> <li>• Determine range, and calculating arithmetic mean, mode and media of grouped data</li> <li>• Read and interpreting statistical graphs frequency</li> </ul>
---------------------------------	--	---	---	---	---

<b>Unit 11</b>	<b>Tree and venn diagrams (12 periods)</b>
Introduction	Review the definition of probability and determination of probability of an event numerically
Classroom organization	<ul style="list-style-type: none"> <li>• Working in pairs</li> <li>• Small groups,</li> <li>• Whole class orientation</li> <li>• Individual work when doing assignments.</li> </ul>
Equipment required	<ul style="list-style-type: none"> <li>• Dice, coins, assorted balls different colours</li> <li>• Textbook</li> </ul>
Activities	<p>Activities:</p> <ul style="list-style-type: none"> <li>• In pairs to review what was learnt in S1 on probability</li> <li>• In groups to determine total number of all possible outcomes unit the help of of tree diagram</li> <li>• In groups to determine probability of events using tree diagrams</li> <li>• In groups to determine probability of event using venn diagrams</li> <li>• In groups to determine probability of mutually exchange events</li> <li>• In groups to determine probability of independent events</li> </ul>
Competences practiced	<ul style="list-style-type: none"> <li>• Determination of total number of all possible outcomes unit the help of of tree diagram</li> <li>• Determination of probability of events using tree diagrams</li> <li>• Determination of probability of event using venn diagrams</li> <li>• Determination of probability of mutually exchange events</li> <li>• Determination of probability of independent events</li> <li>• Using of probability to estimate the likelihood of events happening in real life</li> </ul>
Language practical	<ul style="list-style-type: none"> <li>• Reading instruction in the activities</li> <li>• Discussion in pairs./groups</li> <li>• Writing observations.</li> <li>• Presentation of activity findings, observation and results.</li> <li>• Reading and interpreting mathematical problems</li> </ul>
Vocabulary acquired	<ul style="list-style-type: none"> <li>• New words and phrases such as tree diagram, venn diagram, mutually exclusive, and independent events</li> </ul>
Numeracy	<ul style="list-style-type: none"> <li>• Determination of total number of all possible outcomes unit the help of tree diagram</li> <li>• Determination of probability of events using tree diagrams</li> <li>• Determination of probability of event using venn diagrams</li> <li>• Determination of probability of mutually exchange events</li> <li>• Determination of probability of independent events</li> <li>• Using of probability to estimate the likelihood of events happening in real life</li> </ul>
Study skills	<ul style="list-style-type: none"> <li>• Research skills acquired through searching for information on dices from reference books, dictionary and Internet.</li> <li>• Discussion as a study skill is acquired when performing activities in pairs and groups</li> </ul>
Revision	<ul style="list-style-type: none"> <li>• Revision exercises provided (exercises and unit test)</li> </ul>
Assessment	<p>Formative assessment on:</p> <ul style="list-style-type: none"> <li>• Determination of total number of all possible outcomes unit the help of of tree diagram</li> <li>• Determination of probability of events using tree diagrams</li> </ul>
	<ul style="list-style-type: none"> <li>• Determination of probability of event using venn diagrams</li> <li>• Determination of probability of mutually exchange events</li> <li>• Determination of probability of independent events</li> <li>• Using of probability to estimate the likelihood of events happening in real life</li> </ul>

Learning outcomes	Appreciate use of tree and venn diagram in calculating probability especially where more than two events are involved Ability to use rules of probability ie addition law, multiplication law Understanding the significance of the range of probability of events happening.
-------------------	---

# Algebra

## Unit 1

## INDICES AND SURDS

Learner's Book pages 1 - 26. (10 Lessons)

### Key unit competence

By the end of this unit, the learner should be able to Calculate with indices and surds, use place value to represent very small and very large numbers.

### Content outline

1.1 Indices

1.2 Standard form

1.3 Surds

Answers

- Apply properties of indices to simplify mathematical expressions.
- Apply properties of surds to simplify radicals.
- Compute rationalisation of denominator on surds.

### Learning objectives

#### Knowledge and understanding

- Recognise laws of indices
- Represent very small number or large number in standard form
- Define and give examples of surds
- Identify properties of surds
- Recognise the conjugates of surds.

#### Attitudes and values

- Appreciate the importance of indices and surds in solving mathematical problems.
- Show concern of self confidence, determination, and group work spirit.

#### Skills

- Perform operations on indices and surds.
- Solve simple equations involving indices and surds.
- Use standard form to represent a number.

#### Generic competences addresses in this unit

- Critical thinking
- Research
- Problem solving
- Communication skills
- Creativity and innovation

## Links to other subjects

Subjects that deal with writing large numbers, writing numbers in standard form and writing numbers with powers. For example Physics, chemistry, biology, computer science, economics, finance etc.

## Cross cutting issues addressed in this unit

- Inclusive education
- Financial information

## Assessment criteria

Use rules of indices and surds to simplify mathematical situations involving indices and surds.

## Background Information

Learners have been introduced to topics on algebra from senior 1 but the concept of indices is new to the learners. Most learners find this unit challenging and it is therefore advisable to give more exercises in every concept learnt. Make the unit as practical as possible so that the learners are able to relate with the indices and surds easily. The activities provided will help in introducing the unit but you can bring on board other relevant activities to help the learners in understanding the concept. Make good use of the groups and ensure that the learners research on the concept so that they are actively involved in generating the general formulas throughout the topic.

## Suggested teaching/learning activities

### 1.1 INDICES

#### 1.1.1 Index notation

By the end of the section, the learner should be able to;

- Define indices comprehensively.
- Give examples of indices

## Information to the teacher

This topic is new to the learners and therefore start with a review of factors and prime factorisation of numbers.

## Teaching guidelines 1.1.1

Organise the class to work in pairs. The pairs should comprise of both genders and learners with disability if any. Let each pair choose a group secretary and make sure that learners with disability are also included as group secretaries.

- Ask the pairs to do activity 1.1 in the learner's book page 1 i.e writing prime factors in short form. Allow them to discuss and research on the concept.
- Let the pairs present their findings to the whole class and make a comparison with other pairs through the secretary.
- Allow the learners to present their findings to the class as they point out mistakes and additional in their presentation.

- Verify the learner's findings, summarise their presentation and help them draw the final conclusion.
- Let the learners understand that if  $n=a^x$ , then  $a^x$  is the index notation of  $n$  where  $a$  is the base and  $x$  is the index.
- Guide the learners in doing example 1.1 page 2 learners book and ask them to do exercise 1.1 page 2 learners book. Move around the class as you check their working and helping those with problems.

### Answers to activity 1.1 learner's book page 1

a)  $16 = 2 \times 2 \times 2 \times 2$

$81 = 3 \times 3 \times 3 \times 3$

b)  $16 = 2^4$

$81 = 3^4$

### 1.1.2 Properties of Indices

By the end of the section, the learner should be able to:

- Give properties of indices
- Perform calculations on properties at indices.

#### 1.1.2 (a) Multiplication law of indices

##### Teaching guidelines 1.1.2 (a)

- Prepare the learners to do activity 1.2 page 3 working in pairs on multiplication laws of indices. The pairs should constitute learners of

different academic ability, gender and learners with disability if any.

- Ask the learners to do activity 1.2 on page 3 in learner's book as you move around supervising and helping those who may need help.
- Allow presentations and thereafter explain concepts that can help them draw conclusions and understand that  $a^x \times a^y = a^{(x+y)}$ .
- Involve them in a formative assessment.
- Guide the learners in doing examples 1.2 to 1.4 page 3 and 4 in learner's book on multiplication laws of indices in the learners book and let them do exercise 1.2 page 4 in learner's book. Move around the class as you check their working and helping those with problems.

### Answers to activity 1.2 learners book page 3

a)  $32 = 2 \times 16$

$81 = 3 \times 27$

b)  $32 = 2^1 \times 2^4 = 2^{(1+4)} = 2^5$

$81 = 3^1 \times 3^3 = 3^{(1+3)} = 3^4$

#### 1.1.2 (b) Division laws of indices

##### Teaching guidelines 1.1.2 (b)

- Organise the learners to work in pairs. The pairs should comprise of learners with different abilities and of different gender. Those with

disabilities should also be given a role to play within the pairs.

- Ask the learners to do activity 1.3 page 4 in the learners book, division laws of indices.
- Help the learners in writing the quotient as a result of the dividend and a divisor. The learners should give a dividend which is larger than the divisor.
- Ensure that every member at the pair is participating actively so that learning takes place to all learners.
- After the discussion in the pairs, help the learners to write the dividend, divisor and quotient in index notation to help them draw the conclusion.
- Let the learners understand that  $a^m \div a^n = \frac{a^m}{a^n} = a^{m-n}$
- Let the pairs compare their conclusions with other classmates and help them draw a conclusion that will help in handling examples 1.5 and 1.6 in the learners's book page 5.
- Allow the learners to attempt exercise 1.3 page 5 and 6 in the learner's book as you move round checking as they work.

### Answers to activity 1.3 learners book page 4

1. a) 164                      b)  $3 = 8127$   
2. a)  $4 = \frac{2^4}{2^2}$                       b)  $3 = \frac{3^4}{3^3}$

3. Learners should apply the rule that when dividing the same bases, we subtract powers and therefore,

a)  $\frac{2^4}{2^2} = 2^{4-2} = 2^2 = 4$

b)  $\frac{3^4}{3^3} = 3^{4-3} = 3^1 = 3$

### 1.1.2 (c) Powers of powers Teaching guideline.

- Organise the class to work in groups of three learners. The groups should be composed of both genders, learners with disability and learners with different educational abilities.
- Help the learners to do activity 1.4 page 6 in the learners book on the power of powers laws.
- Invite one of the members of the group to present what they have discussed as the rest of the learners are observing and pointing out mistakes during presentation.
- Learners find the fact that we open the bracket by multiplying challenging therefore give make it as interactive as possible.
- They should have found that  $(a^x)^y = a^x \times y = a^{xy}$
- Guide the learners to do example 1.7 page 6 in the learners book and then do exercise 1.4 page 7 in the learners book as you go round checking as they work. This helps you to identify those learners with problems and be able to help them.

## Answers to activity 1.4 learners book page 6

1 a)  $4=2 \times 2=2^2$

$$27=3 \times 3 \times 3=3^3$$

b)  $4^2=16$

$$27^2=729$$

c)  $4^2 = (2^2)^2 = 2^4$

$$27^2 = (3^3)^2 = 3^6$$

The indices of the numbers 4 and 27 are half the indices of the squares of 4 and 27.

### 1.1.2 (d) Zero index

#### Teaching guidelines.

- Organise the class to work in pairs. The pairs should comprise of both genders if any and learners with disability.
- Ask the learners to do activity 1.5 in the learners book page 7 on zero index.
- Ensure that every member in the pairs is actively participating so that learning takes place to all learners.
- Let the group leaders discuss their findings and compare them with other group's findings.
- Ensure that the learners are using the division laws of indices to draw a conclusion on zero index.
- The learners must have found that  $a^0 = 1$  for all value of  $a$ .
- Guide the learners in doing example 1.8 on page 8 and 9 in the learners book and ask them to do exercise

1.5 page 8 in the learner's book and check as they work.

## Answers to activity 1.5 Learners book page 7

1. a)  $3^4 \div 3^4 = 3^{4-4} = 3^0 = 1$

b)  $5^7 \div 5^7 = 5^{7-7} = 5^0 = 1$

c)  $a^3 \div a^3 = a^{3-3} = a^0 = 1$

2. Learners should observe that as long as  $a > 0$  and  $a \neq 1$  then  $a^0 = 1$

“Any number above zero and not equal to one raised to power zero gives the result as one”

### 1.1.2 (e) Negative indices

#### Teaching guideline.

Shortly revisit the topic on integers especially those that give negative results.

- Organise the learners to work in groups of three. Gender composition and disability should be considered when organising the groups.
- Let the learners do activity 1.6 in the learners book page 8 on negative indices.
- Help the groups to write the indices in both index notation and fraction form.
- The learners draw a conclusion and help them to come up with the negative indices law.
- Let the learners understand that for any number raised to a negative power i.e.  $a^{-n} = \frac{1}{a^n}$ .



- Let the learners attempt the example 1.9 on page 9 in the learners book and ask them to do exercise 1.6 given in the learners book page 9 and 10 as you go round checking to correct them.

### Answers to activity 1.6 Learners book Page 8

1 a)  $5^7 \div 5^3 = 5^{7-3} = 4^4$

b)  $5^3 \div 5^7 = 5^{3-7} = 5^{-4}$

2.  $5^{-4} = \frac{5^0}{5^4} = \frac{1}{5^4} = \frac{1}{625}$

Learners should apply division laws of indices in this activity.

### 1.1.2 (f) Fractional indices Teaching guideline.

- Prepare the learners to do activity 1.7 in the learners book, page 10. The learners should work in groups of three learners. The groups should comprise of learners with disability (if any), learners of different academic abilities and gender.
- Let the learners do activity 1.7 in the learner's book page 10 on fractional indices as you move around supervising and helping those who may need help.
- Ensure that the learners use the division laws of indices to solve the given examples.
- Let the group leaders present their findings as you help them correct the mistakes they have done.

- The learner should be able to show that  $\frac{1}{a^2} = a^{-2}$  and  $\frac{1}{a} = a^{-1}$
- Summarise the learner's findings and help them in doing examples 1.10 to 1.13 in the learner's book, page 11 and 12. Ask the learner to do exercise 1.7 on page 12 of the learners book as you move round helping those with problems.

### Answers to activity 1.7 Learners book page 10

1.  $3^{\frac{1}{2}} = \sqrt{3}$

2. The indices are reducing by half while the results are the square roots of the proceeding results.

3.  $3^4 = 81$  and  $\sqrt{81} = 9$

$3^2 = 9$  and  $\sqrt{9} = 3$

$3^1 = 3$  and  $\sqrt{3} \approx 1.7$  (By calculator)

### 1.1.3 Simple equations involving indices

By the end of this section, the learner should be able to apply properties of indices to simplify mathematical expressions.

### Teaching guidelines 1.1.3

- Organise the learners into groups of three.
- Let the learners attempt activity 1.8 in the learner's book page 12 on finding the unknown number x.

- Ensure that the learners express the numbers given to the same base.
- Allow presentation and thereafter explain concepts on simple equations involving indices for examples,

$$\text{When } 2^2 = 2^y, \text{ then } y = 2$$

$$\text{and when } y^2 = 3^2, \text{ then } y = 3$$

- Assist the learners in doing examples 1.14 to 1.16 given in their learner's book pages 13 and 14 and move round checking their working.
- Guide the learners through examples 1.14 to 1.16 in the learners book.
- Let the learners do exercise 1.8 on page 14 in the student book.
- Summarise to the learners the application of indices in various activities like in calculating compound interest in banks and societies.

### Answers to activity 1.8 learners book page 12

$$\text{a) } 2^x = 4 \Rightarrow 2^x = 2^2 \Rightarrow x = 2$$

Learners should express 4 in index notation and then observe that it is only 2 that can be raised to power 2 to give the result as 4.

### 1.2 Standard form

By the end of this section, the learner should be able to express any given large numbers and small numbers in standard form.

### Teaching guidelines 1.2

- Organise the learner to work in pairs. The pairs should be composed of learners with disability (if any) and of different genders.
- Ensure that every learner is actively participating to enhance learning to all the learners.
- Assist the learners to write the numbers given in their learners book to base 10 on page 14.

$$\text{For example } 10\,000 = 10^5$$

$$0.001 = 10^{-3}$$

- Let the pairs compare their findings and discuss it with other learners.
- Summarise their findings and guide them in doing the given example 1.17 on page 15 in their learner's book.
- Ensure that they can write large numbers in standard form and very small numbers in standard form.

$$\text{For example } 0.0071 = 7.1 \times 10^{-3}$$

$$1\,073\,537 = 1.073\,537 \times 10^6$$

Ask the learners to do exercise 1.9 on page 15 in the learners book as you move round the class checking to correct those who have made errors.

### Answers to activity 1.9 learners book page 14

$$\text{(a) } 1\,000 = 1 \times 10^3$$

$$\text{(b) } 100\,000 = 1 \times 10^5$$

$$\text{(c) } 10 = 1 \times 10^1$$

(d)  $1 = 1 \times 10^0$

(e)  $0.001 = 1 \times 10^{-3}$

(f)  $7000 = 7 \times 10^3$

### 1.3 Surds

By the end of this section, the learner should be able to define and give examples of surds.

#### Materials

- Manilla paper
- Pair of scissors
- Ruler

#### Teaching guidelines 1.3

- Organise the learners into groups of three learners considering their academic abilities and gender.
- Help the learners in arranging the materials for the activity 1.10 in the learner's book page 15.
- Ensure that each group member is actively participating so that they can all help in drawing conclusions
- Let the group leaders discuss their findings and compare with other groups.
- Summarise the activity and help the learners to draw a conclusion.
- Help the learner to define and give examples of surds.

#### Answers to activity 1.10 learners book page 15

This is a practical activity. The teacher should provide pieces of manilla papers to the learners and should ensure that all learners have mathematical sets.

A teacher should also observe that area of triangles obtained (right-angled triangles) can be calculated from the formula  $Area = \frac{1}{2} \times base \times height$

#### Qualities of Surds

By the end of this section, the learners should be able to state and explain properties of surds.

#### Teaching guidelines 1.3.1

- Help the learners to do research on properties of surds by providing relevant materials.
- Ask the learners to present their findings on properties of surds individually.
- Summarise the key properties of surds and help them draw conclusions.
- Let the learners understand that if  $a$  and  $b$  are both rational,  $\sqrt{x}$  and  $\sqrt{y}$  are both surds, and  $a + \sqrt{x} = b + \sqrt{y}$  then  $a = b$  and  $x = y$ .

#### 1.3.2 Simplification of surds

By the end of this section, the learner should be able to simplify surds by using properties of surds.

## Teaching guidelines 1.3.2

- Organise the learners into pairs with consideration to both gender and academic ability.
- Ask the learners to do activity 1.11 in the learners book page 16 on simplification of surds.
- Let the pairs present their workings as you correct the areas where they have made a mistake.
- Summarise the learner's workings and draw the conclusion for the learners.
- Let the learners understand that
$$\sqrt{xy} = \sqrt{x} \times \sqrt{y}$$
and
$$\sqrt{\frac{x}{y}} = \frac{\sqrt{x}}{\sqrt{y}}$$
- Let the learners do example 1.18 and 1.19 in the learners book page 17 then do exercise 1.10 on page 17 in the learners book.

### Answers to activity 1.11 learners book page 16

- $\sqrt{xy} = \sqrt{25 \times 4} = \sqrt{100} = 10$   
 $\sqrt{x} \times \sqrt{y} = \sqrt{25} \times \sqrt{4} = 5 \times 2 = 10$   
In conclusion therefore,  $\sqrt{xy} = \sqrt{x} \times \sqrt{y}$
- $\sqrt{\frac{x}{y}} = \sqrt{\frac{25}{4}} = \sqrt{6.25} = 2.5$   
 $\frac{\sqrt{x}}{\sqrt{y}} = \frac{\sqrt{25}}{\sqrt{4}} = \frac{5}{2} = 2.5$   
In conclusion,  $\sqrt{\frac{x}{y}} = \frac{\sqrt{x}}{\sqrt{y}}$
- $\sqrt{x+y} = \sqrt{25+4} = \sqrt{29} = 5.38$   
 $\sqrt{x} + \sqrt{y} = \sqrt{25} + \sqrt{4} = 5 + 2 = 7$   
Hence  $\sqrt{x} + \sqrt{y} \neq \sqrt{x+y}$

4. Basing on proof from number 3, this means that  $\sqrt{x} - \sqrt{y} \neq \sqrt{x-y}$  as well.
5.  $5\sqrt{x} = 5\sqrt{25} = 5 \times 5 = 25$   
and  $\sqrt{5x} = \sqrt{5 \times 25} = \sqrt{125} = 11.18$   
Therefore,  $\sqrt{5x} \neq 5\sqrt{x}$
6.  $5\sqrt{x} = 5\sqrt{25} = 5 \times 5 = 25$   
and  $\sqrt{25x} = \sqrt{25 \times 25} = \sqrt{625} = 25$   
Therefore,  $\sqrt{25x} = 5\sqrt{x}$

## 1.3.3 Operation of surds

By the end of this section, the learner should be able to perform basic operations involving:

- (i) Addition and subtraction of surds
- (ii) Multiplication at surds

### (a) Addition and subtraction of surds

#### Teaching guidelines 1.3.3 (a)

- Organise the learners to work in pairs
- Review the topic on addition of algebra with consideration on operation of algebra. For example  
 $a + a = 2a$   
 $6a - 3a = 3a$
- Help the learners relate the concept of algebra with the surds.
- Let the learners compare their workings and help them draw a conclusion that:  
 $a\sqrt{x} \pm b\sqrt{x} = (a \pm b)\sqrt{x}$
- Take the learners through activity 1.12 on page 17 and 18 in the learners book making sure that

they factorise all the common terms before carrying out addition and subtraction.

- Let the learners do activity 1.13 on page 18 of the learners book on multiplication of surds in pairs.
- Ensure that they use the algebraic examples to derive the conclusion for multiplication of indices.
- Summarise on the learner's workings and help them in solving examples from the learners book.
- Learners should be able to understand that to be able to add or subtract surds, they must contain roots of the same number. Therefore:  
 $a\sqrt{x} + b\sqrt{x} = (a + b)\sqrt{x}$
- Guide the learners through examples 1.20 - 1.22 page 18 and 19 in the learners book.
- Let the learners attempt exercise 1.11 on page 19 in the learners book as you go round checking to correct those who have problems.

### Answers to activity 1.12 Learners book page 17-18

1. (a)  $x + x = 2x$       (b)  $3x - 2x = x$

2. (a)  $\sqrt{3} + \sqrt{3} = 2\sqrt{3}$     (b)  $3\sqrt{3} - 2\sqrt{3} = \sqrt{3}$

### Answers to activity 1.13 Learners book page 18.

1. (a)  $3x + 2y = 6xy$       (b)  $7x \times z = 7xz$

2.  $x = \sqrt{3}$ ,  $y = \sqrt{5}$ ,  $z = \sqrt{7}$

3. (a)  $6xy = 6\sqrt{3} \times \sqrt{5} = 6\sqrt{15}$

(b)  $7xz = 7\sqrt{3} \times \sqrt{7} = 7\sqrt{21}$

## (b) Division of surds

### Rationalisation of denominator

By the end of this section, the learners should be able to simplify surds by rationalising the denominator.

### Teaching guidelines 1.3.3 (b)

- Organise the learners into pans.
- Revisit the third law on solving quadratic equation. i.e  
 $a^2 - b^2 = (a + b)(a - b)$
- Help the pairs in solving the activity 1.14 page 20 in learners book on rationalising the denominators.
- Take the learners through activity 1.15 and 1.16 on page 20 and 21 in learners book on rationalising of monomial and binomial denominators respectively.
- Let the learners attempt rationalising monomial and binomial surds.
- Ensure that all learners are actively participating to ensure that they learn the concept.
- Summarise on rationalising the denominator and define a conjugate and give an example.
- Learners should understand that to rationalise a denominator, we multiply both the numerator and

denominator by the conjugate of the denominator.

- The learners in doing examples 1.23 – 1.25 on pages 20 and 21 in learners book given in monomial and binomial surds.
- Let the learners do the exercise 1.12, on page 22 given in the learners book as you move round checking.

**Answers to activity 1.14 learners book Page 20.**

- (a)  $\sqrt{3} \times \sqrt{3} = \sqrt{9} = 3$   
 (b)  $2\sqrt{5} \times 2\sqrt{5} = 4\sqrt{25} = 4 \times 5 = 20$
- When rationalizing, we aim at removing the root from the denominator. This is achieved by multiplying the denominator to itself and the numerator.
- 

$$(a) \frac{2}{\sqrt{3}} = \frac{2 \times \sqrt{3}}{\sqrt{3} \times \sqrt{3}} = \frac{2\sqrt{3}}{\sqrt{9}} = \frac{2\sqrt{3}}{3}$$

$$(b) \frac{\sqrt{7}}{\sqrt{5}} = \frac{\sqrt{7} \times \sqrt{5}}{\sqrt{5} \times \sqrt{5}} = \frac{\sqrt{7} \times \sqrt{5}}{\sqrt{25}} = \frac{\sqrt{35}}{5}$$

**Answers to activity 1.15 Learners book page 20**

Rationalising the denominator involves multiplying the denominator by its conjugate.

$$(a) \frac{1}{\sqrt{3}} = \frac{\sqrt{3}}{\sqrt{3} \times \sqrt{3}} = \frac{\sqrt{3}}{\sqrt{9}} = \frac{\sqrt{3}}{3}$$

$$(b) \frac{3}{\sqrt{7}} = \frac{3\sqrt{7}}{\sqrt{7} \times \sqrt{7}} = \frac{3\sqrt{7}}{\sqrt{49}} = \frac{3\sqrt{7}}{7}$$

**Answers to activity 1.16 Learners book page 21**

Learners should understand the conjugate and the method of difference of two squares.

The conjugate of  $2 + \sqrt{3}$  is  $2 - \sqrt{3}$

Difference of two squares

$$(a - b)(a + b) = a^2 - b^2$$

To rationalise  $\frac{1}{2 + \sqrt{3}}$ , learners should multiply the numerator and the denominator by the conjugate of the denominator.

$$\frac{1}{2 + \sqrt{3}} = \frac{1}{(2 + \sqrt{3})} \times \frac{(2 - \sqrt{3})}{(2 - \sqrt{3})} = \frac{2 - \sqrt{3}}{(2)^2 - (\sqrt{3})^2} = \frac{2 - \sqrt{3}}{(2)^2 - 3} = \frac{2 - \sqrt{3}}{4 - 3} = 2 - \sqrt{3}$$

**1.4 Square roots**

**1.4.1 By Estimation method**

By the end of this section, the learner should be able to estimate square roots.

**Teaching guidelines 1.4.1**

- Organise the learners into groups of three.
- Ask the learners to do activity 1.17 in the learners book page 22 that deals with finding the square roots of common numbers by estimation method.
- Use the given square roots to estimate the square roots of numbers between two known squares.
- Summarise how the learners can estimate square roots of numbers.
- Ask the learners to do exercise 1.13, on page 23 in the learners book

as you move around checking and helping those with problems.

**Answers to activity 1.17 learners book page 22**

1. (a)  $\sqrt{4} = 2$

(b)  $\sqrt{9} = 3$

2. To estimate  $\sqrt{5}$ , learners should know that it is between  $\sqrt{4}$  and  $\sqrt{9}$

$$\sqrt{4} < \sqrt{5} < \sqrt{9}$$

$2 < \sqrt{5} < 3$  The square root of 5 is between 2 and 3. If we get  $2.2 \times 2.2 = 4.84$

$$2.3 \times 2.3 = 5.29$$

The approximate value can be 2.24

**1.4.2 Factorisation method**

By the end of the section, the learner should be able to find square roots by factor method.

**Teaching guidelines 1.4.2**

- Organise the learners into pairs
- Ask the learners to find prime factors of the given numbers. The factors should be of prime numbers.
- Let the learners do activity 1.18 on the learners book page 23 on finding square roots by factor method.
- Summarise how the learners can find square root by factor method.
- Ask the learners to do exercise 1.14 page 25 in the learners book question 1 as you check their working.

**Answers to activity 1.18 learners book page 23**

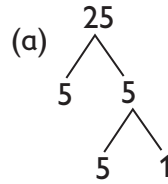

$$25 = 5 \times 5 = 5^2$$

(a)

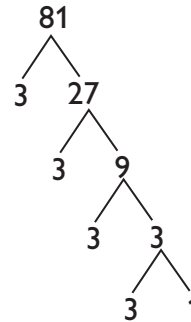

$$81 = 3 \times 3 \times 3 \times 3 = 3^4$$

2. (a)  $\sqrt{25} = (5^2)^{\frac{1}{2}} = 5$

(b)  $\sqrt{81} = (3^4)^{\frac{1}{2}} = 3^2 = 9$

**1.4.3 General method**

By the end of the section, the learner should be able to find square roots by general method.

**Teaching guidelines 1.4.3**

- Organise the learners into pairs.
- Guide the learners in doing examples on square root by general method given in the learners book.
- Summarise how the learners can find square root by general method.
- Ask the learners to do exercise 1.14 question 2 on page 25 in learners book as you check their working.

## ANSWERS

### Exercise 1.1 (learners book page 2)

- (a)  $5^2$  (b)  $4^3$  (c)  $7^2$  (d)  $10^3$
- (a)  $2a^3$  (b)  $3y^2$  (c)  $147h^4$   
(d)  $3ab^5$  (e)  $3^2a^4$
- (a)  $2^1$  (b)  $2^3$  (c)  $2^5$  (d)  $2^4$   
(e)  $2^6$  (f)  $2^7$
- (a) 108 (b) 144 (c) 144 (d) 100  
(e) 80 000 (f) 6 400 000
- (a) 12 (b) 40 (c) 36  
(d) 24 (e) 64
- (a) 6 (b) 4 (c) 3
- $2^3 \times 3^2 \times 5^4$
- $2^3 \times 3^2; 2^2 \times 3^3$

### Exercise 1.2 (learners book page 4)

- (a)  $a^6$  (b)  $n^{12}$  (c)  $p^8$  (d)  $5^{13}$   
(e)  $p^{12}$  (f)  $z^{20}$  (g)  $t^{12}$
- (a)  $2^4$  (b)  $3^5$   
(c)  $3^3 \times 7^2$  (d)  $10^8$
- (a)  $8x^8y^5z^2$  (b)  $10x^7$   
(c)  $18x^5y^6$  (d)  $8a^5b^3$

### Exercise 1.3 (learners book page 5 and 6)

- (a)  $2^3$  (b)  $2^3$  (c)  $2^3$  (d)  $4^1$   
(e)  $2^5$  (f)  $2^5$  (g)  $2^2$  (h)  $5^2$
- (a)  $4^3$  (b)  $4^4$  (c)  $10^2$  (d)  $h^{10}$   
(e)  $a^3$  (f)  $g^3$  (g)  $g^5$  (h)  $p^4$   
(i)  $h^0$  (j)  $a^2$
- (a)  $2a^2$  (b)  $x^5y$  (c)  $2xy^2$   
(d)  $7a^2bc$  (e)  $7p^8q^5r^2$
- (a)  $81x^6y^4z^6$  (b)  $9x^2y^2z^2$   
(c)  $729x^8y^6z^8$  (d)  $9x^4y^2z^4$

### Exercise 1.4 (learners book page 7)

- (a) 225 (b)  $8a^3b^3$  (c) 1  
(d)  $x^6y^6$
- (a)  $\frac{9}{25}$  (b)  $\frac{x^5}{y^5}$  (c)  $\frac{p^3}{q^3}$   
(d)  $\frac{27}{343}$  (e)  $\frac{x^7}{y^7}$

3. (a)  $\frac{x^4}{y^2}$  (b)  $\frac{n^{2x}}{m^2}$  (c)  $x^4$   
(d)  $\frac{a^5b^{10}}{c^5}$

4. (a) 6 (b) 100 (c)  $\frac{1}{7}$   
(d) 729 (e) 16

5. (a)  $6^{-2}$  (b)  $y^{-4}$  (c)  $2^{-9}$   
(d)  $z^{-8}$  (e)  $a^{-3}$  (f)  $\frac{x^{-3}}{2}$

6.  $x^2$  7.  $x$  8.  $x^4, x^3, x^2$

### Exercise 1.5 (learners book page 8)

1. 1 2. 1 3. 1

4. 1 5.  $\frac{y}{z}$  6. 1

### Exercise 1.6 (learners book page 9 and 10)

1. (a)  $\frac{1}{16}$  (b) 216 (c)  $\frac{1}{2^{12}}$   
(d)  $128 + \frac{1}{9}$  (e)  $7^{12}$

2. (a) 1 (b)  $\frac{-1}{4x}$  (c) 4  
(d)  $14x$  (e) 1 (f)  $5 + y$

3. (a) (i)  $6^{-3}$  (ii)  $3^4$  (iii) 1 (iv) 5  
(b) (i)  $\frac{1}{4}$  (ii) 4 (iii)  $\frac{1}{5}$  (iv)  $\frac{4}{1000}$

(c) (i)  $\frac{1}{4}$  (ii) 1 (iii)  $\frac{1}{10}$  (iv) 2

(v) 1 (vi) 32 (vii) 6

(d) (i) 64 (ii) 2 (iii)  $\frac{1}{5^5}$  (iv) 5

4. (a)  $\frac{1}{a^3}$  (b)  $m^{15}$  (c)  $\frac{2}{x^4}$  (d)  $x^3$

5. (a)  $x^{10}$  (b)  $a^{10}$  (c) 1  
(d) 1 (e)  $x$  (f)  $x^{14}$

6. (a)  $\frac{1}{x^6}$  (b)  $\frac{1}{y^3}$  (c)  $\frac{1}{2}$   
(d)  $\frac{1}{p^8}$  (e)  $\frac{1}{q^4}$  (f)  $\frac{3^4}{x^2}$



7. (a)  $\frac{1}{11}$  (b) 1 (c)  $\frac{1}{32}$   
 (d)  $\frac{1}{81}$  (e)  $\frac{1}{144}$

**Exercise 1.7** (learners book page 12)

1. (i)(a) 3 (b) 2 (c) 2 (d) 5  
 (e) 3  
 (ii)(a) 2 (b) 9 (c) 4 (d) 32  
 (e) 6  
 2. (a)  $16\frac{1}{3}$  (b) 21 (c)  $-\frac{3}{4}$   
 (d)  $16\frac{15}{16}$  (e) 2 (f) 768  
 3. 252

**Exercise 1.8** (learners book page 14)

1.  $x = 5$  2.  $\frac{3}{2}$  3.  $x = 2$   
 4.  $x = 3$  5.  $x = 2$  6.  $p = -6$   
 7.  $x = 6$  8.  $x = \frac{-3}{2}$  9.  $x = 4$   
 10.  $n = 0$  11.  $n = \frac{1}{8}$  12.  $n = -2$   
 13.  $n = \frac{-3}{2}$  14.  $n = \frac{-1}{2}$  15.  $n = \frac{-1}{4}$   
 16.  $x = \frac{1}{7}$  17.  $n = 0$  18.  $n = 0$   
 19.  $n = 12$  20.  $n = 9$  21.  $n = -2$   
 22.  $n = 8$  23.  $n = -8$  24.  $n = -12$   
 25.  $n = \frac{1}{2}$  26.  $x = 4$  27.  $= 0.65$   
 28.  $n = -3.5$  29.  $n = 2$  30.  $x = 2$   
 31.  $x = -\frac{1}{2}$  32.  $x = 1$   
 33.  $n = -3m - 5$

**Exercise 1.9** (learners book page 15)

1. (a)  $6.01 \times 10^2$  (b)  $4.23 \times 10^4$   
 (c)  $6.001 \times 10^3$  (d)  $4.3292 \times 10^6$   
 (e)  $1.0 \times 10^8$  (f)  $7.5 \times 10^4$   
 (g)  $5.61 \times 10^{-4}$  (h)  $3.2 \times 10^{-7}$

2. (a)  $1.4018 \times 10^4$  (b)  $2.8331 \times 10^4$   
 (c)  $2.125 \times 10^2$  (d)  $4.83 \times 10^2$   
 (e)  $5.67 \times 10^5$  (f)  $1.1 \times 10^3$   
 (g)  $5.268 \times 10^3$  (h)  $9.6 \times 10^3$

**Exercise 1.10** (learners book page 17)

1. (a)  $2\sqrt{3}$  (b)  $3\sqrt{5}$  (c)  $6\sqrt{2}$   
 (d)  $\sqrt{5}\sqrt{7}$  (e)  $5\sqrt{2}\sqrt{5}$  (f)  $12\sqrt{3}$   
 (g)  $2\sqrt{31}$  (h)  $2\sqrt{3}\sqrt{11}$   
 2. (a)  $\sqrt{20}$  (b)  $\sqrt{32}$  (c)  $\sqrt{63}$   
 (d)  $\sqrt{147}$  (e)  $\sqrt{84}$  (f)  $\sqrt{1000}$   
 (g)  $\sqrt{2100}$  (h)  $\sqrt{2160}$   
 3. (a)  $5\sqrt{2}$  (b) 8 (c)  $3\sqrt{2}\sqrt{5}$   
 (d)  $5\sqrt{3}$  (e) 12 (f) 60  
 (g) 60 (h)  $6\sqrt{2}\sqrt{3}\sqrt{5}$   
 4. (a)  $\frac{1}{2\sqrt{5}}$  (b)  $\frac{4}{x^3}$  (c)  $\sqrt{2}$   
 (d)  $\sqrt{2}\sqrt{3}$  (e)  $\frac{\sqrt{3}}{2}$  (f)  $\frac{1}{4}$   
 (g)  $6\sqrt{2}\sqrt{5}$

**Exercise 1.11** (learners book page 19 and 20)

1. (a)  $9\sqrt{3}$  (b)  $17\sqrt{5}$  (c)  $6\sqrt{2}$   
 (d)  $-5\sqrt{7}$  (e)  $-\sqrt{11}$  (f)  $3a\sqrt{x}$   
 (g)  $15\sqrt{5}$  (h)  $-88\sqrt{2}$  (i)  $43\frac{1}{2}\sqrt{6}$   
 (j)  $4\frac{3}{4}\sqrt{6}$   
 2. (a)  $\sqrt{21}$  (b)  $35\sqrt{33}$   
 (c)  $4\sqrt{35}$  (d) 27  
 (e)  $192\sqrt{3}$  (f)  $200x^2\sqrt{x}$   
 3. (a)  $19 + 8\sqrt{3}$   
 (b)  $9 + 2\sqrt{2}\sqrt{7}$   
 (c)  $14 - 6\sqrt{5}$   
 (d)  $8 - 2\sqrt{3}\sqrt{5}$   
 (e)  $\sqrt{2} \times \sqrt{7} + \sqrt{5} \times \sqrt{7} - \sqrt{2} \times \sqrt{5} - 2$

$$4\sqrt{7} - \sqrt{5}\sqrt{7} + 4\sqrt{7} - 16$$

(f)  $4\sqrt{7} - \sqrt{5}\sqrt{7} + 4\sqrt{5} - 16$

(g) 5            (h) -7

**Exercise 1.12** (learners book page 22)

1. (a)  $\sqrt{13}$                       (b)  $2 - \sqrt{17}$

(c)  $\sqrt{3} + 7$                     (d)  $\sqrt{3} + \sqrt{8}$

(e)  $2\sqrt{5} - 3\sqrt{4}$                 (f)  $3\sqrt{x} - b\sqrt{y}$

2. (a)  $\frac{4\sqrt{11}}{11}$                         (b)  $\frac{2\sqrt{3}}{3}$

(c)  $\sqrt{13}$                         (d)  $\frac{9}{5}\sqrt{2}\sqrt{5}$

3. (a)  $\frac{5\sqrt{5} - 20}{-11}$                         (b)  $\frac{35}{14} - \frac{7\sqrt{11}}{14} = \frac{5}{2} - \frac{\sqrt{11}}{2}$

(c)  $\frac{2\sqrt{3}(\sqrt{5}-2)}{3}$                             (d)  $5\sqrt{21} + 5\sqrt{14} = 5(\sqrt{21} + \sqrt{14})$

(e)  $\frac{63 + 6\sqrt{35}}{43}$                             (f)  $\frac{9\sqrt{7} - 9\sqrt{11}}{-12}$

(g)  $\frac{6 + 5\sqrt{6}}{19}$                             (h)  $\frac{6 - 5\sqrt{22}}{20}$

(i)  $\frac{\sqrt{7} - 3\sqrt{14} - 2\sqrt{3} + 6\sqrt{6}}{-17}$

(j)  $\frac{85 + 7\sqrt{143}}{-2}$

4. (a) 0.47    (b) 0.99    (c) 0.10    (d) 5.13

5. (a)  $2x(3y + 1)$     (b)  $x(2y - 3)$

(c)  $\frac{2(y - x)}{2xy - 5}$                     (d) -3

**Exercise 1.13** (learners book page 23)

1. (a) 8            (b) 12            (c) 20

(d) 13            (e) 1.4            (f) 0.06

2. (a) 121,144            (b) 400,441

(c) 1 369,1 444    (d) 2 916,3 025

3.  $\sqrt{7}$

5. (a) 2            (b) 3            (c) 6

(d) 11            (e) 31            (f) 99

**Exercise 1.14** (learners book page 25)

1. (a) 13            (b) 9

(c) 32

2. (a) 19            (b) 22

(c) 21.07 (2 d.p)    (d) 28.79 (2 d.p)

(e) 54.77 (2 d.p)

**Unit 1 Test**

1.  $\frac{2}{3}$

2. 1

3.  $\frac{9}{4}$

4. (a)  $22 + 5\sqrt{10}$             (b)  $y + 2\sqrt{y} - 15$

(c)  $4 + 2\sqrt{3}$                     (d)  $9 - 4\sqrt{5}$

5. 2.11 (2 d.p)

6. (a) 2            (b) 3

(c)  $\frac{4}{3}$

7. (a)  $\frac{2\sqrt{3}}{3}$                             (b)  $\frac{4 - 2\sqrt{7}}{-3}$

(c)  $\frac{5\sqrt{5} - 20}{-11}$                         (d)  $\frac{9\sqrt{7} + 9\sqrt{11}}{-12}$

8. (a)  $\sqrt{7} + \frac{7\sqrt{3}}{3}$

(b)  $\frac{8\sqrt{3}\sqrt{5}}{15}$

(c)  $\frac{2\sqrt{2}\sqrt{7}}{2}$

(d)  $\frac{84 - 7\sqrt{14} - 6\sqrt{10} + \sqrt{35}}{65}$

9. (a) 8            (b) 15

(c) 36            (d) 28

10. 6.3246

# Algebra

## Unit 2

## POLYNOMIALS

Learner's Book pages 27 - 57 (30 Lessons)

### Key unit competence

By the end of this unit, the learner should be able to perform operations, factorise polynomials and solve related problems.

### Content outline

2.1 Introduction to polynomials

2.2 Operations on polynomials

2.3 Identities

Answers

### Learning objectives

#### Knowledge and understanding

- Define polynomial
- Classify polynomials by degree and number of terms
- Recognize operation properties on polynomials
- Give common factor of algebraic expression

#### Skills

- Perform operation of polynomials
- Expand algebraic expression by removing brackets and collecting like terms

- Apply operation properties to carry out given operation on polynomials.
- Factorize a given algebraic expression using appropriate methods.
- Expand algebraic identities

#### Attitudes and values

- Appreciate the role of numerical values of polynomials and algebraic identities in simplifying mathematical expressions.
- Develop critical thinking and reasoning
- Ability to classify and able to follow order to perform a given task

#### Generic competence addresses in this unit

- Communication skills

- Critical thinking
- Problem solving
- Research/innovation
- Cooperation, interpersonal management and life skills.

### Links to other subjects

- Physics, Chemistry,

### Cross cutting issues addressed in this unit

- Inclusive education
- Inclusive education
- HIV and AIDS
- Financial education
- Environment sustainability

### Assessment criteria

Perform operations, factorise polynomials and solve related problems.

### Background information

Learners have been introduced to algebra and thus they can easily relate it to polynomials. This topic enlightens the learner on the basic concepts of dealing with equations and how they can solve them. This makes the topic practical. For example, the learners need to know how to find unknowns using the known information and how they can solve problems using the unknown. The activities provided help the learner to be conversant with the polynomials thus understand the concepts easily. Guide

the learners through all the examples and ensure that they do more exercises on the concepts introduced in this unit.

## 2.1 Introduction

By the end of this section, the learner should be able to identify and define the following: monomial, trinomial, polynomial and homogeneous polynomial:

**Materials:** access to internet, reference material and books.

### Teaching guidelines 2.1

- Organise the learners into groups of four or five. Let them choose a group secretary and a group leader.
- Ask the groups to do activity 2.1 on page 27 of learner's book. Ensure The group secretary to record their findings clearly enough and report the group's findings at the end of the activity.
- As they present, verify that their observations are accurate, correct those that may be wrong correct them and summarise the learning points as illustrated in the learner's book.
- That is, the meaning or explanation of the terms a **monomial**, **binomial**, **trinomial**, **polynomial** and **homogenous polynomials**.
- Discuss the last part of this activity with the whole class.

- Invite them to formulate more homogenous polynomial for you to assess their competence.
- Homogenous polynomial is a polynomial containing two or more variables with every term of the same degree example,  
 $xy^2 + x^2y + 3x^2$ .
- Ask learners to do exercise 2.1 on page 28 in learner's book.
- Note that this activity promotes; team work, skills leadership ability to research, communication skills leadership ability, communication skills and self confidence.

### Answers to activity 2.1 learner's book page 27

1. a) One term  
b) Two terms  
c) Three terms  
d) Four terms  
e) Five terms
2. a) One    b) one    c) Two  
d) Three    e) Four
3. a) First degree    b) First degree  
c) Second degree    d) Third degree  
e) Fourth degree

## 2.1 Operations on polynomials

### 2.2.1 Additional and subtraction

By the end of this section, the learner should be able to add and subtract, polynomials.

### Teaching guidelines 2.2.1

- Organise the learners into groups to do activity 2.2 on page 29 in learner's book. Remind them the duty of the group secretary and the group leader.
- When they are done with the activity, ask the group secretaries to present their findings to the whole class.
- Ask them to do their presentations and verify their observations, correct what may be wrong and affirm what is right.
- Conclude the learner's findings, emphasizing the learning points as elaborated in the learner's book. Highlight key points: when simplifying expression first called the like terms together.
- Take learners through examples 2.1 and 2.2 on page 29 and 30 in learner's book.
- Ask learners to do exercise 2.2 on page 31 of learner's book numbers 1 to 6.

### Answers to activity 2.2 learner's book Page 29

- a) Like terms are  $-13x^2, x^2, 5x^2$   
They are combined to give  
 $-13x^2 + x^2 + 5x^2 = -7x^2$

$4x, 3x - 3x$  Are also like terms and they are combined to give  $4x + 3x - 3x = 4x$

Also  $-2, 4, 3$  are also like terms

They are combined to give  $-2 + 4 + 3 = 5$

- b) When all the polynomials are combined, we get  $3x^3 - 13x^2 + 4x - 2 + x^2 + 3x + 4 + 5x^2 - 3x + 3 = 3x^3 - 7x^2 + 4x + 5$

## 2.2.2 Substitution and Evaluation

By the end of this section, the learner should be able to evaluate algebraic expressions for some specific value(s) of the variable(s).

### Teaching guidelines 2.2.2

- Organise the learners into pairs to do activity 2.3 on page 30 in the learner's book.
- Guide them through the activity and allow them to discuss their results.
- Take the learners through the discussion in the learner's book. Emphasise that we use the substitution method to simplify the given expression.
- Take the learners through example 2.3 and 2.4 page 30 in the learner's book.
- Ask learners to do exercise 2.2 on page 31 in learner's book number 7 to 12.

## Answers to activity 2.3 learner's book Page 30

(a)  $x^2 + y + 1 = 2^2 + 3 + 1 = 8$

(b)  $3x^2 + 2y - 3 = 3(2^2) + 2(3) - 3 = 15$

## 2.2.3 Multiplication of monomials

By the end of this section, learners should be able to multiply monomials.

### Teaching guidelines 2.2.3

- Pair up learners to do activity 2.4 on page 32 in the learner's book.
- Ask them to do the activity and guide them
- Guide the learners through the explanation on comparing variables with integers and simplifying the given expressions.
- Take them through example 2.5 on page 32 in the learner's book.
- Ask them to do exercise 2.3 on page 32 in the learner's book.

## Answers to activity 2.4 learner's book Page 30

1.  $4zw$

2. For 5 cars, learners should get  $5 \times 4zw$

3.  $5 \times 4zw = 20zw$

4. (a)  $4 \times 3b = 12b$

(b)  $2a \times 5a^2 = 10a^3$

(c)  $6x \times 2y = 12xy$

(d)  $8d \div 2 = 4d$

(e)  $12y^2 \div 3y = 4y$

(f)  $\frac{15m^3n^2}{3m^2n} = 5mn$

## 2.2.4 Multiplication of a polynomial by a monomial

By the end of this section, the learners should be able to multiply a polynomial by a monomial.

### Teaching guidelines 2.2.4

- Pair up the learners to do activity 2.5 on page 33 in learner's book.
- Invite and encourage learners to demonstrate their observations on the board.
- Help the learners to generalize their findings.
- Summarize the learners' observations and emphasize that when we remove brackets preceded by a negative sign, the sign changes:  $-a(b-c) = -ab + ac$  or  $+a(b-c) = ab - ac$ .
- Take learners through examples 2.6, 2.7 and 2.8 on page 34 in learner's book.
- Ask learners to do Exercise 2.4 on page 35 in learner's book.

### Answers to activity 2.5 learner's book Page 33

1. (a)  $4a + (5 + 3a) = 4a + 5 + 3a = 8a + 5$   
(b)  $4a - (5 - 3a) = 4a - 5 + 3a = 7a - 5$   
(c)  $4a - 2(5 + 3a) = 4a - 10 - 6a = -2a - 10$   
(d)  $4a - 2(-3a - 5) = 4a + 6a + 10 = 10a + 10$
2. (a)  $a - (b + c) = a - b - c$   
(b)  $a - (-b - c) = a + b + c$

## 2.2.5 Multiplication of a polynomial by a polynomial

By the end of this section, learners should be able to multiply polynomials of two or more terms.

### Teaching guidelines 2.2.5

- Work with the whole class and take them through the multiplication of the form  $a(a + b) = a^2 + ab$ .
- Use substitution method to multiply expressions of the form  $(a+b)(x+y) = ax + ay + bx + by$ .
- Step by step emphasize the procedure of multiplying binomials and other polynomials.
- Take the learners through examples 2.9 to 2.12 on page 36 in learner's book.
- Ask learners to do Exercise 2.5 on page 37 in learner's book.

## 2.2.6 Division

### 2.2.6.1 Division of a monomial by a monomial

By the end of this section, the learners should be able to divide any algebraic expression by a monomial.

### Teaching guidelines 2.2.6.1

- Working with the whole class, conduct a class discussion using the

case in the learner's book. Make the discussion as interactive as possible so that all participate.

- Let the learners work in pairs to do activity 2.6 page 37 in the learner's book.
- Encourage learners to present their findings while others listen to the presentation in order to critique it.
- Summarise their findings, emphasizing on the key learning points.
- To solve the expression, we first identify the numerator and denominator then divide the common terms.
- Give out activity 2.7 page 37 in learner's book as an assignment.
- Take learners through example 2.13 on page 36 in learner's book ask them to do exercise 2.6.

### Answers to activity 2.6 learner's book page 37

1. Learners should be able to know that when dividing same bases, we just subtract the indices eg:  $\frac{a^x}{a^y} = a^{x-y}$
2.  $8x^3y^5 \div 4x^2y^3$  The denominator is  $4x^2y^3$  and the numerator  $8x^3y^5$
3.  $\frac{8x^3y^5}{4x^2y^3} = 2x^{3-2}y^{5-3} = 2xy^2$
4.  $2xy^2$

### Answers to activity 2.7 learner's book page 37

a) The numerator has 3 terms

$$b) \frac{16x^2y^3}{2xy} + \frac{8xy^2}{2xy} - \frac{2x^3y^3}{2xy} = 8xy^2 + 4y - x^2y^2$$

## 2.2.6.2 Division of a polynomial

By the end of this section, the learners should be able to divide a polynomial by another.

### Teaching guidelines 2.2.6.2

- Pair up learners into appropriate groups.
- Ask them to do activity 2.8 on page 38 in the learner's book.
- Allow them to discuss their findings with other groups in the class.
- Working with the whole class, emphasize the basic requirements for division to take place.
- Demonstrate to the learners how division by polynomials compares with long division of large numbers i.e.  $\frac{f(x)}{g(x)} = Q + \frac{R}{g(x)}$   
hence,  $f(x) = Q \cdot g(x) + R$
- Take them through the discussion given in the learner's book under this section.
- Guide learners through examples 2.14, 2.15 and 2.16 on page 39 explaining step by step.
- Ask learners to do exercise 2.7 on page 40 in learner's book.



## Answers to activity 2.8 learner's book page 38

$$\begin{array}{r} x + 6 \\ x + 3 \sqrt{x^2 + 9x + 18} \\ - \quad x^2 + 3x \\ \hline \phantom{x + 3} 6x + 18 \\ - \quad 6x + 18 \\ \hline \phantom{x + 3} \phantom{6x + 18} 0 \quad 0 \end{array}$$

Learners can also try the method of factorization but it can only work if the divisor is the factor of dividend.

### 2.2.8 Numerical value of polynomial

By the end of this section, the learners should be able to evaluate the numerical value of a polynomial.

#### Teaching guidelines 2.2.7

- Group the learners into appropriate groups.
- Ask them to do activity 2.9 on page 40 in learner's book.
- Guide the learners through the activity and allow them to compare their results with other groups in class.
- Hold a class discussion on their findings. Correct any error in the learner's findings and any omitted content.
- Guide them through the discussion in the learner's book.

- Take them through example 2.16 on page 40 in learner's book.

## Answers to activity 2.9 learner's book page 40

1.  $2x^2 + 3xy + xy$

2. If  $x = 2$ , and  $y = 3$

Then  $2x^2 + 3xy + xy = 2(2)^2 + 3(2)(3) + 2(3) = 8 + 18 + 6 = 32$

## 2.3 Identities

### 2.3.1 Algebraic identities and equation

By the end of this section, the learners should be able to distinguish between an identity and an equation and how to work with both.

#### Teaching guideline 2.3.1

- Pair up the learners to do activity 2.10 in the learner's book on page 41.
- Ensure that all learners are participating actively. Let the learners know that different people will or may use different values of  $x$  provided the working is correct.
- Let as many pairs of works as possible present their observations while others verify.
- Confirm that the learners' argument is accurate. Summarize the observations and draw appropriate conclusions.

- Take learners through example 2.19 on page 42 in learner's book.
- Ask learners to do exercise 2.8 on page 42 in learner's book.

### Answers to activity 2.10 learner's book page 41

1.  $x^2 = -7x - 12 \quad x^2 + 7x + 12 = 0$

Learners can solve this by trial and error and they can use negative values only since the expression has positive signs only.

For  $x = -2$

$$(-2)^2 + 7(-2) + 12 = 4 - 14 + 12 = 2$$

Since  $2 \neq 0$ , the  $x \neq -2$

If  $x = -3$ ,

$$(-3)^2 + 7(-3) + 12 = 9 - 21 + 12 = 0$$

Since the expression is reduced to zero by  $x = -3$ , then  $x = -3$  is the solution to the expression.

If  $x = -4$ , then

$$(-4)^2 + 7(-4) + 12 = 16 - 28 + 12 = 0$$

And the expression is reduced to zero by  $x = -4$  then  $x = -4$

2.  $(x + 3)(x - 3) = x^2 - 9$  Is not true if  $x \neq -3$  and  $x \neq 3$ .

### 2.3.2 Factorization of polynomials

By the end of this section, the learner should be able to factorize a polynomial with a common factor and to expand similar polynomials.

### Teaching guidelines 2.3.2

- Organize the learners in pairs to do activity 2.11 on page 43 in learner's book.
- Guide the learners to relate expansion and factorization to multiplication and division of polynomials.
- Let the learners present their findings and encourage them to illustrate their findings with examples similar to the ones in the learner's book. Let them demonstrate their examples on the board for all to see.
- Summarize the class findings and observation. Correct those that may be wrong, emphasize on: To **factorise** means to write a sum or difference of terms as product of a polynomial. Expanding is the reverse of factorise. Explain this use examples.
- Guide the learners through example 2.20 on page 43 in learner's book.
- Ask learners to do exercise 2.9 on page 44 learner's book.

### Answers to activity 2.11 learner's book page 43

(a)  $2a + 2b = 2(a + b)$  Common factor is 2

(b)  $3r + 6r^2 = 3r(1 + 2r)$  Common factor is 3r

(c)  $xy(1+a)$  Common factor is  $xy$

(d)  $3xy(3x+5y)$  Common factor is  $3xy$

### 2.3.3 Factorization of algebraic expressions by grouping

By the end of this section, the learner should be able to factorize expressions with four terms by grouping the terms.

#### Teaching guidelines 2.3.3

- Work with the whole class activity 2.12 on page 44 learner's book.
- Explain to the class that to factorize by grouping we pair the terms which have a common factors that can be identified at a glance. Demonstrate this point with simple four terms expressions. This process is best demonstrated using examples.
- Take the learners through example 2.21, on page 44 in learner's book explaining every step.
- Help the learners to group part to differently, to verify that the results will be the same. Let them illustrate the alternative grouping on the board so that all learners can also participate.
- Ask learners to do exercise 2.10 on page 45 in learner's book.

#### Answers to activity 2.12 learner's book page 44

1.  $ab - 2a + 3cb - 6c = a(b - 2) + 3c(b - 2)$
2.  $a(b - 2) + 3c(b - 2) = (a + 3c)(b - 2)$

## 2.4 Quadratic identities

### 2.4.1 Quadratic expressions

By the end of this section, the learners should be able to identify and define quadratic expressions, expand binomials and to obtain quadratic identities.

#### Teaching guidelines 2.4.1

- Pair up learners to do activity 2.13 on page 45 in learner's book. Use examples in this activity, to describe the properties of a quadratic expressions i.e. Number of terms, degree of the expression etc.
- Invite the learners to demonstrate the binomial products on the board  $(a+b)^2$ ,  $(a-b)^2$ ,  $(a-b)(a+b)$ .
- These products are defined as quadratic identities.
- Summarize these identities on the board and ensure that the learners do the same in their exercise books for them to master them.
- Highlight the summary of the procedure of obtaining binomial products using short cuts.
- Help learners to relate numerical perfect squares to algebraic perfect squares. For example in  $2^2 = 4$ , 4 is a perfect square similarly in  $(a+b)^2 = a^2 + 2ab + b^2$  and  $(a-b)^2 = a^2 - 2ab + b^2$ ,  $a^2 \times 2ab + b^2 - 2ab + b^2$  are examples of perfect squares.

- Help learners to see that quadratic identities, can be used to factorize quadratic expressions which are perfect squares.
- Relate also, difference of two square  $x^2 - y^2$  to the binomial product  $(x - y)(x + y)$ . How do they relate? Provoke them to think in terms of factors and expansions.
- Now, guide the learners to work through the activities 2.14, 2.15 and 2.16 on page 48 in learner's book that use area to derive the quadratic identities. Let them work in groups to appreciate the analytical derivation of the identities.
- Guide the learners through the discussion provided in the learner's book to enable them master the concept well.
- Take learners through examples 2.22 and 2.23 on page 48 in learner's book.
- Ask the learner to do exercise 2.11 on page 48 in learner's book.

**Answers to activity 2.14 and 2.15  
learner's book page 48**

These activities should be a discussion between learners and the teacher because they are explained in learner's book page 48.

The teacher should ensure that learners discuss the activities well and understand

all explanations provided in learner's book.

**Answers to activity 2.16 learner's  
page 48**

This activity should be a discussion between learners and the teacher because it is explained in learner's book page 48.

The teacher should ensure that learners discuss the activity well and understand all explanations provided in learner's book.

**2.4.1.3 Factorising quadratic  
expressions**

By the end of this section, the learner should be able to factorize quadratic expressions of the form  $ax^2 + bx + c$  where  $a, b$  and  $c$  are constant.

**Teaching guidelines 2.4.1.3**

- Let the learners work in pairs to do activity 2.17 in the learner's book.
- Guide learners to conclude that  $(x + 3)$  and  $(x + 2)$  are the factors of  $x^2 + 5x + 6$ .
- Help learners see the relationship between the constant term, 6, and the constants of the two factors; the relationship between the coefficient of the middle term 5, and the constants of the two factors.

- Generalise the relationships above for a quadratic expression of the form  $ax^2 + bx + c$  where  $x = 1$ .
- Take learners through examples 2.24 and 2.25 page 50 in the learner's book.
- Ask them to do exercise 2.12 on page 51 in the learner's book.

### Answers to activity 2.17 learner's page 49

$$\begin{aligned}(x + 4)(x - 2) &= x(x - 2) + 4(x - 2) \\ &= x^2 - 2x + 4x - 8 \\ &= x^2 + 2x - 8\end{aligned}$$

The resulting expression can be factorized back by looking for two factors that can multiply to give -8 and add to get 2.

$$\begin{aligned}x^2 + 2x - 8 &= x^2 + 4x - 2x - 8 \\ &= x(x + 4) - 2(x + 4) \\ &= (x + 4)(x - 2)\end{aligned}$$

### 2.4.2 Further factorization

By the end of this section, the learners should be able to factorise quadratic expressions of the form  $ax^2 + bx + c$  where a, b and c are constants and  $a \pm 1$ .

### Teaching guidelines 2.4.2

- Let learners work in pairs to work activity 2.18 on page 51 in learner's book.
- Discuss the result of the activity, and help the learners to relate the binomials  $2x + 3$  and  $2x + 7$  to the result obtained.
- Help them describe  $2x + 3$  and  $2x + 7$  as the factors of the resulting expression  $4x^2 + 20x + 21$
- Now, using  $(2x + 3)(2x + 7) = 4x^2 + 20x + 21$ , write a relationship between:
  - 3, 7 and 21
  - Two factors of  $(4 \times 21)$  and coefficient of x, 20. Generalize the relationship above using a quadratic expression  $ax^2 + bx + c$  where a, b and c are constants and  $a \pm 1$ .
- Guide learners through examples 2.26 and 2.27 page 52 in learner's book step by step.
- Ask them to do exercise 2.13 on page 52 learner's book.

### Answers to activity 2.18 learner's page 51

$$\begin{aligned}(3x + 3)(4x + 1) &= 3x(4x + 1) + 3(4x + 1) \\ &= 12x^2 + 3x + 12x + 3 \\ &= 12x^2 + 15x + 3\end{aligned}$$

The resulting expression is a quadratic expression are the factors of

$$12x^2 + 15x + 3$$

## 2.5 Perfect squares

By the end of this section, the learners should be able to identify and define a perfect square, and factorise it.

### Teaching guidelines 2.5

- In pairs, let the learners do the activity 2.19 in the learner's book page 53.
- Conduct a class discussion to summarize their findings.
- Help the learners to relate the products to the given binomials. Conclude the observation in a way similar to the one used in the learner's book i.e.  $a^2 + 2ab + b^2$  is a perfect square.
- Guide learners through example 2.28 on page 53 in learner's book.
- Ask learners to do exercise 2.14 on page 53-54 in learner's book.

### Answers to activity 2.19 learner's page 53

$$\begin{aligned} \text{(a)} \quad (x + 4)^2 &= (x + 4)(x + 4) \\ &= x(x + 4) + 4(x + 4) \\ &= x^2 + 4x + 4x + 16 \\ &= x^2 + 8x + 16 \end{aligned}$$

$$\begin{aligned} \text{(b)} \quad (x - 1)^2 &= (x - 1)(x - 1) \\ &= x(x - 1) - 1(x - 1) \\ &= x^2 - x - x + 1 \\ &= x^2 - 2x + 1 \end{aligned}$$

1. Each expression has three terms
2. The first term has the degree which is equal to the square of the first term.
3. The second term is twice the product of the first and last terms in the brackets.
4. The third term is the square of the second term in the brackets.

### 2.5.1 Factorising a difference of two square

By the end of this section, the learner should be able to identify and factorize a difference of two squares.

### Teaching guidelines 2.5.1

- Working with the whole class remind them of the binomial products  $(a+b)(a-b) = a^2 - b^2$ . Let them see that the left hand side (LHS) is in factor form, while the right hand side (RHS) is a difference of squares
- Caution the learners that sometimes squares are hidden as in expressions such as  $2x^2 - 50y^2$ . To reveal a difference of two squares in  $2x^2 - 50y^2$ , identify the common factor 2 and factor it out so that  $2x^2 - 50y^2 = 2(x^2 - 25y^2)$

- Take them through examples 2.29 on page 54 in learner's book.
- Ask them to do exercise 2.15 on page 54 to 55 in learner's book.

## 2.6 Applying the quadratic identities

By the end of this section, the learner should be able to use quadratic identities to ease numerical calculations.

### Teaching guidelines 2.6

- Pair up the learners to do activity 2.20 on page 55 in learner's book.
- Let them demonstrate their findings on the board for others to compare with their findings.
- Help them to see that the best numbers to use to get a binomial sum or difference easy to work with are multiple of first significant figure (1s.f) of 10 together with small numbers between 1 and 10.
- Summarize their findings ensuring that all are moving with you.
- Take them through example 2.30. on page 55 in learner's book
- Ask them to do exercise 2.16 on page 55-56 in learner's book.
- Take them through the unit summary and ask the learners to do unit 2 test, all questions as an assignment.

### Answers to activity 2.20 learner's page 55

- (a)  $102 = 100 + 2$ , so  $102^2 = (100 + 2)^2$   
 (b)  $199^2 = (200 - 1)^2$   
 (c)  $3002 = (3000 + 2)^2$
- (a)  $102 \times 99 = (100 + 2)(100 - 1)$   
 (b)  $106 \times 399 = (100 + 6)(400 - 1)$

### ANSWERS

#### Exercise 2.1 (learner's book page 28 to 29)

- |                        |             |
|------------------------|-------------|
| (a) (i) 4              | (ii) y      |
| (b) (i) -6             | (ii) $x^2$  |
| (c) (i) 1              | (ii) x      |
| (d) (i) -12            | (ii) ab     |
| (e) (i) 36             | (ii) $x^3y$ |
| (f) (i) -15            | (ii) $b^2$  |
| (g) (i) $-\frac{3}{5}$ | (iv) xy     |
| (h) (i) 1              | (ii) kc     |
- |                           |              |
|---------------------------|--------------|
| (a) polynomial            | (b) Binomial |
| (c) Monomial              | (d) Binomial |
| (e) Trinomial             | (e) Binomial |
| (f) Binomial              | (g) Monomial |
| (h) Trinomial             |              |
| (i) polynomial, Trinomial |              |
- |  |
|--|
| (a) $3yz + zx + xy$ – order 2                    |
| (c) $x^3 + y^3 - z^3$ – degree 3                 |
| (d) $x^2 - 3xy - 40y^2$ – order 2                |
| (e) $6x - 5y + 6z$ – first degree                |
| (f) $ab + ac + bc$ – order 2                     |
| (g) $x^3 + y^3 + z^3 + 3a^2c + 3ac^2$ – order 3. |

- (h)  $2a^2 - 7ab - 30y^2$  – order 2  
 (i)  $5x^3 + 6x^2y - 7xy^2 + 6y^3$  – order 3
4. (a)  $x^2 - y^2 - z^2$  – degree 2  
 (b)  $3xy + zx - 2yz$  – degree 1  
 (f)  $a^2b + ab^2 - x^2y + x^2y$  – degree 3

**Exercise 2.2** (learner's book pages 32)

1. (a)  $3x^2$  (b)  $5m^2$   
 (d)  $m^2n$  (e)  $xy$
2. (a)  $3y$  (b)  $n$   
 (c)  $f$  (d)  $2d$
3. (a)  $6a$  (b)  $3b$   
 (c)  $4z$  (d)  $0$   
 (e)  $3q$  (f)  $12p$   
 (g)  $r$  (h)  $-4w$
4. (a)  $9a$  (b)  $7c$   
 (c)  $9b$  (d)  $2y$   
 (e)  $12w$  (f)  $8n$   
 (g)  $5m$  (h)  $0$
5. (a)  $2x + 2y$  (b)  $11w + 5z$   
 (c)  $12n + 1$  (d)  $s + 3t$   
 (e)  $7p - 11$  (f)  $8b - 9c$   
 (g)  $3m + n$  (h)  $d - 5$
6. (a)  $5x^2 - 5x + 3$  (b)  $-6y - 9$   
 (c)  $2x^2 + 2x - 8$  (d)  $3y^2 - 5y - 4$
7. (a)  $12$  (b)  $14$   
 (c)  $15$  (d)  $11$
8. (a)  $15$  (b)  $1$   
 (c)  $5$  (d)  $0$   
 (e)  $15$  (f)  $30$   
 (g)  $0$  (h)  $-\frac{1}{3}$   
 (i)  $27$  (j)  $72$   
 (k)  $9$  (l)  $-4$   
 (m)  $128$  (n)  $6$   
 (o)  $7$

9. (a)  $6\frac{1}{2}$  (b)  $3\frac{1}{2}$   
 (c)  $2$  (d)  $1$
10.  $\frac{3}{2}$
11. (a)  $x = \frac{5}{2}$  (b)  $9$
12. (a)  $68$  (b)  $\frac{538}{5} = 107.6$   
 (c)  $167.45$

**Exercise 2.3** (learner's book page 32)

1. (a)  $12a$  (b)  $20m$   
 (c)  $54x$  (d)  $33q$
2. (a)  $6xy$  (b)  $14ab$   
 (c)  $40pq$  (d)  $8xy$
3. (a)  $3a^2b$  (b)  $14a^2b$   
 (c)  $28y^2x$  (d)  $143st^2$
4. (a)  $10m^2$  (b)  $15p^3q$   
 (c)  $3q^3p$  (d)  $6p^2q^2$

**Exercise 2.4** (learner's book page 35)

1. (a)  $10x + 15$  (b)  $12m - 8n$   
 (c)  $14b - 21c + 7$   
 (d)  $12wx - 3w$  (e)  $18x - 30y - 6$   
 (f)  $8r + 3s - 9$   
 (g)  $6ab + 3ac - 4ax - 2ay$   
 (h)  $36 - c$  (i)  $-y$   
 (j)  $4a + 15b$  (k)  $3xy - 25by^2$   
 (l)  $x^3 - x^2y^2$
2. (a)  $(a + 2y)4$   
 (b)  $\frac{12e+30d-18}{6} = 2e+5d-3$   
 (c)  $p(p - 2)(p - 4)$   
 (d)  $(a + b) - (a - b)$
3. (a)  $(n - 1)$  (b)  $(b + c)$   
 (c)  $(y - z)$  (d)  $(q + r - s)$



- (e)  $(v - w - x)$     (f)  $(y - v + w)$   
 (g)  $(b - c)$     (h)  $(b + 2c)$   
 (i)  $(a - 4c), (x + 3z)$   
 (j)  $(k + 2l), (3m - 4n)$

**Exercise 2.5** (learner's book page 37)

1. (a)  $x^2 - 5x + 6$     (b)  $a^2 - 25$   
 (c)  $y^2 - 16$     (d)  $x^2 + 10x + 25$
2. (a)  $3x^2 - 15x + 12$   
 (b)  $12y^4 + 8y^2 - 7$   
 (c)  $27x^2 + 18x + 3$   
 (d)  $12y^2 - 10yt + 2t^2$
3. (a)  $x^4 - 11x^2 + 24$   
 (b)  $a^2b^2 - 36$   
 (c)  $4x^2 - 2x + \frac{1}{4}$
4. (a)  $10a^2$     (b)  $7x^2 - 30x + 75$   
 (c)  $-3xy^2 + 9y^2$   
 (d)  $6x^3 - 10x^2 \times 7x - 2$
5. (a)  $x^2 - y^2 - 2x - 2y$   
 (b)  $4x^2 + y^2 + 12x - 4xy - 6y + 9$   
 (c)  $3a^3 - 8a^2b + 5ab^2 - 2b^3$   
 (d)  $x^2 + x$   
 (e)  $2x^2 - x - 3xy - y + y^2 - 6$

**Exercise 2.6** (learner's book page 38)

1. (a)  $x^4$     (b) 2  
 (c)  $3x$     (d)  $-4$   
 (e)  $-2a^2$     (f)  $4b^2$   
 (g)  $\frac{8}{3}m$     (h) 3
2. (a)  $-4y$     (b)  $a^2$   
 (c)  $4x$     (d)  $-2x^2$

(e)  $\frac{2}{3}(4xy - 3y - 9x)$

3. (a)  $-6x^2 = (6)(-x^2)$   
 (b)  $10m^5 = (-5m)(-2m^4)$   
 (c)  $6x^4 = (-2x^3)(-3x)$   
 (d)  $-36x^5y^3 = (-9x^3y^2)(4x2y)$   
 (e)  $-24ab^3 = (12b^2)(-2ab)$   
 (f)  $-6 \times 2y^4 = (-3x^2y)(2y^3)$

**Exercise 2.7** (learner's book page 40)

1. (a)  $-x^4 - 12x^3 + 3x^2 + 7x + 10$   
 (b)  $-3x^5 + 4x^3 + 6x^2$   
 (c)  $12a^3 + a^2 + 4a - 12$   
 (d)  $4a^5 + a^4 + 3a^3 - 7a^2 - 5a$
2. (a)  $4x^3 + 0x^2 - 2x + 8$   
 (b)  $4x^5 + 0x^4 - 3x^3 - 2x^2 + 7x + 0$   
 (c)  $8x^5 + 0x^4 + 4x^3 - 3x^2 + 0x - 7$   
 (d)  $3a^4 - 0a^3 - 8a^2 + 7a + 0$
3. (a)  $4m$     (b)  $16x$   
 (c)  $-6x^2 + 11x$     (d)  $10x$
4. (a) True    (b) True  
 (c) False    (d) False
5. Quotient    Remainder
- |                       |                |
|-----------------------|----------------|
| (a) $3x + 7$          | 0              |
| (b) $4t - 3$          | 8              |
| (c) $-2a - 3$         | 13             |
| (d) $-4r - 3$         | 0              |
| (e) $-x^2 - x + 1$    | 1              |
| (f) $2a^2 - 24$       | 125            |
| (g) $y - \frac{8}{3}$ | $-\frac{4}{3}$ |
| (h) $3a^2 - 3a - 3$   | $-4$           |
| (i) $h^2 - 4h - 2$    | 0              |

**Exercise 2.8** (learner's book page 42 - 43)

- $a = -\frac{1}{2}, b = 7$
- $a = -5, b = -6$  remainder = 70
- $a = 2.5, b = 4$
- $a_1 = 3, b_1 = 4$   
 $a_2 = 4, b_2 = 3$
- $a = 2, b = 3, c = 2$
- $ab = 9c$
- $a = 3, b = 2$
- $a = 3, b = 1$
- $a = 3, b = -9, c = -8$
- $a_1 = -1, b_1 = 2$   
 $a_2 = -2, b_2 = 1$
- $a = 1, b = -2, c = 3$

**Exercise 2.9** (learner's book page 44)

- $a(x + y)$
- $3(x + z)$
- $3x(7y - 2x)$
- $3x(2x + 5y)$
- $9x^2(1 - 5y^2x)$
- $2x(2 + 7x)$
- $5x(5x - 3y^2)$
- $2a(4p + q)$
- $-16a + 10$
- $-4b^2 + b$
- $6x^2 + 10x$
- $5x + 8$
- $8y^2 - 3y - 45$
- $-x^2 - 25$
- $t^2 - 10t + 25$

**Exercise 2.10** (learner's book page 45)

- $3(2p + 6q + 9r - 4s)$
- $8(x + 2y - 4n - 8m)$
- $ab(ab + a^2 - b^2)$
- $3k(2 + 6kl - 9m + 4k^2n)$
- $2ax(2b - 2x)$
- $14mn(2m^2 + 5mn - 3n^2)$
- $a(6a - 4b + 1)$
- $(a + 3c)(b - 2)$
- $(e + f)(e + 2)$
- $(n - w)(2 - m)$

- $(a - c)(5b + 4)$
- $(x - y)(x + 6)$
- $(7 + k)(ab - m)$
- $(n + 3m)(x - 2)$
- $(y + 3)(1 + a)$
- $(a - c)(3b + 2)$
- $(w - n)(m - 3)$
- $(b + 3b)(x - y)$  or  $4b(x - y)$
- $2(bm - 2na)$

**Exercise 2.11** (learner's book page 49)

- (a) (i)  $a^2 + 2a + 1$   
(ii)  $a^2 + 12ab + 36b^2$   
(iii)  $x^2 + 2xy + y^2$   
(iv)  $x^2 + 18x + 81$   
(v)  $m^2 + 2mn + n^2$   
(vi)  $4a^2 + 12ab + 9b^2$   
(vii)  $9x^2 + 24x + 16$   
(viii)  $9m^2 + 12m + 4$   
(ix)  $16x^2 + 24xy + 9y^2$
- (b) (i)  $b^2 - 2b + 1$   
(ii)  $r^2 - 6r + 9$   
(iii)  $x^2 - 2xy + y^2$   
(iv)  $16x^2 - 24x + 9$   
(v)  $25x^2 - 20x + 4$   
(vi)  $9x^2 - 72x + 144$   
(vii)  $25x^2 - 30x + 9$   
(viii)  $16z^2 - 24bz + 9b^2$   
(ix)  $49x^2 - 28xy + 4y^2$
- (a)  $a^2 - 9$  (b)  $a^2 - 25$   
(c)  $x^2 - 81$  (d)  $f^2 - g^2$   
(e)  $4p^2 - 1$  (f)  $16x^2 - y^2$   
(g)  $49 - 4x^2$  (h)  $4a^2 - 9b^2$   
(i)  $25y^2 - 9$  (j)  $16x^2 - 1$   
(k)  $9x^2 - 16$  (l)  $4x^2 - 9y^2$

(m)  $64 - 9x^2$       (n)  $9x^2 - 49y^2$

**Exercise 2.12** (learner's book page 51)

1. (a)  $(x + y)(a + b)$  (b)  $(x + 2)(x + 3)$   
(c)  $(3x - 2)(2x - 3)$  (d)  $(x - 3)(x - 2)$   
(e)  $(c + d)(x + y)$  (f)  $(a + b)(x - y)$
2. (a)  $(x + 3)(x + 1)$  (b)  $(x + 4)(x + 8)$   
(c)  $(x + 10)(x + 10)$  (d)  $(x + 2)(x + 9)$   
(e)  $(x + 1)(x + 2)$  (f)  $(x + 3)(x + 3)$
3. (a)  $(x + 8)(x - 3)$  (b)  $(x + 9)(x - 7)$   
(c)  $(x + 4)(x - 3)$  (d)  $(x + 5)(x - 3)$   
(e)  $(x + 3)(x - 2)$  (f)  $(x + 6)(x - 1)$
4. (a)  $(x - 3)(x - 5)$  (b)  $(x - 2)(x - 7)$   
(c)  $(x - 1)(x - 1)$  (d)  $(x - 2)(x - 2)$   
(e)  $(x - 4)(x - 6)$  (f)  $(x - 3)(x - 3)$
5. (a)  $(x - 4)(x + 3)$  (b)  $(x - 8)(x + 3)$   
(c)  $(x - 6)(x + 5)$  (d)  $(x - 6)(x + 3)$   
(e)  $(x - 5)(x + 2)$  (f)  $(x - 5)(x + 4)$

**Exercise 2.13** (learner's book page 52)

1.  $(x + 1)(x + 3)$     2.  $(2x + 1)(3 - x)$   
3.  $(2a - 3)(4a - 3)$     4.  $(b + 6)(4b - 1)$   
5.  $3(y + 2)(4 - y)$     6.  $(2x - 3)(x + 2)$   
7.  $(a + 3)(3a - 2)$     8.  $(2x + 1)(x + 1)$   
9.  $2(x + 1)(2x - 3)$     10.  $(2y - 3)(2y + 1)$   
11.  $(3b + 1)(3b - 8)$     12.  $(4x + 1)(2x - 3)$   
13.  $2(x - 2)(x + 5)$     14.  $(2x + 3)(3x - 2)$   
15.  $(3a + 1)(5a - 1)$     16.  $(3a + 8)(3a - 1)$   
17.  $(2b - 3)(4b - 3)$     18.  $(5a + 2)(2a + 1)$   
19.  $(7x - 1)(x - 5)$     20.  $(x + 3)(6x + 5)$

**Exercise 2.14** (learner's book page 54)

1.  $(x + 4)^2$                       2.  $(x + 6)^2$   
3.  $(x - 7)^2$                       4.  $(y - 3)^2$

5.  $(2x + 5)^2$

6.  $(3x - 7)^2$

7.  $(3x - 1)^2$

8.  $(4x + 3)^2$

9.  $(5x - 4y)^2$

10.  $(12x - 5)^2$

11.  $(2x + 3)^2$

12.  $9(2x - 3)^2$

**Exercise 2.15** (learner's book pages 54-55)

1. (a)  $(x - 4)(x + 4)$  (b)  $(x - 2)(x + 2)$   
(c)  $(x - 5)(x + 5)$
2. (a)  $(x - 1)(x + 1)$  (b)  $(6 - a)(6 + a)$   
(c)  $(9 - a)(9 + a)$
3. (a)  $(5 - y)(5 + y)$  (b)  $(x - y)(x + y)$   
(c)  $(x - 2y)(x + 2y)$
4. (a)  $(b - 7)(b + 7)$   
(b)  $(2a - 5b)(2a + 5b)$   
(c)  $(3x - 7y)(3x + 7y)$
5. (a)  $(3y - 5x)(3y + 5x)$   
(b)  $(4p - 3q)(4p + 3q)$   
(c)  $(2x - 3b)(2x + 3b)$
6. (a)  $(9x - y)(9x + y)$   
(b)  $(p - 5q)(p + 5q)$   
(c)  $(a - 4b)(a + 4b)$
7. (a)  $(12x - 11y)(12x + 11y)$   
(b)  $(l - c)(l + c)$   
(c)  $2(x - 2y)(x + 2y)$
8. (a)  $3(x - 4y)(x + 4y)$   
(b)  $2(3x - 1)(3x + 1)$   
(c)  $5(2 - b)(2 + b)$
9. (a)  $8(x - 2y)(x + 2y)$   
(b)  $2(5 - x)(5 + x)$   
(c)  $r^2 - 3)(r^2 + 3)$
10. (a)  $(7x - 8y^2)(7x + 8y^2)$   
(b)  $(x - 1)(x + 1)(x^2 + 1)$   
(c)  $(ab - 2c)(ab + 2c)(a^2b^2 + 4c^2)$

**Exercise 2.16** (learner's book pages 55-56)

1. (a) 121 (b) 841  
(c) 4 489 (d) 9 409  
(e) 399 (f) 40 804  
(g) 251 001 (h) 998 001  
(i) 1 006 009 (j) 8 999 996
2. (a)  $891 \text{ m}^2$  (b)  $9\,984 \text{ m}^2$   
(c)  $9\,999 \text{ m}^2$  (d)  $999\,996 \text{ m}^2$

**Unit 2 Test** (learner's book page 57)

1.  $3a + 2c$
2.  $(3x + y)(x - y)$

3.  $\frac{2(x-3)}{3(x+3)}$

4.  $-\frac{13}{8}$

5.  $a_1 = -14.29$        $b_1 = 0.28$   
 $a_2 = 0.76$        $b_2 = -5.28$

6.  $3[(x-9)(x+9)]$

7.  $2abc$

8.  $64$

9. (a)  $x^2 - 2x - 2 \text{ rem } 1$

(b)  $3x^2 - x - 1 \text{ rem } -2x + 2$

10.  $a = 4, b = 4, c = 16$

# Algebra

## Unit 3

### SIMULTANEOUS LINEAR EQUATIONS INEQUALITIES

Learner's Book pages 58 - 87 (30 Lessons)

#### Key unit competence

By the end of this unit, the learner should be able to solve problems related to simultaneous linear equations, inequalities and represent the solution graphically.

#### Content outline

3.1 An equation in two variables

3.2 Solving simultaneous equations

3.2 Inequalities

Answers

#### Learning objectives

##### Knowledge and understanding

- Define simultaneous linear equations and give examples.
- Show whether a given simultaneous linear equations is independent, dependent or inconsistent
- Recognize the forms of compound inequalities with one unknown and give examples

##### Skills

- Solve simultaneous linear equations in two variables
- Model and solve mathematical word problems using simultaneous equations

- Solve compound inequalities in one variable

#### Attitudes and values

- Appreciate the importance of solving problems related to simultaneous linear equations, inequalities.
- Be accurate in solving system of linear equations, inequalities.
- Developing self confidence in solving system of linear equations/ inequalities in one variable

#### Generic competences addresses in this unit

- Communication skills
- Critical thinking
- Problem solving
- Research/innovation
- Cooperation, interpersonal management and life skills.

### Links to other subjects

- Any subject where simultaneous linear equations and inequalities are needed.

### Cross cutting issues addressed in this unit

- Inclusive education
- Financial education
- Genocide studies
- Peace , gender and values
- Standardization of culture
- Comprehensive and sexuality education
- HIV and AIDS

### Assessment criteria

Solve problems related to simultaneous linear equations, inequalities and represent the solution graphically.

### Background Information

Most of the learners find this unit enjoyable because of the prior knowledge of algebra that they have. However, few slow learners find this unit challenging and therefore should be handled carefully to put them into consideration. This unit is highly practical as learners can apply it in solving daily problems involving numbers especially dealing with money. This therefore makes this unit an essential topic in the learner's future endeavor. Few activities are given in every concept but ensure that you add more activities and make the unit as practical as possible.

### Introduction to simultaneous equations

By the end of this lesson, the learners should be able to identify and formulate a pair of simple simultaneous equations

### 3.1 An equation in two variables

By the end of this section, the learner should be able to explain the meaning of equation in two variables and solve problems involving it.

#### Teaching and learning guidelines 3.1

- Using a real life situation, model a simple problem which can be represented in algebraic form using two variables.
- Discuss the case given in the learner's book under an equation in two variables.
- Organise learners into groups to carry out activity 3.1 and 3.2 on page 58 learners book.
- Let the groups present their findings in class discussions through the group secretary.
- Summarise the group presentation emphasising on the learning points.
- The learners should understand that simultaneous equations involve two sets of equations with same set of two or more variables that collectively satisfy all the equations.
- Refer to the observations made in the learner's book.
- Take learners through Example 3.1 on page 59 in learners book.
- Let learners work through exercise 3.1 on page 59 and 60 in learners book.

#### Answer to Activity 3.1 Learners book page 58

1. Let  $w$  represent white chicken and  $b$  represent black chickens  
 $b + w = 12$

2. Let  $a$  represent number of oranges by Lucy and  $m$  the number of mangoes by Lucy  
 Number of oranges by Mary:  $2a$   
 Number of mangoes by Mary:  $3m$   
 Mary bought a total of 18 fruits  
 $\therefore$  Mary bought:  $2a + 3m = 18$

**Answers to Activity 3.2 Learners book page 58**

- i)  $p = 30n + 110$  and  $p = 600 - 40n$   
 ii)

$n$	2	4.5	9	10
$p$	170	345	380	410

$n$	3	5	7.5	9	10
$p$	480	400	300	240	200

- iii) Bank balances would be the same when  
 $30n + 110 = 600 - 40n$

$$70n = 490$$

$$\frac{70n}{70} = \frac{490}{70}$$

$$n = 7$$

The two equations in part (i) above are called simultaneous equation in  $p$  and  $n$ .

**3.2 Solving simultaneous equations**

**3.2.1 Graphical solutions of simultaneous equations**

By the end of this lesson, the learner should be able to solve simultaneous linear equations using graphical method.

**Materials**

Graph papers, pens, pencils and rulers.

**Teaching/learning guidelines 3.2.1**

- Treat this section as a practical continuation of activity 3.3 on

page 60 take learners through the explanation in the learner's book. Let them draw the graph in this section individually.

- Take them through Example 3.2 on page 61 in learners book. As you demonstrate the example on the board, ensure that they also do it in their graph book.
- Let the learners do Exercise 3.2 in the learner's book on pages 61-62.

**Answers to Activity 3.3 Learners book page 60**

1.

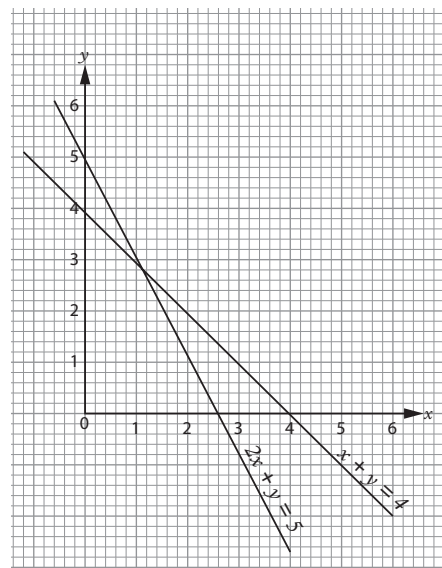

2. The point of intersections are;  $x = 1$ ,  $y = 3$
3. Substitute  $x$  and  $y$  values in the equations  
 $x + y = 4 \quad 1 + 3 = 4 \dots\dots\dots$ True  
 $2x + y = 5 \quad (2 \times 1) + 3 = 5 \dots\dots$  True  
 Both values of  $x$  and  $y$  satisfy the two equations.
4. Values of  $x$  and  $y$  at the intersection of two lines represent the solutions of the equations.

### 3.2.1.1 Classification of simultaneous equations

By the end of these lessons the learner should be able to identify different types of simultaneous equations.

**Materials:** graph papers, pens, pencils and rulers

#### Teaching and learning guidelines 3.2.1.1

- Pair up the learners in the class to do activity 3.4 on page 62 in learners book
- Ensure that all learners have graph books/papers and can draw the given graphs. Learners should also be able to describe the resulting graphs.
- Let the learners discuss and summarise their observations and record them in their books.
- Invite and encourage each group to present their observations to the rest of the class. Other members of the class should listen and antique the presenters.
- As you listen to the learners present their work, take the opportunity to verify their work and correct here necessary. Emphasise the learning points according to the observations in the learners book
- Let the learners work through exercise 3.3 on page 63 in the learners book.

### Answers to Activity 3.4 Learners book page 62

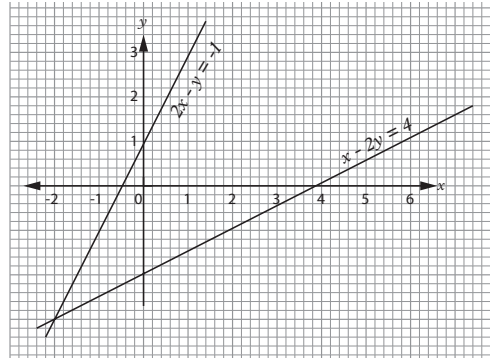

- a) The lines representing the equations intersect at a point where  $x = -2$ ,  $y = -3$ . The two equations have a unique solution. Such a set of equations is classified as **consistent** or **independent**.

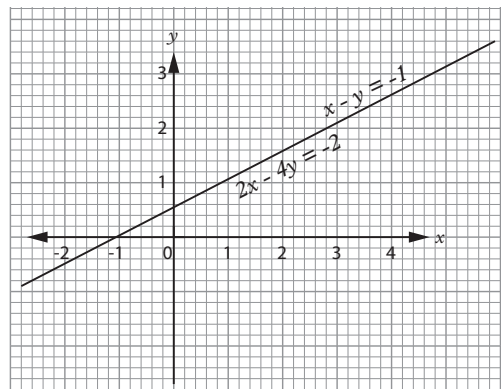

- b) The lines representing the two equations are coincident. All the points on one line lie on the second line as well. In such a case we say the solutions are **infinite**. The equations are said to be consistent and dependent.



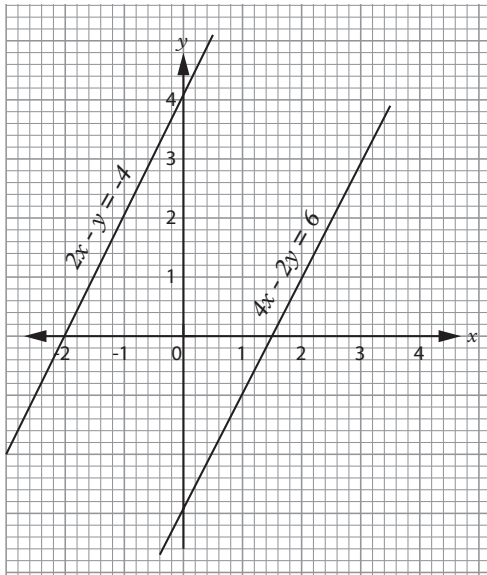

- c) The two lines in this part are parallel. They have no point in common. We say such equations have no solution. Therefore they are classified as **inconsistent** and **incompatible**.

### 3.2.2 Solving simultaneous equations analytically

By the end of this lesson, learners should be able to describe/identify algebraic methods of solving simultaneous linear equations to solve simultaneous equations.

#### Materials:

Dictionary (mathematical dictionary)  
computer or any other means to access internet

#### Teaching/learning guidelines 3.2.2

- Individually let the learners find the meaning of the terms substitution, elimination in mathematical sense Cramer's rule.
- Ensure that learners can use the

words substitution and elimination appropriately.

- Summarise the different methods of solving simultaneous linear equations.

#### 3.2.2.1 Solving simultaneous equations by substitution method

By the end of this lesson, the learners should be able to solve a system of simultaneous equations by substitution method.

#### Teaching/learning guidelines 3.2.2.1

- Working with the whole class, guide the learners through the explanation in the learner's book.
- Ensure that the learners work along side writing the explanations in their books.
- Take them through activity 3.5 on page 63 in learners book and examples 3.3 on page 64 in the learners book.
- Ask learners to do Exercise 3.4 on page 65 in the learners book.

#### Answers to Activity 3.5 Learners book page 63

Consider the equation

$$2x + y = 7 \dots\dots(i)$$

$$3x - 2y = 0 \dots\dots(ii)$$

$$2x + y = 7$$

$$y = 7 - 2x \dots (iii)$$

1. Substitution

$$3x - 2y = 0 \Rightarrow 3x - 2(7 - 2x) \dots (iv)$$

$$2. \quad 3x - 14 + 4x = 0$$

$$7x = 14$$

$$x = 2$$

3. Using equation (i)  
 $2x + y = 7 \Rightarrow 2(2) + y = 7$   
 $4 + y = 7$   
 $y = 3$
4. Verify answers using equations (i) and (ii) when  $x = 2$  and  $y = 3$   
 $2x + y = 0 \Rightarrow 2(2) + 3 = 4 + 3$   
 $= 7 \dots\dots\dots$  True  
 And  $\therefore$  RHS = LHS = 7  
 $3x - 2y = 0 \Rightarrow 3(2) - 2(3) = 6 - 6$   
 $= 0 \dots\dots\dots$   
 True  
 $\therefore$  LHS = RHS
5. This method of solving simultaneous equations is called **substitution** method. From the foregoing discussion, explain to the learner's why the name of the method is appropriate.

### 3.2.2.2 Solving simultaneous equations elimination method

By the end of this lesson the learners should be able to solve simultaneous equations using elimination method.

#### Teaching/learning guidelines 3.2.2.2

- Individually let the learners do activity 3.6 on page 65 in the learner's book.
- Remind them that as they do the activity, they should write down their observations as they work.
- Move around the room as they work to ensure that all are working.
- When they are through with the activity, invite them to volunteer to report their findings, as you listen to verify their work.
- Finally conclude the discussion by summarising the resulting learning

points and the procedure used in this method in line with this activity

- Take the learners through examples 3.4 and 3.5 on page 66 and 67 in learners book.
- Ask the class to do Exercise 3.5 on page 67 in learners book.
- This activity promotes independence and work discipline in the learner.

### Answers to Activity 3.6 Learners book page 65

Use equations  $3x - y = 2 \dots\dots\dots$  (1)

$$x + y = 4 \dots\dots\dots$$
 (2)

i) LHS:  $(3x - y) + (x + y) = 4x + 0$

ii) RHS:  $2 + 4 =$

iii)  $4x = 6 \dots\dots\dots$  (3)

iv)  $4x = 6 \Rightarrow x = \frac{6}{4} = 1\frac{1}{2}$

v) Use equation (1) and the value of  $x$  to obtain another equation (4)

$$3x - y = 2 \Rightarrow 3\left(1\frac{1}{2}\right) - y = 2$$

$$\frac{9}{2} - y = 2 \dots\dots\dots$$
 (4)

vi)  $\frac{9}{2} - y = 0$

$$-y = -\frac{9}{2}$$

$$\therefore y = 4\frac{1}{2}$$

### 3.2.2.3 Solving complex simultaneous equations by elimination method

By the end of this lesson, learners should be able to solve simultaneous equations of the form  $ax + by = c$ ,  $dx + ey = k$ , where  $a, b, c, d, e$  and  $k$  are constants

#### Teaching / learning guidelines 3.2.2.3

- Lead a class discussion on the procedure that can be used to make the coefficients of  $x$  or  $y$  in both equations same or opposite in sign in the equations

$$3x - 2y = 8 \text{ and } x + 5y = -3$$

- Let the learners answer the following questions as a class discussion.
  - (i) What is the LCM of 3 and 1?
  - (ii) What is the LCM of -2 and 5?
  - (iii) Find a constant  $p$  such that  $3 = 1xp = 0$
  - (iv) Find constants  $p$  and  $q$  such that  $2xp = txq$  so that  $-2p + 5q = 0$
- Now use the concept of the LCM to eliminate  $x$  or  $y$  in examples 3.6 to 3.8 on page 68 in the learners book. Take learners through the examples and ask them to do Exercise 3.6 on page 69 in the learners book.

### 3.3 Comparison method

By the end of this lesson, the learners should be able to solve simultaneous equations by comparing  $x$  and  $y$  at a point  $(x, y)$  where lines representing the equations intersect.

#### Teaching/learning guidelines 3.3

- This explanation is best dealt with in a class discussion.
- Using the equations involved let the learners express one of the variables, say  $y$  in terms of  $x$  in both equations.
- Take the learners through the explanation and activity 3.7 in the learner's book page 69. Ensure that by question and answer method, the learner understand

what is happening especially at the comparison of the ordered pairs either in terms of  $x$  or in terms of  $y$ .

- Conclude by solving for  $x$  or  $y$  and then by substitution solving for the other variable.
- Take the learners through example 3.9 on page 69 in learners book if need be, you can give another illustration using another example.
- Ask class to do Exercise 3.7 on page 70 in learners book.

#### Answers to Activity 3.7 Learners book page 69

From activity 3.7, you should have found

$$1) \quad x + y = 5 \Rightarrow x = 5 - y$$

$$2) \quad 2x - y = 4 \Rightarrow x = \frac{4 + y}{2}$$

$$3) \quad 5 - y = \frac{4 + y}{2} \Rightarrow 10 - 2y = 4 + y$$

$$-3y = -6$$

$$y = 2$$

- 4) Using equation (i)

$$x + y = 5$$

$$x + 2 = 5$$

$$x = 3$$

- In this pair of equations, we express one variable in terms of the other using the equations one by one.
- Then we compare the two expressions in one unknown, by equating them.
- Then using our solution, we substitute it in any of the original equation to find the second variable.
- The method is therefore appropriately called the **comparison method**.

### 3.4 Cramer's Rule

By the end of this lesson, learners should be able to derive and use Cramer's Rule to solve simultaneous equations.

### Teaching/learning guidelines 3.4

- Using specific equations  $x - 3y = 4$  and  $5x + 7y = 8$ , let the learners identify the coefficients of  $x$  and  $y$  and arrange them in a square pattern as  $\begin{pmatrix} 1 & -3 \\ 5 & 7 \end{pmatrix}$  its determinant is denoted as  $\begin{vmatrix} 1 & -3 \\ 5 & 7 \end{vmatrix}$  i.e. the number pattern enclosed between two vertical lines.
- Thus: Determinant (d) =  $\begin{vmatrix} 1 & -3 \\ 5 & 7 \end{vmatrix}$   
 $= 7 \times 1 - (3 \times -3)$   
 $= 7 - (-15)$   
 $= 7 + 15 = 22$
- Let the learners work individually under your supervision to do activity 3.8 and 3.9 on page 71 and 72 in the learners book.
- Invite and encourage the learners to report their observations to the class.
- Summarise their findings and verify their work.
- Take the learners through the rest of the explanation using the equations  $ax + b, y = c$ , and
- $a^2x + b^2y = C^2$
- State and highlight the Cramer's Rule as in the learner's book.
- Now, take learners through Example 3.10 on page 72 and 73 in the learners book. Let the learners work through exercise 3.8 on page 73 in the learners book.

### Answers to Activity 3.8 Learners

### book page 71

1. A matrix is a rectangular arrangement or pattern of numbers e.g.  $\begin{pmatrix} 1 & 2 \\ 3 & 4 \end{pmatrix}$ . Each entry in a matrix is called an element. A matrix consists of rows and columns that define the order of a matrix.

i.e. in  $\begin{pmatrix} 1 & 2 \\ 3 & 4 \end{pmatrix}$  ← these are the rows  
 ↑ columns

- This is a 2 x 2 matrix (two rows, two columns)
- A matrix is enclosed in a pair of brackets.
- Determinant of a matrix is the difference between the products of the elements in the diagonals.
- Determinant of matrix  $\begin{pmatrix} 2 & 1 \\ 3 & 4 \end{pmatrix}$  is denoted as  $\begin{vmatrix} 2 & 1 \\ 3 & 4 \end{vmatrix}$  leading diagonal

e.g.  $\begin{vmatrix} 2 & 1 \\ 3 & 4 \end{vmatrix} = 2 \times 4 - 3 \times 1 = 5$

2.  $\begin{vmatrix} 1 & 2 \\ 3 & 4 \end{vmatrix} =$  product in leading diagonal  
 - product in second diagonal  
 $= (2 \times 4) - 3 \times 1 = 8 + 3 = 1$

### Answers to Activity 3.9 Learners book page 72

Simultaneous equations

$$4x - 3y = 2$$

$$3x + y = -1$$

i) Matrix of coefficients  $\begin{pmatrix} 4 & -3 \\ 3 & 1 \end{pmatrix}$

$$\text{Determinant} = \begin{vmatrix} 4 & -3 \\ 3 & 1 \end{vmatrix}$$

ii)  $\begin{vmatrix} 4 & -3 \\ 3 & 1 \end{vmatrix} = 4 \times 1 - (3 \times -3)$   
 $= 4 + 9 = 13$

Note:

- The explanation on the Cramer's rule had to be lengthy because learners are not familiar with matrices so, do not rush the learners, be patient with them. They will master the concept.

### 3.5 Forming and solving simultaneous equation

By the end of this lesson learners should be able to form simultaneous equations from word problems and solve them.

#### Teaching/learning guidelines 3.5

- This section should be approached as a class discussion so that there is interaction between the teacher and the learners.
- Take the learners through the activity 3.10 in the learner's book page 73. Begin with choice of variables and then relate them according to the given formation. As far as possible, let the session be a question and answer interaction.
- Take learners through example 3.11 on page 73 learners book. if need be, take them through another example.
- Ask learners to do Exercise 3.9 on page 74 and 75 in learners book.

#### Answers to Activity 3.10 Learners book page 73

1. Let Esther pick numbers  $x$  and  $y$   
Double the first no gives  $2x$   
Adding double the first no to the second:  $2x + y = 18$   
Double the first number and subtract the second  $2x - y = 14$

$$\left. \begin{array}{l} 2x + y = 18 \\ 2x - y = 14 \end{array} \right\} +$$

$$\frac{4x}{4x} = \frac{32}{4x}$$

$$x = 8$$

using one of the equations i.e.

$$2x + y = 18, \text{ substitute } 8 \text{ for } x$$

$$2(8) + y = 18$$

$$y = 18 - 16$$

$$= 2$$

$$1^{\text{st}} \text{ number; } x = 8$$

$$2^{\text{nd}} \text{ number: } y = 2$$

2. Help the learners to think of common situations they can use to form pairs of simultaneous equations.
3. Different learners will form different equations. Suggest situations such **sharing shopping**, contributions etc.

### 3.6 Inequalities

By the end of this lesson, learners should be able to solve simple inequalities and represent inequality solutions on a number line.

#### 3.6.1 Review of basic operations on inequalities

##### Teaching/learning guidelines 3.6.1

- Pair up learners to do activity 3.11 on page 75 in learners book.
- Ensure that each pair completes the activity and are ready and willing to present their findings to the rest of the class.
- As they represent their findings verify their work. This presentation session should take the form of a class discussion, clarify the vague areas, and correct the wrong observations, affirm and summarise the correct ones. You are now ready to deal with compound inequalities.

- Guide the learners through examples 3.12 to 3.14 on page 74 and 73 in the learners book.
- Ask them to practise doing exercise 3.10 on page 76 in learners book.

### Answers to Activity 3.11 Learners book page 75

2. (a)  $x + 1 \leq -2x$

$$x - x + 1 \leq -2x - x$$

$$\frac{1}{3} \leq \frac{-3x}{3}$$

$$\frac{1}{3} \leq -x$$

$$\therefore x \leq \frac{-1}{3}$$

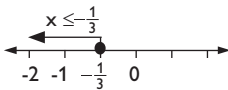

(b)  $x - 6 > 12 + 3x$

$$x - x - 6 > 12 + 3x - x$$

$$-6 > 12 + 2x$$

$$-18 > 2x$$

$$2x < -18$$

$$x < -9$$

$$x < -9$$

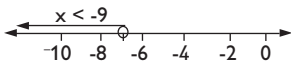

### 3.6.2 Compound inequalities

By the end of this session the learners should be able to identify a compound inequality, and represent it on a number line.

#### Teaching / learning guidelines: 3.6.2

- Pair up your learners so that they do activity 3.12 on page 76 in learners book.
- Ask them to work as move around the room so as to check that they are doing the correct workings.

- As they complete the activity, invite and encourage them to share their findings. As many as share their findings will help you to assess the accuracy of their work.
- Summarise their observations emphasising on the learning points and correcting those that may be wrong.
- Take learners through example 3.15 on page 77 in learners book.
- Ask learners to do Exercise 3.11 on page 77 in the learners book.

### Answers to Activity 3.12 Learners book page 76

1. Let the numbers be 6, 7 and 8
2.  $6 < 7$  and  $7 < 8 \Rightarrow 6 < 7 < 8$

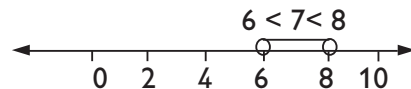

Remember, on the number line, numbers increase in value as we move on to the right.

Given only two numbers, the number to the right is always greater than the number to the left.

### 3.6.3 Solving compound inequalities

By the end of this lesson the learner should be able to solve a given compound inequality. Remember this work is a review of what the learners did in S1.

#### Teaching/learning guidelines 3.6.3

- Organise the learners into appropriate groups of three students.

- Guide the learners through Activity 3.13 on page 77 in the learners book on solving compound inequalities.
- Take learners through Example 3.16 and 3.17 on page 78 in learners book.
- Ask learners to work through Exercise 3.12 on page 79 in learners book.

### Answers to Activity 3.13 Learners book page 77

Consider inequality

$$3x + 4 < 2x + 8 < x + 3$$

1. Required inequalities are

$$3x + 4 < 2x + 8$$

$$3x + 4 < x + 3$$

$$2x + 8 < x + 3$$

2.  $3x + 4 < 2x + 8$

$$3x - 2x + 4 < 2x - 2x + 8$$

$$x + 4 < 8$$

$$x < 4$$

$$2x + 8 < x + 3$$

$$x + 8 < 3$$

$$x < -5$$

$$3x + 4 < x + 3$$

$$2x < -1$$

$$x < -\frac{1}{2}$$

We represent the three solutions on a number line to be able to identify the values that satisfy all the three inequalities

$$x < -\frac{1}{2}$$

$$x < -5$$

$$x < 4$$

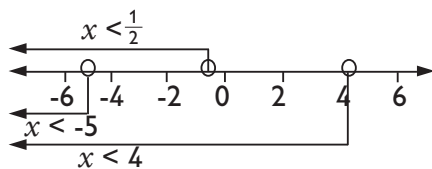

#### Note:

- A number between  $-\frac{1}{2}$  and 4 will only satisfy  $x < 4$ . Therefore not suitable.
- A number between -5 and  $-\frac{1}{2}$  will satisfy two inequalities only i.e.  $x < -\frac{1}{2}$  and  $x < 4$ . Therefore not suitable,
- A number less than -5, will satisfy all the three inequalities i.e.  $x < -\frac{1}{2}$ ,  $x < 4$
- $\therefore$  the solution set contains all the values of  $x: x < -5$

### 3.6.4 Solving simultaneous inequalities

By the end of this session the learner should be able to solve simultaneous inequalities, state the range of the solution and represent the same on a number line.

#### Teaching / learning guidelines 3.6.4

- Individually, let the learners do the activity 3.14 page 79 in the learner's book.
- Move around the class to ensure that the learners are following the given instructions.
- When the learners are through with the activity, let the presentation session be in form of a class discussion.
- As you listen to their observations,

verify that their findings are correct.

- Summarise the activity emphasising the key learning points
- Take learners through Examples 3.18 and 3.19 on page 80 in learners book.
- Ask them to do Exercise 3.13 on page 80 in learners book.

### Answers to Activity 3.14 Learners book page 79

i)  $1 - 3x > 10$

$$-3x > 9$$

$$x < -3$$

ii)  $3 - 2x < 15$

$$-2x < 12$$

$$x > -6$$

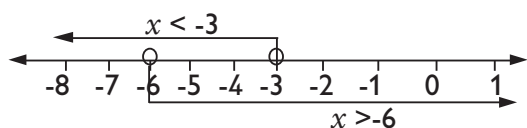

Solution  $x$ :  $-6 < x < -3$

Emphasize that the portion on the number line belonging to the two inequalities gives the solution set.

### 3.7 Solving inequalities involving multiplication and division of algebraic expressions

By the end of this section, the learner must be able to solve inequalities of the form  $ab \geq c$  or  $ab \leq c$  where  $c$  is a constant,  $\frac{a}{b} \leq 0$  or  $\frac{a}{b} \geq 0$

#### Teaching/learning guidelines 3.7

- Working with the whole class, take learners through the explanation given in the learner's book. Emphasize the meaning of

statements such as  $ab > 0$  or  $ab < 0$  when  $a$  and  $b$  are integers.

- Take the learners through activity 3.15 on page 81 in the learners book as you guide them through.
- If  $\frac{a}{b} > 0$  what can you say about the integers  $a$  and  $b$ ? what if  $\frac{a}{b} < 0$ ?
- Take learners through examples 3.20 to 3.23 on page 80 to 82 in learners book.
- Ask learners to do Exercise 3.14 on page 83 in learners book.

### Answers to Activity 3.15 Learners book page 81

$$(x + 30)(x - 2) = 0$$

$$x + 30 = 0 \text{ or } x - 2 = 0$$

$$x = -30 \text{ or } x = 2$$

In this case, for the product of two numbers to be equal to zero, either one or the other must be equal to zero

i) If  $xy = 0$ , either  $x = 0$  or  $x = 0$   
or  $x = y = 0$

ii)  $\frac{xy}{y} = 0$

Note:  $y \neq 0$  because division by zero cannot give a real number

### 3.8 Forming and solving inequalities from real life situations

By the end of this lesson, a learner should be able to form inequalities from word problems.

#### Teaching/learning guidelines 3.8

- This section is to expand the imagination of the learners by forming simple inequalities from problems.
- Guide the learners through activity 3.16 in the learners book page 84



on forming and solving inequalities from word problem.

- Take them through examples 3.24 to 3.26 on page 84 in the learners book and ask them to do exercise 3.16 on pages 85-86 in learners book individually.

### **Answers to Activity 3.16 Learners book page 84**

- b) Think of a number;  $x$
- c) Multiply  $x$  by 5 and add 6
- d)  $5x + 6$   
use  $x$  again
- e) Multiply  $x$  by 6, then add 5

f)  $6x + 5$

g)  $6x + 5 > 5x + 6$

### **3.9. Application of inequalities in life**

By the end of this session, a learner should be able to solve practical problems using inequalities.

#### **Teaching/learning guidelines 3.9**

- Take learners through examples 3.27 and 3.28 on page 85 in learners book.
- Explain to the learners how to make reasonable and sensible conclusions from inequality solutions.
- Ask the learners to work through Exercise 3.16 on page 85 and 86 in learners book and unit 3 test on page 86-87 in learners book.

## ANSWERS

### Exercise 3.1 (learners book pages 59-60)

- (a), (b), (c), (d)
- (b), (c), (f)
- (1, 12), (2, 9), (3, 6), (4, 3)
- 

x	11	17	23	2	-1	8	-4
y	2	0	-2	5	6	3	7

- (a) (3, 1)                      (b) (3, 1)

### Exercise 3.2 (learners book pages 61-62)

- $x = 1, y = 2$                       2.  $x = 2, y = 1$
- $x = 4, y = 5$                       4.  $x = 2, y = -3$
- $x = -1, y = -3$                       6.  $x = -1, y = 1$
- $x = 0.5, y = 0.5$                       8.  $x = -1, y = -1$
- $x = 1.5, y = 4$                       10.  $x = 1.5, y = 1$
- $x = -2, y = -3$                       12.  $x = 0.5, y = 1$
- $x = 0.8, y = 0.5$                       14.  $x = -3, y = -2$
- $x = -24, y = -40$                       16.  $x = -0.8, y = -2.5$

### Exercise 3.3 (learners book page 63)

- Unique solution; (2, 0)
- No solutions
- Unique solution; (2, 2)
- No solution
- Unique solutions
- Unique solution; (-2, -3)
- No solution
- Unique solution; (-1, 1)
- Infinite solutions
- Infinite solutions

### Exercise 3.4 (learners book page 65)

- $y = 4x - 12$                       2.  $y = \frac{10-2x}{5}$
- $y = \frac{x}{12} - 4$                       4.  $y = 12x - 40$
- $x = 5y + 3$                       6.  $x = -\frac{4}{9}y$
- $x = \frac{1}{2}(y - 1)$                       8.  $x = 3y + 8$
- $a = 2, b = 1$                       10.  $w = 3, z = -1$
- $x = -2, y = 2$                       12.  $x = -1, y = 3$
- $x = -2, y = -3$                       14.  $a = -\frac{1}{2}, b = -2$
- $m = -\frac{1}{4}, n = 2$                       16.  $p = 75, q = -28$
- $u = -10, v = \frac{10}{3}$                       18.  $s = 2, t = -1$
- $x = 1, y = 3$                       20.  $a = \frac{14}{3}, b = -\frac{4}{3}$
- $y = 4\frac{6}{11}, z = \frac{14}{11}$                       22.  $a = \frac{1}{3}, b = \frac{5}{3}$

### Exercise 3.5 (learners book page 67)

- $x = 3, y = 1$                       2.  $x = 4, y = 2$
- $x = 2, y = 3$                       4.  $x = 7, y = 4$
- $x = 7, y = 2$                       6.  $x = -10, y = 21$
- $a = 1, b = -4$                       8.  $r = -6, s = -7$
- $m = 12, n = 13$                       10.  $x = \frac{3}{5}, y = 2$
- $x = 5, y = 3$                       12.  $x = \frac{54}{11}, y = \frac{144}{11}$
- $x = 5, y = 1\frac{1}{2}$                       14.  $x = -3, y = -\frac{1}{3}$
- $x = 2, y = 3$                       16.  $x = 4, y = 19$

### Exercise 3.6 (learners book page 69)

- $x = 4, y = 2$                       2.  $x = 5, y = 3$
- $x = -3, y = 11$                       4.  $x = 3, y = 2$
- $x = -1, y = 3$                       6.  $x = -2, y = 2$
- $x = 4, y = 0$                       8.  $x = -3, y = 1$
- $n = -28, m = 75$                       10.  $x = 2, y = -1$
- $x = 550, y = -100$                       12.  $a = \frac{1}{2}, b = -2$
- $w = 3, z = -1$                       14.  $x = 1, y = 3$
- $x = \frac{1}{3}, y = \frac{1}{3}$                       16.  $x = 4, y = 2$
- $x = \frac{19}{11}, y = \frac{28}{11}$                       18.  $x = -\frac{48}{53}, y = \frac{62}{53}$

### Exercise 3.7 (learners book page 70)

- (a)  $x = -2y + 6$                       (b)  $x = 4 + 3y$

- (c)  $x = \frac{2+6y}{3}$  (d)  $x = \frac{6+y}{2}$
2. (a)  $y = 4 - x$  (b)  $y = 3x - 2$   
 (c)  $y = \frac{x+8}{2}$  (d)  $y = 2x - 4$
3. (a) (2,1) (b) (-1,2)  
 (c)  $(-\frac{1}{2}, -2)$
4. (a) (3,-2) (b) (-2,3)  
 (c) (5,1) (d)  $(-\frac{3}{5}, \frac{6}{5})$
5. (a) (4,2) (b) (1,0)  
 (c) (-2,3) (d) (4,1)
6. (1,3);  $x = 1, y = 3$
7. (a) (-1,-1) (b)  $(-\frac{1}{2}, -1)$

**Exercise 3.8** (learners book page 73)



1.  $x = 11\frac{1}{7}, y = 3\frac{5}{7}$  2.  $x = 2, y = 0$   
 3.  $x = 5, y = 2$  4.  $x = 5, y = 2$   
 5.  $x = -\frac{7}{23}, y = \frac{11}{23}$  6.  $x = -\frac{10}{23}, y = 2\frac{20}{23}$   
 7.  $x = -1, y = 2$  8.  $x = 1, y = 4$   
 9.  $x = -\frac{1}{13}, y = -\frac{10}{13}$  10.  $x = 2, y = 7$

**Exercise 3.9** (learners book page 74-75)

1. 2, 8 2. 7, 8  
 3. 75, 425 4. 7(50 FRW coins)  
 7(100 FRW coins)  
 5. 6 and 11 6.  $\frac{7}{16}$   
 7. 8 000 FRW 8. 48.5 cm by 51.5 cm  
 9. Son: 13 years, father: 35 years  
 10. Length 3 m, width 1 m

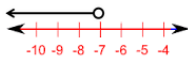
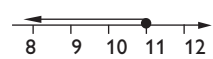
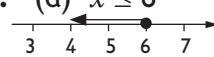
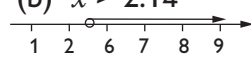
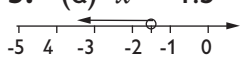
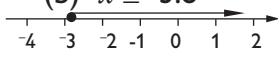

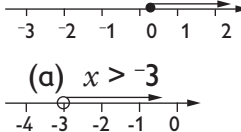
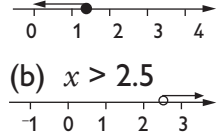
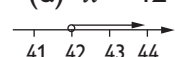
**Exercise 3.10** (learners book page 76)

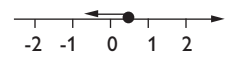
1. (a)  $x < 7$  (b)  $x \leq 11$   
  

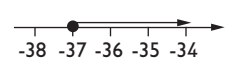
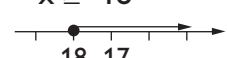
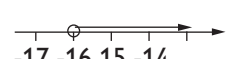
2. (a)  $x \leq 6$  (b)  $x > 2.14$   
  

3. (a)  $x < -1.5$  (b)  $x \geq -3.8$   
  

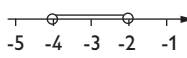
4. (a)  $x > 0.4$  (b)  $x \leq 1.4$

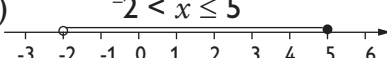
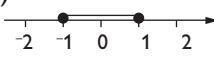
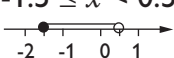
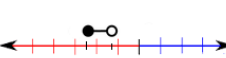
5. (a)  $x > -3$  (b)  $x > 2.5$   
  

6. (a)  $x > 42$  (b)  $x \geq -0.75$   
  

7. (a)  $m < \frac{3}{11}$  (b)  $m \leq \frac{11}{10}$   
  

8.  $x \geq -37$   

9.  $x \geq -18$   

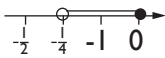
10.  $t > -16$   

**Exercise 3.11** (learners book page 77)

1. (a)  $-4 < x < -2$   

- (b)  $-3 \leq x < 0$   

- (c)  $-2 < x \leq 5$   

- (d)  $-1 \leq x \leq 1$   

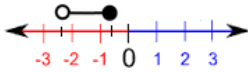
- (e)  $-1.5 \leq x < 0.5$   

- (f)  $-2.5 \leq x \leq -1.8$   

2. (a)  $-\frac{1}{4} < x \leq 0$



(b)  $-2\frac{1}{4} < x \leq -\frac{3}{4}$



(c)  $-3\frac{1}{2} < x < -2\frac{1}{2}$

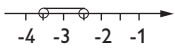

(d)  $-\frac{2}{3} < x < -\frac{1}{5}$

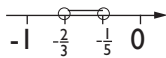

(e)  $-0.75 \leq x \leq 0.75$

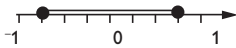

(f)  $-4\frac{1}{2} < x < \frac{1}{2}$

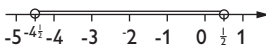

**Exercise 3.12** (learners book page 79)

1.  $\{-3, -2, -1, 0, 1\}$

2.  $-1 < x \leq 4$

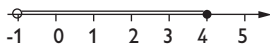

3. (a)  $-2 < x \leq 1$

(b)  $0 \leq x < 5$

(c)  $2\frac{1}{6} < x < 6\frac{2}{3}$

4.  $-1 < x \leq 4$

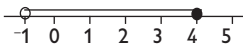

5.  $-3 < x < 2$

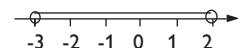

6. (a)  $-3 < x < 8$  (b)  $-3 < x < 2$

7.  $-3 \leq x < 4$

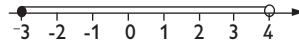

8. (a)  $\frac{13}{3} < x < \frac{29}{3}$  (b)  $\frac{89}{17} \leq x \leq \frac{10}{7}$

(4, 5, 6, ...) (5, 6, 7, ...)

9. (a)

(b)  $x \leq 8\frac{2}{3}$

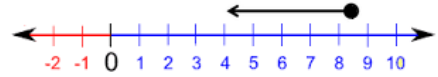

10. (a)

(b)

**Exercise 3.13** (learners book page 80)

1. (a)  $3 \leq x < 5$  or  $x \geq \frac{29}{5}$  (b)  $0 < x \leq 3$

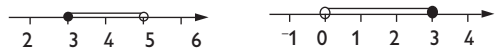

2. (a)  $-8 < x < -7$

(b)  $3 \leq x \leq 7$

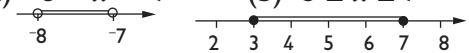

3. (a)  $-1 < x < 8$

(b)  $5.6 \leq x < 13.5$

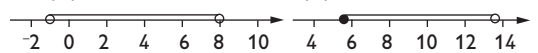

4. (a)  $1 < x < 6$

(b)  $\frac{3}{8} < x < 2$

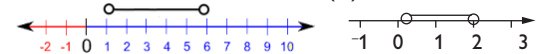

**Exercise 3.14** (learners book page 83)

1. (a)  $x < \frac{1}{2}$

(b)  $x > \frac{1}{2}$

2. (a)  $x > \frac{1}{2}$

(b)  $x < -\frac{1}{2}$

3.  $x < 3$  or  $x > -2$

4.  $x > \frac{5}{2}$  or  $x > -\frac{7}{3}$

5.  $x > 3$  or  $x > -\frac{5}{2}$

6.  $x < -2$  or  $x > -\frac{5}{2}$

7.  $x > \frac{5}{4}$  or  $x > 1$

**Exercise 3.15** (learners book page 85)

1. (a)  $b \times w = 48$

$$\text{Perimeter} = 2\left(\frac{b^2 + 48}{b}\right)$$

2.  $x > 7$

3.  $x \leq 9$

4.  $x \geq 46$

5.  $x > 29$

6.  $x > 30$

**Exercise 3.16** (learners book page 85-86)

1. 26 books

2. 5 items

3. 17

4. (a)  $5000 - 255x \geq 2000$

(b)  $w = 11$  weeks

5. (a)  $700 + 12d \leq 8300$

(b) 63 km

6. 42

7. 50 000 FRW

**Unit 3 Test** (Learner's book page 87)

1.  $\frac{13}{6} < x < \frac{20}{3}$

2. (a)  $x \geq -2$

(b)  $x \geq -3$  or  $x > 4$

3. (a)  $x = 44$

(b)  $x = -3\frac{1}{6}$

(c)  $y = 19.69$

(d)  $x = 8$

4. (a)  $x = 5, y = 2$

(b)  $x = 1.79, y = 2.3$

(c)  $x = 3, y = 1$

(d)  $b = 1\frac{8}{39}$   $a = \frac{-32}{273}$

5. 269

6. (a)  $x = -1, y = -2$

(b)  $x = -2, y = 4$

7. (a)  $x \leq 15$

(b)  $3 \leq x < 5$

(c)  $4 < x < 8$

(d)  $x < 6$

(e)  $x < \frac{-10}{7}$

8. (a)  $x = 1, y = 4$

(b)  $x = 19, y = -17$

9. Faces are = 8, Edges are = 12

10. (a)  $a = 30, u = -10$

(b) 200 km/h

(c) 9 h

11. 234

12. Asale: 20, Mbiya: 25

13. 15 000 FRW, 35 000 FRW

# Algebra

## Unit 4

## MULTIPLIER FOR PROPORTIONAL CHANGE

Learner's Book pages 88-94 (30 Lessons)

### Key unit competence

By the end of this unit, the learner should be able to use a multiplier for proportional change.

### Content outline

- 4.1 Proportions
- 4.2 Expressing ratios in their simplest forms
- 4.3 Multiplier for proportional change
- 4.4 Calculation of proportional change using multiplier

Answers

### Learning objectives

#### Knowledge and understanding

- Recognize the properties of proportions
- Express ratio in their simplest form
- Share quantities in a given proportion or ratio.

### Skills

- Solve problems in real life involving multiplier proportion change.
- Apply multipliers for proportional change to solve given problem.
- Use multiplier for proportional change to find the new quantities.
- Use “Decreased by n%” and “Increased n%.”

### Attitudes and values

- Be honest in sharing with other.
- Develop critical thinking in terms of proportion multiplier for proportional change

### Generic competences addresses in this unit

- Communication skills
- Critical thinking
- Problem solving

- Research/innovation
- Cooperation, interpersonal management and life skills.

### Links to other subjects

- Economics, Entrepreneurship, Finance, Accounting, Business Administration and other related fields.

### Cross cutting issues addressed in this unit

- Inclusive education
- Financial education
- Genocide studies
- Peace , gender and values
- Standardization of culture
- Comprehensive and sexuality education
- HIV and AIDS

### Assessment criteria

Explain the importance of money in connection to real life.

### Background information

Multiplier for proportional change is the forth topic of the book. This unit is one of the main areas where learners can pick up a lot of interest to study mathematics. The topic has a lot of applications in the real life situation as it recognizes proportions as a value in the society. The unit deals with both tangible and visible things that learners are able to observe and experience in their everyday activities. Consider

areas where proportionate division is required; proportions and ratios will be required.

## Suggested teaching and learning Activities

### 4.1 Proportions

By the end of this section, the learner should be able to define proportions, give some of its properties and finally its application in real life situation.

**Materials:** Access to internet, exercise books.

### Teaching Guideline 4.1

- Organise the learners into groups consisting of different gender, ability and accommodate all the disabled learners if any.
- Every group to select a group leader/secretary to put down the points discussed and present the findings of the group to the whole class after discussion.
- Ask the learners do activity 4.1 on page 88 in the learner's book to discuss the definition and properties of proportions learned in senior one.
- After the discussion, let the group leader of every group present their findings and let other members of the class to point out omissions and errors in the facts presented.
- Summarize the discussion by giving the right definition of proportion and some of the activities learned in S1.

- Guide the learners through different properties of proportion as discussed in the learner's book for example:

1. Mean-extremes or cross-product properly if  $\frac{a}{b} = \frac{c}{d}$ ,  $ad = bc$

2. Equivalent proportions

if  $\frac{a}{b} = \frac{c}{d} = \frac{e}{f}$  then,

$$\frac{a+c+e}{b+d+f} = \frac{a}{b} = \frac{c}{d} = \frac{e}{f}$$

- Take them through examples 4.1 to 4.4 in pages 88 - 89 in learner's book given on each property.
- Ask the learner's to discuss what equivalent proportion are among themselves and let them report their findings.
- Take them through the discussion in the learner's book.
- Guide the learners through Example 4.5 on page 89 in the learner's book.
- This activity will promote among other competences:
  - (a) Leadership and organizational skills.
  - (b) Critical and problem solving
  - (c) Listening and speaking skills

### Answers to activity 4.1 Learner's book page 88

Learners should have as many examples as they can as long as the change in one variable is proportional to the change in another variable.

### Common examples expected are:

- Rainfall and temperatures
- Demand of a commodity and price

- Supply of a commodity and its price.
- Age and thinking capacity e.t.c

### 4.2 Expressing ratios in their simplest forms

By the end of the section, the learner should be able to express ratios in their simplest form.

### Teaching Guideline 4.2

- Ask the learners to pair up for this activity. The best way of pairing is to ask them to join their immediate neighbours in class according to sitting arrangement.
- Ask the learners to do Activity 4.2 in the learners book page 89 as you guide them through the activity. Remind them on how ratios are simplified by means of either dividing or multiplying the ratio by the same value without necessarily changing the value of the ratio.
- Discuss with the class example 4.6 and 4.7 on page 90 in the learners book. Give the learners time to relate what they are learning with what they had learned before.
- Let the learners do question 1 of exercise 4.1 on page 90 in the learners book as you go through checking their work if they have indeed mastered the content learned.
- Now ask them to do the remaining, question 2 in exercise 4.1 on page 90 in the learner book as their homework.



- The activity will promote among other competences:
  - (a) Problem solving and critical thinking.
  - (b) Leadership and organizational skills.
- Use of question - answer method to find out whether the learners have understood the concept of multiplier, increase and decrease by percentage.
- Take the learners through example 4.10 to 4.12 on page 91 in the learner's book as you guide them through. The three examples are all based on increasing on increasing multiplier.

### Answers to activity 4.2 Learner's book page 89.

Ratios are expressed in form  $a:b$  or  $\frac{a}{b}$   
 $4:12$  is  $\frac{4}{12}$  and when divided by 4 both side

### 4.3 Multipliers for proportional change

By the end of the section, the learner should be able to define a multiplier and its application.

#### Teaching Guideline 4.3

- Organize the learners into pairs based on their sitting arrangement in class and ability.
- Let the learners discuss activity 4.3 on page 90 in the learners book on the definition of multiplier and its application.
- Still in pair, let the learners do example 4.8 and 4.9 on pages 90-91 in the learners book as you discuss with them.
- Using the same group, ask learners to do activity 4.4 on page 91 in the learner's book.
- Guide them through the discussion given in the learner's book.
- The activity will promote among other competencies:
  - (a) Problem solving and critical thinking
  - (b) Leadership and organizational skills
  - (c) Speaking and leadership skills

### Answers to activity 4.3 Learner's book page 91

- Multiplier is a quantity by which a given number is to be multiplied.
- If the shirt is at 20% discount, then the selling price is 80% of the original price.
- The 80% converted to fraction gives and is the multiplier price of the shirt.

## Answers to activity 4.4 learner's book page 91

The cost price of the shirt is 10 000 FRW

At 20% less, the price becomes 80% of 10 000FRW which gives  $\frac{80}{100} \times 10\ 000 = 8000$  FRW

At 20% more, then it is 120% of 10 000FRW, which gives  $\frac{120}{100} \times 10\ 000 = 12000$  FRW

### 4.4 Calculations of proportional change using multiplier

By the end of the section, the learners should be able to solve various calculations on proportional change using multiplier.

#### Teaching guideline 4.4

- Organization the learners into pairs based on their sitting arrangement where every learner works with his/her immediate neighbour.
- Ask the learners to do activity 4.5 on page 92 in the learner's book. The activity explains the level of price reduction with the application of multiplier.
- Still in pairs, let the learners do example 4.15 and 4.16 on pages 92-93 in the learner's book. Go round the class as you check their work to verify if the content is well understood.
- Let the learners do number 1 and 2 of exercise 4.4 on page 93 in the learners book as part of the

class work. Later, let them do the remaining question 3 to 5 of exercise 4.4 on page 93 of the same exercise as their assignment.

- Take learners through the Unit Summary and ask them to do all questions in Unit 4 test on page 94.
- The activity will promote among other competencies, critical thinking and problem solving.

## Answers for activity 4.5 learner's page 92

The marked price of the shirt is 500 FRW

At 10% less, the price becomes 90% of 500 FRW, which gives  $\frac{90}{100} \times 500$  FRW  
 $= 450$  FRW

Therefore, new selling price = 450 FRW

## Answers to the unit 4 exercise

### Exercise 4.1

(Learner's book page 90)

- |            |            |
|------------|------------|
| 1.         | 2.         |
| (a) 2 : 3  | (a) 5 : 1  |
| (b) 3 : 5  | (b) 5 : 1  |
| (c) 4 : 5  | (c) 5 : 2  |
| (d) 1 : 2  | (d) 3 : 40 |
| (e) 4 : 1  | (e) 5 : 4  |
| (f) 1 : 2  | (f) 7 : 5  |
| (g) 20 : 1 |            |
| (h) 2 : 25 |            |

## Answers cont...

(Learner's book page 92)

### Exercise 4.2

- a. 55
- b. 78
- c. 73.5
- d. 360
- e. 900
- f. 656.25

### Exercise 4.3

- a. 160
- b. 142.5
- c. 292.5
- d. 368.5
- e. 970
- f. 1 068.75

### Exercise 4.4

(Learner's book page 93)

- 1. (a) 84
- (b) 375
- (c) 1 500
- (d) 1 312.5
- (e) 3.9
- (f) 100.75
- 3. 9.5 m
- 5. 38 250 FRW
- 2. (a) 480
- (b) 21
- (c) 1 584
- (d) 204.7
- (e) 9.8
- (f) 2 205
- 4. 750 FRW

## UNIT TEST

(Learner's book page 94)

### I.

- (a) 1 : 3
- (b) 1 : 4
- (c) 1 : 4
- (d) 3 : 80

- 2. 1 800 sheep
- 3. 1 040 litres
- 4. 67 200 people
- 5. 6 080 tonnes
- 6. 310 490 litres
- 7. 61 585
- 8. 900 patients
- 9. 3 300 000 litres
- 10. 4 250 000 tones
- II. 4 000 FRW

# Geometry

## Unit 5

## THALES' THEOREM

Learner's Book pages 95 - 104 (12 Lessons)

### Key unit competence

By the end of this unit, the learner should be able to use Thales' theorem to solve problems related to similar shapes, and determine their lengths and areas.

### Content outline

- 5.1 Midpoint theorem
- 5.2 Thales theorem
- 5.3 The converse of Thales theorem

### Answers

### Learning objectives

#### Knowledge and understanding

- Identify and name triangles or trapezium from parallel and transversals intersecting lines
- State Thales' theorem and its corollaries

#### Skills

- Associate extended proportions in the triangles
- Apply Thales' theorem and its corollaries to solve problems on proportions of triangles, trapezium

- Discuss the converse of Thales' theorem

### Attitudes and values

- Develop participation, selfconfidence, determination, and team spirit.
- Appreciate the importance of solving daily activities involving midpoint theorem, Thales' theorem and its converse and application of Thales' theorem.

### Generic competences addresses in this unit

- Communication skills
- Critical thinking
- Problem solving
- Research/innovation
- Cooperation, interpersonal management and life skills.

## Links to other subjects

- Technical drawing, Scientific drawing, Light Physics etc.

## Cross cutting issues addressed in this unit

- Inclusive education
- Financial education
- Genocide studies
- Peace , gender and values
- Standardization of culture
- Comprehensive and sexuality education
- HIV and AIDS

## Assessment criteria

Use Thales' theorem to Solve problems related to similar shapes, and determines their lengths and areas.

## Background information

Thales' theorem is one of the interesting and practical unit in this book. It develops skills in learners especially in the field of construction, carpentry and building. Here learners are able to visualize things which empower them to make critical decision in life. It is of great importance if the learners are exposed to the real world like taking them to the nearest construction company to see for themselves what takes place there.

## Suggested teaching/ learning activities

### 5.1 Midpoint theorem

By the end of this section, the learners should be able to locate midpoint between two locations or points. They

should be able to accurately construct triangles and locate the midpoint of the sides.

## Materials

A ruler, a protractor, set square, a tape measure

## Teaching guidelines 5.1

- Organize the class in pairs and make sure that one of them is writing down their points and present their findings to the class after the discussion.
- Ask learners to do Activity 5.1 given in the Learner's book page 95. To draw a line segment and measure the midpoint.
- Move round the class to check what the learners are doing the right thing and help those who find difficulties.
- After they have completed the activity, ask secretary to present their findings in a class discussion and allow other members of the class to point out any errors in the presentation.
- Summarise the presentation by emphasizing on the accuracy in the construction and go on to give them the activity 5.2 on learner's book page 95-96 i.e. to construct a triangle with the given dimensions. Mid-point is the point halfway between the endpoints of a line segment. It divides a line into two equal parts. To locate the midpoint and join the mid-points to form a parallel line to the third side of the triangle.

- After finishing doing the activity, ask them to present their findings and take this opportunity to summarize the midpoint theorem in triangles and work together example 5.1 page 97 to help drive the point home.
- In their pairs, ask the learners to do activity 5.3 page 97 which talks about midpoint theorem in trapezium.
- Ask the learners to establish the relationship between the line segment which joins the midpoint EF and line AB on figure 5.5.
- Move round the class to help those who have problems.
- At the end of the activity each group should present their finding and ask the rest of the class to supplement in the discussion. Use this opportunity to summarize the theorem in trapezium i.e the line through the mid-point of the two non-parallel sides of a trapezium is parallel to the base of the trapezium. Use Example 5.2 in learner's book page 97-98 to help them to understand more on the theorem.
- Allow the learners to try exercise 5.1 in learner's book page 98.
- This activity will promote:
  - (i) Leadership and organization skills,
  - (ii) Listening/speaking skills.

### **Answers to activity 5.1 learner's book page 95**

1. This is a practical activity. You should therefore ensure that all learners

have fully equipped mathematical sets.

2. If the line AC is half AB, then  $AC = 5 \text{ cm}$  and  $CB = 5 \text{ cm}$
3. This means AC is half of AB that is  $AC = \frac{1}{2} AB$

### **Answers to activity 5.2 learner's book pages 95-96**

Learners should have complete mathematical sets. You should observe how learners are constructing triangle ABC accurately.

If accurate measurements are taken, the length of DE should be half the length of AB and if they accurately construct triangle ABC.

The length of the perpendicular from D to AB should be equal to the length of the perpendicular from E to AB. This draws up a conclusion that DE and AB are parallel.

### **Answers to activity 5.3 learner's book page 97**

Ensure that learners have complete mathematical sets. You should also observe the degree of accuracy by learners when they are constructing trapezium ABCD.

The lengths of the perpendiculars from E and F to the line AD of the trapezium ABCD must be equal and this should draw up a conclusion that AD is parallel to EF.

### **5.2 Thales' theorem and its converse**

By the end of the section, the learners should be able to draw three lines which

are parallel and two transverse lines and establish the proportionality between the lengths.

### Materials:

A ruler, pencil, compass and divider

### Teaching guidelines 5.2

- Organise the learners in pairs to do Activity 5.4 in the learner's book page 98-99 i.e. to find the values of the unknown in the given ratios and to construct triangle with dimension of your choice .
- They should draw a line segment from one side of the triangle to the other side which must be parallel to the third side.
- Ensure that every member of the group is actively participating so that learning takes place to all the learners.
- When the activity is done, listen as different learners report their findings. Verify their findings and emphasize the key points and correct possible errors that arise from the discussion.
- Emphasize on the accuracy of the measurement to be carried out.
- Summarise the discussion by stating the Thales' theorem. *That is: If a line is drawn parallel to one side of a triangle intersecting the other two sides; it divides the two sides in the same ratio.*
- Guide the learners through Example 5.3 on page 99 in the learner's book to clarify Thales' theorem.

- Still with the same group of learners, ask the learners to go and on do activity 5.5 which talks about three parallel lines which are transverse by two lines to establish proportionality between the lengths.
- Work together example 5.4 and 5.5 on page 100 with learners to establish the level of understanding and then ask the learners to try on individual basis to workout example 5.6 on page 100.

### Answers to activity 5.4 learner's book pages 98-99

1. a)

$$4 : 6 = c : 3 \Rightarrow \frac{4}{6} = \frac{c}{3} \Rightarrow c + \frac{4 \times 3}{6} = \frac{12}{6} = 2$$

b)

$$5 : 4 = 15 : x \Rightarrow \frac{5}{4} = \frac{15}{x} \Rightarrow 5x = 60 \Rightarrow x \frac{60}{5} = 12$$

2. a) Learners can draw a triangle of their choice but they should specify their measurements.

b) The ratios compared must be equal from the triangles drawn by the learners.

### Answers to activity 5.5 learner's book pages 99-100

Learners should own fully equipped mathematical sets.

Learners should ensure that the parallel lines constructed have equal distance between them at all intervals.

After constructing the parallel lines, they should observe that figure AEBF is a trapezium.

The lengths of AC, CE, BD and DF can vary from group to group depending on the initial parallel lines drawn.

Learners should then find out that  $\frac{AC}{CE}$  and  $\frac{BD}{DF}$  vary from group to group but they must be equal.

### 5.3 The converse of Thales' theorem

By the end of the lesson, learners should be able to differentiate between Thales' theorem and its converse.

#### Materials

A ruler, pencil, compass and divider

#### Teaching guidelines 5.3

- Organise the class in pairs to do activity 5.6 given in learner's book page 101 that is; to draw a triangle of their own dimension and a line drawn from one side of the triangle to the other side which is not parallel to the third side? They should carry out the measurement of the dimensions asked and check whether the ratios are proportional.
- When they have finish doing the activity, ask one of the members to present their findings and allow the rest of the class to point out omissions or errors during the presentation.
- Take this chance to make any correction where necessary. Emphasize the key point that is converse of Thales' theorem that is summed as; if a line intersects two

sides of a triangle and is not parallel to the third side, then it does not divide the sides in the same ratio. Come up with more parallel examples as one in Activity 5.6. So that it can help them to understand the concept better.

- Ask the learners to do exercise 5.2 on page 101-102 from numbers 1–5 as you move round to check their work and help those who may have difficulties especially slow learners. For the quick, allow them to do number 6 to 8.
- Conclude the lesson by taking learners through the unit summary. List the important points down and give the contrast between Thales' theorem and its converse.

#### Answers to activity 5.6 learner's book page 101

Mathematical sets are a must in this activity.

Learners can have dimensions of their choice in triangle ABC but they should state their dimensions during presentations.

Also learners can have line XY drawn in their own choice.

Measurements for AX, XC, BY and YC can also vary from group depending on values of the measurement obtained from the triangle.

The ratio  $\frac{AX}{XC} = \frac{BY}{YC}$  because lines XY and AB are not parallel.



## 5.4 Unit test

By the end of the lesson, learners should be able to attempt all the questions of the unit 5 test whose questions are picked from the concept of the entire unit learnt.

### Materials

Ruler, compass, protractor, pencil, papers

### Teaching guidelines 5.4

- Organise the class to do the unit test on individual bases. Distribute papers for the learners to do the test. Move round to monitor the learners to avoid cases of copying from each other.
- This lesson promotes problem solving skills, critical thinking, independence and research skills.

### Answers

#### Exercise 5.1

(Learner's book page 98)

1. 12
2. 3 or -2
3. -1 and 3.5
4. 5
5. (a) 23.5  
(b) 8
6. 15 cm

#### Exercise 5.2

(Learner's book pages 101-102)

1. 12
2. 6.5
3. 20
4. 1
5. (a) (i) 15 (ii)  $x-7$  (iii)  $x$   
(b)  $x = 21, y = 12$
6. 2.5
7. 48
8. (a) 12  
(b) 9.6  
(c) 20

### UNIT 5 TEST

(Learner's book page 103-104)

1. 13 cm
2. -3 or -4
3. 4
4. (a)  $n = 10, x = 4$  and  $y = 4.5$   
(b) (i)  $MB:CD = 2:5$   
(ii)  $AM:DN = 4:5$
5. (a) 12  
(b) 7.5  
(c)  $13.5 \text{ cm}^2$  and  $54 \text{ cm}^2$
6.  $AC' = 9 \text{ cm}$  and  $B'C' = 6 \text{ cm}$
7. 12
8. 2.75
9. 6
10. -1 and 3.5

# Geometry

## Unit 6

## PYTHAGORAS' THEOREM

Learner's Book pages 105-119 (9 Lessons )

### Key unit competence

By the end of this unit, the learner should be able to solve problems of lengths in right angled triangles by using Pythagoras' theorem.

### Content outline

- 6.1 Pythagoras' theorem
- 6.2 Proof of Pythagoras theorem
- 6.3 Pythagorean triples
- 6.4 Applying Pythagoras theorem in real life situations

Answers

### Learning objectives

#### Knowledge and understanding

- State Pythagoras' theorem
- Identify the hypotenuse in three sides of a right angled triangle
- List properties of a right-angled triangle

#### Skills

- Use Pythagoras' theorem to find lengths of sides of right angled triangle.
- Apply Pythagoras' theorem to solve problems in range of contexts.

- Demonstrate Pythagoras' theorem practically.

### Attitudes and values

- Appreciate the role of Pythagoras' theorem in solving daily life activities.
- Develop confidence and accuracy in constructing shapes.
- Develop team work spirit and respect analytically the views of others.

### Generic competencies addresses in this unit

- Communication skills
- Critical thinking
- Problem solving
- Research/innovation
- Cooperation, interpersonal management and life skills.

### Links to other subjects

- Technical drawing, Scientific drawing, Optics, etc.

## Cross cutting issues addressed in this unit

- Environmental sustainability
- Inclusive education

## Assessment criteria

Solve problems of length in right-angled triangles by using Pythagoras theorem.

## Background information

Pythagoras' theorem is highly practical and learners find this unit interesting. You should therefore engage the learners in as many activities as possible to arouse interest and help them be innovative. While teaching this, consider the slow learners who may not find this unit interesting. This topic can be applied on many life situations for example when travelling, a person can use a shortcut instead of joining two distances. The provided activities, will help the learners visualize the concept of Pythagoras' theorem and thus understand the concepts easily.

## 6.1 Pythagoras' theorem

By the end of this section, the learner should be able to:

- Identify right-angled triangle.
- Relate the areas of the squares on the two shorter sides and the area of the square on the hypotenuse.

## Material

Mathematical geometrical set

## Teaching guidelines 6.1

- Organize the class into groups to do activity 6.1 on pages 105-106 in learner's book. By this time they should know the need of a group leader and a secretary.

- Let the groups summarize their findings.
- In the same groups let the learners do activity 6.2 on pages 106-107 in learner's book and combine findings from the two activities.
- Now, invite the groups to present their findings in a class discussion through their group secretary.
- Summarize the group presentations emphasizing the key learning points derived from the activities that is:
  - (i) Any triangle that contains a right angle is called a right triangle or right-angled triangle.
  - (ii) The longest side in any right triangle is called the hypotenuse.
  - (iii) The sum of the areas of the square on the two shorter sides is equal to the area of the square on the hypotenuse.
- Ensure that every member of the class makes their own rules for use individually later on.
- Now, individually, let the learners do activity 6.3 on page 107 in order to consolidate the learned concepts on the theorem.
- When activity 6.3 is done, conduct a whole class discussion just to verify their findings.
- This activity should serve as an exercise to find out whether the learners have understood the concept on how the area of the sides of a right-angled triangle relate to each other.
- Guide the learners through the discussion provided in the learner's book pages 106-107 on how to state pythagorus' theorem that is; in a right-angled triangle, the square of the hypotenuse is equal to the sum of the square of the two sides.

- Take learners through example 6.1 on page 108 in learner's book and ask them to do exercise 6.1 on page 108 in learner's book.

### Answer to activity 6.1 learner's book pages 105-106

1. The scale can vary from group to group depending on the learner's wish.
3. Two tiles make a square on the longest side called Hypotenuse.
5. A square has 4 tiles.
6. The relationship is that the sum of the squares of two shorter sides give one longer side.

**NB:** For Activity 6.2 in the learner's book pages 106-107, mark learner's drawing and guide them appropriately.

### Answers to activity 6.3 learner's book page 107

1. Learners should own fully equipped mathematical sets and must be able to construct triangles.

Learners should recognize that the longest side of a right angled triangle is called hypotenuse and should be 5 cm in this activity.

So the area of the squares are;

$$\text{Area} = \text{length} \times \text{width} = 3 \times 3 = 9 \text{ m}^2$$

$$\text{Area} = \text{length} \times \text{width} = 4 \times 4 = 16 \text{ m}^2$$

$$\text{Area} = \text{length} \times \text{width} = 5 \times 5 = 25 \text{ m}^2$$

The area of the square on the hypotenuse side is equal to the sum of areas on the base and height of the triangle.

2. (a) The areas become

$$\text{Area} = \text{length} \times \text{width} = 6 \times 6 = 36 \text{ cm}^2$$

$$\text{Area} = \text{length} \times \text{width} = 8 \times 8 = 64 \text{ cm}^2$$

$$\text{Area} = \text{length} \times \text{width} = 10 \times 10 = 100 \text{ cm}^2$$

- b)  $\text{Area} = \text{length} \times \text{width} = 5 \times 5 = 25 \text{ cm}^2$   
 $\text{Area} = \text{length} \times \text{width} = 12 \times 12 = 144 \text{ cm}^2$   
 $\text{Area} = \text{length} \times \text{width} = 13 \times 13 = 169 \text{ cm}^2$

3. The table should be as below

Side 1	Side 2	Side 3
9cm	12cm	15cm
1.5cm	12.0cm	12.09cm
9cm	2.0cm	9.22cm
15cm	36cm	39cm
2.5cm	6.0cm	6.5cm

### 6.2 Proof of Pythagoras theorem

By the end of this section, the learner should be able to:

- Use algebra to prove the Pythagoras, theorem that they derived in the previous sections.
- Use Pythagoras theorem to calculate the lengths of a right angled triangle.

### Teaching guidelines 6.2

- You may constitute new groups or use the ones used in Activity 6.3 on page 107 in the learner's book.
- Let the learners do activity 6.4 in the learner's book page 109. Your input may be necessary for the learners to begin the activity so that learners understand exactly what they are expected to do and to achieve.
- When the activity is done, allow the groups to reports their findings and conclusions.
- Ensure that their presentations are accurate and correct those that may be erroneous.
- Use the activity 6.4 on page 109 learner's book to emphasise that in a right angled triangle, the square of the hypotenuse is equal to the sum of the square of the two sides of the triangle. Emphasises the learning points and conclusions walk with

them through the activity so that you do not lose any on the way.

- Now, take them through Examples 6.2, 6.3 and 6.4 on pages 110-111 in the learner's book.
- Ask learners to do Exercise 6.2(b) on pages 111-112 as you around checking their working and helping those with problems.

### Answers to activity 6.4 learner's book page 109

The teacher should work with learners in groups to explain this activity because it is well explained step by step.

A teacher should allow learners to ask many questions as they can on this activity because explanation is well given.

### 6.3 Pythagorean triples

By the end of this section, learners should be able to identify a Pythagorean triples using some acceptable relations including the one we have just dealt with.

#### Additional information

A pythagorean triple consists of three positive integers say;  $a, b$  and  $c$  such that  $a^2 + b^2 = c^2$ . Such a triple is commonly written as  $(a,b,c)$ . There are infinitely many such triples. The well-known example is  $(3,4,5)$ .

One method of generating pythagorus triple is:

For any positive integer  $m > n$ , where

$$a = m^2 - n^2$$

$$b = mn$$

$$c = m^2 + n^2$$

Then,  $(a,b,c)$  is a pythagorean triple. For example, if  $m = 1$  and  $m = 2$  then,  $a = 3, b = 4, c = 5$  and  $3^2 + 4^2 = 5^2$ .

### Teaching guidelines 6.3

- Organize the class into pairs to do activities 6.5 on page 112 in learner's book.
- Guide them through the activity on question 1-4 and allow the learners to complete the patterns in activity.
- Check whether the learners obtained the following results from the remaining questions in the activity:
  5.  $(11, 60, 61)$
  6.  $(13, 84, 85)$
  7.  $(15, 112, 113)$
  8.  $(17, 144, 145)$
  9.  $(19, 180, 181)$
  10.  $(21, 220, 221)$
- Conclude the activity by noting that. If we denote a pythagoream triple as  $a, b, c$  then
  - (i)  $a < b < c$  and  $a, b$  and  $c$  are positive integers.
  - (ii)  $b$  and  $c$  are consecutive number.
  - (iii)  $b + c = a^2$
- Take the learners through example 6.5 on page 113 in learner's book to ensure that they master the concept on Pythagorean triples in this part.
- With the same pair used in Activity 6.5 on page 112 in learner's book ask learners to do activity 6.6 on page 113 in the learner's book.
- Guide them through question 1-4 in the activity and allow them to continue with the rest of the questions 5-10 in activity 6.6 page 113 of learner's book.
- Check whether the learners obtained the following result from the remaining questions in the activity:
  5.  $48 + 50$
  6.  $63 + 65$
  7.  $80 + 82$
  8.  $99 + 101$

9.  $120 + 122$

10.  $143 + 145$

- Summarise the activity by taking learners through the discussion given in the learner's book page 113.
- Let them note that if  $a, b, c$  is a pythagoras triple, then:
  - (i)  $a < b < c$
  - (ii)  $b + 2 = c$
  - (iii)  $b + c = \frac{1}{2}a^2$
- Now, take learners through example 6.6 and if need be model and work through some more examples.
- Guide them through the discussion that follows to put more emphasis on the concept of pythagorean triple learnt.
- Take them through example 6.7 on page 114 in learner's book before asking them to do exercise 6.3 on pages 114-115 in the learner's book.

#### 6.4 Using Pythagoras theorem in real life

By the end of this section, the learner should be able to:

- Identify real life situations calling for use of Pythagoras' theorem.
- Apply the theorem in such situations.

#### Teaching guidelines 6.4

- Organise learners into appropriate groups according to their sitting arrangement in class. Ask them to do activity 6.7 on page 115 in learner's book.
- As the groups to discuss their situations, encourage them to make notes, and represent their situations in clear diagrams which they can demonstrate on the chalkboard.
- Encourage the groups to present

their observations in a class discussion while others listen in order to give positive feed back.

- All the presentations must be accompanied by appropriate sketch diagrams which shows how pythagoras' theorem is applied in real life and how it should be self explanatory.
- Summarise their presentation by emphasising that there are many situations in life where pythagores' theorem is applied. For instance when leaning a ladder on a vartical wall and use it to climb up the wall, when observing objects from roof tops of a cliff among others.
- Take the learners through some of real life situations captured on the learner's book pages 115-116.
- Go through other situations that learners listed which were not captured in the learner's book and guide them appropriately.
- Take learners through examples 6.8 on page 116 in the learner's book.
- Ask them to do exercise 6.4 on pages 117-118 in the learner's book.
- Guide the learners through the unit summary as you conclude this section.
- Ask the learners to do unit 6 test on pages 118-119 in the learner's book as homework.
- The activities in this unit should promote in the learners:
  - Leadership and organization skills.
  - Communication skills.
  - peace , gender and values
  - comprehensive and sexuality education.

### **Activity 6.7**

*(learners book page 115)*

Learners should have as many applications of Pythagoras' theorem as possible. The following are some of those applications.

1. Ladders used when climbing to the top of the houses and electric poles.
2. The view of the televisions is among the factors when purchasing a television. Given the length and height of a rectangular television, the diagonal of viewing can be calculated by Pythagoras' theorem.

3. Construction sector for example fitting tiles in houses.
4. Calculation of site of view for example electric poles. The nearer pole appears taller while the far pole appears shorter because the hypotenuse for the far pole is too much.

Any other application listed by learners and with strong reasons should be accepted by a teacher.

## Answers

### Exercise 6.1

(learner's book page 108)

1. Right angled triangles are:

(a)  $AB = 24$  cm,  $BC = 10$  cm,

$AC = 26$  cm

(c)  $GH = 10.6$  cm,  $HF = 5.6$  cm

$1G = 9.0$  cm

(d)  $JK = 16$  mm,  $KL = 34$  m

$LJ = 30$  mm

**Note:** Mark the method used by the learner

2. (a)  $45$  cm<sup>2</sup>                      (b)  $58$  cm<sup>2</sup>  
(c)  $2.34$  cm<sup>2</sup>                      (d)  $109.89$  cm<sup>2</sup>  
(e)  $76.08$  cm<sup>2</sup>                      (f)  $107.72$  mm<sup>2</sup>

### Exercise 6.2

(learner's book pages 111-112)

1. (a)  $13$  cm    (b)  $3$  cm    (c)  $1.536$   
2. (a)  $10$  cm    (b)  $17$  cm  
(c)  $12$  cm    (d)  $14$  cm  
3.  $5.83$  cm                      4.  $4.47$  cm  
5.  $a = 3.4$  cm     $b = 10.1$  cm     $c = 8$  cm  
 $d = 2.9$  cm     $e = 2.5$  cm     $f = 36.4$  cm  
6.  $a = 9$  m         $b = 15$  m         $c = 20$  m  
 $d = 14$  m  
7.  $10.09$  cm  
8.  $66.46$  cm  
9. (a)  $25$         (b)  $10$         (c)  $19.1$   
10. (a)  $\frac{\sqrt{302}}{2}$     (b)  $2\sqrt{14}$     (c)  $\frac{2409}{2\sqrt{2}}$   
11.  $2\sqrt{2}$   
12. (a)  $4.5$  cm                      (b)  $13$  cm

### Exercise 6.3

(learner's book pages 114-115)

1. (a)  $(10, 24, 26)$ ,  $(15, 36, 39)$ ,  
 $(20, 48, 52)$ ,  $(25, 60, 65)$   
(b) Yes    (c)  $(na, nb, nc)$   
2. (a) Yes    (b) Yes                      (c) No  
(d) No    (e) Yes                      (f) Yes

3. (b)  
4. (a)  $8, 15, 17$                       (b)  $10, 24, 26$   
(c)  $24, 32, 40$                       (d)  $48, 55, 73$   
5. (a)  $312, 313$                       (b)  $480, 481$   
(c)  $924, 925$                       (d)  $1\ 200, 1\ 201$   
(e)  $224, 226$                       (f)  $360, 362$   
(g)  $483, 485$                       (h)  $1\ 023, 1\ 025$   
6. (a), (b), (d), (f), (j), (l), (m), (n), (o)  
and (p)

### Exercise 6.4

(learner's book pages 117-118)

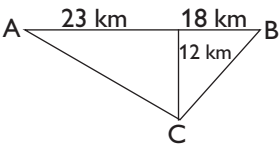
1.  $20$  m                      2.  $6.5$  m  
3.  $69.3$  m,  $297.7$  m<sup>2</sup>  
4. (a) It is right-angled    (b) No  
5.  $2.51$  m  
6.  $19.47$  m                      7.  $21.26$  m  
8. (a)  $3$  m                      (b)  $8$  m  
9. 

(a)  $21.63$  km                      (b)  $25.94$  km  
(c)  $41$  km  
10.  $57.60$  m

### Unit 6 test

(learner's book pages 118-119)

1.  $30$  cm  
2.  $5$  cm  
3.  $12.5$  m  
4.  $15.1$  m  
5. (a)  $10$  cm    (b)  $19.9$  cm  
6.  $20.7$  cm  
7.  $32.33$  cm



# Geometry

## Unit 7

## VECTORS

Learner's Book pages 120-139 (18 Lessons)

### Key unit competence

By the end of this unit, the learner should be able to solve problems using operation on vectors.

### Content outline

- 7.1 Concept of a vector, definition and properties
  - 7.2 Vectors in a Cartesian plane
  - 7.2 Operations on vectors
  - 7.3 Position vectors
  - 7.3 Multiplication of a vector by a scalar
  - 7.4 Magnitude of a vector
- Answers

### Learning objectives

#### Knowledge and understanding

- Define a vector
- Represent a vector in a cartesian plane
- Differentiate between vector quantities and scalar quantities.
- Show whether vectors are equal.

### Skills

- Use vector notations correctly and perform operations on vectors
- Find the components of a vector in the Cartesian plane
- Find the magnitude of a vector

### Attitudes and values

- Appreciate the importance of vectors in motion
- Show self-confidence; and, determination while solving problems on vectors

### Generic competences addresses in this unit

- Communication skills
- Critical thinking
- Problem solving
- Research/innovation
- Cooperation, interpersonal management and life skills

### Links to other subjects

- Physics (forces)

## Cross cutting issues addressed in this unit

- Inclusive education
- Financial education
- Genocide studies
- Peace , gender and values
- Standardization of culture
- Comprehensive and sexuality education
- HIV and AIDS

### Background information

Solve problems using operation on vectors.

### Background Information

A vector is a physical quantity that has both magnitude and direction.

It is one of which learners can pick in the field of mathematics. Vectors are highly used in many fields like navigation when finding directions.

Since this is a practical unit, learners can be asked how directions can be estimated and sizes of objects.

### Suggested teaching/learning activities

#### 7.1 Concept of a vector, definition and properties

By the end of this section, the learner should be able to define a vector and give examples of vector quantities, distinguish between vector and scalar quantities and geometrically represent a vector.

### Materials

Chalk, mathematical sets, exercise books.

### Teaching guidelines for 7.1

- Organise the learner's in pairs to do activity 7.1 in learners' book page 120.
- One of them should work as a secretary who should write down the observations and findings made in activity 7.1 page 120.
- Let the groups present their findings in class through discussions and presentations through the group secretaries.
- Summarise the presentations by explaining what a vector quantity is, that is, a vector quantity is any quantity that has both magnitude and direction. Highlight more examples of vector quantities because sometimes learners find it difficult to distinguish between a vector and a scalar.
- Explain the notation of vectors and how a vector can be geometrically represented.
- This is also best explained in learners book.

### This activity will promote:

- Leadership skills and organisation skills.
- Good communication skills.

## Answers to activity 7.1 learner's book page 120

1. a) - Length of the journey to be covered  
- Direction of the next destination  
b) A vector the name of the above two aspects.
2. The distance can vary depending on the school location  
Direction can also vary.
3. a) Distance is 266.2km  
b) Displacement 0  
c) Distance is scalar  
Displacement is a vector

## 7.2 Vectors on a cartesian plane

### 7.2.1 The null vector

By the end of this section, the learner should be able to present a vector on a cartesian and explain what a null vector is with ease.

#### Materials

Chalk, mathematical sets, graph papers

#### Teaching guidelines for 7.2.1

- Organise learners in pairs, provide them with graph papers, one learner should work as a secretary to present down the findings of the activity.
- Let the learners do activity 7.2 in learners book page 121.
- Let them present their findings through class discussion.
- Use the opportunity to explain how a vector is presented on cartesian plane.
- Generate more examples on how the vector can be presented on a cartesian plane to help learners understand the concept.
- Guide the learner through the discussion on column vector in learner's book page 121
- Explain example 7.1 on page 122 in learner's book to prepare them for exercise 7.1 on page 122 in learner's book.
- Ask learners to do question 1 of exercise 7.1 in the learner's book page 122.
- Identify quick learners and slow learners as you move around the class checking their work.
- As you are helping slow learners, let the quick learners do question two of exercise 7.1 on page 122, mark their work and guide them appropriately.
- Now discuss with learners what a null vector is, that is; a vector without magnitude and direction.
- Guide them through examples 7.2 and 7.3 in learner's book on page 123.
- Ask learners to do question 1 of Exercise 7.2 in learner's book page 123.
- Conclude this section by checking learner's work and guiding them appropriately.
- This section will promote in learners among other competence the:

- Leadership skills
- Listening/speaking skills
- Construction skills

### Answers to activity 7.2 learner's book page 121

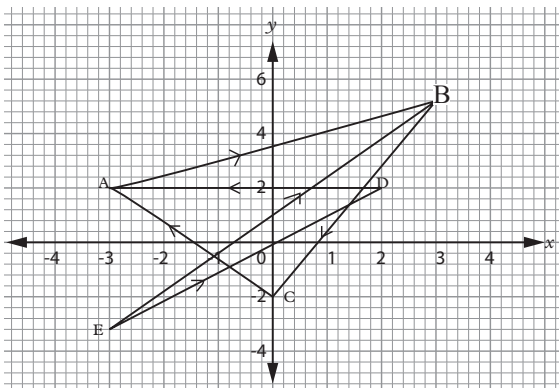

#### 7.2.2 Equivalent of vector

By the end of this section, the learners should be able to understand equality of vectors.

#### Materials

Mathematical sets

#### Teaching guidelines 7.2.2

- Organise the learners in pairs, one of them must work as a secretary to note down the findings.
- Let the learners do activity 7.3 in learner's book page 123.
- Allow the learners to present their findings through their secretaries.
- Use the opportunity to explain the equality of vectors as explained in learner's books.
- Revisit example 7.3 in the learner's book page 122 and guide the learners through using the idea of equivalent vector. This will enable them to understand better the

concept of equivalent.

- Allow learners to do questions 1, 2, 4 and 5 of exercise 7.2 in the learner's book page 123 - 124.

From learners' book. Pass around the class to mark their answers. Let quick learners do question 3 which is more challenging as you help the slow learners.

- Summarise and conclude the lesson by correcting all the errors. This section will promote in learners amongst other competencies:
  - Observation skills
  - Leadership and organization skills

### Answers to activity 7.3 learner's book page 122

- AB and DC have the same magnitude and direction.  
 $AB=DC$ , meaning AB and DC are parallel vectors.
- DA and BC have the same magnitude but different directions.  
 $BC=-DA$ , they are parallel vectors.

#### 7.2.3 Midpoints

By the end of this section, the learner should be able to understand midpoints and their applications.

#### Materials

Chalk, mathematical set, graph papers

#### Teaching guidelines 7.2.3

- Organise the learners in pairs, one should work as a secretary to note the findings.
- Provide the pairs with graph papers.
- Let the learners do activity 7.4 in

learner's book page 124.

- Allow the learners to present their findings through secretaries in class discussion.
- Use this opportunity to correct them by explaining what midpoint is and how it can be found by construction and by calculation.
- Take them through a discussion given in the learner's book.
- Guide the learners in doing example 7.4 on page 124.
- Allow learners to do exercise 7.3 on pages 123-124 as you move around the class correcting their mistakes.
- Conclude the lesson by correcting errors.
- This part of the unit will promote:
  - Leadership skills
  - Communication skills
  - Confidence among other competences

### **Answers to activity 7.4 learner's book page 124**

1. The desks can vary depending on the size of the class. A teacher should determine the number according to the class size.
2. a) Learners should use their own scale.  
b) They should find the midpoint to be at  $(4, 4)$ .

## **7.3 Operation of vectors**

### **7.3.1 Addition and subtraction of**

### **vectors**

By the end of this section, the learner should be able to understand addition and subtraction of vectors.

### **Materials**

Chalk, mathematical sets

### **Teaching guidelines 7.3.1**

- Organise the learners in pairs, one should be the secretary. Ensure gender balance for mixed class.
- Let the learners do activity 7.5 in learner's book page 125.
- Through class discussion, let the learners present their findings through the secretaries.
- Use the opportunity to explain fully how addition and subtraction of vectors can be done algebraically and by construction. This is well explained in learner's book pages 125-126.
- Guide the learners in doing example 7.5 on page 126.
- Allow learners to do exercise 7.4 from the learner's book on pages 127-128.
- Make sure you identify quick learners and slow learners. Help slow learners by correcting their errors.
- Conclude the lesson by summarizing the facts and giving home work.
- This section will promote among other competences:

- Gender balance
- Communication and leadership/ skills

### Answers to activity 7.5 learner's book page 125

a) i)

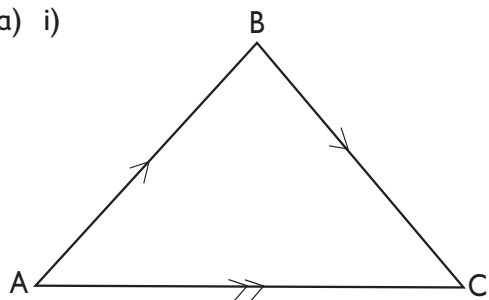

ii)

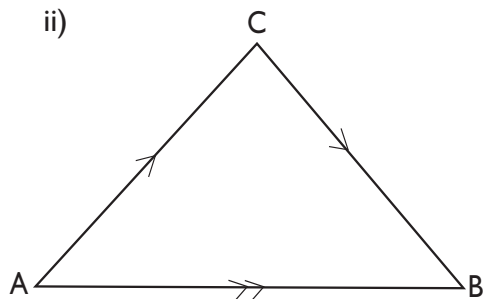

iii)  $AC = AB + BC$

b) i)

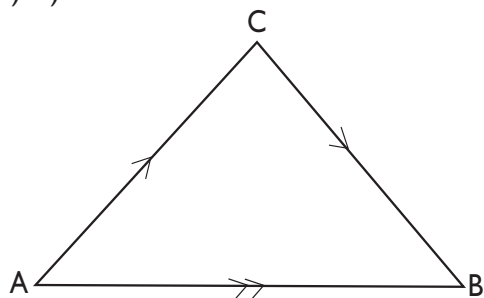

ii)  $AC = AB + BC$

c) (a) (iii) and b (ii) are equivalent

### column vectors

By the end of this section, the learner should be able to add and subtract column vectors.

### Materials

Chalk, graph papers, mathematical sets

### Teaching guidelines 7.3.2

- Organise the learners in pairs, one should act as the secretary. Provide them with graph papers.
- Let the learners do activity 7.6 in learner's book on page 128.
- Allow the learners to present their findings through class discussion. Use the opportunity to explain to them how column vectors can be added and subtracted. Explain the formulas used shown in the learner's book pages 128-129.
- Do examples 7.6 and 7.7 on pages 127-128 to the learners after demonstrating the formula and the techniques used.
- Let the learners do exercise 7.5 on pages 129-130 from question 1 to question 4. Give the rest as homework.
- Summarise the lesson and correct the errors as you conclude.

### This section will promote among other competences:

- Good communication skills
- Leadership skills among other competences.

### Answers to activity 7.6 learner's book page 128

### 7.3.2 Addition and subtraction of

- a)  $\mathbf{r} = \begin{pmatrix} 2 \\ 2 \end{pmatrix}$ ,  $\mathbf{p} = \begin{pmatrix} 3 \\ 1 \end{pmatrix}$ ,  $\mathbf{q} = \begin{pmatrix} 5 \\ 3 \end{pmatrix}$
- b)  $\mathbf{r} + \mathbf{p} = \begin{pmatrix} 2 \\ 2 \end{pmatrix} + \begin{pmatrix} 3 \\ 1 \end{pmatrix} = \begin{pmatrix} 5 \\ 3 \end{pmatrix}$
- c)  $\mathbf{r} + \mathbf{p} = \mathbf{q}$  is the mathematical expression
- d)  $-\mathbf{r} - \mathbf{p} = -\mathbf{q}$ . On the Cartesian plane

#### 7.4 Position vector

By the end of this section, the learner should be able to understand position vector and its operations.

##### Materials

Chalk, mathematical sets

##### Teaching guidelines 7.4

- Hold a whole class discussion on position vectors.
- Basing on previous operations, explain what position vector is.
- Guide the learners through the discussion provided in the learner's book on position vector pages 130-131.
- Guide them through examples 7.8 to 7.11 in the learner's book pages 131-132.
- Ask learners to do Exercise 7.6 on pages 132-133. Mark their work and guide them appropriately to ensure that the concept of position vector is well understood by the learners.
- This section will promote among other competences; problem solving skills.

#### 7.5 Multiplying vectors by a scalar

By the end of this section, the learner should be able to multiply a vector by a scalar correctly.

##### Materials

Chalk, metre ruler

##### Teaching guidelines 7.5

- Organise learners in pairs to do activity 7.7 in learner's book pages 133-134.
- Guide the learners through the activity and let them discuss with their classmate.
- Allow the learners to present their findings in class discussions through their group leaders.
- Use the opportunity to explain scalar multiplication of a vector as explained in learners' book on page 133.
- Take them through example 7.12 on page 134 and deeply explain how scalar multiplication affects a vector quantity.
- Allow the learners to do exercise 7.7 on pages 134-135 in their exercise books. Identify quick learners and slow learners. Quick learners should be helped by giving more challenging questions and slow learners should be corrected.
- This section will promote among other competences:
  - Leadership skills
  - Good communication skills

among other competences

### Answers to activity 7.7 learner's book pages 133-134

(a)

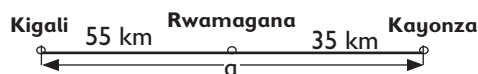

Total distance = 55 km + 35 km = 90 km

(b) (i) From Rwamagana to Kayonza

we have  $\frac{35}{90} a = \frac{7}{18} a$

(ii) From Kayonza to Rwamagana

we have  $-\frac{7}{18} a$  because we take the opposite direction.

### 7.6 Magnitude of a vector

By the end of this section, learners should be able to find the magnitude of a vector.

**Materials:** calculators, chalk

#### Teaching guidelines

- Organise the learners in appropriate group. Appoint one learner as the secretary for each group.
- Instruct the learners to do activity 7.8 in learner's book on page 135.
- Guide the learners through the activity and the discussion there after in the learner's book page 135.
- Ask learners to pair up to do activity 7.9 in the learner's book page 135.
- Let the learners present their

findings in class discussion through their group leaders.

- Correct them where they are wrong and explain comprehensively the meaning of magnitude/modulus and establish the formula involved. For instance, if two points;  $A(x_1, y_1)$  and  $B(x_2, y_2)$  lie in x - y plane then  $|\mathbf{AB}| = \sqrt{(x_2 - x_1)^2 + (y_2 - y_1)^2}$
- Do examples 7.13 and 7.14 in learner's book page 136 to make them understand more about modulus.
- Allow them to discuss examples 7.15 and 7.16 on page 137 among themselves as you monitor them.
- Let the learners do the first four questions of exercise 7.8 in the learner's book pages 137-138. Move around the class correcting their errors. Identify quick and slow learners. Correct their errors and give the rest of the exercise as home work.
- Take the learners through the unit summary and ask them to do all questions in Unit 7 test on pages 138-139 as homework.
- Ensure that you have marked learner's homework on Unit 7 test. This will give you an opportunity to find out the areas where the learners have a challenge and guide them appropriately.

**This section will promote among other competences:**



- Leadership skills
- Good communication skills

**Answers to activity 7.8 learner's book page 135**

1. Invalid statement. Distance cannot be negative.

2.

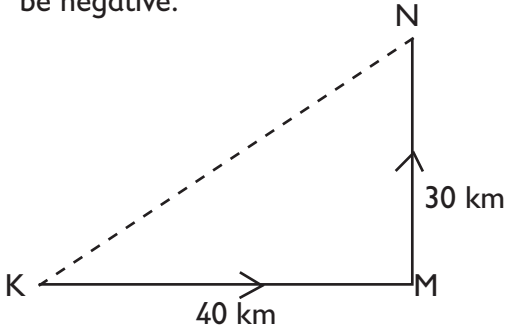

$$|\mathbf{KN}|^2 = |\mathbf{KM}|^2 + |\mathbf{MN}|^2$$

$$|\mathbf{KN}|^2 = 40^2 + 30^2 = 2500$$

$$|\mathbf{KN}| = 50 \text{ km}$$

The shortest distance is 50 km

**Answers to activity 7.9 learner's book page 135**

1. If,  $A(x_1, y_1), B(x_2, y_2)$

$$\text{Then, } \mathbf{AB} = \sqrt{(x_2 - x_1)^2 + (y_2 - y_1)^2}$$

2.

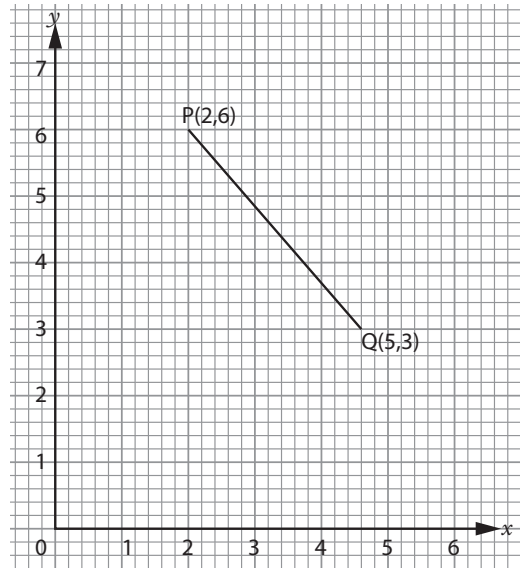

# Answers

## Exercise 7.1

(Learner's book page 122)

1. (a)

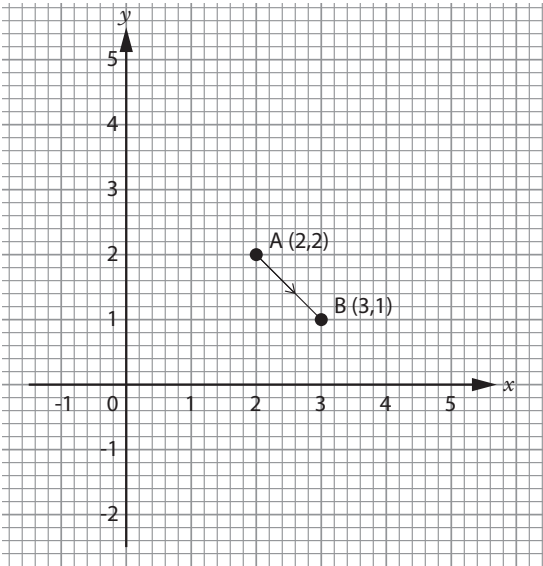

(b)

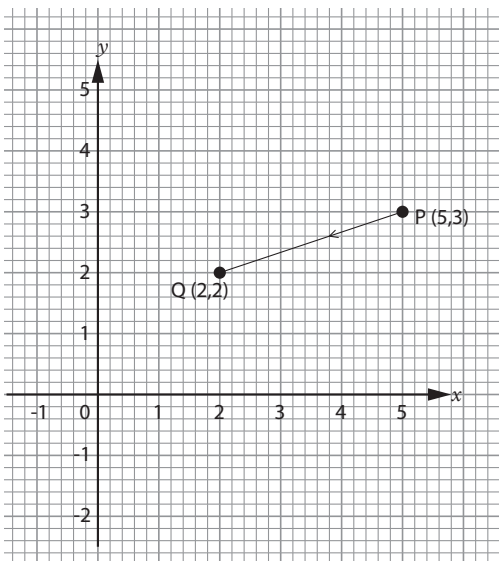

(c)

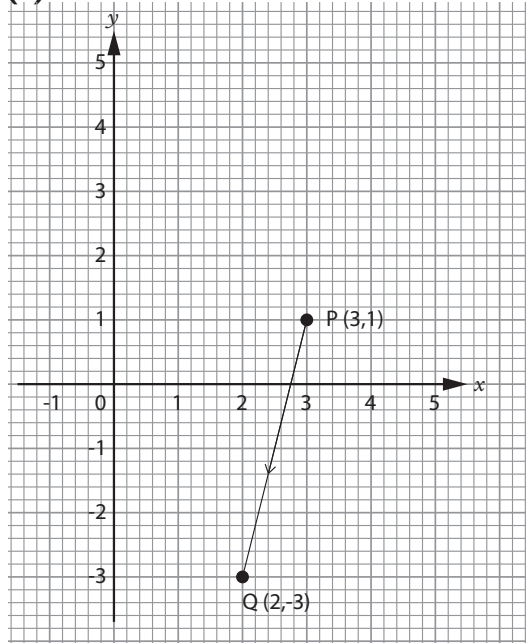

(d)

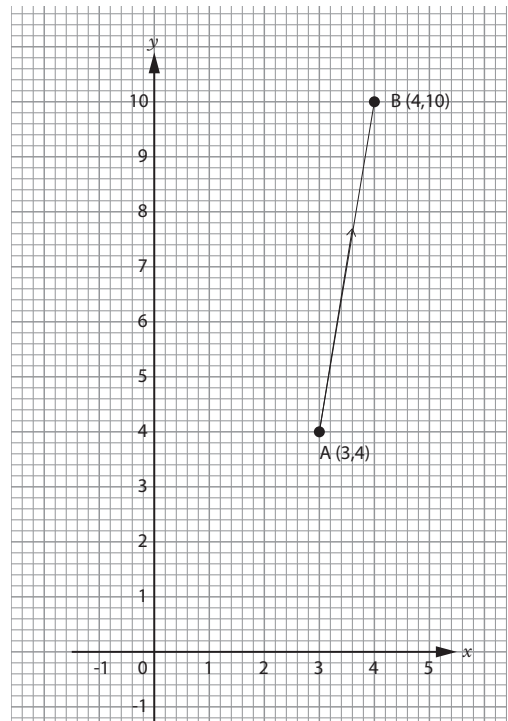

(e)

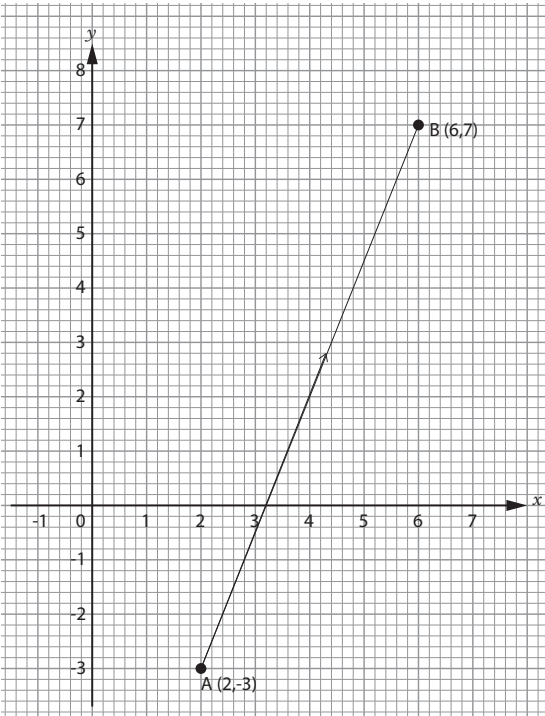

(f)

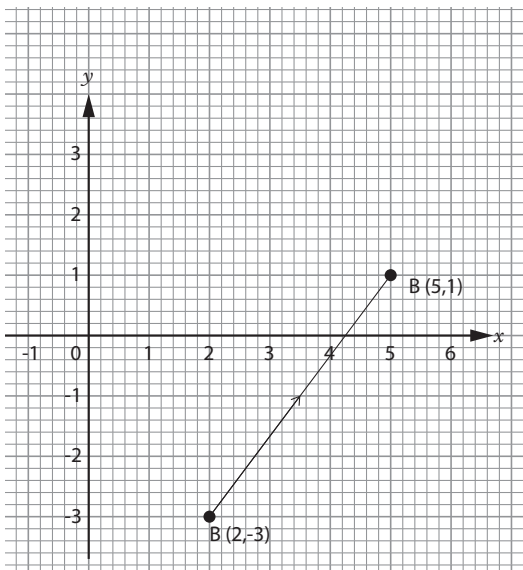

2. (a)  $\begin{pmatrix} 1 \\ -11 \end{pmatrix}$  (b)  $\begin{pmatrix} -3 \\ 3 \end{pmatrix}$  (c)  $\begin{pmatrix} -12 \\ -4 \end{pmatrix}$  (d)  $\begin{pmatrix} 1 \\ -7 \end{pmatrix}$

### Exercise 7.2

(Learner's book pages 124-125)

1.  $x = -\frac{1}{2}, y = -49$

2.  $k = 8, x = 5$

3. (a) (i) **DE** (ii) **EF**

(b) No. Because they face different directions

4.  $a = 2, y = 12$

5.  $x = -\frac{3}{4}, y = \frac{-24}{7}$ ,

### Exercise 7.3

(Learner's book pages 124-125)

1. (a)  $\left(\frac{7}{2}, 2\right)$  (b) (1, 5)

(c) (4, 1) (d) (0, 2)

2. (i) (a)  $\begin{pmatrix} 1 \\ 3 \end{pmatrix}$  (b)  $\begin{pmatrix} 8 \\ 0 \end{pmatrix}$

(c)  $\begin{pmatrix} -10 \\ -7 \end{pmatrix}$  (d)  $\begin{pmatrix} 21 \\ -1 \end{pmatrix}$

(e)  $\begin{pmatrix} 1 \\ 1 \end{pmatrix}$  (f)  $\begin{pmatrix} 6 \\ -4 \end{pmatrix}$

ii) (a)  $\begin{pmatrix} 7 \\ 2 \\ 2 \end{pmatrix}$  (b) (1, 1)

(c)  $\begin{pmatrix} -7 \\ -9 \\ 2 \end{pmatrix}$  (d)  $\begin{pmatrix} 3 \\ 1 \\ 2 \end{pmatrix}$

(e)  $\begin{pmatrix} -15 \\ 2 \\ 2 \end{pmatrix}$  (f) (0, 0)

3. (a) S(2, 2)

(b) Mid of PQ: (2.5, 1) mid of PS: (1.5, 1)

Mid of QR: (4.5, 3) mid of SR: (3.5, 3)

### Exercise 7.4

(Learner's book pages 127-128)

1. Vectors in (a)

2. (a) **SU** (b) **TR**  
 (c) **-RT** (d) **US**  
 (e) **UR** (f) **UT**  
 (g) **0** (h) **0**  
 (i) **RU** (j) **UR**  
 (k) **0** (l) **0**

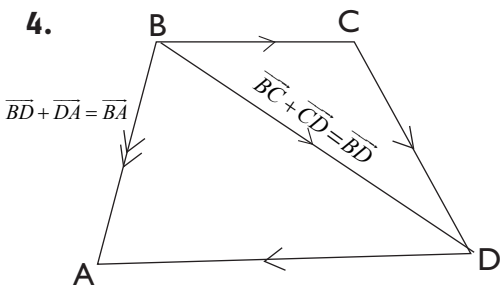
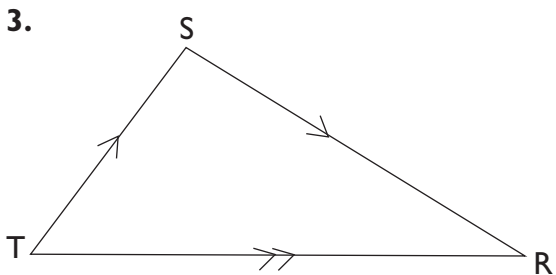

5. Mark the learners' construction

6. **a** and **b** are equal

7.

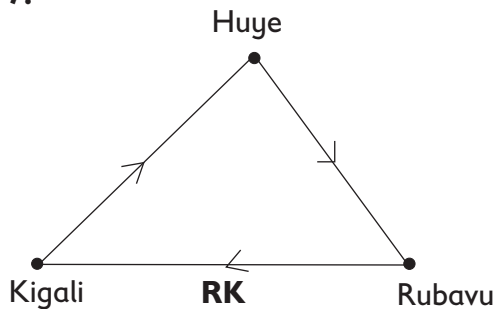

8.

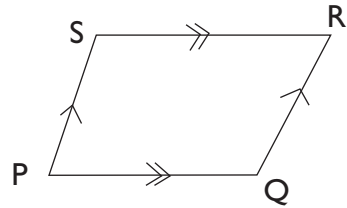

- (a) **PS = QR**  
**SR = PQ**  
 (b) (i) **PR** (ii) **PR**  
 (iii) **SQ** (iv) **SQ**

9.

- (a) **EB** (b) **EB**  
 (c) **BD** (d) **BC**  
 (e) **BD** (f) **OD**  
 (g) **ED** (h) **DE**  
 (i) **CE**

10.

- (a) **-u** (b) **w**  
 (c) **-a** (d) **b**  
 (e) **v**

### Exercise 7.5

(Learner's book pages 129-130)

1. (a)

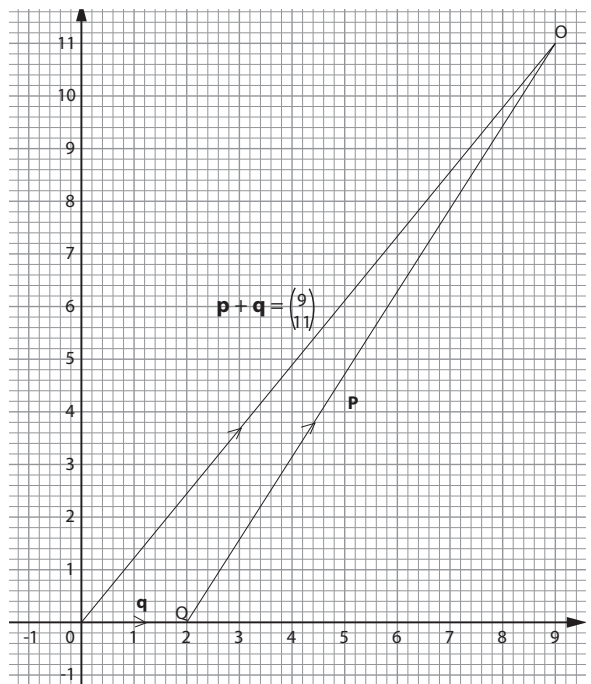

(b)

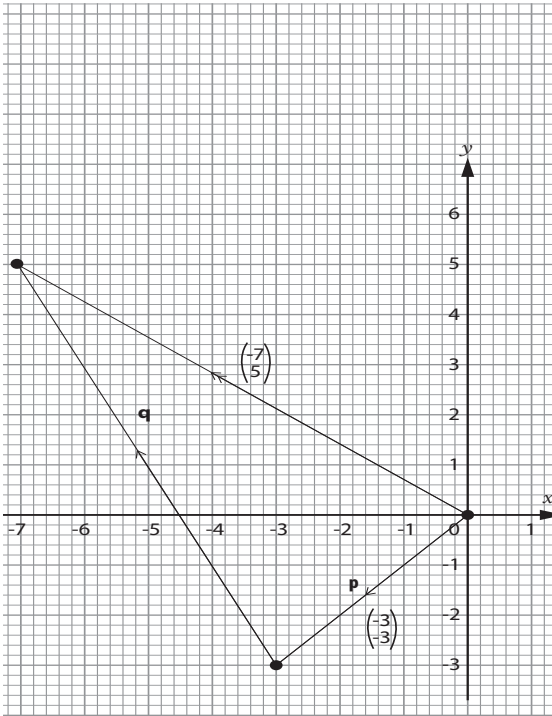

(c)

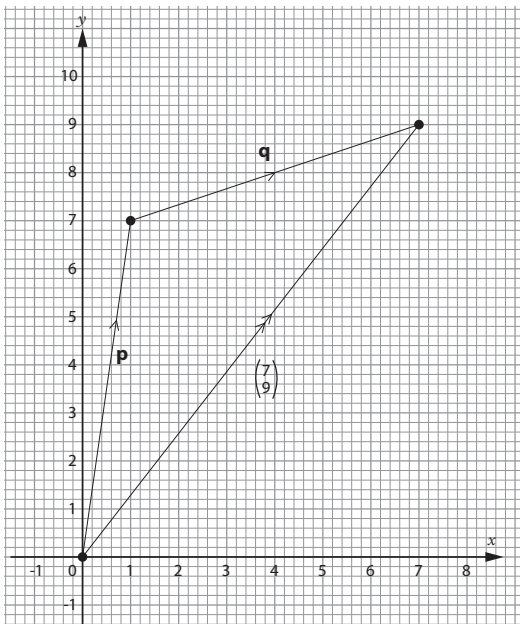

2. (a)  $\begin{pmatrix} -7 \\ -11 \end{pmatrix}$  (b)  $\begin{pmatrix} -5 \\ 6 \end{pmatrix}$  (c)  $\begin{pmatrix} 3 \\ 3 \end{pmatrix}$

(d)  $\begin{pmatrix} -2 \\ 0 \end{pmatrix}$  (e)  $\begin{pmatrix} 4 \\ -8 \end{pmatrix}$  (f)  $\begin{pmatrix} 0 \\ 0 \end{pmatrix}$

3. (a)  $\mathbf{FG} \begin{pmatrix} 2 \\ 2 \end{pmatrix}$ ,  $\mathbf{TU} \begin{pmatrix} 2 \\ 2 \end{pmatrix}$

(b) **KL**

(c) No, have different directions

(d) Yes, direction and magnitude equal

(e)  $\mathbf{EH} = \begin{pmatrix} 1 \\ 2 \end{pmatrix}$

(f)  $\begin{pmatrix} -3 \\ 0 \end{pmatrix}$

(g) **FG, TU, AB**

(h) **RS**

4.  $\mathbf{AB} = \begin{pmatrix} 2 \\ 2 \end{pmatrix}$        $\mathbf{CD} = \begin{pmatrix} 1 \\ 2 \end{pmatrix}$

$\mathbf{FG} = \begin{pmatrix} 2 \\ 2 \end{pmatrix}$        $\mathbf{TU} = \begin{pmatrix} 2 \\ 2 \end{pmatrix}$

$\mathbf{EF} = \begin{pmatrix} 1 \\ -2 \end{pmatrix}$        $\mathbf{MN} = \begin{pmatrix} 3 \\ 0 \end{pmatrix}$

$\mathbf{RS} = \begin{pmatrix} -1 \\ 1 \end{pmatrix}$        $\mathbf{PQ} = \begin{pmatrix} -1 \\ 2 \end{pmatrix}$

$\mathbf{GH} = \begin{pmatrix} -2 \\ 2 \end{pmatrix}$        $\mathbf{KL} = \begin{pmatrix} 1 \\ -2 \end{pmatrix}$

$\mathbf{GM} = \begin{pmatrix} -2 \\ 2 \end{pmatrix}$

5. (a)  $\begin{pmatrix} -9 \\ -1 \end{pmatrix}$  (b)  $\begin{pmatrix} -6 \\ 5 \end{pmatrix}$  (c)  $\begin{pmatrix} 3 \\ 6 \end{pmatrix}$

6.  $\begin{pmatrix} 2 \\ 6 \end{pmatrix}$

7.  $\begin{pmatrix} -3 \\ 9 \end{pmatrix}$

8. (a)  $\begin{pmatrix} 4 \\ -2 \end{pmatrix}$  (b)  $\begin{pmatrix} 9 \\ 4 \end{pmatrix}$  (c)  $\begin{pmatrix} 3 \\ 12 \end{pmatrix}$

9.  $\mathbf{FG} + \mathbf{GH} = \mathbf{FH}$ , Resultant vector

10. (a)

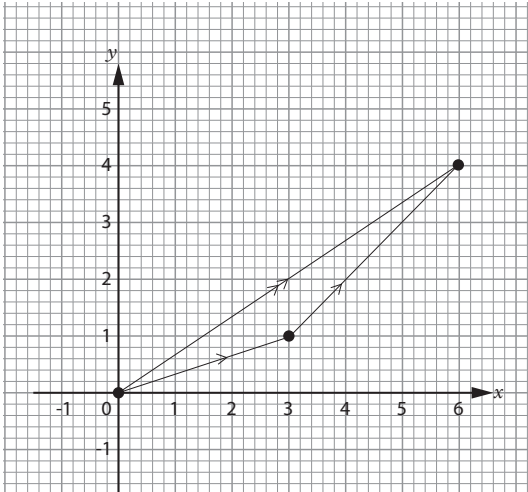

(b)

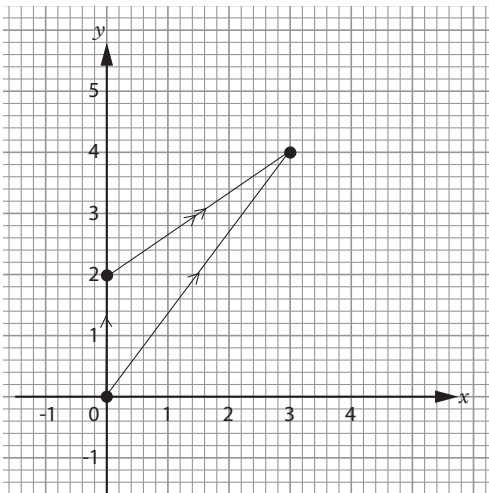

(c)

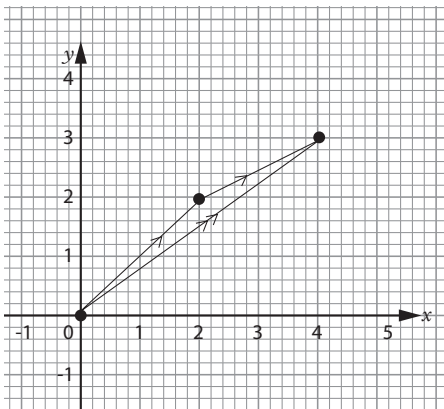

11. (a)  $\begin{pmatrix} 7 \\ 5 \end{pmatrix}$  (b)  $\begin{pmatrix} 6 \\ 5 \end{pmatrix}$

(c)  $\begin{pmatrix} -5 \\ -4 \end{pmatrix}$  (d)  $\begin{pmatrix} -16 \\ 12 \end{pmatrix}$

### Exercise 7.6

(Learner's book pages 132-133)

1. (a)  $\mathbf{OP} = \begin{pmatrix} 5 \\ 3 \end{pmatrix}$  (b)  $\mathbf{OQ} = \begin{pmatrix} 2 \\ 3 \end{pmatrix}$

(c)  $\mathbf{OR} = \begin{pmatrix} -6 \\ 8 \end{pmatrix}$  (d)  $\mathbf{OS} = \begin{pmatrix} -3 \\ -4 \end{pmatrix}$

(e)  $\mathbf{OT} = \begin{pmatrix} 0 \\ 2 \end{pmatrix}$  (f)  $\mathbf{OF} = \begin{pmatrix} -3 \\ 0 \end{pmatrix}$

2. (a) (1, 4) (b) (0, 3) (c) (-1, -3) (d) (-5, 0)

3. (a) C(2, 12) (b) C(10, -6)

4. (a) R(3, 7) (b) R(2, 3) (c) R(-2, -3)

5.  $\mathbf{OA} = \begin{pmatrix} 1 \\ 0 \end{pmatrix}$   $\mathbf{OB} = \begin{pmatrix} 3 \\ 4 \end{pmatrix}$

$\mathbf{OC} = \begin{pmatrix} 1.5 \\ 3 \end{pmatrix}$   $\mathbf{OD} = \begin{pmatrix} 2 \\ -3 \end{pmatrix}$

$\mathbf{OE} = \begin{pmatrix} 4 \\ -1 \end{pmatrix}$   $\mathbf{OF} = \begin{pmatrix} 0 \\ -2 \end{pmatrix}$

$\mathbf{OG} = \begin{pmatrix} -1 \\ -1 \end{pmatrix}$   $\mathbf{OH} = \begin{pmatrix} -2 \\ -3 \end{pmatrix}$

$\mathbf{OI} = \begin{pmatrix} -2 \\ 1 \end{pmatrix}$   $\mathbf{OJ} = \begin{pmatrix} -1.5 \\ 0 \end{pmatrix}$

$\mathbf{OK} = \begin{pmatrix} -1 \\ 4 \end{pmatrix}$

6.

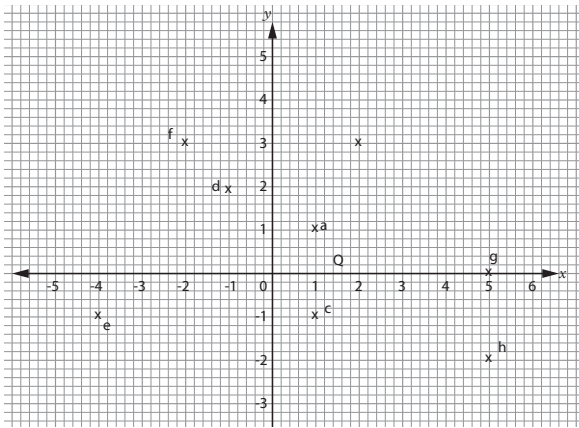

7. (a)  $\begin{pmatrix} -2 \\ -4 \end{pmatrix}$

(b) (i)  $\begin{pmatrix} 9 \\ 8 \end{pmatrix}$  (ii)  $\begin{pmatrix} -9 \\ -8 \end{pmatrix}$

(c)  $\mathbf{FG} = \begin{pmatrix} -4 \\ -12 \end{pmatrix}$   $\mathbf{GF} = \begin{pmatrix} 4 \\ 12 \end{pmatrix}$

(d) (i)  $\mathbf{MN} = \begin{pmatrix} 3 \\ -4 \end{pmatrix}$  (ii)  $\mathbf{MP} = \begin{pmatrix} -3 \\ -5 \end{pmatrix}$

(iii)  $\mathbf{NM} = \begin{pmatrix} -3 \\ 4 \end{pmatrix}$

8. (a)  $\mathbf{OB} = \begin{pmatrix} -1 \\ 6 \end{pmatrix}$   $\mathbf{OC} = \begin{pmatrix} 9 \\ 9 \end{pmatrix}$  (b)  $d = 6$

### Exercise 7.7

(Learner's book pages 134-135)

1. (a)  $\begin{pmatrix} 8 \\ 2 \end{pmatrix}$  (b)  $\begin{pmatrix} 9 \\ 6 \end{pmatrix}$  (c)  $\begin{pmatrix} 25 \\ 10 \end{pmatrix}$

(d)  $\begin{pmatrix} 6 \\ 5 \end{pmatrix}$  (e)  $\begin{pmatrix} 5 \\ -4 \end{pmatrix}$  (f)  $\begin{pmatrix} 21 \\ 9 \end{pmatrix}$

(g)  $\begin{pmatrix} 3.5 \\ 1.5 \end{pmatrix}$

2.  $\begin{pmatrix} 10 \\ 5 \end{pmatrix}$

3.  $k = 7$

4.  $k = 4, r = -3$

5. (a)  $\begin{pmatrix} 3 \\ 9 \end{pmatrix}$  (b)  $\begin{pmatrix} 3 \\ -17 \end{pmatrix}$  (c)  $\begin{pmatrix} 6\frac{1}{3} \\ 6 \end{pmatrix}$

6. (a)  $a = \begin{pmatrix} 1 \\ 3 \\ 8 \\ 3 \end{pmatrix}$  (b)  $\begin{pmatrix} -5 \\ 4 \\ -5 \\ 4 \end{pmatrix}$

### Exercise 7.8

(Learner's book pages 137-138)

1. (a)  $\begin{pmatrix} 9 \\ 10 \end{pmatrix}$  (b)  $\begin{pmatrix} 11 \\ 10 \end{pmatrix}$

(c)  $\begin{pmatrix} -3 \\ 3 \end{pmatrix}$  (d)  $\begin{pmatrix} 45 \\ -15 \end{pmatrix}$

(e)  $\sqrt{13}$  units (f)  $\sqrt{544}$  units

(g)  $\sqrt{85}$  units (h)  $26\sqrt{26}$  units

2. Midpoint  $\left(\frac{5}{2}, \frac{11}{2}\right)$ , distance  $\sqrt{10}$  units

3. (a)  $\sqrt{5}$  units (b) 5 units

(c)  $\sqrt{113}$  units (d) 5 units

4.  $k = \pm\frac{1}{\sqrt{2}}$

5. (a)  $\sqrt{557}$  units

(b)  $\sqrt{962}$

(c)  $2\sqrt{13} + 2\sqrt{74}$  units

6. (a)  $\sqrt{98}$  units (b)  $\sqrt{73}$  units

(c)  $\frac{\sqrt{117}}{\sqrt{65}}$  (d) 12

7. (a)  $\sqrt{10}$  units (b)  $\sqrt{40}$  units

(c) 6 units (d)  $\sqrt{65}$  units

8. (a) 5 units (b) 10 units

(c) 13 units (d)  $\sqrt{65}$  units

9. (a)  $\sqrt{41}$  units (b) 10 units (c)  $\sqrt{41}$  units

(d)  $\sqrt{58}$  units (e) 5b units (f)  $(\sqrt{53})m$  units

10. (a) is correct expression

## Unit 7 Test

(Learner's book pages 138-139)

1. (a)  $\begin{pmatrix} 6 \\ 2 \end{pmatrix}$  (b)  $\begin{pmatrix} 5 \\ 2 \end{pmatrix}$  (c)  $\begin{pmatrix} -20 \\ -25 \end{pmatrix}$  (d)  $\begin{pmatrix} 0 \\ 3 \end{pmatrix}$

(e)  $\begin{pmatrix} 8 \\ 8 \end{pmatrix}$  (f)  $\begin{pmatrix} 7 \\ 0 \end{pmatrix}$  (g)  $\begin{pmatrix} 1 \\ 3 \end{pmatrix}$  (h)  $\begin{pmatrix} 2 \\ 1 \end{pmatrix}$

2. (a) C(1,4) (b) C(8,18) (c) C(14,-6)

3. (a)  $\begin{pmatrix} 3 \\ 9 \end{pmatrix}$  (b)  $\begin{pmatrix} 3 \\ -17 \end{pmatrix}$  (c)  $\begin{pmatrix} 6.5 \\ 6.5 \end{pmatrix}$

4. (a) 4.47 (b) 3.16

(c) 10 (d) 8.06

5. (a) 3.33 (b) 23.02

(c) 9.49 (d) 11.66

6.  $a = -2$

7.  $y = \frac{-11}{6}$

8. (a)  $\mathbf{OP} = \mathbf{p} - \mathbf{r}$ ,  $\mathbf{OR} = \frac{1}{3}(\mathbf{p} - \mathbf{r})$

(b)  $\mathbf{OQ} = \frac{1}{3}\mathbf{p} + \frac{1}{3}\mathbf{r}$ ,  $Q = (4.67, 2)$

9. (a) (i)  $-\mathbf{a}$  (ii)  $-\mathbf{b}$  (iii)  $-\mathbf{c}$

(b) 4 units



# Geometry

## Unit 8

## PARALLEL AND ORTHOGONAL PROJECTIONS

Learner's Book pages 140-150 (12 Lessons)

### Key unit competence

By the end of this unit, the learner should be able to transform shapes under orthogonal or parallel projections.

### Content outline

8.1 Parallel projections

8.2 Orthogonal projection

Answers

### Learning objectives

#### Knowledge and understanding

- Identify an image of a figure under Parallel projection
- Identify an image of a figure under orthogonal projection

#### Skills

- Construct an image of an object or geometric shape under :
  - Parallel projection
  - Orthogonal projection.

#### Attitudes and values

- Show the importance of parallel and orthogonal projection in various situations while transforming shapes under parallel or orthogonal projection.

- Be accurate in construction of figures and their images under parallel or orthogonal projection
- Develop confidence in solving problems related to transformation of shapes under parallel or orthogonal projection.

#### Generic competences addresses in this unit

- Communication skills
- Critical thinking
- Problem solving
- Research/innovation
- Cooperation, interpersonal management and life skills.

#### Links to other subjects

- Technical drawing, scientific drawing.

## Cross cutting issues addressed in this unit

- Inclusive education
- Financial education
- Genocide studies
- Peace , gender and values
- Standardization of culture
- Comprehensive and sexuality education
- HIV and AIDS

## Assessment criteria

Make image of figures using parallel projections.

## Background Information

Parallel and orthogonal projection is a type of transformation in which objects are projected parallel to and orthogonal to a given line. This unit helps learners to see clearly image formation. This is visualized in the case of how shadows are projected parallel to the light rays. Learners will always find the lesson interesting because whatever is happening during the lesson is real and it is related to the daily life.

## Additional activity

### Introduction to the concept of parallel and orthogonal projection

This section is meant to assist you as a teacher to introduce parallel and orthogonal projection, therefore by the end of it, the learner should be able to:

- Identify and define parallel lines
- Use different methods of constructing parallel methods of constructing parallel lines i.e.

- (i) Ruler and set square
- (ii) Pair of compasses and a ruler

- State or list properties of parallel lines.

**Materials:** mathematical instruments

## Teaching/learning guidelines

- Organise learners into groups.
- Let learners draw parallel and perpendicular lines. Ask them to distinguish between the two. Let them list the properties of parallel lines.
- Ask them to discuss their results with other groups. Ensure that right procedure has been used.
- Ask the learners to present their findings in a class discussion.
- Help the class to summarize and list the properties of parallel lines.
  - (i) Parallel lines never meet.
  - (ii) The perpendicular distance between them is a constant.

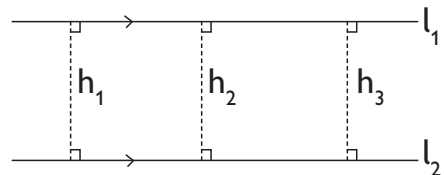

$h_1 = h_2 = h_3$ , the perpendicular distance between the parallel lines  $l_1$  and  $l_2$ .

- Remind the learners of other methods of constructing parallel lines using angles and protractor or pair of compasses and transversal
- Emphasise the importance of being accurate in constructing parallel lines because the learners will require skill in this unit.

## 8.1 Parallel projection

### 8.1.1 Introduction to parallel projection

By the end of this section, the learner should be able to draw parallel lines and determine the distance between two parallel lines.

**Materials:** a ruler, set square, pencil, protractors

#### Teaching guidelines 8.1.1

- Organise the class into pairs to do activity 8.1 in the learner's book page 140.
- Guide them through the activity to draw the parallel lines.
- Ask them to answer steps 5 and 6 in the activity.
- Let one member to record down all necessary points during the discussion which will be presented to the rest of the class during class discussion.
- Hold a class discussion and give change to the rest of the members to point out omissions and errors which arises during the presentation.
- Summarise their presentation by helping the learners to understand the accurate way of drawing parallel horizontal line. Emphasize that the same steps are used for vertical parallel lines.
- Use this chance to emphasize the key points and possibly correct any erroneous errors. Also use the chance to assess whether the objectives have been met.
- This activity will promote in the learner, leadership and organization skills.

### Answers to activity 8.1 page 140

Steps 1 to 4 are well illustrated in the activity 8.1 in the learner's book page 140.

In steps 5, the two parallel lines are as shown below. CD is the required line.



In step 6, the distance between parallel lines is defined as perpendicular distance.

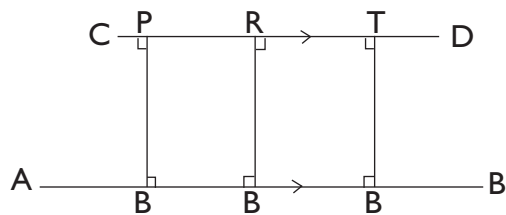

Thus PQ, RS, TU are examples of the distance between AB and CD.

$PQ = RS = TU$  and it will depend on how far apart the parallel lines are.

This is an appropriate time for you to show the learners how to draw a line parallel to another using a transversal or by copying an angle equal to a given one.

### 8.1.2 Parallel projection of a point on a line

By the end of this section, the learner should be able to:

- Define **parallel projection**.
- Find the image of a point under a projection in given line, in a given direction.
- Find the projection of a different points on a given line.

**Materials:** Geometrical instruments

#### Teaching/learning guidelines 8.1.2

- Organise learners to do activity 8.2, individually in learner's book page 141.

- Ensure that every learner is doing the right thing. This can be done by moving around the classroom and check whether they are doing what you expect them to do. Guide where necessary.
- Ensure that every learner has a class partner and that both partners are active and know what they are looking for. Make sure that the sources of information are available to the learners; lack of access to research materials will impair learning.
- When the activity is done, listen as different learners report their findings. Verify their findings and emphasize the key points
- Take the learners through the steps of projecting many different points on the same line and compare the ratios of the object lengths to the image lengths which lead you to Thales' theorem.
- Conclude the lesson by asking the learners to project as many points and line segments as possible on the same line and move round to correct erroneous errors encounter by the learners.
- This unit will promote communication skills, leadership skills, debating skills among other competences.

### Answers to Activity 8.2 in learner's book page 141

Guide the learners on how to draw lines through points A and B with line L as its transversal.

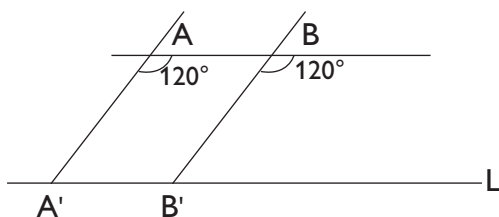

Through point A draw a line segment to meet L at A'.

Through A draw a line parallel to L.

Through B draw another line parallel to L.

At point B, copy an obtuse angle equal to the angle at A.

The angle at A can be copied to B using a pair of compasses or using a protractor as we have done.

Thus AA' is parallel to BB'

This procedure has guided us to draw a line parallel to a given one through a given point by copying appropriate and accurate angles.

Explain this procedure step by step and demonstrate on the board.

### 8.1.3 Parallel projection of a line on a line segment

By the end of the section, the learner should be able to project a line segment and be able to measure accurately the length of the image.

**Materials:** rulers, set squares, compass and research facilities.

#### Teaching guidelines 8.1.3

- Organise the learners in pairs to do task on figure 8.10 and figure 8.11 in the Learner's book page 142. Let this activity be done practically and let the learners record their findings.
- Discuss with learners on how the line AB in Fig. 8.10 is projected on line  $L_2$  that is; first, the point A to give image A' then point B to give B'.
- Conclude this section by giving more practical examples of parallel projection on a line segment.

- This section of the unit will promote among other competencies"
  - (i) Critical thinking skills
  - (ii) Problem solving
  - (iii) Cooperation and interrelation among learners

### 8.1.4 Properties of parallel projection

By the end of this section, the learner should be able to show and prove the various properties of parallel projection by construction.

**Materials:** ruler, compass, set square divider

#### Teaching guidelines 8.1.4

- Organise the learners in pairs to do activity 8.3 in learner's book page 141 -142. Use figure 8.11 in this activity to prove all the properties of parallel projections.
- Ask learners to prove the properties. Take this chance to tour the class and help those who may need help.
- When the learners have finished their constructions. You need to guide them to discover the property related to each construction and state the property.
- Help the learners to identify all the properties of parallel projections; the ratios, angles, projection and direction lines.
- Now, guide the learners through the discussion of the properties of parallel projection highlighted in the learner's book page 143.
- The activity will promote research skills, leadership skills and self-confidence among other competences.

### Answers to activity 8.3 learner's book pages 142-143

1. (a)  $AB = 1.8$  cm  
(b)  $A'B' = 1.8$  cm; They are equal
2.  $AA' = 1.9$  cm (b)  $B'B' = 1.9$  cm;  
They are equal
3. (a)  $\frac{AB}{A'B'} = \frac{1.8}{1.8} = 1$   
(b)  $\frac{A'A'}{B'B'} = \frac{1.9}{1.9} = 1$
4. (a)  $\angle AA'B' = 70^\circ$   
(b)  $\angle BB'O = 70^\circ$   
(c)  $\angle$ Interior angles at A and B' are also equal to  $110^\circ$ . Sum of the interior angles =  $360^\circ$

### 8.1.4 Parallel projection of geometrical figures on a line

By the end of this section, the learner should be able to:

- Project a geometric figure on a given line of projection.
- Find the image of geometrical figures on a given line of projection in a given direction.

**Materials:** mathematical instruments

#### Teaching/learning guidelines 8.1.4

- Organise learners in pairs to do activity 8.4 on page 143-144.
- Ensure that every learner is doing the right thing by moving around the classroom and check what they are doing. Guide where necessary.
- Ask the learners to present their findings in a class discussion.
- Emphasize that the angle between  $L_1$  and  $L_2$  must be as indicated i.e. acute angle at point O is  $40^\circ$  as shown.
- Discuss the triangle ABC and its image  $A'B'C'$  emphasizing the reason why the image is a line segment rather than another triangle.

- Help the learners to confirm that this is really a parallel projection i.e. the relationship between line segments  $AA'$ ,  $BB'$ ,  $L_2$ . Compare also angles of  $AA'B'$ ,  $BB'O$ ,  $CC'O$ .
- Create simple cases of examples the learners to practice constructions of parallel projections. Such examples may include finding images of points and line segments in different directions i.e

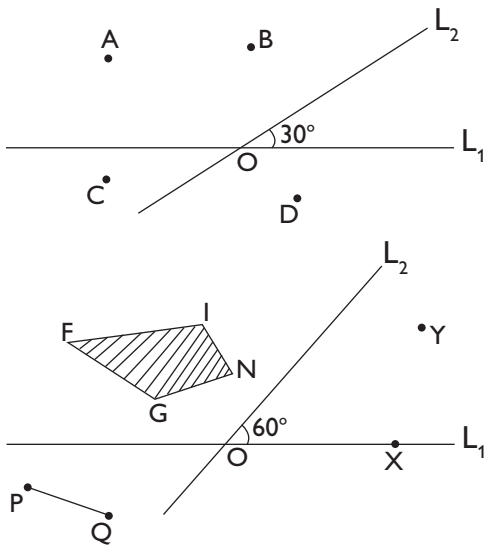

- Formulate questions based on these lines and such examples.
- Ask learners to do exercise 8.1 in the learner's book pages 144-145.

### Answers to activity 8.4 learner's book pages 143-144

To find parallel projection of a point, a line segment or a geometric figure, the following are the requirements:

- 1) The line of projection.
- 2) The direction of the projection.
- 3) The object to be projected.

A point projects onto a point, a line segment onto a line segment and a geometric figure on a line segment.

This applies to projection in two dimensions.

The image of  $\angle ABC$  is line segment  $A'B'C'$ .

## 8.2 Orthogonal projection

### 8.2.1 Introduction to orthogonal projection

By the end of this section, the learner should be able to draw perpendicular line and define orthogonal projection with ease.

**Materials:** rulers, compass, pencil, protractor

### Teaching / learning guidelines 8.2.1

- Organise learners in pairs to do activity 8.5 in learner's book page 145.
- Ensure that every learner is doing the right thing by moving around the classroom to see what they are doing. Guide them where necessary.
- Ask the learners to compare their constructions with other member's work as they summarize their activity.
- Help learners to define orthogonal projection that is orthogonal projection is the type of projection where the line of projection and the line giving the direction meet at  $90^\circ$ . This will help them appreciate the development of construction of parallel lines learnt earlier in the unit.
- Point out to the learners that orthogonal projection is also a parallel projection i.e. orthogonal projection is subset of parallel projection. The direction determines the name.

- This part of the unit will promote in learners among other competencies:
  - (i) Problem solving skills
  - (ii) Cooperation and interrelation
  - (iii) Critical thinking
  - (iv) Communication skills

### Answers to activity 8.5 learner's book pages 145-146

Ensure that learners can construct a line perpendicular to a given one through a given point.

Demonstrate this activity on the board. Verify that the construction is correct by measuring the angles at the point of intersection. In this activity,

$$\angle PP'A = \angle PP'B = 90^\circ$$

### 8.2.2 Orthogonal projection of a line on a line

By the end of this section, the learner should be able to understand the orthogonal projection of a line on a line and solving any task given on orthogonal projection of a line on a line with ease.

**Materials:** Mathematical instruments

#### Teaching/learning guidelines 8.2.2

- Organise learners into appropriate pairs. Ensure that you observe gender balance in case of a mixed class.
- Ask learners to do activity 8.6 in the learner's book pages 146-147.
- Guide the learners through the steps of the activity. Emphasize on how to construct a perpendicular lines through points P and Q of line PQ.

- Allow them to discuss their construction with other classmates.
- Let them report their findings to the whole class.
- Hold the whole class discussion and use the opportunity to correct any errors in the learner's findings.
- Summarise the discussion by pointing out that PQ is the orthogonal projection of PQ on the line AB.
- This section of the unit will promote in learners among other competencies:
  - (i) Communication skills
  - (ii) Problem solving skills
  - (iii) Cooperation and interrelationship

### Answers to activity 8.6 learner's book pages 146-147

Using P as centre and a suitable radius draw an arc to meet AB at R and S. With R and S as centres and same radius, draw another pair of arcs to meet at a point. Join P to X to meet AB at P' as shown in the following figure.

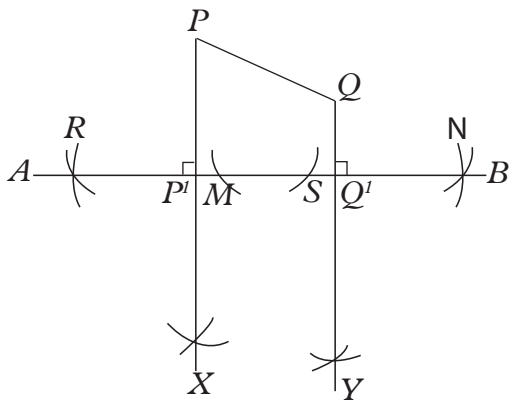

Using Q as centre and another radius, draw an arc to meet AB at points M and N. With M and N as centres and same

radius, draw another pair of arcs to meet at point Y.

Join Q to Y to meet AB at Q'

P' and Q' are the orthogonal projections of P and Q respectively on line AB.

### 8.2.3. Orthogonal projection of geometrical figure on a line

By the end of this section, the learner should be able to find the image of any point, line segment and shape on a line.

**Materials:** mathematical instruments

#### Teaching/learning guidelines 8.2.3

- Organize learners to do activity 8.7 on page 147 in the learner's book individually.
- Move around the classroom to ensure that every learner is doing the right thing. Guide them where necessary.
- Let the learners hold a discussion to discover that the images of the points A, B, C, D are found by the accurate construction of perpendicular line segment to line  $L_1$ .
- Emphasize on the correct use of ruler and compass in this activity if need be, do a chalkboard illustration on the same.
- Allow the learner to compare their constructions with those other members of the class. You could use this opportunity to demonstrate on board.
- Help learners to identify and list the properties of orthogonal projection that is:

1. The projection meets the line of projection at  $90^\circ$ .
2. Preserves ratios of corresponding line segments and ratio of corresponding projections.
3. Preserves the distance between line segments and pairs of corresponding points.
  - Ensure that the learners understand the properties because they will use them in doing the exercise that follows.
  - Ask them to do exercise 8.2 on pages 147-148.
  - Take them through the unit summary and ask them to do unit 8 test as homework, mark the homework to determine the area of weakness of your learners and guide them appropriately.
  - This part of the unit will promote in learners among other competencies:
    - (i) Communication skills
    - (ii) Problem solving skills
    - (iii) Leadership and organisation.

#### Answers to activity 8.7 learner's book page 147

Drop perpendiculars from each of points A, B, C, D to  $L_1$  to locate the images A'B', C', D' of A, B, C, D respectively. (see the following figure).

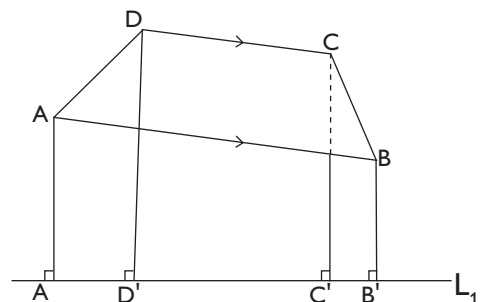

A'B'C'D' is a line segment on L.



No properties of the trapezium have been preserved.

Emphasize the fact that the perpendiculars from A, B, C, D can be drawn using a set square or pair of compasses.

## Answers

### Exercise 8.1

(Learner's book pages 144-145)

1. (d) You should have noticed that

$$BC' = C'D' = D'E' = E'A' = 3 \text{ cm}$$

(e) (ii)  $\frac{BC}{BC'} = \frac{CD}{C'D'} = \frac{DE}{D'E'} = \frac{EF}{E'A'} = 1$

- (f) Under this projection the image of F is A

2. (c) AA'B'B is a trapezium in which AA' // BB'

(d)  $\angle AA'B' = 60^\circ$   
 $\angle A'B'B = 120^\circ$

These angles could be calculated using properties of parallel lines and a transversal

3. (d) PABQ is a quadrilateral

(e) PA = QB, AB = PQ  
 PA // QB, AB // PQ  
 $\angle PQB = \angle PAB$ ,  
 $\angle APQ = \angle ABQ$   
 $\therefore$  PABQ is a parallelogram

4.

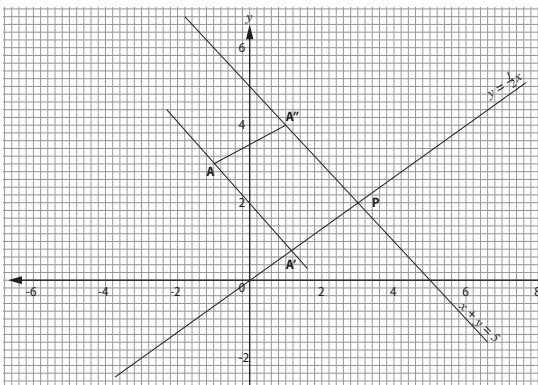

- (e) P(3.3, 1.7) A'(1, 4) A''(1.3, 0.7)

AA'PA'' is a parallelogram

Thus AA' // A''P

AA'' // A'P

$\angle A'AA'' = \angle A'PA''$  and

$\angle AA'P = \angle AA''P$

5. (a) A'(4, 0), B'(2, 0), C'(5, 0)  
 (b) A''(0, 4), B''(0, 2) C''(0, 5)

### Exercise 8.2

(Learner's book pages 147-149)

1. (a)

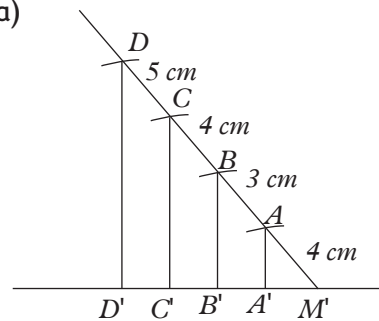

- (c) (i) 0.5 (ii) 0.5 (iii) 0.5  
 (iv) 0.5 (v) 0.5 (vi) 0.5  
 (viii) 0.5

- (d) All ratios are equal

2. (a) A'(3, 0), B'(5, 0), C'(8, 0)

- (b) (i) 2 units (ii) 3 units  
 (iii) 5 units

3. 6.6 cm

4. (a)  $54^\circ$  (b) 12 cm

5. (a) P'(3, 3), Q'(5.5, 5.5), R'(5, 5), S'(2, 2)

- (b) P''(-2, 2), Q''(0, 0), R''(-0.5, 0.5)  
 S''(0, 0)

## Unit Test 8

(Learner's book page 149)

1. 5.7 cm

2. (c) 5.3 cm

4. (c) 10 cm (f) 1 : 2

# Geometry

## Unit 9

## ISOMETRIES

Student's Book pages 151-179 (30 Lessons)

### Key unit competence

By the end of this unit, the learner should be able to transform shapes using congruence (central symmetry, reflection, translation and rotation).

### Content outline

- 9.1 Introduction to isometries
- 9.2 Central symmetry
- 9.3 Reflection
- 9.4 Rotation
- 9.5 Translation
- 9.6 Composite transformations

### Answers

### Learning objectives

### Knowledge and understanding

- Identify an image of a figure under:
  - Central symmetry
  - Reflection
  - Rotation

### Skills

- Construct the image of a point, a segment, a geometric shape, under:
  - Central symmetry
  - Reflection
  - Translation
  - Rotation
- Find the coordinates of image of an object under:

- Central symmetry
- Reflection
- Translation
- Rotation

### Attitudes and values

- Appreciate that translation, rotation and reflection play important role in various situations.
- Develop team work spirit
- Develop confidence in construction of the image of a point, a segment, a geometric shape under any isometry
- Develop accuracy in constructing shapes under isometries

### Generic competences addresses

#### in this unit

- Communication skills
- Critical thinking
- Problem solving
- Research/innovation
- Cooperation, interpersonal management and life skills.

## Links to other subjects

- Physics, ICT, Engineering, technical drawing, scientific drawing,...

## Cross cutting issues addressed in this unit

- Inclusive education
- Financial education
- Genocide studies
- Peace, gender and values
- Standardization of culture
- Comprehensive and sexuality education
- Hiv and aids

Transform shapes using congruence (central symmetry, reflection, translation and rotation).

## Background Information

Isometrics is the ninth unit of the book. The unit is one of the key units of the book where learners learn about translation of figures and drawings and have they can pick a lot of interest to study mathematics. The unit has a lot of application in real life situation as the learners get opportunity to learn about rotation. The provided activities will help the learners visualize the concept of reflection, symmetry and translation which we use in our daily activities.

### 9.1 Introduction

By the end of this section learners should be able to:

- Define the term isometries
- Identify the four types of isometries in this section.
- Construct the image of geometric shapes under each of the four isometries.
- Describe each of the four isometries fully.

## Materials

- Dictionary or access to internet.

## Teaching guidelines 9.1

- Organize the learners so that they can do Activity 9.1 in learner's book on page 151 individually.
- Ask the class to do Activity 9.1 in the learner's book on page 151.
- Move round the class as they work so that you are able to assist them where need be.
- Identify a few learners to present their findings in a class discussion.
- Now summarise the class findings by improving their definition of;
  - i) Transformation
  - ii) Isometry
  - iii) Distinguish between transformation and isometry.

## Answers to activity 9.1 learner's book page 151

1. (i) Transformation in geometry, transformation refers to the movement of an object in the plane. Some transformations preserve **shape** and **size**. Others change shape and size.
  - (ii) Isometry is a transformation that preserves both shape and size. Examples of isometrics include **translation**, **rotation**, **reflection** and **central symmetry**.

### 9.2 Central Symmetry

By the end of this section the learner should be able to explain the meaning of central symmetry and solve problems involving central symmetry.

## Materials

- Geometrical instruments

## Teaching/learning guidelines 9.2

- Organize the learners into groups that comprise learners of different gender and abilities.
- Let every group select a group leader/ secretary who will be noting down and presenting to class the discussed points.
- Ask the learners to do Activity 9.2 in the learners book on page 151.
- Let the group leaders present the findings to the whole class as other class members point out omissions, ask questions and contribute to the discussion. Emphasize that **isometry** defines transformation with respect to distance and has got four examples that includes central symmetry, reflection, translation, and rotation.
- As the groups present their findings in a class discussion, encourage the learners to fully participate in the discussion.
- Summarise the class findings comparing both object and image with reference to the shape, size, orientation and areas.
- Emphasize on the properties of central symmetry and the definition of the transformation.
  1. An object and its image have same shape and size.
  2. A point on the object and a corresponding point on the image are equidistant from the centre.

3. The image of the object is inverted.
4. Central symmetry is fully defined if the object and the centre are known.

- Ensure that the key concepts and facts are well summarized by all the learners.
- Working with the whole class, take the learners through example 9.1 in their book.
- Ask class to do exercise 9.1 on page 152 – 154 in learners book individually.

## Answers to activity 9.2 learner's book page 151

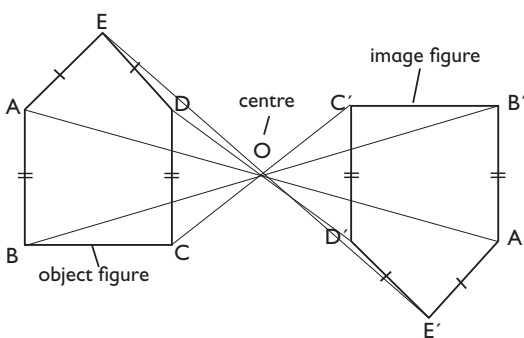

In this figure,  $A'B'C'D'E'$  is the image of  $ABCDE$  under a transformation called central symmetry, centre  $O$ .

- Both shape and size are preserved.
- Any object point, corresponding image point and the centre are called collinear.
- Any object point and corresponding image point are equidistant from the centre.
- $ABCDE$  and  $A'B'C'D'E'$  face opposite directions.

## 9.3 Reflection

By the end of this section, the learner should be able to:

- Define reflection as a transformation.
- Find image of a given figure under a specific reflection.
- Given object and image construct a mirror line.
- State the properties of reflection.
- Perform reflection on the Cartesian plane.

### Learning materials

- Full length mirror.
- Graph books.
- Geometrical instruments.

### Teaching /learning guidelines

- Organize class into groups to do activity 9.3 on page 154 individually.
- Ask the groups to report their findings in a class discussion illustrating their discussion on the board.
- Be alert to ensure that the groups develop correct concepts and summarise them properly.
- Help the learners to come up with properties of reflection in connection to object, image and mirror line.
- Take class through examples 9.2 on page 155 in learners book.
- Ask class to do exercise 9.2 on page 155 – 156 in learners book.

## 9.4 Reflection on the Cartesian plane

By the end of this section, the learner should be able to;

- Find image of an object under reflection in;
  - a) x-axis ( $y = 0$ )
  - b) y-axis ( $x = 0$ )

### Materials

- Square chalkboard
- Coloured chalk
- Graph book or paper.
- Mathematical instruments.

### Answers to activity 9.3 learner's book page 154

1. Left
2. Both are equal in height.
3. Same distance i.e. 3 m
4. The image appears to be walking towards the object

$ON = ON'$

All the angles at point O are equal to  $90^\circ$

Both object and image face opposite direction

### Teaching /learning guidelines 9.4

- Organize the learners into groups.
- Ask them to do activity 9.4 on page 156.
- Ensure that every learner has the required materials and that they are participating in the activity actively.
- Ask the learners to present their findings in a class discussion, demonstrate their presentations on the board.
- Help the learners summarise the properties discovered in this activity.
- Guide the learner through examples 9.3 on page 156 – 157.
- Ask learners to do exercise 9.3 on page 158 – 159 Q1(a), (b), (c), Q2. (a)(i) and (b) (ii).

- In a class discussion, help the learners to identify lines  $x=k$  and  $y = c$  where  $c$  and  $k$  are constants. Then take them through examples 9.4 including the note after the example on page 157 in learners book.
- Ask learners to exercise 9.3; 2.(c) (ii), d (i) and (ii) on page 158 – 159.
- Help class to identify lines  $x = y$  and  $y = -x$ . Take class through example 9.5 including the note after the example and example 9.6 on page 157 – 158.
- Ask class to do exercise 9.3 (i) b and d, (2) a (ii), b (i) on page 158 – 159.

### Answers to activity 9.4 learner's book page 156

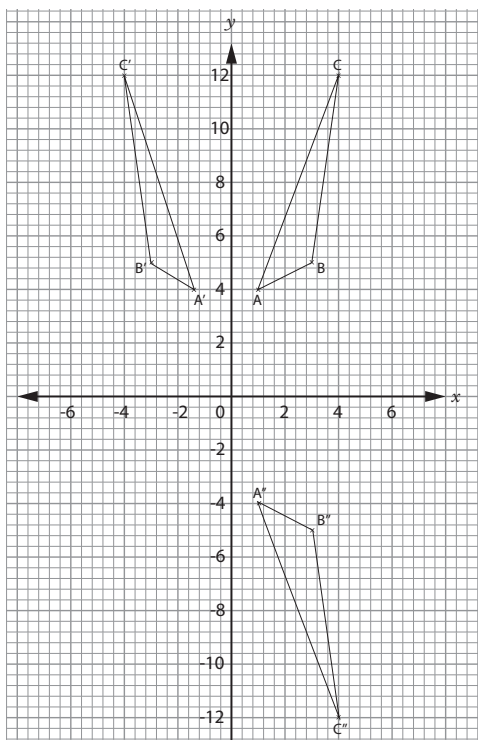

- Object and image are equidistant from the mirror line.
- Under reflection, shape and size have been preserved.

## 9.5 Rotation

By the end of this section the learner should be able to:

- Identify a rotation
- Describe a rotation fully.
- Find the image of an object under a given rotation by construction.
- Find the (i) centre and (ii) the angle of rotation given object and its image.
- List the properties of a rotation.

### Materials

- Geometrical instrument

### Teaching /learning guidelines 9.5

- Organize the learners in pairs.
- Ask the learners to do Activity 9.5 on page 159.
- Ask the learners to summarise their findings and report them in a class discussion.
- As they report, encourage them to illustrate their activity on the board.
- Help the learners to emphasize on the key concepts and facts i.e centre of rotation and angle of rotation.
- List the properties of rotation according to the activity 9.5.
- Ensure that the learners are able to identify the centre and the angle of rotation.

### Answers to activity 9.5 learner's book page 159

- OA and OB have turned through  $90^\circ$
- Point O has remained in the same position.

- Yes corresponding angles are equal
- The above properties have remained the same.

### 9.5.1 Direction of Rotation

By the end of this section, the learner should be able to:

- Identify clockwise and anticlockwise turn relating them to negative and positive rotations respectively.
- Use a guideline to construct the image of an object under a given rotation.
- Compare and contrast the object and its image under a rotation.
- Find the central and the angle of rotation given object and its image.

### Materials

- Mathematical instruments

### Teaching /learning guidelines

#### 9.5.1

- Organize the learners to work in pairs to do activities 9.6 and 9.7, doing one activity at a time on pages 159 – 160.
- Move round the classroom to ensure that all learners participate actively.
- Ask the learners to summarize their findings and present them in a class discussion.
- Ensure that the learners are able to answer all the questions in the activities and explain the properties of rotation.
- Describe the congruence between an object and its image from activities 9.5 and 9.8.

### Answers to activity 9.6 learner's book page 159

As in activity 9.5

- OB has turned through the same angle as OA. This can be verified by measuring angles AOA' and BOB'.
- The centre of rotation, O, has remained fixed. The centre of rotation is always invariant.
- The angle between AB and A'B' is equal to the angle of rotation i.e.  $60^\circ$ .
- The shape and size have been preserved.

### Answers to activity 9.7 learner's book page 160

- The angle between a line and its image is  $90^\circ$
- Every point in the object turns through the same angle in the same direction.
- $OB = OB'$ ;  $OC = OC'$
- The positive angle equivalent to a rotation of  $-90^\circ$  is  $270^\circ$
- A rotation of  $-150^\circ$  is equivalent to a positive rotation of  $(360 - 150) = 210^\circ$
- A rotation of  $320^\circ$  is equivalent to a rotation of  $-40^\circ$

### Answers to activity 9.8 learner's book page 161

- From activities 9.5 to 9.7 learned before.
- An object and corresponding images, the corresponding angles are equal.
- The lengths of corresponding lengths are equal.

- Object and image face a direction determined by the angle of rotation. The orientation is determined by the angle of rotation.

## 9.6 Locating an image given the object, Centre and angle of rotation

By the end of this section a learner should be able to:-

- Construct the image of an object, centre and angle.
- Describe the congruency of both the object and its image.

### Materials

- Mathematical instruments

### Teaching /learning guidelines 9.6

- Organize learners to work in pairs.
- Ask learners to do activity 9.9 on page 161.
- Let the each group discuss the outcomes of the activity among themselves.
- Ask them to present their findings in a class discussion.
- Help the class to sumamrise their findings and draw the conclusions emphasizing on the right concepts and facts.
- Now take learners through example 9.7 on pages 161 – 162.
- Ask the learners to do exercise 9.4 question 1 on pages 165 – 164.

### Answers to activity 9.9 learner's book page 161

We identify the midpoint of AB by constructing the perpendicular bisector of AB.

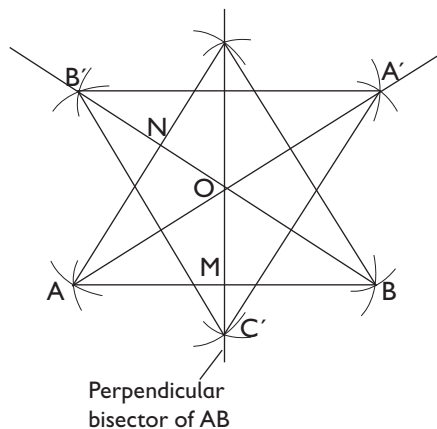

$\triangle ABC$  and  $A'B'C'$  are directly congruent

### 9.6.1 Finding the centre and angle of rotation

By the end of this section, the learner should be able to;

- Construct perpendicular bisector of a line segment, leading to locating the centre of rotation.
- Identify corresponding points in a rotation.
- Locate centre of rotation.
- Identify the angle of rotation.
- Measure the angle of rotation distinguishing between positive and negative angle.

### Materials

- Geometrical instruments

### Teaching /learning guidelines 9.6.1

- Organize learners to work in pairs.
- Ask the learners to do the activity 9.10 in learners book on page 162.
- Let the groups present their findings in a class discussion.
- Help learners to sumamrise the outcome of the activity, emphasizing all the properties of rotation with regard to this activity.



- Take the class through examples 9.8 on page 163.
- Ask learners to do exercise 9.4 on pages 163-164 questions (2) and (3).

### Answer to activity 9.10 learner's book page 162

- Corresponding line segments are equal.
- $\angle AOA' = \angle BOB' = \angle COC'$
- Point O is the centre of rotation that maps  $\triangle ABC$  onto  $\triangle A'B'C'$
- $\angle s AOA', BOB'$  and  $COC'$  represent the angle of rotation that maps  $\triangle ABC$  onto  $\triangle A'B'C'$ .

### 9.6.2 Rotation in the cartesian plane

By the end of this section, the learner should be able to:

- Plot points on the Cartesian plane.
- Locate centre of rotation, identify and measure angle of rotation.
- Find image point given, object point and vice versa.

#### Teaching /learning guidelines 9.6.2

- Prepare the learners for a class discussion using activity 9.11 on page 164.
- Copy fig. 9.28 on pages 164 – 165 on the board.
- Do this activity as a class discussion. After every part of the activity summarise the findings, ensuring that the whole class is with you.
- Use the same method to do activity 9.12 on page 165. Summarize and generalise the results where possible.

- Now take class through examples 9.9 on pages 165 – 166.
- Ask learners to do exercise 9.5 on page 167 in learners book.

### Answers to activity 9.11 learner's book pages 164-165

1.  $\triangle ABC \Rightarrow \triangle A'B'C'$   
Rotation  $90^\circ$ , centre (0, 0)  
B(3, 2) A'(-3, 1) C'(-1, 2) P'(-b)
2.  $\triangle ABC \Rightarrow \triangle A''B''C''$   
Rotation,  $-90^\circ$  centre (0, 0)  
C(2, 1) A''(3, -1) B''(2, -3) P''(b, -a)
3.  $\triangle ABC \Rightarrow \triangle A'''B'''C'''$   
Rotation  $180^\circ$  centre (0, 0)  
B'''(-3, -2) C'''(-2, -1) P'''(-a, -b)

### Answers to activity 9.12 learner's book page 165

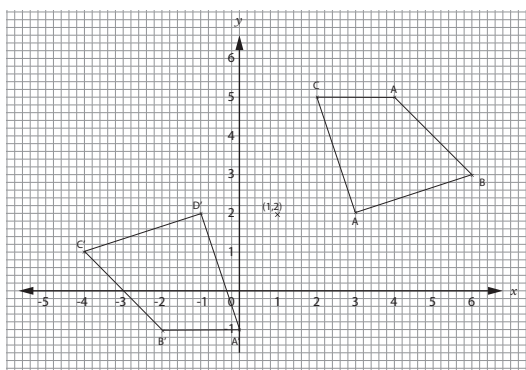

### 9.7 Translation

By the end of this section, the learner should be able to define translation, perform operations and construction on translation, and give characteristics and properties of a figure that has been translated. Identify translation vector.

### Teaching/learning guideline 9.7

- Organize the class in pairs based on their sitting arrangements.
- In pairs, ask them to do activity 9.13 and 9.14 on page 168 in the learners book.
- Let them report to the class what they can observe about the two triangles. Each point on triangle ABC move the same distance and same direction to triangle A'B'C'.
- Summarize this activity by letting the learners know about direct congruency and the factors used in define or stating translation.
- Emphasize the vector notations  $\mathbf{AA}'$
- Let the learners do exercise 9.6 on page 169 in the learners book.

### Answers to activity 9.13 learner's book page 168

- A and C coincide with A' and C' respectively
  - $\Delta s$  ABC and A'B'C' coincide
- Therefore the two triangles are congruent.

### Answers to activity 9.14 learner's book page 168

- $ABCD \Rightarrow A,B,C,D$  by translation equivalent to  $\mathbf{BB}$  in the direction  $\mathbf{BB}$ .
- $ABCD \Rightarrow A_2B_2C_2D_2$  by translation equivalent to  $\mathbf{BB}_2$  in the direction  $\mathbf{BB}_2$ .

Emphasize the fact that  $\mathbf{AA}_1$ ,  $\mathbf{BB}_1$  or  $\mathbf{CC}_1$  or  $\mathbf{DD}_1$  and that the vectors  $\mathbf{AA}_1$ ,  $\mathbf{BB}_1$ , or  $\mathbf{CC}_1$  or  $\mathbf{DD}_1$ .

- Similarly the second translation could be described by any of the distances  $\mathbf{AA}_2$ ,  $\mathbf{BB}_2$ ,  $\mathbf{CC}_2$ . Also, the translation vector could be any of the vectors  $\mathbf{AA}_1$ ,  $\mathbf{BB}_1$ ,  $\mathbf{CC}_1$  or  $\mathbf{DD}_1$ .

### 9.7 Translation in the Cartesian plane

By the end of this section, the learner should be able to;

- Determine the translation vector that maps an objects to its image.
- Describe a translation in terms of displacement vector.

### Teaching/learning guideline 9.7

- Organize the learners in pairs
- Let the learners do activity 9.15 on page 169 – 170 in the learners book.
- Ensure that learners can define a translation in terms of displacement vector i.e.stating the distances moved in the  $x$  followed by  $y$  directions and an object point.
- Help learners summarize the properties of translation. Emphasize the congruency between object and its image under a translation.
- Take learners through examples 9.11 to 9.15 on page 170 – 173.
- Now asks class to do exercise 9.7 on page 173.

### Answers to activity learner's book 9.15 page 169-170

$\Delta ABC \Rightarrow \Delta PQR$  by a translation, equivalent to column vector  $\begin{pmatrix} 4 \\ 2 \end{pmatrix}$ .

## 9.8 Composite Transformations

By the end of this section, learners should be able to;

- Perform successive transformations on the Cartesian plane.

### Teaching /learning guidelines 9.8

- Organize class so that they can work on activity 9.16 on page 174 individually.
- Explain clearly the meaning of composite transformations.
- Move round the classroom so that you are able to see that they are doing the activity properly.
- Ensure that they understand fully the statement similar to T followed by R followed M? Where T, R and M represent distinct transformations.
- Ask learners to summarise their findings and invite the groups to present their observations in a class discussion.
- Ensure that the presentations is done on the board so that all can see and follow the argument.
- Now take class through examples 9.16 on pages 174 – 176.
- Ask class to do exercise 9.8 on pages 176 – 177 in learners book.
- Take them through the unit summary and ask them to do unit test 9.

## Answers to activity 9.16

learner's book page 174

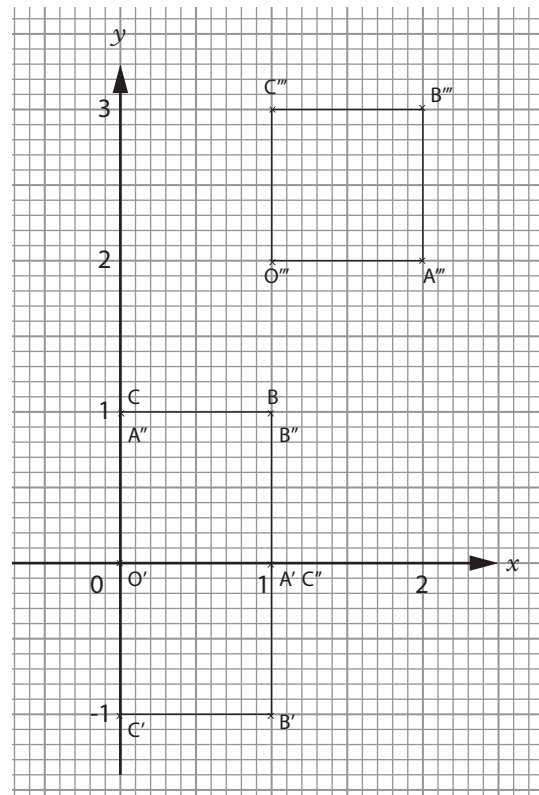

$A'' (2, 2)$

$B'' (2, 3)$

$C'' (1, 3)$

$O'' (1, 2)$

$A' (1, 0) B' (1, -1)$

$C' (0, -1) O' (0, 0)$

$A''' (0, 1) B''' (1, 1)$

$C''' (1, 0) O''' (0, 0)$

# Answers

## Exercise 9.1

(Learner's book page 152-154)

1.

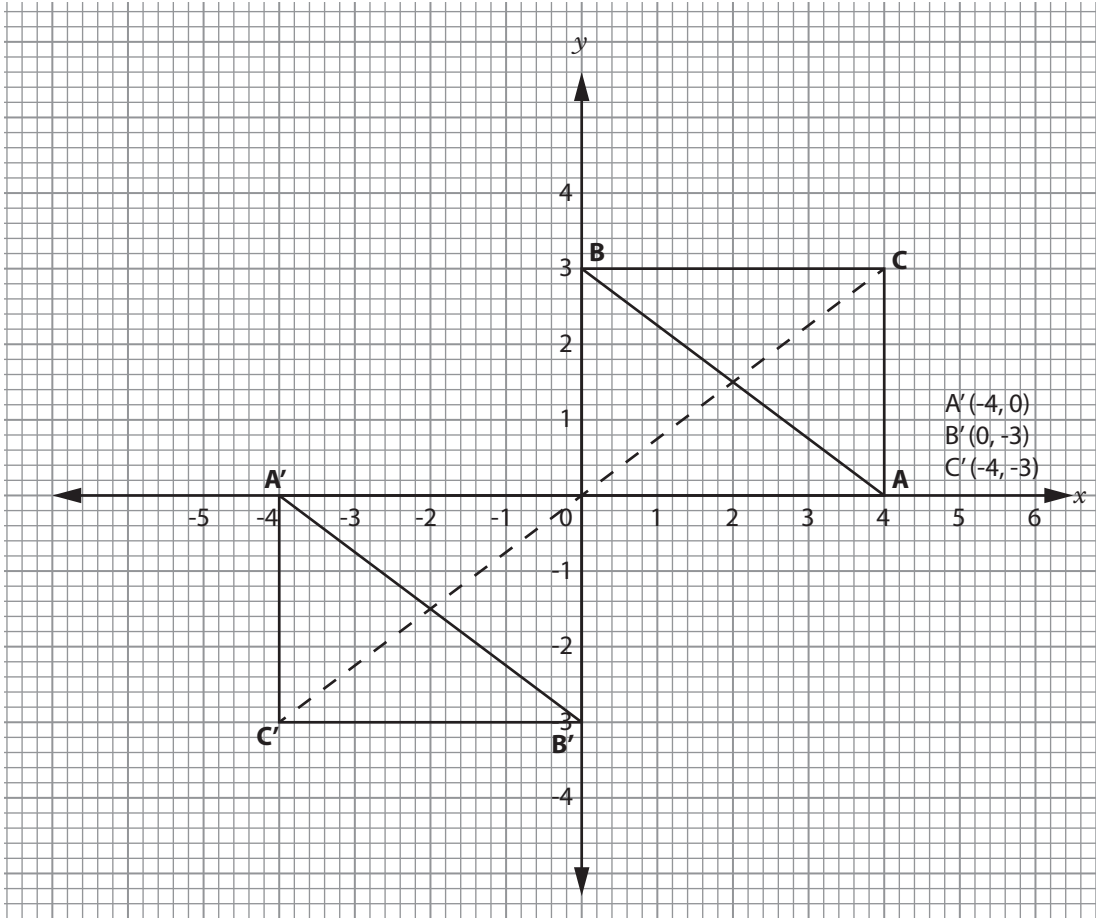

2.

The transformation is a central symmetry centre  $(-1, -1)$

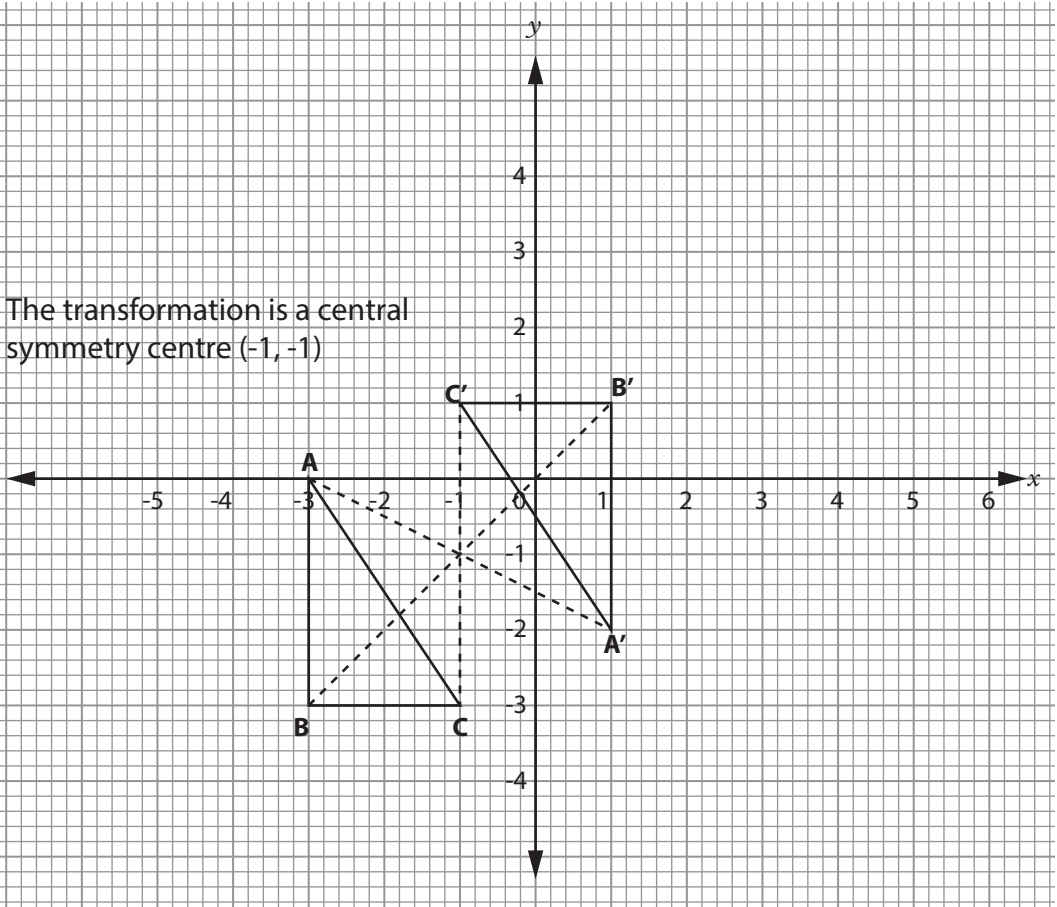

3.

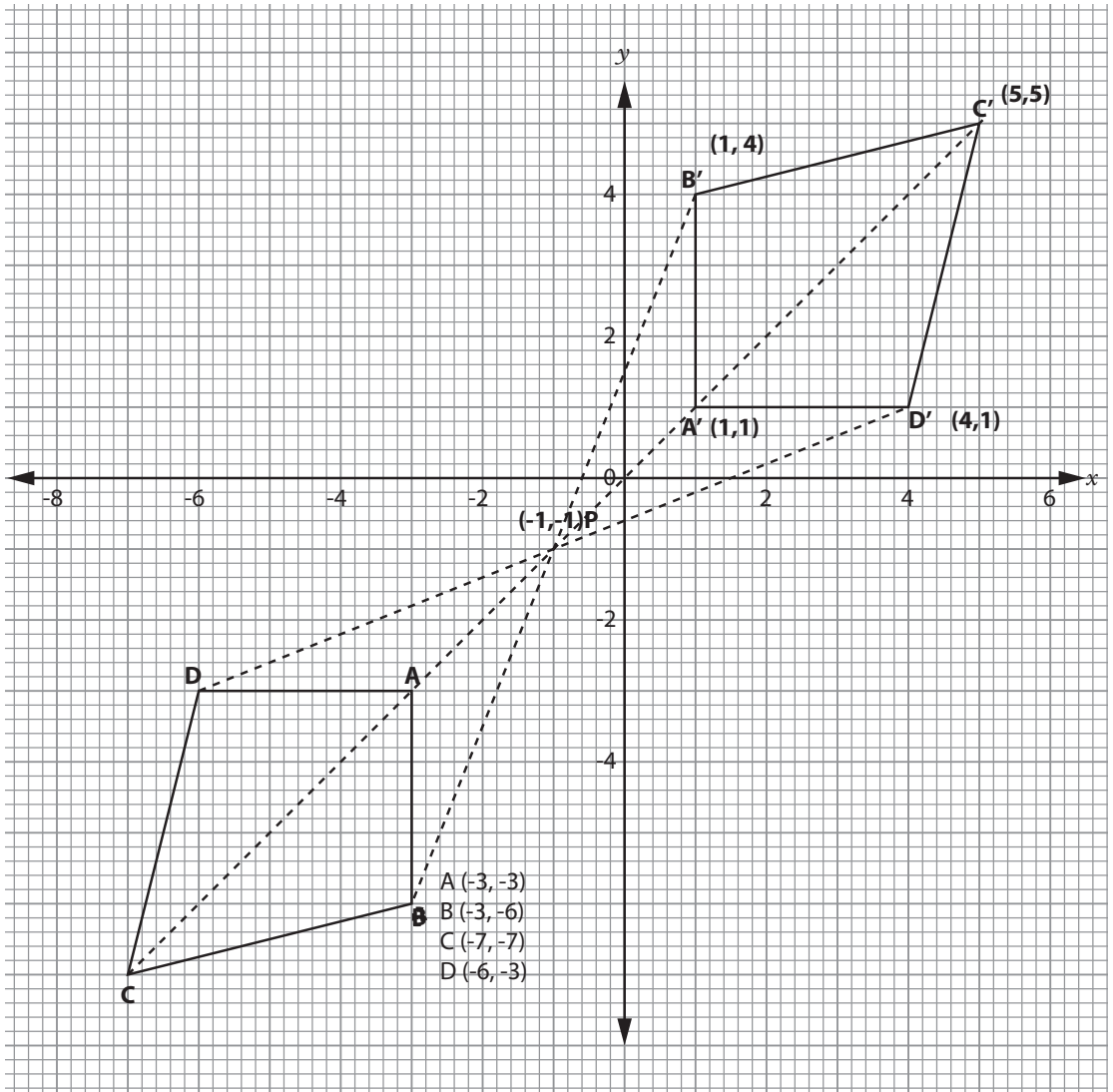

4.

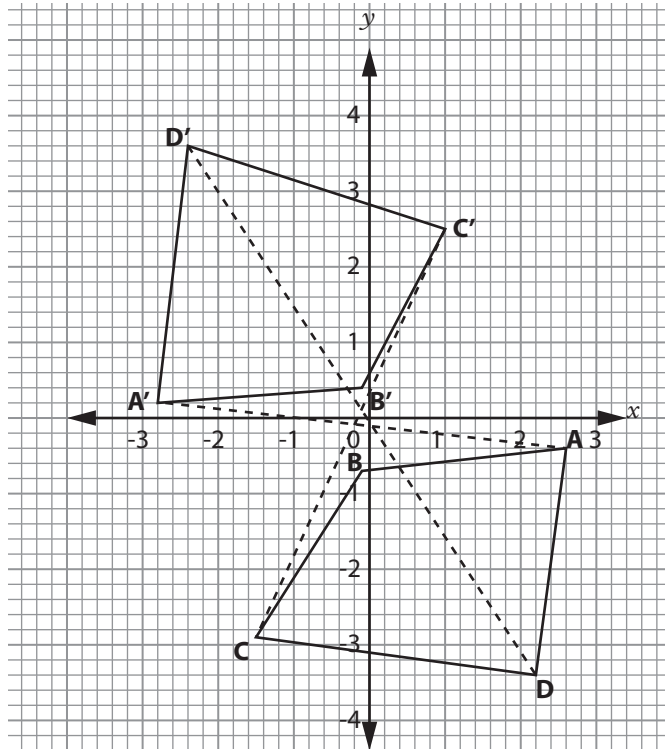

- (a)  $OA \equiv OA' = 2.6 \text{ cm}$   
 $OB \equiv OB' = 0.6 \text{ cm}$   
 $OC \equiv OC' = 2.8 \text{ cm}$   
 $OD \equiv OD' = 4 \text{ cm}$
- (b) (i)  $\angle AOA' = 180^\circ$   
(ii)  $\angle BOB' = 180^\circ$   
(iii)  $\angle COC' = 180^\circ$

5.

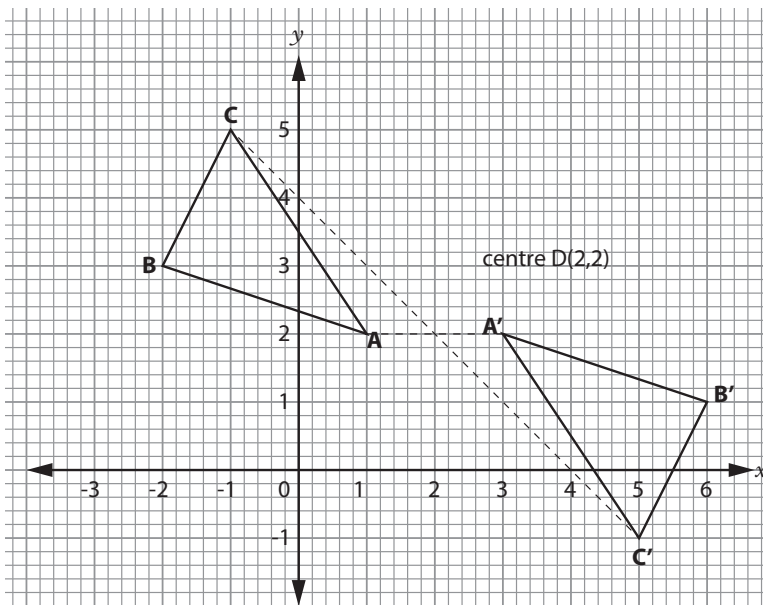

6.

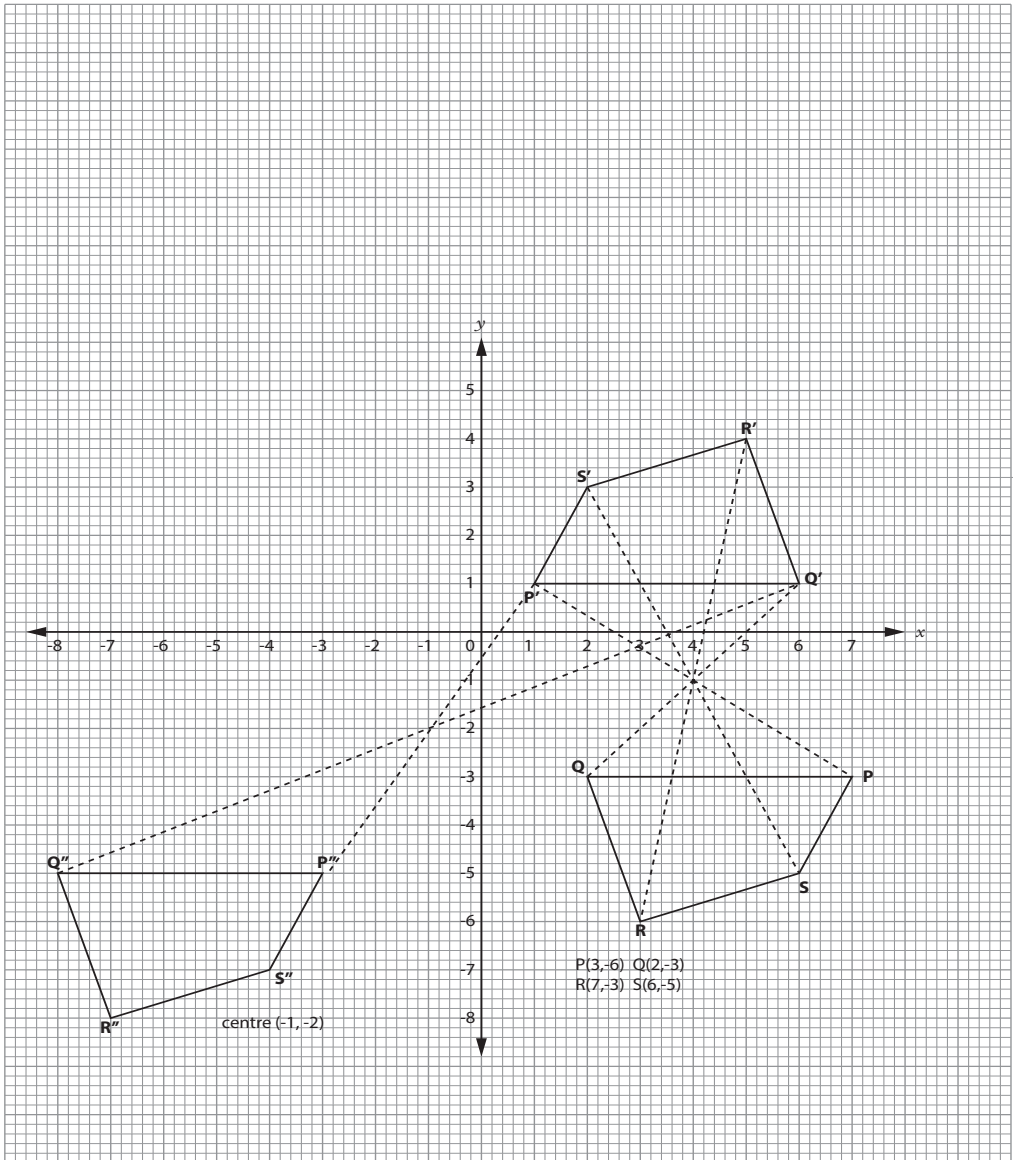



## Exercise 9.2

(Learners book pages 155 – 156)

Mark correct tracing and their images

## Exercise 9.3

(Learner's book pages 158 – 159)

- (a)  $P^I(4, -2)$   $Q^I(7, -3)$   $R^I(6, -2)$   $S^I(4, 0)$   
(b)  $P^{II}(2, 4)$   $Q^{II}(3, 7)$   $R^{II}(2, 6)$   $S^{II}(0, 4)$   
(c)  $P^{III}(-4, 2)$   $Q^{III}(-7, 3)$   $R^{III}(-6, 2)$   $S^{III}(-4, 0)$   
(d)  $P^{IV}(-2, -4)$   $Q^{IV}(-3, -7)$   $R^{IV}(-2, -6)$   
 $S^{IV}(0, -4)$
- (a) (i)  $A'(-6, 4)$ ,  $B'(-2, 3)$ ,  $C'(-1, 7)$   
(ii)  $A''(-6, 4)$ ,  $B''(2, -3)$ ,  $C''(-1, -7)$   
(b) (i)  $A'(-6, 4)$ ,  $B'(-2, 3)$ ,  $C'(-1, 7)$   
(ii)  $A''(4, -6)$ ,  $B''(3, -2)$ ,  $C''(7, -1)$   
(c) (i)  $A'(6, -4)$ ,  $B'(2, -3)$ ,  $C'(1, -7)$   
(ii)  $A''(6, 6)$ ,  $B''(2, 5)$ ,  $C''(1, 9)$   
(d) (i)  $A'(7, 6)$ ,  $B'(6, 2)$ ,  $C'(10, 1)$   
(ii)  $A''(-4, 6)$ ,  $B''(-3, 2)$ ,  $C''(-7, 1)$

3. Shape and size, points on the mirror line.

4. Reflection in the x-axis.

## Exercise 9.4

(Learner's book pages 163 – 164)

- (a) R  
(b) PQ and ST  
(c) Q  
(d) parallelogram  
(e)  $4.5\text{cm} < \overline{PQR}$
- (a)  $\overline{PQ} = \overline{P'Q'}$  (b) x  
(c) distance
- (b) (i)  $220^\circ$ ,  $-140^\circ$  (ii)  $70^\circ$ ;  $-290^\circ$   
(iii)  $280^\circ$ ;  $-80^\circ$  (iv)  $90^\circ$ ;  $-270^\circ$

## Exercise 9.5

(Learner's book page 167)

- (a)  $L'(1, 3)$   $M'(5, -2)$   $N'(3, 2)$   
(b)  $S'(4, 1)$   
(c)  $T'(6, 3)$   
(d)  $90^\circ$   
(e) arc of circle, centre (2,1) radius CL.

- (a)  $-90^\circ$  about (1, -1)  
(b)  $90^\circ$  about (-1, 1)  
(c)  $180^\circ$  about (0, 0)
- (a) (i) (-4, 4) (ii) (4, 3)  
(iii) (7, 4), (iv) (8, -6)  
(b) (i) (1, -7) (ii) (6, 3)  
(iii) (-7, -4), (iv) (-3, 2)  
(c) (i) (-4, -4) (ii) (3, -2)  
(iii) (0, 5), (iv) (3, 4)  
(d) (i) (4, 1) (ii) (11, 1)  
(iii) (2, 9) (iv) (3, 5)  
(e) (i) (-11, -11) (ii) (-1, 16)  
(iii) (-8, -3) (iv) (-2, -7)
- A (-2, 2) B (-6, -1) C (-2, -1)
- (a)  $A'(1, 1)$   $B'(2, -1)$   
 $C'(4, 0)$   $D'(3, 1)$   
(b) A rotation of  $180^\circ$  centre (-2, -1)
- (a)  $L'(-3, 2)$   $M'(-5, 2)$   $N'(-5, 6)$   
(b)  $L'(3, -2)$   $M'(5, -2)$   $N'(5, -6)$   
(c)  $L'(-2, -3)$   $M'(-2, -5)$   $N'(-6, -5)$
- (a) Rotation  $180^\circ$  centre (0, 0)  
(b) Reflection in the y-axis

## Exercise 9.6

(Learner's book page 169)

- (a) 8 m (b) 8 m  
(c) 8 m (d) 8 m
- (a) (i) To the right; 10 cm  
(ii) Every point moves 10 cm to the right.  
(b) (i) to, (iii) move to the right  
(c) (i) to (iii), move up parallel to FG
- 2, 12, 16, 19, respectively.
- (a) 10, 16, 19, 13 respectively.  
(b) G, H, K, L respectively.
- (a) EG, GK, HL  
(b) BD, CE

### Exercise 9.7

(Learner's book page 173)

1. (a)  $\begin{pmatrix} 7 \\ 0 \end{pmatrix}$

(b) (i)  $B'(12, 2)$       (ii)  $C'(12, 5)$

(iii)  $D'(9, 5)$

2.  $A'(8, 5)$      $B'(11, 5)$

$C'(11, 8)$      $D'(8, 8)$

3. Yes.  $\triangle LMN$  maps onto  $\triangle L'M'N'$  by a translation displacement vector  $\begin{pmatrix} 2 \\ 3 \end{pmatrix}$

4. Translation, displacement vector  $\begin{pmatrix} 5 \\ 2 \end{pmatrix}$

5. (a) (i)  $\mathbf{OA} = \begin{pmatrix} 3 \\ -1 \end{pmatrix}$ , (ii)  $\mathbf{AB} = \begin{pmatrix} 0 \\ 2 \end{pmatrix}$

(iii)  $\mathbf{OB} = \begin{pmatrix} 3 \\ 1 \end{pmatrix}$

(b) (i)  $O'(3, -1)$ ,  $A'(6, -2)$ ,  $B'(6, 0)$

(ii)  $O'(0, 2)$ ,  $A'(3, 1)$      $B'(3, 3)$

(iii)  $O'(3, 1)$      $A'(6, 0)$      $B'(6, 2)$

6. (a) translation, vector  $\begin{pmatrix} 5 \\ 4 \end{pmatrix}$

(b) translation, vector  $\begin{pmatrix} -5 \\ -4 \end{pmatrix}$

7.  $Q(-2, 4)$

8. (a)  $\mathbf{T} = \begin{pmatrix} 3 \\ 4 \end{pmatrix}$

(b)  $R(3, 5)$ ,  $S(6, 0)$ ,  $Q(-3, -1)$

(c)  $\begin{pmatrix} -3 \\ -4 \end{pmatrix}$

### Exercise 9.8

(Learner's book pages 176 – 177)

1.

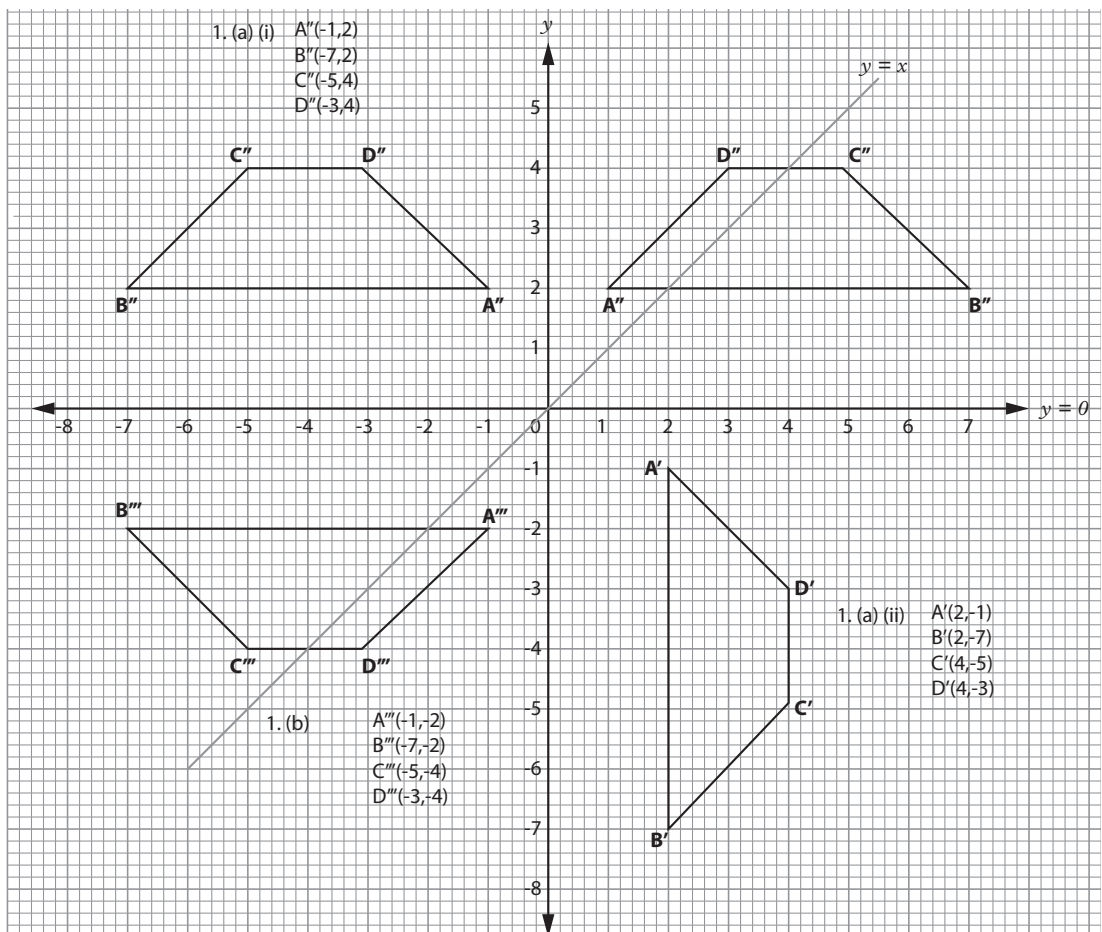

- (c) (i) ABCD maps on A''B''C''D'' by a rotation, centre (0, 0) through 180° or Central symmetry about centre (0, 0)  
 (ii) ABCD maps onto A''B''C''D'' by a reflection in the line x = 0

2. (a)

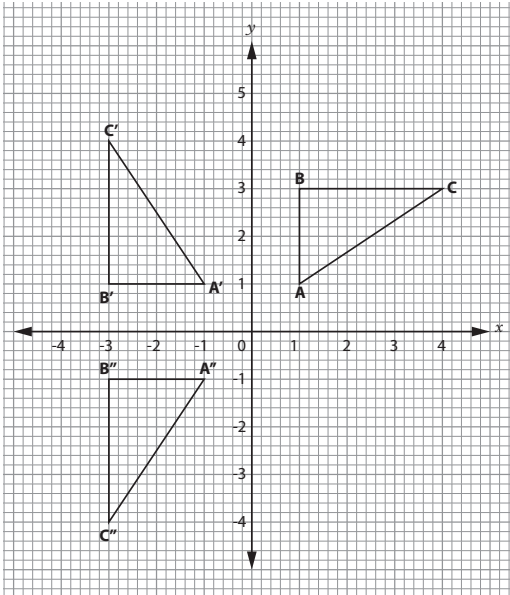

- (b) transformation denoted as **P** is a rotation centre (0, 0) through 90°  
 (c) transformation denoted as **M** is a reflection in the line y = 0

(d) transformation maps  $\Delta ABC$  onto  $\Delta A''B''C''$  is a reflection in the line y = -x

3. (a) (i)  $M(A) = (6, -2)$   
 (ii)  $T(B) = (12, 5)$   
 (iii)  $TM(A) = (16, 0)$   
 (iv)  $MT(B) = (5, 12)$
- (b) (i)  $TM(\Delta ABC)$   
 $A'(16, 0)$   $B'(13, 4)$   $C'(13, 4)$   
 (ii)  $MT(\Delta ABC)$   
 $A'(8, 8)$   $B'(5, 12)$   $C'(5, 8)$
4. (a)  $M(P): A'(-1, 0)$   $B'(-6, 0)$   $C'(-6, -4)$   
 (b)  $H(P): A'(0, -1)$   $B'(0, -6)$   $C'(-4, -6)$   
 (c)  $HM(P): A'(1, 0)$   $B'(6, 0)$   $C'(6, 4)$   
 (d)  $MH(P): A'(1, 0)$   $B'(6, 0)$   $C'(6, 4)$   
 (e)  $MM(P): A'(0, 1)$   $B'(0, 6)$   $C(4, 6)$   
 (f)  $A'(0, 1)$   $B'(0, 6)$   $C'(4, 6)$   
 (g)  $HM(P) = MH(P)$ ;  $MM(P)$  – same as the object  $HH(P)$ : same as the object.

**Answers to Unit test 9** (Learner's book pages 178-179)

1. (a) 2 lines                      (b) None                                      (c)  $A'(-2, 1), B'(-4, -1), C'(-7, 0)$   
     (c) 2 lines                      (d) 1 line                                      (d)  $A'(7, 1), B'(5, -1), C'(2, 0)$
2. Yes,  $90^\circ$ ; equal
3. (a)  $A'(-4, 1), B'(-2, 3), C'(1, 2)$   
     (b)  $A'(-4, -5), B'(-2, -3), C'(1, -4)$
4.  $A(1, 2), B(4, 2), C(4, 4)$ .
5. Reflection in the x-axis.

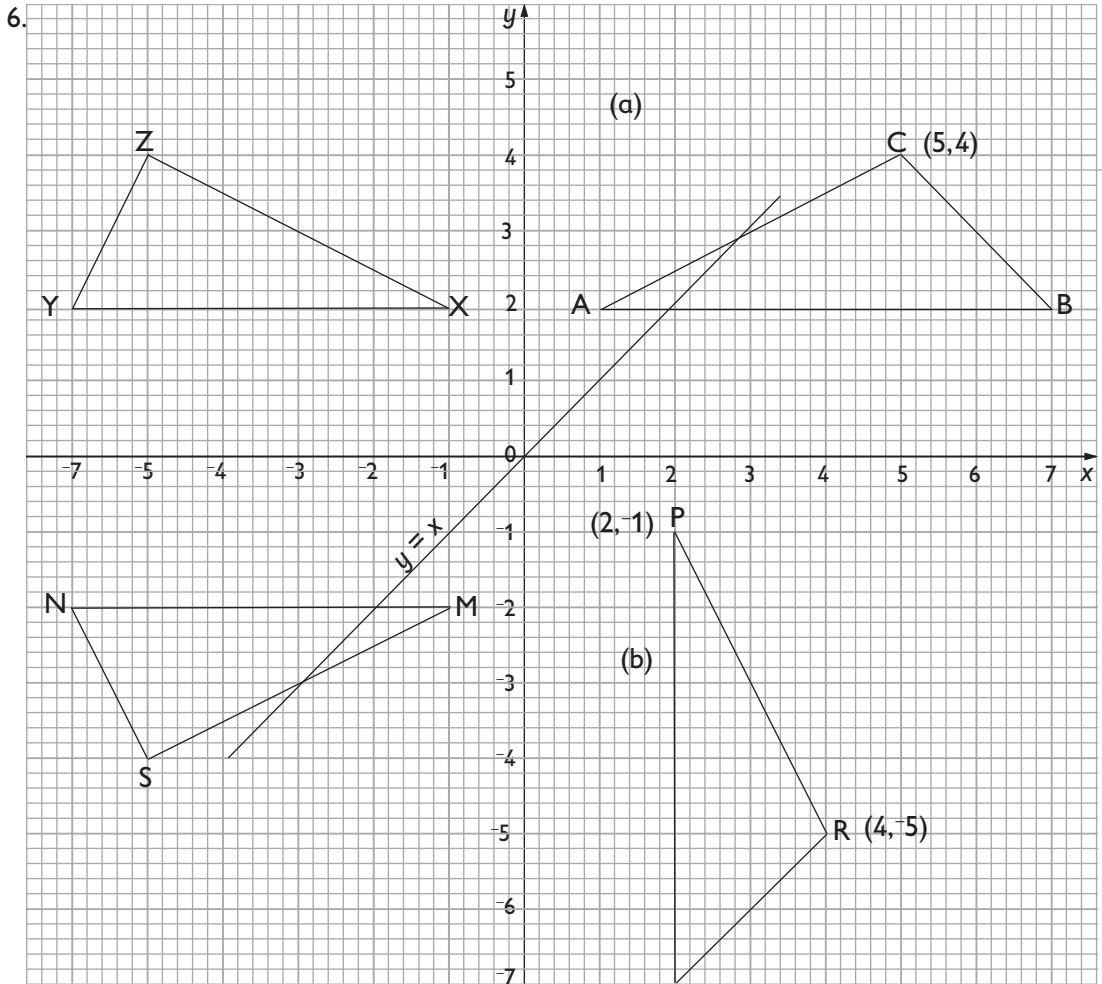

6. (c)  $X(-1, 2), Y(-7, 2), Z(-5, 4)$   
     (d)  $M(-1, -2), N(-7, -2), S(-5, -4)$   
     (e)  $\Delta MNS$  maps onto  $\Delta ABC$  by rotation of  $180^\circ$  about the origin
7.  $P'(2, 2), Q'(6, 2), R'(6, 6), S'(2, 6)$
8. A rotation of  $-90^\circ$  about  $(0, 0)$
9. (a)  $(3.5, 0.5)$                        $R(0, -5)$
10. (a) (i)  $(1, -1), 90^\circ$                       (ii)  $(1, -1), -90^\circ$   
     (b)  $y = -x$
11. (a), (c), (e) true; (b), (d) false
12. (a) (i)  $\Delta s ABC$  and  $PQR$  are oppositely congruent
13.  $A''(1, 0), B''(3, 3), C''(6, 1)$
14.  $\begin{pmatrix} -3 \\ 0 \end{pmatrix}$
15.  $A'(-1, 7), B'(1, 6), C'(2, 10)$
16. (a)  $\begin{pmatrix} 3 \\ 4 \end{pmatrix}$                       (b)  $R(3, 5), S(6, 0), Q'(3, 7)$

# Statistics and Probability

## Unit 10

## STATISTICS

Student's Book pages 180-217 (30 Lessons)

### Key unit competence

By the end of this unit, I will be able to collect, present and interpret grouped data.

### Content outline

10.1 Grouped data

10.2 Data presentation

10.3 Measure of central tendency

10.4 Interpreting statistical graphs

Answers

- Represent grouped statistical information using: histogram, polygon, frequency distribution table and pie chart.
- Calculate the mode, mean and median of statistical data
- Interpret correctly the graph of grouped statistical data

### Learning objectives

#### Knowledge and understanding

- Define grouped data and represent grouped data on a frequency distribution table
- Identify mode, middle class, modal class and median of given grouped statistical data
- Read and interpret diagram of grouped statistical data

#### Skills

- Apply data collection to carry out a certain research.

#### Attitudes and values

- Appreciate how data collection, data representation and data interpretation can be used for solving real life situations.
- Appreciate the importance of data in culture of investigation and decision making.
- Team work spirit and respect the views of others.
- Develop accuracy in reading graphs instructing shapes under isometries

## Generic competences addresses in this unit

- Communication skills
- Critical thinking
- Problem solving
- Research/innovation
- Cooperation, interpersonal management and life skills.

## Links to other subjects

- History, Biology, Geography, Physics, Computer Science, Finance, Etc

## Cross cutting issues addressed in this unit

- Inclusive education
- Financial education
- Genocide studies
- Peace , gender and values
- Standardization of culture
- Comprehensive and sexuality education
- HIV and AIDS

## Assessment criteria

Collect, represent and Interpret grouped data.

## Background information

Statistics is not a new topic to the learners and it's highly practical. Statistics is a topic that can open doors for learners in future careers that deal with handling data. As a teacher, you can therefore engage the learners in many activities and make the topic more interesting through the activities. Most of it that involves collecting data should

be done by the students to allow them interact with environment. You should also help to arouse the interest of the learners in statistics especially the slow learners.

## Suggested teaching/learning activities

### 10.1 Grouped data

By the end of this section, the learner should be able to make a frequency distribution table of a grouped data.

### Teaching/learning guideline 10.1

- With reference to table 10.1, on page 180 in learner's book, discuss grouping of data into classes; introduce the terms such as class, class size, class limits, frequency distribution table etc.
- Organise the class into pairs and let them decide who among them would record their findings and report.
- Let the class do activity 10.1 and 10.2 on page 181 learner's book.
- Ensure that the learners summarize their findings accurately.
- Give as many as possible a chance to report their findings to the rest of the class.
- Summarise the learners' findings to ensure that all are with you.
- Take the class through example 10.1 on pages 182-183 learner's book, dividing any questions from the class.
- Ask the learners to do exercise 10.1 on pages 183-184 learner's book as you supervise to ensure that they have grasped the concept and the procedure.

**Answers to activity 10.1 learners book page 180**

1.

Mass (kg)	tally	Frequency (f)
36-40	//	2
41-45	///	3
46-50	####	8
51-55	####	8
56-60	###	5
61-65	////	4
		$\Sigma f = 30$

2. a) Highest mass is for 46-50 and 51-55

b) Lowest mass is 36-40

3. 50.4 belongs to 49-50 because the boundary is at 50.5

50.9 belongs to 51-55 because the boundary is at 50.5

**Answers to activity 10.2 learners book page 181**

1. a) Lowest score is 6

b) Highest score is 95

2. Range = highest – lowest = 95 – 6 = 89

3.

Marks	Tally	Frequency
1 - 10	//	2
11 - 20	///	3
21 - 30	////	4
31 - 40	####	6
41 - 50	####	7
51 - 60	#####	10
61 - 70	###	6
71 - 80	###	5
81 - 90	////	4
91 - 100	///	3
		$\Sigma f = 50$

Range helps in determining the class intervals

**10.2 Data presentation**

**10.2.1 & 10.2.3 Class boundaries, histogram and frequency polygon**

By the end of this section, the learner should be able to group given data and to present it on histogram and frequency table **materials:** graph papers, raw data to be used.

**Teaching / learning guidelines 10.2**

- Organise your class into groups. Ensure that the group has a secretary and a group leader.
- Familiarise the class with terms such as frequency density, class boundaries.
- Let the learners work through the activities 10.3, 10.4, 10.5 on page 184 - 190 in this section.
- Ensure that all learners participate actively in the given activities to reap maximum benefit.
- Ensure that they summarise their findings accurately and invite the groups to present findings to the rest of the class
- Conclude their findings to ensure that they all have the correct findings.
- As you summarise emphasize on the following; Frequency density, class boundaries, correct labelling of the axes,
- Correct drawing of a histogram and a frequency polygon.

- Take learners through the examples 10.2, 10.3 page 186-188 in learner's book and ask them to do Exercise 10.2 on page 188 in the learner's book.

### Answers to activity 10.3 page 184-185

Height (cm)	Frequency
149.5 - 154.5	3
154.5 - 159.5	7
159.5 - 164.5	10
164.5 - 169.5	14
169.5 - 174.5	6
174.5 - 179.5	6
179.5 - 184.5	3
184.5 - 189.5	1

### Answers to activity 10.4 learners book page 185-186

- a) Frequency density- This is the ratio of the frequency to the width of the class intervals in grouped data.

Relative frequency: This describes the number of times a particular value or variable has been observed to occur in relation to the total number of values for the variable.

b)

Height (cm)	Frequency	Frequency density
149.5 - 154.5	3	0.6
154.5 - 159.5	7	1.4
159.5 - 164.5	10	2
164.5 - 169.5	14	2.8
169.5 - 174.5	6	1.2
174.5 - 179.5	6	1.2
179.5 - 184.5	3	0.6
184.5 - 189.5	1	0.2

For the graph, see figure 10.1 in learners book page 183.

### Answers to activity 10.5 learners book page 190

See table 10.26 in learners' book page 190 for this activity

### 10.2.4 Pie-chart

By the end of this section, the learner should be able to represent given data in a pie chart.

**Materials:** mathematical instruments.

### Teaching /learning guidelines 10.2.4

- Ensure that learners work in groups. Remind them of the need for a secretary and a group leader.
- Lead them through the activity 10.6 on page 191 suggested in the learner's book with regard to pie chart
- Emphasise the importance of the class boundaries and the conversion of frequencies into degrees.
- Let the learners summarise their findings and give them a chance to report their findings to the class.
- Finally, conclude the findings of the activity, by summarising and emphasizing the key points.
- A pie-chart is a graph or diagram in which different proportions of a given data distribution is represented by sectors of a circle.
- Take learners through example 10.4 and 10.5 on page 192-193 learner's book and ask them to do exercise 10.3 on page 193 to 194 in learner's book.



### Answers to activity 10.6 learners book page 191

This is well explained in the learners' book. A teacher should follow the procedures well to guide the learners in this activity. He should allow learners to ask more questions to understand more.

### Cumulative frequency table and graph

By the end of this lesson, the learner should be able to construct a cumulative frequency table, and draw a cumulative frequency graph. Read answers from the graph

#### Material

Graph paper

#### Teaching guidelines 10.2.5

- Organise the class into groups and remind them of the need for a secretary and a group leader.
- Let the class do activity 10.7 in the learners book on page 195 .
- Ensure that they summarise their findings and invite them to present their findings to the class.
- As they present, pick the key points that you may wish to clarify or correct.
- As you summarise the activity, emphasize the correct method of plotting and drawing the cumulative frequency curve.
- Point out how we can use the curve to estimate the median of a grouped data. We can use cumulative frequency graph to estimate median of data.
- Take learners through example 10.6 on page 196 -197 learner's book

and ask them to do Exercise 10.4 on learner's book page 197.

### Answers to activity 10.7 learners' book page 195

This is well explained in the learners' book. A teacher should follow the procedures well to guide the learners in this activity. He should allow learners to ask more questions to understand more.

### 10.3 Measures of central tendency

#### 10.3.1 Arithmetic mean

By the end of this section, the learner should be able to estimate the mean of a grouped data.

#### Teaching guidelines 10.3.1

- Help learners to recall the meaning of measures of central tendencies as they learned in S1.
- Let them and describe some of them like the arithmetic means, the median, the mode.
- Now organise your class into groups and ask them to carry out activity 10.8 on learner's book page 198.
- Let them summarise their findings and invite as many groups to present their findings to the class.
- Summarise their presentations emphasizing the meaning of the notation  $\bar{x}$ ,  $\Sigma$ ,  $z + x$ ,  $(\Sigma fx)/(\Sigma f)$   
$$\bar{x} = \frac{\Sigma fx}{\Sigma f}$$
- Take the learners through examples 10.7 and 10.8 on learner's book page 199.

- Ask learners to do exercise 10.5 on page 199-200 learner's book.

### 10.3.1.1 Findings the mean using the assumed mean

#### Teaching guidelines 10.3.1.1

- This is an alternative method of estimating the mean.
- Take the learners through the explanation given in the pupil's book first.

$$\bar{x} = A + \frac{\sum f x - A}{\sum f}$$

- Take them through examples 10.9 and 10.10 in the learner's book on page 201-202.
- Ask the learners to do exercise 10.6 on page 202 - 203.

### 10.3.2 -10.3.3 The mode and the range

By the end of this lesson, the learner should be able to:

- Estimate the mode of a grouped data.
- To define the range of a set of information.

#### Teaching/learning guidelines 10.3.2 -10.3.3

- Take the learners through the explanation of the formulae described in the pupil's book.

$$\text{Mode} = L + \frac{t_1}{t_2 + t_1}$$

Range = Highest – Lowest value

- Take them through example 10.11 on page 204 learner's book.
- Ask learners to do exercise 10.7 on page 205 in learner's book.

### 10.3.4 The median

By the end of this section, the learner should be able to estimate the median of a grouped data using the formula.

#### Teaching / learning guidelines 10.3.4

- Help the learners to review how to calculate the median of un-grouped data.
- Organise the class into groups and let the groups pick their respective leaders and secretaries.
- Get the groups work through activity 10.9 on page 206 learner's book and summarise their observations.
- Move around the class to ensure that all are actively involved in the activity.
- Have a few groups report their findings to the class follow them closely to verify their findings and emphasize on the key concepts and points of learning.

$$\text{Median} = \left(\frac{1}{2} (N + 1)\right)^{\text{th}}$$

$$\text{or } \frac{(n^{\text{th}} + (n + 1)^{\text{th}})}{2}$$

- Take the class through examples 10.12 and 10.13 on page 207 - 208 learner's book.
- Ask the learners to do Exercise 10. on page 209 - 210 in learner's book.

### 10.4 Reading statistical graphs and diagrams

By the end of this section, the learner should be able to read information from statistical graphs and diagrams such as

- Frequency distribution tables.
- Histograms and bar graphs

- (iii) Frequency polygon
- (iv) Cumulative frequency graphs.
- (v) Pie charts etc.

**Teaching / learning guidelines 10.4**

- Organise the learners to work in pairs as they go through activity 10.10 on page 210 in learner's book.
  - Monitor them closely so that you can check their working and their conclusions.
  - To summarise the findings of the activity, conduct a class discussion so that many have a chance to give their observations.
- Verify their findings and emphasize the fact that all observations are learning points to be mastered.
  - Take them through example 10.14 on pages 211 - 212 in learner's book.
  - Ask pupils to do exercise 10.9 on page 212 - 213 in learner's book.
  - Ask them to do unit 10 test on page 216 - 217 in learner's book and assess their work

**ANSWERS**

**Exercise 10.1**

(Learner's book pages 183 - 184)

1.

Hand span	Tally	Frequency
14.0 - 15.9	///	3
16.0 - 17.9	### /	6
18.0 - 19.9	### ///	8
20.0 - 21.9	////	4
		21

2.

Length (mm)	Tally	Frequency
50 - 59	////	4
60 - 69	### /	6
70 - 79	### ### //	12
80 - 89	### ###	10
90 - 99	////	4
		36

3.

Amount (K)	Tally	Frequency
10 - 19	////	4
20 - 29	//	2
30 - 39	### /	6
40 - 49	### ### ###	15
50 - 59	### ### ///	13
60 - 69	### ### /	11
70 - 79	###	5
80 - 89	### ////	9
90 - 99	###	5
		70

4.

Length (cm)	Tally	Frequency
0.1 - 1.5	### ### ### ### //	22
1.6 - 3.0	### ### /	11
3.1 - 4.5	### ###	10
4.6 - 6.0	### ### ///	13
6.1 - 7.5	////	4
7.6 - 9.0	### ###	10
		70

**Exercise 10.2**

(Learner's book page 188)

1.

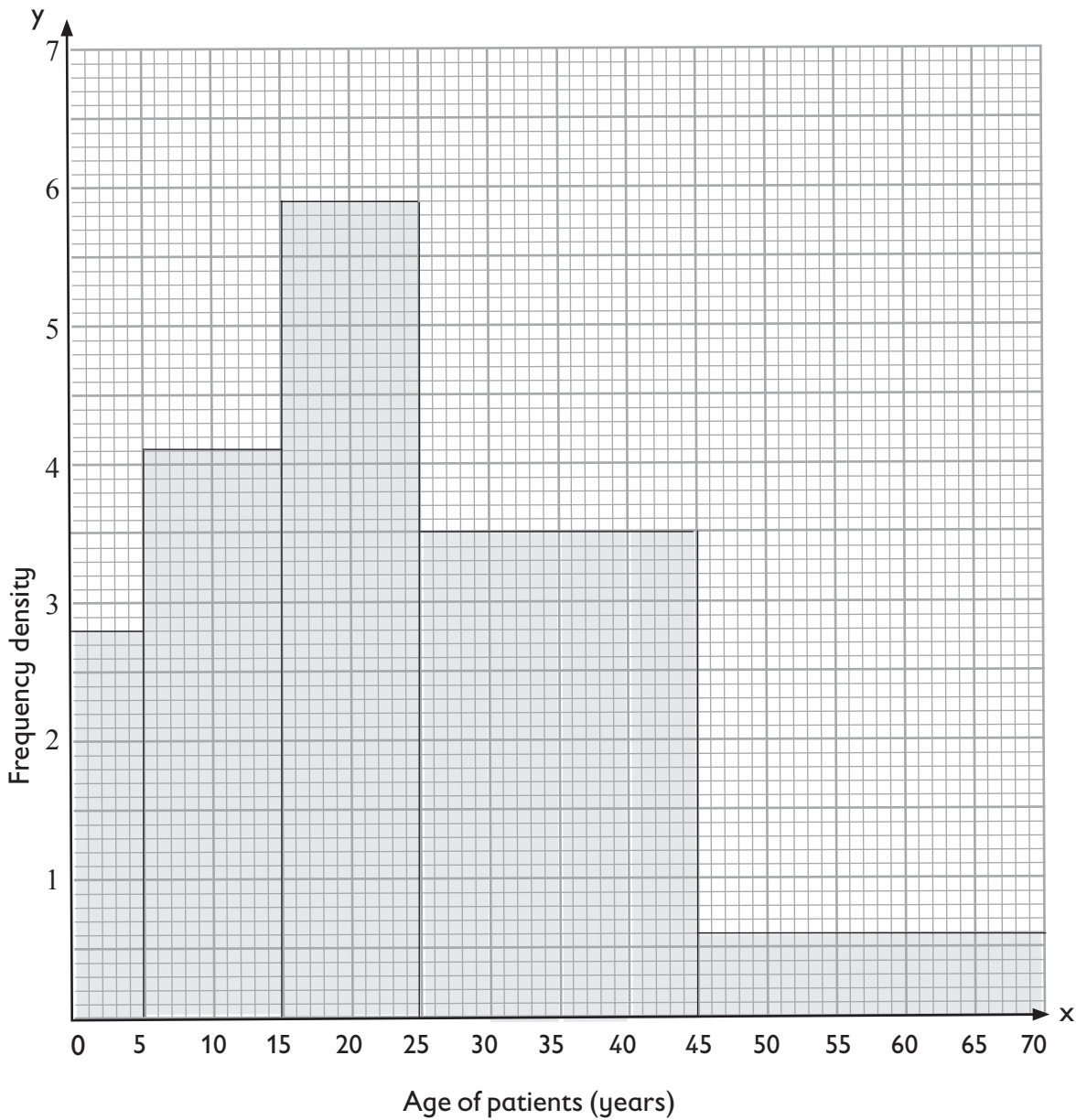

2.

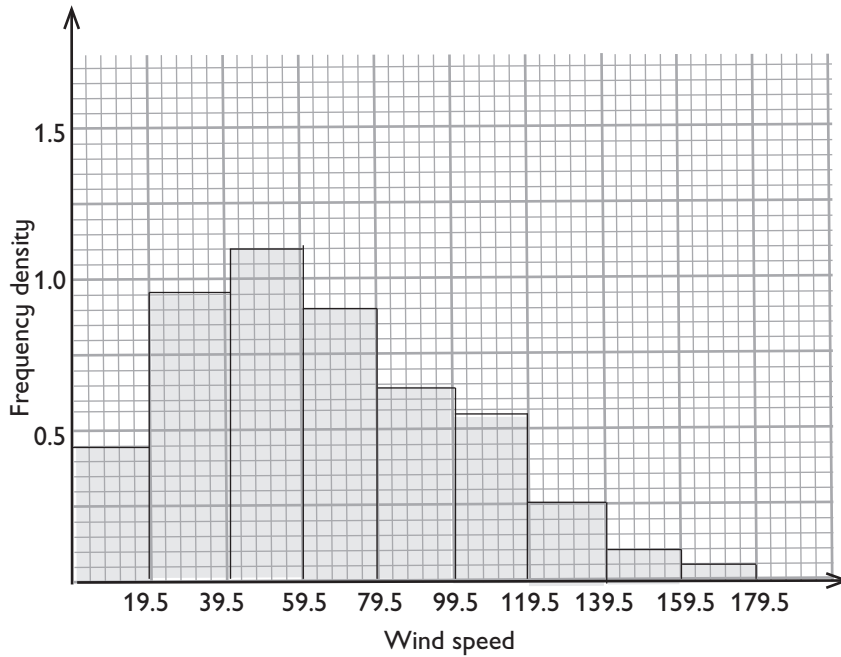

3.

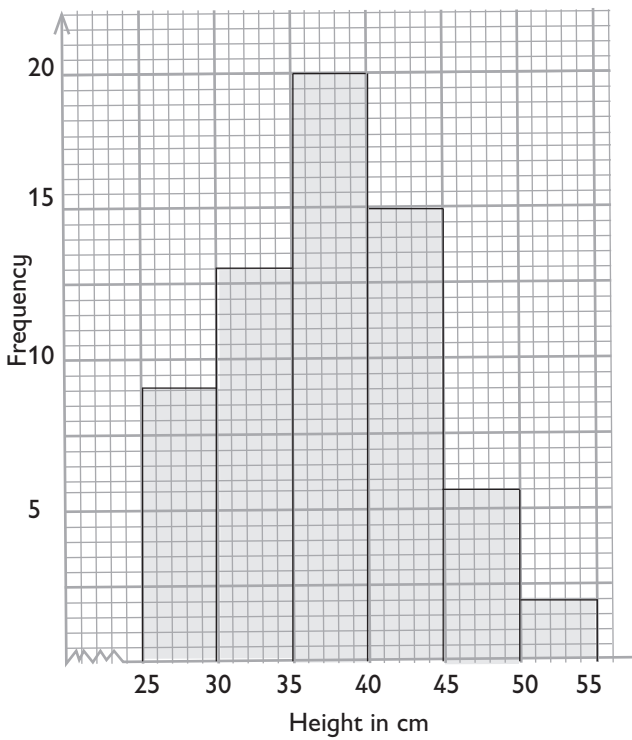

4.

Marks	frequency	frequency density
20-25	2	0.4
25-30	4	0.8
30-35	2	0.4
35-40	10	2
40-45	4	6.8
45-50	5	1
50-55	3	0.6
55-60	2	0.4
60-65	3	0.6
65-70	2	0.4
70-75	3	0.6
	$\sum fx = 40$	

### Exercise 10.3

(Learner's book pages 193-194)

1. (a)

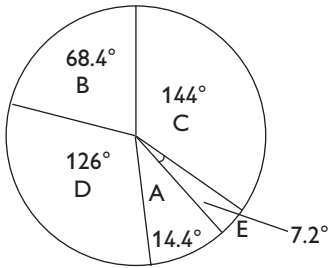

(b)

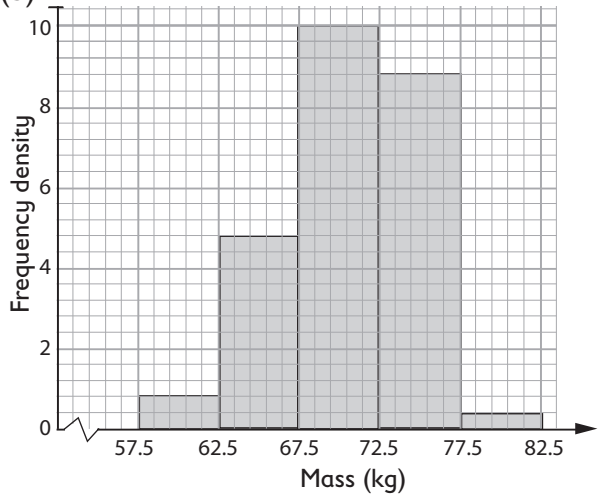

2. (a)

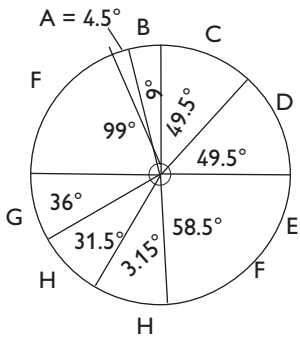

(b)

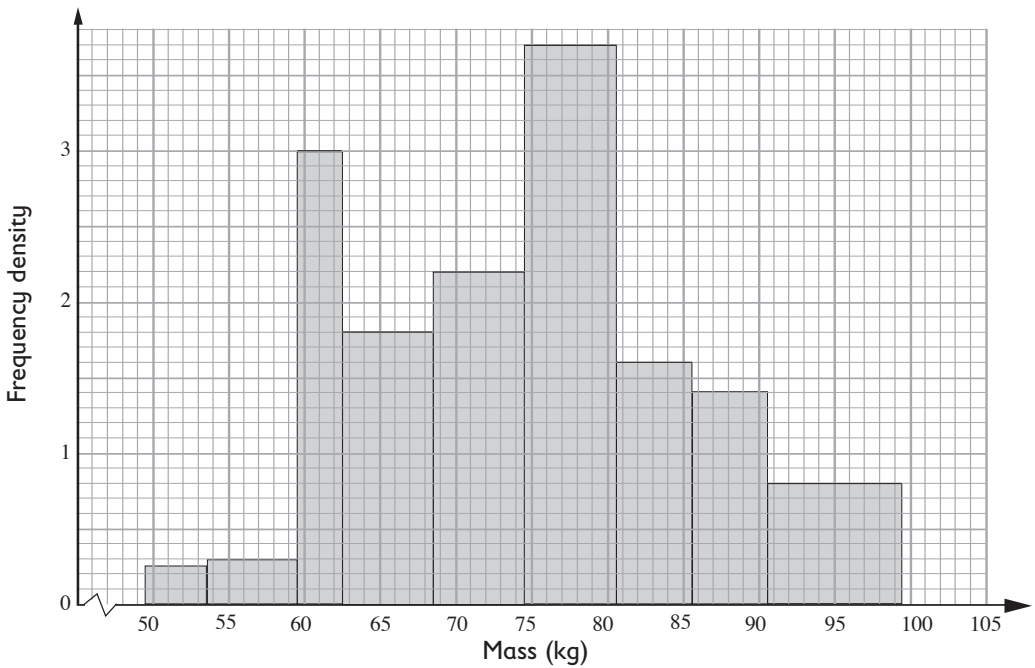

3. (a)

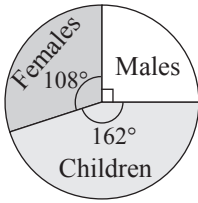

(b) 427 500 children

(c) 106 875 females not married

4.

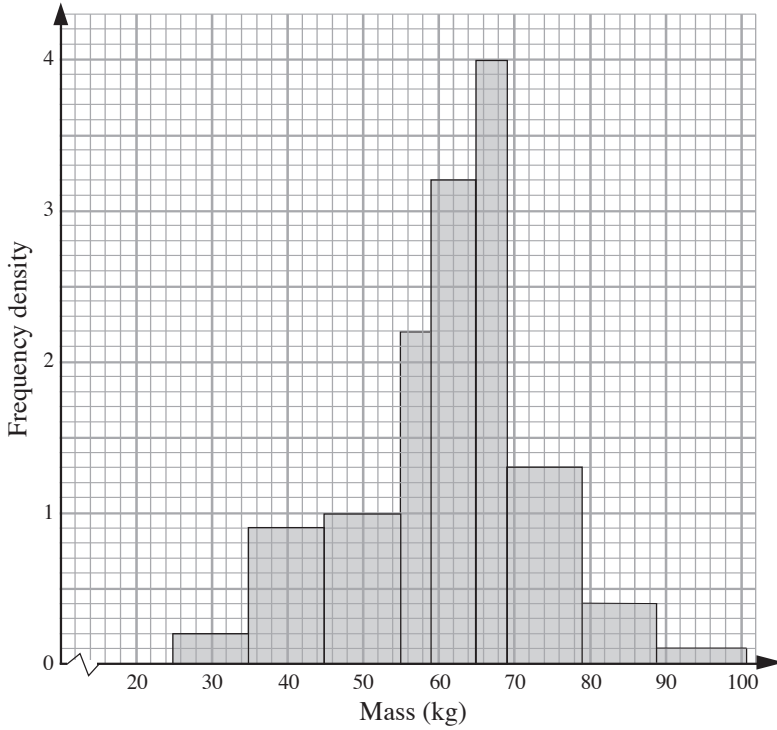

5. (a) 720 students (b) 70 students

6. (a) Frequency polygon for data in question 1 Table 10.3.2

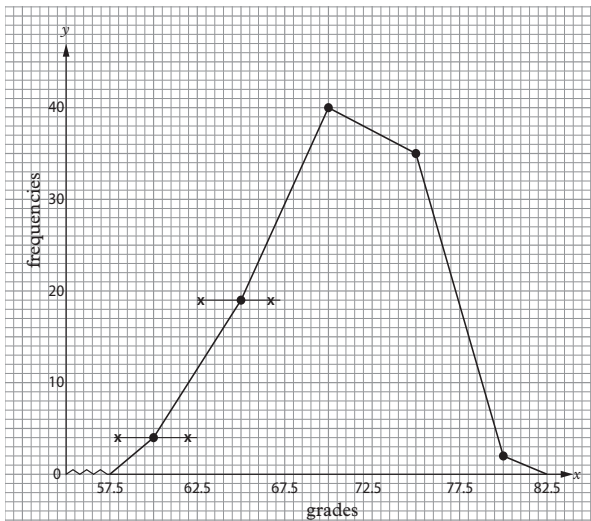

(b) Frequency polygon for data in question 2 Table 10.3.3

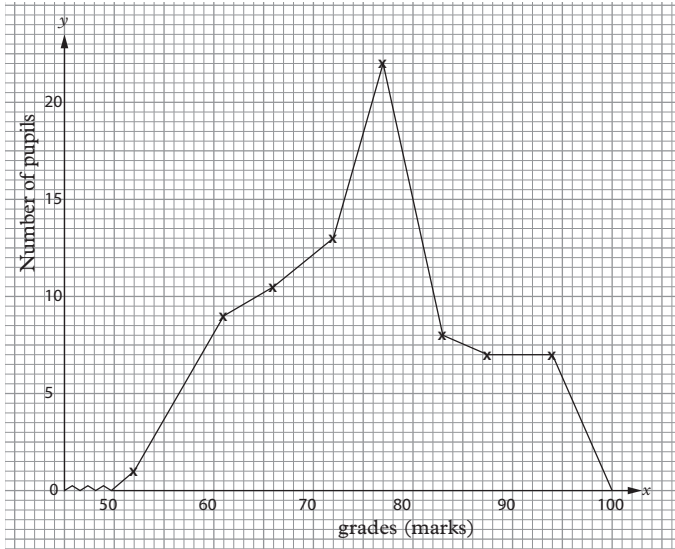

(c) Frequency polygon for data in question 4 Table 10.3.4

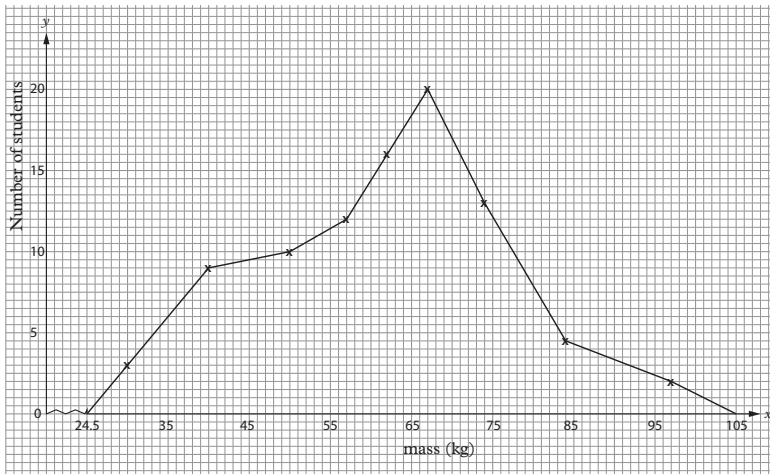



**Exercise 10.4** (Learner's book page 197)

1.

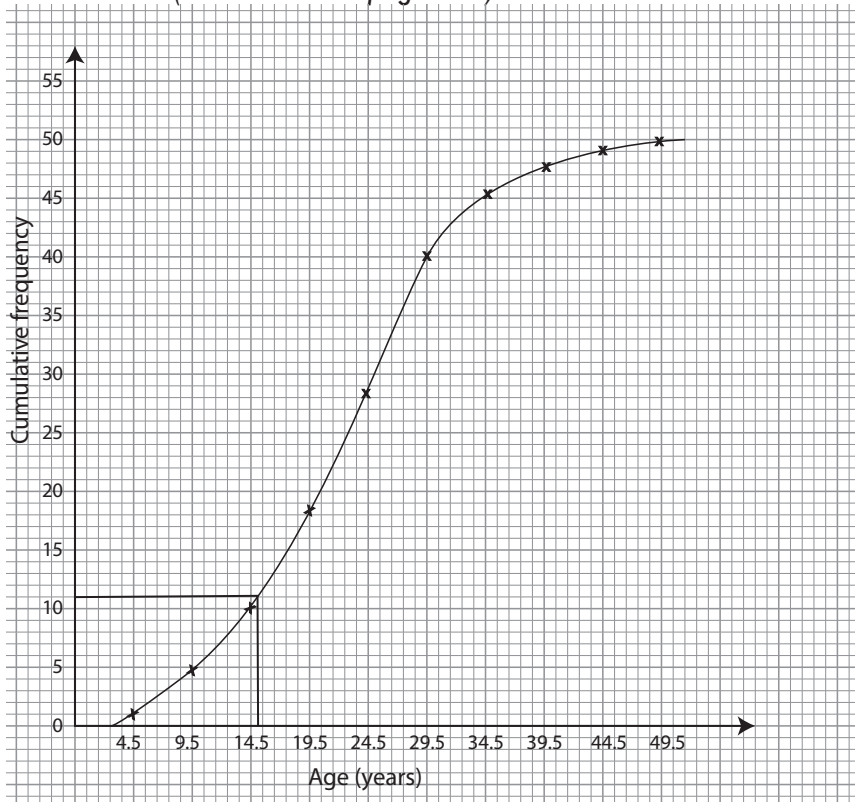

2.

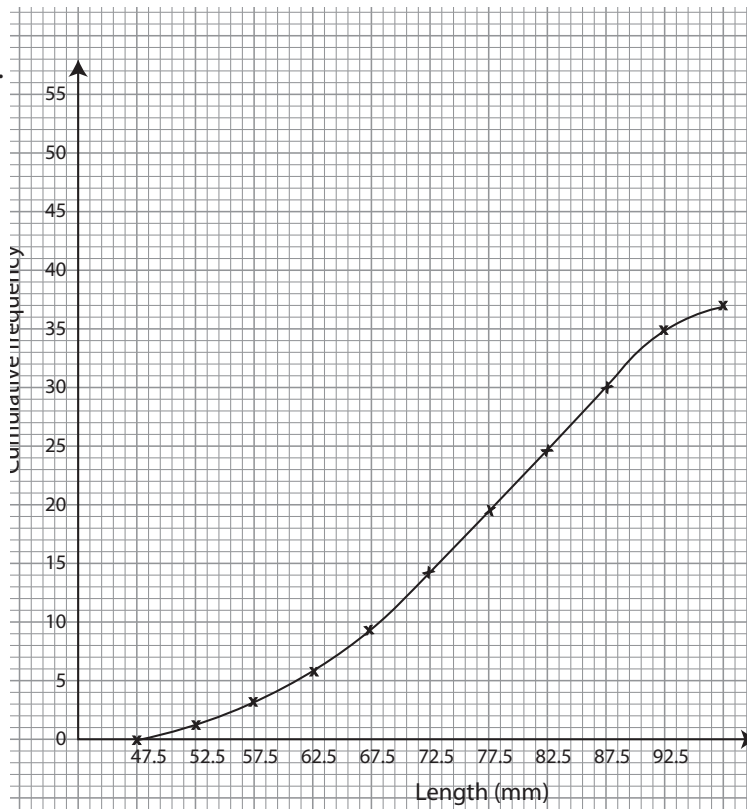

Class limit	f	cf	Upper boundary
48 - 52	1	1	52.5
53 - 57	2	3	57.5
58 - 62	3	6	62.5
63 - 67	3	9	67.5
68 - 72	4	13	72.5
73 - 77	7	20	77.5
78 - 82	4	24	82.5
83 - 87	6	30	87.5
88 - 92	5	35	92.5
93 - 97.5	1	36	97.5

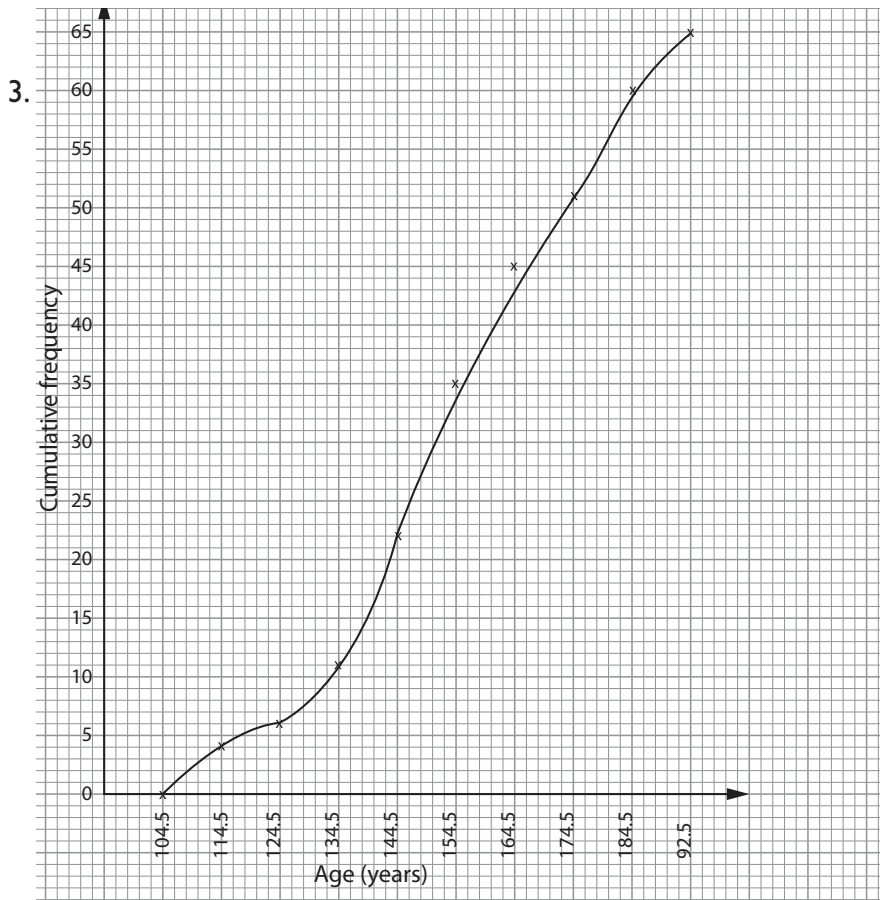

### Exercise 10.5

(Learner's book pages 199-200)

- 8.44 kg
- 14.55
- 844.2 FRW
- (a) 56.5  
(b) 57
- 44.9 marks
- 161.2 cm

### Exercise 10.6

(Learner's book pages 202-203)

- (a) 184.7                      (b) 68.94  
(c) k 18.70                      (d) 224 cm
- 40.96 marks
- 59.5 kg
- 21 years
- 61.7 cm

### Exercise 10.7

(Learner's book page 205)

- (a) (i) 25                      (ii) 10  
(b) (i) 9                      (ii) 27  
(c) (i) 7                      (ii) 21
- (a) 37, 25                      (b) 33
- 22, 17                      4. 55
- 27.77

### Exercise 10.8

(Learner's book pages 209-210)

- (a) 22                      (b) 20  
(c) 14                      (d) 12.5
- (a) 77 kg                      (b) 51 mm
- 46
- (a) 51 persons                      (b) 40 years
- (a) (i) 72 marks                      (ii) 25 marks  
(b) 20                      (c) 44.7 marks
- 53.5, 48
- Mode: 4, media: 5

8. (a) Mode: 1.8, (b)(i) median: 1.8,  
(ii) mean: 1.8
9. (i) Median: 180  
(ii) Mode: 180  
(iii) Mean: 182
10. Mean: 16, median 16

### Exercise 10.9

(Learner's book pages 212-213)

1. (a)

Class	Upper boundary	Mid-value ( $x$ )	cf	f
0 - 20	19.5	10	8	8
20 - 39	39.5	24.5	28	20
40 - 59	59.5	44.5	50	22
60 - 79	79.5	69.5	68	18
80 - 99	99.5	89.5	81	13
100 - 119	119.5	109.5	92	11
120 - 139	139.5	129.5	97	5
140 - 159	159.5	149.5	99	2
160 - 179	179.5	169.5	100	1

1. (b) 62.84 (c) 59.78  
(d) 59.5, has a difference of 0.28  
(e) 44.5

2. (a)

mks	$x$	f	fx	$fd = \frac{f}{c}$	cf
1-10	5.5	12	66	1.2	12
11-20	15.5	11	170.5	1.1	23
21-30	25.2	15	382.5	1.5	38
31-40	35.5	21	745.5	2.1	59
41-50	45.5	24	1092	2.4	83
51-60	55.5	33	1831.5	3.3	116
61-70	65.5	39	2545.5	3.9	155
71-80	75.5	24	1812	2.4	179
81-90	85.5	15	1282.5	1.5	194
91-100	95.5	6	573	0.6	200
		$\Sigma f = 200$	$\Sigma fx = 10501$		

2. (b)

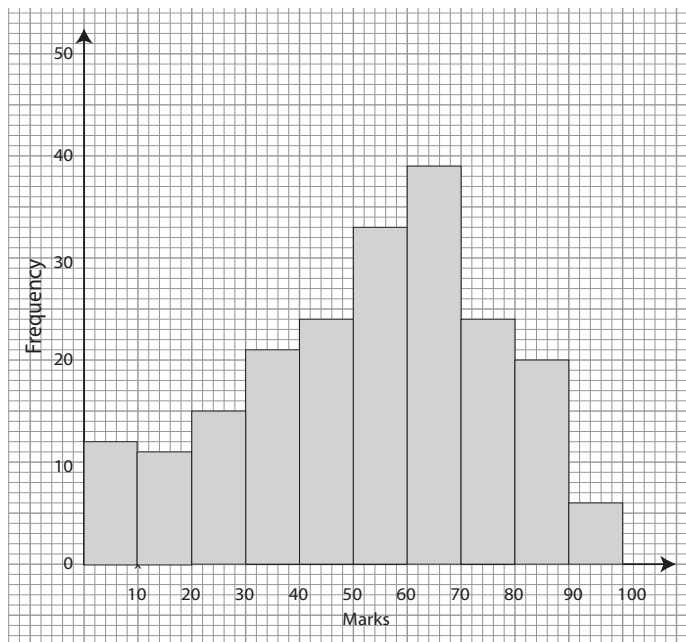

2. (c) (i) 52.51 (ii) 49.98 (iii) 69.07

3. (a) 25 years

(b)

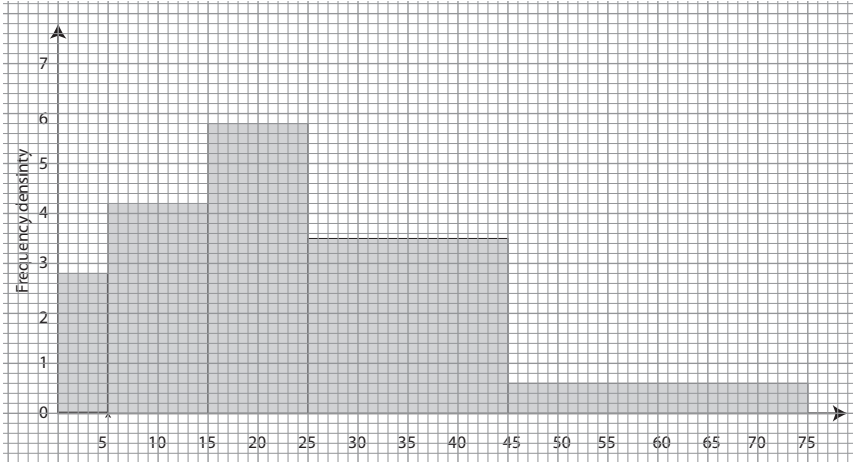

4. (a)  $A=23, B=13, C=10, D=10, E=27, F=37$

(b)

Class	30-39	40-94	50-59	60-69	70-79	80-89
Frequency(f)	23	36	46	56	83	120

(c) (i) 62.06      (ii) 71.08      (iii) 80-89

5. (a)

Class	35-39	40-44	45-49	50-54	55-59	60-64	65-69	70-74
Frequency(f)	1	7	11	4	2	2	2	1

(b) 45-49

6. (a)

Mass(kg)	0-5	5-10	10-15	15-20	20-25	25-30
Frequency(f)	5	10	17	8	7	3

(b) 23 people

7. (a)

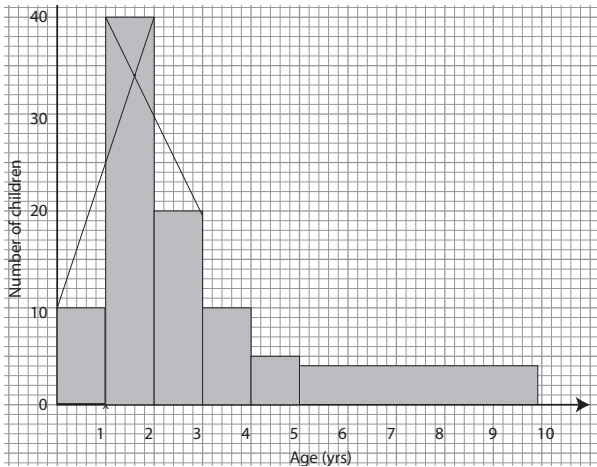

(b)

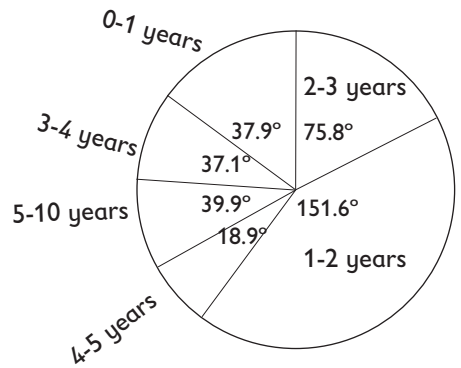

**Answers to Unit 10 test**

1. (a) 29.83 (b) 25.33 (c) 25-29

2.

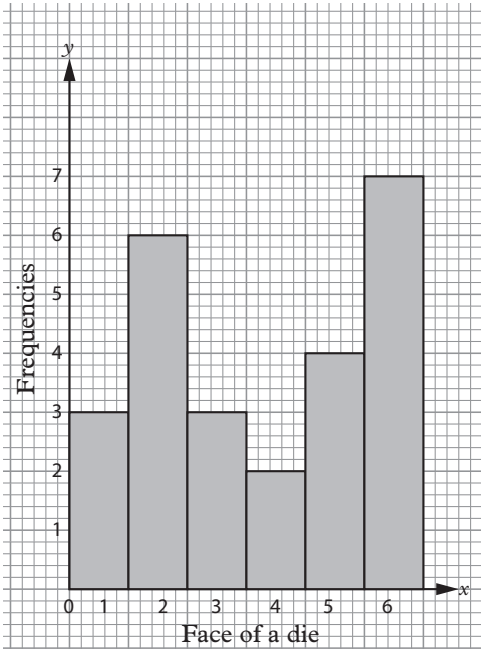

3. Paul: 160 l  
 Jean: 200 l  
 Charlotte: 340 l  
 Lucie: 500 l

4. (a) mean =  $\frac{2480}{65}$   
 median = 38.15  
 (b) modal class: 36-40  
 (c) the mode: 38.417

(d) 1.6 yrs

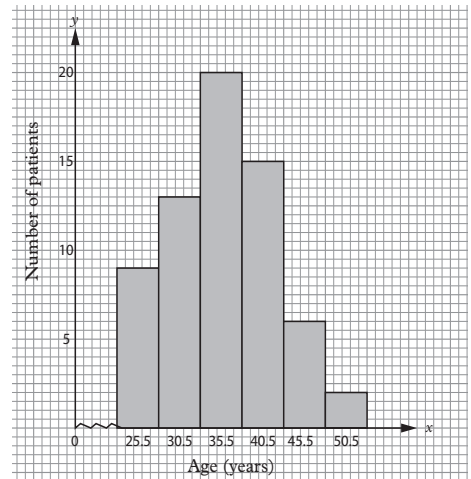

5. (a) 26.05  
 27.1  
 (b)

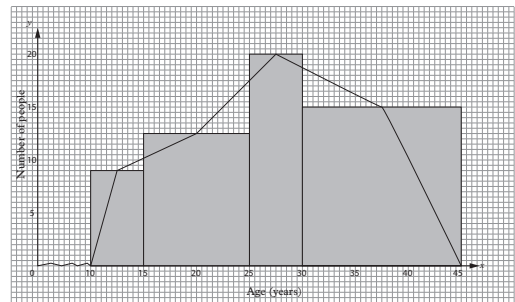

6. Mean = 29.875  
 median = 24.375  
 7. (a) Mean mass: 4.1 g  
 (b) Median mass 4.28 gms  
 8.  $\alpha = 5$   
 Median = 5

# Statistics and Probability

## Unit 11

### TREE AND VENN DIAGRAMS AND SAMPLE SPACE

Learner's Book pages 218 – 235 (30 Lessons)

#### Key unit competence

By the end of this unit, I will be able to determine probabilities and assess likelihood by using tree and Venn diagrams.

#### Content outline

- 11.1 Introduction
- 11.2 Tree diagrams and total number of outcomes
- 11.3 Determining probability using tree and Venn diagrams
- 11.4 Mutually exclusive events
- 11.5 Independent events

Answers

#### Learning objectives

##### Knowledge and understanding

- Define mutually exclusive and independent events
- Count the number of branches and total number of outcomes on a tree diagram

##### Skills

- Construct and Interpret correctly the tree diagram
- Use tree and Venn diagrams to determine probability.

#### Attitudes and values

- Appreciate the importance of probability to find chance for an event to happen.
- Show curiosity to predict what will happen in future.
- Promote team work spirit and self confidence.

#### Generic competences addresses in this unit

- Communication skills
- Critical thinking
- Problem solving
- Research/innovation
- Cooperation, interpersonal management and life skills.

#### Links to other subjects

- Financial education, Physics, Chemistry, Biology, Physical Education and Sport, Etc.

## Cross cutting issues addressed in this unit

- Inclusive education
- Financial education
- Genocide studies
- Peace , gender and values
- Standardization of culture
- Comprehensive and sexuality education
- HIV and AIDS

### Assessment criteria

Determine probabilities and assess likelihood by using tree diagrams.

### Background information

Probability is one of the branches of mathematics. It is one area in mathematics that the learners can have a career in, for example Bachelor of Science in statistics involves a combination of statistics and probability. It is a highly practical subject hence you should engage the learners in as many practical activities to arouse their interest and help them understand probability concepts with ease. Such activities may in be in simple experiments like praying cards, throwing coins, dice and analysis.

### Suggested teaching/learning activities

#### 1.1 Introduction

By the end of this lesson, learners should be able to review the concepts of probability from senior one.

### Materials

Chalk, dice, playing cards, coins, calculators, exercise books.

### Teaching guidelines 1.1

- Organise the learners in pairs to do activity 11.1 in learners' book page 218.
- Note that one learner should act as the secretary.
- Let the secretaries present their findings through class discussion and use the opportunity to remind the learners about concepts of probability in book one.
- Take them through example 11.1 on page 218 for the learners.
- Allow the learners to do exercise 11.1 on page 219 and move around to correct those who are wrong and guide them more about probability concepts.
- Conclude the lesson by summarizing the probability concepts and formulas covered in the lesson.
$$P(A) = \frac{n(A)}{n(S)}$$
- This lesson will promote;
  - (i) Leadership skills
  - (ii) Communication skills
  - (iii) Critical thinking among other competences.

### Answers to activity 11.1 learners book page 218

1. Probability is the measure of likelihood that an event will occur.

2. a) because there are 40 students of which 22 are boys, the probability of getting a boy is  $\frac{22}{40} = \frac{11}{20}$

b) Because there are 18 girls in a class of 40 boys, the probability of getting a girl is  $\frac{18}{40} = \frac{9}{20}$

## 11.2 Tree diagrams and total number of outcomes

By the end of this lesson, should be able to understand how to use tree diagrams to determine the total number of outcomes.

### Materials

Coins, Dice, playing cards

### Teaching guidelines 11.2

- Organise the learners in groups of three. One learner should be group leader and another should work as secretary
- Let the learners do activity 11.2 on page 219 in learners book.
- Let the learners present their findings through group leaders in class discussion
- Use the opportunity to explain to the learners what a tree diagram is after they have presented their views.
- Perform simple experiment of throwing a coin or two coins and determine the total number of outcomes. This will make learners understand more the concepts.
- Take them through examples 11.2 on page 220 in the learners book.

- Test the learners with example 11.3 on page 220 in the learners book which might be more challenging.
- Help the slow learners to understand more concepts on this example.
- Let the gifted learners do example 11.4 as you are explaining to slow learners.
- Let the learners do Exercise 11.2 on page 220-221 from number one to number four. Move around the class and correct those with mistakes.
- Give the rest of the Exercise 11.2 on page 220-221 as an assignment.
- This unit will promote;
  - (i) Leadership skills
  - (ii) Innovative and thinking
  - (iii) Problem solving skills

### Answers to activity 11.2 learners book page 219

1. a) Chicken, Fish, Beef, Soda, Mango Juice, Orange juice  
The following are the combinations for the drinks and food.  
Chicken, mango juice; Chicken, Soda; Chicken, orange juice  
Beef, soda; Beef, mango juice; Beef, orange juice  
Fish, mango juice; Fish, orange juice; Fish, soda  
There are 9 combinations in total for the foods and drinks without repetition.
- b) Blue shirt, Green shirt Then Blue trousers, black trousers, and khaki trousers  
The following are the combinations for dressing.



Blue shirt, blue trousers; Blue shirt Khaki trousers; Blue shirt, black trousers

Green shirt, blue trousers; Green shirt, Khaki trousers; Green shirt, black trousers.

There are 6 combinations in total.

2.

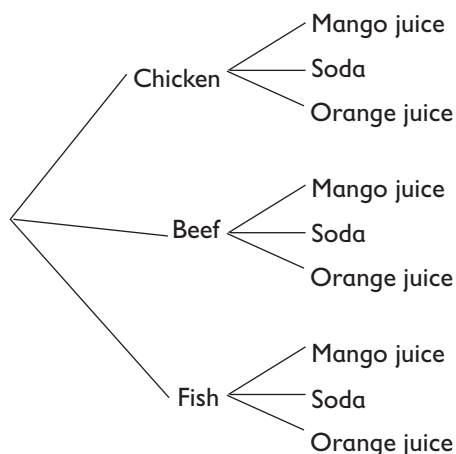

From the tree diagram, it can clearly be seen that each food type can go with three combinations of drinks. We have a total of 9 combinations on counting, i.e.

Chicken, mango juice; Chicken, Soda; Chicken, orange juice

Beef, soda; Beef, mango juice; Beef, orange juice

Fish, mango juice; Fish, orange juice; Fish, soda

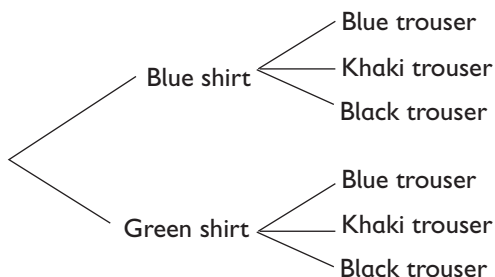

Each shirt has got three trouser combinations making a total of 6 combinations i.e.

Blue shirt, blue trousers; Blue shirt Khaki trousers; Blue shirt, black trousers

Green shirt, blue trousers; Green shirt, Khaki trousers; Green shirt, black trousers.

3. A tree diagram is easy to use when determining the total number of outcomes.

### 11.3 Determining probability by using tree and Venn diagrams

#### 11.3.1 Use of tree diagrams to determine probability.

By the end of this lesson, learners should be able to determine the probability using tree diagrams.

**Materials:** Coins, playing cards, spinning disks with numbered sectors, dice

#### Teaching guidelines 11.3.1

- Organise the learners in groups of three learners.
- One learner should work as the secretary and another should work as group leader
- Let the learners do activity 11.3 from learners book page 221.
- Let the learners present their findings in class discussion through their group leaders.
- Remind the learners how probability can be determined by using tree diagrams already discussed in previous lesson.
- Do examples 11.5, 11.7 in learners book page 221-224. To make sure that learners have understood the concepts.

- Let the learners do exercise 11.3 on page 223-224 from question 1-4.
- As you move around the class marking the work, identify slow learners and give them much help. Let the quick learners continue with the rest of exercise and the slow learners do the exercise as home work.
- Summarise the lesson by talking about the most important points.
- This lesson will promote;
  - (i) Critical thinking
  - (ii) Problem solving skills
  - (iii) Leadership skills among other competences

### Answers to activity 11.3 learners book page 221

Define O=orange, M=mango, A=Apple

a) Probability of orange followed by

$$\text{Apple is } \frac{3}{9} \times \frac{2}{8} = \frac{6}{72} = \frac{1}{12}$$

b) Probability for two oranges is

$$\frac{3}{9} \times \frac{1}{8} = \frac{2}{72} = \frac{1}{36}$$

c) Probability for a mango and an apple irrespective of the order is

$$\frac{2}{9} \times \frac{4}{8} + \frac{4}{9} \times \frac{2}{8} = \frac{1}{9} + \frac{1}{9} = \frac{2}{9}$$

### 11.3.2 Determining probability using Venn diagrams

By the end of this lesson, learners should be able to determine probability using Venn diagrams

**Materials:** Chalk, exercise books, calculators, objects like sweets that can be used in sets.

### Teaching guidelines 11.3.2

- Organise the learners in groups of three learners.
- One learner should be the group leader and another should be the secretary.
- Let the learners do activity 11.4 in learners book page 224.
- Allow the group leaders to present their findings through group discussions.
- Use the opportunity to explain fully the meaning of a Venn diagram as explained in learners book. Do examples 11.8, 11.9 and 11.10 on page 225-226 for the learners and to help them master the concepts.
- Allow the learners to do exercise 11.4 on page 224 in learners book from question 1-4.  
Move around marking their work and identify slow and quick learners.
- As you are helping slow learners, quick learners can proceed to do the rest of the exercise. Slow learners can do the rest of the exercise as homework.
- Conclude the lesson by giving more important concepts.
- This lesson will promote;
  - (i) Critical thinking
  - (ii) Problem solving skills
  - (iii) Environmental awareness
  - (iv) Leadership skills

**Answers to activity 11.4 learners book page 224**

1. Let represent those who play both games

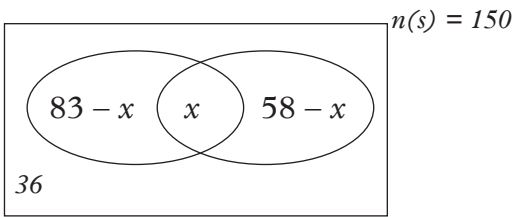

By solving for the value of

$$83 - x + x + 58 - x + 36 = 150$$

$$177 - x = 150$$

$$x = 27$$

Those who play both games are 27.

Probability that a person chosen at random plays both games is

$$\frac{27}{150} = \frac{9}{50}$$

2. Define M= Matoke, S=Sweet potatoes, P=Posho

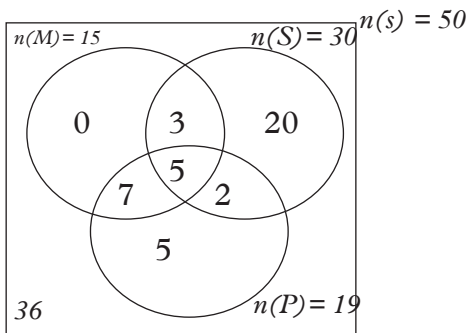

Those who don't eat any are

$$50 - (3 + 20 + 5 + 2 + 7 + 5) = 50 - 42 = 8$$

Probability that a person does not eat any is  $\frac{8}{50} = \frac{4}{25}$

3. Without using a Venn diagram, it is too difficult to determine 1 and 2

**11.4 Mutually exclusive events**

By the end of this lesson, learners should be able to understand the meaning of mutually exclusive events and solve problems involving the events.

**Materials**

Chalk, exercise books, calculators, dice, playing cards

**Teaching guidelines 11.4**

- Let the learners be organized in groups
- One learner should work as the secretary.
- Let the learners do activity 11.5 in learners book page 228.
- Let the learners present their findings through group secretaries.
- Use this opportunity to explain deeply the meaning of mutually exclusive as explained in learner's book page 228.
- Mutually exclusive events is where occurrence of one event excludes the occurrence of the other one.  
 $P(A \text{ or } B) = P(A) + P(B)$
- Do examples 11.11, 11.12 and 11.13 on page 228-229 in learners book to make learners master the concepts.
- Let the learners do Exercise 11.15 from learners book page 229-230.
- Correct their errors and guide the slow learners appropriately.
- Conclude the lesson by giving summary about important facts.

- This lesson will promote;
  - (i) Critical thinking
  - (ii) Leadership skills
  - (iii) Problem solving skills

### Answers to activity 11.5 learners book page 228

- A bus can never be Isuzu and Scania model at the same time.
- Probability Isuzu is  $\frac{20}{50} = \frac{2}{5}$
- Probability Scania is  $\frac{15}{50} = \frac{3}{10}$
- Probability Isuzu or Scania is  $\frac{2}{5} + \frac{3}{10} = \frac{9}{10}$
- The probability of getting Scania or Isuzu is obtained by adding the two probabilities in (b) and (c). Since a bus cannot be both Isuzu and Scania, the (d) combines mutually exclusive events.

### 11.5 Independent Events

By the end of the lesson, learners should be able to understand and solve problems involving independent events.

#### Materials

Chalk, exercise books, calculators, dice, playing cards, spinning disks with numbered sectors

#### Teaching guidelines 11.5

- Organise the learners in pairs
- One should be the secretary
- Let the learners do activity 11.6 in learners book page 230.
- Let the learners present their findings through group secretaries in a class discussion.

- Use the opportunity to explain the meaning of the term independent events as explained in learners book.
- Independent events are events where two or more events can take place at the same time without one affecting the occurrence of the other.

$$P(A \text{ and } B) = P(A) \times P(B)$$

- Let the learners understand more concepts through examples 11.14, 11.5 and 11.16 in learners book page 230-232.
- Allow the learners to also attempt examples 11.17 to ensure that they master the concept fully.
- Learners should do Exercise 11.6 on page 232-233 in learners book from question 1 to question 5. Mark their work and correct their errors
- Give the rest of the exercise as homework
- Summarise the lesson by giving highlights of the important facts under independent events.
- Let them discuss unit summary and ask them to do unit 11 test on page 234-235
- This lesson will promote;
  - (i) Critical thinking
  - (ii) Leadership skills
  - (iii) Communication skills

### Answers to activity 11.6 learners book page 230

- A head and a six can be obtained at the same time.  
The outcomes when a coin and a die are tossed are

- b) Probability of getting a head is  
 $P(H) = \frac{1}{2}$
- c) Probability of obtaining head and six  
is  $P(6) = \frac{1}{6}$

- d) Probability  $P(H6) = \frac{1}{12}$
- e) The probability  
 $P(H6) = P(H) \times P(6) = \frac{1}{2} \times \frac{1}{6} = \frac{1}{12}$   
which is got by multiplying individual  
probabilities in (b) and (c).

# Answers

## Exercise 11.1

(Learner's book page 219)

1. a)  $\frac{1}{2}$    b)  $\frac{2}{5}$    c)  $\frac{9}{20}$

2.

Number on black die	Number on white die					
	1	2	3	4	5	6
1	(1,1)	(1,2)	(1,3)	(1,4)	(1,5)	(1,6)
2	(2,1)	(2,2)	(2,3)	(2,4)	(2,5)	(2,6)
3	(3,1)	(3,2)	(3,3)	(3,4)	(3,5)	(3,6)
4	(4,1)	(4,2)	(4,3)	(4,4)	(4,5)	(4,6)
5	(5,1)	(5,2)	(5,3)	(5,4)	(5,5)	(5,6)
6	(6,1)	(6,2)	(6,3)	(6,4)	(6,5)	(6,6)

a)  $\frac{1}{9}$    b)  $\frac{1}{18}$    c)  $\frac{1}{36}$

3.  $\frac{1}{12}$

4. a)  $\frac{1}{2}$    b)  $\frac{1}{2}$

5. 0.7

## Exercise 11.2

(Learner's book pages 220-221)

1.

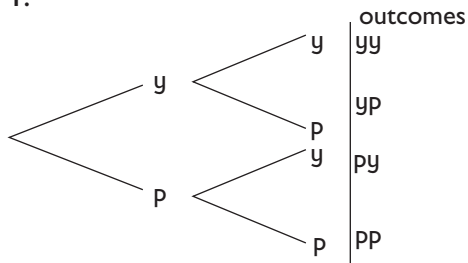

There are 4 outcomes.

2. There are 8 outcomes

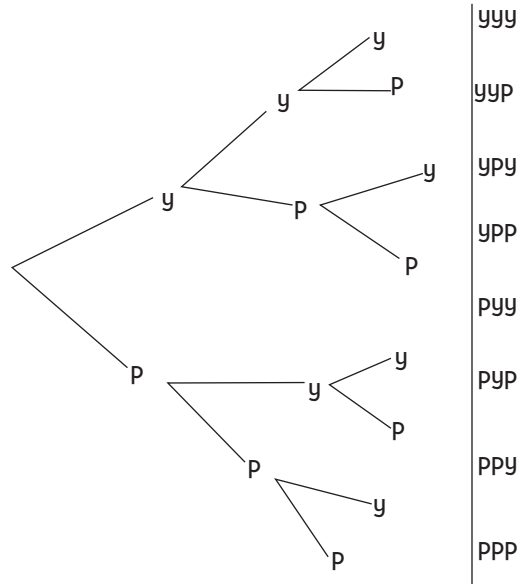

3.

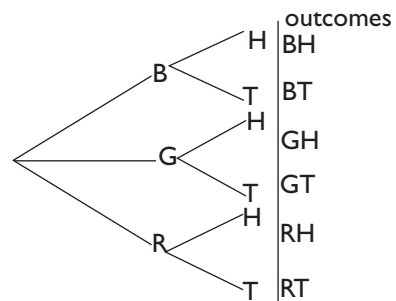

There are 6 outcomes

4.

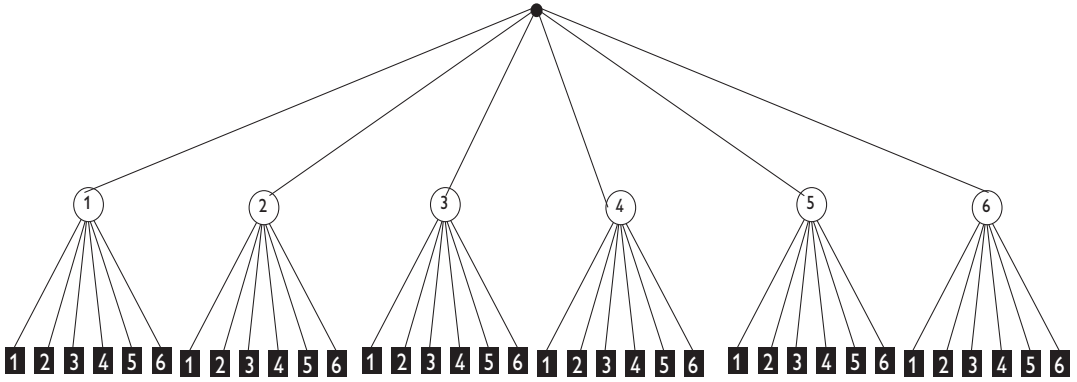

There are 36 outcomes.

5.

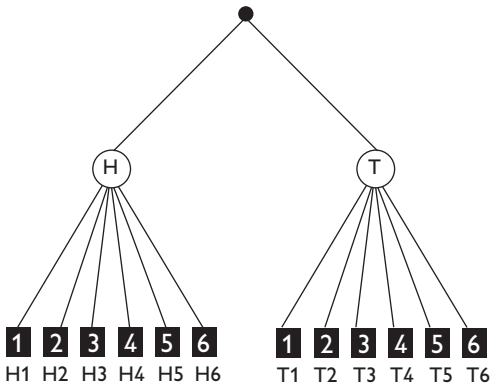

There are 12 outcomes

6.

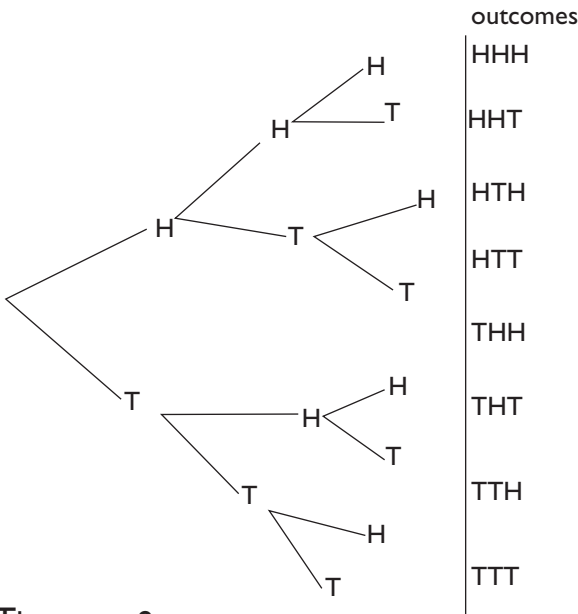

There are 8 outcomes

7. a) 8 outcomes for 3 times

b) 16 outcomes for 4 times

32 outcomes for 5 times

$2^n$  Outcomes for n times.

8. Let the bulbs be 1, 2 and 3. And let D represent defective, G represent good.

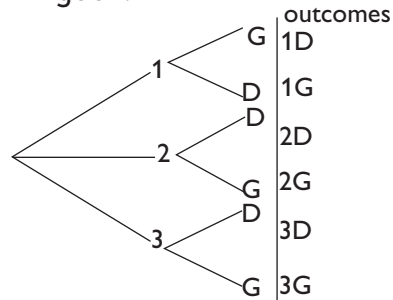

• We have 6 outcomes.

9. Define M= motorbike, C=car, S=start, F=Fail to start.

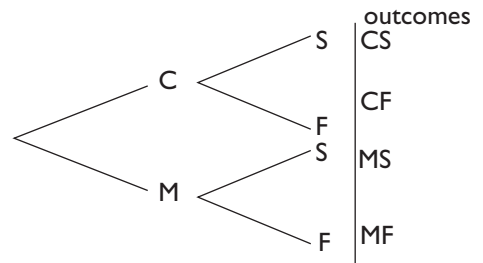

There are 4 possible outcomes

10. Let Y=Yellow and P= pink

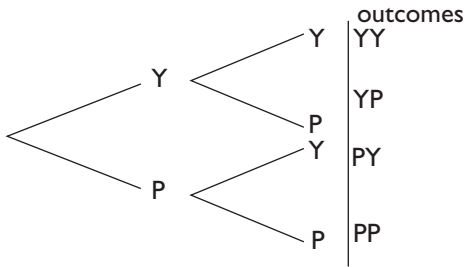

There are 4 possible outcomes

**Exercise 11.3**

(Learner's book pages 223-224)

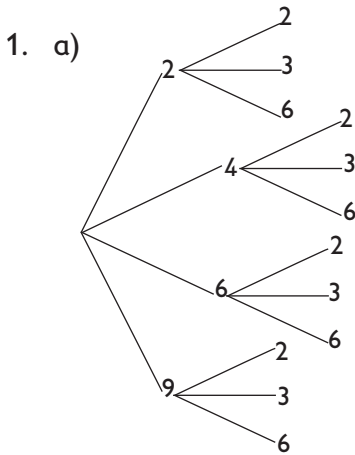

- b) i)  $\frac{5}{6}$     ii)  $\frac{1}{2}$     iii)  $\frac{1}{12}$   
 iv)  $\frac{5}{6}$     v)  $\frac{1}{2}$

2. i)  $\frac{1}{4}$     ii)  $\frac{1}{3}$     iii)  $\frac{5}{12}$

3. The tree diagram is as below

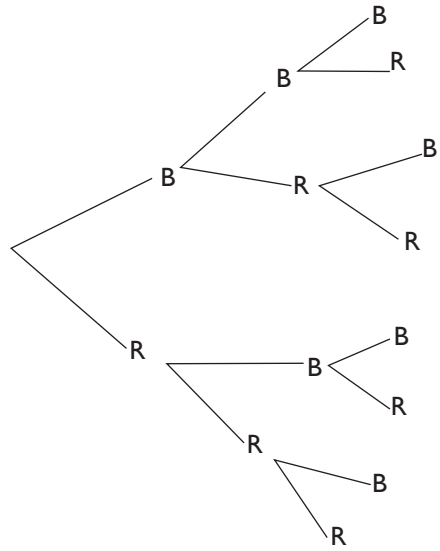

- i)  $\frac{1}{2}$     ii)  $\frac{1}{8}$   
 4. i)  $\frac{1}{4}$     ii)  $\frac{1}{4}$   
 5. i) The tree diagram is as below;

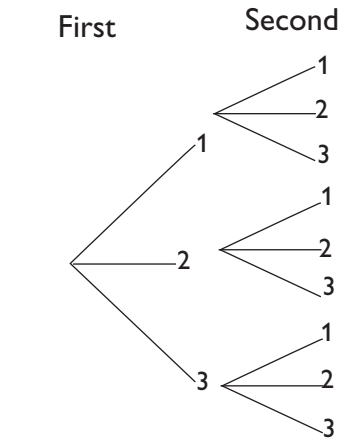

- 11), (12), (13), (21), (22), (23), (31), (32), (33)
- ii)  $\frac{1}{3}$     iii)  $\frac{5}{9}$



6. a) The tree diagram is as below

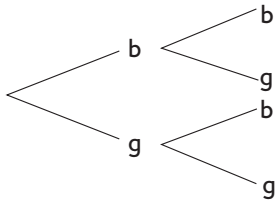

b) i)  $\frac{3}{4}$     ii)  $\frac{3}{4}$     iii)  $\frac{3}{4}$

7. a)

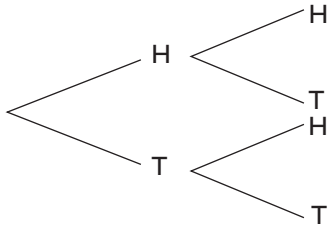

b)

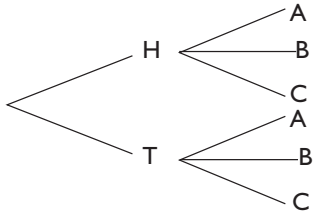

c)

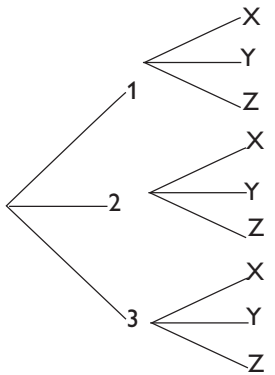

d)

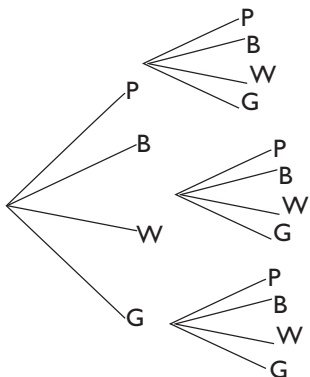

### Exercise 11.4

(Learner's book page 227)

1. a)

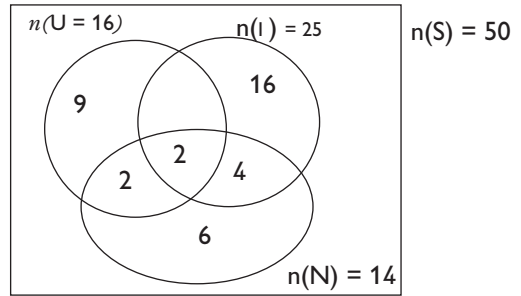

b) i)  $\frac{21}{50}$     ii)  $\frac{31}{50}$     iii)  $\frac{8}{25}$

2. a)

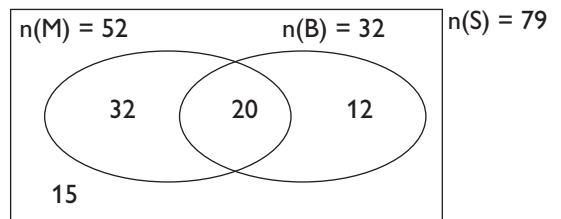

b) i)  $\frac{20}{79}$     iii)  $\frac{12}{79}$     iii)  $\frac{32}{79}$

3. a)

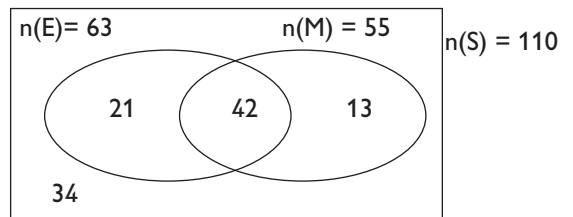

b)  $\frac{76}{110}$     c)  $\frac{13}{110}$

4.

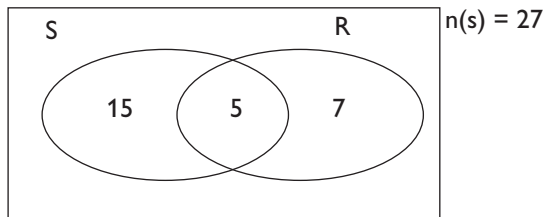

### Exercise 11.5

(Learner's book pages 229-230)

1. a)  $\frac{1}{4}$                       b)  $\frac{2}{5}$   
     c)  $\frac{3}{20}$                       d)  $\frac{7}{20}$   
     e)  $\frac{9}{20}$                       f)  $\frac{3}{4}$
2. a)  $\frac{5}{21}$                       b)  $\frac{13}{21}$
3. 0
4. a)  $\frac{5}{21}$                       b)  $\frac{7}{26}$
5.  $\frac{13}{24}$
6. a)  $\frac{1}{2}$     b)  $\frac{2}{3}$     (c)  $\frac{1}{3}$   
     (d)  $\frac{1}{5}$  The result of (c)=(b) and (a)=(d)

### Exercise 11.6

(Learner's book pages 232-233)

1. a)  $\frac{7}{15}$                       b)  $\frac{8}{15}$

2. a)  $\frac{1}{24}$                       b)  $\frac{36}{125}$
3. A,B and B,C are independent.

4. a)  $\frac{27}{125}$                       b)  $\frac{36}{125}$

5.  $\frac{1}{50}$

6.  $\frac{2}{3}$

7. 0.00833

8. a)  $\frac{1}{3}$                       b) 1

9.  $\frac{20}{39}$

10.  $\frac{1}{20}$

11. a)  $\frac{6}{7}$     b)  $\frac{36}{49}$     (c)  $\frac{216}{343}$

12. a) 0.0096    b) 0.8096

13. a) 0.56    b) 0.06    c) 0.14    d) 0.24

14. a)  $\frac{1}{8}$                       b)  $\frac{1}{8}$

15. a)  $\frac{1}{16}$                       b)  $\frac{15}{16}$

16.  $\frac{5}{8}$

# Unit 11 test

(Learner's book pages 234-235)

1. a)

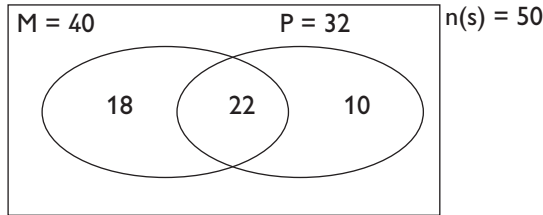

b) i)  $\frac{18}{50}$     ii)  $\frac{22}{50}$

2. a)  $\frac{28}{50}$     b)  $\frac{5}{50}$     (c)  $\frac{10}{50}$

3. a) H and S are mutually exclusive because a chocolate cannot be having hardcore centre and soft core centre at the same time.

9. a)

		Die one					
		1	2	3	4	5	6
Die 2	1	(1,1)	(1,2)	(1,3)	(1,4)	(1,5)	(1,6)
	2	(2,1)	(2,2)	(2,3)	(2,4)	(2,5)	(2,6)
	3	(3,1)	(3,2)	(3,3)	(3,4)	(3,5)	(3,6)
	4	(4,1)	(4,2)	(4,3)	(4,4)	(4,5)	(4,6)
	5	(5,1)	(5,2)	(5,3)	(5,4)	(5,5)	(5,6)
	6	(6,1)	(6,2)	(6,3)	(6,4)	(6,5)	(6,6)

b. i)  $\frac{1}{36}$     ii)  $\frac{4}{9}$     iii)  $\frac{10}{36}$     iv)  $\frac{6}{36}$     v)  $\frac{8}{36}$     vi)  $\frac{20}{36}$     vii)  $\frac{11}{36}$     viii)  $\frac{25}{36}$     ix)  $\frac{9}{36}$

b)  $P(H) = \frac{28}{50}$      $P(S) = \frac{1}{3}$   
 $P(H \cap S) = 0$      $P(H \text{ or } S) = 1$

5. 0.0491

6.  $\frac{1}{12}$

7.a)

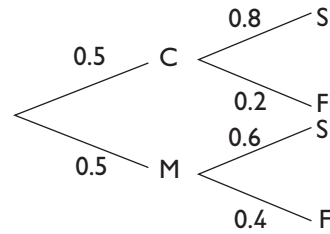

b) i) 0.7    ii) 0.4

8. a)  $\frac{7}{15}$     ii)  $\frac{7}{15}$     iii)  $\frac{7}{30}$

## REFERENCES

1. Rwanda Education Board (2015). Mathematics Syllabus for Ordinary Level Senior I-3, Kigali.
2. Allen R (2004). Intermediate Algebra for College Students, Pearson Education, Inc, New Jersey.
3. Richard E (1997). Algebra I, Addison – Wesley Publishing Company, Inc, Phillipines.
4. Engelsohn H., Feit J (1980). Basic Mathematics, Moriah Publishing, New York.
5. Mugo K., Maina L., Ondera J (2003). Excel and Suced Mathematics Form I, Longhorn Publishers, Nairobi.
6. Mugo K., Maina L., Ondera J (2003). Excel and Suced Mathematics Form 2, Longhorn Publishers, Nairobi.
7. Penguin Books Ltd (1998). The Penguin Dictionary of Mathematics, England.