

COMPUTER SCIENCE S6
STUDENT'S BOOK

Copyright

© 2022 Rwanda Basic Education Board

All rights reserved.

This book is the property of the Government of Rwanda.
Credit should be given to REB when the source of this book is quoted

FOREWORD

Dear Student,

Rwanda Basic Education Board is honoured to present Senior 6 Computer Science student book which serves as a guide to competence-based teaching and learning to ensure consistency and coherence in the learning of the Computer Science subject. The Rwandan educational philosophy is to ensure that learners achieve full potential at every level of education which will prepare them to be well integrated in society and exploit employment opportunities.

In line with efforts to improve the quality of education, the government of Rwanda emphasizes the importance of aligning teaching and learning materials with the syllabus to facilitate your learning process. Many factors influence what you learn, how well you learn and the competences acquired. Those factors include the relevance of the specific content, the quality of teachers' pedagogical approaches, the assessment strategies and the instructional materials available. We paid special attention to the activities that facilitate the learning process in which learners can develop ideas and make new discoveries during concrete activities carried out individually or with peers. With the help of the teachers, you will gain appropriate skills and be able to apply what you have learnt in real life situations. Hence, you will be able to develop certain values and attitudes allowing you to make a difference not only to your own life but also to the nation.

This is in contrast to traditional learning theories which view learning mainly as a process of acquiring knowledge from the more knowledgeable who is mostly the teacher. In competence-based curriculum, learning is considered as a process of active building and developing of knowledge and understanding, skills and values and attitude by the learner where concepts are mainly introduced by an activity, situation or scenario that helps the learner to construct knowledge, develop skills and acquire positive attitudes and values.

In addition, such active learning engages you in doing and thinking about what you are doing and you are encouraged to bring your own real experiences and knowledge into the learning processes. In view of this, your role is to:

- Develop knowledge and skills by working on given activities which lead to the content;
- Communicate and share relevant information with other learners through presentation, discussion, group work and other active learning techniques such as role play, case studies, investigation and research in the library on internet or outside;
- Participate to and take responsibility for your own learning;
- Carry out research/investigation by consulting printed/online documents and resourceful people, and present your findings;
- Ensure the effective contribution of each group member in assigned tasks through clear explanations and arguments, critical thinking, responsibility and confidence in public speaking;
- Draw conclusions based on the findings from the learning activities.

I wish to sincerely extend my appreciation to the people who contributed towards the development of this book, particularly REB staff who organized the whole process from its inception. Special appreciation goes to the teachers who supported the exercise throughout. Any comment or contribution would be welcome to the improvement



Dr. MBARUSHIMANA Nelson

Director General of REB



ACKNOWLEDGEMENT

I wish to express my appreciation to the people who played a major role in the development of this teacher's guide. It would not have been successful without active participation of different education stakeholders.

I owe gratitude to different universities and schools in Rwanda that allowed their staff to work with REB in the in-house textbooks production initiative. I wish to extend my sincere gratitude to lecturers and teachers whose efforts during writing exercise of this teacher's guide were very much valuable.

Finally, my word of gratitude goes to the Rwanda Basic Education Board staff who were involved in the whole process of in-house textbook writing.



Joan Murungi,

Head of CTRLR

TABLE OF CONTENT

FOREWORD	iii
ACKNOWLEDGEMENT	v
UNIT 1. COMPUTER SECURITY	3
1.1 Why computer security?	3
1.2 Computer threats	5
1.3 Computer attacks	6
1.4 Sources of virus and other attacks	16
1.5 Damage caused by Threats	18
1.6 Threats protection and precaution	19
END UNITY ASSESSMENT	36
UNIT 2. LAN ARCHITECTURE, NETWORK ROTOCOLS AND MODELS	41
2.1 LAN architecture	41
2.2 Cable Ethernet Standards	44
2.3 Fiber Distributed Data Interface (FDDI)	52
2.4 Network devices	56
2.5 computer Network Protocols	80
2.6 OSI model	84
2.7 TCP/IP model	90
END UNIT ASSESSMENT ACTIVITIES	98
UNIT 3: NETWORKING PROJECT	101
3.1 Build Peer to Peer network	101
3.2 Wireless Router installation and configuration	114
3.3 Building Client/Server network	121
End unit activity	131
UNIT 4: SQL AND DATABASE PROJECT	135
4.1 Relational algebra and relational calculus	136
4.2 Structured Query language	152
4.3.Database security concept	195
END UNIT ASSESSMENT	207
UNIT 5: ARRAYS, FUNCTIONS AND PROCEDURES IN VISUAL BASIC	215
5.1. ARRAYS	216

5.2. FUNCTIONS IN VB	227
END UNIT ASSESSMENT	252
UNIT 6. VISUAL BASIC PROJECT	255
6.1. PROJECT 1: REQUIREMENT ANALYSIS AND PROJECT PLANNING	255
6.2. PROJECT2: FRONT END USER INTERFACE IN VISUAL BASIC	263
6.3. PROJECT 3: BACK END DATABASE	264
6.4. PROJECT 4: CONNECTING A VISUAL BASIC 6.0 PROJECT TO A DATABASE (ODB	265
6.5. PROJECT 5: DAO, RDO AND ADO OBJECTS IN VISUAL BASIC	268
6.6. PROJECT 6: DATA CONTROLS, PROPERTIES AND DATA MANIPULATION AND CODING	272
6.7. PROJECT 7: PRINCIPLES FOR DESIGNING A FRIENDLY AND ERGONOMIC USER INTERFACE	281
UNIT 7: PROCESS MANAGEMENT AND SCHEDULING ALGORITHM	287
7.1 PROCESS	287
7.2. THREAD	293
7.3. PROCESS SCHEDULING	298
END OF UNIT ASSESSMENT	313
UNIT 8: FILE MANAGEMENT	319
8.1. Understanding computer file	320
8.2. FILE TYPE	333
8.3. FILE ACCESS MECHANISMS	337
8.4. FILE SPACE ALLOCATION	341
8.5. END UNIT ASSESSMENT	344
UNIT 9: MEMORY MANAGEMENT	347
9.1. UNDERSTANDING COMPUTER MEMORY	348
9.2. LOGICAL AND PHYSICAL ADDRESS MEMORY SPACE	354
9.3. ALLOCATING AND PLACING PARTITIONS IN MEMORY	358
9.4. MEMORY FRAGMENTATION	364
9.5. VIRTUAL MEMORY CONCEPTS	369
UNIT 10: COLLECTIONS IN JAVA	379
10.1.INTRODUCTION TO THE COLLECTION FRAMEWORK	379
10.2 Java - The collection interfaces and Classes	381

END UNIT ASSSSMENT	425
UNIT 11: JAVA ENTERPRISE WEB APPLICATIONS	429
11.1 Tomcat	429
11.2. Installation and configuration of tomcat configuration directory	432
11.3 Hypertext Transfer Protocol (HTTP) request / response	444
11.4 Web application	447
11.5. A Uniform Resource Locator (URL)	456
11.6. Project creation	459
11.7 Java Server Pages	475
11.8 tandard Tag Library (JSTL)	485
11.9 Java Database Connectivity (JDBC) connection	492
End unit assessment	509
UNIT 12. INTRODUCTION TO COMPUTER GRAPHICS	513
12.1 Definition of Computer graphics terms	513
12.2 Images capturing tools	520
12.3 Computer-Aided Design	527
12.4 Graphics software, features and editing tools	529
12.5 Basic Graphic elements	550
END UNIT ASSESSMENT	554
UNIT 13: MULTIMEDIA	559
13.1. INTRODUCTION TO MULTIMEDIA	559
13.2. Interactive multimedia	564
13.3. Creating action buttons	570
13.4. Digital Audio recording and Editing	574
13.4. Digital Video recording and editing	590
End unit assessment	609
UNIT 14: FILE HANDLING IN C++	613
14.1. Understanding files	613
14.2. File Streams	617
Summary	639
BIBLIOGRAPHY	643



UNIT 1

COMPUTER SECURITY

UNIT 1. COMPUTER SECURITY

Key Unit Competency: To be able to enumerate various security threats and ensure security of computer.

INTRODUCTORY ACTIVITY

A. Apply the following scenario.

1. In the school computer lab, some computers have been damaged by humidity, some computer screens that have been broken and other computers are not password protected. In groups, respond to the following questions. What is wrong with such A computer lab?
2. Identify the risks of an unsecured computer
3. Describe how this computer lab can be secured
4. Describe how data stored in a computer can be protected
5. What are the measures that can be considered to protect the computer lab physically and logically?

Describe what you see on the picture bellow.

1. Is this computer lab well organized?
2. Identify the security risks.
3. Propose solutions to improve the security of material inside this computer lab

1.1 Why computer security?

ACTIVITY 1.1

Visit the school computer lab and answer the following questions?

1. In the school computer lab, are all computers secured? If yes, describe how they are secured. If not, what to do to enhance the security of computers?
2. Describe the simple measures that can be taken to protect the computers in the school computer lab

Introduction

Nowadays, computers become an indispensable tool in the life of human beings. They are used in banking, in shopping, in communicating between people through emails and chats, etc. However, some intruders are joining the conversations and try to read emails of others without permission. Most of the time, they misuse their computers by attacking other systems, sending forged emails from computers, or examining personal information stored in others' computers.

Computer security refers to techniques developed to safeguard information and systems stored on computers.

The protection of data (information security) is important. It reduces the probability of hardware and software problems and it increases the security of data stored in computers.

Why is computer security important?

Computer security is important for many reasons:

Computer security helps to keep safely data and equipment functioning properly and provide access only to appropriate people.

Computer security prevent unauthorized persons to enter in others computers without their consents.

Computer security helps to keep healthily computers against viruses, malware and other unintentional softwares that can prevent computers to run smoothly.

Computer network need to be protected because Cyber criminals, hackers, and identity thieves present real and dangerous threats to any online system.

APPLICATION ACTIVITY 1.1

1. By using simple words, define computer security?
2. In pairs, discuss and write a brief report on importance of computer security at your school, in Rwanda and in the whole world.
3. Write down some cases of computer security break that have happened in Rwanda and in the world?

1.2 Computer threats

LEARNING ACTIVITIES 1.2

A hard disk is connected into a broken computer system case like the one below. When the computer is switched on, it shows that something is wrong. The user cannot work on it properly. It is very difficult to send a document to hard disk.

1. Describe what is happening to make the computer not functioning correctly.
2. Propose solutions to this problem

1.2.1 Threat definition

A threat, in the context of computer security, refers to anything that has the potential to cause serious harm to a computer system. A threat is an activity/ attack/ situation that may happen, with the potential to cause serious damage. Threats can lead to attacks on computer systems, networks and more.

1.2.2 Threat categories

Knowing how to identify computer **security** threats is the first step in protecting a computer. The **threats** could be intentional, accidental or caused by natural disasters. Computer threats are categorized in two categories; **physical threats** and **logical threats**:

Physical threats

Digital storage media and hardware are subject to numerous internal and external forces that can damage or destroy their readability. Below are some cases of physical threats:

- Improper storage environment (temperature, humidity, light, dust),
- Over use (mainly for physical contact media),
- Natural disaster (fire, flood, earthquake),
- Infrastructure failure (plumbing, electrical, climate control),
- Inadequate hardware maintenance,
- Hardware malfunction

Logical threats

Are events or attacks that remove, corrupt, deny access, allow access, or steal information from a computer without physical presence of somebody. These include viruses, worms, Trojans, spyware, adware, SQL injection etc.

Threats to information systems can cause:

- **Hardware failure:** A malfunction within the electronic circuits or electromechanical components (disks, tapes) of a computer system. Example: a CPU socket damaged.
- **Software failure:** The inability of a program to continue processing due to erroneous logic. Example: a crash of a computer program.
- **Electrical problems:** are faults caused by electric like a low-resistance connection between two points in an electric circuit through which the current tends to flow rather than along the intended path.
- **User errors:** is an error made by the human user of a computer system in interacting with it. Example: a system file deleted unintentionally by a user.
- **Telecommunication problems. Example:** when the antenna are not working
- **Program changes; modifications made to program. Example:** a simple modification in a program can affect the whole software.
- **Theft of data, software, services and equipment.** When a physical or logical component of a system is stolen, the whole system stops. Example: a computer cannot run without a RAM or cannot run with a corrupted software

APPLICATION ACTIVITY 1.2

1. Discuss the difference between logical and physical threats and give examples for each?
2. Explain the difference between hardware and software failure
3. Explain how a computer user can cause the errors to information system.
4. In the school computer lab, take one computer and remove the RAM. What is happening to the system?
5. After analyzing the school computer lab, enumerate the different threats that are existing with the computer

1.3 Computer attacks

LEARNING ACTIVITY 1.3.

Suppose that yesterday when students were using computers in the school computer lab, everything worked well. They brought from outside different storage devices like flash disks and external hard disks used to copy various documents to the computers. Today morning, when the Lab attendant switched on the computers, most of them displayed suspected messages.

Discuss in groups what may be the cause of such behaviors. How the problem can be addressed in the laboratory?

In computer and computer networks an attack is any attempt to expose, alter, disable, destroy, steal or gain unauthorized access to or make unauthorized use of an asset. An attack can be active or passive.

An “active attack” attempts to alter system resources or affect their operation.

A “passive attack” attempts to learn or make use of information from the system but does not affect system resources.

The different kinds of attacks are summarized in the following image:

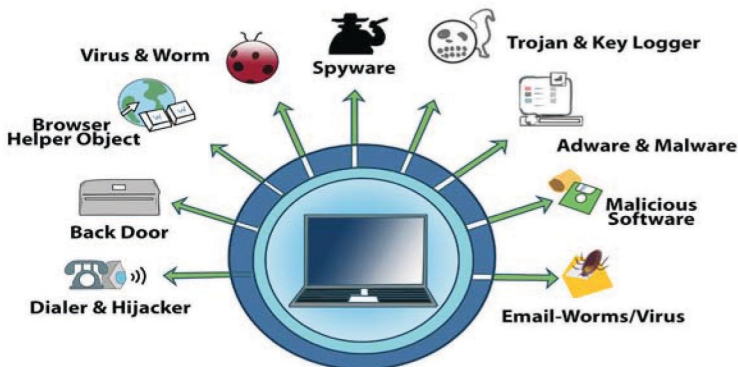

Picture 1.1: different types of computer threats

Source: <https://svtechworld.in/potential-security-threats-to-your-computer-systems/>

However, the frequent computer attacks are virus, worms, Trojan, spyware, Shoulder Surfing, Denial-of-Service, eavesdropping, social engineering and cybercrimes

1.3.1 Virus

A virus is a self-duplicating computer program or piece of code that is loaded onto a computer without the user's knowledge and runs against his/her wishes. Viruses can spread themselves from computer to computer, interfering with data and software. A virus is attached to small pieces of computer code, software, or documents. The virus executes when the software is run on a computer. If the virus is spread to other computers, those computers could continue to spread the virus.

Some viruses work by hiding on the first sector of a disk and loaded into memory. Other viruses insert themselves onto program files that start applications. Those files have the extension of **.exe and .com** the last category of viruses are viruses which infect programs that contain powerful macro languages like programming languages.

The common viruses are:

a. Worms

A worm is a computer program that sits in the computer memory, duplicates itself continuously until the system runs out of memory and crashes. Worms infect networks by replicating themselves and transmitting their multiple copies to all the nodes connected on the network.

b. Trojan

A Trojan may appear to be something interesting and harmless, such as a game, but when it runs it may have harmful effects. Unlike worms, Trojans do not replicate themselves but they are destructive.

Trojan are used by hackers to gain access into a machine without the permission of the user.

Normally when someone visits some websites which are malicious in nature, the trojan gets downloaded or may come from an infected source.

The Trojan gets installed in the computer and later on helps the hackers to gain access into that computer.

1.3.2 Denial of Service (DoS)

When a denial of service (**DoS**) attack occurs, a computer or a network user is unable to access resources like e-mail and the Internet. An attack can be directed at an operating system or at the network.

1.3.3 Spyware

Just like virus, Spyware also comes under that category of malware attacks, which means that it is a code or program written for doing some damage to the computer.

Although the working of spyware is different from the other types of malware mentioned, Spyware as the name suggests is used to spy into a system. The job of the spyware is to silently sit inside the host system and observe the activities of the system.

It may also come from other sources like detachable storage devices. Spyware sits quietly in the system and copies all the relevant information being input and processed.

Example of how spyware work:

Suppose a user is logging on to any bank.

Once the website of the bank opens, the user id and login password is input.

After that if the user wants to do a financial transaction, the transaction password has to be entered. All this information is quietly registered by the spyware. Then the spyware sends all the information recorded from the user's computer to its parent i.e. probably a hacker somewhere on the Internet. The information may be transmitted even while the user is using the system.

Once the hacker has the user's information, like bank name, login id and password, nothing can stop him/her from transferring the money from that account to anywhere else.

APPLICATION ACTIVITY 1.3a

1. What is a computer attack? Differentiate active attack to passive attack.
2. Explain the difference between worms and Trojan
3. Explain briefly how virus are categorized?

1.3.3 Social Engineering

A Social Engineer is a person who is able to gain access to equipment or a network by tricking people into providing him/her the necessary access information. Often, the Social Engineer gains the confidence of an employee and convinces him/her to divulge username and password information.

A Social Engineer may pose as a technician to try to gain entry into a facility. Once inside, he/she may look over shoulders to gather information, seek out papers on desks with passwords, or obtain a company directory with e-mail addresses.

So, Social Engineering is a technique/method used by someone by trying to socialize with someone else with the purpose of picking/getting his/her credentials or user name and password with intention to use them during his/her absence. A user never feels that revealing his/her credentials to someone that he/she trusts is wrong.

Example:

- A husband gives his credentials to her wife and vice versa.
- An Administrative Assistant gives his/her credentials to his/her boss.
- Etc

1.3.4 Shoulder Surfing

In computer security, shoulder surfing is a type of social engineering technique used to obtain information such as personal identification number, password and other confidential data by looking over the victim's shoulder. This attack can be performed either from a closer range by directly looking over the owner of information.



Picture 1.2 Someone can watch the keys you press when entering your password

1.3.5 Eavesdropping

Eavesdropping refers to the unauthorized monitoring of other people's communications. It can be conducted on ordinary telephone systems, emails, instant messaging or other Internet services.

1.3.6 Cybercrimes

Cybercrime, also called computer crime, is any illegal activity that involves ICT tools such as a computer or network-connected device, such as a mobile phone.

Different types of cybercrimes:

- **Cyberbullying**

Cyberbullying is bullying that takes place using electronic technology. Electronic technology includes devices and equipment such as cell phones, computers, and tablets as well as communication tools including social media sites, text messages, chat, and websites.

Examples of cyberbullying include text messages, rumors sent by email or posted on social networking sites, and embarrassing pictures, videos, websites, or fake profiles, posting hurtful images, making online threats, and sending hurtful emails or texts.

Example: when someone tweets or posts on social media:

Today, the president of United States resigns because he failed to supply laptops in schools.

- **Sexting**

Sexting is the sending and receiving of text, photo or video messages of children and young people that are inappropriate and sexually explicit.

These images are mostly self-generated and shared through mobile phone MMS, Skype and social networking sites where images can be posted and shared such as Facebook, WhatsApp, Twitter, Tumblr, Flickr, YouTube, Instagram, Snapchat etc.

- **Grooming**

“Grooming” is the way sexual predators get from bad intentions to sexual exploitation. Sometimes it involves flattery, sometimes sympathy and other times offers of gifts, money, transportation, or modeling jobs.

1.3.7 Website hacking

1.3.7.1 Definitions

Hacking

Hacking is a term used to describe actions taken by someone to gain unauthorized access to a computer belonging to other people. It is the process by which cyber criminals gain access to your computer. After entering in that computer, a hacker can find weaknesses (or pre-existing bugs) in the security settings and exploit them in order to access available information. He/she can also install a Trojan horse, providing a back door for hackers to enter and search for your information.

1.3.7.2 Website hacking techniques

Most of the information belonging to different individuals or institutions either private or public bring attention of outsiders who may want to break inside. The use of this information differ according to the interest of its users. The owners or administrators of websites should then put in place measures to protect their information and the users. There exist different techniques used by hackers and hence, there are many tools to deal with many kinds of theft and protect the websites.

Rwanda Information Society Authority (RISA) has pledged stronger cooperation

with the public in enhancing cyber security for all computers in Rwanda amid an alert over an outbreak of a security attack that has affected over 150 countries. According to a statement, the cyber security attack is known as ransomware and bears different variations like WannaCrypt, WannaCry, WannaCryptor or Wcrya. The broad based ransomware attack has appeared in at least eight Asian nations, a dozen countries in Europe, Turkey and the United Arab Emirates and Argentina and appears to be sweeping around the globe, researchers said. The cyber-attack mostly affects computers that run Microsoft Operating Systems, by automatically encrypting the files and blocking the user's access to the entire system. Over the last decade Rwanda's strong growth through ICT promotion has brought untold opportunities and prosperity in the country. And as we globally face this challenge in cyber security, as a country we strongly believe that an integrated strategy to ensure effective regulation to our cyber security is significant at this point.

To mitigate this outbreak, RISA gave a set of actions to ensure lasting national prevention and protection:

1. Users are required to maintain daily backups of critical data including application, databases, mails systems, and user's files. Backups should be regularly tested for data restoration.
2. All computers should be installed with latest security updates (specifically including MS17-010. Patch)
3. Until the security patch is applied, the Server Message Block v1 (SMB v1) should be disabled on all computers.
4. The LAN perimeter firewall should be configured with a rule to block all incoming SMB traffic on port 445.
5. All computers should be upgraded to Windows 10 to benefit from the latest protection from Microsoft. The Windows Defender Antivirus, which can detect the above malware, should also be enabled on all Windows systems.
6. Ensure your Antivirus signatures are up to date as major vendors are all working to deliver updated signatures to detect/ prevent this.
7. All users are advised not to open any suspicious email especially one that has an attachment, furthermore all users are advised not to download any files that they are not sure of the source.

Comprehensive action to strengthen our information and communication

technology sector countrywide is taken. However, in case of any compromise or attack, RISA advises that the affected computer/PC must be removed from the network and the incident must also be reported to Rwanda Computer Security Incident Response team with immediate effect.

WannaCry exploited a vulnerability in the Windows operating system and was among a large number of hacking tools and other files that a group known as the Shadow Brokers released on the internet. Shadow Brokers said that they obtained it from a secret NSA server.

The identity of Shadow Brokers is unknown though many security experts believe the group that surfaced in 2016 is linked to the Russian government.

1.3.8 Unwanted content

During the use of internet, some webmasters through the usage of cookies and other applications had managed that when someone is navigating in a given website, unwanted webpages are opened. This happens mostly for advertising of other products or services rendered by other institutions or companies that contracted the webmasters. Or, it happens by itself with malicious software.

1.3.9 Pornography and violence

1.3.9.1 Pornography

These are images and video whose focus is on n sex or sexual arousal either directly or indirectly. In that group of videos, many films on pornography are produced and sold all over the world. This kind of films hurts adults, children, couples, families, and society.

Families, Non-Government Organizations and government institutions in charge of education and social welfare need to fight seriously against tis malpractice which addict our society and hence affect the whole development.

In Rwanda, the institutional and national ICT policies contain articles prohibiting to watch pornographic film in offices. The selling of these films is also officially banned.

1.3.9.2 Cyber violence

Cyber violence is defined as online behavior that constitutes or leads to assault against the well-being (physical, psychological, emotional) of an individual or group.

What distinguishes cyber violence from traditional off-line forms of violence is that in the former case, some significant portion of the behavior takes place online, although it may even be carried out in offline contexts. There exist four basic types of cyber violence namely online contact leading to off-line abuse, cyber stalking, online harassment, degrading representations.

1.3.10. Hate media and unwanted content

The hate media is a form of violence, which helps to demonize and stigmatize people that belong to different groups of society. This type of media has incited haters among citizens and in some cases influenced most of the genocide that the world has known.

APPLICATION ACTIVITY 1.3 b

1. Which types of computer attacks had happened your school computer lab or in Rwanda or in sub region?
2. How to recognize that a document in a computer is infected by virus?
3. Explain what is social engineering in computer security;
4. Explain the difference between social engineering and Shoulder Surfing techniques;
5. Explain the different types of cybercrimes

1.4 Sources of virus and other attacks

LEARNING ACTIVITIES 1.4

In the school computer lab, when one student inserted a flash disk in one computer, he/she gets a virus detection message and all files are immediately deleted and the flash disk becomes empty

Another student discovers that when he/she opens a document in my MS Word, the content is displayed in unknown characters.

The last students gets a message that looks like the one below:

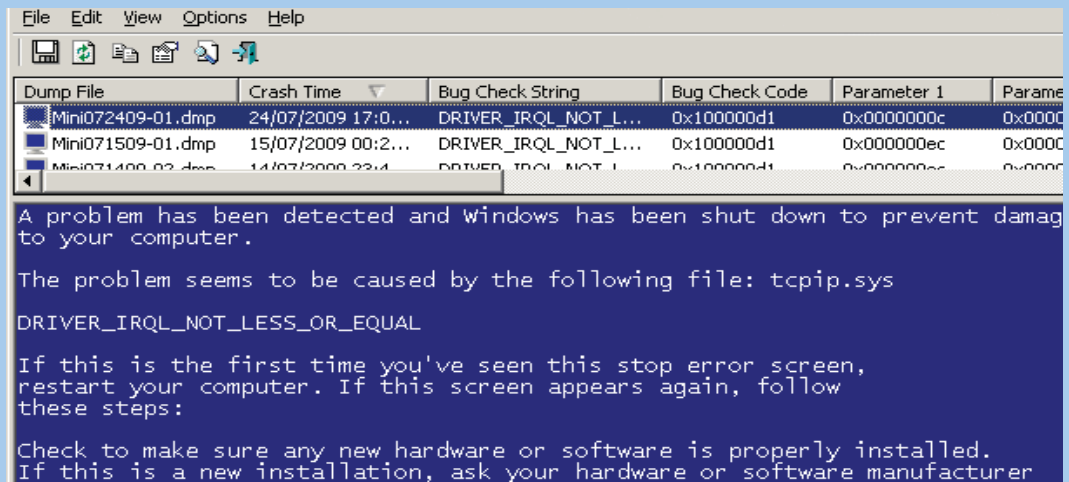

Picture 1.4: Wrong message interface

In groups, discuss what should be the causes for such problems.

Source of viruses

Virus infection in computers can be contacted through different means. Below are the common causes of computer virus attack.

A. Internet

It can not be denied that internet is one of the common sources of virus infection. This fact is not a real surprise and there is no point to stop using internet henceforth. Majority of all computer users are unaware as when viruses attack computer systems. Almost every computer user click/download everything that comes their way and therefore, unknowingly, invites the possibility of virus attacks.

B. Downloadable Programs

One of the possible sources of virus attacks is downloadable programs from the web. Unreliable sources and internet newsgroups are one of the main sources of computer virus attacks. Downloadable files are one of the best possible sources of virus. Any type of executable program including games, freeware, screen savers as well as executable files are one of the major sources of computer virus attacks.

C. Cracked Software

Cracked Software proves to be yet another source of virus attacks. Most people who download cracked and illegal versions of software online are unaware of the reality that they may contain virus sources as well. Such cracked forms of illegal files contain viruses and bugs that are difficult to detect as well as to remove.

D. Email Attachments

Email attachments are one of the other popular sources of computer virus attacks. Hence, you must handle email attachments with extreme care, especially if the email comes from an unknown sender. Installation of a good antivirus is necessary if one desires to eliminate the possibility of virus attacks.

E. Removable media

Removable media such as CDs, USB flash disks,... can be a source of viruses when the files they contain which may have been taken from other electronic devices, have been infected.

F. Bluetooth Transfer

Viruses can be contacted through a transfer of documents via a Bluetooth, once one of the computers is infected with a virus or the document to be transferred is infected.

APPLICATION ACTIVITIE 1.4

1. Describe different ways of how internet is a virus source
2. Explain how CD is a source of virus in computer

1.5 Damage caused by Threats

LEARNING ACTIVITIES 1.5

From the previous lessons in this unit, different kinds of threats have been studied with their characteristics and their modes of contamination.

Discuss in groups the possible damages that they could cause in a computer, a school computer laboratory and in any network.

The consequences of the damages may vary according to the specific type of malware and the type of device that is infected plus the nature of the data that is stored on or accessed the device.

Whereas in some cases the results of a malware infection may be invisible to the user, in other cases the damage can have serious consequences.

Damages caused by threats:

Forhome users

- It can **infect a computer** if the user clicks on an infected banner or if he/she downloads and opens an attachment from a spam email or if he/she ends up on an infected website
- **Harvest user's data** and send it to cybercriminal servers to use it in future attacks
- **Destroy user's data**, it happens when the encryption key was not downloaded correctly and won't work when trying to decrypt your data
- **Hide from being detected by antivirus** products because of its communication mechanisms
- **Enlist your computer** in a botnet and use its resources to launch attacks on other victims.
- **Performance dropped when the user is not doing anything heavy.**

On corporate network

- **Web efacements and Semantic Attacks** are used to propagate false information by changing the web page content subtly.
- In **Domain Name Server (DNS) Attacks**, when the user requests for a

particular website to the DNS server, then he/she is diverted to an unwanted website because of a wrong Internet Protocol (IP) address generated by the DNS server (DHCP).

- **Distributed Denial of Service (DDoS) Attacks** involves high volume of communications to the targeted computers. It is the strategy that cyber attackers use to slow down those targeted computers.
- There are **compound attacks** whereby attackers can combine a number of attacks and make a series out of them which can destroy everything by leaving no possibility of recovery.

APPLICATION ACTIVITY 1.5

1. List and explain damages caused by virus in a computer system
2. List what damages caused by threats for home users
3. Enumerate other damages caused by virus that are not listed above
4. Use an example, explain how virus damage can reduce the production of any institution

1.6 Threats protection and precaution

ACTIVITY 1.6

In the school computer laboratory, to enter in a secured computer with password, someone needs to be given that password. If it has been forgotten, it becomes impossible to work with that computer. In groups, answer to the following questions:

1. What is the importance of login to computer with password?
2. List other security measures that can be used to protect a computer.
3. Explain how data stored in computer can be protected from damage?

As with any business asset, hardware, software, networks, and data resources need to be protected and secured to ensure quality, performance, and beneficial use.

They are four simple ways of protecting a computer:

1. To install antivirus software
2. To install firewall.
3. To install anti-spyware software.

4. To use complex and secure passwords.

Effective security measures can reduce errors, fraud, and losses.

1.6.1 Antivirus

i. Definition

Antivirus software are computer programs that attempt to identify, neutralize or eliminate harmful softwares. The term “antivirus” is used because the earliest lessons were designed to combat a wide range of threats, including worms, trojan and other malware. Antivirus software typically uses three different approaches to accomplish their tasks:

- The first way is to examine file looking like known viruses that match virus definition in virus dictionary
- The second way is to try and to recognize unusual behavior from a program which might signify a threat
- The last way is to prevent the execution of all computer codes which has not been identified as trustworthy

ii. Virus detection

An antivirus needs to scan the system in order to detect a security threat such as a virus. There exist 3 possible actions, depending to the user’s choice, when a virus has been found in a file:

- **Move to quarantine:** the infected file will be moved in protected repository. It will thus be inaccessible and the code of the virus will not be executed.
- **Repair/ Disinfect:** the antivirus can also try to repair an infected file, i.e. to remove the code of the virus from the file. This is needed especially for program files.
- **Delete:** in this case, if the infected file cannot be repaired, there is no other alternative rather than deleting it. It is especially useful when this file is not essential to system, especially if it is not a program file.

After scanning an internal or external storage device, a report is generated in form of an interface. An example is shown below.

iii. Anti-Virus installation

In this case Kaspersky 2017 is going to be used as an example of how to install an antivirus.

Before the installation of Kaspersky 2017 on a computer, the following preparation has to be made:

- Make sure that the software is on external storage device or on another computer is a network;
- Check if the computer meets the requirements of Kaspersky Anti-Virus 2017;
- Make sure no antivirus software of Kaspersky Lab or other vendors is installed on your computer;
- Check if there is any incompatible software, remove it;
- Close all running applications;

Check if it is Kaspersky Anti-Virus 2017 installation under Windows 10, then click on the Desktop tile on the start screen.

Standard Installation:

1. Download the installation file from Kaspersky Lab website and run it. Then, the user follows the instructions given by the system.
2. If the antivirus Kaspersky installation file is saved in another computer of the same network, connect to that computer and run the executive file from it or displace it using a removable storage. The instructions will be followed as in the point above
3. Insert the disc into the CD/DVD drive if it contains the Kaspersky installation file. If the installation does not start automatically, run the installation file manually. Click Install.
4. Read the License Agreement in the window that appear afterward by clicking on the respective link. Accept its terms to install the application. Respond to other windows that may display in halfway during the installation
5. Wait until installation is completed. Make sure the Start Kaspersky Anti-Virus check box is selected, then click **Finish**.

Updating an antivirus

As mentioned above, new viruses are created every day. But if an antivirus is not aware of the signature of the newly developed virus, it will not know it and this

enables the virus to attack the computer. It is important to regularly update the list of signatures of antivirus and if possible every day or at least after 3 days. These signatures are offered by the company which has developed the antivirus used. Signatures of viruses are kept in a database created by the company that created the antivirus. The steps to go through while updating an anti virus software depends on the type of that anti virus.

1.6.2 Anti spyware

Anti-spyware software is a type of program designed to prevent and detect unwanted spyware program installations and to remove those programs if installed. Detection may be either rule based or based on downloaded definition files that identify currently active spyware programs. Notice that most anti-virus software such as AVG contain inbuilt anti spyware software.

There exist many anti spyware software but the most popular are the following: AVG Anti Spyware, CheckFlow Anti Spyware 2005, CounterSpy, NoAdware, Avast and ScanSpyware

1.6.3 Firewall

Computers connected to communication networks, such as the internet, are particularly vulnerable to electronic attack because so many people have access to them. These computers can be protected by using firewall computers or firewall software placed between the networked computers and the network. The firewall examines, filters, and reports on all information passing through the network to ensure its appropriateness.

1.6.4 Parental Control

(Family Safety for any user)

The Parental Controls feature is a valuable tool for controlling the amount of time the children spend on the computer and the programs they're using. Parental controls can filter the web, blocking inadvertent access to inappropriate websites.

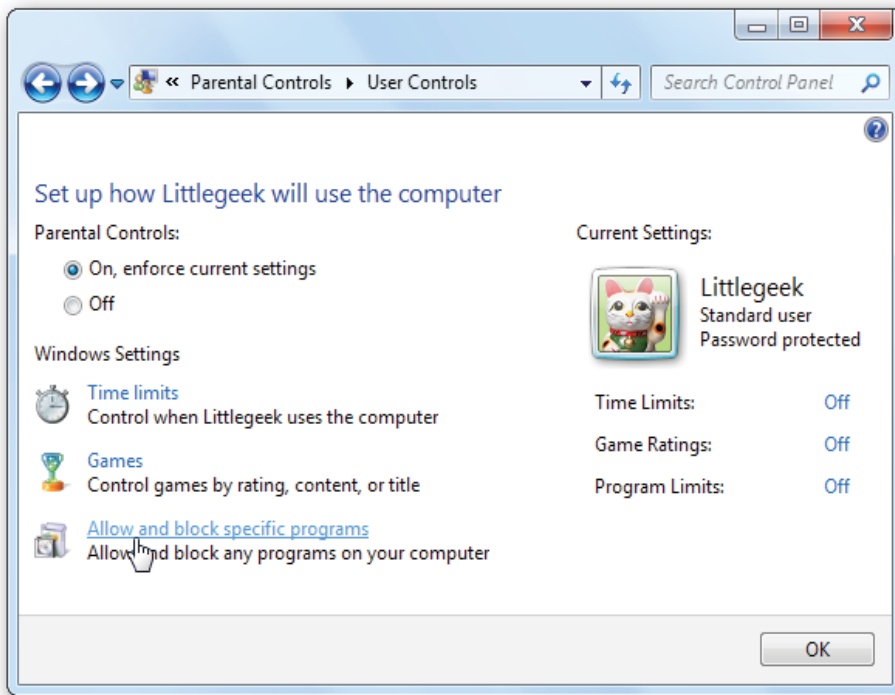

Picture 1.5: Windows 10 Parental Controls

1.6.5 Access control

Access control is a security technique that can be used to regulate who or what can view or use resources in a computing environment.

The access control model used by some operating systems ensures authorized use of its objects by security principles. Security principles include users and groups. Security principles perform actions on objects, which include files, folders, printers, registry keys and Active Directory.

Username and Password

The user can protect the access to the operating system. The administrator defines the passwords of users who are allowed to use the computer. If users do not enter the valid credentials (Username and Password), access will be denied.

- New account and password creation
 1. From your current account, go to Settings > Accounts > Other People.

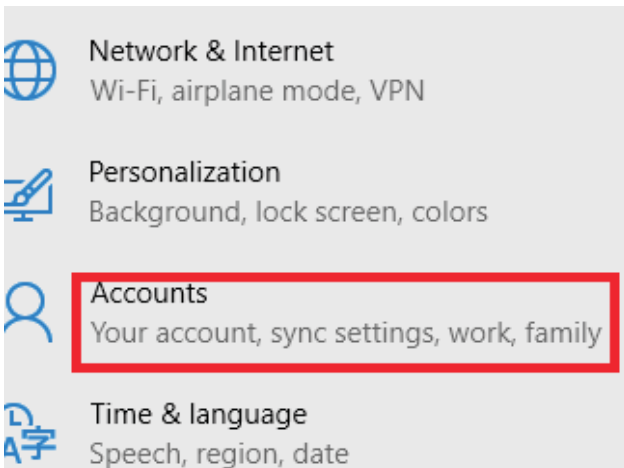
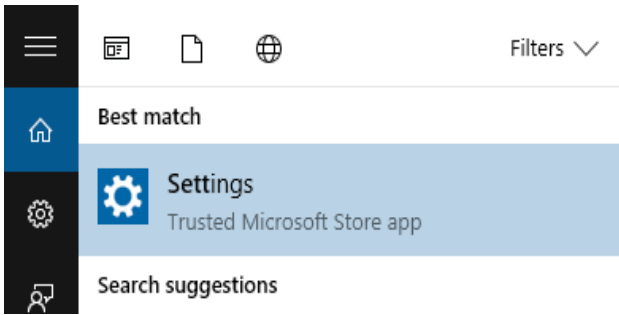

1. Click **Add someone else to this PC**.
2. That dialog box wants you to enter the email address associated with a Microsoft account. Ignore that box and instead click **I don't have this person's sign-in information**.

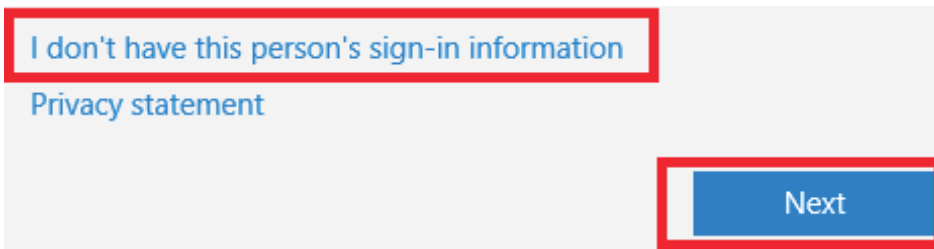

3. The previous option opens a new dialog box that encourages you to create a new Microsoft account, which is not your goal. Ignore the fields at the top of this dialog box and instead click **Add a user without a Microsoft account**.

*If you already use a Microsoft service, go Back to sign in with that account

Add a user without a Microsoft account

Next

4. Now create that local user account, entering a short descriptive user name, a password you'll be able to remember, and a password hint (which is mandatory).

Who's going to use this PC?

uwimana

Make it secure.

•••••

•••••

merci

Back

Next

1.6.6 Identification

Identification occurs when a user (or any subject) claims or professes an identity. This can be accomplished with a username, a process ID, a smart card, or anything else that can uniquely identify a subject. Security systems use this identity when determining if a subject can access an object.

In computer security, general access control includes authentication and authorization. Authentication and access control are often combined into a single operation, so that access is approved based on successful authentication, or based on an anonymous access token. Authentication methods and tokens include passwords, biometric scans, physical keys, electronic keys and devices.

* Authentication

Authentication is a process in which the credentials provided are compared to those on file in a database of authorized users' information on a local operating system or within an authentication server. If the credentials match, the process is completed and the user is granted authorization for access. The permissions and folders returned define both the environment the user sees and the way he can interact with it, including hours of access and other rights such as the amount of allocated storage space.

Therefore, Authentication verifies the identity and authentication enables authorization

* **Authorization**

Authorization is the process of giving someone permission to do or have something. In multi-user computer systems, a system administrator defines for the system which users are allowed access to the system and what privileges of use (such as access to which file directories, hours of access, amount of allocated storage space, and so forth).

1.6.7 Biometric authentication

Biometric authentication is a security process that relies on the unique biological characteristics of an individual to verify that he/she is who is says he/she is. Typically, biometric authentication is used to manage access to physical and digital resources such as buildings, rooms and computing devices.

Types of biometric authentication technologies:

Retina scans produce an image of the blood vessel pattern in the light-sensitive surface lining the individual's inner eye.

Iris recognition is used to identify individuals based on unique patterns within the ring-shaped region surrounding the pupil of the eye.

Finger scanning, the digital version of the ink-and-paper fingerprinting process, and works with details in the pattern of raised areas and branches in a human finger image.

Finger vein ID is based on the unique vascular pattern in an individual's finger.

Facial recognition systems work with numeric codes called face prints, which identify 80 nodal points on a human face.

Voice identification systems rely on characteristics created by the shape of the speaker's mouth and throat, rather than more variable conditions

1.6.8 Encryption and Decryption

Definition of Key Terms

Cryptography means "secret writing." However, the term is used to refer to the science and art of transforming messages to make them secure and immune to attacks.

Encryption is the process of encoding a message or information in such a way that only authorized parties can access it. Encryption does not of itself prevent intervention, but denies the intelligible content to a would-be interceptor.

To read an encrypted file, you must have access to a secret key or password that enables you to decrypt it. Unencrypted data is called plain text; encrypted data is referred to as cipher text.

Decryption is the process of taking encoded or encrypted text or other data and converting it back into text that you or the computer can read and understand. This term could be used to describe a method of un-encrypting the data manually or with un-encrypting the data using the proper codes or keys. It is reversing encryption process

Cryptosystem: A combination of encryption and decryption methods

Cleartext or Plaintext: The original message, before being transformed, is called plaintext. After the message is transformed, it is called ciphertext. An encryption algorithm transforms the plaintext into ciphertext; a decryption algorithm transforms the ciphertext back into plaintext.

1.6.9 Data Backup and recovery point

a. Data backup

Just as the system restore points allow the restoration of operating system configuration files, backup tools allow the recovery of data. The user can use the Microsoft backup tool to perform backups as required.

Storing backup copies of data and having backup computer capabilities are important basic safeguards because the data can then be restored if it was altered or destroyed by a computer crime or accident. Here are some considerations for data backups:

- Computer data should be backed up frequently
- Should be stored nearby in secure locations.
- Transporting sensitive data to storage locations should also be done securely.

By using MS windows 10, the backup is done in this way:

1. Open control panel.
2. Click on system and security.

Adjust your computer's settings



3. Click on backup and restore (windows 7).



Power Options

Change battery settings | Require a password when the computer wakes | Change what the power buttons do | Change when the computer sleeps



File History

Save backup copies of your files with File History | Restore your files with Fi



Backup and Restore (Windows 7)

Backup and Restore (Windows 7) | Restore files from backup



BitLocker Drive Encryption

Manage BitLocker

4. On the left pane, click the create a system image link.



Backup and Restore (Windows 7)

← → ▾ ↑ > Control Panel > System and Security > Backup and Restore (Windows 7)

Control Panel Home



Create a system image



Create a system repair disc

Back up or restore your files

Backup

Windows Backup has not been set up.

Restore

Windows could not find a backup for this computer.

Select another backup to restore files from

5. Under “where do you want to save the backup?” choose location.

6. Using the “on a hard disk” drop-down menu, select the storage to save the backup and click on start back up button

The following drives will be backed up:



Start backup

b. Recovery point

i. Fix problems with system restore

Microsoft Windows Operating System helps to recover from problems that might stop it from working properly, but there may come a time when it needs some manual intervention. Microsoft's latest operating system has a similar set of recovery tools as easier versions for this, but not all work in the way you would expect and there are some new options at your disposal, too.

ii. System restore on windows 10

As with earlier versions of windows, system restore allows to 'rewind' windows installation to an earlier working state, without affecting the documents inside the computer. This is possible because windows automatically saves restore points when something significant happens, such as installing a windows update or a new application the idea being that if it goes wrong, the last restore point (or an even earlier one) can be returned back and get things performing as they were previously. The problem is that system restore is disabled by default in windows 10 and should therefore be enabled before benefiting from its features. Here is how to enable it:

- **Open system restore**

Search for **system restore** in the windows Operating System search box and select **create a restore point** from the list of results. When the system properties dialog box appears, click the **system protection** tab and then click the **configure** button. The following interface is coming from Microsoft Windows 10 Operating System.

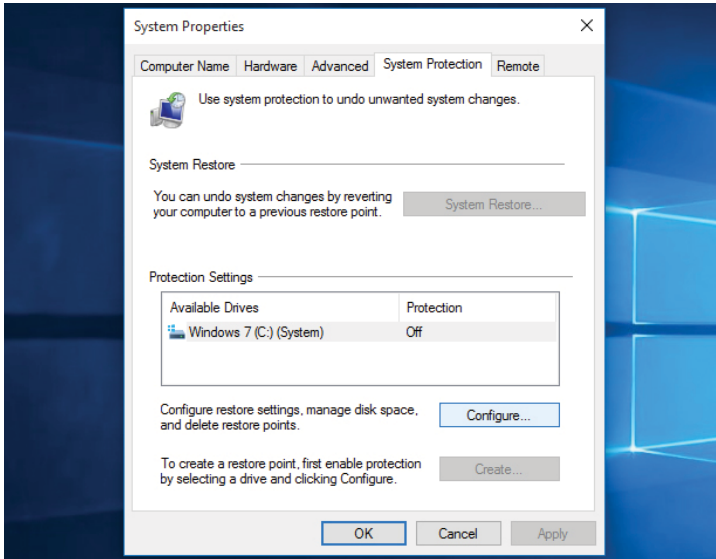

Picture 1.6 : System Protection layout

- **Enable system restore**

Click to enable **turn on system protection** and then use the **max usage** slider to determine how much of your hard drive to use to store restore points — 5% to 10% is usually sufficient — and click **ok**. If you ever need to create a restore point manually, return to this dialog box and click the **Create** button, otherwise Microsoft windows 10 will create them automatically.

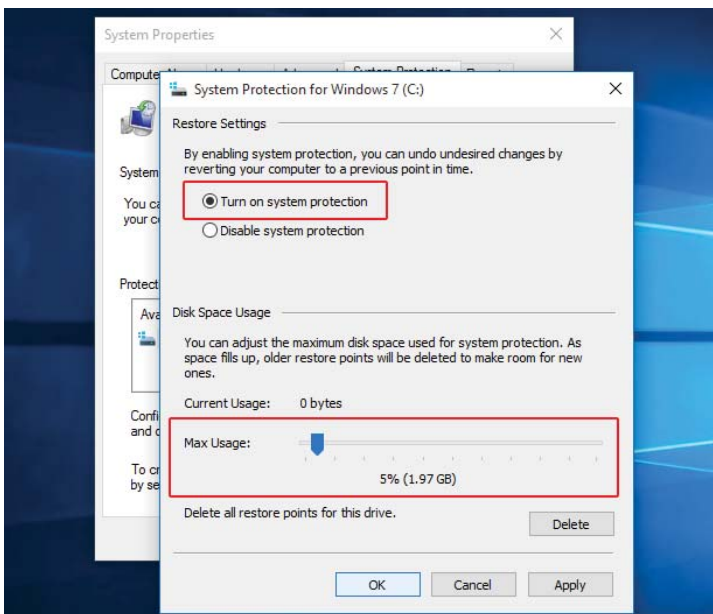

Picture 1.7 : System protection settings

- **Restore your pc**

Whenever you want to return to a restore point, open the **system properties** dialog box again (see step 1), click the **system protection** tab and then click the **System restore** button. Follow the on-screen instructions and select the desired restore point when prompted. You can also click the **scan for affected programs** button before going any further, to see what might change on your pc afterwards. When you're happy to proceed, click **next**.

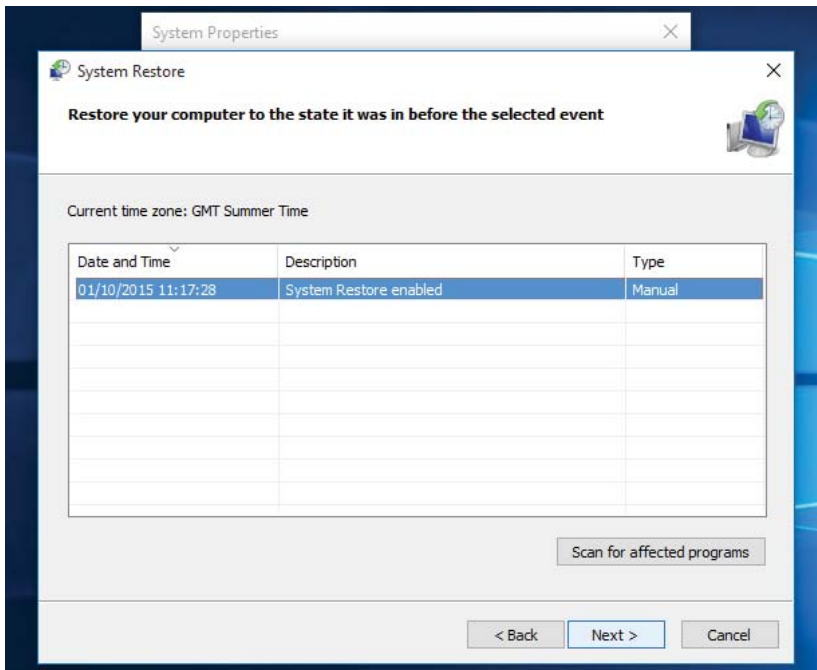

Picture 1.8: System Restore

a. If system restore doesn't work event

Some serious windows problems can prevent you from rewinding to a restore point with system restore, but all is not lost. All you need to do is start windows 10 in safe mode. This barebones windows mode only runs the essential parts of windows, which means any problematic apps, drivers or settings will be disabled. System restore will then usually be successful.

1. Open advanced start-up

Go to start > **settings** > **update & security** > **recovery** and click **restart now** below **advanced start-up**.

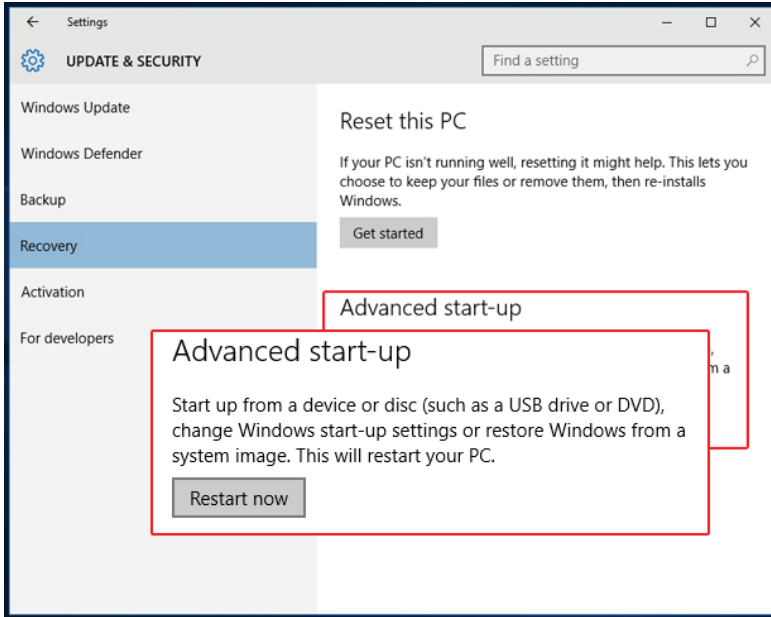
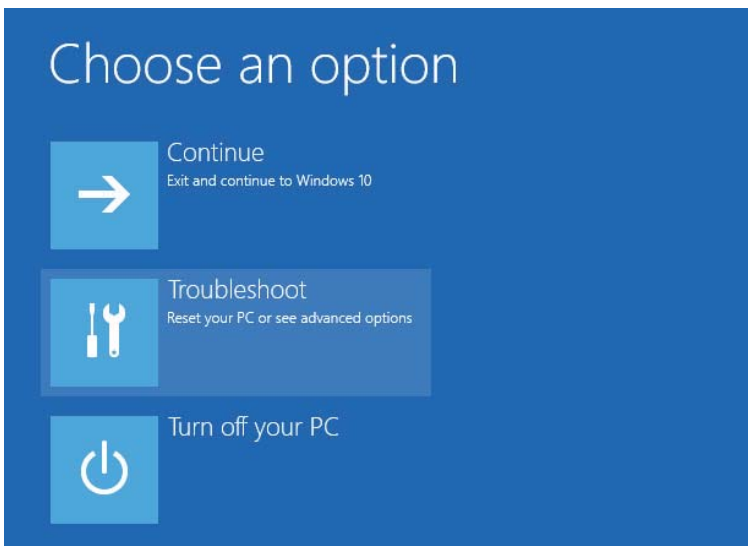

Figure 1.9: update and security settings

2. Start system restore in safe mode

Windows will then restart and display a **choose an option** menu. Select **troubleshoot** > **advanced options** > **system restore** and use system restore in the usual way.



Picture 1.10 : Start system restore in safe mode

b. Recovering from more serious problems

System restore won't always rescue your pc from very serious problems, but windows 10 still has extra trick up its sleeve. It can restore windows to a factory fresh state without affecting your documents, although everything else (including apps) are removed. Even so, you should make sure you have a back up of your important files before using this option, just in case.

1. Open reset this pc

Go to **start > settings > update & security > recovery** and click **get started** below **reset this pc**.

2. Reset windows 10, but save your files

On the next screen, click **keep my files** and follow the on-screen instructions to reset windows 10. You'll see a list of apps that will be removed and be asked to confirm your choice before going any further.

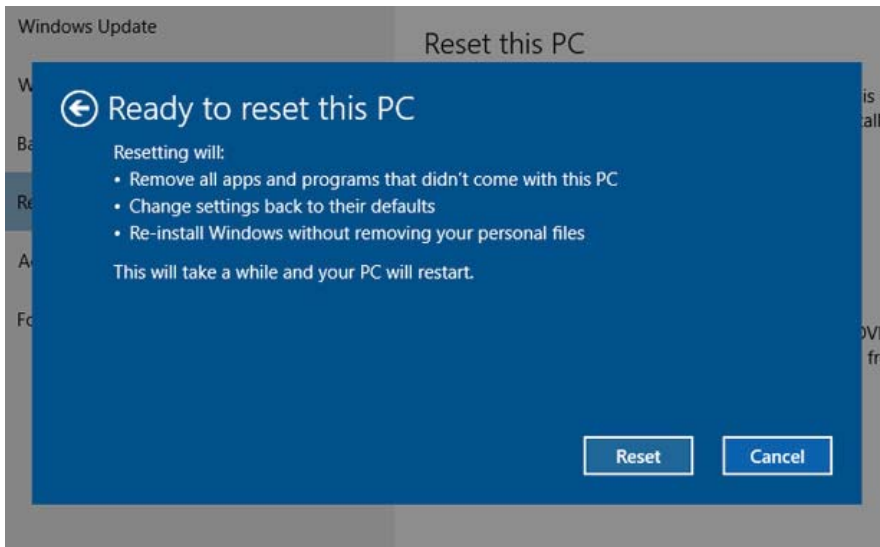

Picture 1.11: Resetting windows 10 layout

3. Reset this PC from safe mode

As with system restore, serious windows 10 problems can prevent reset this PC from working, but you can also run it from safe mode to bypass this. Follow step 1 under if system restore won't work above, but instead choose troubleshoot > reset this pc

> keep my files under step 2.

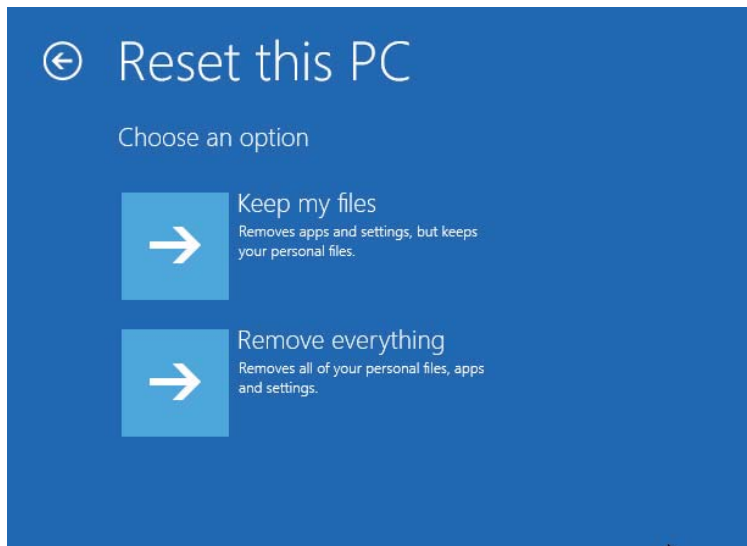

Picture 1.12: *Resetting windows 10 Options*

APPLICATION ACTIVITY 1.6

1. By using clear example, compare access control and parental control
2. In a bank, any customer can create and use an identity (e.g., a user name and password) to log into that bank's online service but the bank's policy must ensure that the user can only access to his/her individual account online once his/her identity is verified.
 - a. Identify which type of security is used in this bank?
 - b. Why is it important?
3. What is the purpose of creating deferent computer users?
4. After anti-virus installation, where do you place the unusable CD and CD box?
5. At your school, the anti-virus used or installed in computers it was for haw many users?

Suppose that, the anti-virus keys are stolen by someone else to use it on network. What can be the consequences for that anti-virus users in that school? How the computer users can avoid that illegal action?

6. In the computer lab, configure the firewall

END UNITY ASSESSMENT

Part 1. Written

1. What is computer security? What is the purpose of computer security?
2. With an example, explain how you can protect a computer from physical threats?
3. Use three characters in an information exchange scenario; we use computers called Mulisa, Ndoli, and Kamana. Mulisa is the person who needs to send secure data. Ndoli is the recipient of the data. Kamana is the person who somehow disturbs the communication between Mulisa and Ndoli by intercepting messages to uncover the data or by sending her own disguised messages.
 - a. In the scenario, identify to whom belong cleartext, plaintext and ciphertext
 - b. Differentiate ciphertext to plaintext
4. Explain the difference between finger scanning and finger vein ID
5. By using example, explain access control in authorization
6. Which type of attack that enable a computer user to access his/her e-mail address?
7. What do you understand by social engineering technique? Give examples
8. It is heard that some web site become hacked by unknown people. Which strategies can be used to avoid young Rwandan programmers to engage in that action?
9. Using an arrow match the following in Group A with their corresponding in B

Group A	GROUP B
1. Virus	a. Is the process pedophiles use to get children they target online to meet with them offline, the simple goal being sex.
2. Worms	c. Sits quietly in the system and copies all the relevant information being input and processed.
3. Grooming	d. Piece of code that is loaded onto your computer without your knowledge and runs against your wishes.
4. Trojan	e. Are used by hackers to gain access into a machine without the permission of the user.
5. Email attachment	f. infect networks by replicating themselves and transmitting their multiple copies to all the nodes connected on the network
6. Spyware	g. are one of the other popular sources of computer virus attacks

Part 2 Practice

In school computer lab, every student takes a computer and do the following activities:

1. With one external hard disk, make a backup of the local disk drive C
2. Update the anti-virus found on the computers
3. Add a new user on the computer



UNIT 2

LAN ARCHITECTURE, NETWORK PROTOCOLS AND MODELS

UNIT 2. LAN ARCHITECTURE, NETWORK PROTOCOLS AND MODELS

Key Unit Competency: To be able to identify computer network models, protocols and configure network devices

Introductory Activity

Look at figure 2.1 below and answer the following questions:

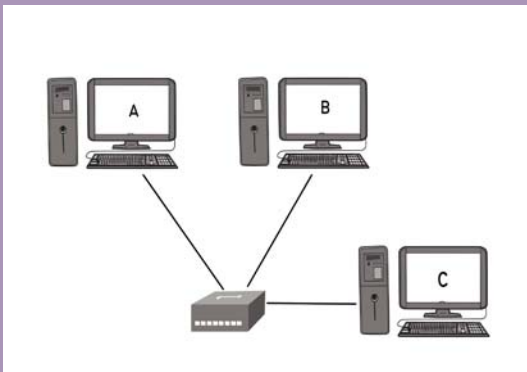

1. Describe what you see.
2. Are the above computers communicating? How and why?
3. In which case the communication may not be possible?
4. What type of network does the figure above represent?
5. How the Computers A and B are connected?
6. Is there any other way of connecting A, B and C

2.1 LAN architecture

Activity 2.1:

Visit your school computer lab and look at the existing Network and answer the followings questions:

1. Describe how computers are connected to the Network?
2. Determine the type of the logical or physical arrangement of network devices (nodes) in that network.

2.1.1 Definition of LAN Architecture?

A Local Area Network (LAN) architecture is the overall design of a computers network that interconnects computers within a limited area such as a residence, school, laboratory, university campus or office building. The LAN architecture consists of three levels: Physical, Media Access Control (MAC) and Logical Link Control (LLC).

- The LLC provides connection management, if needed.
- The Media Access Control (MAC) is a set of rules for accessing high speed physical links and for transferring data frames from one computer to another in a network.
- The Physical level deals mainly with actual transmission and reception of bits over the transmission medium.

2.1.2 Major Components of LANs

A LAN is made of the following main components:

- Hardware:
 - ◇ Computers
 - ◇ Network interface card (NIC) linked to physical address
 - ◇ Media or Cables (Unshielded twisted pair, Coaxial cable, Optical fiber, Air for wireless)
 - ◇ Hub, Switches, repeaters
- Access Methods: Rules that define how a computer puts data on and takes it from the network cable.
- Software: Programs to access and / or to manage the network.

2.1.3 Aspects of LAN architecture.

These aspects include:

- LAN's physical topology: defines how the nodes of the network are physically connected
- LAN's logical topology: how data is transmitted between nodes
- LAN's MAC protocol: used for the physical identification of different devices within the network

2.1.4 Ethernet

Ethernet is a family of computer networking technologies commonly used in local area networks, metropolitan area networks and wide area networks. Ethernet cable is one of the most popular forms of network cable used in wired networks. They connect devices together within a local area network like PCs, routers and switches. A standard Ethernet network can transmit data at a rate up to 10 Megabits per second (10 Mbps). Ethernet uses CSMA/CD (Carrier Sense multiple Access with Collision Detection)

2.1.5 Carrier Sense Multiple Access with Collision Detection (CSMA/CD)

In a LAN, computers transmit data to each other. Normally, there is order to follow so that two computers can not send data at the same time while they are using the same route. When it happens that two computers send messages at the same time, there is what we call data collision. Therefore, a data collision occurs when two or more computers send data at the same time. When this happens, each computer stops data transmission and waits to resend it when the cable is free. Carrier Sense Multiple Access with Collision Detection (CSMA/CD) is a set of rules determining how network devices respond to a collision.

How does the CSMA/CD work?

Consider the following picture:

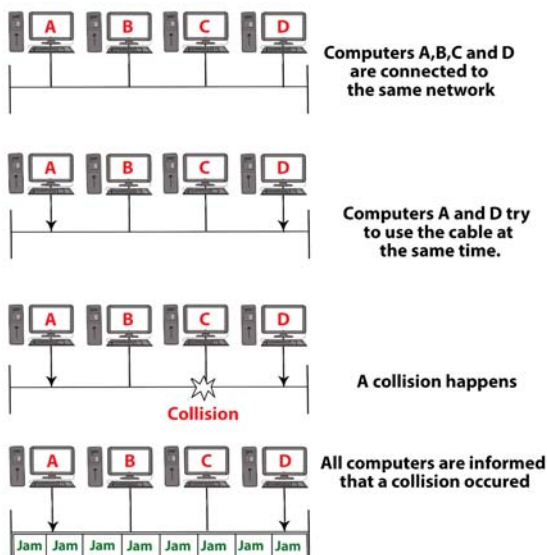

Figure 2.1.: CSMA/CD

On the figure above, host A is trying to communicate with host B. Host A “senses” the wire and decides to send data. But, in the same time, host D sends its data to host C and the collision occurs. The sending devices (host A and host D) detect the collision and resend the data after a random period of time.

When a collision occurs on an Ethernet LAN, the following happens:

- A jam signal informs all devices that a collision occurred.

A signal sent by a device on an Ethernet network to indicate that a collision has occurred on the network is called a **jam signal**.

- The collision invokes a random **backoff algorithm** (a set of rules which controls when each computer resends the data in order to assure that no more collision will happen again).
- Each device on the Ethernet segment stops transmitting for a short time until the timers expire.
- All hosts have equal priority to transmit after the timers have expired.

Application activity 2.1:

1. Realize a physical topology using devices like router, switches, Hubs, Ethernet cables and 4 computers available in your school computer lab as indicated in Fig. 2.2.
2. Describe how does the CSMA/CD enable the communication over Ethernet?

2.2 Cable Ethernet Standards

Activity 2.2:

Look around your school computer lab and answer the following question:

Observe and describe the communication media (different types of Cables) available there.

2.2.1 Definition of standard

Standards provide guidelines to manufacturers, vendors, government agencies, and other service providers in guaranteeing national and international interoperability of data and telecommunications technology and processes. With Ethernet technologies, different types of standards have been so far used in networks.

The different Ethernet technologies used in wired networks to connect computers are given in the following table. The choice of one or another type depends on the size of networks and the quantity of data to exchange.

Name	IEEE Standard	Data Rate	Media Type	Maximum Distance	Advantages
Ethernet	802.3	10 Mbps	10Base-T	100 meters	Low cost components Easy to install Easy to troubleshoot
Fast Ethernet/ 100Base-T	802.3u	100 Mbps	100Base-TX 100Base-FX	100 meters 2000 meters	It is the most popular and cheapest Ethernet
Gigabit Ethernet/ GigE	802.3z	1000 Mbps	1000Base-T 1000Base-SX 1000Base-LX	100 meters 275/550 meters 550/5000 meters	Gigabit Ethernet is ten times faster than Fast Ethernet
10 Gigabit Ethernet	IEEE 802.3ae	10 Gbps	10GBase-SR 10GBase-LX4 10GBase-LR/ER 10GBase-SW/LW/EW	300 meters 300m Multimode Fiber (MMF) / 10km Single-mode Fiber (SMF) 10km /40km 300m/10km /40km	It is the fastest one It is too expensive

Table 2. 1: LAN Technology Specifications

10BASE-F

10BASE-F is a generic term for the family of 10 Mbit/s Ethernet standards using fiber optic cable. In 10BASE-F, the 10 represents its maximum throughput of 10 Mbit/s, BASE indicates its use of baseband transmission, and F indicates that it relies

on medium of fiber-optic cable. In fact, there are at least three different kinds of 10BASE-F. All require two strands of 62.5/125 μm multimode fiber. One strand is used for data transmission and one strand is used for reception, making 10BASE-F a full-duplex technology.

The 10BASE-F variants include **10BASE-FL**, **10BASE-FB** and **10BASE-FP**. Of these only 10BASE-FL experienced widespread use. All 10BASE-F variants deliver 10 Mbit/s over a fiber pair. These 10 Mbit/s standards have been largely replaced by faster Fast Ethernet, Gigabit Ethernet and 100 Gigabit Ethernet standards.

10BASE-FL

10BASE-FL is the most commonly used 10BASE-F specification of Ethernet over optical fiber. In 10BASE-FL, FL stands for fiber optic link. It replaces the original fiber-optic inter-repeater link (FOIRL) specification, but retains compatibility with FOIRL-based equipment. The maximum segment length supported is 2000 meters. When mixed with FOIRL equipment, maximum segment length is limited to FOIRL's 1000 meters.

Today, 10BASE-FL is rarely used in networking and has been replaced by the family of Fast Ethernet, Gigabit Ethernet and 100 Gigabit Ethernet standards.

10BASE-FB

The 10BASE-FB (10BASE-FiberBackbone) is a network segment used to bridge Ethernet hubs. Due to the synchronous operation of 10BASE-FB, delays normally associated with Ethernet repeaters are reduced, thus allowing segment distances to be extended without compromising the collision detection mechanism. The maximum allowable segment length for 10BASE-FB is 2000 meters.

10BASE-FP

10BASE-FP calls for a non-powered signal coupler capable of linking up to 33 devices, with each segment being up to 500m in length. This formed a star-type network centered on the signal coupler. There are no devices known to have implemented this standard.

2.2.1 Wireless network standards

Wireless LANs (WLANs) use radio frequencies (RFs) that are radiated into the air from an antenna that creates radio waves.

Because WLANs transmit over radio frequencies, they are regulated by the same types of laws used to govern things like AM/FM radios. It is the Federal Communications Commission (FCC) that regulates the use of wireless LAN devices, and the IEEE takes it from there and creates standards based on what frequencies the FCC releases for public use.

The wireless standards like the Ethernet standards are applied in different situations. The table below clearly describes each type.

Standard	Specification	Advantages	Disadvantages
802.11 Standard	Rate: 1Mbps and 2Mbps.	-	Slowest.
802.11b Standard	It runs in the 2.4GHz radio frequency	Lowest cost; signal range is good and not easily blocked	Slowest maximum speed.
802.11g Standard	It operates in the 2.4GHz and delivers a maximum data rate of 11Mbps	It is backward compatible with 802.11b.	Costs more than 802.11b.
802.11n standard	Bandwidth up to 54 Mbps, and it uses the 2.4 GHz frequency for greater range.	Best signal range and it is backward-compatible with 802.11b/g gear.	Standard is not yet finalized; costs more than 802.11g;
802.11ac standard	It provides up to 300 Mbps of network bandwidth	It offers backward compatibility to 802.11b/g/n and bandwidth rated up to 1300 Mbps on the 5 GHz band plus up to 450 Mbps on 2.4 GHz.	-
	It operates on both the 2.4 GHz and 5 GHz Wi-Fi bands. 802.11ac		

Table 2. 2: Summary of wireless standards

2.2.3 Range, bandwidth and frequency

One characteristic that measures network performance is bandwidth. The bandwidth reflects the range of frequencies we need. However, the term can be used in two different contexts with two different measuring values: **bandwidth in hertz** and **bandwidth in bits per second**.

a. Bandwidth in Hertz

Bandwidth in hertz is the range of frequencies contained in a composite signal or the range of frequencies a channel can pass. For example, we can say the bandwidth of a subscriber telephone line is 4 kHz.

b. Bandwidth in Bits per Seconds

The term bandwidth can also refer to the number of bits per second that a channel, a link, or even a network can transmit per second. For example, one can say the bandwidth of a Fast Ethernet network is a maximum of 100 Mbps. This means that this network can send 100 Megabits per second.

2.2.3.1 Frequency and Network Range

The higher the frequency of a wireless signal, the shorter its range. 2.4 GHz wireless networks therefore cover a significantly larger range than 5 GHz networks. In particular, signals of 5 GHz frequencies do not penetrate solid objects nearly as well as do 2.4 GHz signals, limiting their reach inside homes.

Many older Wi-Fi devices do not contain 5 GHz radios and so must be connected to 2.4 GHz channels in any case.

2.4 GHz	5 GHz
802.11b/g/n	802.11a/n/ac
Greater Range (~90 meters)	Lower Indoor Range (~28 meters)
Universal Compatibility	Limited Compatibility (a/n/ac devices only)
3 non-overlapping channels	24 non-overlapping channels
Congested with Wi-Fi	Little Wi-Fi congestion
Plagued by non-Wi-Fi interference	Very little non-Wi-Fi interference

Table 2. 3: 2.4 GHz and 5 GHz Comparison

2.2.3.2 Range, Bandwidth and Frequency

- The term 'Bandwidth' refers to the speed at which data is transferred over the wireless network (more bandwidth means faster downloading and uploading)
- The term 'Range' refers to the maximum distance from the router at which the network can be received (the greater the range, the further you can be from the router and still be connected).
- The term 'Frequency' refers to the number of waves that pass a fixed place in a given amount of time. So if the time it takes for a wave to pass is $1/2$ second, the frequency is 2 per second. If it takes $1/100$ of an hour, the frequency is 100 per hour.

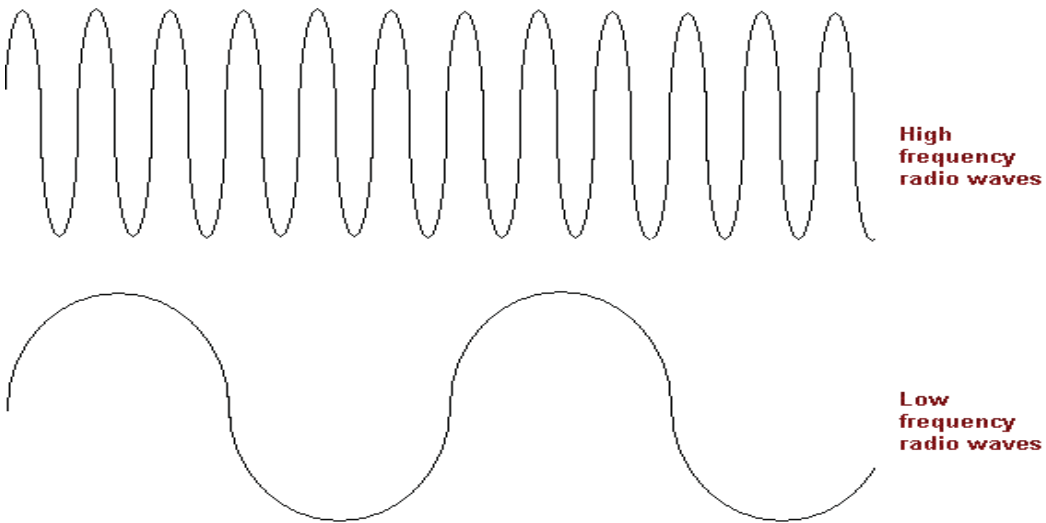

Source: *Universal Technique For The Fastest Communication With The Minimum Uncertainty In Losing The Information* published on http://www.iaeng.org/publication/WCE2010/WCE2010_pp242-246.pdf

Usually frequency is measured in the hertz unit, named in honor of the 19th-century German physicist Heinrich Rudolf Hertz. The hertz measurement, abbreviated Hz, is the number of waves that pass by per second. For example, an "A" note on a violin string vibrates at about 440 Hz (440 vibrations per second).

2.2.3.3 Advantages and Disadvantages of the 2.4 GHz and the 5 GHz Wireless Networks

2.4 GHz Wireless Networks		5 GHz Wireless Networks	
Advantages	Disadvantages	Advantages	Disadvantages
<ul style="list-style-type: none"> It is cheaper to manufacture devices that use this frequency. As a result, this frequency has become standard and all Wi-Fi enabled devices can use this network. It has a much better range than a 5 GHz wireless network. This is due to the fact that the radio waves are able to penetrate solid objects (such as walls and floors) much better than the 5 GHz radio waves. 	<ul style="list-style-type: none"> It has a lower bandwidth than the 5 GHz network. Devices such as cordless phones and microwaves use the same 2.4 GHz radio waves as a wireless router. If you have such devices at home, they can cause interference with the radio waves from the router, causing the network's bandwidth to be reduced. More devices support this frequency so there is more congestion in this frequency which may cause issues with bandwidth. 	<ul style="list-style-type: none"> It has a much higher bandwidth than the 2.4 GHz network. This network is not used by common wireless devices such as cordless phones; therefore, there will be no or very little interference to cause a reduction in bandwidth. 	<ul style="list-style-type: none"> It is more expensive to manufacture devices that use this frequency, therefore, only few wireless devices can use this network. It has a much lower range than the 2.4 GHz wireless network. Being the higher frequency of the two, it is not able to penetrate solid objects as great as the 2.4 GHz radio waves. As this is a newer standard and more expensive to implement, fewer devices support this frequency s this is a newer analyzed the pros and the cons for both the 2.4 GHz and the 5 GHz wireless networks, which wireless network do you think will be the best for you?

2.2.3.4 Token ring

Token ring or IEEE 802.5 is a network where all computers are connected in a circular fashion. The term token is used to describe a segment of information that is sent through that circle. When a computer on the network can decode that token, it receives data.

A Multistation Access Unit (MSAU) is a hub or concentrator that connects a group of computers ("nodes" in network terminology) to a token ring local area network. For example, eight computers might be connected to an MSAU in one office and that MSAU would be connected to an MSAU in another office that served eight other computers. In turn, that MSAU could be connected to another MSAU in another office, which would be connected back to the first MSAU. Such a physical configuration is called a star topology. However, the logical configuration is a ring topology because every message passes through every computer one at a time, each passing it on to the next in a continuing circle.

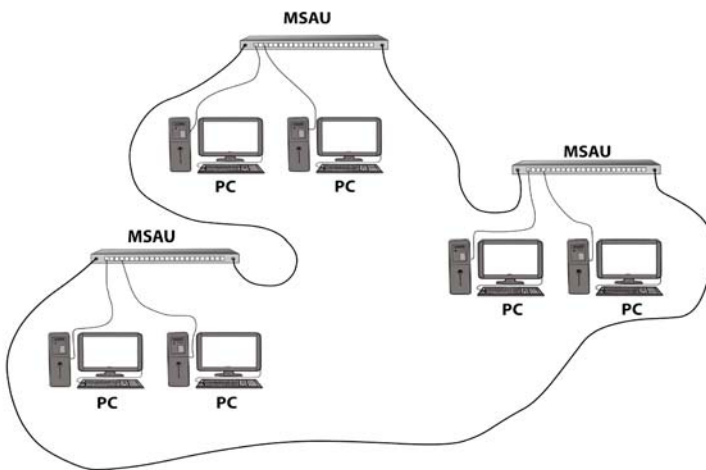

Figure 2. 1: Multistation access unit (MSAU)

Application activity 2.2:

Your school has classrooms, computer labs and the staff room located in three different buildings as indicated in the figure below:

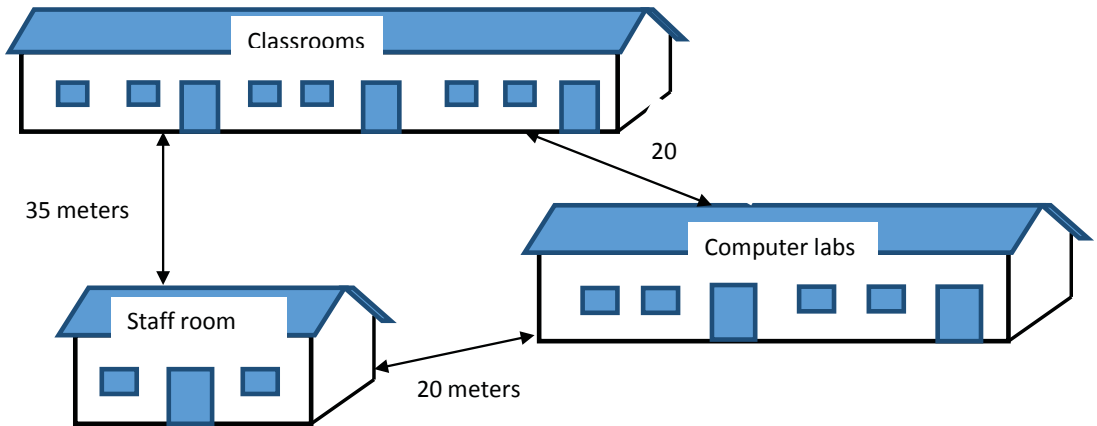

Figure 2. 2: School buildings

Questions:

1. Which kind of technology can you propose to connect computers in the 3 buildings. Explain your choice.
2. If you choose to install a wireless network within this school, in which building would you place the wireless device which serves the whole school? Explain.
3. What type of Ethernet cable would you use if you are requested to interconnect those three buildings? Explain.

2.3 Fiber Distributed Data Interface (FDDI)

Learning activity 2.3:

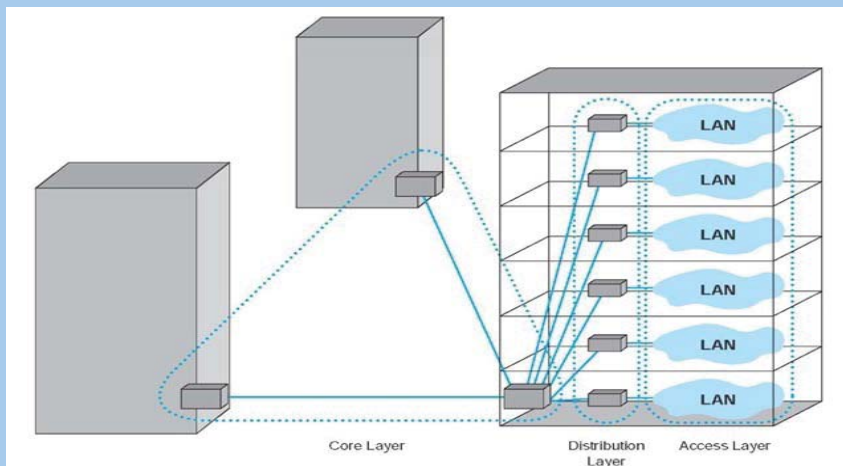

Describe what you can see on the figure above.

Source: <http://yourpict.com/editor/>

2.3.1 Definition

The Fiber Distributed Data Interface (FDDI) is a standard developed by the American National Standards Institute (ANSI) for transmitting data on optical fiber cables. FDDI supports transmission rates of 100 megabits per second on token-passing networks.

FDDI provides high-speed network backbones that can be used to connect and extend LANs.

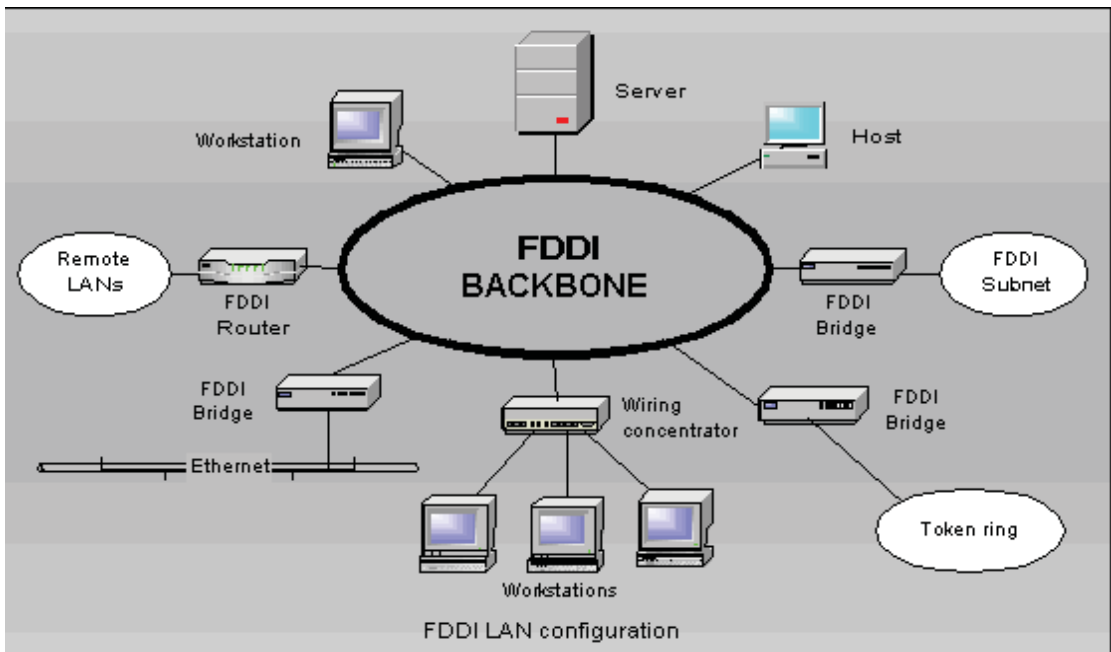

Figure 2. 3: Fiber Distributed Data Interface LAN configuration

Source: <http://aquaticws.com/fddi-network-47/>

2.3.2 Advantages of FDDI

The Fiber Distributed Data Interface allows the transmission of very large volumes of data over large distances. It provides high bandwidth.

2.3.3 Disadvantages

The Fiber Distributed Data Interface (FDDI) is an expensive technology to set up because the network devices require a special network card and also the required fiber-optic cabling is expensive than twisted-pair cable. Because most Fiber Distributed Data Interface (FDDI) installations use a redundant second ring, more cabling is required.

2.3.4 Fiber Optic cables

A fiber optic cable is a glass or plastic strand that transmits information using light and is made up of one or more optical fibers enclosed together in a sheath or jacket. It has the following properties:

- Not affected by electromagnetic or radio frequency interference.
- All signals are converted to light pulses to enter the cable, and converted back into electrical signals when they leave it.
- Signals are clearer, can go farther, and have greater bandwidth than with copper cable.
- Signal can travel several miles or kilometers before the signal needs to be regenerated.
- Usually more expensive to use than copper cabling and the connectors are more costly and harder to assemble.
- Common connectors for fiber-optic networks are SC, ST, and LC. These three types of fiber optic connectors are half-duplex, which allows data to flow in only one direction. Therefore, two cables are needed.

a. Types of fiber optic

There are three types of fiber optic cable commonly used: **single mode, multimode and plastic optical fiber (POF)**.

1. **Single-mode:** Cable that has a very thin core. It is harder to make, uses lasers as a light source, and can transmit signals dozens of kilometers with ease.

Single-Mode

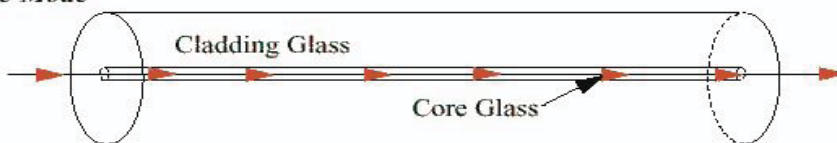

Figure 2. 4: Single mode Optical Fiber

Source: <https://www.ad-net.com.tw/difference-between-single-mode-fiber-and-multi-mode-fiber/>

2. **Multimode:** Cable that has a thicker core than single-mode cable. It is easier to make, can use simpler light sources (LEDs), and works well over distances of a few kilometers or less.

Multimode

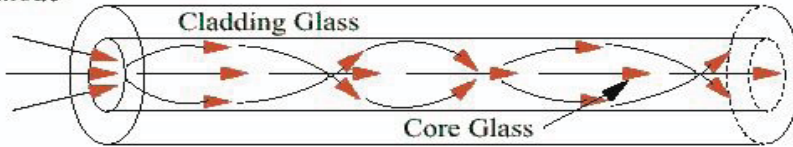

Figure 2. 5: Multimode Optical Fiber

- 3. Plastic optical fiber (POF):** Transparent glass or plastic fibers which allow light to be guided from one end to the other with minimal loss.

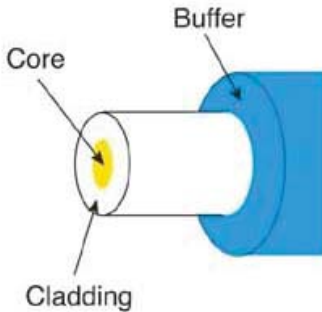

Figure 2. 6: Plastic Optical Fiber

Source: <http://www.thefoa.org/tech/ref/basic/ljar-fib.jpg>

The Fiber optic technologies are summarized in the following table.

Designation	Supported Media	Maximum Segment Length	Transfer Speed	Topology
100Base-FX	Fiber-optic- two strands of multimode 62.5/125 fiber	412 meters (Half-Duplex), 2000 m (full-duplex)	100 Mbps, (200 Mb/s full-duplex mode)	Star(often only point-to-point)
1000Base-SX	Fiber-optic- two strands of multimode 62.5/125 fiber	260m	1Gbps	Star, using buffered distributor hub (or point-to-point)

1000Base-LX	Fiber-optic- two strands of multimode 62.5/125 fiber or monomode fiber	440m (multimode) 5000 m (single mode)	1Gbps	Star, using buffered distributor hub (or point-to-point)
1000Base-CX	Twinax,150- Ohm-balanced, shielded, specialty cable	25m	1Gbps	Star(or point-to- point)
10Base-FL				

Application activity 2.3:

4. Discuss the advantages and disadvantages of FDDI within a Local Area Network.
5. Referring to the figure on learning activity 2.3, what type of fiber optic cable would you recommend for the core and distribution layers? Explain.

2.4 Network devices

Activity 2.4.

In groups, look at the devices given below and answer the questions:

6. Describe the role of each one within a Local Area Network.
7. Explain how you can make a Local Area Network using the following devices?



Access Point



Wireless router



Switch



Desktop



Laptop



UTP cable



Printer

There are many networking devices: NIC cards, Repeaters, HUB, Bridges, Switches and Router

2.4.1 Wireless LAN cards (Network adaptors)

Also called Network Interface Cards (NICs), they are connectivity devices enabling a desktop, server, printer, or other node to receive and transmit data over the network media

a. Types of Wireless Network Interface Cards (NICs)

NICs come in a variety of types depending on:

- The access method (for example, Ethernet versus Token Ring)
- Network transmission speed (for example, 100 Mbps versus 1 Gbps)
- Connector interfaces (for example, RJ-45 versus SC)
- Type of compatible motherboard or device (for example, PCI)
- Manufacturer (popular NIC manufacturers include 3Com, Adaptec, D-Link, IBM, Intel, Kingston, Linksys, and so on)

b. Wireless NIC card installation and configuration

- Refer to the card manufacturer's quick-start guide. Alternatively, you can also run the software installation program on the CD which comes with the PCI card and observe the steps to install it.
- Shut down the PC.
- Remove the cover.
- Locate an available PCI slot and remove the corresponding slot cover from the back of the PC.
- Carefully route the antenna through the open slot in the back of the PC, insert the card in the slot, and secure it. Replace the cover.
- Power up the PC. It should recognize and enable the new hardware.

c. Wireless NIC card Driver installation through the Device Manager

Step 1: Right-click on Computer (or PC) to select Manage.

Step 2: On the left, select Device Manager to bring it up on the right.

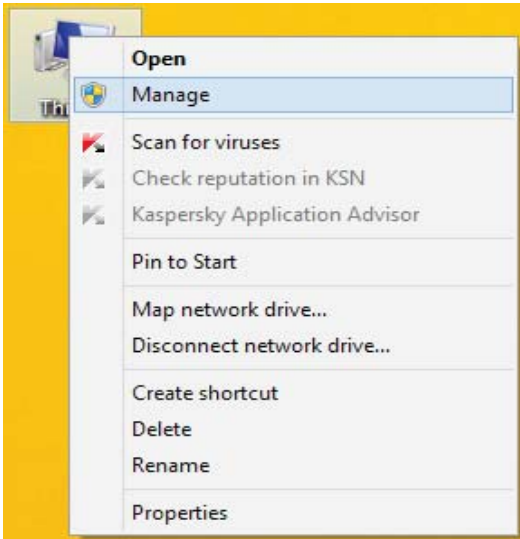

Figure 2.9: Pop up menu for device manager

Step 3: Right click on the unknown adapter to Update Driver Software.

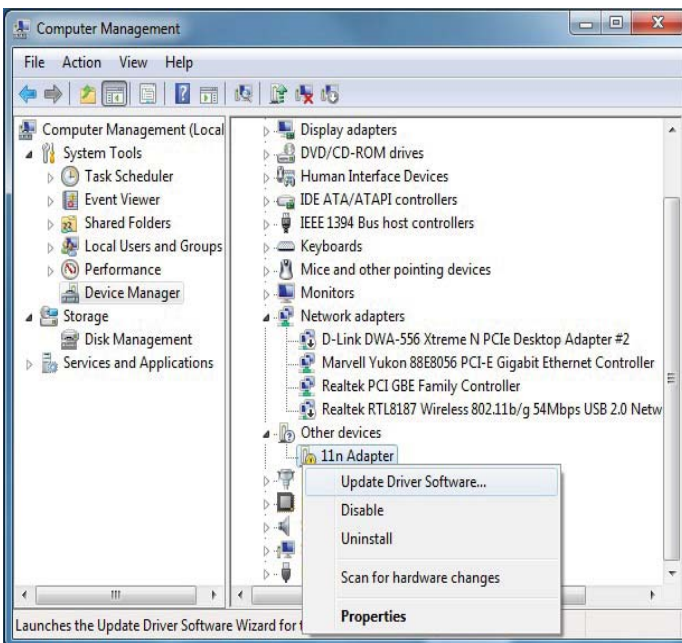

Figure 2.10: Device manager window

Step 4: Click to Search automatically for updated driver software.

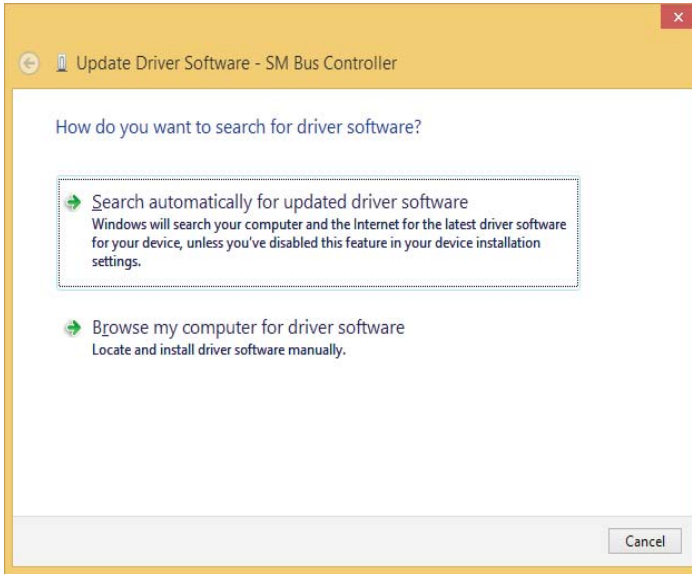

Figure 2.11: Driver update window

Step 5: Wait until the download process is successfully completed.

Step 6: Click on Save Settings or OK to apply the change.

Confirmation of a successful Driver installation is achieved when the model of your adapter is labeled and listed in the Network adapters group of the Device Manager.

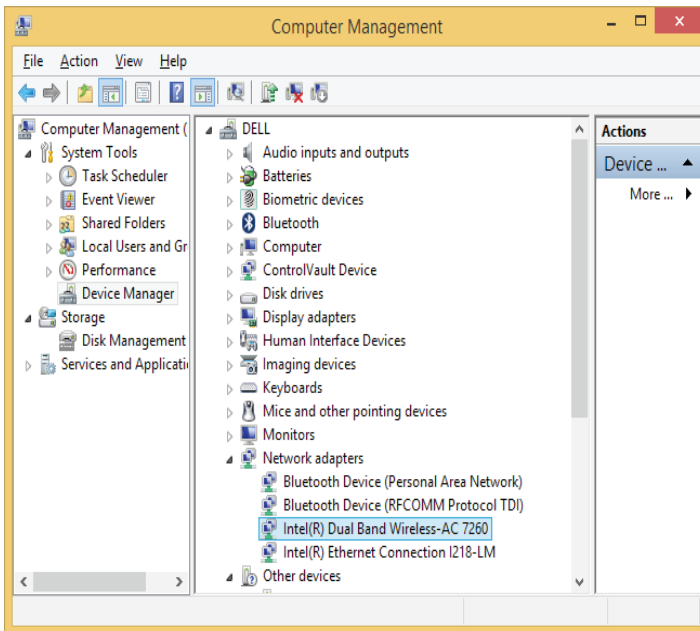

Figure 2.12: Intel(R) Dual Band Wireless-AC 7260 successfully installed

2.4.2 Routers and Access points

A wireless router is a device that performs the functions of a router and also includes the functions of a wireless access point. It is used to provide access to the Internet or a private computer network. Routers operate at the Network layer (Layer 3) of the OSI Model.

The Wireless access points (APs or WAPs) are networking devices that allow wireless Wi-Fi devices to connect to a wired network.



Figure 2.13: Routers

Source: https://www.grosbill.com/4-cisco_892fsp_2_ge_sfp_high-701229-reseaux-routeur

2.4.3 Configuring a wireless router

Step 1: Get to know your wireless router

- A power input jack one.
- One or more wired Ethernet jacks (often labeled 1, 2, 3, 4) for computers on your network which don't have wireless ability.
- One Ethernet jack for your broadband connection, often labeled "WAN" or "Internet."
- A reset button. to

Step 2: Connect your router a wired PC for initial setup

Step 3: Open web browser and connect to wireless router administration INTERFACE

To connect to your router, you need to know its default IP address and connect your browser to `http://routeripaddress`. For example, if you own a Linksys brand wireless router, its default IP address is **192.168.1.1**, and therefore you open your browser to the URL **`http://192.168.1.1`**.

Most wireless routers also require you to log in to access configuration pages. Your router includes a manual or a "quick setup" guide which details both its default IP address and default login.

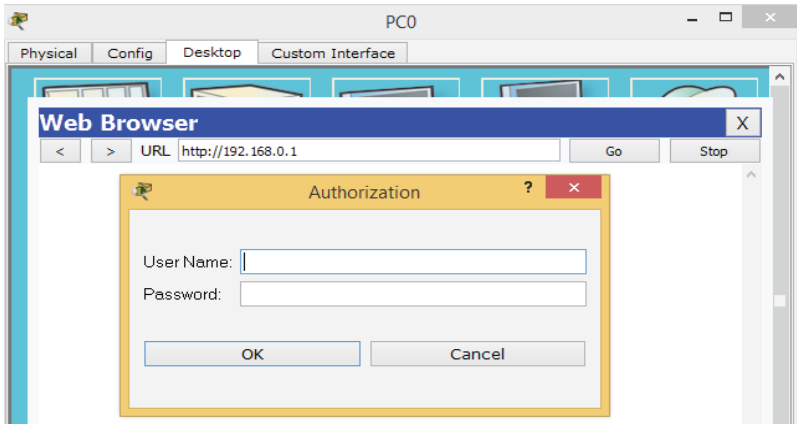

Figure 2.14: Login window

Step 4: Determine your broadband type

There are three common broadband connection methods:

- DHCP Dynamic IP: Basic network parameters are automatically assigned to your router by the broadband modem.
- PPPoE: Requires you to supply a username and password provided to you by your ISP.
- Static IP: Your broadband provider would have supplied you with a set of numeric addresses you need to connect to the network, as they are not assigned automatically.

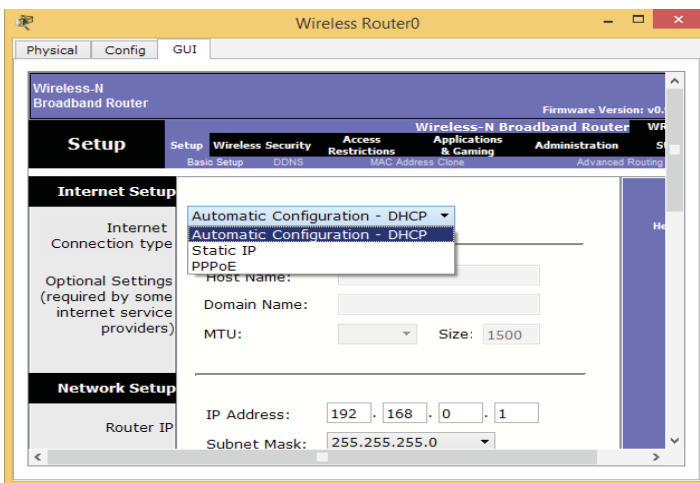

Figure 2.15: Broadband connection methods

Step 5: Configure your broadband connection

On this model, you clicked the "Setup" menu and "Basic setup" submenu. Again, your model may differ, and newer models may include a guided wizard that takes you through these steps.

Step 6: Configure your wireless network basics

If your router is connected to broadband and it is working successfully, we can setup the wireless networking configuration. On our sample router we clicked the "**Wireless**" submenu.

Assign your wireless network a name, also known as Service Set Identifier (SSID). Choose a unique name in case there may be neighboring wireless routers nearby.

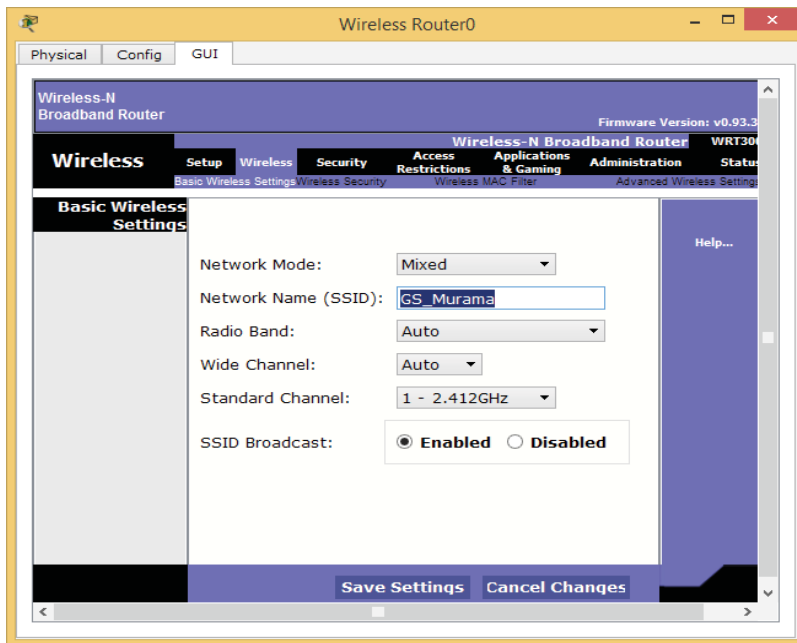

Figure 2.16: Basic wireless settings

Step 7: Configure your wireless security

Most wireless network users will select one of four degrees of encryption security available in wireless hardware today.

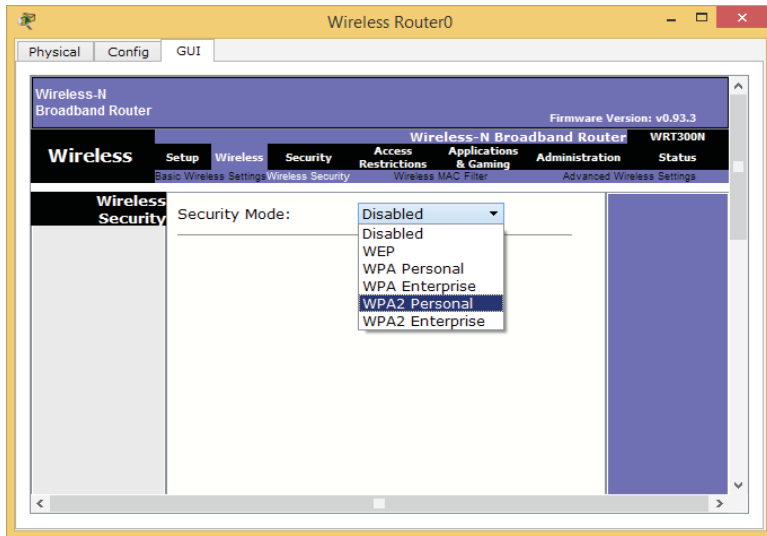

Figure 2.17: Encryption security modes

1. WEP: The oldest and least secure data encryption. All wireless gear supports WEP, though, it is useful when you need at least some kind of encryption to be compatible with older wireless hardware.
2. WPA: A more secure upgrade to WEP. Designed so that many older devices which included only WEP can be upgraded to support WPA.
3. WPA2: A significantly more secure upgrade to either WEP or WPA. Cannot upgrade older hardware to WPA2, but many new wireless devices support WPA2.

Note: At each step you must click on the “save Settings” button before you proceed with the next step

2.4.3.1 Router Operation Mode

Many of the routers offers different operation modes that you can use.

a. Wireless Router Mode

In wireless router/ IP sharing mode, the router connects to the Internet via PPPoE, DHCP, PPTP, L2TP, or Static IP and shares the wireless network to LAN clients or devices. Select this mode if you are a first-time user or you are not currently using any wired/wireless routers.

b. Repeater Mode

In Repeater mode, your router wirelessly connects to an existing wireless network to extend the wireless coverage. You will generally use repeaters or wireless extenders

when you have hard to reach places with your home Wi-Fi setup.

c. Access Point (AP) Mode

In Access Point (AP) mode, the router connects to a wireless router through an Ethernet cable to extend the wireless signal coverage to other network clients. This mode is best to be used in an office, hotel, and places where you only have wired network.

d. Media Bridge or Client Mode

With client mode or media bridge, it can connect to a wired device and works as a wireless adapter to receive wireless signal from your wireless network. The reason for this mode is that it can increase the speed of your wireless connection so that it matches the speed of the Ethernet connection.

2.4.3.2 Default gateway

A default gateway is used to allow devices in one network to communicate with devices in another network. If your computer, for example, is requesting an Internet webpage, the request first runs through your default gateway before exiting the local network to reach the Internet.

An easier way to understand a default gateway might be to think of it as an intermediate device between the local network and the Internet.

a. Configuring the default gateway on a wireless router

Start packet tracer, add a wireless router and do the following:

- Click on wireless router and go to GUI tab.
- Set the Internet Connection type to Static IP.
- Configure the IP addressing according to the figure below.
- Scroll down and click on Save Settings.

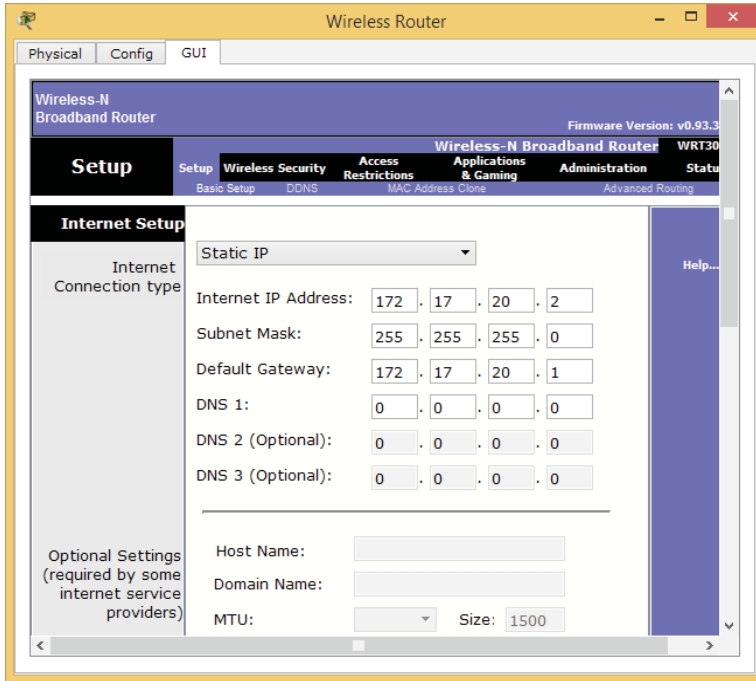

Figure 2.18: Default gateway configuration

b. How to find your default gateway IP address

You might need to know the IP address of the default gateway if there is a network problem or if you need to make changes to your router.

- In Microsoft Windows, the IP address of a computer's default gateway can be accessed through **Command Prompt** with the **ipconfig** command, as well as through the **Control Panel**.
- The **netstat** and **ip route** commands are used on macOS and Linux for finding the default gateway address.

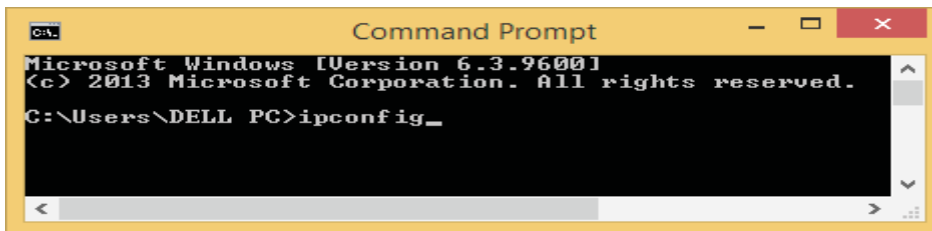

Figure 219: The command prompt window

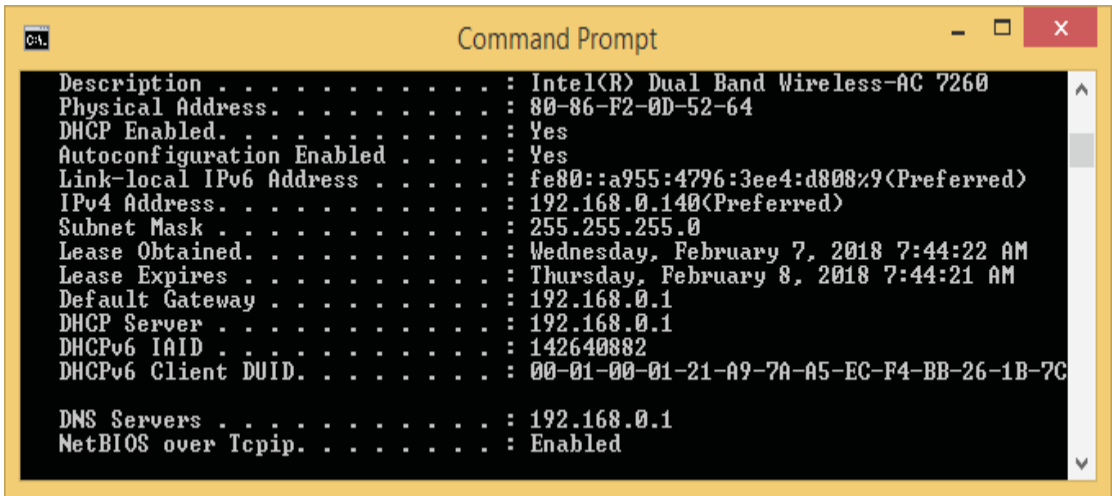

Figure 2.20: Default gateway

c. Configuring a default gateway on a desktop

- Open the control panel
- Click on Network and Internet
- Click on Network and sharing center
- Click on adapter settings

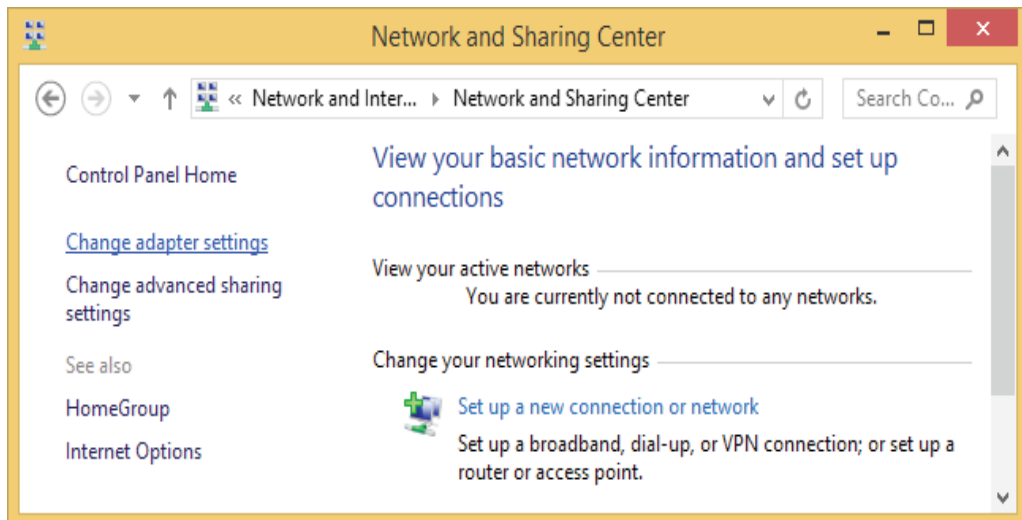

Figure 2.20: Network and sharing center

- Right click on wi-fi and choose properties

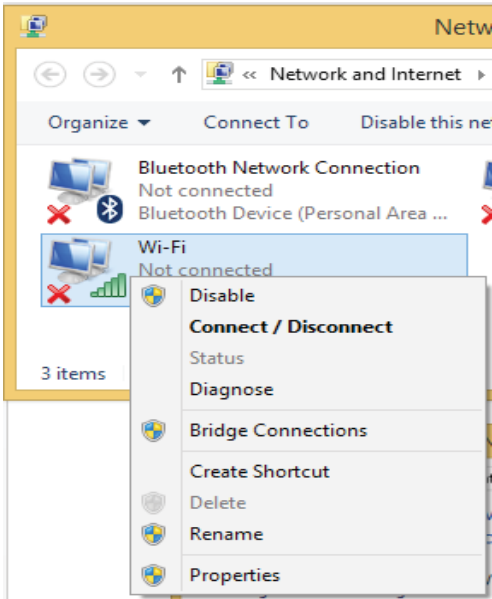

Figure 2.21: Wi-Fi properties 1

- Choose Internet Protocol Version 4 (TCP/IPv4) and click on properties

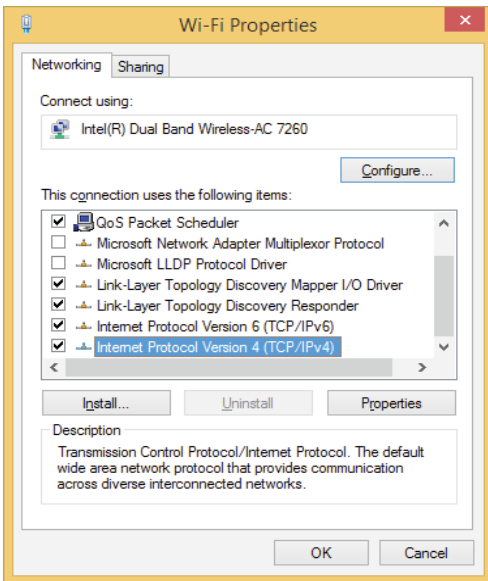

Figure 2.22: Wi-Fi properties 2

- Enter IP address as follows and then click on OK:

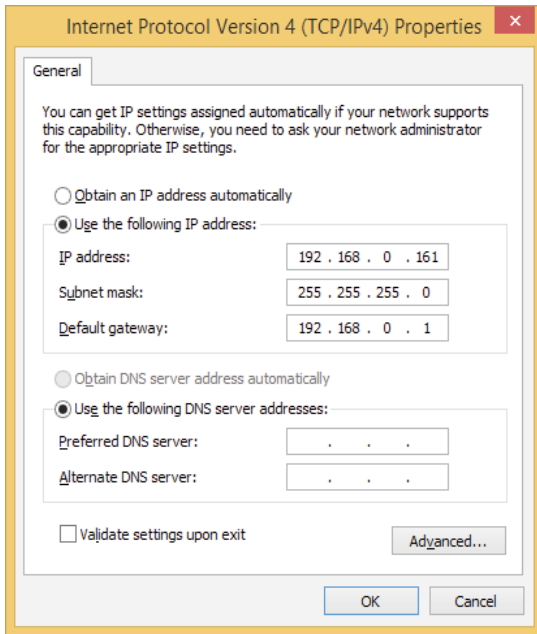

Figure 2.23: TCP/IP properties

2.4.4 Public and private IP

2.4.4.1 Public IP addresses

A public IP address is the one that your ISP (Internet Service Provider) provides to identify your home network to the outside world. It is an IP address that is unique throughout the entire Internet. A public IP address is worldwide unique, and can only be assigned to a unique device

Depending on your service, you might have an IP address that never changes (a fixed or static IP address). But most ISPs provide an IP address that can change from time to time (a dynamic IP address)

Example: Web and email servers directly accessible from the Internet use public IP addresses.

2.4.4.2 Private IP addresses

A private IP address provides unique identification for devices that are within your Local Area Network, such as your computer, your smartphones, and so on. If every

device on every network had to have real routable public IP addresses, we would have run out of IP addresses to hand out years ago. Private IP addresses are used for the following reasons:

- To create addresses that cannot be routed through the public Internet
- To conserve public addresses

Examples:

- Computers, tablets and smartphones within an organization are usually assigned private IP addresses.
- A network printer residing in your school computer lab is assigned a private address so that only users within computer lab can print to your local printer.
- Notice that IP addresses, public or private, are assigned to devices according to network classes. The most used classes are A, B and C. They differ according to the number of networks and hence to the number of IP addresses in one network. From A to C, the number of possible networks increase while number of available IP addresses in a network reduces.

Address Class	Reserved Address Space
Class A	10.0.0.0 through 10.255.255.255
Class B	172.16.0.0 through 172.31.255.255
Class C	192.168.0.0 through 192.168.255.255

Table 2. 4: *Reserved IP Address Space*

2.4.5 Configuring a wireless Access Point

The physical setup for a wireless access point is pretty simple: you take it out of the box, put it on a shelf or on top of a bookcase near a network jack and a power outlet, plug in the power cable, and plug in the network cable.

To get to the configuration page for the access point, you need to know the access point's IP address. Then, you just type that address into the address bar of a browser from any computer on the network.

For example to configure TP-Link TL-WA701ND Access Point you will follow the following steps:

Step 1: Power the TP-Link TL-WA701ND using the barrel jack or PoE (Power-over-

Ethernet) injector, and connect a computer to the access point using an Ethernet cable (if using the PoE injector, connect the LAN port to your computer, and the POE port to the access point).

Step 2: Ensure all wireless interfaces are disabled on the computer (such as WiFi and Bluetooth) and that DHCP is enabled on the Ethernet interface. Open a web browser and access the TL-WA701ND by entering 192.168.0.254 into the address bar.

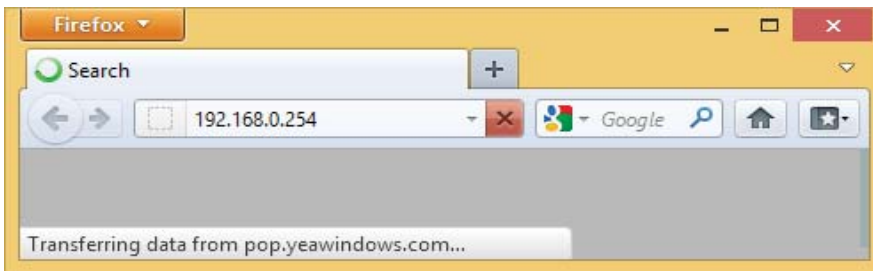

Figure 2.24: Entering Access Point default IP address

Step 3: Log in using username admin and password admin

Step 4: The Quick Setup wizard will load in the browser. Click Next to start the configuration process.

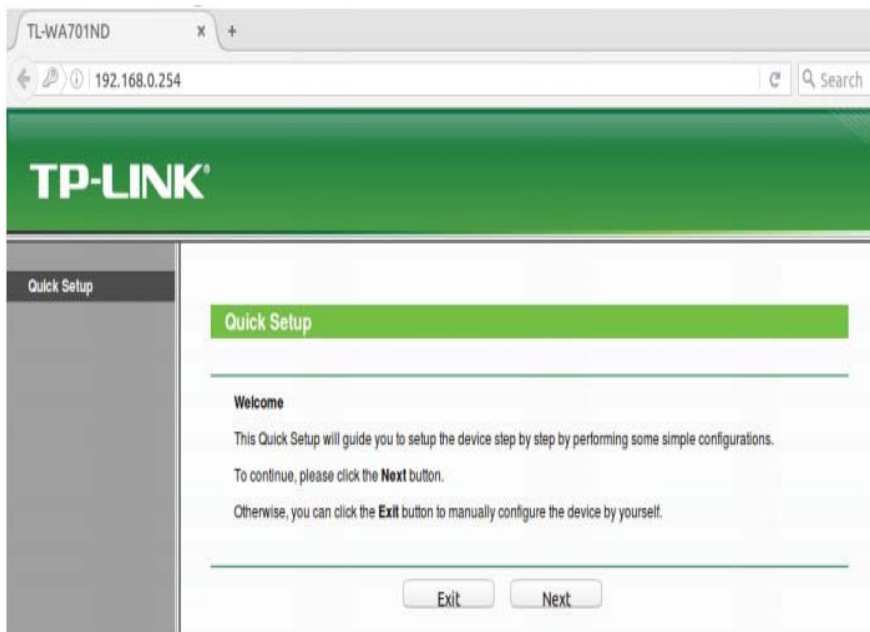

Figure 2.25: Quick setup window

Step 5: Select Client from the list of operating modes. Click Next.

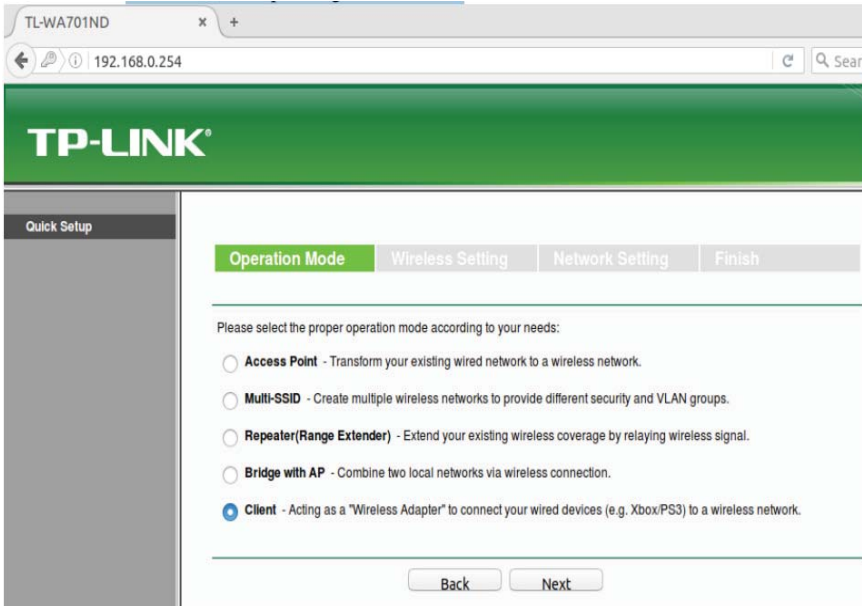

Figure 2.26: Operation mode

Step 6: Click Survey to scan for a list of available wireless access points. Alternatively, skip to step 8 and manually enter information.

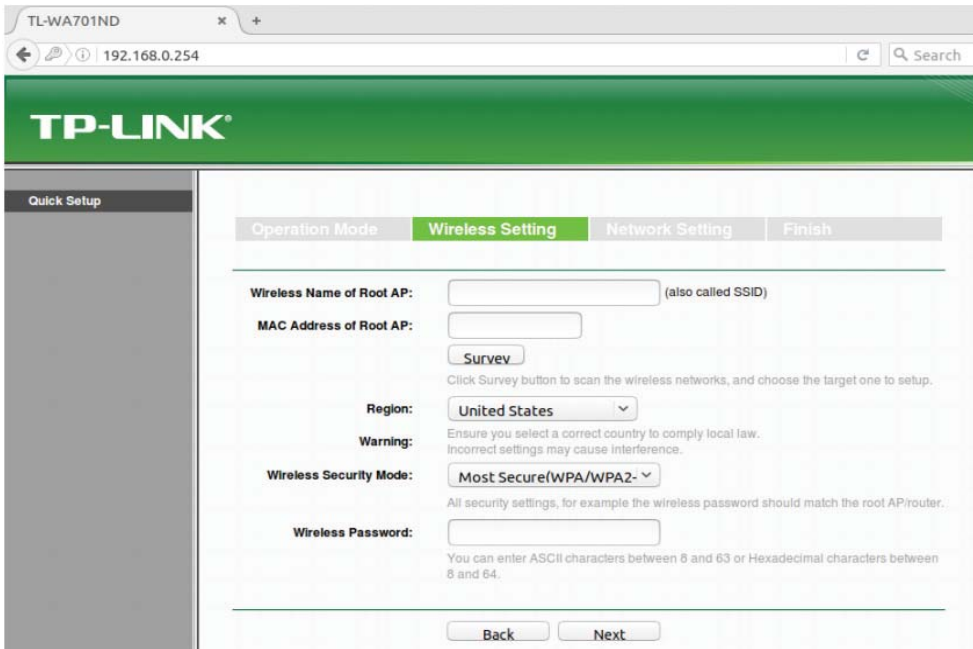

Figure 2.27: Wireless settings

Step 7: From the list of available WiFi networks, select the network to use by clicking Connect to the far right. Make sure the network has a good connection by checking the signal strength. The higher the number, the stronger the connection.

AP List						
AP Count: 40						
ID	BSSID	SSID	Signal	Channel	Security	Choose
13	A2-E5-47-82-33-EA	MyWiFi	60dB	2	WPA2-PSK	Connect
14	1B-7C-CF-E7-3D-4C	MyGuestNetwork	40dB	2	WPA2-PSK	Connect
15	05-1D-85-59-32-97	NeighborsWiFi	13dB	6	WPA2-PSK	Connect
16	09-95-AA-BD-3E-73	FarAwayWiFi	2dB	6	OFF	Connect

Figure 2.28: Existing wireless

Step 8: Once the Connect option is clicked, these fields will automatically fill in. Alternatively, enter the Wireless Name (SSID) and Wireless Security Mode and Wireless Password. The wireless security settings will need to be manually entered for any password protected WiFi network. Click Next.

The screenshot shows the TP-Link Quick Setup interface. The browser address bar shows the IP address 192.168.0.254. The page has a green header with the TP-LINK logo. Below the header, there are four tabs: Operation Mode, Wireless Setting (selected), Network Setting, and Finish. The main content area contains the following fields and options:

- Wireless Name of Root AP:** Home-WiFi (also called SSID)
- MAC Address of Root AP:** IE-23-C4-9F-00-1D
- Survey:** A button to scan for wireless networks.
- Region:** A dropdown menu set to United States.
- Warning:** A message: "Ensure you select a correct country to comply local law. Incorrect settings may cause interference."
- Wireless Security Mode:** A dropdown menu set to Most Secure(WPA/WPA2).
- Wireless Password:** password1234
- Instructions:** "All security settings, for example the wireless password should match the root AP/router. You can enter ASCII characters between 8 and 63 or Hexadecimal characters between 8 and 64."

At the bottom of the form, there are two buttons: Back and Next.

Figure 2.29: Setting wireless name

Step 9: The default values are typically fine for these settings. If needed, obtain the correct settings from the network administrator. Be sure to make a note/take a screenshot of the IP address set in this step, as it will replace the original fallback IP address. When the correct settings have been applied, click Next.

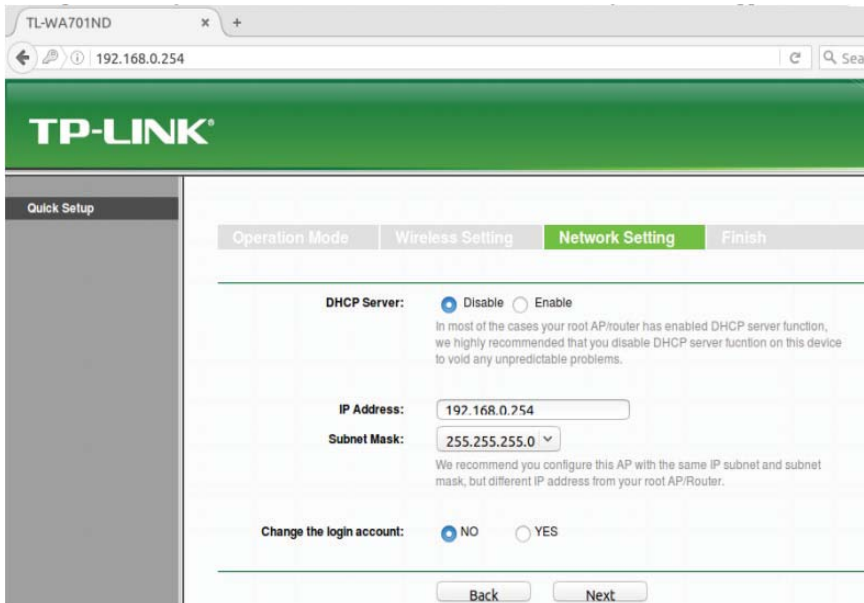

Figure 2.30: Network settings

Step 10: Make a note or take a screenshot of the applied settings if desired, then click Save.

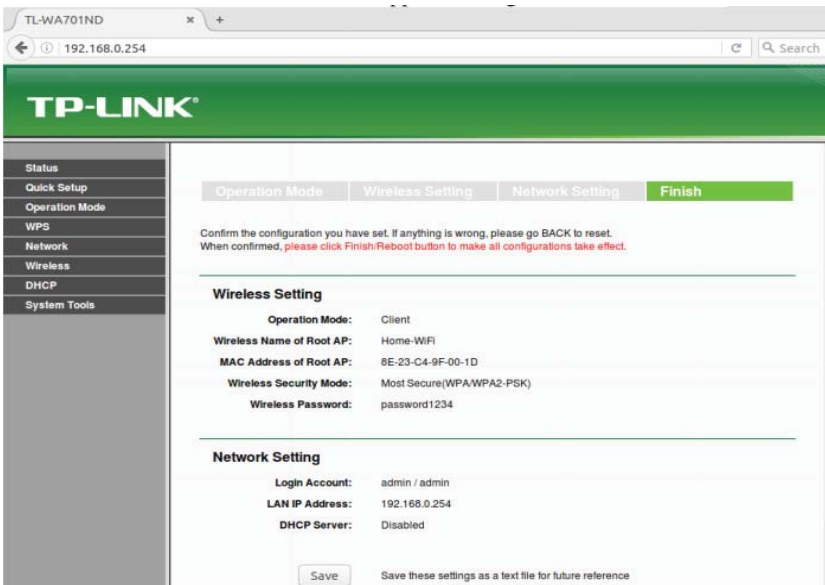

Figure 2.31: Summary of configuration

Step 11: The device will reboot. The configuration page will likely not load; try loading a web-page (e.g. <http://www.irembo.gov.rw>) while the TP-Link Access Point is connected to the computer to see if there is Internet connectivity.

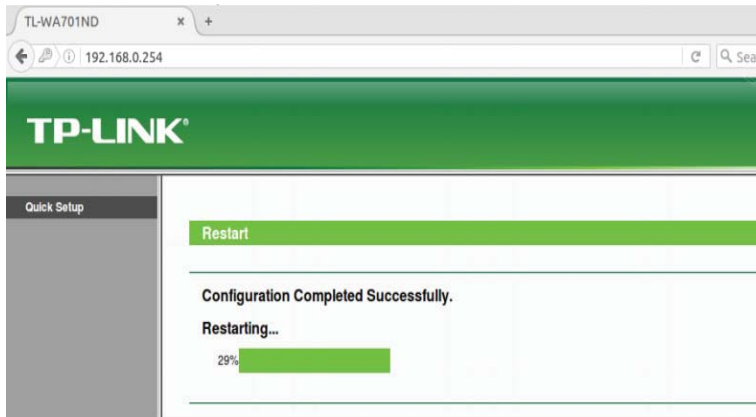

Figure 2.32: Access Point reboot

Step 12: Troubleshooting

- The TP-Link TP-WA701ND does not have any LEDs illuminated
 - *Ensure the access point has power either directly to the barrel jack on the back, or via the POE injector's POE Ethernet port. The POE injector requires power via barrel jack.
 - *Verify the ON/OFF button next to the access point's Ethernet port is depressed in the ON position.
- I cannot access the device configuration page.
 - *The TP-Link WA701ND has a default fallback IP address of 192.168.0.254. To access the device configuration pages, connect a computer directly via an Ethernet cable, configure the computer to use an IPv4 address in the same range (for example, 192.168.0.100), open a web browser, and enter the fallback IP address of 192.168.0.254 in the address bar. If you changed the IP address on the Network Setting page during configuration step 9, use that IP address instead.
- I cannot access the device at all (lost credentials, major configuration issue, etc)
 - *The TP-Link TL-WA701ND has a recessed reset button located on the back of the device. This button is closest to the antenna, and a pin or paperclip is needed to press it. Hold the button down for 8+ seconds. All of the LEDs should turn off and back on; after this the initial configuration steps can be used to gain access. Note that this will reset all device settings to the factory default.

2.4.5 How to connect to the Internet through your wireless access point?

a. Connecting to Internet through the control panel

- Open the windows control panel, and then click network and Internet.
- The Network and Internet window appears.

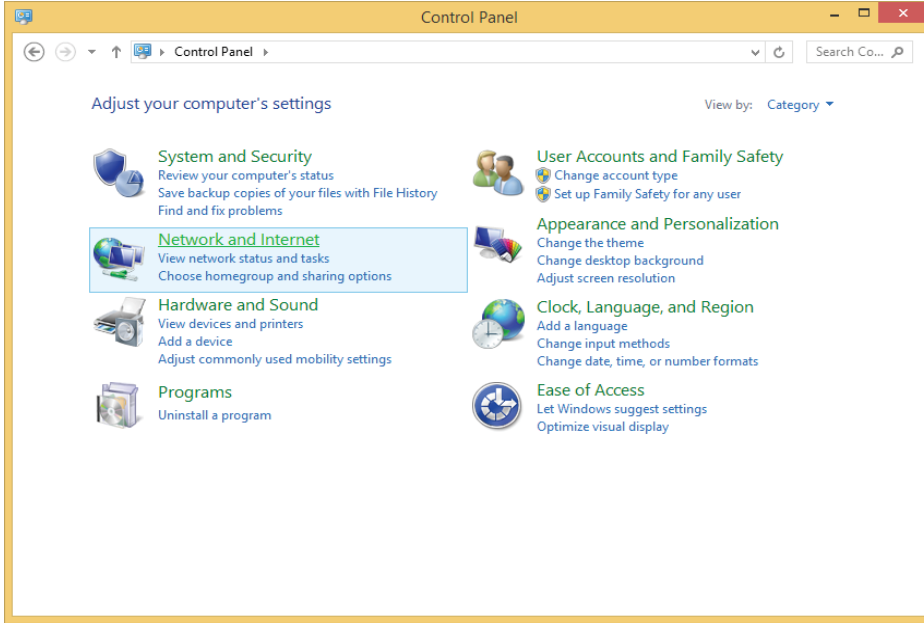

Figure 2.33: The Network and Internet window

- Click network and sharing center.
- The Network and Sharing Center window appears.
- Click set up a new connection or network.

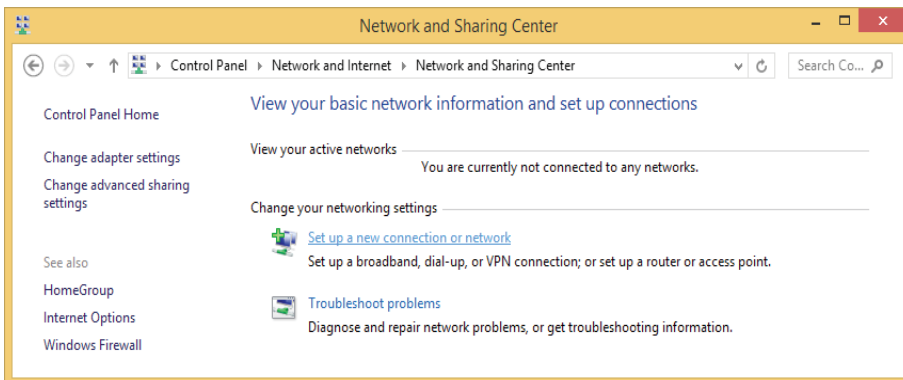

Figure 2.34: Set up a new connection of network

- Set up a Connection or Network window appears.
- Click Manually connect to a wireless network

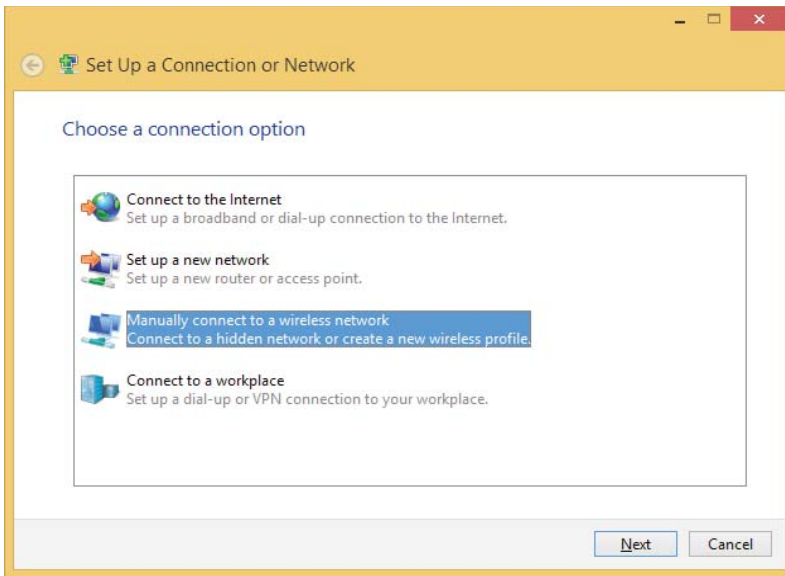

Figure 2.47: Manually connect to a wireless network window

- Click Manually connect to a wireless network
- Enter your wireless name in the Network name textbox, for example in our case we want to connect to “WirelessAP”
- Choose WPA2-Personal for security type
- Choose AES for encryption type
- Type wireless key in the security key textbox
- Click next

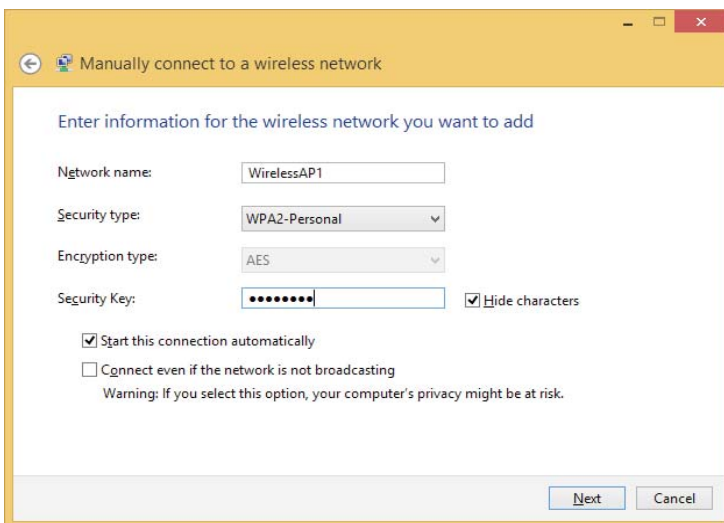

Figure 2. 35: Wireless information captured

- Click next
- Click close

b. Connecting to the Internet through the Taskbar

1. Select the Network icon in the notification area.

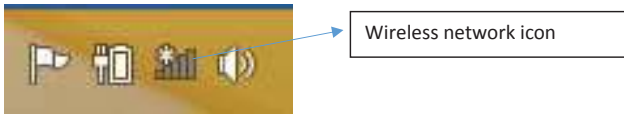

Figure 2.36: Wireless notification icon

2. In the list of networks, choose the network that you want to connect to, and then select Connect.
3. Type the security key (often called the password).
4. Follow additional instructions if there are any.

2.4.7 Wireless Access Point vs Router

The Wireless Access Points (AP) and routers play the similar role but they have some differences. They all connect different networks. A router often has an Access Point built-in, but a standalone Access Point can't be a router. An AP can be compared to a modem which is limited in its functionality on managing multiple devices or controlling an entire network with many devices. Routers on the other hand can manage an entire home or small business giving network capability to many computers and devices simultaneously.

2.4.7.1 Wireless Access Point Functions

APs give wireless network ability to any device that only has a hard-wired connection. It is done by plugging in an Ethernet cable and the AP would then communicate with WiFi devices and giving them network access. .

For example a printer that has no built-in wireless can have a access point added which will give it wireless ability.

While current routers have built-in WiFi and play many roles including being an AP, many don't use dedicated APs. APs are still used in many networks and they are used to help with WiFi dead spots and extending a wireless network.

An AP can be added in locations that have bad wireless network ability and give good coverage throughout a home or business.

2.4.7.2 Router Functions

From the above section, a router is a network device that can transfer data wirelessly or wired. It forwards data packets to the desired device and control LAN (local Area Networks) or WAN (Wide Area Networks) networks

2.4.7 SSID and encryption

2.4.7.1 SSID and Wireless Networking

An SSID (Service Set Identifier) is the primary name associated with an 802.11 Wireless Local Area Network (WLAN) including home networks and public hotspots. Client devices use this name to identify and join wireless networks.

When you right click on the icon of wireless network in the Task Bar (Bottom Right of the computer's screen), the displayed list of names of different networks are the SSID that are covered now or have been used in past.

On home Wi-Fi networks, a broadband router or broadband modem stores the SSID but allows administrators to change it. Routers can broadcast this name to help wireless clients find the network. Router manufacturers set a default SSID for the Wi-Fi unit, such as Linksys, xfinitywifi, NETGEAR, dlink or just default. However, since the SSID can be changed, not all wireless networks have a standard name like that.

2.4.7.2 Wireless fundamentals: Encryption and authentication

Wireless encryption and authentication help users to make an educated decision on what type of security to implement into their wireless network. There exist different types of encryption and authentication. For example, CISCO Meraki is using the following:

types of encryption and authentication	Explanations
WEP	Wired Equivalent Privacy, now depreciated, was part of the original 802.11 standard. WEP utilized a 40-128 bit key that was a combination of a key (string of hexadecimal characters) and an initialization vector. Cisco Meraki Access Points support pre-shared key WEP authentication. WEP was deemed insecure due to how easy it could be decoded but is still available in Cisco Meraki equipment for legacy devices.

WPA	<p>Wi-Fi Protected Access, WPA, was created to “patch” the issues with WEP, allowing users to update their equipment with a firmware update as opposed to buying brand new hardware. WPA included a new type of key system called TKIP (Temporal Key Integrity Protocol.) TKIP develops a unique encryption key for each wireless frame facilitating a more secure connection. However, TKIP is susceptible to wireless attacks and is no longer considered the Enterprise standard.</p>
WPA2 - PSK (Pre Shared Key)	<p>WPA2 is currently the most secure standard utilizing AES (Advanced Encryption Standard) and a pre-shared key for authentication. WPA2 is backwards compatible with TKIP to allow interoperability with legacy devices. AES uses CCMP encryption protocol which is a stronger algorithm for message integrity and confidentiality. By default, SSIDs on Cisco Meraki access points that are configured as WPA2 utilize a combination of both TKIP and AES encryption.</p>
WPA2 - Enterprise	<p>WPA2 Enterprise utilizes authentication on a user level, using the 802.1x standard, along with the features of WPA2 such as AES. Cisco Meraki fully supports WPA2 Enterprise association with RADIUS and PEAP/MSCHAPv2, or Meraki Authentication, to provide a secure wireless network for enterprise use. Users log in with a valid username and password to authenticate instead of a pre-shared key susceptible to social engineering.</p>
Splash Page	<p>Cisco Meraki provides a variety of splash pages that can be utilized for additional security.</p> <p>Sign on with Authentication - Forces users to authenticate through a sign on page using various types of Authentication including RADIUS, LDAP, and Meraki Authentication.</p> <p>Sign on with SMS Authentication - Forces users to authenticate with an SMS code that they would receive on their phone.</p> <p>Systems Manager Sentry - Utilizes Cisco Meraki Systems Manager, users will need to install the manager client on their computer, their device can then be viewed on a Systems Manager network.</p> <p>Splash Pages can be used with or without a WPA/WEP solution as well.</p>
Hidden SSID	<p>A hidden SSID can prevent public visibility of your corporate SSID. Hidden SSID requires a manual creation of a wireless profile in order for the wireless client to initiate association. Although packet sniffers can detect SSID names from other probe requests and association frames, disabling SSID broadcasts can dissuade many would-be attackers from trying to gain access.</p>

Application activity 2.4:

A. Look around your school computer lab and do the following:

- Uninstall and reinstall wireless adaptors into your desktops
- Switch on your computers and check whether wireless drivers are installed.
- Using your computers, check for available wireless signal?
- Login into your wireless router and change its SSID to “NetworkingLab”.
- What is the IP address of your computer?
- Discuss the advantages of protecting your wireless network with a password?

B. Using one smart phone, setup a computer network made of your laptops. Describe how to connect to that network. What is the name of the network? Change that name and set up a new password.

2.5 computer Network Protocols

Activity 2.5:

The school computer lab has 20 computers connected to the Local Area Network and Internet. Using his computer, the teacher wishes to get a copy of 40 MB document in all computers but he does not have any storage devices to facilitate the task. In groups, discuss possible ways to obtain this document in all computers in laboratory. Apply your proposed solutions.

2.5.1 Definition

A network protocol defines rules and conventions for communication between network devices. Network protocols include mechanisms for devices to identify and make connections with each other, as well as formatting rules that specify how data is packaged into messages sent and received.

Network protocols are grouped such that each one relies on the protocols that underlie it sometimes referred to as a protocol stack. The key network protocols are the following:

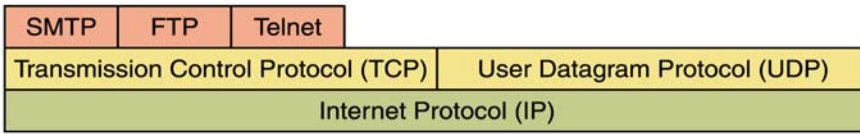

Figure 2.37: Layering of key network protocols

2.5.1 Most used protocols

The most used protocols with their descriptions are given in the following table.

Protocol Name	Description
Simple Mail Transfer Protocol (SMTP)	The Simple Mail Transfer Protocol (SMTP) is used to transfer electronic mail from one user to another. This task is done by means of email client software (User Agents) the user is using. While SMTP is used by end user to only send the emails, the Servers normally use SMTP to send as well as receive emails. Client software uses Internet Message Access Protocol (IMAP) or Post Office Protocol (POP) protocols to receive emails.
File Transfer Protocol (FTP)	The File Transfer Protocol (FTP) is the most widely used protocol for file transfer over the network. It is the standard mechanism provided by TCP/IP for copying a file from one host to another.
Terminal Network (TELNET)	TELNET is an abbreviation for TERminal NETwork. It is the standard TCP/IP protocol for virtual terminal service as proposed by the International Organization for Standards (ISO). TELNET enables the establishment of a connection to a remote system in such a way that the local terminal appears to be a terminal at the remote system.

<p>Transmission Control Protocol / Internet Protocol (TCP/IP)</p>	<p>TCP stands for “Transmission Control Protocol”</p> <p>TCP software breaks messages into packets, hands them off to the IP software for delivery, and then orders and reassembles the packets at their destination</p> <p>IP stands for Internet Protocol</p> <p>Internet Protocol (IP) is the principal set of digital message formats and rules for exchanging messages between computers across a single network or a series of interconnected networks, using the Internet Protocol Suite (often referred to as TCP/IP).</p> <p>TCP/IP</p> <p>The Transmission Control Protocol/Internet Protocol (TCP/IP) is the language a computer uses to access the Internet. It consists of a suite of protocols designed to establish a network of networks to provide a host with access to the Internet. TCP/IP can also be used as a communication protocol in a private network (an intranet or an extranet).</p>
<p>User Datagram Protocol (UDP)</p>	<p>It is an alternative to TCP. The main difference is that TCP is highly reliable, at the cost of decreased performance, while UDP is less reliable, but generally faster.</p>
<p>Post Office Protocol version 3 (POP3)</p>	<p>Post Office Protocol version 3 (POP3) is a standard mail protocol used to receive emails from a remote server to a local email client. POP3 allows you to download email messages on your local computer and read them even when you are offline. Note, that when you use POP3 to connect to your email account, messages are downloaded locally and removed from the email server.</p> <p>By default, the POP3 protocol works on two ports:</p> <p>Port 110 - this is the default POP3 non-encrypted port</p> <p>Port 995 - this is the port you need to use if you want to connect using POP3 securely</p>

<p>Internet Message Access Protocol (IMAP)</p>	<p>The Internet Message Access Protocol (IMAP) is a mail protocol used for accessing email on a remote web server from a local client. IMAP and POP3 are the two most commonly used Internet mail protocols for retrieving emails. Both protocols are supported by all modern email clients and web servers.</p> <p>While the POP3 protocol assumes that an email is being accessed only from one application, IMAP allows simultaneous access by multiple clients. This is why IMAP is more suitable for the user if he/she is going to access his/her email from different locations or if his/her messages are managed by multiple users.</p> <p>By default, the IMAP protocol works on two ports:</p> <p>Port 143 - this is the default IMAP non-encrypted port</p> <p>Port 993 - this is the port someone needs to use if he/she wants to connect using IMAP securely.</p>
<p>Dynamic Host Configuration Protocol (DHCP)</p>	<p>Dynamic Host Configuration Protocol (DHCP) is a protocol that automatically provides an Internet Protocol (IP) host with its IP address and other related configuration information such as the subnet mask and default gateway.</p>
<p>Hypertext Transfer Protocol (HTTP)</p>	<p>The Hypertext Transfer Protocol (HTTP) is a protocol used mainly to access data on the World Wide Web. HTTP functions as a combination of FTP and SMTP.</p>
<p>Hypertext Transfer Protocol Secure (HTTPS)</p>	<p>Hyper Text Transfer Protocol Secure (HTTPS) is the secure version of HTTP, the protocol over which data is sent between your browser and the website that you are connected to. It means that all communications between your browser and the website are encoded. HTTPS is often used to protect highly confidential online communications like online banking and online shopping order forms.</p> <p>Web browsers such as Internet Explorer, Firefox and Chrome also display a padlock icon in the address bar to visually indicate that a HTTPS connection is in effect.</p>

Secure Shell (SSH)	The Secure Shell (SSH) protocol is a method for securing remote log-in from one computer to another. It is a secure alternative to the non-protected login protocols (such as telnet, rlogin) and insecure file transfer methods (such as FTP).
Some of the other most used protocols	<p>Network Basic Input/output System (NetBIOS)</p> <p>NetBIOS Extended User Interface (NetBEUI)</p> <p>Address Resolution Protocol (ARP)</p> <p>Domain Name System (DNS)</p> <p>Internet Control Message Protocol (ICMP)</p> <p>Internet Group Management Protocol (IGMP)</p> <p>Internet Message Access Protocol version 4 (IMAP4)</p> <p>Trivial File Transfer Protocol (TFTP)</p>

Application activity 2.5:

1. Discuss the role of protocols in computer communication?
2. Search on Internet a free application called FileZilla Client and FileZilla Server using FTP to get access remotely to documents on another computer in the school computer lab. Copy to /from any document between the 2 computers.

2.6 OSI model

Activity 2.6:

Fill in the blanks with the appropriate device between hub, switch and router.

Description	Device
This device sends and receives information about the Network layer.	
This device uses hardware addresses to filter a network.	
This device can measure the distance to a re-mote network.	

2.6.1 Definition

Open System Interconnect (OSI) is an open standard for all communication systems. OSI model is established by International Standard Organization (ISO). It is a general-purpose model for discussing or describing how computers communicate with one another over a network. Its seven-layered approach to data transmission divides the many operations up into specific related groups of actions at each layer.

Table 2. 5: *Data flow in OSI layers*

Transmitting device					Receiving device	
Application software					Application software	
↓	7	Application	7	↑		
↓	6	Presentation	6	↑		
↓	5	Session	5	↑		
↓	4	Transport	4	↑		
↓	3	Network	3	↑		
↓	2	Data link	2	↑		
↓	1	Physical	1	↑		

In the OSI model, data flows down the transmit layers, over the physical link, and then up through the receive layers. The transmitting computer software gives the data to be transmitted to the applications layer, where it is processed and passed from layer to layer down the stack with each layer performing its designated functions. The data is then transmitted over the physical layer of the network until the destination computer or another device receives it. At this point the data is passed up through the layers again, each layer performing its assigned operations until the data is used by the receiving computer's software. The roles of OSI model layers are:

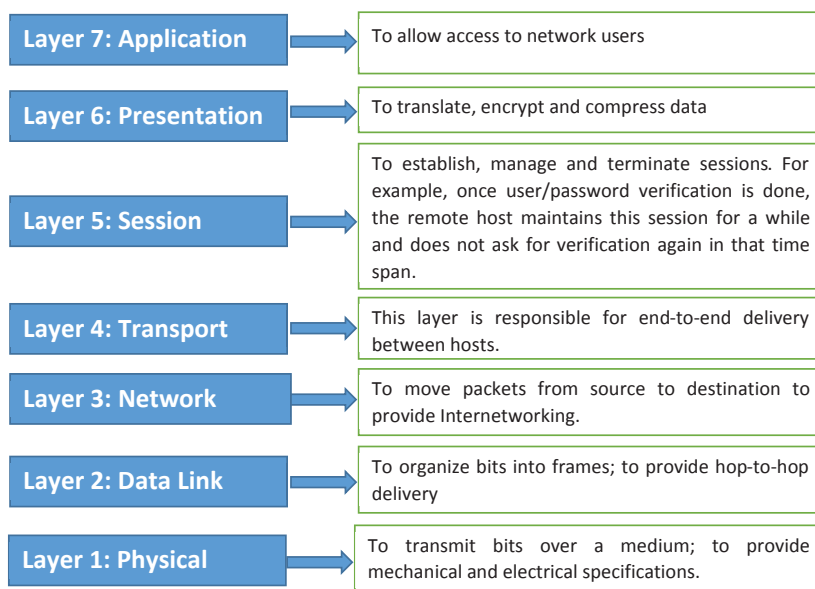

Figure 2.37: Layers in OSI Model

a. The Application Layer

The application layer enables the user, whether human or software, to access the network. It provides user interfaces and support for services such as domain name service (DNS), file transfer protocol (FTP), hypertext transfer protocol (HTTP), Internet message access protocol (IMAP), post office protocol (POP), simple mail transfer protocol (SMTP), Telenet, and terminal emulation. Devices used in this layer are Gateways, Firewalls, and all end devices like PC's, Phones, and Servers.

b. The Presentation Layer

It presents data to the Application layer and is responsible for data translation and code formatting.

The presentation layer is concerned with the syntax and semantics of the information exchanged between two systems.

Specific responsibilities of the presentation layer include the following:

- Translation
- Encryption
- Compression

Devices which operate at this layer are Gateways, Firewalls and PC's.

c. The Session Layer

The Session layer is responsible for setting up, managing, and then destroying down sessions between Presentation layer entities. This layer also provides dialogue control between devices, or nodes.

It coordinates communication between systems and serves to organize their communication by offering three different modes of communication: simplex, half duplex, and full duplex.

Specific responsibilities of the session layer include the following:

- Dialog control
- Synchronization

The devices used at this layer are Gateways, Firewalls, and PC's.

d. The Transport Layer

The Transport layer segments and reassembles data into a data stream. Services located in the transport layer segment and reassemble data from upper-layer applications and unite it onto the same data stream. They provide end-to-end data transport services and can establish a logical connection between the sending host and destination host on an internetwork. At this layer we find devices like Gateways and Firewalls.

e. The Network Layer

The Network layer manages device addressing, tracks the location of devices on the network, and determines the best way to move data, which means that the Network layer must transport traffic between devices that are not locally attached. Routers (layer 3 devices) are specified at the Network layer and provide the routing services within an Internetwork.

The network layer is responsible for the delivery of individual packets from the source host to the destination host.

Two activities are performed:

- **Logical addressing:** IP addressing
- **Routing:** Source to destination transmission between networks

f. The Data Link Layer

The Data Link layer formats the message into pieces, each called a data frame, and adds a customized header containing the hardware destination and source address. This added information forms a sort of capsule that surrounds the original message. To allow a host to send packets to individual hosts on a local network as well as transmit packets between routers, the Data Link layer uses hardware addressing. Switches and bridges work at the Data Link layer and filter the network using hardware (MAC) addresses.

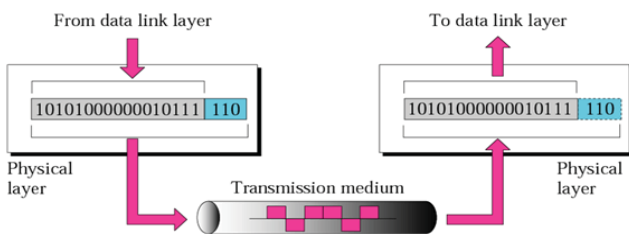

Figure 2.38: Data Link layer task illustration

Source: <http://computernetworkingonlinehelp.com/PhysicalLayer.php>

g. The Physical Layer

Finally arriving at the bottom, the Physical layer does two things: It sends bits and receives bits. Bits come only in values of 1 or 0. The Physical layer communicates directly with the various types of actual communication media.

The Physical layer specifies the electrical, mechanical, procedural, and functional requirements for activating, maintaining, and deactivating a physical link between end systems. This layer is also where you identify the interface between the data terminal equipment (DTE) and the data communication equipment (DCE). Devices like Hubs, Repeaters, Cables, and Fibers operate at this layer.

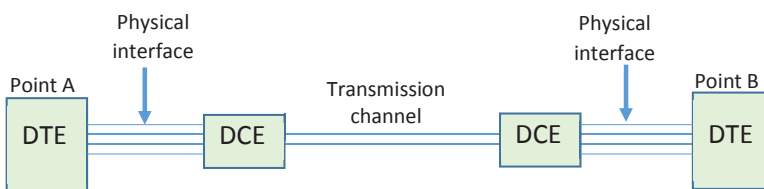

Figure 2.39: Physical layer

Notice that the following network devices operate on all seven layers of the OSI model:

- Network management stations (NMSs)
- Web and application servers
- Gateways (not default gateways)
- Network hosts

2.6.2 Advantages of using the OSI layered model

1. It divides the network communication process into smaller and simpler components, thus aiding component development, design, and troubleshooting.
2. It allows multiple-vendor development through standardization of network components.
3. It encourages industry standardization by defining what functions occur at each layer of the model.
4. It allows various types of network hardware and software to communicate.
5. It prevents changes in one layer from affecting other layers, so it does not hamper hardware or software development.

Application activity:

1. Which layer of the OSI model creates a virtual link between hosts before transmitting data?
2. What is the main reason of the creation of OSI model?
3. Describe each one of the 7 layers of the OSI model.
4. Which layer is responsible for converting data packets from the Data Link layer into electrical signals?
5. At which layer is routing implemented, enabling connections and path selection between two end systems?
6. Which layer defines how data is formatted, presented, encoded, and converted for use on the network?
7. Which layer is responsible for creating, managing, and terminating sessions between applications?
8. Search on Internet and propose the format of a packet sent between 2 computers through the

2.7 TCP/IP model

Learning activity 2.7:

One teacher at your school wants to send a 50MB file to students' emails but when he tries to attach it the email server rejects because of the size limit. It says that it cannot upload files larger than 20MB.

1. What are other alternative to share this file?

2.7.1 Introduction

The TCP/IP protocol suite was developed prior to the OSI model. Therefore, the layers in the TCP/IP protocol suite do not exactly match those in the OSI model. TCP/IP model is the combination of TCP as well as IP models. This model ensures that data received is same as the data sent, and the data bytes are received in sequence. This model mainly defines how data should be sent (by sender) and received (by receiver). Most common examples of applications using this model include the email, media streaming, or World Wide Web (WWW). Presentation and session layers OSI model are not there in TCP/IP model.

TCP/IP model comprises 4 layers that are as follows:

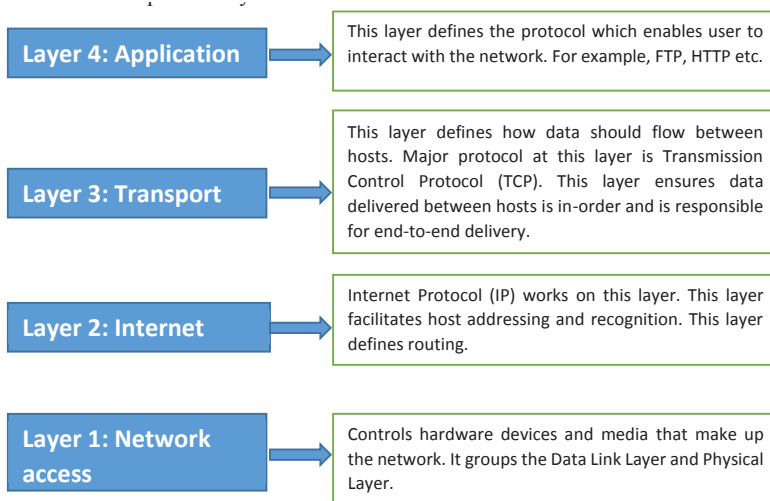

Figure 2.40: TCP/IP layers

1. Application Layer

Application layer is the top most layer of four layers TCP/IP model. Application layer is present on the top of the Transport layer. Application layer defines TCP/IP application protocols and how host programs interface with Transport layer services to use the network.

It groups the functions of OSI Application, Presentation and Session Layers. It includes protocols like:

- The Hypertext Transfer Protocol (HTTP) is used to transfer files that make up the Web pages of the World Wide Web.
- The File Transfer Protocol (FTP) is used for interactive file transfer.
- The Simple Mail Transfer Protocol (SMTP) is used for the transfer of mail messages and attachments.
- Telnet, a terminal emulation protocol, is used for logging on remotely to network hosts.

2. Transport layer

Transport Layer (also known as the Host-to-Host Transport layer) is the third layer of the four layer TCP/IP model. The position of the Transport layer is between Application layer and Internet layer. The purpose of Transport layer is to permit devices on the source and destination hosts to carry on a conversation. Transport layer defines the level of service and status of the connection used when transporting data. It is responsible for providing the Application layer with session and datagram communication services.

The core protocols of the Transport layer are Transmission Control Protocol (TCP) and the User Datagram Protocol (UDP).

- TCP provides a one-to-one, connection-oriented, reliable communications service. TCP is responsible for the establishment of a TCP connection, the sequencing and acknowledgment of packets sent, and the recovery of packets lost during transmission.
- UDP provides a one-to-one or one-to-many, connectionless, unreliable communications service. UDP is used when the amount of data to be transferred is small (such as the data that would fit into a single packet).

The Transport layer encompasses the responsibilities of the OSI Transport layer and some of the responsibilities of the OSI Session layer.

3. Internet layer

The Internet layer is responsible for addressing, packaging, and routing functions. The core protocols of the Internet layer are IP, ARP, ICMP, and IGMP.

- The Internet Protocol (IP) is a routable protocol responsible for IP addressing, routing, and the fragmentation and reassembly of packets.
- The Address Resolution Protocol (ARP) is responsible for the resolution of the Internet layer address to the Network Interface layer address such as a hardware address.
- The Internet Control Message Protocol (ICMP) is responsible for providing diagnostic functions and reporting errors due to the unsuccessful delivery of IP packets.
- The Internet Group Management Protocol (IGMP) is responsible for the management of IP multicast groups.

The Internet layer is analogous to the Network layer of the OSI model.

4. Network Access Layer

This layer basically controls hardware devices and media that make up the network. Its tasks include routing of data, sending it over the network, verifying the data format, and converting the signs from analog to the digital format. TCP/IP can be used to connect differing network types. These include LAN technologies such as Ethernet and Token Ring and WAN technologies such as X.25 and Frame Relay.

The Network Interface layer encompasses the Data Link and Physical layers of the OSI model.

2.7.1 Summary of network models

The 2 network models do realize the same job of sending data between different networks. By comparing OSI and TCP/IP models, there is a difference because the number of layers differs. However, some layers like application in TCP/IP do the job done by many layers in OSI models. For example Application layer and Network layer in TCP/IP combine the role of many layers.

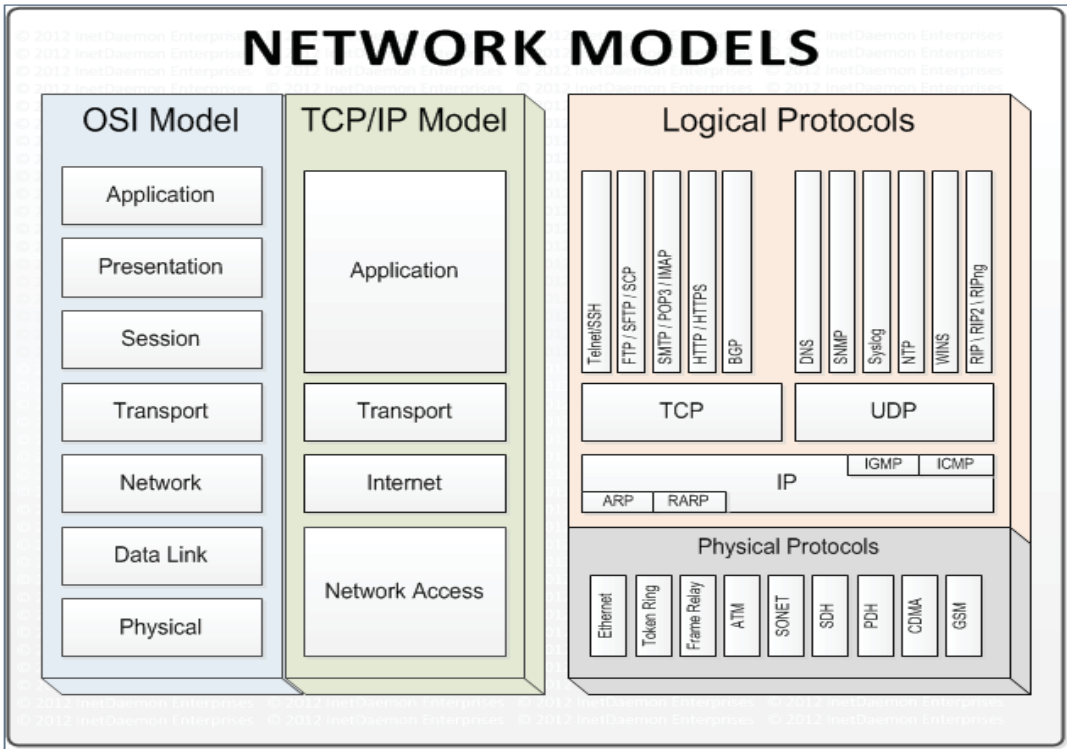

Figure 2.41: Network models

Source: <https://www.pinterest.com/robkell3377/osi-model/>

Table 2.6: OSI vs. TCP/IP models

Sr. No.	TCP/IP Reference Model	OSI Reference Model
1	Defined after the advent of Internet.	Defined before advent of Internet.
2	Service interface and protocols were not clearly distinguished before	Service interface and protocols are clearly distinguished
3	TCP/IP offers support for connectionless communication within the network layer.	In the network layer, OSI supports both connectionless and connection-oriented communication.
4	TCP/IP supports Internet working	Internet working not supported
5	Loosely layered	Strict layering
6	Protocol Dependent standard	Protocol independent standard
7	More Credible	Less Credible
8	TCP reliably delivers packets, IP does not reliably deliver packets	All packets are reliably delivered

Application activity 2.7:

1. Which of the following are layers in the TCP/IP model? (Choose three.)
 - a. Application
 - b. Session
 - c. Transport
 - d. Internet
 - e. Data Link
 - f. Physical
2. What layer in the TCP/IP stack is equivalent to the Transport layer of the OSI model?
 - a. Application
 - b. Host-to-Host
 - c. Internet
 - d. Network Access
3. Using a figure, describe TCP/IP and OSI network models with their associated protocols.
4. Describe the purpose and basic operation of the protocols in the OSI and TCP models.

2.7.1 Network switching

Learning activity 2.8:

Look at the following two network designs represented by figure A and B and answer questions:

5. Describe what you see.
6. What is the difference between these two designs?

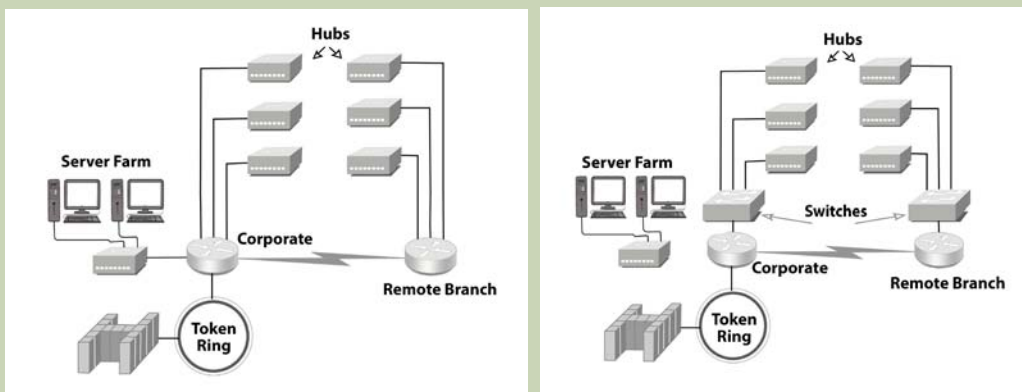

2.8.1 Definition

Switching is a process to forward packets coming in from one port to a port leading towards the destination. When data comes on a port it is called ingress, and when data leaves a port or goes out it is called egress.

A switched network consists of a series of interlinked nodes, called switches. In a switched network, some of these nodes are connected to the end systems (computers or telephones, for example). Others are used only for routing. The Figure below shows a switched network.

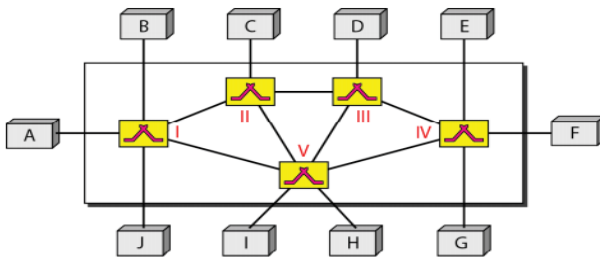

Figure 2.42: Switched network

Source: <http://www.myreadingroom.co.in/notes-and-studymaterial/68-dcn/787-switching-and-types-of-switching-techniques.html>

The end systems (communicating devices) are labeled A, B, C, D, and so on, and the switches are labeled I, II, III, IV, and V. Each switch is connected to multiple links.

The advantages of switches are as follows:

- Switches increase available network bandwidth
- Switches reduce the workload on individual computers
- Switches increase network performance
- Networks that include switches experience fewer frame collisions because switches create collision domains for each connection (a process called micro segmentation)
- Switches connect directly to workstations.

2.8.2 Switching methods

The classification of switched networks is given by the figure below.

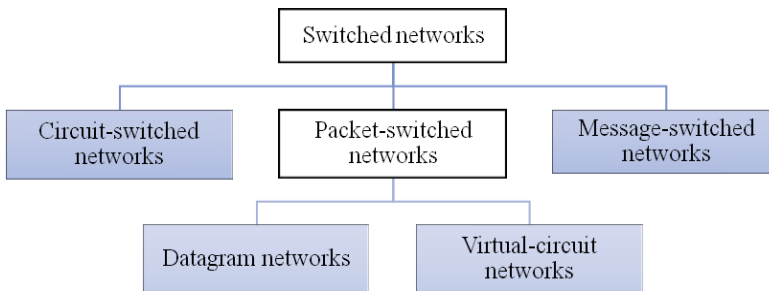

Figure 2.43: Classification of switched networks

2.8.2.1 Circuit-Switched Networks

Circuit switching is a switching method in which a dedicated communication path in physical form between two stations within a network is established, maintained and terminated for each communication session. Applications which use circuit switching may have to go through three phases:

- Establish a circuit
- Transfer the data
- Disconnect the circuit

2.8.2.2 Packet Switched Networks

In **packet switched** data networks all data to be transmitted is first broken down into smaller chunks called packets. The switching information is added in the header of each packet and transmitted independently.

It is easier for intermediate networking devices to store small size packets and they do not take much resources either on carrier path or in the internal memory of switches.

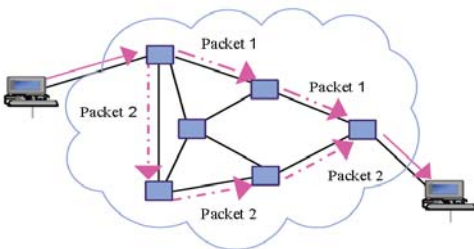

Figure 2.44: Packets sent over the network

Packet switching can be done through the following technologies:

g. Datagram networks

Packets are treated independently and may take different routes. Datagram is better if numbers of packets are not very large.

h. Virtual circuit networks

In virtual circuit, a logical path is setup prior the transmission and therefore, no routing decision is to make which ensure that packet are forwarded more quickly than datagram. The logical path between destination and source also assure the sequencing of packet and better error control. However, virtual circuit is less reliable because Interruption in a switching node loses all circuit through that node.

2.8.2.3 Message switching

In message switching, if a station wishes to send a message to another station, it first adds the destination address to the message. Message switching does not establish a dedicated path between the two communicating devices i.e. no direct link is established between sender and receiver. Each message is treated as an independent unit.

Consider a connection between the users (A and D) in the figure below (i.e. A and D) is represented by a series of links (AB, BC, and CD).

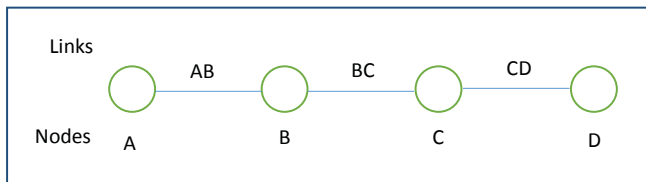

Figure 2.45: A connection between A and D

For example, when an email message is sent from A to D, it first passes over a local connection (AB). It is then passed at some later time to C (via link BC), and from there to the destination (via link CD). At each message switch, the received message is stored, and a connection is subsequently made to deliver the message to the neighboring message switch.

Application activity 2.8

1. How does the message switching differ from circuit switching?
2. Explain the technologies used in packet switching.

END UNIT ASSESSMENT ACTIVITIES

1. Your school has acquired 60 computers from the Rwanda Education Board (REB) and wishes to distribute them as follows:
 - Administration: 3 computers
 - Staff room: 7 computers
 - Computer lab for students in Ordinary level: 30 computers
 - Computer lab for students in Advanced level: 20 computers
 - a. List and describe specifications of all materials needed to setup 2 wireless LANs within the school.
 - b. Is it possible to secure those wireless networks?
 - c. Indicate the type of wireless security to be used.
2. Discuss the advantages of Fiber optic cables within a LAN.
3. Why routers and switches do not operate at the same OSI reference model layer?
4. What are the common steps in configuring both wireless router and access points?
5. Is it possible to change the default gateway of your computer? Explain.
6. When and how both public and private IP addresses are used within the same network?
7. Describe the purpose and basic operation of the protocols in the OSI and TCP models.
8. What are the advantages of using OSI layered model?
9. Discuss the importance of switches within a LAN.



UNIT 3

NETWORKING PROJECT

UNIT 3: NETWORKING PROJECT

Key Unit Competency:

To be able to build a computer wired and wireless network

INTRODUCTORY ACTIVITY

Observe the following figure



Figure: 3.1: Networking tools

Observe the figure above and answer the following questions

1. List all the medium in the figure above
2. Using two telephones or two laptops state different steps which can help sharing films via Bluetooth technology.
3. Choose the different tools which can help in crossover Network cable making
4. Describe all network tools available in the school computer Lab and in the figure 3.1

3.1 Build Peer to Peer network

Project I: Preparing Ethernet cables and devices

P2P Project 3.1. A

- 1) You are given 10 computers, UTP cables, RG-45, crimping tools, switch/ hub
 - a. Arrange the tools and devices required to build P2P network
 - b. Prepare cables required to build P2P network
 - c. Test each cable if they are properly working.
 - d. Connect cables to different devices.
 - e. How will you dispose your useless materials?
 - f. To avoid the loss of many materials which are costly, what measures would you take?

Observation: If you have a green light, the connection is successful; if the color is Red, the connection is failed, please revise you cabling. If tried twice without success, please call the teacher/Lab technician.

3.1.1 Tools required building P2P Network

This practice has crucial importance as when files are shared to the network will reduce the cost of printout papers as one document can be shared by many users who stands in the same P2P network or when sharing printer to the same P2P network, all users can enjoy printing without taking time in installing setup to all computers in the same work group.

In order to build peer to peer network we need several equipment discussed in previous network classes, the maximum number of computer to build a P2P network is 10, transmission media needed is UTP cables. We use crossover to connect the same devices (hub to hub, computer to computer, router to router, and switch to switch) and straight through cable to connect different devices (Computer to switch, computer to hub). We use star topology where we need Switch/hub as the central devices. To build a P2P network of 2 computers we need only two computers and Ethernet cable (Straight through cable), for P2P network of more than 2 computers we need computers, Ethernet cables (Crossover and Straight through) and Switch/hub.

3.1.2 Process to build P2P network

We are going to build a peer to peer network for small office or home office.

Step 1: Make sure all computers are turned off, organized and arranged.

In this practice we need to arrange 10 computers which is the maximum number of computer allowed in P2P network.

Step 2: Install central devices (Switch or hub).



Figure 3.2: Installed central devices

Step 3: Connect each end of the UTP CAT 6 straight through cables to connect computers to Switch/ Hub.

When connecting devices, UTP CAT 6 straight through cable is required to connect the same devices (Computer to computer) and UTP CAT 6 crossover cable to connect different devices (Switch to computer), depending on number of devices we have in our practice, more Ethernet cables are need. There are some tools which are needed to make ethernet cables and different steps learned in the previous school (S5, Unit 3 **Introduction to networking**) are needed.

Tools used to make Ethernet cables: cat 6 cables, RJ 45 , RJ 45 crimping tool, scissors, Cable tester, drilling machine, hammer, screw driver, cable stripper, cable ducts

Making straight through cable and Crossover cable:

Step 1: Strip the cable jacket about 1.5 inch down from the end.

Step 2: Spread the four pairs of twisted wire apart. For Cat 5e, you can use the pull string to strip the jacket farther down if you need to, then cut the pull string. Cat 6 cables have a spine that will also need to be cut.

Step 3: Untwist the wire pairs and neatly align them in the T568B orientation. Be sure not to untwist them any farther down the cable than where the jacket begins; we want to leave as much of the cable twisted as possible.

Step 4: Cut the wires as straight as possible, about 0.5 inch above the end of the jacket.

Step 5: Carefully insert the wires all the way into the modular connector, making sure that each wire passes through the appropriate guides inside the connector.

Step 6: Push the connector inside the crimping tool and squeeze the crimper all the way down.

Step 7: Repeat steps 1-6 for the other end of the cable.

Step 8: To make sure you've successfully terminated each end of the cable, use a cable tester to test each pin.

The following figure shows how you should keep each wire according to their colors for each type of cable (Crossover and straight through cables)

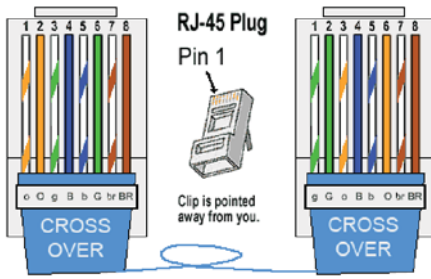

Figure 3.3: Crossover cable

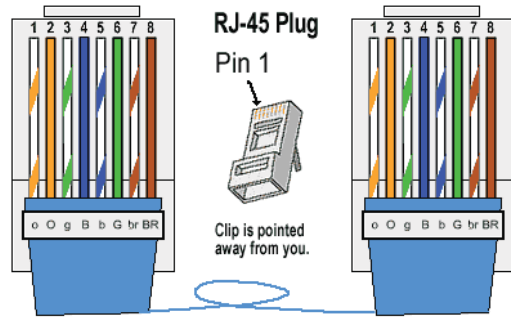

Figure 3.4: Strait through cable

Source: <http://www.fiber-optic-components.com/category/ethernet-cables>

You should also use numbers of wires in case you are confused by colors. The following figure helps also to create the indicated cables.

a. Straight Cable

Pin ID	Side A	Side B	Pin ID	side A	side B
1	Orange-white	Orange-white	1	Orange-white	green-white
2	Orange	Orange	2	Orange	green
3	Green-white	Green-white	3	green-white	orange-white
4	Blue	Blue	4	blue	brown-white
5	Blue-white	Blue-white	5	blue-white	Brown
6	Green	Green	6	green	orange
7	Brown-white	Brown-white	7	brown-white	Blue
8	Brown	Brown	8	brown	blue-white

1 2 3 4 5 6 7 8

Side A Side B

Straight through Cable

1 2 3 4 5 6 7 8

Side A Side B

Crossover cable

Figure 3.5: straight through and crossover cables with colors

Source: <https://www.home-network-help.com/straight.html>

After making Ethernet cable we need to make them tested using cable tester using packet tracer, we can connect devices using different cables not only packet tracer which can be used but also real computers depending on the resources/ computer lab.

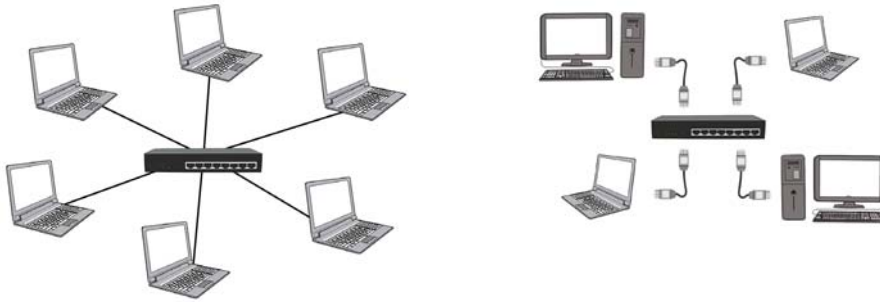

Figure 3.6: Connected devices

Project II: Static IP address configuration

P2P Project 3.1. B

Using previous exercises P2P project 3.1.A, after arranging computers and connect them with different cables accordingly do the following:

- Define IP address scheme to be used
- Assign each computer a static IP address
- After assigning static IP address, test if they are connected using ping command.
- Identify the materials to be used for keeping devices clean.

Observation: By pinging each computer, the observation will be on the replies, if IP address is assigned successfully, the packet sent will be equal to 4, received will be 4 and the lost will be 0, else it is not assigned successfully else repeat the process. If failed twice call the teacher/Lab technician for guidance.

Step 4: Define IP address scheme

Listing IP addresses that will be used to different computers is an important step that will be helpful to define the same working group for being able to share files, folder, printers and network.

In this project we use maximum 10 computers which are allowed to build P2P network, the IP addresses given to the PCs can be in the same network for being in the same work group to share resources such as folder, printer, files and network.

The following are IP addresses we will use in this practice:

PC1: 192.168.0.1, **PC2:** 192.168.0.2, **PC3:** 192.168.0.3, **PC4:** 192.168.0.4,

PC5: 192.168.0.5, **PC6:** 192.168.0.6, **PC7:** 192.168.0.6, **PC8:** 192.168.0.8,

PC9: 192.168.0.9, **PC10:** 192.168.0.10

Step 5: Configure static IP address for each computer.

Process1: In windows 10, go to search and type in Control panel and click on it

Process2: Click the link “**View network status and tasks**” under the “**Network and Internet**” heading.

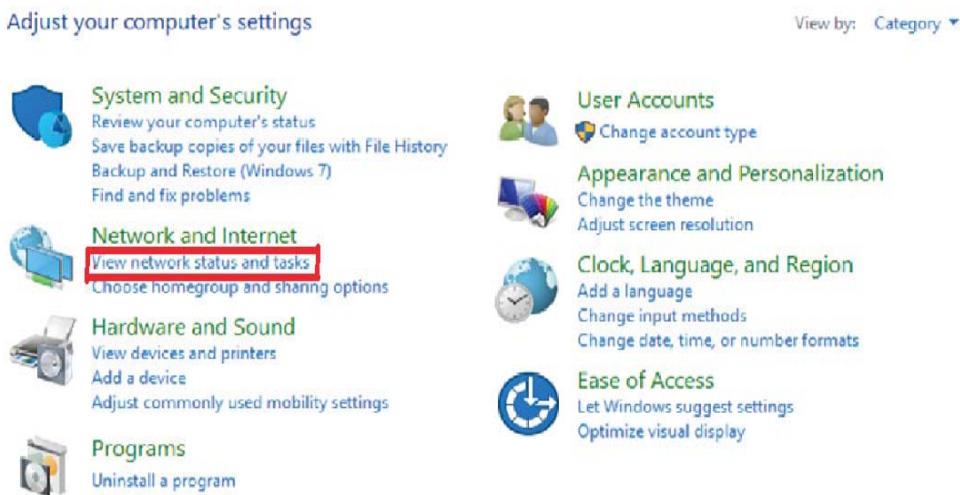

Figure 3.1.8:

Viewing network status and tasks

Process 3: Click the link on the left of the window labeled Change adapter settings.

Process 3: change adaptor settings

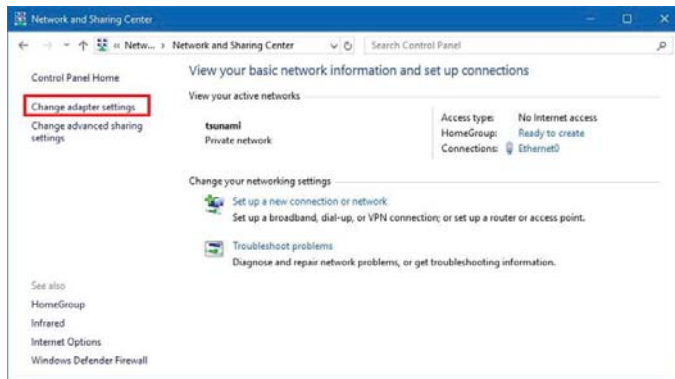

Figure 3.9: Changing adaptor settings

Process 4: You might have more than one Internet connection listed in this window. If this is the case you will need to determine which one is your connection to the Internet. Once you have found it, right click on your network adapter and choose properties to open up the properties window of this internet connection.

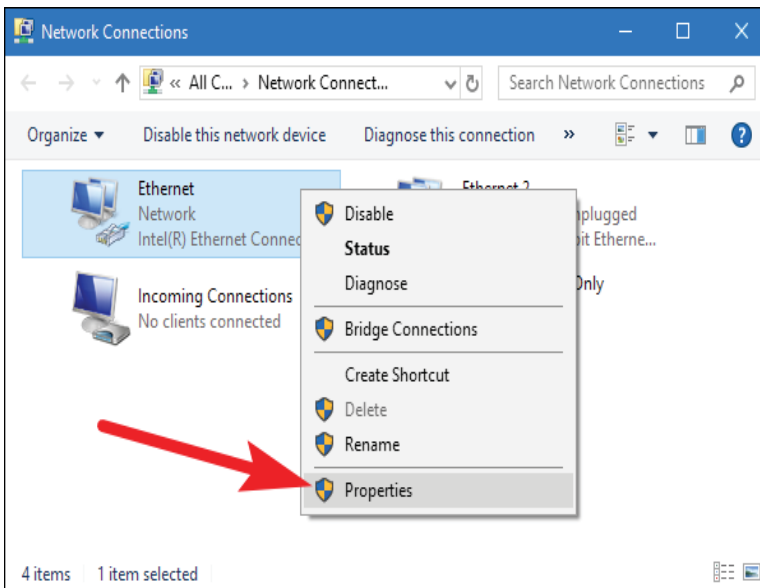

Figure 3.10: Viewing properties

Process 5: Find the option of **Internet Protocol Version 4 (TCP/IPv4)** and click on it. Then choose one option (Internet Protocol Version 4)

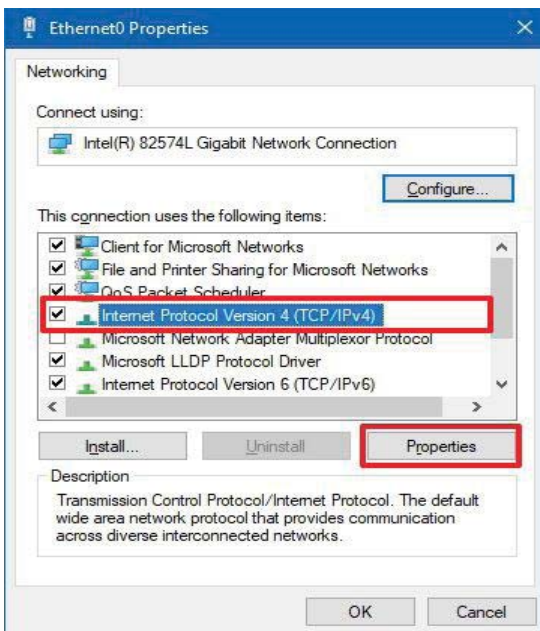

Figure 3.11: Choosing the type of Internet connection

Process 6: Select “Use the following IP address” and enter the IP address, Subnet Mask, Default Gateway and DNS server. Click **OK** and close the **Local Area Connection** properties window.

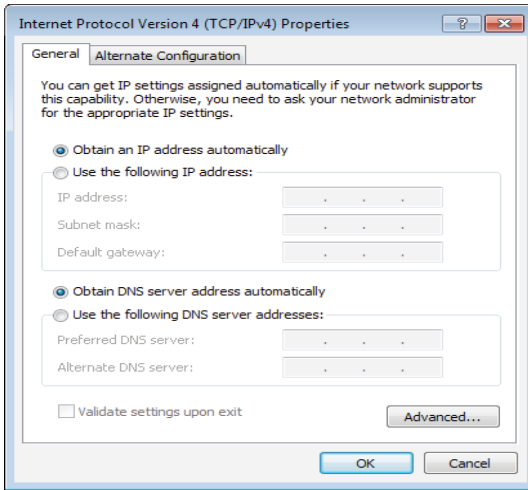

Figure 3.12: Setting static IP address

When choosing “Use the following IP address” the IP must be configured as **Static**

Process 7: As an example, assign one PC1 an IP address of 192.168.0.1 and use the subnet mask 255.255.255.0.

For PC1

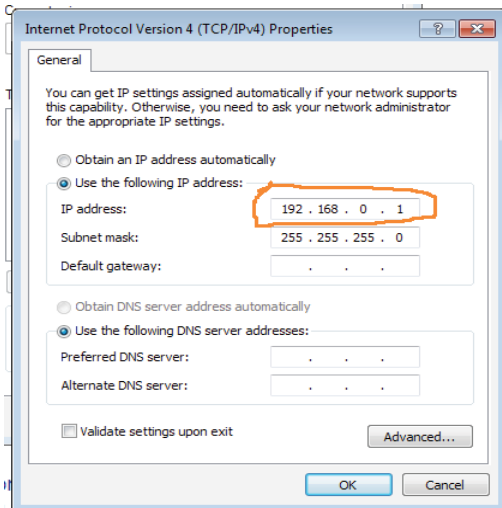

Figure 3.13: Assigning IP address to PC1

Process 8: As an example, assign one PC2 an IP address of 192.168.0.2 and use the subnet mask 255.255.255.0.

For PC2

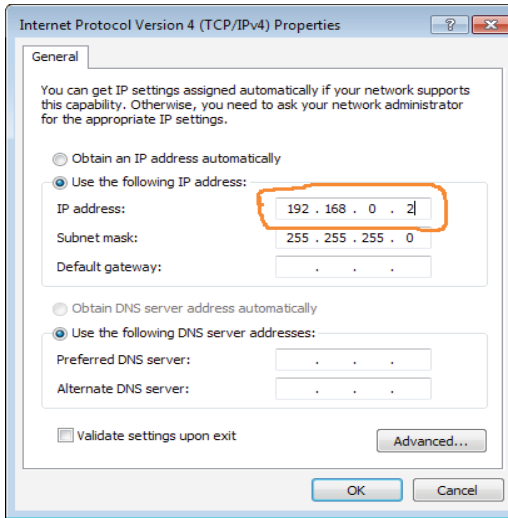

Figure 3.14: Assigning IP address to PC2

Process 9: Do the same for other 8 PCs

Step 6: Ping each computer to verify if they are connected

Process 1: In windows 10, go to search and type in CMD then press Enter

Process 2: Type **Ping 192.162.0.1** (if you use a computer assigned with 192.168.0.2 type in: ping 192.168.0.2) then press Enter button, the replies should be as indicated in the figure below

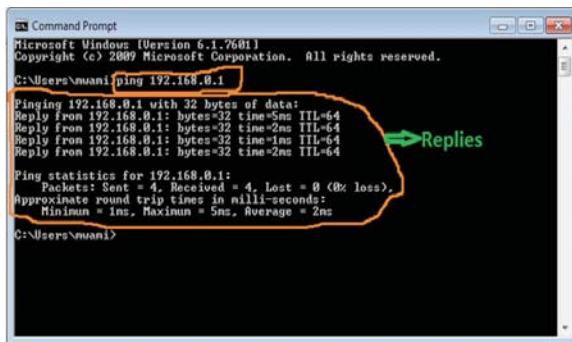

Figure 3.12: Verifying connection

Figure 3.1.15: IP address Replies

Step 7: Do the same as what you did on step 5 to all PCs

Note: if you receive timeout message when attempting to ping your selected IP address, it is possible that the internet connection firewall is interfering, unplugged

cables, mistake on IP configuration, etc

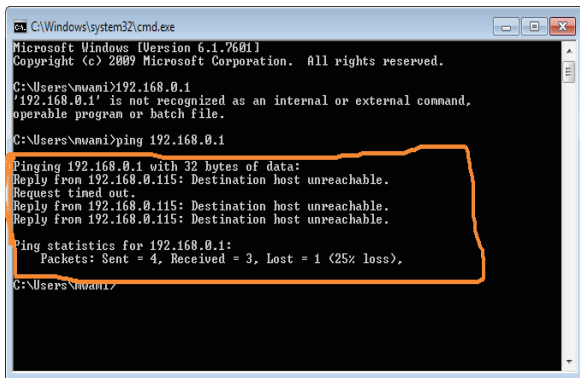

```
C:\Windows\system32\cmd.exe
Microsoft Windows [Version 6.1.7601]
Copyright (c) 2009 Microsoft Corporation. All rights reserved.

C:\Users\nuami>192.168.0.1
'192.168.0.1' is not recognized as an internal or external command,
operable program or batch file.

C:\Users\nuami>ping 192.168.0.1

Pinging 192.168.0.1 with 32 bytes of data:
Reply from 192.168.0.115: Destination host unreachable.
Request timed out.
Reply from 192.168.0.115: Destination host unreachable.
Reply from 192.168.0.115: Destination host unreachable.

Ping statistics for 192.168.0.1:
    Packets: Sent = 4, Received = 3, Lost = 1 (25% loss),
```

Figure 3.13: Timeout message

How to allow internet connection through the firewall?

- Right click on My Network places, then select properties.
- Right click local Area connection and select properties once again,
- Click the advanced tab. Uncheck the box titled: protect my computer from the internet.
- Click OK. Now, try typing the selected IP address again.

Once you get two computers to communicate successfully together, you can now enjoy the benefit of files, printer, internet sharing.

Project III: Sharing folder, files, printer and internet

P2P Project 3.1.C

Using previous exercises P2P project 3.1.B, after assigning each computer its own IP address, do the following

- a. Put all computers in the same work group network
- b. Share files, folder, printers and network.
- c. How to avoid piracy in networking.

Observation: When files, folder, printer and internet are successfully to all permitted PCs, they should be seen and retrieved on other PCs and enjoying using them when you are in the same P2P network. The shared printer must print to every connected PC even if there is no setup installed. If fails to share repeat the process once else call to the teacher/Lab technician for guidance

To share folder requires creating a home group/ workgroup, for the topic discussed in S5, creating home group/ work group is discussed, here we need to change a home group/ work group to be able to share files, folder, printer and network.

The following are the steps to change the home group/ workgroup in Windows 10

Step1: With the right mouse button click the Start icon and choose System. If you have a touch enabled device, click and hold the start button, then tap the System button.

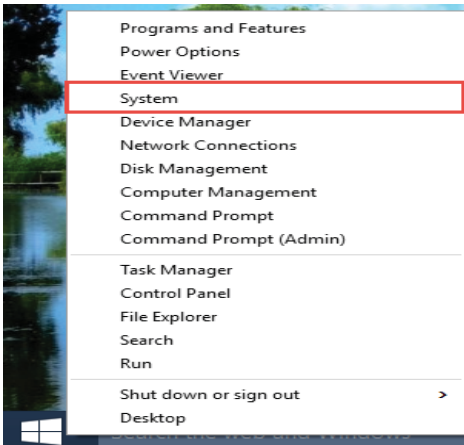

Figure 3.14: Selecting system

Step2: Under “Computer name, domain, and workgroup settings” click on **Change Settings**

Computer name, domain, and workgroup settings

Computer name: WIN-1M1K6CUK0TH
Full computer name: WIN-1M1K6CUK0TH
Computer description:
Workgroup: WORKGROUP

A button with a shield icon and the text "Change settings" is highlighted with a red rectangular box.

Figure 3.15: Select change settings

Step3: Under the tab “Computer Name” find the Change... button and click it

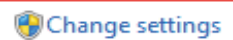
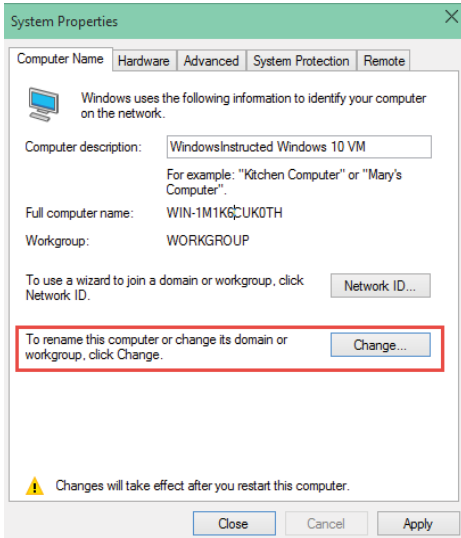

Figure 3.16: Select Change

Step4: Under “Member Of” change the Workgroup name.

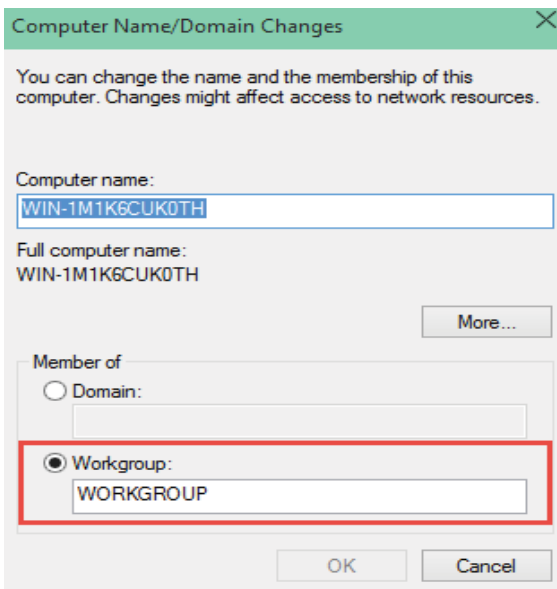

Figure 3.17: Select workgroup

Step 5: Change the name from WORKGROUP to S6A

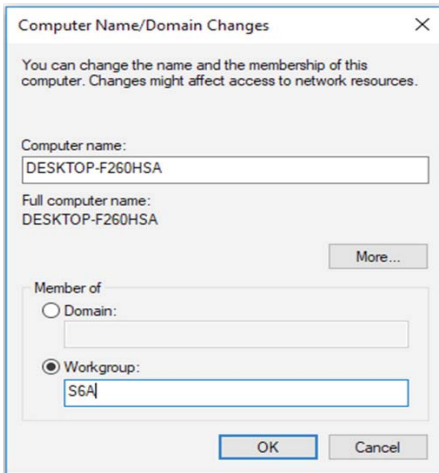

Figure 3.18: Change the name of work group

Step 6: Then click on OK, the system will prompt to reboot

After rebooting the system, the new folder/files/printer or network will be added to the existing Home group following the steps below

Step 1: Use the Windows key + E keyboard shortcut to open File Explorer

Step 2: On the left pane, expand your computer's libraries on Home Group

Step 3: Right-click Documents and choose Properties

Step 4: Click Properties.

Step 5: Click Add.

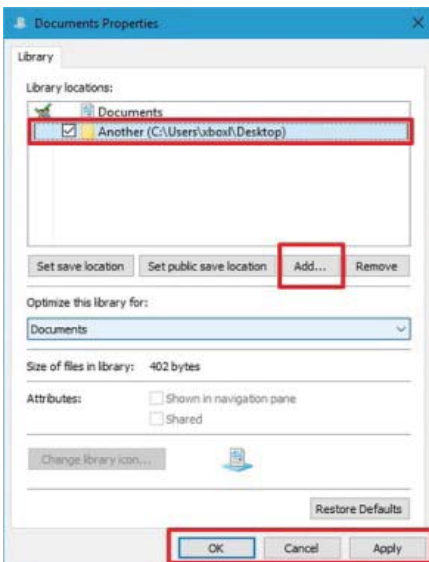

Figure 3.19: Add new folder

Step 6: Select the folder you want to share and click Include folder.

Step 7: Click Apply.

Step 8: Click OK.

Now the folder will be accessible by anyone who joined the Home Group when they browse the Documents folder

3.2 Wireless Router installation and configuration

Note: This configuration is for TP-Link wireless Router, for other types of wireless routers, consult manufacturer requirements and guidance.

Project I: Wireless router connection and Setting

P2P Project 3.1.C

Using previous exercises P2P project 3.1.B, after assigning each computer its own IP address, do the following

- a. Put all computers in the same work group network
- b. Share files, folder, printers and network.
- c. How to avoid piracy in networking.

Observation: When files, folder, printer and internet are successfully to all permitted PCs, they should be seen and retrieved on other PCs and enjoying using them when you are in the same P2P network. The shared printer must print to every connected PC even if there is no setup installed. If fails to share repeat the process once else call to the teacher/Lab technician for guidance

This unit provides procedures for configuring the basic parameters of your router; it also describes the default configuration on startup.

3.2.1 Default configuration

When you first boot up the router, some basic configuration has already been performed for TP-Link wireless router. All of the LAN and WAN interfaces have been created, console and VTY (Virtual Teletype) ports are configured, and the inside interface for Network Address Translation has been assigned.

3.2.2 Wireless Router configuration requirements

For some routers web browsers are needed to configure them to the wireless router, others need Ethernet cables to be configured, they are also some which

needs their catalog where there is written all process to configure them.

To configure wireless Router the following materials are needed:

- A wireless router,
- A computer or laptop with wireless capabilities.
- Two Ethernet cables.

Step 1: Prepare router and switch on it.

Step2: Connect router to the Laptop/PC with wireless capability

Step3: Access Dashboard using default IP address and Password

The different process will be applicable when prompting to the Dashboard using default IP and password.

Process1: Open the web browser and key in the address bar the default IP address (192.168.0.1)

Process2: The server asks for the default username and password. The user will then write in the form the default username and password

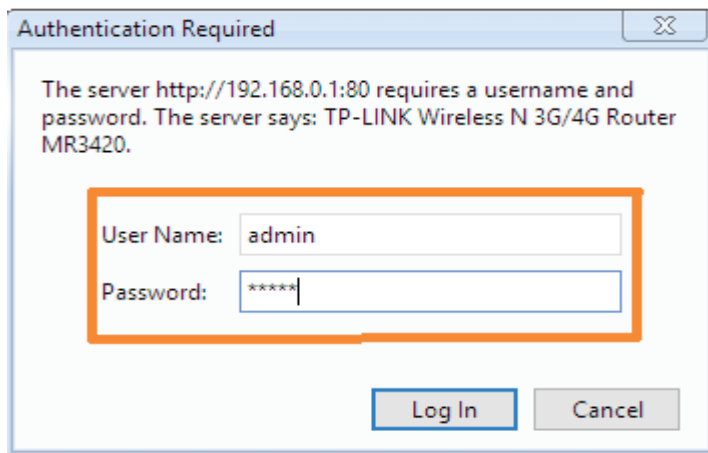

Figure3.21: Default username and password

Process 3: Prompting default dashboard

The figure below will be displayed after entering default username and password

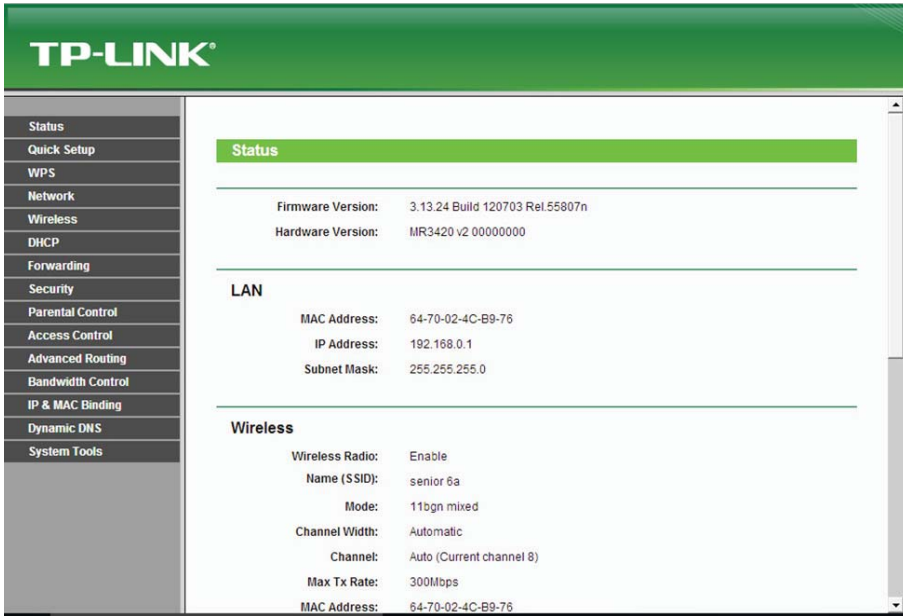

Figure3.22: Default dashboard

Step4: Configure internet using information from the ISP

When configuring internet using information from ISP, some processes are applicable

Process1: Click on Network then select internet mode and click Save

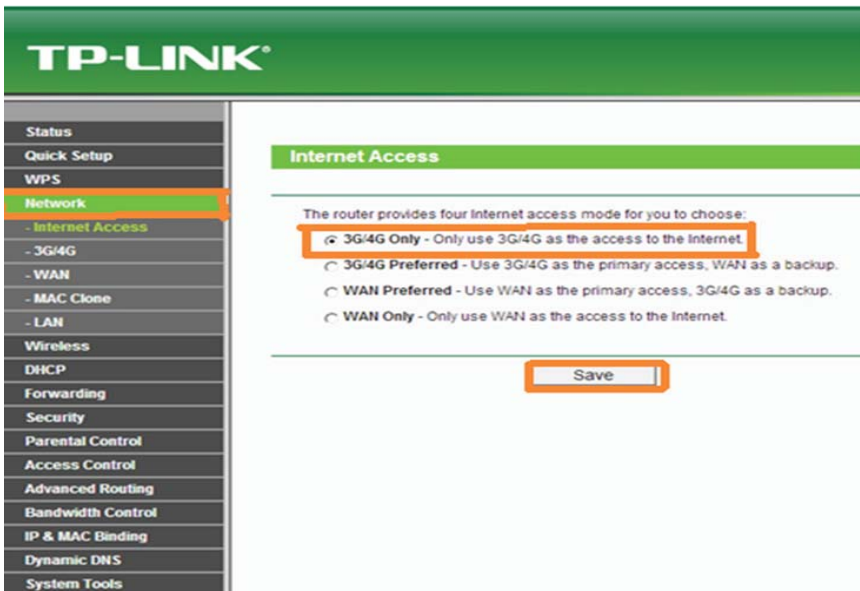

Figure3.23: Selecting internet mode

Process2: Click on Quick Setup to start configuring internet using information from ISP where the selected internet mode is activated, then click Next.

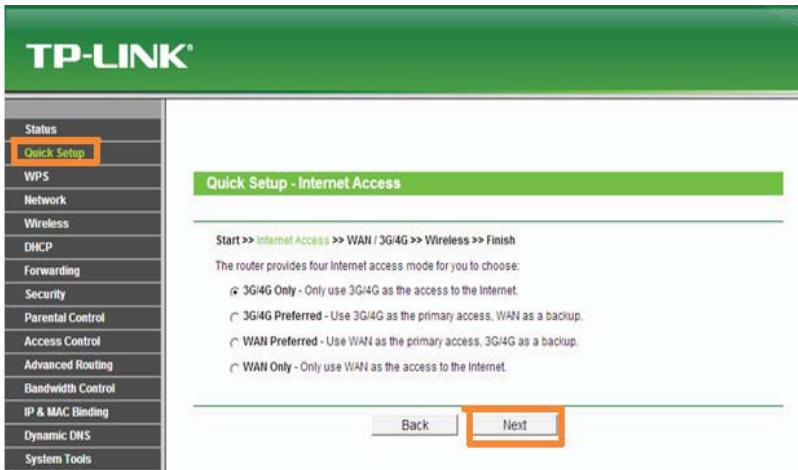

Figure3.24: Quick setup to configure internet

Process3: On Wireless name rename the existing name of wireless and authenticate by set your own password for network protection.

In this practice, we use

Wireless name: senior 6a

Password: Kigali12

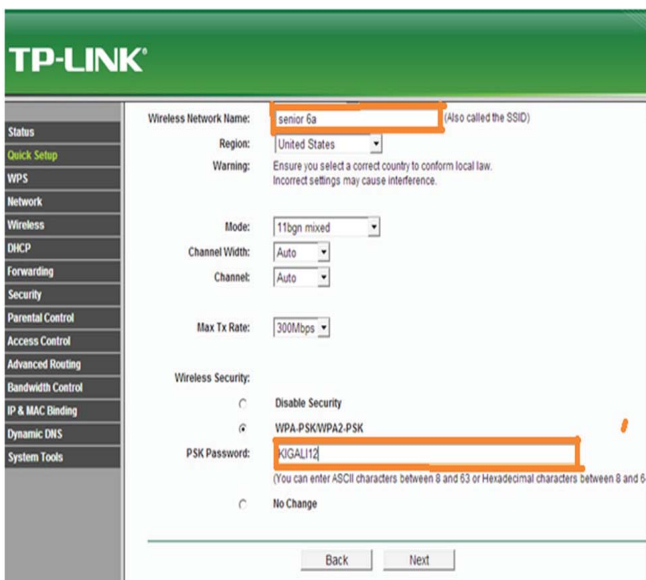

Figure3.25: Network authentication

Process 3: After renaming Wireless and authentication, click Finish to apply the change, and then move to set DHCP settings.

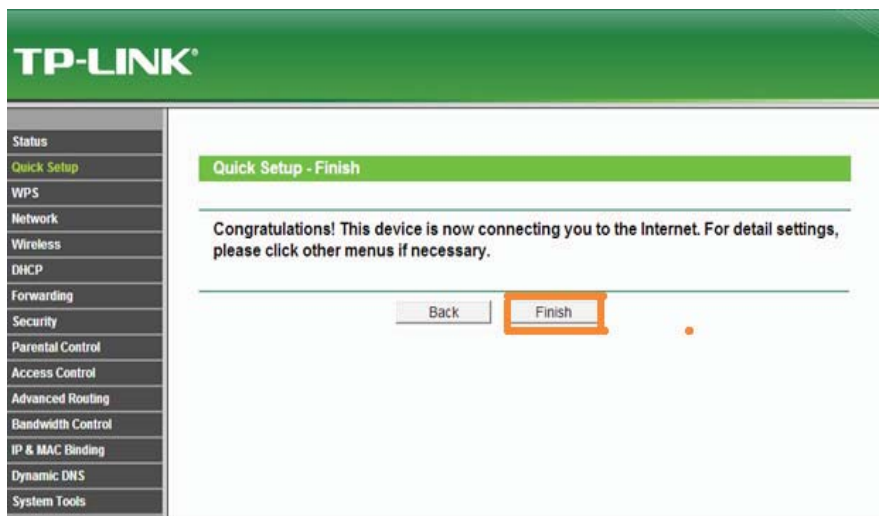

Figure3.26: Finishing internet setting.

Project II: Wireless security configuration

Wireless Router configuration Project 3.2.B

Following what is done in Wireless Router 3.2.A

- a. Configure the wireless security
- b. Set DHCP settings?
- c. What measures would you take to keep data on router confidential?

Observation: If wireless router is successfully configured it will be seen on each device which has capabilities to be connected to the wireless and using the name of the wireless and password connect to verify if it is working, if it is not working repeat configuration once if fails twice, call to the teacher for guidance.

Step5: configure LAN and IP using DHCP

Go to Wireless then Wireless Security and configure the wireless security. WPA/WPA2-Personal is recommended as the most secure option. Once configured, click Save.

There are many wireless security protocols. Here is a basic list ranking the current

Wi-Fi security methods available on any modern (post-2006) router, ordered from best to worst: WPA2 + AES, WPA + AES, WPA + TKIP/AES (TKIP is there as a fallback method), WPA + TKIP, WEP and Open Network (no security at all).

Ideally, you will disable Wi-Fi Protected Setup (WPS) and set your router to WPA2 + AES. Everything else on the list is less than ideal step down from that. Once you get to WEP, your security level is so low, it's about as effective as a chain link fence. The fence exists simply to say "hey, this is my property" but anyone who actually wanted to go in could just climb right over it.



Figure3.27: Configure the wireless security

Note: If using a dual band router, repeat this process.

Step 5:

Go to **DHCP** → **DHCP Settings** and select **Disable the DHCP Server**. Click on **Save**.

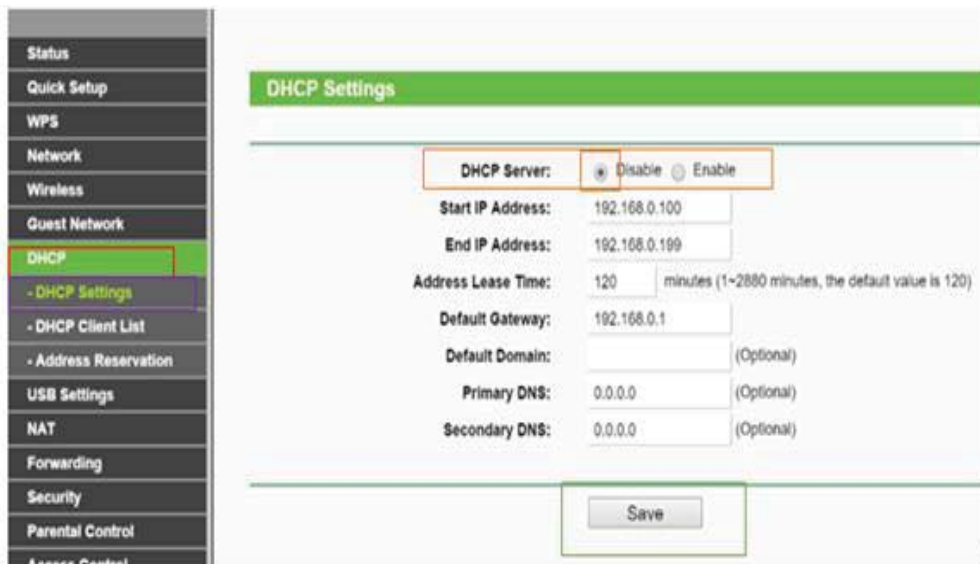

Figure3.28: Disable DHCP Server

Step 6: Set the IP from ISP and go to the System **Tools** and select **Reboot** to reboot the device.

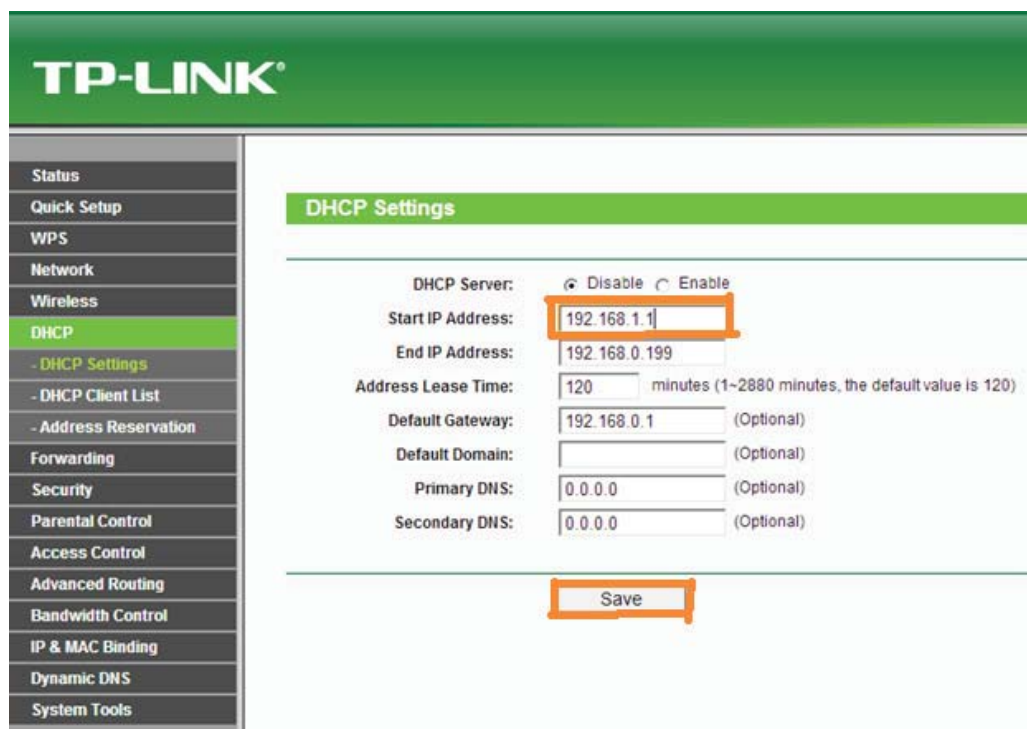

Figure3.29.: Setting the IP address from ISP

3.3 Building Client/Server network

Project I: Creating and setting an FTP folder

Client/server project 3.3.A

1. You are given 2 computers and strait through cables
 - a. Create an FTP Folder
 - b. Configure IP address
 - c. Configure an FTP Server
 - d. When file is needed to be used by many people in the group, sometimes printing or sending to flash disk is needed which is costly and sometimes spread viruses. What measures would you take to avoid high cost and virus spreading?

Observation: If the FTP folder is successfully created it will be available on server computer and start enjoying using it for the next session to create an FTP site. If it fails once, call to the teacher/lab technician for guidance.

3.3.1 Creating an FTP client/server network

With a home FTP server, you are able to upload and download files from anywhere to your PC, Similar to cloud storage but without the limitations.

Setting up a File transfer protocol (FTP) server may sound complicated, but it's actually quite easy to set up especially if using Windows 10.

Step 1: Create a folder that your FTP users will be accessing on C: drive.

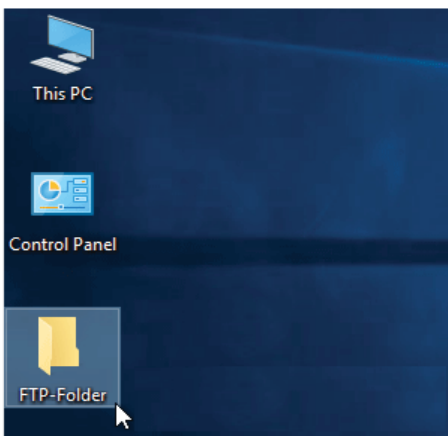

Figure3.3.1: Creating FTP Folder

Step2: Press the “Windows key + R” on your keyboard to open the Run window, and type CMD, click OK to open the command prompt window.

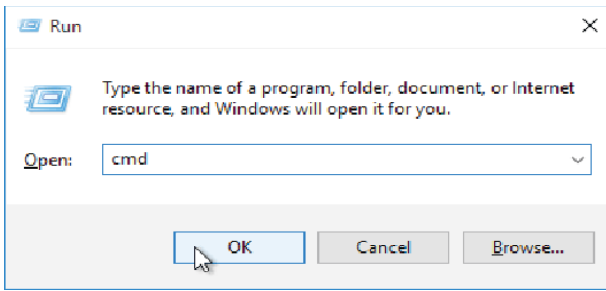

Figure3.3.2: Open Run windows

Step3: Here type “ipconfig” and press enter, write down the IP address and the default gateway IP, because we are going to use it in the next steps. Here the following IP addresses will be used: 10.0.0.17 and 10.0.0.1

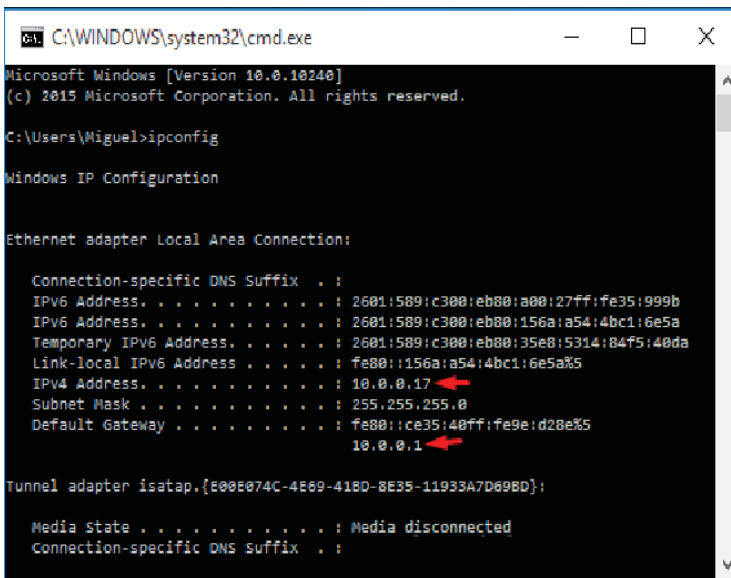

Figure3.3.3: in CMD, Type in “ip config”

Step4: Then go to Control Panel -> Programs and Features.

Step5: Navigate to Turn Windows features on or off on the top left.

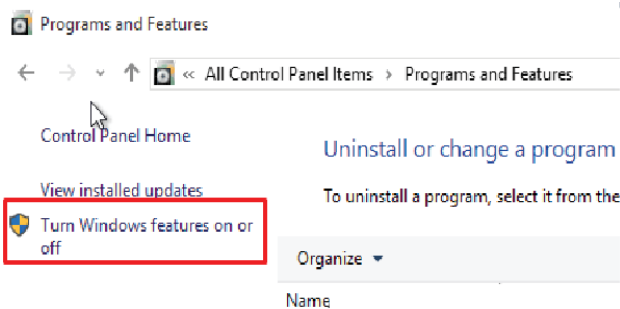

Figure 3.3.4: Click on "Turn Windows features on or off"

Step 6: Select the check box, next to "Internet Information Services" also collapse it to check mark "FTP Server" and "FTP Extensibility", then click the OK button and wait for the features to be added.

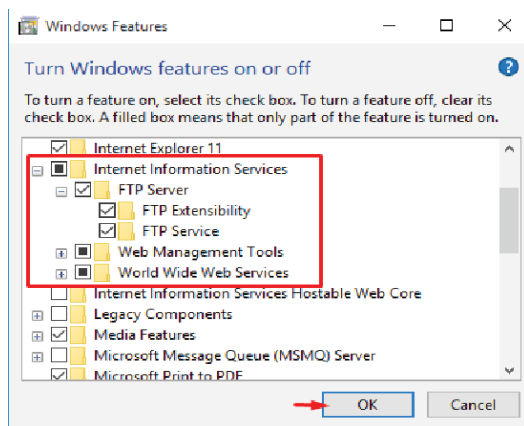

Figure 3.3.5: Select the check box, next to "Internet Information Services"

Project II: Creating and setting an FTP site

Client/server project 3.3.B

1. Following the steps client/project 3.3.A,
 - a. Create an FTP site
 - b. Create an Internet Information service site
 - c. How can you prevent unauthorized user to access your data?

Observation: If the FTP site is successfully created it will be available on server computer and start enjoying by sharing folder, printers and files to the same client/server network. If it fails repeat the process or consult the teacher for guidance.

Step 7: Go to Control panel, Administrative tools,



Adjust your computer's settings

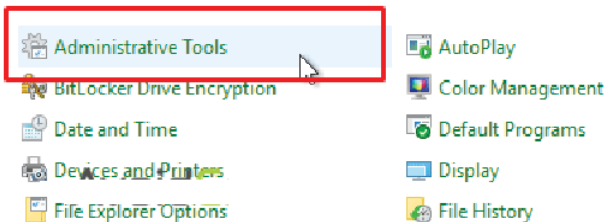

Figure 3.3.6: Select "Administrative Tools"

Step 8: Choose Internet Information Services (IIS) Manager,

Step 9: Expand the root and right click on Sites to create a new FTP Site, click on "add FTP Site..."

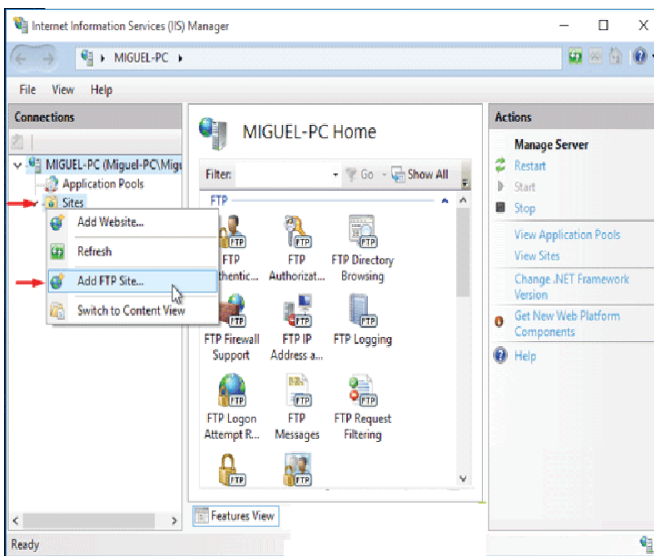

Figure 3.3.6: Add an FTP site

Step 10: Give your FTP site a name, such as "AvoidErrors", and browse for the folder we created initially. This will be the default location where files will be accessible on the server via FTP.

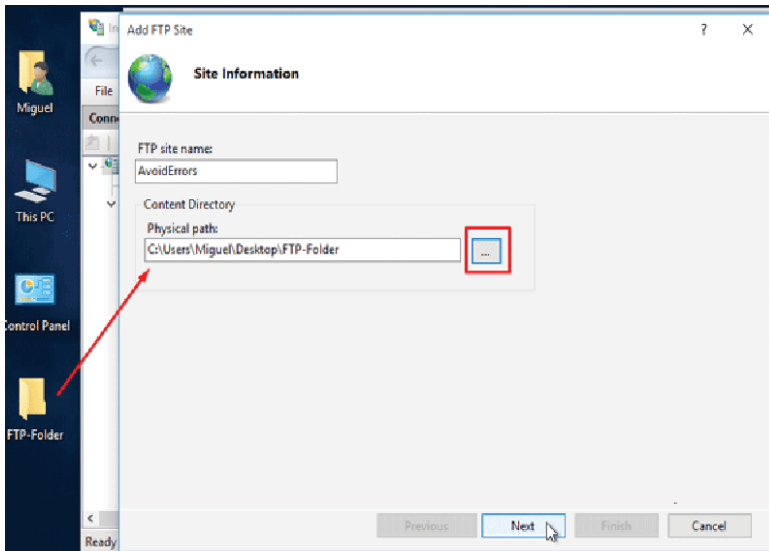

Figure 3.3.7: Give name to an FTP site

Step11: On the Binding and SSL Settings page, click on the drop down to select the IP Address of the computer, Select “No SSL”. If you do have an SSL certificate, you can choose either “Require SSL” or “Allow SSL”.

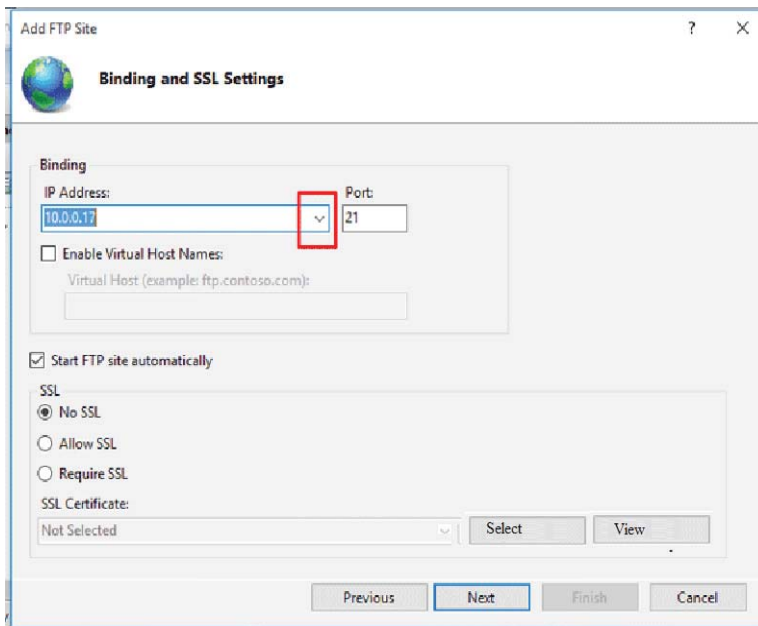

Figure3.3.8: Selecting IP address of the computer

Note: Be sure to require SSL if you intend to make this FTP server accessible via the Internet.

On the Authentication and Authorization Information screen, change “Authentication” option to “Basic” (requires that FTP users specify a login ID and password).

Step13: Authorization section, select “Specified Users”, and Read & Write permissions. Alternatively, you can choose specific user accounts or a group, and limit permission to only Read or Write. Click Finish.

Step13: Now your new IIS Site is properly created.

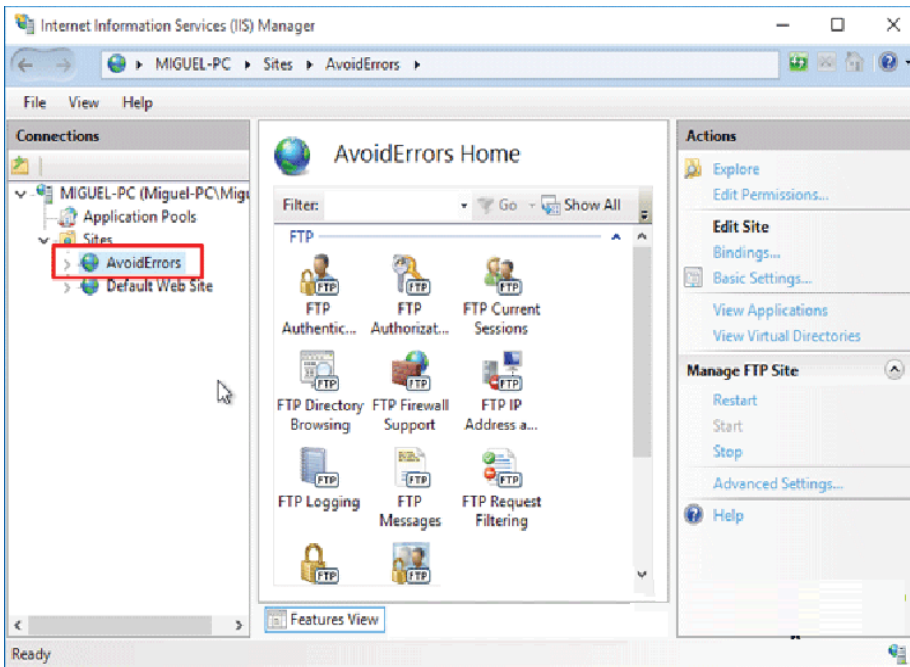

Figure 3.3.9: Created new IIS

Step14: Create a local user account, and give to him/her permission on the FTP content directory:

*If you prefer to use an already existing local computer user account instead of creating one you can skip the create user step and skip to open windows firewall ports.

To allow additional users you must:

1. Create a Windows 10 user.
2. Create a new IIS Rule for the new user.
3. Add the new user to the security settings of the FTP folder.

Open firewall ports for FTP:

Open Control Panel... (View by: “Small icons” recommended)... Windows

Firewall... Select "Allow an app or feature through windows firewall" -> Change Settings button

Select the checkbox next to "FTP Server" and at least one of the networks, and then click on OK.

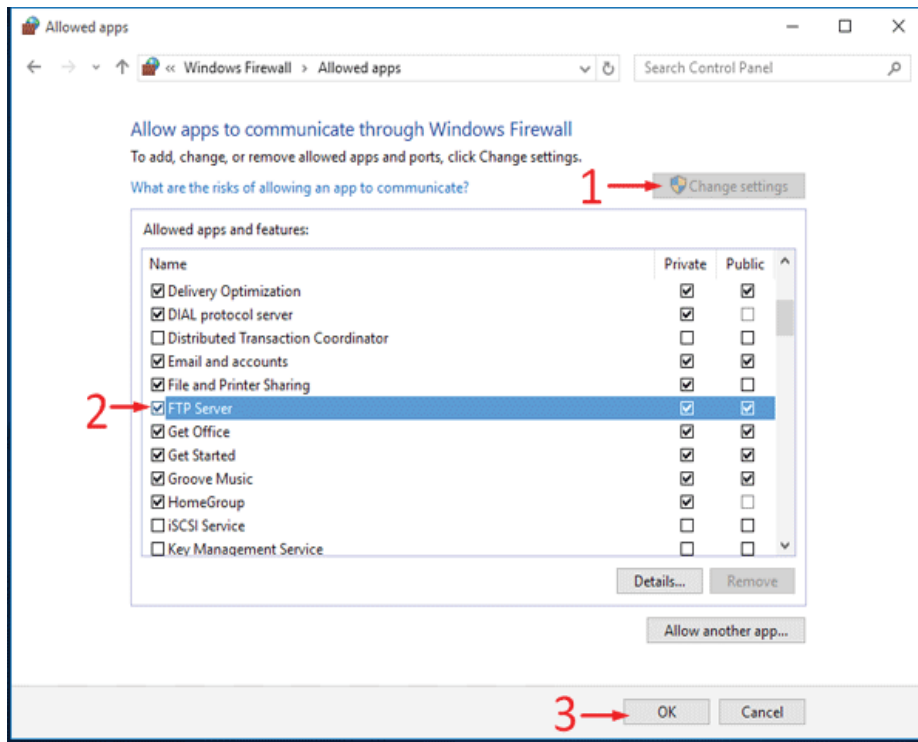

Figure3.3.10: Creating local account

Project III: Creating rules and sharing folders

Client/server project 3.3.C

1. Following the project 3.3.B,
 - a. Enable FTP server port to be accessed from the LAN
 - b. Select proper management
 - c. Add the new user to the security settings of the FTP folder.
 - d. How can you avoid unauthorized users to access your folder

Observation: If the FTP client/server network is successfully configured the shared Folder, printer, files and internet will be seen among all computers on the same network of FTP server network, you can start enjoying using the shared files, folder and printers. Else repeat the process twice or call the teacher for guidance.

Now the Windows 10 FTP Server is enabled to be accessed from the LAN.

Step15: Once you have tested the FTP over the LAN than we are ready to access it via WAN. To allow FTP connection you must enable Port 21 in your router's firewall to allow incoming connection via FTP port 21.



Figure3.3.11: Creating rule to share folder

Process1: Select the proper Site in IIS Manager and on the right, navigate to FTP Authorization Rule.

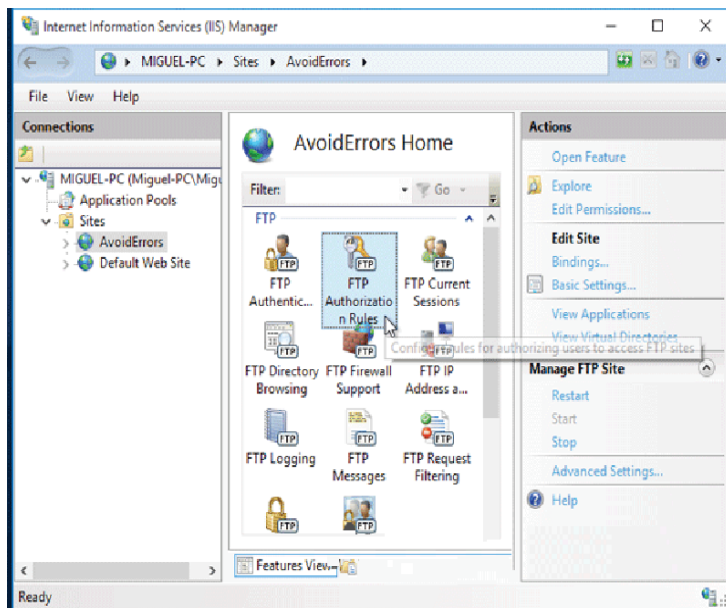

Figure3.3.12: Selecting proper management

Process2: Right click an empty space and select Add Allow Rule...

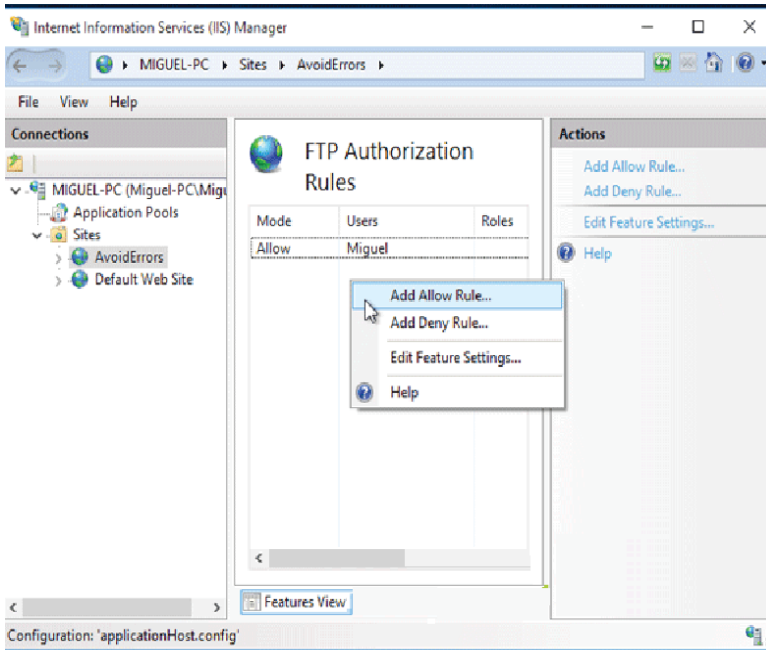

Figure 3.3.13: Allowing rule

Process3: Here check mark specified users and write the user name. Make sure is first created in windows 10 and click OK.

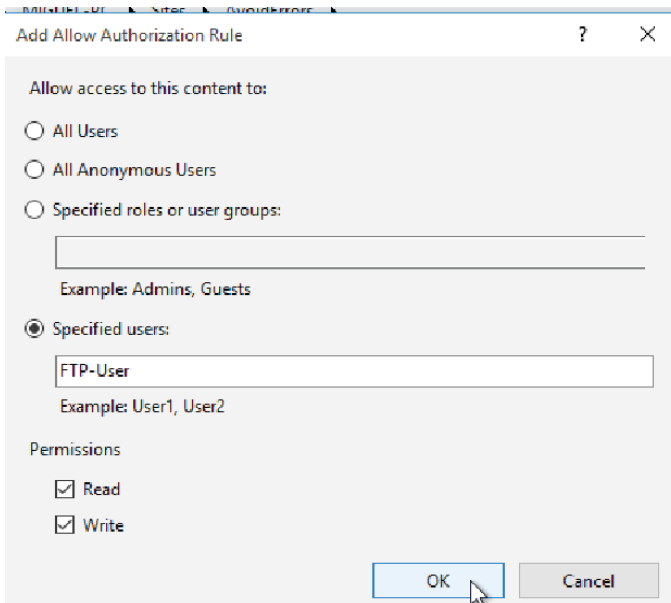

Figure 3.3.14: Checking specified users to give username

To add the new user to the security settings of the FTP folder:

Process4: Locate the folder that your FTP users will be accessing (example: C:\FTP-Folder), right click the folder... select Properties -> Security tab... and add the user that was created in the previous step with appropriate permissions.

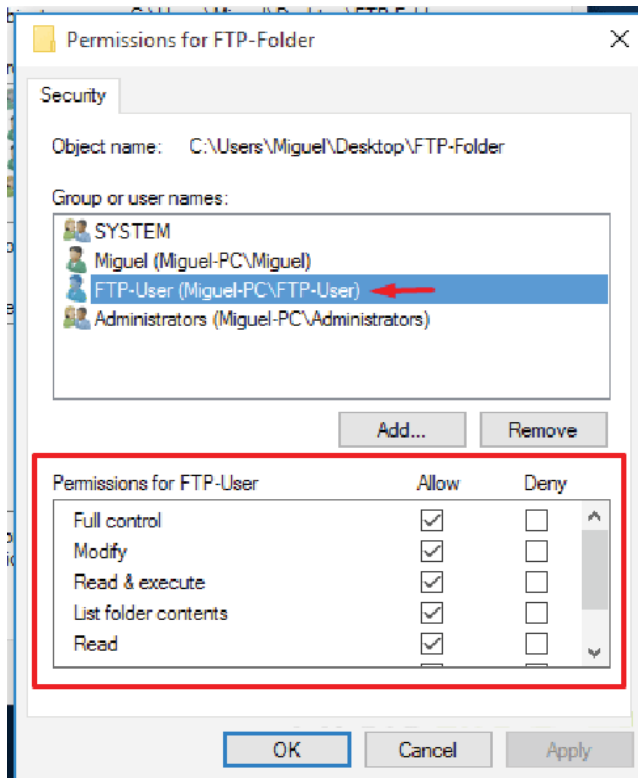

Figure3.3.8: Locate the folder that will be accessible

End unit activity

1. Lab activity: a given 5 computers with the following IP addresses: 198.162.0.117, 198.162.0.114, 198.162.0.118, 198.162.0.119, 198.162.0.116, the subnet mask is 255.255.255.0 assigned to all computers
 - a. Create a P2P network
 - b. Add a home group and share folders, music and files to all computers.
2. You are given a server machine, three new laptop, three Ethernet cables, and the following IP addresses: 198.162.0.12 and 198.162.0.13, create an FTP client/ server network and share folder.



UNIT 4

SQL AND DATABASE PROJECT

UNIT 4: SQL AND DATABASE PROJECT

Key Unit Competency: To be able to apply Structured Query Language in RDBMS and create a short database project

Introductory activity:

The school is requested to submit a report to the District indicating the data on students, teachers, rooms and courses.

In groups, conduct a survey in your school and answer the following questions:

- i. How many students are in the schools?
- ii. How many student are in each class?
- iii. How many boys are in the school? How many boys are in each class?
- iv. How many are girls in the school? How girls are many in each class?
- v. What is the number of teachers in the schools?
- vi. How many teachers for Mathematics Subjects
- vii. How many rooms are there in the school?
- viii. How can you choose the courses that can be taught in the same room?
- ix. Show the number of students eligible to get National Identity card.
- x. How do you think the school does such reporting according to these criteria?
 - a. Design the entities student, teacher, room and course
 - b. Using the used RDBMS (MS Office Access) in the school computer lab, create the database of the school with the 3 tables representing the entities above.
 - c. Respond again to the sub questions in question a) by querying your database. Are the answers the same? What is used to get the answer to each answer?

Activity 4.1:

4. Kabeza Company Ltd is running a business and wishes to manage transactions in computerized way. The database of business contains various entities including "Customers" (id, name, age, address, salary) and orders (id,date,customer_id, amount) which are given here below.

Help your school to find a solution to get the following:

- i. The highly paid employee
- ii. The least paid employee
- iii. The oldest employee
- iv. The youngest employee
- v. To generate total amount of income at a given day.
- vi. To retrieve only the names and age of all employees
- vii. To retrieve the average income at a given day.

"Customers" table:

i. $\sigma_{age \geq 23 \text{ AND } address \neq \text{kigali}}(\text{"Customers"})$

id	name	age	address	salary
1	keza	32	kigali	2000
2	muhirwa	25	muhanga	1500
3	kabandana	23	huye	2000
4	mugisha	25	nyamagabe	6500
5	nyampundu	27	gasabo	8500
6	uwera	22	nyagatare	4500
7	mutoni	24	rusizi	10000

"Orders" table:

id	date	customer_id	amount
100	2017-10-02 00:00:00	3	1500
101	2017-01-20 00:00:00	2	1560
102	2017-10-02 00:00:00	3	3000
103	2016-05-20 00:00:00	4	2060

Definition: relational algebra is the one whose operands are relations or variables that represent relations.

4.1.1 Unary operations

By definition a unary operation is an operator that uses only one operand (relation). In Relational algebra, the unary operations are selection and projection

4.1.1.a Selection operation

Selection is a unary operation that selects records satisfying a given predicate (criteria). It selects a subset of records. The lowercase Greek letter sigma (σ) is used to denote selection. The selection condition appears as a subscript to σ . The argument relation is given in parenthesis following the σ .

Select Operation Notation Model

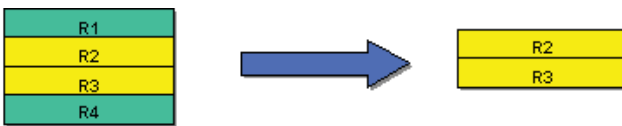

Syntax: σ selection_condition (Relation)

The selection condition or selection criterion can be any legally formed expression that involves:

1. Constants (i.e, members of any attribute domain)
2. Attributes names
3. Arithmetic operators(+, *, /, -, %)
4. Comparisons/Relational operators : a. in mathematical algebra(=, ≠, <, >, ≤, ≥)
b.in relational algebra (=, <, <=, >, >=)
5. Logical operators(And, Or, Not)

Example of using selection operation within a relation: σ last_name='Mugisha' ("Customers") where the table "Customers" in learning activities 4.1 is considered.

The result is a binary relation listing all the "Customers" with the name Mugisha.

id	name	age	address	salary
4	mugisha	25	nyamagabe	6500

result of σ name='Mugisha' ("**Customers**")

Application activity 4.1:

Using the table “Customers” in learning activities 4.1, what is the result of the following statements?

- i. σ Salary>2000 (“Customers”)
- ii. σ age>=23 AND address \neq kigali(“Customers”)

4.1.1.b Projection operation

Activity 4.2

From the table “Customers”, display the following table with only two columns name and age

name	age
muhirwa	25
kabandana	23
mugisha	25
nyampundu	27
uwera	22
mutoni	24

Result for π name,age (“Customers”)

The PROJECT operation is another unary operation. This operation returns a set of tuples containing a subset of the attributes in the original relation. Thus, we state that the SELECT operation selects some rows and discards the others. The PROJECT operation, on the other hand, selects some columns of the relation and discards the other column. The PROJECT operation can be viewed as the vertical filter of the relation.

The projection operation copies its arguments relation, but certain columns are left out. The projection operation lists the desired attributes to appear in the result as a subscript to π .

Projection is unary operation denoted by the Greek letter pi (π).

- Syntax: π attribute-list(*r*)
- Eg: Π attribute_1, attribute_2,..., attribute_n(*Relation*)

Project Operation Notation Model:



Notice that if the projection produces two identical rows, the duplicate rows must be removed since the relation is a set and it is not allowed to contain identical records.

Eg:Example: Retrieve the suburbs that are stored in database

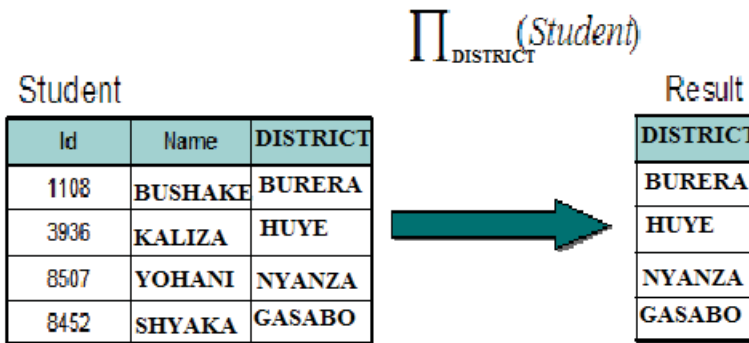

Application activity 4.2:

What is the result of the following statements?

- i. π ID, Address ("Customers")
- ii. π name,Salary(σ Salary>5000) ("Customers")

4.1.2 Binary operations

A binary operation is an operation that uses two operands (relations). In Relational algebra, the binary operations are Cartesian product, Union operator, Set Difference, Intersection, Theta-join and Natural Join.

Activity 4.3:

We have two relations, student and subject, as follows:

First_name	Last_name
John	Kamanzi
Sarah	Umutoni

Student relation

Course_name
Mathematics
ICT
English

Subject Relation

How can be generated the following table?

First_name	Last_name	CourseName
John	Kamanzi	Mathematics
John	Kamanzi	ICT
John	Kamanzi	English Mathematics
Sarah	Umutoni Umutoni	ICT
Sarah	Umutoni	English
Sarah		

The Cartesian product of two relations, R_1 and R_2 , is written in infix notation as $R_1 \times R_2$. To define the final relation scheme, we need to use **fully qualified attribute** names. Practically, it means we attach the name of the original relation in front of the attribute. This way we can distinguish $R_1.A$ from $R_2.A$. If $R_1(A_1, A_2, \dots, A_n)$ and $R_2(A_1, A_2, \dots, A_n)$ are relations, then the Cartesian product $R_1 \times R_2$ is a relation with a scheme containing all fully qualified attribute names from R_1 and R_2 : $(R_1.A_1, \dots, R_1.A_n, R_2.A_1, \dots, R_2.A_n)$.

The records of Cartesian product are formed by combining each possible pair of records: one from the R_1 relation and another from the R_2 relation. If there are n_1 records in R_1 and n_2 records in R_2 , then there are $n_1 \times n_2$ records in their Cartesian product.

The results of a **Cartesian product** is a relation whose scheme is a concatenation of student scheme and subject scheme. In this case, there are no identical attribute names. For that reason, we do not need to use the fully qualified attribute names. Student relation contained 2 records, subject relation 3, therefore, the result has 6 records (2 times 3).

Note that the Cartesian product contains no more information than its components contain together. However, the Cartesian product consumes much more memory than the two original relations consume together. These are two good reasons why Cartesian product should be de-emphasized, and used primarily for explanatory or conceptual purpose.

Application activity 4.3:

Carry out the following activity:

X	A	B		C	D	Y
	1	2	X	6	7	
	3	4		8	9	

A. Union operator

Activity 4.4:

First_name	Last_name	First_name	Last_name
John	Kamanzi	Rebekah	Hogoza
Sarah	Umutoni	Ashley	Isimbi
Joe	Mucyo	John	Kamanzi
David	Ntwari	Joe	Mucyo
Amanda	Umwari		
Joel	Kamanzi		

Student relation

Teacher relation

What was the operation performed in order to get this table?

First_name	Last_name
John	Kamanzi
Sarah	Umutoni
Joe	Mucyo
David	Ntwari
Amanda	Umwari
Joel	Kamanzi
Rebekah	Hogoza
Ashley	Isimbi

The result of the query are all the people (students and teachers) appearing in either or both of the two relations. Again, since relations are sets, duplicate values are dropped.

The binary operation Union is denoted, as in set theory, by \cup . Union is intended to bring together all of the facts from its arguments, however, the relational union operator is intentionally not as general as the union operator in mathematics.

We cannot allow for an example that shows union of a binary and a ternary relation, because the result of such union is not a relation. Formally, we must ensure that union is applied to two union compatible relations. Therefore, for a union operator $R_1 \cup R_2$ to be legal, it is required that two conditions be held:

1. The relations R1 and R2 are of the same arity. Which means, they have the same numbers of attributes.
2. The domains of the *i*th attribute of R1 and *i*th attribute of R2 are the same.

Application activity 4.4:

Carry out the following activity:

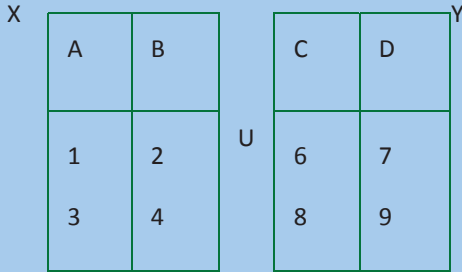

B. Set Difference

Activity 4.5:

From the following table:

First_name	Last_name
John	Kamanzi
Sarah	Umutoni
Joe	Mucyo
David	Ntwari
Amanda	Umwari
Joel	Kamanzi

Student relation

First_name	Last_name
Rebekah	Hogoza
Ashley	Isimbi
John	Kamanzi
Joe	Mucyo

Teacher relation

What is the operation performed in order to generate the following table?

First_name	Last_name
Sarah	Umutoni
David	Ntwari
Amanda	Umwari
Joel	Kamanzi

The last fundamental operation we need to introduce is set difference. The set difference, denoted by $-$ is a binary operator. To apply this operator to two relations, it is required for them to be union compatible. The result of the expression $R1-R2$, is a relation obtained by including all records from $R1$ that do not appear in $R2$. Of course, the resulting relation contains no duplicate records.

Note that if the relations are union compatible, applying “set difference” to them is allowed.

C. Intersection

The first operation we add to relational algebra is intersection, which is a binary operation denoted by \cap symbol. Intersection is not considered a fundamental operation because it can be easily expressed using a pair of set difference operations. Therefore, we require the input relations to union compatible.

After applying the intersection operator, we obtain a relation containing only those records from $r1$ which also appear as records in $r2$. We do not need to eliminate duplicate rows because the resulting relation cannot contain any (since neither of the operands contain any).

Practical example:

Consider relations R and S

R

A	1
B	2
D	3
F	4
E	5

$R \cap S$

A	1
D	3

S

A	1
C	2
D	3
E	4

D. Join operations

SQL Joins can be classified into Equi join and Non Equi join.

1. SQL Equi joins

It is a simple sql join condition which uses the equal sign as the comparison operator. Two types of equi joins are SQL Outer join and SQL Inner join.

For example: You can get the information about a customer who purchased a product and the quantity of product.

2. SQL Non equi joins

Types of Joins:

Join is a special form of cross product of two tables. It is a binary operation that allows combining certain selections and a Cartesian product into one operation. The The join operation forms a Cartesian product of its two arguments, performs a selection forcing equality on those attributes that appear in both relation schemas, and finally removes duplicate attributes. Following are the different types of joins: Theta Join, Equi Join, Semi Join, Natural Join and Outer Joins

We will now discuss them one by one

1. Theta Join:

In theta join we apply the condition on input relation(s) and then only those selected rows are used in the cross product to be merged and included in the output. It means that in normal cross product all the rows of one relation are mapped/merged with all the rows of second relation, but here only selected rows of a relation are made cross product with second relation. It is denoted as $R \bowtie S$

For example there are two relations of FACULTY and COURSE now first apply select operation on the FACULTY relation for selection certain specific rows then these rows will have a cross product with COURSE relation, so this is the difference in between cross product and theta join. From this example the difference between cross product and theta join becomes clear.

FACULTY

F_ID	EMPLOYEE_NAME	DEPT	SALARY	RANK
F1	BUSHAKE	COMPUTER SCIENCE	800 000	PROF
F2	UWAJENEZA	ENGLISH	300 000	LECTURER
F3	MUGENZI	CIVIL ENGINEERING	400 000	PROF
F4	RUKUNDO	ENGLISH	150 000	LECTURER

COURSE

C_CODE	C_NAME	FAC_ID
C25	DATABASE	F1
C26	LITERATURE	
C27	DYNAMICS	F3
C28	PROGRAMMING	F4

($\delta_{RANK=PROF(FACULTY) \times COURSE}$)

F_ID	EMPLOYEE_NAME	DEPT	SALARY	RANK	C_CODE	C_NAME	FAC_ID
F1	BUSHAKE	COMPUTER SCIENCE	800 000	PROF	C25	DATABASE	F1
F1	BUSHAKE	COMPUTER SCIENCE	800 000	PROF	C26	LITERATURE	
F1	BUSHAKE	COMPUTER SCIENCE	800 000	PROF	C27	DYNAMICS	F3
F1	BUSHAKE	COMPUTER SCIENCE	800 000	PROF	C28	PROGRAMMING	F4
F3	MUGENZI	CIVIL ENGINEERING	400 000	PROF	C25	DATABASE	F1
F3	MUGENZI	CIVIL ENGINEERING	400 000	PROF	C26	LITERATURE	
F3	MUGENZI	CIVIL ENGINEERING	400 000	PROF	C27	DYNAMICS	F3
F3	MUGENZI	CIVIL ENGINEERING	400 000	PROF	C28	PROGRAMMING	F4

Two tables with an example of Theta join

2. Equi-Join:

This is the most used type of join. In equi-join rows are joined on the basis of values of a common attribute between the two relations. It means relations are joined on the basis of common attributes between them; which are meaningful. This means on the basis of primary key, which is a foreign key in another relation. Rows having the same value in the common attributes are joined. Common attributes appear twice in the output. It means that the attributes, which are common in both relations, appear twice, but only those rows, which are selected. Common attribute with the same name is qualified with the relation name in the output. It means that if primary and foreign keys of two relations are having the same names and if we take the equi-join of both then in the output relation the relation name will precede the attribute name. For Example, if we take the equi-join of FACULTY and COURSE relations then the output would be

FUCULTY \bowtie COURSE

F_ID	EMPLOYEE_NAME	DEPT	SALARY	RANK	C_CODE	C_NAME	FAC_ID
F1	BUSHAKE	COMPUTER SCIENCE	800 000	PROF	C25	DATABASE	F1
F3	MUGENZI	CIVILENGENEERING	400 000	PROF	C27	DYNAMICS	F3
F4	RUKUNDO	ENGLISH	150 000	LECTURER	C28	PROGRAMMING	F4

3. Natural Join:

This is the most common and general form of join. If we simply say join, it means the natural join. It is same as equi-join but the difference is that in natural join, the common attribute appears only once. Now, it does not matter which common attribute should be part of the output relation as the values in both are same. To join the tables use this symbol: \bowtie

FUCULTY \bowtie COURSE

F_ID	EMPLOYEE_NAME	DEPT	SALARY	RANK	C_CODE	C_NAME
F1	BUSHAKE	COMPUTER SCIENCE	800 000	PROF	C25	DATABASE
F3	MUGENZI	CIVILENGENEERING	400 000	PROF	C27	DYNAMICS
F4	RUKUNDO	ENGLISH	150 000	LECTURER	C28	PROGRAMMING

4. Outer Join:

This join condition returns all rows from both tables which satisfy the join condition along with rows which do not satisfy the join condition from one of the tables.

The Outer Join has three forms:

a. Left Outer Join:

In a left outer join all the tuples of left relation remain part of the output. The tuples that have a matching tuple in the second relation do have the corresponding tuple from the second relation. However, for the tuples of the left relation, which do not have a matching record in the right tuple, have null values against the attributes of the right relation. Left outer join is the equi-join plus the non matching rows of the left side relation having null against the attributes of right side relation.

The following example shows how Left Outer Join operation works:
Consider the relation BOOK and relation STUDENT

BOOK

BK_ID	BK_TITLE	ST_ID
FF54	BIOLOGY	S104
FG55	CHEMISTRY	S101
FH56	MATH	S101
FI57	COMPUTER SCIENCE	S103
FJ58	ECONOMICS	
FK59	GEOGRAPHY	S104

STUDENT

ST_ID	ST_NAME
S101	KAMANA PAUL
S103	DUSENGE INES
S104	NDOLI JOHN
S106	IRANZI CLAUDE
S107	MUGISHA GASANA YVE

BOOK Left Outer Join STUDENT Where BOOK.BK_ID = STUDENT.ST_ID

BK_ID	BK_TITLE	ST_ID	BK_ID	BK_TITLE
FF54	BIOLOGY	S104	S104	NDOLI JOHN
FG55	CHEMISTRY	S101	S101	KAMANA PAUL
FH56	MATH	S101	S101	KAMANA PAUL
FI57	COMPUTER SCIENCE	S103	S103	DUSENGE INES
FK59	GEOGRAPHY	S104	S104	NDOLI JOHN
FJ58	ECONOMICS	Null	Null	Null

b. Right Outer Join:

In right outer join all the tuples of right relation remain part of the output relation, whereas on the left side the tuples, which do not match with the right relation, are left as null. It means that right outer join will always have all the tuples of right relation and those tuples of left relation which are not matched are left as Null. The following example shows how Right Outer Join operation works:

Consider the Relation BOOK and Relation STUDENT

BOOK Right Outer Join STUDENT Where BOOK.BK_ID = STUDENT.ST_ID

BK_ID	BK_TITLE	ST_ID	BK_ID	BK_TITLE
FF54	BIOLOGY	S104	S104	NDOLI JOHN
FG55	CHEMISTRY	S101	S101	KAMANA PAUL
FH56	MATH	S101	S101	KAMANA PAUL
FI57	COMPUTER SCIENCE	S103	S103	DUSENGE INES
FK59	GEOGRAPHY	S104	S104	NDOLI JOHN
Null	Null	Null	S106	IRANZI CLAUDE
Null	Null	Null	S107	MUGISHA GASANA YVE

c. Full Outer Join:

In outer join all the tuples of left and right relations are part of the output. It means that all those tuples of left relation which are not matched with right relation are left as null. Similarly all those tuples of right relation which are not matched with left relation are left as null.

The following example shows how Right Outer Join operation works:

Consider the relation BOOK and relation STUDENT

BOOK Full Outer Join STUDENT Where BOOK.BK_ID = STUDENT.ST_ID

BK_ID	BK_TITLE	ST_ID	BK_ID	BK_TITLE
FF54	BIOLOGY	S104	S104	NDOLI JOHN
FG55	CHEMISTRY	S101	S101	KAMANA PAUL
FH56	MATH	S101	S101	KAMANA PAUL
FI57	COMPUTER SCIENCE	S103	S103	DUSENGE INES
FK59	GEOGRAPHY	S104	S104	NDOLI JOHN
FJ58	ECONOMICS	Null	Null	Null
Null	Null	Null	S106	IRANZI CLAUDE
Null	Null	Null	S107	MUGISHA GASANA YVES

d. Division Operator

Division identifies attribute values from a relation that are paired with all of the values from another relation.

Application activity 4.5:

1. Solve the following relational expressions for these relations:

User

Id	Name	Age	Gender	OccupationId	CityId
1	Mukamana	25	Male	1	3
2	Gakuru	20	Female	3	4
3	Mukama	31	Male	2	5
4	Cyiza	27	Female	1	3

Occupation

OccupationId	OccupationName
1	Software Engineer
2	Accountant
3	Pharmacist
4	Library Assistant

City

CityId	CityName
1	Kigali
2	Huye
3	Nyamagabe
4	Gasabo
5	Nyagatare

- $\pi_{\text{Name}}(\delta_{\text{Age}>25}(\text{User}))$ same as $\delta_{\text{Name}}(\delta_{\text{Age}>25}(\text{User}))$
- $\delta_{(\text{Id}>2 \vee \text{Age} \neq 31)}(\text{User})$
- $\delta_{(\text{User.OccupationId}=\text{Occupation.OccupationId})}(\text{User} \times \text{Occupation})$
- $\pi_{\text{Name,Gender}}(\delta_{\text{CityId}=1}(\text{User} \bowtie \text{City}))$

- With clear example, differentiate unary operators and binary operators.
- Use an example and explain projection and selection operations.
- Consider ABC database containing the following relations:

Representative (number, surname, firstname, committee, county)

Counties (code, name, region)

Regions (code, name)

Committees (number, name, president)

Formulate the following queries in relational algebra, in domain calculus and in record calculus:

- Find the number and surname of the Representatives from the country of Rwanda;
- Find the name and surname of representatives;
- Find the members of the finance committee;
- Find the name, surname, country and region of election of the delegates of the finance committee;
- Find the regions in which representatives having the same surname have been elected.

5. Consider the DEFG database schema with the relations:

Courses (number, faculty, coursetitle, tutornumber)

Students (number, surname, firstname, faculty)

Tutors (number, surname, firstname)

Exams (studentnumber, coursenum, grade, date)

Studyplan (studentnumber, coursenum, year)

- * Formulate in relational algebra the queries that produce:
- * The students who have gained an 'A' in at least one exam, showing, for each of them, the first name, surname and the date of the first of such occasions;
- * For every course in the engineering faculty, the students who passed the exam during the last session;
- * The students who passed all the exams required by their respective study plans;
- * For every course in the literature faculty, students who passed the exam with the highest grades;
- * The students whose study plans require them to attend lectures only in their own faculties;
- * First name and surname of the students who have taken an exam with a tutor having the same surname as the student.

4.2 Structured Query language

Activity 4.6:

1. Consider the following relational schema of HIJK database;

Departments (Dept_Code (integer), name (text) , Budget (number)) Employees (SSN (integer), first_name (text), last_name (text), Dept_Code (integer, foreign key) Write SQL query to:

- i. Create the above relations (tables)
- ii. Add at least ten records
- iii. Select the last name of all employees, without duplicates.
- iv. Select all the data of employees whose first name is "Peter" or "Diane".
- v. Retrieve the sum of all the departments' budgets.
- vi. Retrieve all the data of employees whose last name begins with letter "U".
- vii. Show the number of employees in each department (you only need to show the department code and the number of employees).
- viii. Select the name and last name of employees working for departments with a budget greater than 6,000,000 (currency: Rwf)
- ix. Show the departments with a budget larger than the average budget of all the departments.
- x. Add a new department called "Quality Assurance", with a budget of 4,000,000 (currency: Rwf) and departmental code 11. Add an employee called "KAMANA" in that department, with SSN 847-21-9811.
- xi. Reduce the budget of all departments by 10%.
- xii. Delete from the table all employees in the IT department (code 14).

4.2.0. Introduction

SQL which is an abbreviation for **Structured Query Language**, is a language to request data from a database, to add, update, or remove data within a database, or to manipulate the metadata of the database.

Commonly used statements are grouped into the following categories:

DML: Data Manipulation Language

DDL: Data Definition Language

DCL: Data Control Language

4.2.1 Data Definition Language (DDL)

a. To create a new database, the SQL query used is **CREATE DATABASE**

The Syntax is:

```
create database databasename;
```

Always database name should be unique within the RDBMS. Example of a query to create a database called XYZLtd

CREATE DATABASE XYZLtd; In MYSQL, it will look like the following:

```
mysql> create database XYZLtd;
```

Make sure that the user has admin privilege before creating any database.

b. To display the list of all databases created, the SQL query is **SHOW databases;**

Once a database is created, the user can check it in the list of databases as follows:

Show databases;

If the RDBMS used is MYSQL, the result will look like this:

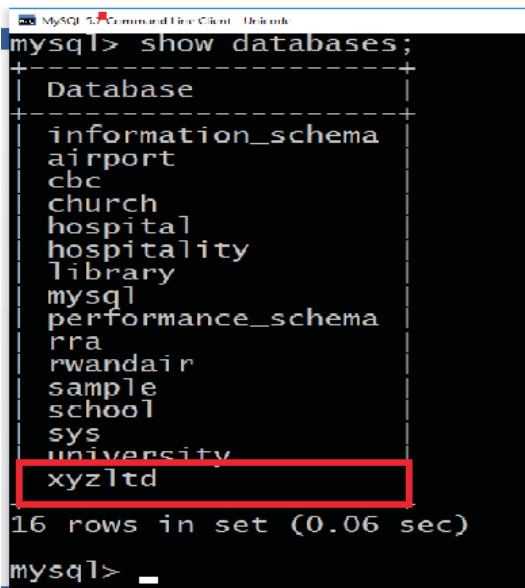

```
mysql> show databases;
+-----+
| Database                |
+-----+
| information_schema      |
| airport                 |
| cbc                     |
| church                  |
| hospital                |
| hospitality              |
| library                 |
| mysql                   |
| performance_schema     |
| rra                     |
| rwandair                |
| sample                  |
| school                  |
| sys                     |
| university              |
| xyzltd                  |
+-----+
16 rows in set (0.06 sec)

mysql> _
```

c. Before using a database, the SQL command USE helps to select the name of the database.

The SQL USE statement is used to select any existing database in the SQL schema. Syntax: The basic syntax of the USE statement is as shown below: Always the database name should be unique within the RDBMS. Now, if the user wants to work with the XYZLtd database, then he/she can execute the following SQL command and start working with the School database.

```
mysql> use XYZLtd;
```

d. After creating a database and entering in it, there is a need now to create table

Creating a basic table involves naming the table and defining its columns and each column's data type. The SQL **CREATE TABLE** statement is used to create a new table.

the basic syntax of CREATE TABLE statement is as follows:

```
create table table_name (column1 datatype, column2 datatype, column3 datatype,  
..... columnn datatype,  
primary key( one or more columns ) );
```

CREATE TABLE is the keyword telling the database system what you want to do. In this case, you want to create a new table. The unique name or identifier for the table follows the CREATE TABLE statement.

Then in brackets comes the list defining each column in the table and what sort of data type it is. The syntax becomes clearer with an example below.

Activity 4.7:

The following SQL query creates a "Customers" table with ID as primary key and NOT NULL and thereafter, when the table was successfully created, the message "Query OK, 0 rows affected (0.48 sec)" is displayed. See below.

```

mysql> use xyzltd;
Database changed
mysql> create table customers(
->   id          int          not null, not null,
->   name       varchar(20)   not null,
->   age        int          not null,
->   address    char(25)     ,
->   salary     int,
->   primary   key(id)
->);
query OK, 0 rows affected (0.48 sec)
mysql>

```

The user can verify if the table has been created successfully by looking at the message displayed by the SQL server, otherwise he/she can use DESC command as follows:

```

mysql> desc customers;
+----+-----+-----+-----+-----+-----+
| Field | Type          | Null | Key | Default | Extra |
+----+-----+-----+-----+-----+-----+
| id    | int(11)       | NO   | PRI | NULL    |       |
| name  | varchar(20)   | NO   |     | NULL    |       |
| age   | int(11)       | NO   |     | NULL    |       |
| address | char(25)     | YES  |     | NULL    |       |
| salary | int(11)       | YES  |     | NULL    |       |
+----+-----+-----+-----+-----+-----+
5 rows in set (0.02 sec)
mysql>

```

Now, "Customers" table is created and available in database. It can be used to store required information related to "Customers".

Notice that DESC is the same as DESCRIBE is some RDBMS.

e. Create Table Using another Table:

A copy of an existing table can be created using a combination of the CREATE TABLE statement and the SELECT statement.

The new table has the same column definitions. All columns or specific columns can be selected.

When you create a new table using existing table, new table would be populated using existing values in the old table.

The basic syntax for creating a table from another table is as follows:

```
create table new_table_name as like existing_table_name [ where ]
```

Example:

To create a table called SALARY having the same attributes like table “Customers”, write

Create table salary like “Customers”;

```
mysql> create table salary like customers;
Query OK, 0 rows affected (0.55 sec)

mysql>
```

The structure of SALARY is displayed in the following interface.

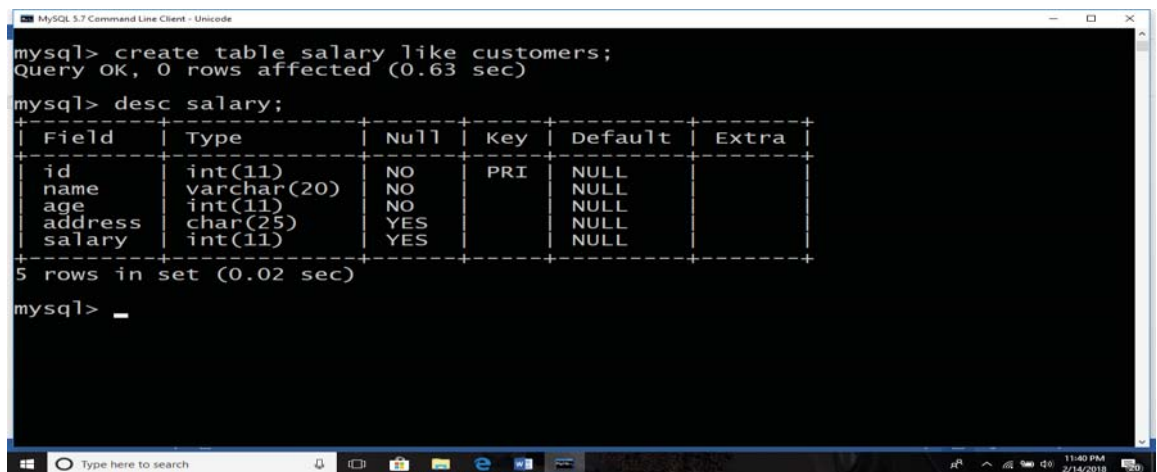

```
mysql> create table salary like customers;
Query OK, 0 rows affected (0.63 sec)

mysql> desc salary;
+-----+-----+-----+-----+-----+-----+
| Field | Type          | Null | Key | Default | Extra |
+-----+-----+-----+-----+-----+-----+
| id    | int(11)       | NO   | PRI | NULL    |       |
| name  | varchar(20)   | NO   |     | NULL    |       |
| age   | int(11)       | NO   |     | NULL    |       |
| address | char(25)     | YES  |     | NULL    |       |
| salary | int(11)       | YES  |     | NULL    |       |
+-----+-----+-----+-----+-----+-----+
5 rows in set (0.02 sec)

mysql> _
```

f. To remove a table from a database, use the SQL Command “DROP TABLE”.

The SQL **DROP TABLE** statement is used to remove a table definition and all its data.

Notice that the user has to be careful while using this command because once a table is deleted then all the information available in the table would also be lost forever.

The Basic syntax of DROP TABLE statement is as follows:

```
drop table table_name;
```

Example:

```
DROP TABLE “Customers”;
```

To make sure that the table has been removed, check with

DESC “Customers”; and the answer will be like the following:

```
mysql> drop table customers;
Query OK, 0 rows affected (0.27 sec)

mysql> desc customers;
ERROR 1146 (42S02): Table 'xyzltd.customers' doesn't exist
mysql> _
```

“CUSTOMERS” Relation

```
mysql> desc customers;
+-----+-----+-----+-----+-----+-----+
| Field | Type          | Null | Key | Default | Extra |
+-----+-----+-----+-----+-----+-----+
| id    | int(11)       | NO   | PRI | NULL    |       |
| name  | varchar(20)   | NO   |     | NULL    |       |
| age   | int(11)       | NO   |     | NULL    |       |
| address | char(25)     | YES  |     | NULL    |       |
| salary | int(11)       | YES  |     | NULL    |       |
| sex   | char(1)       | YES  |     | NULL    |       |
+-----+-----+-----+-----+-----+-----+
6 rows in set (0.00 sec)

mysql> drop table customers;
Query OK, 0 rows affected (0.27 sec)

mysql> desc customers;
ERROR 1146 (42S02): Table 'xyzltd.customers' doesn't exist
mysql> _
```

g. To add, delete or modify columns in an existing table, use the SQL Command ALTER TABLE followed by either ADD or DROP or MODIFY.

ALTER TABLE command can also be used to add and drop various constraints on an existing table.

The basic syntax of **ALTER TABLE** to add a new column in an existing table is as follows:

```
alter table table_name add column_name datatype;
```

The basic syntax of ALTER TABLE to **DROP COLUMN** in an existing table is as follows:

```
alter table table_name drop column column_name;
```

The basic syntax of ALTER TABLE to change the **DATA TYPE** of a column in a table is as follows:

```
alter table table_name modify column column_name datatype;
```

The basic syntax of ALTER TABLE to add a **NOT NULL** constraint to a column in a table is as follows:

```
alter table table_name modify column_name datatype not null;
```

The basic syntax of ALTER TABLE to **ADD UNIQUE CONSTRAINT** to a table is as follows:

```
alter table table_name  
add constraint myuniqueconstraint unique(column1, column2...);
```

The basic syntax of ALTER TABLE to ADD CHECK CONSTRAINT to a table is as follows:

```
alter table table_name  
add constraint myuniqueconstraint check (condition);
```

The basic syntax of ALTER TABLE to **ADD PRIMARY KEY** constraint to a table is as follows:

```
alter table table_name add constraint myprimarykey primary key (column1,  
column2...);
```

The basic syntax of ALTER TABLE to **DROP CONSTRAINT** from a table is as follows:

```
alter table table_name drop constraint myuniqueconstraint;
```

If you're using MySQL, the code is as follows:

```
alter table table_name drop index myuniqueconstraint;
```

The basic syntax of ALTER TABLE to **DROP PRIMARY KEY** constraint from a table is as follows:

```
alter table table_name drop constraint myprimarykey;
```

If you're using MySQL, the code is as follows:

```
alter table table_name drop primary key;
```

Application activity 4.7:

You are given a flat database named "Library", with a relation Book (ISBN (Text, primary key), title (text), author (text), pages (integer), and price (integer)) Create this database and relation, then insert at least five records.

4.2.1.a SQL Constraints

Activity 4.8:

Consider "Customers" relation, perform the following tasks;

- i. Add new column "sex"
- ii. Change the datatype of salary to decimals
- iii. Add "Not null" constraint to age field (column)
- iv. Remove the column "sex"
- v. Drop "not null" constraint from age field.

Constraints are the rules enforced on data columns of a table. These are used to limit the type of data that can go into a table. This ensures the accuracy and reliability of the data in the database.

Constraints could be column level or table level. Column level constraints are applied only to one column whereas table level constraints are applied to the whole table.

Following are commonly used constraints available in SQL. These constraints have already been discussed in SQL - RDBMS

Following are commonly used constraints available in SQL:

- **Not null constraint:** ensures that a column cannot have null value.
- **Default constraint:** provides a default value for a column when none is specified.
- **Unique constraint:** ensures that all values in a column are different.
- **Primary key:** uniquely identified each rows/records in a database table.
- **Foreign key:** uniquely identified a row/record in any other database table.
- **Check constraint:** the check constraint ensures that all values in a column

satisfy certain conditions.

- **Index:** use to create and retrieve data from the database very quickly.
- **NOT NULL Constraint:**

By default, a column can hold NULL values. If the user does not want a column to have a NULL value, then he/she needs to define such constraint on this column specifying that NULL is now not allowed for that column. A NULL is not the same as no data, rather, it represents unknown data.

Example:

For example, the following SQL query creates a new table called "CUSTOMERS" and adds five columns, three of which, ID and NAME and AGE, specify not to accept NULLs:

```
create table "Customers"(  
    id int        not null,  
    name varchar (20) not null,  
    age int       not null,  
    address char (25) ,  
    salary Int,  
    primary key (id)  
);
```

a. DEFAULT Constraint:

The DEFAULT constraint provides a default value to a column when the INSERT INTO statement does not provide a specific value.

Example:

For example, the following SQL creates a new table called "CUSTOMERS" and adds five columns. Here, SALARY column is set to 5000 by default, so in case INSERT INTO statement does not provide a value for this column, then by default this column would be set to 5000.

```
create table "Customers"(  
    id int        not null,  
    name varchar (20) not null,  
    age int       not null,  
    address char (25) ,  
    salary int default 5000,  
    primary key (id)  
);
```

If "Customers" table has already been created, then to add a DEFAULT constraint to SALARY column, write a statement similar to the following:

```
alter table "Customers" modify salary int default 5000;
```

Drop "Default" Constraint:

To drop a DEFAULT constraint, use the following SQL:

```
alter table "Customers" alter column salary drop default;
```

b. UNIQUE Constraint:

The UNIQUE Constraint prevents two records from having identical values in a particular column. In the "Customers" table, for example, you might want to prevent two or more people from having identical age.

Example:

For example, the following SQL creates a new table called "CUSTOMERS" and adds five columns. Here, AGE column is set to UNIQUE, so that you cannot have two records with same age:

```
create table "Customers"(  
    id int        not null,  
    name varchar (20) not null,  
    age int       not null unique,  
    address char (25) ,  
    salary Int,  
    primary key (id)  
);
```

If "CUSTOMERS" table has already been created, then to add a UNIQUE constraint to AGE column, you would write a statement similar to the following:

```
alter table "Customers" modify age int not null unique;
```

The user can also use the following syntax, which supports naming the constraint in multiple columns as well:

```
alter table "Customers" add constraint myuniqueconstraint unique(age, salary);
```

Drop a UNIQUE Constraint:

To drop a UNIQUE constraint, use the following SQL:

```
alter table "Customers" drop constraint myuniqueconstraint;
```

If you are using MySQL, then you can use the following syntax:

```
alter table "Customers" drop index myuniqueconstraint;
```

c. PRIMARY Key:

A primary key is a field in a table which uniquely identifies each row/record in a database table. Primary keys must contain unique values. A primary key column cannot have NULL values.

A table can have only one primary key, which may consist of single or multiple fields. When multiple fields are used as a primary key, they are called a **composite key**.

If a table has a primary key defined on any field(s), then it is impossible to have two records having the same value of that field(s).

Notice that these concepts can be used while creating database tables.

The syntax to define ID attribute as a primary key in a "CUSTOMERS" table is:

```
create table "Customers"(  
    id int not null,  
    name varchar (20) not null,  
    age int not null,  
    address char (25) ,  
    salary Int,  
    primary key (id)  
);
```

To create a PRIMARY KEY constraint on the "ID" column when "CUSTOMERS" table already exists, use the following SQL syntax:

Alter table customers add primary key (ID);

Notice that to use the ALTER TABLE statement to add a primary key, the primary key column(s) must already have been declared to not contain NULL values (when the table was first created).

For defining a PRIMARY KEY constraint on multiple columns, use the following SQL syntax:

```
create table "Customers"(  
    id int      not null,  
    name varchar (20)  not null,  
    age int      not null,  
    address char (25) ,  
    salary Int,  
    primary key (id, name)  
);
```

To create a PRIMARY KEY constraint on the "ID" and "NAMES" columns when "CUSTOMERS" table already exists, use the following SQL syntax:

```
alter table "Customers"  add constraint pk_custid primary key (id, name);
```

To delete the Primary Key constraints from the table,

, use the Syntax:

```
alter table "Customers" drop primary key;
```

d. FOREIGN Key:

A foreign key is a key used to link two tables together. This is sometimes called a referencing key.

The Foreign Key is a column or a combination of columns, whose values match a Primary Key in a different table.

The relationship between 2 tables matches the Primary Key in one of the tables with a Foreign Key in the second table.

If a table has a primary key defined on any field(s), then you cannot have two records having the same value of that field(s).

Example:

Consider the structure of the two tables as follows:

“CUSTOMERS” table:

```
mysql> create table customers(  
->     id      int          not null,  
->     name   varchar(20)   not null,  
->     age    int          not null,  
->     address char(25) ,  
->     salary int,  
->     primary key (id)  
-> );
```

```
mysql> desc customers;  
+-----+-----+-----+-----+-----+-----+  
| Field | Type          | Null | Key | Default | Extra |  
+-----+-----+-----+-----+-----+-----+  
| id    | int(11)       | NO   | PRI | NULL    |      |  
| name  | varchar(20)   | NO   |     | NULL    |      |  
| age   | int(11)       | NO   |     | NULL    |      |  
| address | char(25)     | YES  |     | NULL    |      |  
| salary | int(11)       | YES  |     | NULL    |      |  
+-----+-----+-----+-----+-----+-----+  
5 rows in set (0.03 sec)
```

ORDERS table:

```
mysql> create table orders (  
->     id      int          not null,  
->     date    datetime,  
->     customer_id int ,  
->     amount  double,  
->     primary key (id)  
-> );  
Query OK, 0 rows affected (0.56 sec)  
mysql> _
```

If ORDERS table has already been created, and the foreign key has not yet been, use the syntax for specifying a foreign key by altering a table.

```
alter table orders add foreign key (customer_id) references "Customers" (id);
```

Drop a FOREIGN KEY Constraint:

To drop a FOREIGN KEY constraint, use the following SQL:

```
alter table orders drop foreign key;
```

e. CHECK Constraint:

The CHECK Constraint enables a condition to check the value being entered into a record. If the condition evaluates to true, the record violates the constraint and isn't entered into the table.

Example:

For example, the following SQL creates a new table called "CUSTOMERS" and adds five columns. Here, we add a CHECK with AGE column, so that you cannot have any Customer below 18 years:

```
create table "Customers"(  
    id int      not null,  
    name varchar (20)  not null,  
    age int      not null check  
(age >= 18),  
    address char (25) ,  
    salary Int,  
    primary key (id)  
);
```

If "Customers" table has already been created, then to add a CHECK constraint to AGE column, you would write a statement similar to the following:

```
alter table "Customers" modify age int not null check (age >= 18);
```

You can also use following syntax, which supports naming the constraint and multiple columns as well:

```
alter table "Customers" add constraint mycheckconstraint check(age >= 18);
```

Drop a CHECK Constraint:

To drop a CHECK constraint, use the following SQL. This syntax does not work with MySQL:

```
alter table "Customers" drop constraint mycheckconstraint;
```

Dropping Constraints:

Any constraint that you have defined can be dropped using the ALTER TABLE command with the DROP CONSTRAINT option.

For example, to drop the primary key constraint in the EMPLOYEES table, you can use the following command:

```
alter table employees drop constraint employees_pk;
```

Some implementations may provide shortcuts for dropping certain constraints. For example, to drop the primary key constraint for a table in Oracle, you can use the following command:

```
alter table employees drop primary key;
```

Some implementations allow you to disable constraints. Instead of permanently dropping a constraint from the database, you may want to temporarily disable the constraint, and then enable it later.

Integrity Constraints:

Integrity constraints are used to ensure accuracy and consistency of data in a relational database. Data integrity is handled in a relational database through the concept of referential integrity.

There are many types of integrity constraints that play a role in referential integrity (RI). These constraints include Primary Key, Foreign Key, Unique Constraints and other constraints mentioned above.

4.2.2 Data Manipulation Language (DML)

A. Insert into command

The SQL **INSERT INTO** Statement is used to add new rows of data into a table in the database.

There are two basic syntaxes of INSERT INTO statement as follows:

```
insert into table_name (column1, column2, column3,...columnn)] values  
(value1, value2, value3,...valuen);
```

Here, column1, column2,..columnN are the names of the columns in the table into which you want to insert data.

You may not need to specify the column(s) name in the SQL query if you are adding values for all the columns of the table. But make sure the order of the values is in the same order as the columns in the table. The SQL INSERT INTO syntax would be as follows:

```
insert into table_name values (value1,value2,value3,...valuen);
```

Activity 4.9:

Create/ insert six records in "Customers" table (relation). Use two possible ways to insert records (tuples) in a table:

First method:

```
MySQL 5.7 Command Line Client - Unicode
Query OK, 1 row affected (0.16 sec)

mysql> insert into customers (id,name,age,address,salary)
-> values (2,'muhirwa', 25, 'muhanga', 1500 );
Query OK, 1 row affected (0.01 sec)

mysql>
mysql> insert into customers (id,name,age,address,salary)
-> values (3,'kabandana', 23, 'huye', 2000 );
Query OK, 1 row affected (0.06 sec)

mysql>
mysql> insert into customers (id,name,age,address,salary)
-> values (4,'mugisha', 25, 'nyamagabe', 6500 );
Query OK, 1 row affected (0.05 sec)

mysql> insert into customers (id,name,age,address,salary)
-> values (5,'nyampundu', 27, 'gasabo', 8500 );
Query OK, 1 row affected (0.06 sec)

mysql>
mysql> insert into customers (id,name,age,address,salary)
-> values (6,'uwera', 22, 'nyagatare', 4500 );
Query OK, 1 row affected (0.06 sec)
```

Second method:

```
MySQL 5.7 Command Line Client - Unicode
mysql> insert into customers
-> values (7,'mutoni', 24, 'rusizi', 10000 );
Query OK, 1 row affected (0.09 sec)

mysql> _
```

All the above statements would produce the following records in "Customers" table:

```
MySQL 5.7 Command Line Client - Unicode
mysql> insert into customers
-> values (7,'mutoni', 24, 'rusizi', 10000 );
Query OK, 1 row affected (0.09 sec)

mysql> select * from customers;
+----+-----+-----+-----+-----+
| id | name   | age  | address | salary |
+----+-----+-----+-----+-----+
| 1  | keza  | 32   | kigali  | 2000   |
| 2  | muhirwa | 25   | muhanga | 1500   |
| 3  | kabandana | 23   | huye    | 2000   |
| 4  | mugisha | 25   | nyamagabe | 6500   |
| 5  | nyampundu | 27   | gasabo  | 8500   |
| 6  | uwera  | 22   | nyagatare | 4500   |
| 7  | mutoni | 24   | rusizi  | 10000  |
+----+-----+-----+-----+-----+
7 rows in set (0.00 sec)
```

New record

B. Select statement

The SELECT statement is used to select data from a database. The data returned is stored in a result table, called the result-set.

SELECT Syntax

```
SELECT column1, column2,...FROM table_name;
```

Here, column1, column2,... are the field names of the table you want to select data from. If you want to select all the fields available in the table, use the following syntax:

```
SELECT * FROM table_name;
```

SELECT * (Select all)

The following SQL statement selects all the columns from the "Customers" table:

```
SELECT * FROM "Customers";
```

```
mysql> select * from customers;
+----+-----+-----+-----+-----+
| id | name   | age  | address | salary |
+----+-----+-----+-----+-----+
| 2  | muhirwa | 25  | muhanga | 1500  |
| 3  | kabandana | 23  | huye   | 2000  |
| 4  | mugisha | 25  | nyamagabe | 6500  |
| 5  | nyampundu | 27  | gasabo | 2125  |
| 6  | uwera  | 22  | nyagatare | 4500  |
| 7  | mutoni | 24  | Ngororero | 10000 |
+----+-----+-----+-----+-----+
6 rows in set (1.38 sec)
```

The SQL SELECT DISTINCT Statement

The SELECT DISTINCT statement is used to return only distinct (different) values. Inside a table, a column often contains many duplicate values; and sometimes you only want to list the different (distinct) values. The SELECT DISTINCT statement is used to return only distinct (different) values.

SELECT DISTINCT Syntax

```
SELECT DISTINCT column1, column2 ...FROM table_name;
```

SELECT Example

The following SQL statement selects all (and duplicate) values from the "Address" column in the "Customers" table:

Example

```
SELECT Address FROM "Customers";
```

WHERE Clause Example

The following SQL statement selects all the "Customers" from the address "Muhanga", in the "Customers" table:

Example

```
SELECT * FROM "Customers"  
WHERE Address='Muhanga';
```

The SQL AND, OR and NOT Operators

The WHERE clause can be combined with AND, OR, and NOT operators. The AND, OR operators are used to filter records based on more than one condition: The AND operator displays a record if all the conditions separated by AND are TRUE. The OR operator displays a record if any of the conditions separated by OR is TRUE. The NOT operator displays a record if the condition(s) is NOT TRUE.

AND Syntax

```
SELECT column1, column2, ...  
FROM table_name  
WHERE condition1 AND condition2 AND condition3 ...;
```

OR Syntax

```
SELECT column1, column2, ...  
FROM table_name  
WHERE condition1 OR condition2 OR condition3 ...;
```

NOT Syntax

```
SELECT column1, column2, ...  
FROM table_name  
WHERE NOT condition;
```

AND Example

The following SQL statement selects all fields from “Customers” where address is “Nyamagabe” AND address is “Huye”:

Example

```
SELECT * FROM “Customers” WHERE Address=’Nyamagabe’ AND Address=’Huye’;
```

OR Example

The following SQL statement selects all fields from “Customers” where address is “Huye” OR “Nyamagabe”;

```
mysql> SELECT * FROM Customers WHERE Address=’Huye’ OR Address=’Nyamagabe’;
```

id	name	age	address	salary
3	kabandana	23	huye	2000
4	mugisha	25	nyamagabe	6500

```
2 rows in set (0.53 sec)
```

Example for NOT operator

The following SQL statement selects all fields from “Customers” where address is NOT “Nyamagabe”:

Example

```
SELECT * FROM “Customers” WHERE NOT Address=’Nyamagabe’;
```

Combining AND, OR and NOT

You can also combine the AND, OR and NOT operators.

The following SQL statement selects all fields from “Customers” where address is “Nyamagabe” AND address must be “Huye” OR “Nyamagabe” (use parenthesis to form complex expressions):

Example:

```
SELECT * FROM “Customers” WHERE Address=’Nyamagabe’ AND (Address=’Huye’ OR Address=’Nyamagabe’);
```

```
mysql> SELECT * FROM Customers WHERE Address=’Nyamagabe’ AND (Address=’Huye’ OR Address=’Nyamagabe’);
```

id	name	age	address	salary
4	mugisha	25	nyamagabe	6500

```
1 row in set (0.00 sec)
```

The following SQL statement selects all fields from “Customers” where address is NOT “Nyamagabe” and NOT “GASABO”:

Example:

```
SELECT * FROM “Customers” WHERE NOT Address = “Nyamagabe” AND NOT Address = “GASABO”;
```

Application activity 4.6:

You are given a flat database named “Library”, with a relation Book (ISBN (Text, primary key), title (text), author (text), pages (integer), and price (integer))

- i. Create this database and relation, then insert at least five records.
- ii. Retrieve ISBN and price of books written by “Bigirumwami”
- iii. Retrieve books whose price is between 30,000 and 200,000 Rwf
- iv. Select title and pages of all books
- v. Show the books that have more than 300 pages or books that cost more than 4,000 Rwf
- vi. Retrieve books written by authors whose name is started by A, B or C.
- vii. Order the books ‘titles from A to Z.
- viii. Retrieve top three books.
- ix. Delete books which have less than 50 pages
- x. Delete books written by “Kagame”.

C. Aggregate functions:

1. **SQL COUNT Function**- The SQL COUNT aggregate function is used to count the number of rows in a database table.
2. **SQL MAX Function**- The SQL MAX aggregate function allows us to select the highest (maximum) value for a certain column.
3. **SQL MIN Function**- The SQL MIN aggregate function allows us to select the lowest (minimum) value for a certain column.
4. **SQL AVG Function**- The SQL AVG aggregate function selects the average value for certain table column.
5. **SQL SUM Function**- The SQL SUM aggregate function allows selecting the total for a numeric column.
6. **SQL COUNT Function**

SQL COUNT Function is the simplest function and very useful in counting the number of records, which are expected to be returned by a SELECT statement.

```
mysql> use xyz1td;
Database changed
mysql> select * from customers;
+----+-----+-----+-----+-----+
| id | name   | age  | address | salary |
+----+-----+-----+-----+-----+
| 1  | keza  | 32   | kigali  | 2000   |
| 2  | muhirwa | 25  | muhanga | 1500   |
| 3  | kabandana | 23  | huye    | 2000   |
| 4  | mugisha | 25  | nyamagabe | 6500   |
| 5  | nyampundu | 27  | gasabo  | 8500   |
| 6  | uwera  | 22   | nyagatare | 4500   |
| 7  | mutoni | 24   | rusizi  | 10000  |
+----+-----+-----+-----+-----+
7 rows in set (0.00 sec)

mysql> select count(*) from customers;
+-----+
| count(*) |
+-----+
| 7        |
+-----+
1 row in set (0.00 sec)
```

Similarly, if you want to count the number of records that meet a given criteria, it can be done as follows to count records whose salary is 2000:

```
mysql> select count(*) from customers where salary=2000;
+-----+
| count(*) |
+-----+
| 2        |
+-----+
1 row in set (0.09 sec)

mysql> _
```

Notice that all the SQL queries are **case insensitive**, so it does not make any difference if you write SALARY or salary in WHERE condition.

SQL MAX Function

SQL MAX function is used to find out the record with maximum value among a record set.

```
mysql> select max(salary) from customers;
+-----+
| max(salary) |
+-----+
| 10000       |
+-----+
1 row in set (0.08 sec)
```

SQL MIN Function

SQL MIN function is used to find out the record with minimum value among a record set.

```
MySQL 5.7 Command Line Client - Unicode
mysql> SELECT MIN(salary) FROM customers;
+-----+
| MIN(salary) |
+-----+
|          1500 |
+-----+
1 row in set (0.00 sec)

mysql> _
```

You can use MIN Function along with MAX function to find out minimum value as well.

```
MySQL 5.7 Command Line Client - Unicode
mysql> SELECT MIN(salary) least, MAX(salary) max FROM customers;
+-----+-----+
| least | max  |
+-----+-----+
|  1500 | 10000 |
+-----+-----+
1 row in set (0.00 sec)

mysql>
```

SQL AVG Function

SQL AVG function is used to find out the average of a field in various records.

```
mysql> select avg(salary) as AVERAGE_SALARY from customers;
+-----+
| AVERAGE_SALARY |
+-----+
|          4089.2857 |
+-----+
1 row in set (0.30 sec)
```

7. SQL SUM Function

SQL SUM function is used to find out the sum of a field in various records.

```
mysql> SELECT sum(salary) FROM customers;
+-----+
| sum(salary) |
+-----+
|          35000 |
+-----+
1 row in set (0.00 sec)

mysql>
```

Application activity 4.7:

You are given a flat database named “Library”, with a relation Book (ISBN (Text, primary key), title (text), author (text), pages (integer), and price (integer))

- i. Create this database and relation, then insert at least five records.
- ii. Retrieve the amount to get when all books are sold.
- iii. Retrieve the most expensive book.
- iv. Select the least expensive book
- v. Show the total number of the books in book relation.
- vi. Find the average price of the books

D. String Expressions

SQL string functions are used primarily for string manipulation. The following table details the important string functions:

Name	Description
CONCAT()	Returns concatenated string
LCASE()	Synonym for LOWER()
LEFT()	Returns the leftmost number of characters as specified
LENGTH()	Returns the length of a string in bytes
LOWER()	Returns the argument in lowercase
REVERSE()	Reverses the characters in a string
RTRIM()	Removes trailing spaces
SPACE()	Returns a string of the specified number of spaces
STRCMP()	Compares two strings
TRIM()	Removes leading and trailing spaces
UCASE()	Synonym for UPPER()

a. CONCAT (str1,str2,...)

Returns the string that results from concatenating the arguments. May have one or more arguments. If all arguments are non-binary strings, the result is a non-binary string. If the arguments include any binary strings, the result is a binary string. A numeric argument is converted to its equivalent binary string form; if you want to

avoid that, you can use an explicit type cast, as in this example:

```
mysql> select concat('my','sql');
+-----+
| concat('my','sql') |
+-----+
| mysql              |
+-----+
1 row in set (0.09 sec)
mysql> _
```

b. LEFT(str,len)

Returns the leftmost len characters from the string str, or NULL if any argument is NULL.

```
mysql> select left('Abanyarwanda',8);
+-----+
| left('Abanyarwanda',8) |
+-----+
| Abanyarw                |
+-----+
1 row in set (0.00 sec)
mysql> _
```

c. LENGTH (str)

Returns the length of the string str measured in bytes. A multi-byte character counts as multiple bytes. This means that for a string containing five two-byte characters, LENGTH() returns 10, whereas CHAR_LENGTH() returns 5.

```
mysql> select length('Abanyarwanda');
+-----+
| length('Abanyarwanda') |
+-----+
| 12                      |
+-----+
1 row in set (0.05 sec)
mysql>
```

d. LOWER(str)

Returns the string str with all characters changed to lowercase according to the current character set mapping.

```
mysql> select lower('ABANYARWANDA');
+-----+
| lower('ABANYARWANDA') |
+-----+
| abanyarwanda          |
+-----+
1 row in set (0.08 sec)
mysql>
```

e. REVERSE(str)

Returns the string str with the order of the characters reversed.

```
mysql> select reverse('Abanyarwanda');
+-----+
| reverse('Abanyarwanda') |
+-----+
| adnawraynaba           |
+-----+
1 row in set (0.01 sec)
mysql>
```

f. STRCMP(str1, str2)

Compares two strings and returns 0 if both strings are equal, it returns -1 if the first argument is smaller than the second according to the current sort order otherwise it returns 1.

```
MySQL 5.7 Command Line Client - Unsecured
mysql> select strcmp('Abasore', 'abakobwa');
+-----+
| strcmp('Abasore', 'abakobwa') |
+-----+
|                               1 |
+-----+
1 row in set (0.00 sec)

mysql> select strcmp('Kigali', 'Kigali');
+-----+
| strcmp('Kigali', 'Kigali') |
+-----+
|                             0 |
+-----+
1 row in set (0.00 sec)

mysql> select strcmp('abana', 'abandi');
+-----+
| strcmp('abana', 'abandi') |
+-----+
|                          -1 |
+-----+
1 row in set (0.00 sec)
```

g. UPPER (str)

Returns the string str with all characters changed to uppercase according to the current character set mapping.

```
mysql> select upper('kigali');
+-----+
| upper('kigali') |
+-----+
| KIGALI          |
+-----+
1 row in set (0.00 sec)
mysql> _
```

Application activity 4.8:

You are given a flat database named “Library”, with a relation Book (ISBN (Text, primary key), title (text), author (text), pages (integer), and price (integer))

- i. Find the length of the title of the book which has 35050115-30 as ISBN
- ii. Reverse the name of the author who wrote the book “Imizirizo ya Kinyarwanda”.
- iii. Compare the names “Aloys” and “Alexis”.
- iv. Change “Ndi umunyarwanda” in upper case.
- v. Change “HELP EACH OTHER” in lower case

E. SQL JOINS

The SQL Joins clause is used to combine records from two or more tables in a database. A JOIN is a mean for combining fields from two tables by using values common to each.

Consider “Customers” and orders tables as follows:

```
mysql> desc customers;
+-----+-----+-----+-----+-----+-----+
| Field | Type | Null | Key | Default | Extra |
+-----+-----+-----+-----+-----+-----+
| id    | int(11) | NO | PRI | NULL |      |
| name  | varchar(20) | NO |      | NULL |      |
| age   | int(11) | NO |      | NULL |      |
| address | char(25) | YES |      | NULL |      |
| salary | int(11) | YES |      | NULL |      |
+-----+-----+-----+-----+-----+-----+
5 rows in set (0.06 sec)

mysql> desc orders;
+-----+-----+-----+-----+-----+-----+
| Field | Type | Null | Key | Default | Extra |
+-----+-----+-----+-----+-----+-----+
| id    | int(11) | NO | PRI | NULL |      |
| date  | datetime | YES |      | NULL |      |
| customer_id | int(11) | YES |      | NULL |      |
| amount | double | YES |      | NULL |      |
+-----+-----+-----+-----+-----+-----+
4 rows in set (0.08 sec)

mysql>
```

These two tables (relations) have the following records:

```
mysql> select * from customers;
+----+-----+-----+-----+-----+
| id | name      | age | address | salary |
+----+-----+-----+-----+-----+
| 1  | keza     | 32  | kigali  | 2000   |
| 2  | muhira  | 25  | muhanga | 1500   |
| 3  | kabandana | 23  | huye    | 2000   |
| 4  | mugisha | 25  | nyamagabe | 6500   |
| 5  | nyampundu | 27  | gasabo  | 8500   |
| 6  | uwera    | 22  | nyagatare | 4500   |
| 7  | mutoni   | 24  | rusizi  | 10000  |
+----+-----+-----+-----+-----+
7 rows in set (0.00 sec)

mysql> select * from orders;
+----+-----+-----+-----+
| id | date                | customer_id | amount |
+----+-----+-----+-----+
| 100 | 2017-10-02 00:00:00 | 3           | 1500   |
| 101 | 2017-01-20 00:00:00 | 2           | 1560   |
| 102 | 2017-10-02 00:00:00 | 3           | 3000   |
| 103 | 2016-05-20 00:00:00 | 4           | 2060   |
+----+-----+-----+-----+
4 rows in set (0.00 sec)
```

Now, let us join these two tables in our SELECT statement as follows:

```
SQL> select Customers.id, name, age, amount from Customers, orders
      where Customers.id = orders.customer_id;
```

This would produce the following result:

```
mysql> select customers.id, name, age, amount
->      from customers, orders
->      where customers.id = orders.customer_id;
+----+-----+-----+-----+
| id | name   | age  | amount |
+----+-----+-----+-----+
| 3  | kabandana | 23  | 1500   |
| 2  | muhirwa  | 25  | 1560   |
| 3  | kabandana | 23  | 3000   |
| 4  | mugisha  | 25  | 2060   |
+----+-----+-----+-----+
4 rows in set (0.00 sec)

mysql> _
```

Here, it is noticeable that the join is performed in the WHERE clause. Several operators can be used to join tables, such as =, <, >, <>, <=, >=, !=, BETWEEN, LIKE, and NOT; they can all be used to join tables. However, the most common operator is the equal symbol.

SQL Join Types:

There are different types of joins available in SQL:

Inner join: returns rows when there is a match in both tables.

Left join: returns all rows from the left table, even if there are no matches in the right table.

Right join: returns all rows from the right table, even if there are no matches in the left table.

Full join: returns rows when there is a match in one of the tables.

Self-join: is used to join a table to itself as if the table were two tables, temporarily renaming at least one table in the sql statement.

Cartesian join: returns the Cartesian product of the sets of records from the two or more joined tables.

1. INNER JOIN

The most frequently used and important of the joins is the INNER JOIN. They are also referred to as an EQUIJOIN.

The INNER JOIN creates a new result table by combining column values of two tables (table1 and table2) based upon the join-predicate. The query compares each row of table1 with each row of table2 to find all pairs of rows which satisfy the join-predicate. When the join-predicate is satisfied, column values for each matched pair of rows of A and B are combined into a result row.

The basic syntax of INNER JOIN is as follows:

```
select table1.column1, table2.column2... from table1 inner join table2 orders
on table1.common_field = table2.common_field;
```

```
MySQL 5.7 Command Line Client - Unicode
mysql> select customers.id, name, amount, date
->      from customers
->      inner join orders
->      on customers.id = orders.customer_id;
+----+-----+-----+-----+
| id | name   | amount | date                |
+----+-----+-----+-----+
| 3  | kabandana | 1500 | 2017-10-02 00:00:00 |
| 2  | muhirwa  | 1560 | 2017-01-20 00:00:00 |
| 3  | kabandana | 3000 | 2017-10-02 00:00:00 |
| 4  | mugisha  | 2060 | 2016-05-20 00:00:00 |
+----+-----+-----+-----+
4 rows in set (0.00 sec)
mysql> _
```

2. LEFT JOIN

The SQL LEFT JOIN returns all rows from the left table, even if there are no matches in the right table. This means that if the ON clause matches 0 (zero) records in right table, the join will still return a row in the result, but with NULL in each column from right table.

This means that a left join returns all the values from the left table, plus matched values from the right table or NULL in case of no matching join predicate.

Syntax:

The basic syntax of LEFT JOIN is as follows:

```
select table1.column1, table2.column2... from table1 left join table2 orders
on table1.common_field = table2.common_field;
```

```
mysql> select customers.id, name, amount, date
-> from customers
-> left join orders
-> on customers.id = orders.customer_id;
```

id	name	amount	date
3	kabandana	1500	2017-10-02 00:00:00
2	muhirwa	1560	2017-01-20 00:00:00
3	kabandana	3000	2017-10-02 00:00:00
4	mugisha	2060	2016-05-20 00:00:00
1	keza	NULL	NULL
5	nyampundu	NULL	NULL
6	uwera	NULL	NULL
7	mutoni	NULL	NULL

```
8 rows in set (0.00 sec)
mysql> _
```

3. RIGHT JOIN

The SQL RIGHT JOIN returns all rows from the right table, even if there are no matches in the left table. This means that if the ON clause matches 0 (zero) records in left table, the join will still return a row in the result, but with NULL in each column from left table.

This means that a right join returns all the values from the right table, plus matched values from the left table or NULL in case of no matching join predicate.

The basic syntax of RIGHT JOIN is as follows:

```
select table1.column1, table2.column2... from table1
right join table2 orders on table1.common_filed = table2.common_field;
```

```
mysql> select customers.id, name, amount, date
-> from customers
-> right join orders
-> on customers.id = orders.customer_id;
```

id	name	amount	date
3	kabandana	1500	2017-10-02 00:00:00
2	muhirwa	1560	2017-01-20 00:00:00
3	kabandana	3000	2017-10-02 00:00:00
4	mugisha	2060	2016-05-20 00:00:00

```
4 rows in set (0.00 sec)
mysql>
```

4. FULL JOIN

The SQL FULL JOIN combines the results of both left and right outer joins.

The joined table will contain all records from both tables, and fill in NULLs for missing matches on either side.

The basic syntax of FULL JOIN is as follows:

```
select table1.column1, table2.column2... from table1
full join table2 orders on table1.common_field = table2.common_field;
```

```
SQL> select id, name, amount, date from "Customers"
full join orders on "Customers".id = orders.customer_id;
```

If your DBMS does not support FULL JOIN like MySQL does not support FULL JOIN, then you can use UNION ALL clause to combine two JOINS as follows:

```
SQL> select id, name, amount, date from "Customers" left join orders on
"Customers".id = orders.customer_id
union all
select id, name, amount, date from "Customers" right join orders on
"Customers".id = orders.customer_id
```

5. SELF JOIN

The SQL SELF JOIN is used to join a table to itself as if the table were two tables, temporarily renaming at least one table in the SQL statement.

The basic syntax of SELF JOIN is as follows:

```
select a.column_name, b.column_name... from table1 a, table1 b where
a.common_field = b.common_field;
```

```
mysql> select a.id, b.name, a.salary
->      from customers a, customers b      where a.salary < b.salary;
```

id	name	salary
2	keza	1500
2	kabandana	1500
1	mugisha	2000
2	mugisha	1500
3	mugisha	2000
6	mugisha	4500
1	nyampundu	2000
2	nyampundu	1500
3	nyampundu	2000
4	nyampundu	6500
6	nyampundu	4500
1	uwera	2000
2	uwera	1500
3	uwera	2000
1	mutoni	2000
2	mutoni	1500
3	mutoni	2000
4	mutoni	6500
5	mutoni	8500
6	mutoni	4500

20 rows in set (0.00 sec)

6. CARTESIAN JOIN

The CARTESIAN JOIN or CROSS JOIN returns the Cartesian product of the sets of records from the two or more joined tables. Thus, it equates to an inner join where the join-condition always evaluates to True or where the join condition is absent from the statement.

The basic syntax of INNER JOIN is as follows:

```
select table1.column1, table2.column2... from table1, table2 [, table3 ]
```

```
MySQL5.7 Command Line Client - Unicode
mysql> select customers.id, name, amount, date
->      from customers, orders;
```

id	name	amount	date
1	keza	1500	2017-10-02 00:00:00
1	keza	1560	2017-01-20 00:00:00
1	keza	3000	2017-10-02 00:00:00
1	keza	2060	2016-05-20 00:00:00
2	muhirwa	1500	2017-10-02 00:00:00
2	muhirwa	1560	2017-01-20 00:00:00
2	muhirwa	3000	2017-10-02 00:00:00
2	muhirwa	2060	2016-05-20 00:00:00
3	kabandana	1500	2017-10-02 00:00:00
3	kabandana	1560	2017-01-20 00:00:00
3	kabandana	3000	2017-10-02 00:00:00
3	kabandana	2060	2016-05-20 00:00:00
4	mugisha	1500	2017-10-02 00:00:00
4	mugisha	1560	2017-01-20 00:00:00
4	mugisha	3000	2017-10-02 00:00:00
4	mugisha	2060	2016-05-20 00:00:00
5	nyampundu	1500	2017-10-02 00:00:00
5	nyampundu	1560	2017-01-20 00:00:00
5	nyampundu	3000	2017-10-02 00:00:00
5	nyampundu	2060	2016-05-20 00:00:00
6	uwera	1500	2017-10-02 00:00:00
6	uwera	1560	2017-01-20 00:00:00
6	uwera	3000	2017-10-02 00:00:00
6	uwera	2060	2016-05-20 00:00:00
7	mutoni	1500	2017-10-02 00:00:00
7	mutoni	1560	2017-01-20 00:00:00
7	mutoni	3000	2017-10-02 00:00:00
7	mutoni	2060	2016-05-20 00:00:00

28 rows in set (0.00 sec)

```
mysql>
```

F. SQL Unions Clause

The SQL **UNION** clause/operator is used to combine the results of two or more SELECT statements without returning any duplicate rows.

To use UNION, each SELECT must have the same number of columns selected, the same number of column expressions, the same data type, and have them in the same order, but they do not have to be the same length.

The basic syntax of **UNION** is as follows:

```
select column1 [, column2 ] from table1 [, table2 ] [where condition]
```

union

```
select column1 [, column2 ] from table1 [, table2 ] [where condition]
```

```
MySQL 5.7 Command Line Client - Unicode
mysql> select customers.id, name, amount, date
->   from customers
->   left join orders
->   on customers.id = orders.customer_id
-> union
->   select customers.id, name, amount, date
->   from customers
->   right join orders
->   on customers.id = orders.customer_id;
+----+-----+-----+-----+
| id | name   | amount | date                |
+----+-----+-----+-----+
| 3  | kabandana | 1500  | 2017-10-02 00:00:00 |
| 2  | muhirwa  | 1560  | 2017-01-20 00:00:00 |
| 3  | kabandana | 3000  | 2017-10-02 00:00:00 |
| 4  | mugisha  | 2060  | 2016-05-20 00:00:00 |
| 1  | keza     | NULL  | NULL                |
| 5  | nyampundu | NULL  | NULL                |
| 6  | uwera    | NULL  | NULL                |
| 7  | mutoni   | NULL  | NULL                |
+----+-----+-----+-----+
8 rows in set (0.11 sec)
mysql> _
```

1. The UNION ALL Clause:

The UNION ALL operator is used to combine the results of two SELECT statements including duplicate rows. The same rules that apply to UNION apply to the UNION ALL operator.

The basic syntax of UNION ALL is as follows:

```
select column1 [, column2 ] from table1 [, table2 ] [where condition]
union all
select column1 [, column2 ] from table1 [, table2 ] [where condition]
```

```
SQL> select id, name, amount, date from "Customers"
left join orders on "Customers".id = orders.customer_id union all select id, name,
amount, date from "Customers" right join orders on "Customers".id = orders.
customer_id;
```

There are two other clauses (i.e., operators), which are very similar to UNION clause: **SQLINTERSECT Clause:** is used to combine two SELECT statements, but returns rows only from the first SELECT statement that are identical to a row in the second SELECT statement. **SQL EXCEPT Clause:** combines two SELECT statements and returns rows from the first SELECT statement that are not returned by the second SELECT statement.

2. INTERSECT Clause

The SQL INTERSECT clause/operator is used to combine two SELECT statements, but returns rows only from the first SELECT statement that are identical to a row in the second SELECT statement. This means INTERSECT returns only common rows returned by the two SELECT statements.

Just as with the UNION operator, the same rules apply when using the INTERSECT operator. MySQL does not support INTERSECT operator

The basic syntax of INTERSECT is as follows:

```
select column1 [, column2 ] from table1 [, table2 ] [where condition]
intersect
select column1 [, column2 ] from table1 [, table2 ] [where condition]
```

Example:

```
SQL> select id, name, amount, date from "Customers" left join orders on "Customers".id
= orders.customer_id

intersect

select id, name, amount, date from "Customers" right join orders on "Customers".id =
orders.customer_id;
```

3. EXCEPT Clause

The SQL EXCEPT clause/operator is used to combine two SELECT statements and returns rows from the first SELECT statement that are not returned by the second SELECT statement. This means EXCEPT returns only rows, which are not available in second SELECT statement.

Just as with the UNION operator, the same rules apply when using the EXCEPT operator. MySQL does not support EXCEPT operator.

The basic syntax of EXCEPT is as follows:

```
SELECT column1 [, column2 ] from table1 [, table2] [where condition]

except

select column1 [, column2] from table1 [, table2] [where condition]
```

Example:

```
SQL> select id, name, amount, date from "Customers" left join orders on "Customers".id
= orders.customer_id

except

select id, name, amount, date from "Customers" right join orders on "Customers".id =
orders.customer_id;
```

Select statement with Alias

You can rename a table or a column temporarily by giving another name known as alias.

The use of table aliases means to rename a table in a particular SQL statement. The renaming is a temporary change and the actual table name does not change in the database. The column aliases are used to rename a table's columns for the purpose of a particular SQL query.

The basic syntax of table alias is as follows:

```
Select column1, column2.... from table_name as alias_name where [condition];
```

The basic syntax of column alias is as follows:

```
select column_name as alias_name from table_name where [condition];
```

Example:

```
SQL> select c.id, c.name, c.age, o.amount from "Customers" as c, orders as o  
where c.id = o.customer_id;
```

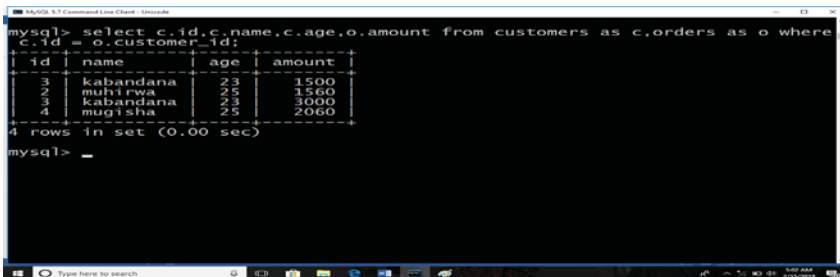

```
mysql> select c.id,c.name,c.age,o.amount from customers as c,orders as o where  
c.id = o.customer_id;
```

id	name	age	amount
3	kabandana	23	1500
2	muhi rwa	25	1560
3	kabandana	23	3000
4	mugisha	25	2060

```
4 rows in set (0.00 sec)  
mysql>
```

Following is the usage of column alias:

```
SQL> select id as customer_id, name as customer_name from "Customers"  
where salary is not null;
```

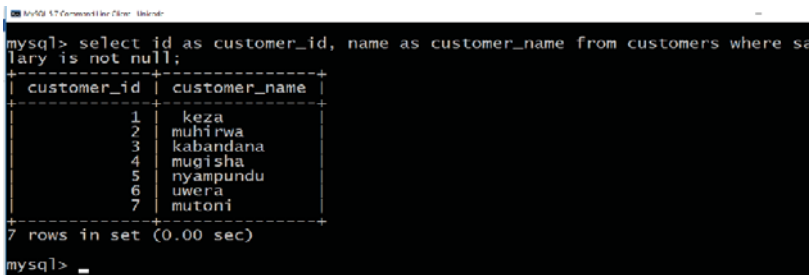

```
mysql> select id as customer_id, name as customer_name from customers where sa  
lary is not null;
```

customer_id	customer_name
1	keza
2	muhi rwa
3	kabandana
4	mugisha
5	nyampundu
6	uwera
7	mutoni

```
7 rows in set (0.00 sec)  
mysql>
```

G. SQL TRUNCATE TABLE

The SQL TRUNCATE TABLE command is used to delete complete data from an existing table.

You can also use DROP TABLE command to delete complete table but it would remove complete table structure from the database and you would need to re-create this table once again if you wish you store some data.

The basic syntax of TRUNCATE TABLE is as follows:

```
truncate table table_name;
```

Example:

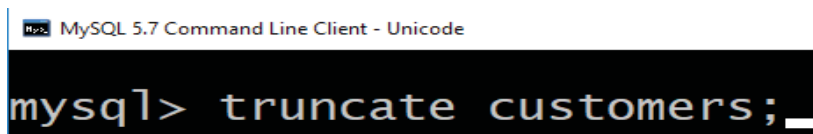

```
MySQL 5.7 Command Line Client - Unicode
mysql> truncate customers;
```

H. SQL HAVING CLAUSE

The HAVING clause enables you to specify conditions that filter which group results appear in the final results. The WHERE clause places conditions on the selected columns, whereas the HAVING clause places conditions on groups created by the GROUP BY clause.

The following is the position of the HAVING clause in a query:

```
select from where [group by] [having] [order by]
```

The HAVING clause must follow the GROUP BY clause in a query and must also precede the ORDER BY clause if used. The following is the syntax of the SELECT statement, including the HAVING clause:

```
select column1, column2 from table1, table2 where [conditions] group by
column1, column2 having [conditions] order by column1, column2
```

Example:

Following is the example, which would display record for which similar age count would be more than or equal to 2:

```
mysql> select *
-> from customers
-> group by age
-> having count(age)>= 2;
+----+-----+-----+-----+-----+
| id | name   | age  | address | salary |
+----+-----+-----+-----+-----+
| 2  | muhirwa | 25  | muhanga | 1500  |
+----+-----+-----+-----+-----+
1 row in set (0.00 sec)

mysql> _
```

I. SQL SUB QUERIES

A Subquery or Inner query or Nested query is a query within another SQL query and embedded within the WHERE clause.

A subquery is used to return data that will be used in the main query as a condition to further restrict the data to be retrieved.

Subqueries can be used with the SELECT, INSERT, UPDATE, and DELETE statements along with the operators like =, <, >, >=, <=, IN, BETWEEN etc.

There are a few rules that subquery must follow:

- * Subquery must be enclosed within parentheses.
- * A subquery can have only one column in the SELECT clause, unless multiple columns are in the main query for the subquery to compare its selected columns.
- * Subqueries that return more than one row can only be used with multiple value operators, such as the IN operator.
- * A subquery cannot be immediately enclosed in a set function.
- * The BETWEEN operator cannot be used with a subquery; however, the BETWEEN operator can be used within the subquery.

I.1. Subqueries with the SELECT Statement:

Subqueries are most frequently used with the SELECT statement. The basic syntax

is as follows:

```
select column_name [, column_name ] from table1 [, table2] where column_name operator (select column_name [, column_name ] from table1 [, table2] [where])
```

```
MySQL 5.7 Command Line Client - Unicode
mysql> SELECT *
-> FROM CUSTOMERS
-> WHERE ID IN (SELECT ID
-> FROM CUSTOMERS
-> WHERE SALARY > 4500);
+----+-----+-----+-----+-----+
| id | name      | age | address | salary |
+----+-----+-----+-----+-----+
| 4  | mugisha  | 25  | nyamagabe | 6500  |
| 5  | nyampundu | 27  | gasabo   | 8500  |
| 7  | mutoni   | 24  | rusizi   | 10000 |
+----+-----+-----+-----+-----+
3 rows in set (0.00 sec)
mysql> _
```

I.2. Subqueries with the INSERT Statement:

Subqueries also can be used with INSERT statements. The INSERT statement uses the data returned from the subquery to insert into another table. The selected data in the subquery can be modified with any of the character, date or number functions.

The basic syntax is as follows:

```
INSERT INTO table_name [ (column1 [, column2 ]) ] SELECT [ *|column1 [, column2 ] FROM table1 [, table2 ] [ WHERE VALUE OPERATOR ]
```

Example:

Consider a table "CUSTOMERS"_BKP with similar structure as "CUSTOMERS" table. Now to copy complete "CUSTOMERS" table into "CUSTOMERS"_BKP, following is the syntax:

```
MySQL 5.7 Command Line Client - Unicode
mysql> create table CUSTOMERS_BKP like customers;
Query OK, 0 rows affected (1.00 sec)

mysql> INSERT INTO CUSTOMERS_BKP
-> SELECT * FROM CUSTOMERS
-> WHERE ID IN (SELECT ID
-> FROM CUSTOMERS);
Query OK, 7 rows affected (0.11 sec)
Records: 7 Duplicates: 0 Warnings: 0
mysql>
```

I.3. Subqueries with the UPDATE Statement:

The subquery can be used in conjunction with the UPDATE statement. Either single or multiple columns in a table can be updated when using a subquery with the UPDATE statement.

The basic syntax is as follows:

```
update table set column_name = new_value [ where operator [ value ] (select
column_name from table_name) [ where) ]
```

Example:

Assuming, we have "CUSTOMERS"_BKP table available which is backup of "CUSTOMERS" table.

Following example updates SALARY by 0.25 times in "CUSTOMERS" table for all the "Customers" whose AGE is greater than or equal to 27:

```
mysql> UPDATE CUSTOMERS
-> SET SALARY = SALARY * 0.25
-> WHERE AGE IN (SELECT AGE FROM CUSTOMERS_BKP WHERE AGE >= 27 );
Query OK, 2 rows affected (0.19 sec)
Rows matched: 2 Changed: 2 Warnings: 0

mysql> select * from customers;
+----+-----+-----+-----+-----+
| id | name   | age | address | salary |
+----+-----+-----+-----+-----+
| 1  | keza   | 32  | kigali  | 500    |
| 2  | muhira | 25  | muhanga | 1500   |
| 3  | kabandana | 23 | huye    | 2000   |
| 4  | mugisha | 25  | nyamagabe | 6500   |
| 5  | nyampundu | 27 | gasabo  | 2125   |
| 6  | uwera  | 22  | nyagatare | 4500   |
| 7  | mutoni | 24  | rusizi  | 10000  |
+----+-----+-----+-----+-----+
7 rows in set (0.00 sec)
```

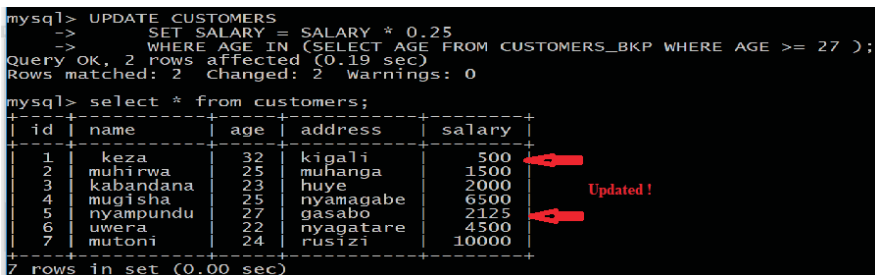

I.4. Subqueries with the DELETE Statement:

The subquery can be used in conjunction with the DELETE statement like with any other statements mentioned above.

The basic syntax is as follows:

```
delete from table_name [ where operator [ value ] (select column_name from
table_name)

[where)]
```

Example:

Assuming, we have "CUSTOMERS"_BKP table available which is backup of "CUSTOMERS" table.

Following example deletes records from "CUSTOMERS" table for all the "Customers" whose AGE is greater than or equal to 27:

```
mysql> DELETE FROM CUSTOMERS
-> WHERE AGE IN (SELECT AGE FROM CUSTOMERS_BKP WHERE
AGE > 27 );
Query OK, 1 row affected (0.16 sec)
mysql>
```

delete

The SQL **DELETE** Query is used to delete the existing records from a table.

You can use WHERE clause with DELETE query to delete selected rows, otherwise all the records would be deleted.

The basic syntax of DELETE query with WHERE clause is as follows:

```
delete from table_name where [condition];
```

Following is an example, which would DELETE a customer, whose ID is 6:

```
MySQL 5.7 Command Line Client - Unicode
mysql> DELETE FROM CUSTOMERS WHERE ID = 6;
Query OK, 1 row affected (0.14 sec)

mysql> select * from customers;
+----+-----+-----+-----+-----+
| id | name   | age | address | salary |
+----+-----+-----+-----+-----+
| 2  | muhirwa | 25 | muhanga | 1500   |
| 3  | kabandana | 23 | huye | 2000   |
| 4  | mugisha | 25 | nyamagabe | 6500   |
| 5  | nyampundu | 27 | gasabo | 2125   |
| 7  | mutoni | 24 | rusizi | 10000  |
+----+-----+-----+-----+-----+
5 rows in set (0.00 sec)
```

id number 6 is
deleted

If you want to DELETE all the records from "CUSTOMERS" table, you do not need to use WHERE clause and DELETE query would be as follows:

```
sql> delete from "Customers";
```

4.2.3 Data Control Language (DCL)

SQL GRANT and REVOKE commands

DCL commands are used to enforce database security in a multiple user database environment. Two types of DCL commands are GRANT and REVOKE. Only Database Administrator's or owners of the database object can provide/remove privileges on a database object.

a. SQL GRANT Command

SQL GRANT is a command used to provide access or privileges on the database objects to the users.

The Syntax for the GRANT command is:

```
GRANT privilege_name  
ON object_name  
TO {user_name |PUBLIC |role_name}  
[WITH GRANT OPTION];
```

- * privilege_name is the access right or privilege granted to the user. Some of the access rights are ALL, EXECUTE, and SELECT.
- * object_name is the name of an database object like TABLE, VIEW, STORED PROC and SEQUENCE.
- * user_name is the name of the user to whom an access right is being granted.
- * Public is used to grant access rights to all users.
- * Roles are a set of privileges grouped together.
- * With grant option - allows a user to grant access rights to other users.

For Example:

GRANT SELECT ON employee TO user1; This command grants a SELECT permission on employee table to user1. You should use the WITH GRANT option carefully because for example if you GRANT SELECT privilege on employee table to user1 using the WITH GRANT option, then user1 can GRANT SELECT privilege on employee table to another user, such as user2 etc. Later, if you REVOKE the SELECT privilege on

employee from user1, still user2 will have SELECT privilege on employee table.

b. SQL REVOKE Command:

The REVOKE command removes user access rights or privileges to the database objects.

The Syntax for the REVOKE command is:

```
REVOKE privilege_name  
ON object_name  
FROM {user_name |PUBLIC |role_name}
```

For Example:

REVOKE SELECT ON employee FROM user1; This command will REVOKE a SELECT privilege on employee table from user1. When you REVOKE SELECT privilege on a table from a user, the user will not be able to SELECT data from that table anymore. However, if the user has received SELECT privileges on that table from more than one users, he/she can SELECT from that table until everyone who granted the permission revokes it. You cannot REVOKE privileges if they were not initially granted by you.

c. Privileges and Roles:

Privileges: Privileges defines the access rights provided to a user on a database object. There are two types of privileges.

- 1. System privileges** - This allows the user to CREATE, ALTER, or DROP database objects.
- 2. Object privileges** - This allows the user to EXECUTE, SELECT, INSERT, UPDATE, or DELETE data from database objects to which the privileges apply.

Application activity 4.9:

You are given a flat database named "Library", with a relation Book (ISBN (Text, primary key), title (text), author (text), pages (integer), and price (integer)).

- Create student and teacher users
- Give student user "selection" abilities only
- Give all rights to user teacher
- Revoke selection rights to students

Application activity 4.10:

XYZ Ltd is a company that focusses on finding ICT and technology related solution to the citizens of Rwanda. It develops software and offers maintenance. It has many competitors in Rwanda and in East Africa, but XYZ Ltd tries to be a market winner in the region. One day, unknown person managed to have access and enter to the XYZ Ltd systems without company's authorization. That person managed to change the passwords that the company used in its everyday activities.

1. Discuss the challenges that the company should face
2. Can granting privileges help in preventing such cases? If yes, show how. If no, explain

4.3.Database security concept

As computers need to be physically and logically protected, the database inside needs also to be secured. There are some principles linked to databases so that they can remain meaningful. Those principles are integrity, Availability, Privacy and Confidentiality.

When dealing with a database belonging to an individual or an organization (company), Some actions are done to Backup and Concurrent control for the sake of security.

Activity 4.10:

1. What are the problems that a database can face in a computer?
2. How the security of database can be done?
3. Who is responsible of the security of a database?
4. What are the consequences that can happen when database security is violated?
5. Discuss security measure that can be taken to keep database secure.

Data integrity refers to the overall completeness, accuracy and consistency of data.

4.3.1. Integrity

There are four types of integrity:

- » **Entity (or table) integrity** requires that all rows in a table have a unique identifier, known as the primary key value. Whether the primary key value can be changed, or whether the whole row can be deleted, depends on the level of integrity required between the primary key and any other tables.
- » **Referential integrity** ensures that the relationship between the primary key (in a referenced table) and the foreign key (in each of the referencing tables) is always maintained. The maintenance of this relationship means that:
 - i. A row in a referenced table cannot be deleted, nor can the primary key be changed, if a foreign key refers to the row. For example, you cannot delete a customer that has placed one or more orders.
 - ii. A row cannot be added to a referencing table if the foreign key does not match the primary key of an existing row in the referenced table. For example, you cannot create an order for a customer that does not exist.
- » **Domain (or column) integrity** specifies the set of data values that are valid for a column and determines whether null values are allowed. Domain integrity is enforced by validity checking and by restricting the data type, format, or range of possible values allowed in a column.
- » **User-Defined integrity**: Enforces some specific business rules that do not fall into entity, domain, or referential integrity.

4.3.2. Availability

Availability is the condition where in a given resource can be accessed by its consumers. So in terms of databases, availability means that if a database is available, the users of its data; that is, applications, “Customers”, and business users; can access it. Any condition that renders the resource inaccessible causes the opposite of availability: unavailability.

Another perspective on defining availability is the percentage of time that a system can be used for productive work. The required availability of an application will vary from organization to organization, within an organization from system to system, and even from user to user.

Database availability and database performance are terms that are often confused with one another, and indeed, there are similarities between the two. The major difference lies in the user's ability to access the database. It is possible to access a database suffering from poor performance, but it is not possible to access a database that is unavailable. So, when does poor performance turn into unavailability?

If performance suffers to such a great degree that the users of the database cannot perform their job, the database has become, for all intents and purposes, unavailable. Nonetheless, keep in mind that availability and performance are different and must be treated by the database administrator as separate issues; even though a severe performance problem is a potential availability problem.

Availability comprises four distinct components, which, in combination, assure that systems are running and business can be conducted:

Manageability: the ability to create and maintain an effective environment that delivers service to users

Recoverability: the ability to reestablish service in the event of an error or **component failure**

Reliability: the ability to deliver service at specified levels for a stated period

Serviceability: the ability to determine the existence of problems, diagnose their cause(s), and repair the problems.

All four of these "abilities" impact the overall availability of a system, database, or application.

4.3.3. Data Privacy

Privacy of information is extremely important in this digital age where everything is interconnected and can be accessed and used easily. The possibilities of our private information being extremely vulnerable are very real, which is why we require data privacy. We can describe the concept as:

Data privacy, also known as information privacy, is the necessity to preserve and protect any personal information, collected by any organization, from being accessed

by a third party. It is a part of Information Technology that helps an individual or an organization determine what data within a system can be shared with others and which should be restricted.

What Type of data is included?

Any personal data that could be sensitive or can be used maliciously by someone is included when considering data privacy. These data types include the following:

- **Online Privacy:** This includes all personal data that is given out during online interactions. Most sites have a privacy policy regarding the use of the data shared by users or collected from users.
- **Financial Privacy:** Any financial information shared online or offline is sensitive as it can be utilized to commit fraud.
- **Medical Privacy:** Any details of medical treatment and history is privileged information and cannot be disclosed to a third party. There are very stringent laws regarding sharing of medical records.
- **Residential and geographic records:** sharing of address online can be a potential risk and needs protection from unauthorized access.
- **Political Privacy:** this has become a growing concern that political preferences should be privileged information.
- **Problems with providing Data Security**
- It is not an easy task to provide data security. Most organizations have problems in providing proper information privacy. These problems include:
 - Difficulty in understanding and defining what is sensitive data and what is not.
 - With data growing in volume by the day, most organizations struggle to create real-time masking facilities and security policies to efficiently protect all the data.
 - Difficulty to screen and review data from a central location with outmoded tools and bloated databases.

Importance of Data Security

- * Data security is extremely important for any individual or organization, as theft of data, can cause huge monetary losses. Data security can help an organization by:
 - Preventing theft of data;
 - Preserving data integrity;
 - Containing a cost of compliance to data security requirements;

- Protection of privacy.

Legal provisions for Data Security

The laws that govern data security vary across the world. Different countries and legal systems deal with it in their way. But most laws agree that personal data is shared and processed only for the purpose for which the information has been collected. In Rwanda we have RURA (Rwanda Utilities Regulatory Agency) that govern data security issues.

4.3.4. Confidentiality

Confidentiality refers to protecting information from being accessed by unauthorized parties. In other words, only the people who are authorized to do so can gain access to sensitive data. Imagine your bank records. You should be able to access them, of course, and employees at the bank who are helping you with a transaction should be able to access them, but no one else should.

A failure to maintain confidentiality means that someone who shouldn't have access has managed to get it, through intentional behavior or by accident. Such a failure of confidentiality, commonly known as a breach, typically cannot be remedied. Once the secret has been revealed, there's no way to un-reveal it.

If your bank records are posted on a public website, everyone can know your bank account number, balance, etc., and that information can't be erased from their minds, papers, computers, and other places. Nearly all the major security incidents reported in the media today involve major losses of confidentiality.

a. Backup

In information technology, a **backup**, or the process of backing **up**, refers to the copying and archiving of computer data so it may be used to restore the original after a data loss event.

A catastrophic failure is one where a stable, secondary storage device gets corrupt. With the storage device, all the valuable data that is stored inside is lost. We have two different strategies to recover data from such a catastrophic failure:

- * Remote backup – Here a backup copy of the database is stored at a remote

location from where it can be restored in case of a catastrophe.

- * Alternatively, database backups can be taken on magnetic tapes and stored at a safer place. This backup can later be transferred onto a freshly installed database to bring it to the point of backup. Grown-up databases are too bulky to be frequently backed up. In such cases, we have techniques where we can restore a database just by looking at its logs.

So, all that we need to do here is to take a backup of all the logs at frequent intervals of time. The database can be backed up once a week, and the logs being very small can be backed up every day or as frequently as possible.

b. Remote access

Individuals, small and big institutions/companies are using databases in their daily businesses. Most of the time institutions have agencies spread around the country, region or the world. Umwalimu SACCO is a saving and credit Cooperative that helps teachers to improve their lives by getting financial loans at low interests. This institution is having different agencies in different districts. The central agency is located at Kigali and host the main database of all members of Umwalimu SACCO in Rwanda. When a client goes to look for a service at an agency, the teller requests permissions from Kigali by identifying, authenticating him/her self so that the authorization can be granted to him/her. The whole network works in the mode of Client/Server. The fact of getting connection to the server from far is what we call "Remote Access". Hence, the database is accessed remotely. This act requires some security measures because otherwise anybody can disturb the system of working and hack the whole business system of Umwalimu SACCO.

This institution needs then to set rules and regulations to manage the remote access to its information.

c. Concurrent control

Process of managing simultaneous operations on the database without having them interfere with one another.

- Prevents interference when two or more users are accessing database simultaneously and at least one is updating data.
- Although two transactions may be correct in themselves, interleaving of operations may produce an incorrect result.

Three examples of potential problems caused by concurrency:

- Lost update problem.
- Uncommitted dependency problem.
- Inconsistent analysis problem.

Application activity 4.11:

1. Discuss the advantages of data backup.
2. Explain the advantages of remote access to big companies.
3. Discuss the reasons why a database administrator must understand well the concept of privacy as used in database.
4. Compare the concepts of integrity, availability and confidentiality. Discuss what should happen when they are violated (case by case).
5. A secondary school has a Management Information System hosted on their own server located inside their compound. All the important data related to students, teachers, salaries, marks, library, etc. are in that server.

One day, it happened that the Head Master finds that some students have the lists of their marks in all courses before deliberation. He investigated and found that the students did not get marks from any teachers or administrative/technical staff of the school.

- In groups, discuss what should happened in the server of the school
- Is data privacy assured in that server?
- What are the measures that the school has to put in place to protect their data.

4.3.5. Database threats

Activity 4.11

- i. From what you have seen in computer security, what are the possible threats of computers?
- ii. What do you do in case you realize that there are threats for your computer system?
- iii. Can database be attacked by hackers?

Threat is any situation or event, whether intentional or unintentional, that will adversely affect a system and consequently an organization.

Threats to databases result in the loss or degradation of some or all of the following security goals: integrity, availability, and confidentiality.

- **Loss of integrity:** Database integrity refers to the requirement that information be protected from improper modification. Modification of data includes creation, insertion, modification, changing the status of data, and deletion. Integrity is lost if unauthorized changes are made to the data by either intentional or accidental acts. If the loss of system or data integrity is not corrected, continued use of the contaminated system or corrupted data could result in inaccuracy, fraud, or erroneous decisions.
- **Loss of availability:** Database availability refers to making objects available to a human user or a program to which they have a legitimate right.
- **Loss of confidentiality:** Database confidentiality refers to the protection of data from unauthorized disclosure. The impact of unauthorized disclosure of confidential information can range from violation of the Data Privacy Act to the jeopardization of national security. Unauthorized, unanticipated, or unintentional disclosure could result in loss of public confidence, embarrassment, or legal action against the organization.

In other words we can say that database threats can appear in form of unauthorized users, physical damage, and Data corruption.

a. Database protection

The protection of a database can be done through access control and data encryption

Access control

- Based on the granting and revoking of privileges.
- A privilege allows a user to create or access (that is read, write, or modify) some database object (such as a relation, view, and index) or to run certain DBMS utilities.
- Privileges are granted to users to accomplish the tasks required for their jobs.

Data encryption

- The encoding of the data by a special algorithm that renders the data

unreadable by any program without the decryption key.

Application activity 4.12:

You are tasked to design a database of your school. Discuss the steps you will follow to come up with genuine product by keeping in mind the data security and the protection of the database against the potential threats.

4.3.6. Database planning and designing

Activity 4.12

1. Discuss the pillars of database design
2. Why is database planning necessary?
3. Discuss activities involved in database planning.

Before planning, designing and managing a database, first it is created. Its creation goes through defined steps known as Database System Development Lifecycle. Those steps are:

- Database planning
- System definition
- Requirements collection and analysis
- Database design
- DBMS selection (optional)
- Prototyping (optional)
- Implementation
- Data conversion and loading
- Testing
- Operational maintenance

A. Database Planning

- ◇ Management activities that allow stages of database system development lifecycle to be realized as efficiently and effectively as possible.
- ◇ Must be integrated with overall information system strategy of the organization.

◇ Database planning should also include development of standards that govern:

- How data will be collected,
- How the format should be specified,
- What necessary documentation will be needed,
- How design and implementation should proceed.

Database Planning – Mission Statement:

- Mission statement for the database project defines major aims of database application.
- Those driving database project normally define the mission statement.
- Mission statement helps clarify purpose of the database project and provides clearer path towards the efficient and effective creation of required database system.

Database Planning – Mission Objectives:

- Once mission statement is defined, mission objectives are defined.
- Each objective should identify a particular task that the database must support.
- May be accompanied by some additional information that specifies the work to be done, the resources with which to do it, and the money to pay for it all.

System Definition

- Database application may have one or more user views.
- Identifying user views helps ensure that no major users of the database are forgotten when developing requirements for new system.
- User views also help in development of complex database system allowing requirements to be broken down into manageable pieces.

Requirements Collection and Analysis

- Process of collecting and analysing information about the part of organization to be supported by the database system, and using this information to identify users' requirements of new system.
- Information is gathered for each major user view including:
 - * a description of data used or generated;
 - * details of how data is to be used/generated;
 - * any additional requirements for new database system.
- * Information is analyzed to identify requirements to be included in new

database system. Described in the requirements specification.

- Another important activity is deciding how to manage the requirements for a database system with multiple user views.

Three main approaches:

- centralized approach;
- view integration approach;
- combination of both approaches(hybrid).

Centralized approach

- Requirements for each user view are merged into a single set of requirements.
- A data model is created representing all user views during the database design stage.

View integration approach

- * Requirements for each user view remain as separate lists.
- * Data models representing each user view are created and then merged later during the database design stage.
- ◇ Data model representing single user view (or a subset of all user views) is called a local data model.
- ◇ Each model includes diagrams and documentation describing requirements for one or more but not all user views of database.
- ◇ Local data models are then merged at a later stage during database design to produce a global data model, which represents all user views for the database.

B. Database Design

In every institution, there is a process of creating a design for a database that will support the enterprise's mission statement and mission objectives for the required database system.

The main approaches include:

- ◇ Top-down or Entity-Relationship Modelling
- ◇ Bottom-up or Normalisation

Top-down approach

- * Starts with high-level entities and relationships with successive refinement to identify more detailed data model.
- * Suitable for complex databases.

Bottom-up approach

- * Starts with a finite set of attributes and follows a set of rules to group attributes into relations that represent entities and relationships.
- * Suitable for small number of attributes.

The main purposes of data modeling include:

- * to assist in understanding the meaning (semantics) of the data;
- * to facilitate communication about the information requirements.
- * Building data model requires answering questions about entities, relationships, and attributes.

There are three phases of database design: Conceptual database design, Logical database design and Physical database design.

Conceptual Database Design:

- * Process of constructing a model of the data used in an enterprise, independent of all physical considerations.
- * Data model is built using the information in users' requirements specification.
- * Conceptual data model is source of information for logical design phase.

Logical Database Design:

- * Process of constructing a model of the data used in an enterprise based on a specific data model (e.g. relational), but independent of a particular DBMS and other physical considerations.
- * Conceptual data model is refined and mapped on to a physical data model.

Physical Database Design:

- * Process of producing a description of the database implementation on secondary storage.
- * Describes base relations, file organizations, and indexes used to achieve efficient access to data. Also describes any associated integrity constraints and security measures.
- * Tailored to a specific DBMS.

DBMS Selection:

The selection of an appropriate DBMS to support the database system follows these steps: define Terms of Reference of study; shortlist two or three products; evaluate products and Recommend selection and produce report.

END UNIT ASSESSMENT

Part I: Relational algebra and SQL statements

1. 1. A company organizes its activities in projects. Products that are used in the projects are bought from suppliers. This is described in a database with the following schema: Projects(projNbr, name, city) Products(prodNbr, name, color) Suppliers(supplNbr, name, city) Deliveries(supplNbr, prodNbr, projNbr, number). Write relational algebra expressions that give the following information:
 - a. All information about all projects.
 - b. All information about all projects in Kigali.
 - c. The supplier numbers of the suppliers that deliver to project number 123.
 - d. The product numbers of products that are delivered by suppliers in Kigali.
 - e. All pairs of product numbers such that at least one supplier delivers both products.

4. The following relations keep track of airline flight information:

Flights(flno: integer, from: string, to: string, distance: integer, departs: time, arrives: time, price: real) Aircraft(aid: integer, aname: string, cruisingrange: integer) Certified(eid: integer, aid: integer) Employees(eid: integer, ename: string, salary: integer)

Note that the Employees relation describes pilots and other kinds of employees as well; every pilot is certified for some aircraft, and only pilots are certified to fly. Write each of the following queries in SQL.

- i. Find the names of aircraft such that all pilots certified to operate them have salaries more than \$80,000.
- ii. For each pilot who is certified for more than three aircraft, find the eid and the maximum cruising range of the aircraft for which she or he is certified.
- iii. Find the names of pilots whose salary is less than the price of the cheapest route from Kigali to New York.
- iv. For all aircraft with cruising range over 1000 miles, find the name of the aircraft and the average salary of all pilots certified for this aircraft.
- v. Find the names of pilots certified for some Boeing aircraft.
- vi. Find the aids of all aircraft that can be used on routes from Kigali to London.
- vii. Identify the routes that can be piloted by every pilot who makes more than

\$100,000.

- viii. Print the names of pilots who can operate planes with cruising range greater than 3000 Km but are not certified on any Boeing aircraft.
- ix. A customer wants to travel from Kigali to New York with no more than two changes of flight. List the choice of departure times from Kigali if the customer wants to arrive in New York by 6 p.m.
- x. Compute the difference between the average salary of a pilot and the average salary of all employees (including pilots).
- xi. Print the name and salary of every non pilot whose salary is more than the average salary for pilots.
- xii. Print the names of employees who are certified only on aircrafts with cruising range longer than 1000 Km.
- xiii. Print the names of employees who are certified only on aircrafts with cruising range longer than 1000 Km, but on at least two such aircrafts.
- xiv. Print the names of employees who are certified only on aircrafts with cruising range longer than 1000 Km and who are certified on some Boeing aircraft.

Part II: Database projects

1. Consider the following relations:

Student (*snum: integer, sname: string, major: string, level: string, age: integer*)

Class (*name: string, meets at: string, room: string, fid: integer*)

Enrolled (*snum: integer, cname: string*)

Faculty (*fid: integer, fname: string, deptid: integer*)

The meaning of these relations is straightforward; for example, Enrolled has one record per student-class pair such that the student is enrolled in the class. Level is a two character code with 4 different values (example: Junior: A Level etc)

Write the following queries in SQL. No duplicates should be printed in any of the answers.

- i. Find the names of all Juniors (level = A Level) who are enrolled in a class taught by Prof. Kwizera
- ii. Find the names of all classes that either meet in room R128 or have five or more Students enrolled.
- iii. Find the names of all students who are enrolled in two classes that meet at the same time.

- iv. Find the names of faculty members who teach in every room in which some class is taught.
- v. Find the names of faculty members for whom the combined enrollment of the courses that they teach is less than five.

2. The following relations keep track of airline flight information:

Flights (no: integer, from: string, to: string, distance: integer, Departs: time, arrives: time, price: real) Aircraft (aid: integer, aname: string, cruisingrange: integer)

Certified (eid: integer, aid: integer)

Employees (eid: integer, ename: string, salary: integer)

Note that the Employees relation describes pilots and other kinds of employees as well; every pilot is certified for some aircraft, and only pilots are certified to fly.

Write each of the following queries in SQL:

- i. Find the names of aircraft such that all pilots certified to operate them have salaries more than Rwf.80, 000.
- ii. For each pilot who is certified for more than three aircrafts, find the eid and the maximum cruisingrange of the aircraft for which she or he is certified.
- iii. Find the names of pilots whose salary is less than the price of the cheapest route from Kigali to Nairobi.
- iv. For all aircraft with cruisingrange over 1000 Kms,. Find the name of the aircraft and the average salary of all pilots certified for this aircraft.
- v. Find the names of pilots certified for some Boeing aircraft.
- vi. Find the aids of all aircraft that can be used on routes from Rusizi to Kigali.

3. Consider the following database of student enrollment in courses & books adopted for each course.

STUDENT (regno: string, name: string, major: string, bdate:date)

COURSE (course #:int, cname:string, dept:string)

ENROLL (regno:string, course#:int, sem:int, marks:int)

BOOK _ ADOPTION (course# :int, sem:int, book-ISBN:int)

TEXT (book-ISBN:int, book-title:string, publisher:string, author:string)

- i. Create the above tables by properly specifying the primary keys and the foreign keys.
- ii. Enter at least five records for each relation.
- iii. Demonstrate how you add a new text book to the database and make this book be adopted by some department.
- iv. Produce a list of text books (include Course #, Book-ISBN, Book-title) in the alphabetical order for courses offered by the 'CS' department that use more than two books.
- v. List any department that has all its adopted books published by a specific publisher.
- vi. Generate suitable reports.
- vii. Create suitable front end for querying and displaying the results.

4. The following tables are maintained by a book dealer.

AUTHOR (author-id:int, name:string, city:string, country:string)

PUBLISHER (publisher-id:int, name:string, city:string, country:string)

CATALOG (book-id:int, title:string, author-id:int, publisher-id:int, category-id:int, year:int, price:int)

CATEGORY (category-id:int, description:string)

ORDER-DETAILS (order-no:int, book-id:int, quantity:int)

- i. Create the above tables by properly specifying the primary keys and the foreign keys.
- ii. Enter at least five records for each relation.
- iii. Give the details of the authors who have 2 or more books in the catalog and the price of the books is greater than the average price of the books in the catalog and the year of publication is after 2000.
- iv. Find the author of the book which has maximum sales.
- v. Demonstrate how you increase the price of books published by a specific publisher by 10%.
- vi. Generate suitable reports.
- vii. Create suitable front end for querying and displaying the results.

5. Consider the following database for a banking enterprise

BRANCH(branch-name:string, branch-city:string, assets:real)

ACCOUNT(accno:int, branch-name:string, balance:real)

DEPOSITOR(customer-name:string, accno:int)

CUSTOMER(customer-name:string, customer-street:string, customer-city:string)

LOAN(loan-number:int, branch-name:string, amount:real)

BORROWER(customer-name:string, loan-number:int)

- i. Create the above tables by properly specifying the primary keys and the foreign keys
- ii. Enter at least five records for each relation
- iii. Find all the “Customers” who have at least two accounts at the Main branch.
- iv. Find all the “Customers” who have an account at all the branches located in a specific city.
- v. Demonstrate how you delete all account records at every branch located in a specific city.
- vi. Generate suitable reports.
- vii. Create suitable front end for querying and displaying the results.

6. XYZ high school’s database has the following information:

- i. Professors have an SSN, a name, an age, a rank, and a research specialty. Projects have a project number, a sponsor name (e.g., USAID), a starting date, an ending date, and a budget.
- ii. Graduate students have an SSN, a name, an age, and a degree program (e.g., Bachelor’s or Masters..).
- iii. Each project is managed by one professor (known as the project’s principal investigator).
- iv. Each project is worked on by one or more professors (known as the project’s co-investigators).
- v. Professors can manage and/or work on multiple projects.
- vi. Each project is worked on by one or more graduate students (known as the project’s research assistants).
- vii. When graduate students work on a project, a professor must supervise their work on the project.
- viii. Graduate students can work on multiple projects, in which case they

will have a (potentially different) supervisor for each one.

- ix. Departments have a department number, a department name, and a main office.
- x. Departments have a professor (known as the chairman) who runs the department.
- xi. Professors work in one or more departments, and for each department that they work in, a time percentage is associated with their job.

Graduate students have one major department in which they are working on their degree. Each graduate student has another, more senior graduate student (known as a student advisor) who advises him or her on what courses to take.

- i. Design and draw an ERD that captures the information about the XYZ High school. Use only the basic ER model here; that is, entities, relationships, and attributes. Be sure to indicate any key and participation constraints.
- ii. Use SQL statement to computerize the above ERD.
- iii. Use your favorite programming language and design front end to interact with your back end (database).

Part III: Database security

1. Explain the following terms as to database security:
 - i. Threat
 - ii. Availability
 - iii. Confidentiality
 - iv. Privacy
 - v. Integrity
2. Discuss the role of backup in database field.
3. In your school, find and explain the possible security issues that can harm your database.
4. Database security is a big concern. Discuss the measures you can adopt to keep your database secure.



UNIT 5

ARRAYS, FUNCTIONS AND PROCEDURES IN VISUAL BASIC

UNIT 5: ARRAYS, FUNCTIONS AND PROCEDURES IN VISUAL BASIC

Key Unit Competency: Use array, functions and procedures in Visual Basic program.

Learning objectives:

- Identify the importance of using array in the program
- Identify the role of using each category of the function in the program
- Give the syntax and step to write a function
- Differentiate Inbuilt function from user-defined function and their usage
- Design and write a Visual Basic program using an array
- Design and write a Visual Basic Program using a user defined and in-built functions

Introductory activity

In one family, a mother has a culture of storing daily expenses for each day of the year; every day she records daily expenses which means 365 times per year.

Answer the following questions:

1. What do you think about 365 times of records per year in terms of programming data storage?
2. What could be the best way of doing it much better?
3. Design a VB interface which can allow her to input date/day, Expense designation, Amount, Submit, Update, Delete and Search buttons.
4. Write a VB program using a functions and procedures which receives marks 35 students in S5 Computer Science and Mathematics where by marks in 10 subjects will be entered, the program should calculate and display the average and percentage got by each student and then generates all students whom their performance is above class average.

5.1. ARRAYS

5.1.1 Understanding arrays in Visual Basic

Learning activity 5.1.

Observe and analyze the two tables below and then answer on the following questions:

Table A

Student Names	John	Didier	Fiona	Williams
---------------	------	--------	-------	----------

Table B

Student Names			
James	Liliane	Jonson	Aline
Claude	Ilis	Aimable	Diane
Louise	Marie	Jemima	Baptiste

- Q1. Give the difference between the way data are stored in Table A and Table B
- Q2. Declare variables and keep the data for both Tables
- Q3. Discuss what would happen if you have to records 500 Students Names? Is it a challenge? If yes discuss what could be the best solution?

An array is a list of variables with the same data type and name. When we work with a single item, we only need to use one variable. However, if we have a list of items which are of similar type to deal with, we need to declare an array of variables instead of using a variable for each item.

By using an array, you can refer a list of values by the same name, and use a number that's called an index or subscript to identify an individual element based on its position in the array. The indexes of an array range from zero to a number one less than the total number of elements in the array. When you use Visual Basic syntax to define the size of an array, you specify its highest index, not the total number of elements in the array.

a. Dimension of an Array

An array can be one dimensional or multidimensional.

One dimensional array is like a list of items or a table that consists of one row of items or one column of items.

Array name	Name(1)	Name(2)	Name(3)	Name(4)
------------	---------	---------	---------	---------

Table 1. One dimensional Array

Example: If we need to record one hundred names, it is difficult to declare 100 different names; this is a waste of time and efforts. So, instead of declaring one hundred different variables, we need to declare only one array. We differentiate each item in the array by using subscript, the index value of each item, for example name(1), name(2), name(3)etc. , makes declaring variables more streamline.

A two dimensional array is a table of items that made of rows and columns. The format for a one dimensional array is ArrayName(x), the format for a two dimensional array is ArrayName(x,y) and a three dimensional array is ArrayName(x,y,z) .

Name(1,1)	Name(1,2)	Name(1,3)	Name(1,4)
Name(2,1)	Name(2,2)	Name(2,3)	Name(2,4)
Name(3,1)	Name(3,2)	Name(3,3)	Name(3,4)

Table 2. Two dimensional Array

Example: A two dimensional array can be considered as a table, which will have x number of rows and y number of columns.

Normally it is sufficient to use one dimensional and two dimensional arrays, you only need to use higher dimensional arrays if you need to deal with more complex problems.

b. Declaring Arrays

We can use **Public** or **Dim** statement to declare an array just as the way we declare a single variable. The Public statement declares an array that can be used throughout an application while the Dim statement declares an array that could be used only in a local procedure.

b.1. The general format to declare a one dimensional array

Dim arrayName(subs) as dataType where subs indicates the last subscript in the array.

Example

Dim StudName(5) as String

The above statement will declare an array that consists of 5 elements starting from StudName (1) to StudName (5).

StudName (1)	StudName (2)	StudName (3)	StudName (4)	StudName (5)
--------------	--------------	--------------	--------------	--------------

Table 3: Array with 5 elements

Example

Dim Count(100 to 500) as Integer

The above statement declares an array that consists of the first element starting from Count(100) and ends at Count(500).

b.2 The general format to declare a two dimensional array

Dim ArrayName(Sub1,Sub2) as dataType

Public ArrayName(Sub1,Sub2) as dataType

Example 5:

Dim StudentName(10,10) as string

The above statement will declare a 10x10 table made up of 100 students' names, starting with StudentName(1,1) and ending with StudentName(10,10).

Application activity 5.1

1. Differentiate a one dimensional array from a two dimensional array
2. Declare both one dimensional and two dimensional arrays which can keep 100

5.1.2. Arrays initialization and accessing elements of an array

Learning activity 5.2.

1. Write a VB program that initializes your First name, Last name, age, combination and level of studies
2. Having an array Num already initialized with 10 numbers calculate the sum of the first and last element.
3. Discuss the way you think elements of an array can be accessed?

When creating an array, each item of the series is referred to as a member of the array. Once the array variable has been declared, each one of its members is initialized with a 0 value. Most, if not all of the time, you will need to change the value of each member to a value of your choice. This is referred to as **initializing the array**. To initialize an array, you can access each one of its members and assign it a desired but appropriate value.

In mathematics, if you create a series of values as X1, X2, X3, X4, and X5, each member of this series can be identified by its subscript number. In this case the subscripts are 1, 2, 3, 4, and 5. This subscript number is also called an index. In the case of an array also, each member can be referred to by an incremental number called an index. A VB array is zero-based which means that the first member of the series has an index of 0, the second has an index of 1. In math, the series would be represented as X0, X1, X2, X3, and X4. In VB, the index of a member of an array is written in its own parentheses. This is the notation you would use to locate each member. One of the actions you can take would consist of assigning it a value or array initialization. Below are some examples:

a. General syntax of array initialization

a.1. One dimensional array initialization

Syntax:

```
[ArrayName(Index no)] [=] [Value]
```

Example

```
StudName(2)="Karera"
```

The above statement initializes **Karera** as a value on index 2 into an array called StudName

```
Private Sub Command1_Click()
```

```
Dim Marks(4) As Double
```

```
Marks(0) = 55
```

```
Marks(1) = 82.50
```

```
Marks(2) = 69.23
```

```
Marks(3) = 74
```

```
Marks(4) = 91.37
```

```
End Sub
```

Example 2:

```
Public StdNames(4) As String
```

```
StdNames(0) = "RUTAGUNGIRA Fils"
```

```
StdNames(1) = "KABERUKA Francis"
```

```
StdNames(2) = "SEMUTWARE Thacien"
```

```
StdNames(3) = "NIYONZIMA Igor"
```

```
StdNames(4) = "HAKIZIMANA Gerard"
```

```
End Sub
```

a.2. Two dimensional array initialization

Syntax:

```
[ArrayName][(RowIndex no, ColumnIndex no)] [=] [Value]
```

Example

```
StdNames(1,5)="SAMVURA"
```

The above statement initializes **SAMVURA** as a value on an index of row 1, column 5 into an array called StudName

b. Accessing elements of an array

Once an array has been initialized, that is, once it holds the necessary values, you can access and use these values. The main technique used to use an array consists of accessing each member or the necessary member based on its index. Remember that an array is zero-based.

You can access the first member using an index of 0. The second member has an index of 1, and so on. Here are some examples: print function or list box can be used to access elements of an array.

Note: The two ways for accessing elements of an array are not excessive.

Syntax:

1. [Print][variableName] or
2. [ListName.AddItem] [VariableName]

You can give an example like this: Suppose an array declared as Dim Marks(4) As Double

55	82.50	69.23	74	91.37
----	-------	-------	----	-------

To access the fourth element of this array we write: Marks(3) = 74

a. With one dimensional array

Program example 1

```
Private Sub Command1_Click()
```

```
Dim Marks(4) As Double
```

```
'Initialization of an array
```

```
Marks(0) = 55
```

```
Marks(1) = 82.50
```

```
Marks(2) = 69.23
```

```
Marks(3) = 74
```

```
Marks(4) = 91.37
```

```
'Accessing element of an array
```

```
List1.AddItem Marks(0)
```

```
List1.AddItem Marks(1)
```

```
List1.AddItem Marks(2)
```

```
List1.AddItem Marks(3)
```

```
List1.AddItem Marks(4)
```

```
End Sub
```

Program example 2

```

Private Sub Command1_Click()
Public StdNames(0 to 4) As String
'Initialization of an array
StdNames(0) = "RUTAGUNGIRA Fils"
StdNames(1) = "KABERUKA Francis"
StdNames(2) = "SEMUTWARE Thacien"
StdNames(3) = "NIYONZIMA Igor"
StdNames(4) = "HAKIZIMANA Gerard"
'Accessing element of an array
Print StdNames(0)
Print StdNames(1)
Print StdNames(2)
Print StdNames(3)
Print StdNames(4)
End Sub

```

b. With two dimensional array

Program example 1

```

Private Sub Command1_Click()
Dim Marks(2,2) As Double ' declaring an array of 9 elements
'Initialization of an array
Marks(0,0) = 55
Marks(0,1) = 82.50
Marks(0,2) = 69.23
Marks(0,3) = 74
Marks(0,4) = 91.37
'Accessing element of an array
List1.AddItem Marks(0,0)
List1.AddItem Marks(0,1)
List1.AddItem Marks(0,2)
List1.AddItem Marks(0,3)
List1.AddItem Marks(0,4)
End Sub

```

Program example 2

```
Private Sub Command1_Click()  
Dim StdNames(2, 2) As String ' declaring an array of 9 elements  
  
'Initialization of an array  
StdNames(0, 0) = "RUTAGUNGIRA Fils"  
StdNames(0, 1) = "KABERUKA Francis"  
StdNames(0, 2) = "SEMUTWARE Thacien"  
StdNames(1, 0) = "NIYONZIMA Igor"  
StdNames(1, 1) = "HAKIZIMANA Gerard"  
StdNames(1, 2) = "KALASIRA James"  
StdNames(2, 0) = "SEZIBERA Charles"  
StdNames(2, 1) = "BUTERA Frank"  
StdNames(2, 2) = "SIBOYINTORE Patrick"  
  
'Accessing element of an array  
Print StdNames(0, 0)  
Print StdNames(0, 1)  
Print StdNames(0, 2)  
Print StdNames(1, 0)  
Print StdNames(1, 1)  
Print StdNames(1, 2)  
Print StdNames(2, 0)  
Print StdNames(2, 1)  
Print StdNames(2, 2)  
End Sub
```

Application activities 5.2.

3. Differentiate a variable from an array
4. Having below, already an initialized array called X:

80	5333	56	456	6888	2232	5555	212
0	1	2	3	4	5	6	7

- a. Write a VB Program to perform an average of elements on index 2,5 and 7

5.1.3. Entering and displaying arrays elements

Learning activity 5.3.

1. Discuss different types of controls and functions that can be used to input and to display elements of an array

The program accepts data entry through an input box and displays the entries in the form itself. As you can see, this program will only allow a user to enter student's marks each time a user clicks on the start button.

a. Entering arrays elements

Examples

1. Entering without using a loop

```
Private Sub Command1_Click()  
Dim studentMarks As Double  
studentMarks = InputBox("Input the student Marks", "Input Marks")  
End Sub
```

2. Displaying without using a loop

```
List1.Item studentMarks
```

3. Entering using a loop

```
Private Sub Command1_Click()  
Public studentMarks(10) As Double  
Public i As Integer  
For i = 1 To 10  
studentMarks(i) = InputBox("Input the student Marks", "Input Marks")
```

Next i

End Sub

4. Displaying using a loop

For i = 1 To 10

List1.Item studentMarks(i)

Next i

After clicking on Run tool, the Input box called “**Input Marks**” allowing a user to Input the students Marks will appear 10 times as shown on **Figure 1**.

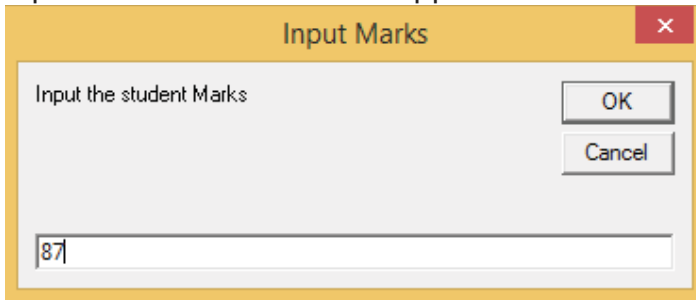

Figure 1: Marks Input box

b. Displaying arrays elements

An array **student Marks** has been already initialized, the next step will be to display its elements using a loop.

Related codes:

For i = 1 To 10

Form1.Print studentMarks(i)

Next i

Expected output

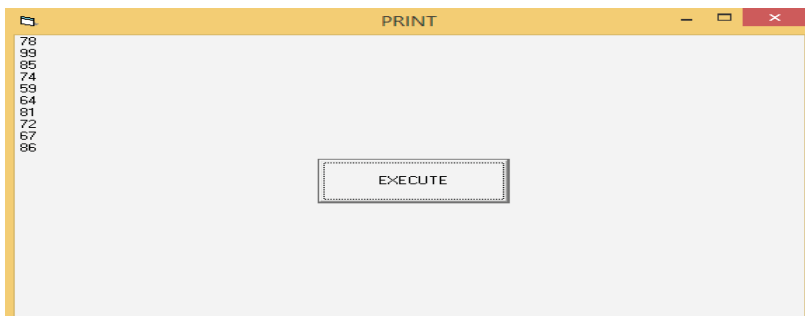

Figure 2: displaying elements of an array on the form

Program 2:

The program accepts data entries through an **InputBox** and displays the items in a list box.

```
Private Sub Command1_Click()  
Dim studentMarks(10) As Double  
Dim i As Integer  
For i = 1 To 10  
studentMarks(i) = InputBox("Enter the Marks of the Student")  
List1.AddItem studentMarks(i)  
Next i  
End Sub
```

The expected output

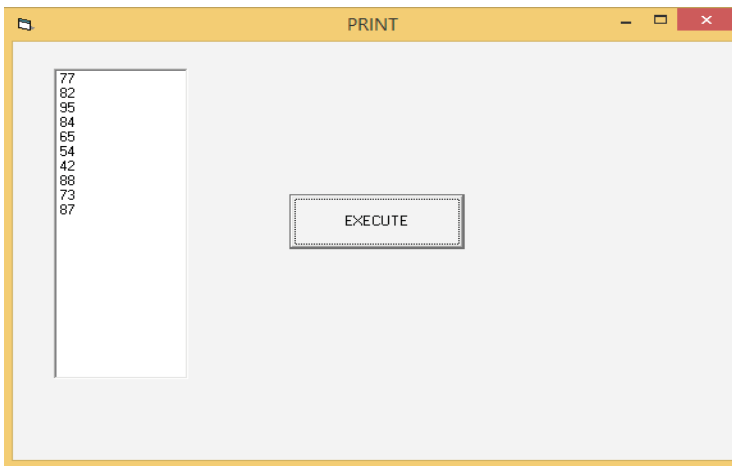

Figure 3: displaying elements of an array using a list box

Application activities 5.3.

1. Write a VB program which allow a user to Input 10 elements of an array and then displays even and odd numbers separately.

5.2. FUNCTIONS IN VB

Functions are “self-contained” modules of code that accomplish a specific task. Functions usually “take in” data, process it, and “return” a result. Once a function is written, it can be used over and over and over again. Functions can be “called” from the inside of other functions.

You can define a function in a module, class, or structure. It is public by default, which means you can call it from anywhere in your application that has access to the module, class, or structure in which you defined it.

A function can take arguments, such as constants, variables, or expressions, which are passed to it by the calling code.

There are two basic types of functions. Built-in functions and user defined ones. The built-in functions are part of the Visual Basic language. There are various mathematical, string or conversion functions.

5.2. 1 Built-in Functions

Learning activity 5.4.

1. Discuss the importance of using functions use in programming context

The built-in functions are functions which are automatically declared by the compiler, and associated with a built-in function identifier.

a. **MsgBox () Function**

The objective of MsgBox is to produce a pop-up message box that prompt the user to click on a command button before he /she can continues. This format is as follows:

yourMsg = MsgBox(Prompt, Style Value, Title)

The first argument, Prompt, will display the message in the message box. The Style Value will determine what type of command buttons appear on the message box, please refer **Table1** for types of command button displayed. The Title argument will

display the title of the message board.

Style Value	Named Constant	Buttons Displayed
0	vbOkOnly	Ok button
1	vbOkCancel	Ok and Cancel buttons
2	vbAbortRetryIgnore	Abort, Retry and Ignore buttons.
3	vbYesNoCancel	Yes, No and Cancel buttons
4	vbYesNo	Yes and No buttons
5	vbRetryCancel	Retry and Cancel buttons

We can use named constant in place of integers for the second argument to make the programs more readable. In fact, VB6 will automatically shows up a list of names constant where you can select one of them.

Example 1: `yourMsg=MsgBox("Click OK to Proceed", 1, "Startup Menu")` and `yourMsg=Msg("Click OK to Proceed". vbOkCancel,"Startup Menu")` are the same. Your `Msg` is a variable that holds values that are returned by the `MsgBox ()` function. The values are determined by the type of buttons being clicked by the users. It has to be declared as Integer data type in the procedure or in the general declaration section. **Table 2** shows the values, the corresponding named constant and buttons.

Table 2: Return Values and Command Buttons

Button clicked	Name constant	Value
Ok button	vbOk	1
Cancel button	vbCancel>	2
Abort button	vbAbort	3
Retry button	vbRetry	4
Ignore button	vbIgnore	5
Yes button	vbYes	6
No button	vbNo	7

Example 2:

The codes for the test button see **Figure 4**

```
Private Sub Test_Click()
Dim testmsg As Integer
```



```

testmsg = MsgBox("Click to test", 1, "Test message")
If testmsg = 1 Then
Display.Caption = "Testing Successful"
Else
Display.Caption = "Testing fail"
End If
End Sub

```

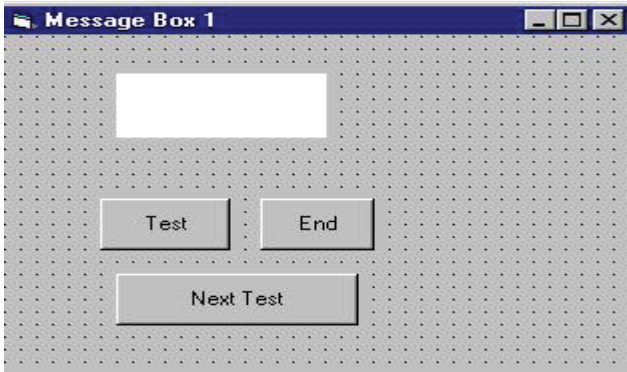

Figure 4: Msg box interface 1

When the user clicks on the test button, the image like the one shown in Figure 4 will appear. As the user clicks on the OK button, the message "Testing successful" will be displayed and when he/she clicks on the Cancel button, the message "Testing fail" will be displayed.

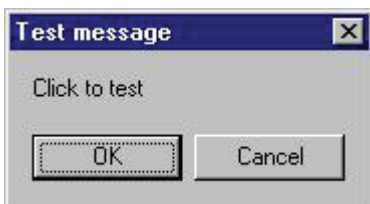





Figure 5: Msg box interface 2

a.3. Icon besides the message

To make the message box looks more sophisticated, you can add an icon besides the message. There are four types of icons available in VB as shown in Table 5.

Table 5: Message with corresponding icon

Value	Named Constant	Icon
16	VbCritical	
32	VbQuestion	
48	VbExclamation	
64	VbInformation	

Example 3

You draw the same Interface as in **example 2** but modify the codes as follows:

```
Private Sub test2_Click()  
Dim testMsg2 As Integer  
  
testMsg2 = MsgBox("Click to Test", vbYesNoCancel + vbExclamation, "Test Message")  
If testMsg2 = 6 Then  
display2.Caption = "Testing successful"  
Elseif testMsg2 = 7 Then  
display2.Caption = "Are you sure?"  
Else  
display2.Caption = "Testing fail"  
End If  
End Sub
```

In this example, the following message box will be displayed:

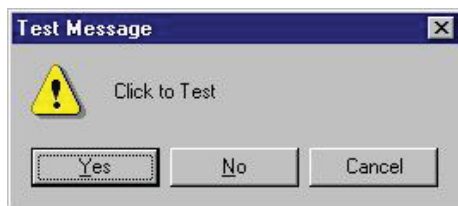

Figure 6: Msg box interface 3

b. The InputBox() Function

An InputBox() function displays a message box where the user can enter a value or a message in the form of text. The format is **myMessage=InputBox(Prompt, Title, default_text, x-position, y-position)**

myMessage is a variant data type but typically it is declared as string, which accept the message input by the users. The arguments are explained as follows:

- **Prompt:** The message displayed normally as a question asked.
- **Title:** The title of the Input Box.
- **Default-text:** The default text that appears in the input field where users can use it as his intended input or he may change to the message he wish to key in.
- **X-position and y-position:** the position or the coordinate of the input box.
Below is an example of an input box

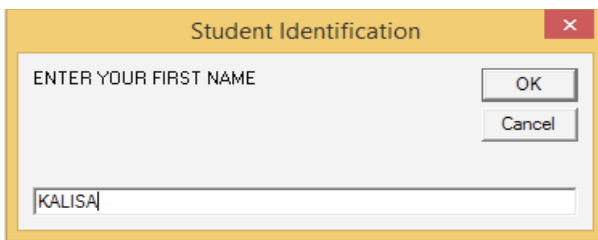

Figure 7: Input box interface



Figure 8: Input box interface 1

The procedure for the OK button

```
Private Sub OK_Click()  
Dim userMsg As String  
userMsg = InputBox("What is your message?", "Message Entry Form", "Enter your message here",  
450, 650)  
If userMsg <> "" Then  
message.Caption = userMsg  
Else  
message.Caption = "No Message"  
End If  
End Sub
```

When a user click the OK button, the input box as shown in Figure 7 will appear. After user entering the message and click OK, the message will be displayed on the caption, if he/she clicks Cancel, "No message" will be displayed.



Figure 9: Input box interface 2

c. String function

In this lesson, we will learn how to use some of the string manipulation function such as Len, Right, Left, Mid, Trim, Ltrim, Rtrim, Ucase, Lcase, Instr, Val, Str ,Chr and Asc.

c. 1 The Len Function

The length function returns an integer value which is the length of a phrase or a sentence, including the empty spaces.

The format is

Len (“Phrase”)

For example,

Len (VisualBasic) = 11 and Len (welcome to VB tutorial) = 22

The Len function can also return the number of digits or memory locations of a number that is stored in the computer.

Example

```
Private sub Form_Activate ( )
```

```
X=sqr (16)
```

```
Y=1234
```

```
Z#=10#
```

```
Print Len(x), Len(y), and Len (z)
```

```
End Sub
```

The above example will produce the output 1, 4, 8. The reason why the last value is 8 is because z# is a double precision number and so it is allocated more memory spaces.

c. 2 The Right Function

The Right function extracts the right portion of a phrase. The format is

Right (“Phrase”, n)

Where n is the starting position from the right of the phrase where the portion of the phrase is going to be extracted.

Example

```
Right(“Visual Basic”, 4) = asic
```

c. 3 The Left Function

The Left\$ function extract the left portion of a phrase. The format is

Left("Phrase", n)

Where n is the starting position from the left of the phrase where the portion of the phrase is going to be extracted.

Example

Left ("Visual Basic", 4) = Visu

c. 4 The Ltrim Function

The Ltrim function trims the empty spaces of the left portion of the phrase. The format is

Ltrim("Phrase")

Example

Ltrim ("Visual Basic", 4) = Visual basic

c. 5 The Rtrim Function

The Rtrim function trims the empty spaces of the right portion of the phrase. The format is

Rtrim("Phrase")

Example:

Rtrim ("Visual Basic", 4) = Visual basic

c. 6 The Trim function

The Trim function trims the empty spaces on both side of the phrase. The format is

Trim("Phrase")

Example

Trim (" Visual Basic ") = Visual basic

c. 7 The Mid Function

The **Mid** function extracts a substring from the original phrase or string. It takes the following format:

Mid(phrase, position, n)

Where position is the starting position of the phrase from which the extraction process will start and n is the number of characters to be extracted.

Example

Mid("Visual Basic", 3, 6) = ual Bas

c. 8 The InStr function

The **InStr** function looks for a phrase that is embedded within the original phrase and returns the starting position of the embedded phrase. The format is

Instr (n, original phase, embedded phrase)

Where n is the position where the Instr function will begin to look for the embedded phrase.

Example

Instr(1, "Visual Basic", "Basic")=8

c. 9 The Ucase and the Lcase functions

The **Ucase** function converts all the characters of a string to capital letters. On the other hand, the **Lcase** function converts all the characters of a string to small letters.

Example

Ucase("Visual Basic") =VISUAL BASIC

Lcase("Visual Basic") =visual basic

c. 10 The Str and Val functions

The **Str** is the function that converts a number to a string while the **Val** function

converts a string to a number. The two functions are important when we need to perform mathematical operations.

c. 11 The Chr and the Asc functions

The **Chr** function returns the string that corresponds to an ASCII code while the **Asc** function converts an ASCII character or symbol to the corresponding ASCII code. ASCII stands for "American Standard Code for Information Interchange". Altogether there are 255 ASCII codes and as many ASCII characters. Some of the characters may not be displayed as they may represent some actions such as the pressing of a key or produce a beep sound.

The format of the Chr function is:

Chr(charcode)

and the format of the Asc function is:

Asc(Character)

The following are some examples:

Chr(65)=A, Chr(122)=z, Chr(37)=%, Asc("B")=66, Asc("&")=38

d. The mathematical functions

The mathematical functions are very useful and important in programming because very often we need to deal with mathematical concepts in programming such as chance and probability, variables, mathematical logics, calculations, coordinates, time intervals and etc. The common mathematical functions in Visual Basic are **Rnd, Sqr, Int, Abs, Exp, Log, Sin, Cos, Tan , Atn, Fix and Round.**

- Int is the function that converts a number into an integer by truncating its decimal part and the resulting integer is the largest integer that is smaller than the number. For example, $\text{Int}(2.4)=2$, $\text{Int}(4.8)=4$, $\text{Int}(-4.6)=-5$, $\text{Int}(0.032)=0$ and so on.
- Sqr is the function that computes the square root of a number. For example, $\text{Sqr}(4)=2$, $\text{Sqr}(9)=3$ and etc.
- Abs is the function that returns the absolute value of a number. So $\text{Abs}(-8)=8$ and $\text{Abs}(8)=8$.

- d. Exp of a number x is the value of e^x . For example, $\text{Exp}(1)=e^1 = 2.7182818284590$
- e. Fix and Int are the same if the number is a positive number as both truncate the decimal part of the number and return an integer. However, when the number is negative, it will return the smallest integer that is larger than the number. For example, $\text{Fix}(-6.34)=-6$ while $\text{Int}(-6.34)=-7$.
- f. Round is the function that rounds up a number to a certain number of decimal places. The Format is $\text{Round}(n, m)$ which means to round a number n to m decimal places.

Example Round (7.2567, 2) =7.26

- g. Log is the function that returns the natural Logarithm of a number.

Example

$\text{Log}(10)= 2.302585$

- h. Sin is the function that returns the natural Sinus of a number.

Example

$\text{Sin}(10)= -0,544021$

- i. Tan is the function that returns the natural Tangent of a number. For example

$\text{Tan}(10)= 0,6403608$

- j. Cos is the function that returns the natural Cosinus of a number.

Example

$\text{Cos}(10)= -0,839071$

- e. Graphical methods (Line, Circle and Rectangle)
- e. 1 Drawing lines

The Line method lets you draw lines in Visual Basic 6. You need to specify the starting point and the finishing point of the line in the argument. You may also specify the color of the line. This is optional, though.

i. A simple line

The following code example shows how to draw a simple line using the Line method.

Example i

```
Private Sub Command1_Click()  
    DrawWidth = 10  
    Line (0, 0)-(6000, 5000), vbGreen  
End Sub
```

Output

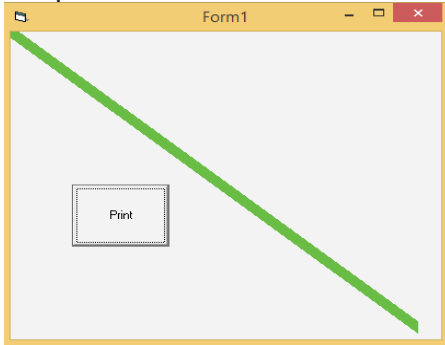

Figure 10: A Simple line

ii. A line with drawing styles

Form's DrawStyle property lets you draw lines using a particular style. The constant values of the DrawStyle property are 0 (vbSolid), 1 (vbDash), 2 (vbDot), 3 (vbDashDot), 4 (vbDashDotDot), 5 (vbTransparent) and 6 (vbInsideSolid). The default value is 0, vbSolid. You may use the numeric constant or the symbolic constant such as vbSolid, vbDash etc to change drawing styles in your code.

NOTE: The DrawStyle property does not work if the value of DrawWidth is other than 1.

Example

```
Private Sub Command1_Click()  
    DrawWidth = 1  
    DrawStyle = 1  
    Line (0, 0)-(6000, 5000), vbGreen  
    DrawStyle = vbDashDot  
    Line (100, 900)-(3500, 3500), vbBlue  
End Sub
```

Output:

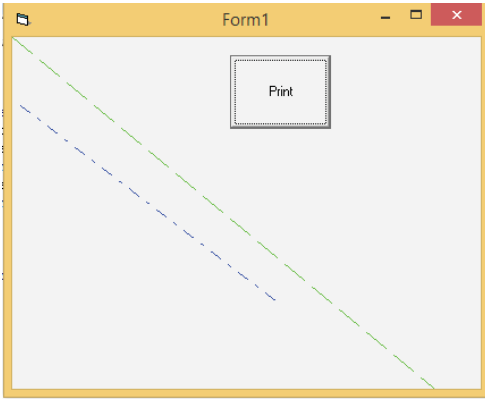

Figure 11: Lines with drawing styles

e. 2 Drawing circles

You can draw a circle using the Circle method in Visual Basic 6. You may also use the Circle method to draw different geometric shapes such as ellipses, arcs etc. You need to specify the circle's center and radius values to draw a circle using the Circle method.

i. A simple circle

The following code draws a simple circle using the Circle method in Visual Basic 6.

Example

```
Private Sub Command1_Click()  
DrawWidth = 5  
Circle (2500, 2500), 2000, vbBlue  
End Sub
```

In the above code, (2500, 2500) is the circle's center, and the radius value is 2000. The color constant 'vbBlue is an optional argument.

Output:

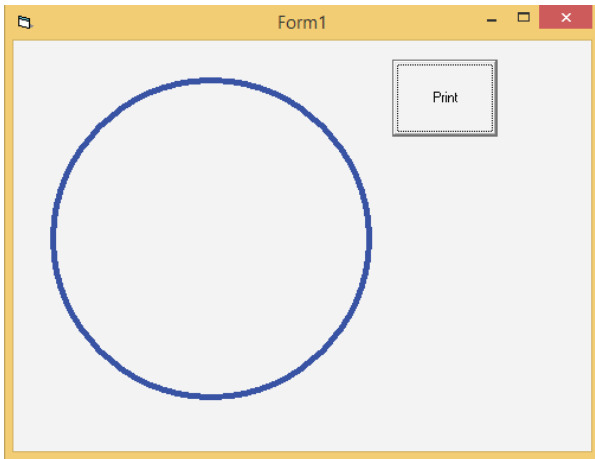

Figure 12: A simple circle

ii. A circle filled with color

The following code example shows how to fill a circle with color in Visual Basic 6.

Example

```
Private Sub Command1_Click()
```

```
FillStyle = vbSolid
```

```
FillColor = &H80C0AA
```

```
DrawWidth = 5
```

```
Circle (2500, 2500), 2000, vbBlue
```

```
End Sub
```

Output:

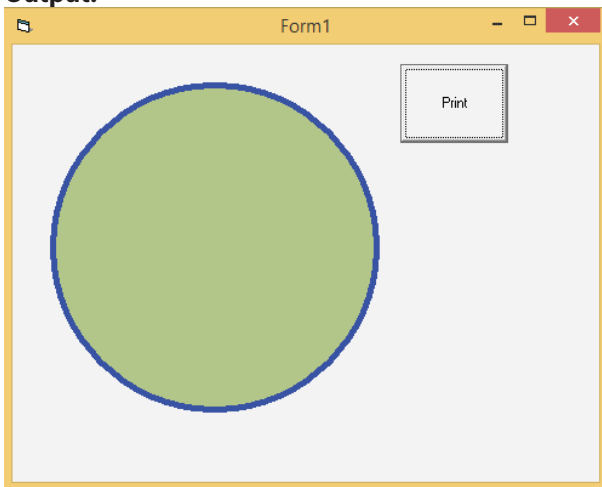

Figure 13: A circle filled with color

e. 3 Rectangle

The Line method can be used to draw different geometric shapes such as rectangle, triangle etc. The following example shows you how to draw a rectangle using the Line method in Visual Basic 6.

Example e.3

```
Private Sub Command1_Click()
```

```
DrawWidth = 5
```

```
Line (400, 400)-Step(4500, 2500), vbBlue, B
```

```
End Sub
```

The B argument in the Line method lets you draw a rectangle.

Output:

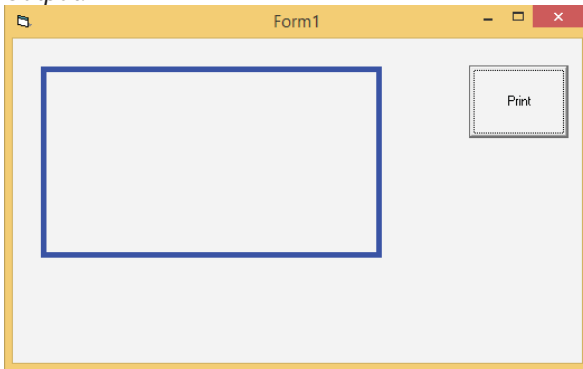

Figure 14: Rectangle

f. Format function

Formatting output is an important part of programming so that the visual interface can be presented clearly to the users. Data in the previous lesson were presented fairly systematically through the use of commas and some of the functions like Int, Fix and Round. However, to better present the output, we can use a number of formatting functions in Visual Basic. The three most common formatting functions in VB are **Tab**, **Space**, and **Format**

f.1. The Tab function

The syntax of a Tab function is **Tab (n); x**

The item x will be displayed at a position that is n spaces from the left border of the

output form. There must be a semicolon in between Tab and the items you intend to display (VB will actually do it for you automatically).

Example f.1.

```
Private Sub Form_Activate
```

```
Print "I'm"; Tab(5); "in"; Tab(10); "Senior"; Tab(15); "Six"; Tab(20); "Computer Science"
```

```
Print
```

```
Print Tab(10); "I'm "; Tab(15); "in "; Tab(20); "Senior "; Tab(25); "Six "; Tab(20); " Computer Science  
"
```

```
Print Tab(15); "I'm "; Tab(20); "in "; Tab(25); "Senior "; Tab(30); "Six "; Tab(35); " Computer Science  
"
```

```
End sub
```

f.2. The Space function

The Space function is very closely linked to the Tab function. However, there is a minor difference. While Tab (n) means the item is placed n spaces from the left border of the screen, the Space function specifies the number of spaces between two consecutive items.

Example f.2.

```
Private Sub Form_Activate()
```

```
Print "Computer"; Space(10); "Science"
```

```
End Sub
```

Means that the words Visual and Basic will be separated by 10 spaces

f.3. The Format function

The Format function is a very powerful formatting function which can display the numeric values in various forms. There are two types of Format function, one of them is the built-in or predefined format while another one can be defined by the users.

(a) The syntax of the predefined Format function is

Format (n, "style argument") where n is a number and the list of style arguments is

given in Table 6.

Table 6: List of Style Arguments

Style argument	Explanation	Example
General Number	To display the number without having separators between thousands.	Format(8972.234, "General Number")=8972.234
Fixed	To display the number without having separators between thousands and rounds it up to two decimal places.	Format(8972.2, "Fixed")=8972.23
Standard	To display the number with separators or separators between thousands and rounds it up to two decimal places.	Format(6648972.265, "Standard")=6,648,972.27
Currency	To display the number with the dollar sign in front has separators between thousands as well as rounding it up to two decimal places.	Format(6648972.265, "Currency")=\$6,648,972.27
Percent	Converts the number to the percentage form and displays a % sign and rounds it up to two decimal places.	Format(0.56324, "Percent")=56.32 %

Example f.2.

```
Private Sub Form_Activate()  
Print Format (8972.234, "General Number")  
Print Format (8972.2, "Fixed")  
Print Format (6648972.265, "Standard")  
Print Format (6648972.265, "Currency")  
Print Format (0.56324, "Percent")  
End Sub
```

Application activity 5.4.

Write a VB program using Input box that accept a string value from the keyboard and then convert it into an integer value, performs and displays its sinus, cosinus and tangent

5.2.2. User Defined functions

Learning activity 5.5.

1. Design the interface bellow and use provided codes Example a, Example b and Example c.

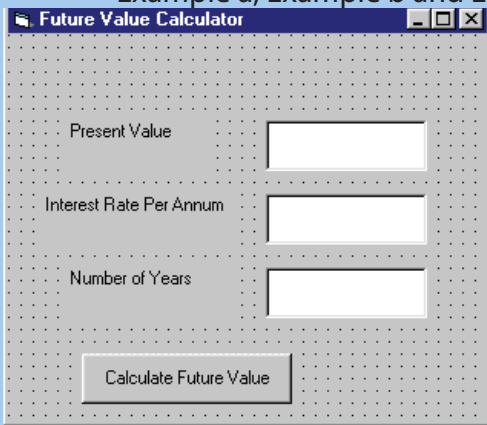

Figure 15: Interface to calculate future value

The functions that we create in a program are known as user defined functions. In this guide, we will learn how to create user defined functions and how to use them in C Programming

Functions are used because of following reasons:

- a. To improve the readability of code.
 - b. Improves the reusability of the code, same function can be used in any program rather than writing the same code from scratch.
 - c. Debugging of the code would be easier if you use functions, as errors are easy to be traced.
 - d. Reduces the size of the code, duplicate set of statements are replaced by function calls.
- a. Function prototype

A function prototype is simply the declaration of a function that specifies function's name, parameters and return type. It doesn't contain function body. A function prototype gives information to the compiler that the function may later be used in the program.

Syntax of function prototype in VB

Function FunctionName(arg1 As type1, arg2 As type2, ...) As return data types

In the above example public, Function FunctionName(argument1 As type1, argument As type2,...) As return data types

The function prototype provides the following information to the compiler:

1. name of the function is FunctionName
2. return type of the function is Double
3. two arguments of type (argument1 As type1, argument As type2) have passed to the function

The function prototype is not needed if the user-defined function is defined before the module program. Public indicates that the function is applicable to the whole project and Private indicates that the function is only applicable to a certain module or procedure.

Example a

```
Public Function FV (PV As Double, i As Double, n As Double) As Double
```

c. Function definition

A function definition specifies the name of the function, the types and number of parameters it expects to receive, and its return type. A function definition also includes a function body with the declarations of its local variables, and the statements that determine what the function does.

Example b

```
Public Function FV(PV As Double, i As Double, n As Double) As Double
```

```
'Formula to calculate Future Value (FV)
```

```
'PV denotes Present Value
```

```
FV = PV * (1 + i / 100) ^ n
```

```
End Function
```

In this example, a user can calculate the future value of a certain amount of

money he/she has today based on the interest rate and the number of years from now, supposing he/she will invest this amount of money somewhere. The calculation is based on the compound interest rate.

d. Function calling

When you call a function you are basically just telling the compiler to execute that function. To call a function "Call" key word can be used or not.

Syntax

[procedureName][argumentList]

Example c

```
Private Sub compute_Click()  
'This procedure will calculate Future Value  
Dim FutureVal As Double  
Dim PresentVal As Double  
Dim interest As Double  
Dim period As Variant  
PresentVal = PV.Text  
interest = rate.Text  
period = years.Text  
'calling the function  
FutureVal = FV(PresentVal, interest, period)  
MsgBox ("The Future Value is " & FutureVal)  
End Sub
```

The following program will automatically compute examination grades based on the marks that a student obtained. The code is shown below:

```
Public Function grade(mark As Variant) As String  
Select Case mark  
Case Is >= 80  
grade = "A"  
Case Is >= 70
```

```

grade = "B"
Case Is >= 60
grade = "C"
Case Is >= 50
grade = "D"
Case Is >= 40
grade = "E"
Case Else
grade = "F"
End Select
End Function
Private Sub Command1_Click()
Dim stdmarks As Double
stdmarks = Val(InputBox("Please enter student marks", "Student marks"))
Print grade(stdmarks)
End Sub

```

e. Passing Arguments by Value and by Reference in Visual Basic

In Visual Basic, you can pass an argument to a procedure by value or by reference. This is known as the passing mechanism, and it determines whether the procedure can modify the programming element underlying the argument in the calling code.

The procedure declaration determines the passing mechanism for each parameter by specifying the ByVal or ByRef keyword.

e. 1. Passing Arguments by Value

You pass an argument by value by specifying the ByVal keyword for the corresponding parameter in the procedure definition. When you use this passing mechanism, Visual Basic copies the value of the underlying programming element into a local variable in the procedure. The procedure code does not have any access to the underlying element in the calling code.

Example e.1

```
Private Sub Command1_Click()  
Dim Test As Integer  
Test = 120  
TestFunction Test  
MsgBox (Test)  
End Sub  
Function TestFunction(ByRef i As Integer)  
i = i + 1  
End Function
```

After executing the above codes output will be: 1

e. 2. Passing Arguments by Reference

You pass an argument by reference by specifying the ByRef keyword for the corresponding parameter in the procedure definition. When you use this passing mechanism, Visual Basic gives the procedure a direct reference to the underlying programming element in the calling code.

Example d.2

```
Private Sub Command1_Click()  
Dim Test As Integer  
Test = 1  
TestFunction Test 'line 5  
MsgBox Test  
End Sub  
Private Sub TestFunction(ByRef i As Integer)  
i = i + 1  
End Sub
```

After executing the above codes output will be: 2

e. 3. Differences between Passing an Argument By Value and By Reference

When you pass one or more arguments to a procedure, each argument corresponds to an underlying programming element in the calling code. You can pass either the value of this underlying element, or a reference to it. This is known as the passing mechanism.

Application activities 5.5.

1. Write a VB function to find the Maximum of three numbers
2. Write a VB function to sum all the numbers in a list

Sample List : (8, 2, 3, 0, 7)

Expected Output : 20

5.2.3 Procedures

Learning activities 5.6.

1. Write a function which allows a user to input monthly salary and then allow him/her to withdraw amount which does not exceed 90% of his/her monthly income otherwise the software should inform the user that the remaining amount (10%) is reserved for the future needs saving .

A procedure is a block of Visual Basic statements inside Sub, End Sub statements. Procedures do not return values. A procedure, in any language, is a self-contained piece of code which carries out a well-defined piece of processing.

a. Syntax of a procedure

[Private /public][Sub] [ProcedureName][Argument list]

Statements

[End Sub]

b. Types of procedure

b. 1. Event procedures

Visual Basic has two kinds of procedures, **event procedures** and **general procedures**.

An event procedure is “attached” to an object and is executed when the relevant event impinges on that object.

e.g., "Click" is an event procedure attached to a button, and is executed when the button is clicked (by the user, with the mouse).

Event procedures are named by VB. VB creates a name for an event procedure by concatenating the name of the object and the name of the event, and putting an underscore between them.

e.g., the click event procedure for a button named "CmdQuit" will be named "CmdQuit_Click".

b. 2. General procedures

A general procedure is not attached to an object such as a button or a text field. A general procedure is located in the "general" section of a Form.

Unlike event procedures, general procedures are only executed when you explicitly call them from your code. You are responsible for naming general procedures, and you can give them any name you like (within normal VB naming rules).

e.g. suppose there are 10 different places in your program where you might want to issue the following error message (with a beep to attract the user's attention):

Beep

MsgBox "Please enter a valid number, then press Enter"

To avoid entering these two lines of code 10 times, and to ensure consistency of wording, spelling etc., you could put them in a general procedure, as follows:

```
Private Sub numberError ()
```

```
    Beep
```

```
    MsgBox "Please enter a valid number, then press Enter"
```

```
End Sub
```

Then, whenever you wanted to issue that error message, you would just enter the following line of code into your program:

Call numberError

Procedures can accept parameters, e.g. a procedure to put a number into a TextBox, formatted to two decimal places and prefixed with a "£" symbol:

```
Private Sub makeMoney (num As Single)
    txtOutput.Text = "£" + Format( Str$(num), "0.00" )
End Sub
```

The above procedure could be called whenever an amount needed to be output via the TextBox txtOutput, as follows:

```
amount = Val(txtInput.Text)
Call makeMoney(amount)
```

The procedure could be made more useful by rewriting it with a second parameter to specify which TextBox you wanted the amount placed into:

```
Private Sub makeMoney (num As Single, txtBox As TextBox)
    txtBox.Text = "£" + Format( Str$(num), "0.00" )
End Sub
```

and to call this procedure...

```
amount = Val(txtInput.Text)
Call makeMoney(amount, txtOutput)
```

Note: We use procedures and functions to create modular programs. Visual Basic statements are grouped in a block enclosed by Sub, Function and matching End statements. The difference between the two is that functions return values, procedures do not.

A procedure and function is a piece of code in a larger program. They perform a specific task. The advantages of using procedures and functions are:

- Reducing duplication of code
- Decomposing complex problems into simpler pieces
- Improving clarity of the code
- Reuse of code
- Information hiding

Application activities 5.6.

1. Write a VB program using procedure which helps a business Woman who has a shop in Nyanza city southern province to input manufactured , expiring and buying year for each product that she has in the shop and then informs whether the product has expired or still valid.

END UNIT ASSESSMENT

1. What do you understand by an array?
2. Discuss about the use of arrays in program.
3. Give the syntax and steps to write a function and a procedure
4. Differentiate a function from a procedure
5. Differentiate a built in function from a user defined function and explain the use of each one
6. Write a VB procedure which solves quadratic equation ($ax^2+bx+c=0$) each output must be underlined using a procedure called underline ().
7. Design a VB function program to find Factorial of an entered number

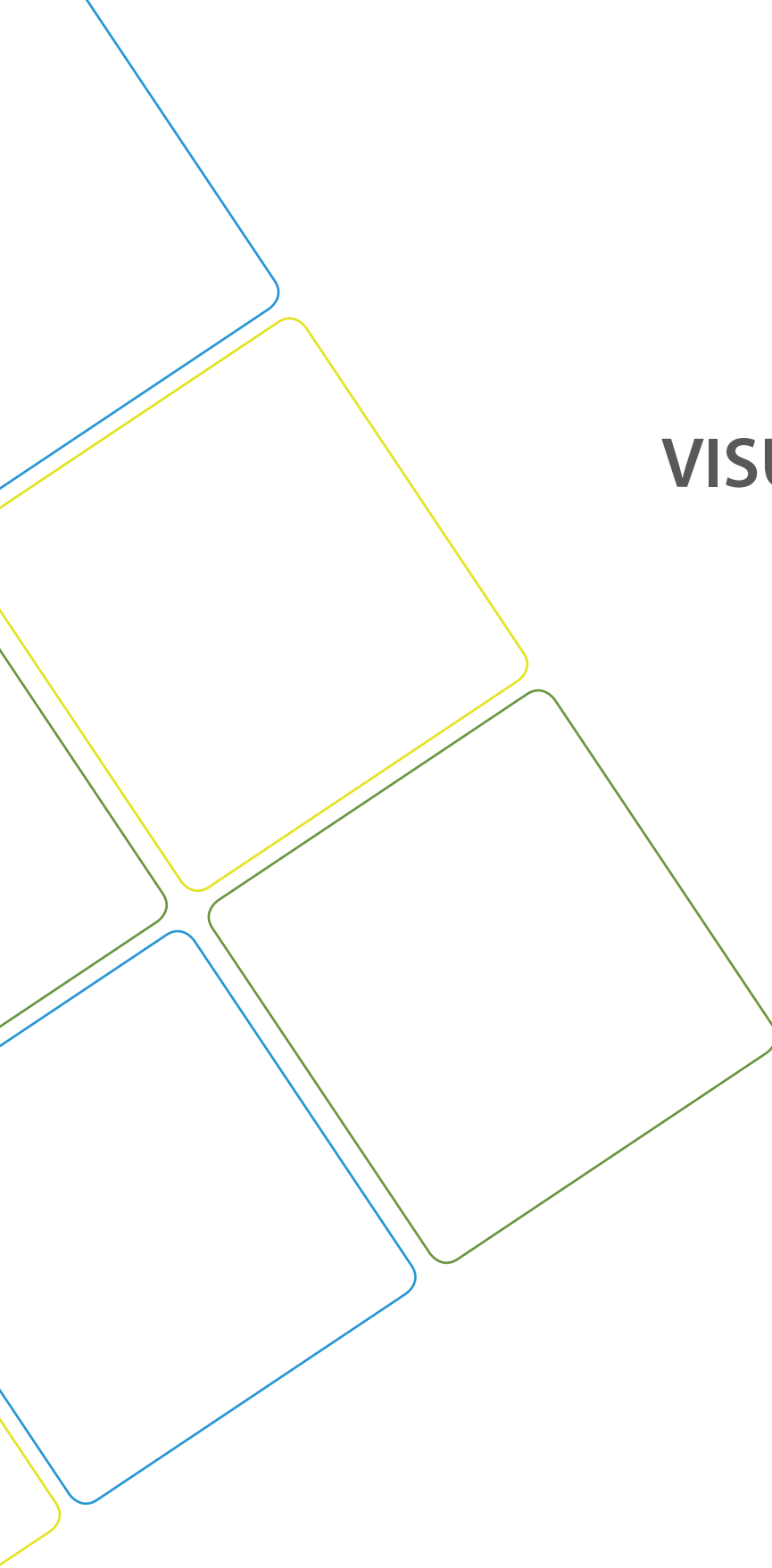

UNIT 6

VISUAL BASIC PROJECT

UNIT 6. VISUAL BASIC PROJECT

Key Unit Competency

To be able to connect Visual Basic Interface to Database and create a simple Visual Basic standard desktop applications for a real life situation.

Introductory activity

GS Gisakura is a Twelve- Years- Basic- Education School that has a big number of students. The school is facing the problem of students' information management and is looking for an application to manage its students' registration.

After elucidating the requirement specifications of the GS Gisakura's students' registration system do the following:

1. Using Visual basic, create a front end interface for the GS Gisakura students' registration system.
2. Using MS access, create the database for the GS Gisakura's students registration system.
3. Using Open Database Connectivity (ODBC), link the front and back end interfaces for the GS Gisakura students' registration system.
4. Using Data Access Objects (DAO), Data controls and properties; manipulate data of the GS Gisakura students' registration system.
5. Design the front end interface basing on ergonomics rules

6.1. PROJECT 1: REQUIREMENT ANALYSIS AND PROJECT PLANNING

In every software project, you need to collect and analyze the information about what you are going to do. This phase in Software Development Life Cycle (SDLC) is called requirement' analysis.

To develop a Visual Basic Project, all requirements specifications must be gathered so that the planning of the project can be realized.

6.1.1. VB Project Planning

The project planning is an important phase of a software development. It works on the breakdown of activities, the scheduling, the human force distribution, its recruitment and capacity development. The cost of the project is also done by considering the size of work and manpower needed for its realization.

As each project should have its objectives, for example, the student registration system should manage student registration information where every student information in the system has to be recorded, stored and should be modifiable (edit, add new, delete and update) by the authorized users.

6.1.2. Software requirement analysis

The software requirement or specification requirement phase allows both the developers and their clients to have a common understanding of the project and avoids mistakes that should cause failures. The requirements can be functional and nonfunctional. Functional requirements are those requirements concerning actions to be performed by the new system while nonfunctional requirements concern the constraints, performance, safety, security, timing and the quality of the new system. In case of the software that manages a school, the Software requirement should help to understand the status of the school in terms of computerization, the intended software and how it will work with the users in this phase. So, there is a need to take sufficient time by conducting extensive interviews with all the people who are going to use the software. In this case, the school administrators, teachers, students and the school secretary have to give their views.

After, it is better to structure all collected data and analyze them for the development of the program. All technical limitations that may arise on the client's side must be considered before the development of a list of specifications that meet the user's needs.

The template to be followed for the software functional requirements is described hereafter. The main template is follows the points in the tablebelow.

Titles	Explanations
A. Introduction	
Purpose	Identify the product whose software requirements are specified in this document, including the revision or release number. Describe the scope of the product that is covered by this SRS, particularly if this SRS describes only part of the system or a single subsystem. Provide a short description of the software being specified and its purpose, including relevant benefits, objectives, and goals.
Intended Audience and Reading Suggestions	Describe the different types of reader that the document is intended for, such as developers, project managers, marketing staff, users, testers, and documentation writers. Describe what the rest of this SRS contains and how it is organized. Suggest a sequence for reading the document, beginning with the overview sections and proceeding through the sections that are most pertinent to each reader type.
B. Project Scope	Provide a short description of the software being specified and its purpose, including relevant benefits, objectives, and goals. Relate the software to corporate goals or business strategies. If a separate vision and scope document is available, refer to it rather than duplicating its contents here. An SRS that specifies the next release of an evolving product should contain its own scope statement as a subset of the long-term strategic product vision.
C. References	List any other documents or Web addresses to which this SRS refers. These may include user interface style guides, contracts, standards, system requirements specifications, use case documents, or a vision and scope document. Provide enough information so that the reader could access a copy of each reference, including title, author, version number, date, and source or location.

D. Overall Description	
E. Product Perspective	Describe the context and origin of the product being specified in this SRS. For example, state whether this product is a follow-on member of a product family, a replacement for certain existing systems, or a new, self-contained product. If the SRS defines a component of a larger system, relate the requirements of the larger system to the functionality of this software and identify interfaces between the two. A simple diagram that shows the major components of the overall system, subsystem interconnections, and external interfaces can be helpful.
Product Features	Summarize the major features the product contains or the significant functions that it performs or lets the user perform. Details will be provided in Section 3, so only a High-level summary is needed here. Organize the functions to make them understandable to any reader of the SRS. A picture of the major groups of related requirements and how they relate, such as a top level data flow diagram or a class diagram, is often effective.
Classes and Characteristics	Identify the various user classes that you anticipate will use this product. User classes may be differentiated based on frequency of use, subset of product functions used, technical expertise, security or privilege levels, educational level, or experience. Describe the pertinent characteristics of each user class. Certain requirements may pertain only to certain user classes. Distinguish the favored user classes from those who are less important to satisfy.
Operating Environment	Describe the environment in which the software will operate, including the hardware platform, operating system and versions, and any other software components or applications with which it must peacefully coexist.

<p>Design and Implementation Constraints</p>	<p>Describe any items or issues that will limit the options available to the developers. These might include: corporate or regulatory policies; hardware limitations (timing requirements, memory requirements); interfaces to other applications; specific technologies, tools, and databases to be used; parallel operations; language requirements; communications protocols; security considerations; design conventions or programming standards (for example, if the customer's organization will be responsible for maintaining the delivered software).</p>
<p>User Documentation</p>	<p>List the user documentation components (such as user manuals, on-line help, and tutorials) that will be delivered along with the software. Identify any known user documentation delivery formats or standards.</p>
<p>Assumptions and Dependencies</p>	<p>List any assumed factors (as opposed to known facts) that could affect the requirements stated in the SRS. These could include third-party or commercial components that you plan to use, issues around the development or operating environment, or constraints. The project could be affected if these assumptions are incorrect, are not shared, or change. Also identify any dependencies the project has on external factors, such as software components that you intend to reuse from another project, unless they are already documented elsewhere (for example, in the vision and scope document or the project plan).</p>

Table 1: Main points of functional requirements

3. System Features

This template illustrates how to organize the functional requirements for the product by system features and the major services provided by the product. This section can be organized by mode of operation, user class, object class, functional hierarchy, or combinations of these, whatever makes the most logical sense for your product.

The main points of the template with their explanations should be like the following.

Points	Explanations
System Feature 1	Don't really say "System Feature 1." State the feature name in just a few words
Description and Priority	<p>Provide a short description of the feature and indicate whether it is of High, Medium, or</p> <p>Low priority. You could also include specific priority component ratings, such as benefit,</p> <p>Penalty, cost, and risk (each rated on a relative scale from a low of 1 to a high of 9).</p>
Stimulus/ Response Sequences	<p>List the sequences of user actions and system responses that stimulate the behavior</p> <p>Defined for this feature. These will correspond to the dialog elements associated with use Cases.</p>
Functional Requirements	<p>Itemize the detailed functional requirements associated with this feature. These are the software capabilities that must be present in order for the user to carry out the services provided by the feature, or to execute the use case. Include how the product should respond to anticipated error conditions or invalid inputs. Requirements should be concise, complete, unambiguous, verifiable, and necessary. Use "TBD" as a placeholder to indicate when necessary information is not yet available. Each requirement should be uniquely identified with a sequence number or a meaningful tag of some kind.</p>

Table 2: Main points for a system feature

4. External Interface Requirements

a. User Interfaces

Describe the logical characteristics of each interface between the software product and the users. This may include sample screen images, any GUI standards or product family style guides that are to be followed, screen layout constraints, standard buttons and functions (e.g., help) that will appear on every screen, keyboard shortcuts, error message display standards, and so on. Define the software components for which a user interface is needed. Details of the user interface design should be documented in a separate user interface specification.

b. Hardware Interfaces

Describe the logical and physical characteristics of each interface between the software product and the hardware components of the system. This may include the supported device types, the nature of the data and control interactions between the software and the hardware, and communication protocols to be used.

c. Software Interfaces

Describe the connections between this product and other specific software components (name and version), including databases, operating systems, tools, libraries, and integrated commercial components. Identify the data items or messages coming into the system and going out and describe the purpose of each. Describe the services needed and the nature of communications. Refer to documents that describe detailed application programming interface protocols. Identify data that will be shared across software components. If the data sharing mechanism must be implemented in a specific way (for example, use of a global data area in a multitasking operating system), specify this as an implementation constraint.

d. Communications Interfaces

Describe the requirements associated with any communications functions required by this product, including e-mail, web browser, network server communications protocols, electronic forms, and so on. Define any pertinent message formatting. Identify any communication standards that will be used, such as FTP or HTTP. Specify any communication security or encryption issues, data transfer rates, and synchronization mechanisms.

5. Other Nonfunctional Requirements

a. Performance Requirements

If there are performance requirements for the product under various circumstances, state them here and explain their rationale, to help the developers understand the intent and make suitable design choices. Specify the timing relationships for real time systems. Make such requirements as specific as possible. You may need to state performance requirements for individual functional requirements or features.

b. Safety Requirements

Specify those requirements that are concerned with possible loss, damage, or harm that could result from the use of the product. Define any safeguards or actions that must be taken, as well as actions that must be prevented. Refer to any external policies or regulations that state safety issues that affect the product's design or use. Define any safety certifications that must be satisfied.

c. Security Requirements

Specify any requirements regarding security or privacy issues surrounding use of the product or protection of the data used or created by the product. Define any user identity authentication requirements. Refer to any external policies or regulations containing security issues that affect the product. Define any security or privacy certifications that must be satisfied.

d. Software Quality Attributes

Specify any additional quality characteristics for the product that will be important to either the customers or the developers. Some to consider are: adaptability, availability, correctness, flexibility, interoperability, maintainability, portability, reliability, reusability, robustness, testability, and usability. Write these to be specific, quantitative, and verifiable when possible. At the least, clarify the relative preferences for various attributes, such as ease of use over ease of learning.

e. Other Requirements

Define any other requirements not covered elsewhere in the SRS. This might include database requirements, internationalization requirements, legal requirements,

reuse objectives for the project, and so on. Add any new sections that are pertinent to the project

6.1.3 Project1

Based on the request of your school to have a student registration system and by following the software requirement specifications template given above, develop the Requirements Document.

6.2. PROJECT2: FRONT END USER INTERFACE IN VISUAL BASIC

6.2.1. Understanding front end

In visual basic, the term Front End refers to the user interface, where the user interacts with the program through the use of the screen forms and reports. The Front End graphical user interface use buttons, text field and different icons to make easy navigation of the application software.

6.2.2. Design the forms constituting a front end interface

Front-end interface for the GS Gisakura students' registration layout are given below and you are going to design the same layout and your own basing on SRS you have elucidated in your school as case study.

a. Login form

The image shows a login form with a light green background. It consists of the following elements:

- A text input field labeled "USERNAME".
- A text input field labeled "PASSWORD".
- Two buttons at the bottom: "LOGIN AS ADMIN" and "LOGIN AS GUEST".

Main forms

The screenshot shows a web application window titled "STUDENT REGISTRATION FORM". The window has a light green background and contains the following elements:

- Header: "WELCOME TO GS GISAKURA STUDENT REGISTRATION INFORMATION SYSTEM"
- Form fields:
 - STUDENT ID: text input
 - FIRST NAME: text input
 - LAST NAME: text input
 - GENDER: dropdown menu
 - MATHER'S NAME: text input
 - FATHER'S NAME: text input
 - Age: text input
 - ID / PASSPORT: text input
 - PROVINCE: dropdown menu
 - DISTRICT: dropdown menu
 - SECTOR: text input
 - OPTION: dropdown menu
 - CLASS: dropdown menu
- Buttons:
 - EXIT (top right)
 - ADD NEW (bottom center)
 - UPDATE (bottom center)
 - DELETE (bottom center)
 - PREVIOUS (bottom left)
 - NEXT (bottom center)
 - BOTTOM (bottom right)
 - TOP (bottom right)

6.3. PROJECT 3: BACK END DATABASE

(In Ms-Access, MySQL or any suitable RDBMS)

Database systems are comprised of a Front End and Back End. The Back End has the tables that store data, including the relationships between the tables, data queries and other behind the scenes technology that accepts information from and displays information to the user via the Front End.

For example, when you are requesting for a birth certificate through Irembo there is a number of information you provide through different forms and that information is kept in the Irembo database tables.

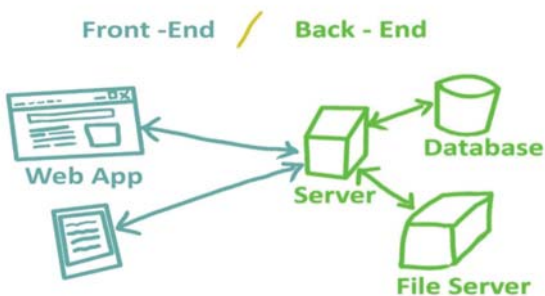

Figure 6.1. Relationship front end-back end

Back ends can be built using different Relational Database Management Systems

such as Microsoft Access, SQL Server, Oracle etc. User at the front end of a system does not need to know how data is stored and how it is modified or retrieved.

Note: If you create a program that access a database:

- Programming language are used as Front End. Example: Visual Basic, HTML. etc.
- Database management systems are used as Back End. Example: Microsoft Access, My SQL, SQL Server, Oracle, etc.

Below is layout of created table in design view. Create a database and name it “school” and create a table whose “student_reg” as a name, using your suitable Database management system (in this book we have used MS access 2016) with the same field names as below. After, you are going to design and create your own database basing on SRS you found in your school as case study.

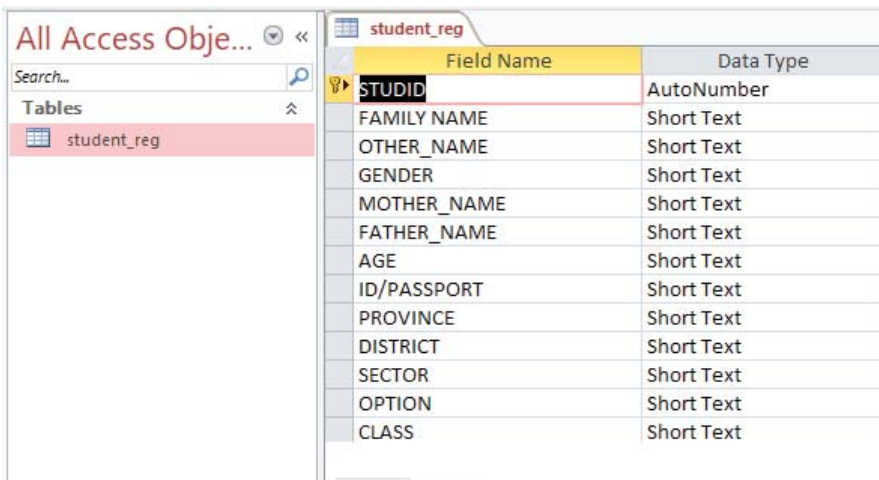

Field Name	Data Type
STUDID	AutoNumber
FAMILY_NAME	Short Text
OTHER_NAME	Short Text
GENDER	Short Text
MOTHER_NAME	Short Text
FATHER_NAME	Short Text
AGE	Short Text
ID/PASSPORT	Short Text
PROVINCE	Short Text
DISTRICT	Short Text
SECTOR	Short Text
OPTION	Short Text
CLASS	Short Text

Figure 6.2. Students’ registration table in design view

6.4. PROJECT 4: CONNECTING A VISUAL BASIC 6.0 PROJECT TO A DATABASE (ODBC configuration)

A visual basic database application has three main parts: user interface, the database engine and the data storage.

- **The user interface:** Is the Media through which the user interacts with the application. It may be form or group of forms, a window or an ActiveX document form.
- **The database engine:** Connects the application program with the physical database files. This gives you modularity and independence from the particular database you are accessing. For all types of database, the same

data access object and programming techniques can be used in visual basic.

- **The data storage:** Is the source of the data. It may be a database or a text file. Database processing has become an integral part of all types of complex applications. A database is a system that contains different objects, which can be used together to store data. Using visual basic, you can create applications easily and make them have efficient access to data.

6.4.1. ODBC (Object Database Connectivity) configuration

a. ODBC overview

ODBC stands for Open Database Connectivity, a standard database access method developed by the SQL Access group in 1992. The goal of ODBC is to make it possible to access any data from any application, regardless of which database management system (DBMS) is handling the data. ODBC manages this by inserting a middle layer, called a database driver, between application and DBMS. The purpose of this layer is to translate the application's data queries into commands that the DBMS understands. For this to work, both application and DBMS must be ODBC compliant.

b. Create an ODBC connection for the Database

Step 1. Click Start button, and select Control Panel. Once the control panel gets opened, click on Administrative Tools or type it in search control panel if you do not locate the Administrative Tools or just type ODBC in start button search and click ODBC data sources(32bit)

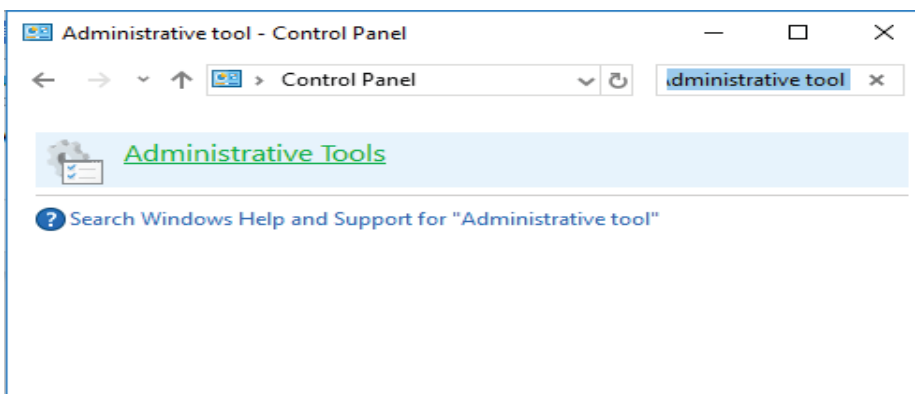

In Administrative Tools, click Data Sources (ODBC).

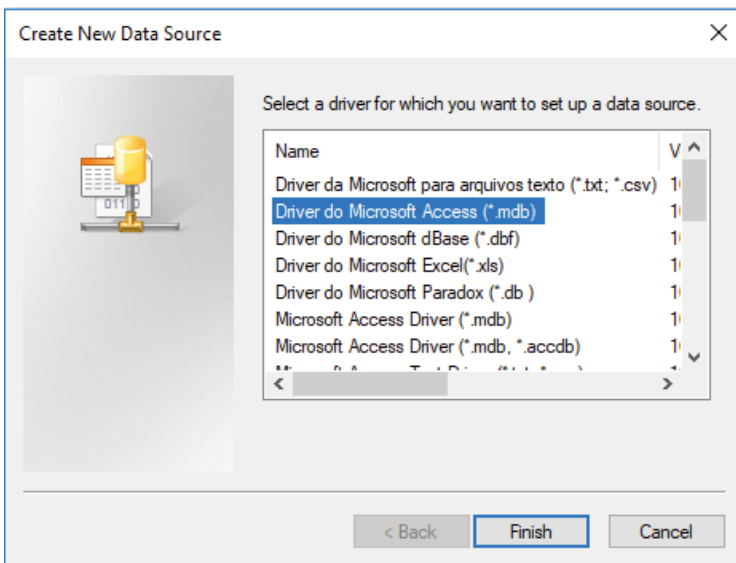
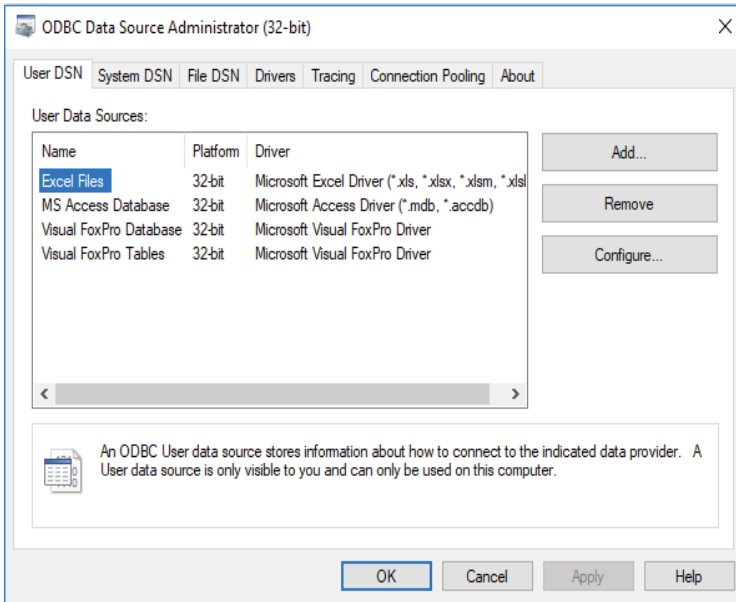

Step 2. Now we are going to add new database, click Add button and new window will appear "Create New Data Source", select the Driver do Microsoft Access (*.mdb) for MS Access, click Finish Button.

Step 3: We're almost done, let's configure the ODBC for MS Access, under Data Source Name, type the MyDatabase, please leave blank the description it's optional. Now, let's select the path of your database .mdb once you found it select OK button.

The image shown below means that the Database .mdb is successfully located. Click

OK button to Finish the configuration. (MS Access Database Configuration done).

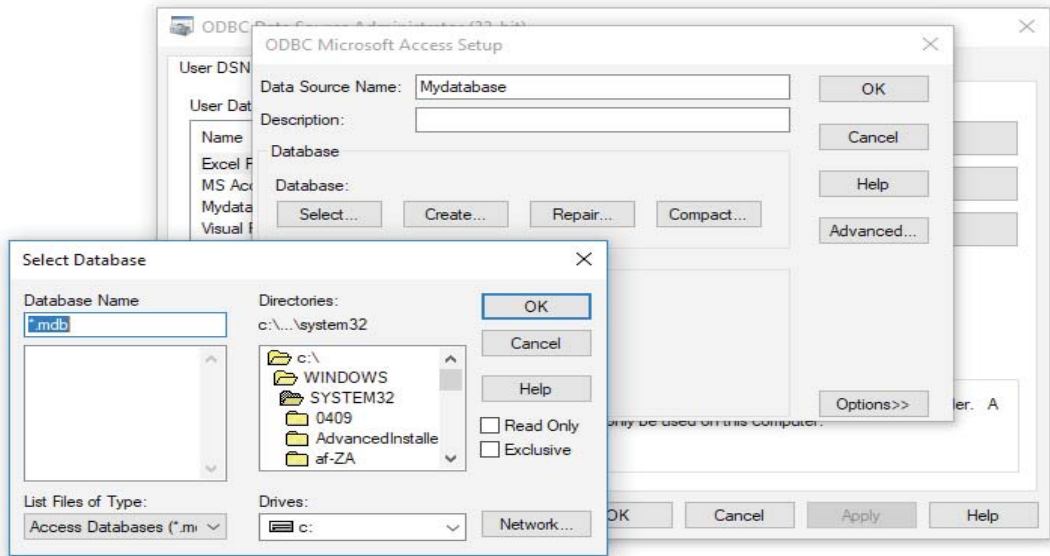

Done! You are now ready to connect your visual basic program using this ODBC setup

6.5. PROJECT 5: DAO, RDO AND ADO OBJECTS IN VISUAL BASIC

Using all steps and guidance below, create connectivity between your backend and frontend

a. Introduction

You may build VB database applications using data control, however, data control is not a very flexible tool as it could only work with limited kinds of data and must work strictly in the Visual Basic environment. To overcome these limitations, we can use a much more powerful data control in Visual Basic, known as ADO control.

Data control is a control that allows connecting a VB program to a text database such as (Sql Server, MS Access, MySQL, Dbase, FoxPro...). That control allows moving in data base records, display, and manipulating data in a list of the available data base records. It is adjusted on the form of other objects and you can define its properties. There are many types of data controls; in Visual Basic, there are three data access interfaces: Dao (Data Access Object), RDO (Remote Data Object), Ado (ActiveX Data

Object). The latest among the three is ADO, which features a simpler yet more flexible object model than either RDO or DAO.

- 1. Data access object (DAO)** is an object that provides an abstract interface to some type of database or other persistence mechanism. By mapping application calls to the persistence layer, DAOs provide some specific data operations without exposing details of the database. This isolation supports the Single responsibility principle. It separates what data accesses the application needs, in terms of domain-specific objects and data types (the public interface of the DAO), from how these needs can be satisfied with a specific , database schema, etc. (the implementation of the DAO).
- 2. Remote Data Objects** (abbreviated **RDO**) is the name of an obsolete data access application programming interface primarily used in Microsoft Visual Basic applications on Windows 95 and later operating systems. This includes database connection, queries, stored procedures, result manipulation, and change commits. It allowed developers to create interfaces that can directly interact with Open Database Connectivity (ODBC) data sources on remote machines, without having to deal with the comparatively complex ODBC API (Open Database Connectivity- Application Programming Interface). Remote Data Objects was included with versions 4, 5, and 6 of Visual Basic; the final version of RDO is version 2.0.
- 3. ActiveX data Object (ADO)**

This control helps us to access a database data offering the possibility of working on different data sources such as text files, relational data base etc.

i. Add ADO control

ADO controls contain multitudes of objects having properties, methods and events.

Access-connection: It allows your program to access a data source using a connection. Its environment deals with transferring data.

ii. Recordset:

this property work with the records which can be accessed by an ADO control. Most of methods are associated to this property. You can use this property to count the number of records.

For example using the command: `CmdRecordCount()`

```
Private Sub CmdRecordCount_click()
```

```
Adodc1.Recordset.MoveLast
```

```
MsgBox Adodc1.RecordSet.RecordCount 'to count the number of records
```

```
End Sub
```

- **Field:** correspond to the fields of a database which are connected to the program.
- **Error:** Errors may occur when a program fails to connect t, execute a command or perform a given operation.
- **Event:** ADO uses the concept of events as other VB interfaces do, you can use also event procedures.
- **Recordsource:** Recordsource property specifies the source of the records accessible through bound controls on your form. If you set the recordsource property to the name of an existing table in the database, all of the fields in that table are visible to the bound controls attached to the Data control.
- **Datasource:** The datasource property specifies an object containing data to be represented as a recordset object. It is used to create data-bound **controls with the data environment in visual basics.**

Eg: a datasource can be a spreadsheet, text file.

To add the ADO control on the form perform the following steps:

1. Select the command Component in the project menu
2. Click on Controls in the dialog box which opens
3. Select Microsoft Ado Data Controls 6.0 (OLEDB)
4. Click ok button
5. This control will be added to the toolbox.
6. To connect ADO objects on the data source use a «ConnectionString» and specify the datasource (the database name you want to connect)
7. Then you have to specify the access path after clicking the connection property.

Let us go a bit details and do practice

Select components in Project Menu or use keyboard shortcuts CTRL+T In components check in check boxes for:

- Microsoft ADO Data Control 6.0 (OLEDB) &Microsoft DataGrid Control 6.0

(OLEDB) By right click in tool box, we obtain also components

- Double click on the form and write the following codes:

```
Private Sub Form_Load()
```

```
Adodc1.ConnectionString = ""
```

```
Adodc1.RecordSource = "select * from student"
```

```
Set DataGrid1.DataSource = Adodc1
```

```
End Sub
```

- Create a connection string by making right click on adodc control which is on the form, then select properties.
- On the properties page which opens, choose build and select the path

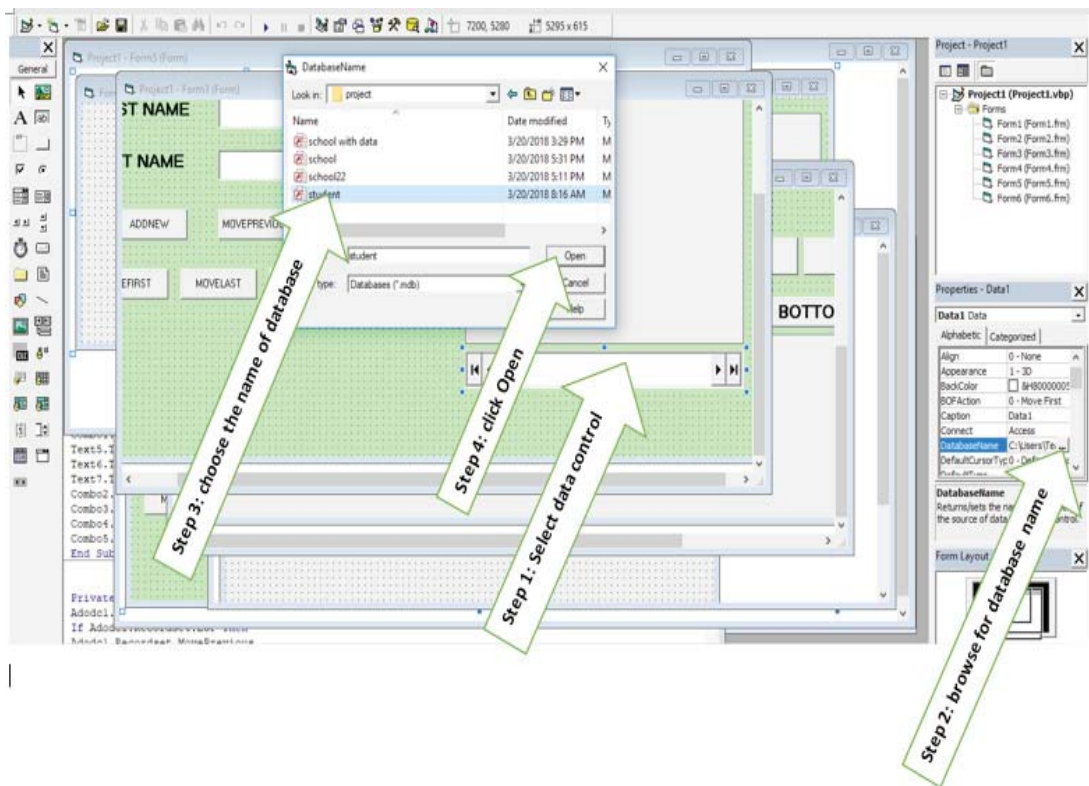

b. Method of the data control

Data control properties

- Name: you can keep data1 or put the one of your choice
- Caption=put your own message or leave it blank
- Connect=access
- Database name= browse and get the Employee database.

- Recordset type= table
- Record source=name of the table
- Visible= choose false so that when you run your application, the data control will not appear

Data control has many methods like move first, move last, move next, and move previous which are used to move through the records.

MoveFirst: will move the record pointer to the first record in the recordset.

MoveNext: will move the record pointer to the next record in the recordset

MovePrevious: will move the record pointer to the previous record in the recordset

MoveLast: will move the record pointer to the last record in the recordset

6.6. PROJECT 6 DATA CONTROLS, PROPERTIES AND DATA MANIPULATION AND CODING

(adodc, recordset, addnew, delete, update, movenext, movelast, movefirst, moveprevious code in vb for data manipulation)

To create an ADO Data Control that exposes a Recordset in your application, at the minimum you need to do the following:

- Specify a Connection by filling in the ConnectionString property.
- Specify how to derive a Recordset by setting the RecordSource property (which is a complex property requiring its own dialog box to set up).

The detailed steps are as follows:

6.6.1. Setting up ADO Data Control in Visual Basic 6.0

a. Adding ADODC (ADO Data Control) on toolbox

To add ADO Data control, make right click on toolbox dialog box and choose component, then you will have a dialog box and tick Microsoft ADO Data Control 6.0(OLEDB) and click OK as shown below:

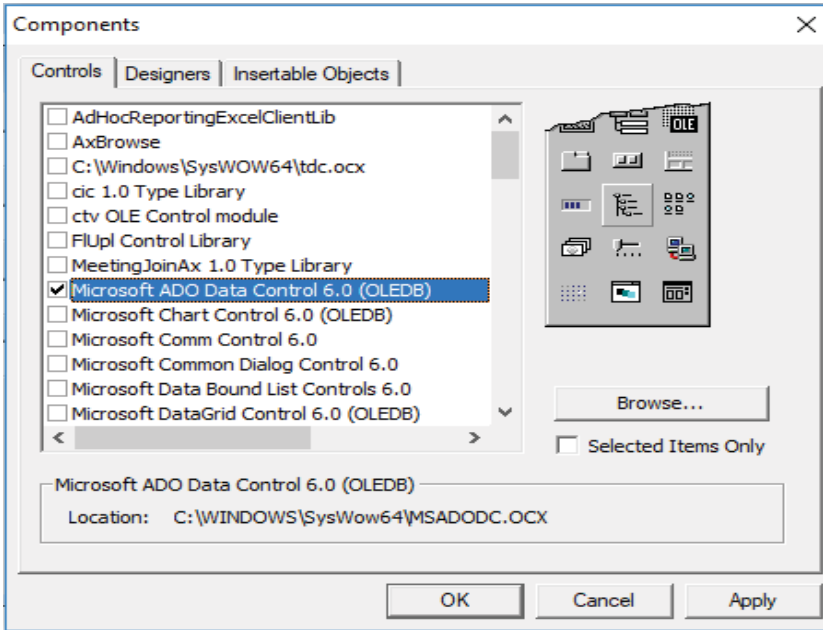

The ADO Data Control icon should now appear in the VB toolbox.



Place an instance of the ADO Data Control on the form

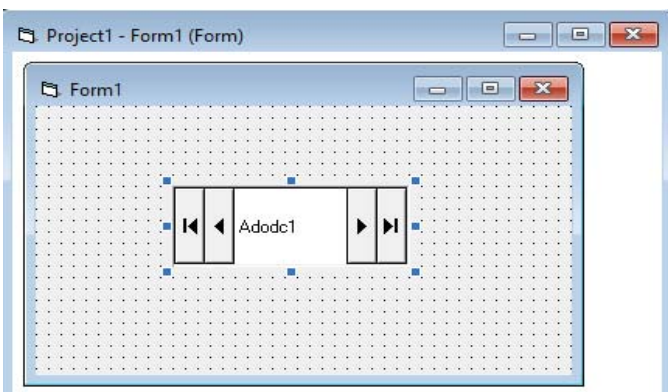

ADODC is now dragged on visual basic form

b. RECORDSET

Recordset property:

A recordset object provides a logical representation of a record in a table, or in the results of a query. There are three types of recordset object:

1. **Table:** this type of recordset provides access to all of the record and field in a specified table. The contents of records can be updated using the table type, but only one table can be referenced by this type of recordset. Data access is faster, since it has a direct reference to the table.
2. **Dynaset:** the dynaset type represents a selected (by SQL) set of records from one or more tables. The records and fields contained in a dynaset type are specified by a query. The data can be modified in the case of dynaset type recordset.
3. **Snapshot:** the snapshot type recordset is similar to a dynaset but it is a read only. The data cannot be updated. So you cannot use snapshot type to modify records in a table. Snapshot type can be used if you want only to view data or fill drop down from a table.

In a recordset, two special positions of record pointer are BOF and EOF.

- BOF is the beginning of the file before the first record
- EOF is the end of the record after the last record. The record pointer is to the first record when BOF is reached and the last record when EOF is reached

Use of ADO control to connect database fields to different VB objects

How to connect database fields to textbox?

1. Select a textbox to connect
2. Press f4 key to display the property window.
3. In data source property, select the name of the connection control (here it is Adodc1)
4. To display a given field, put the field name in « DataField »

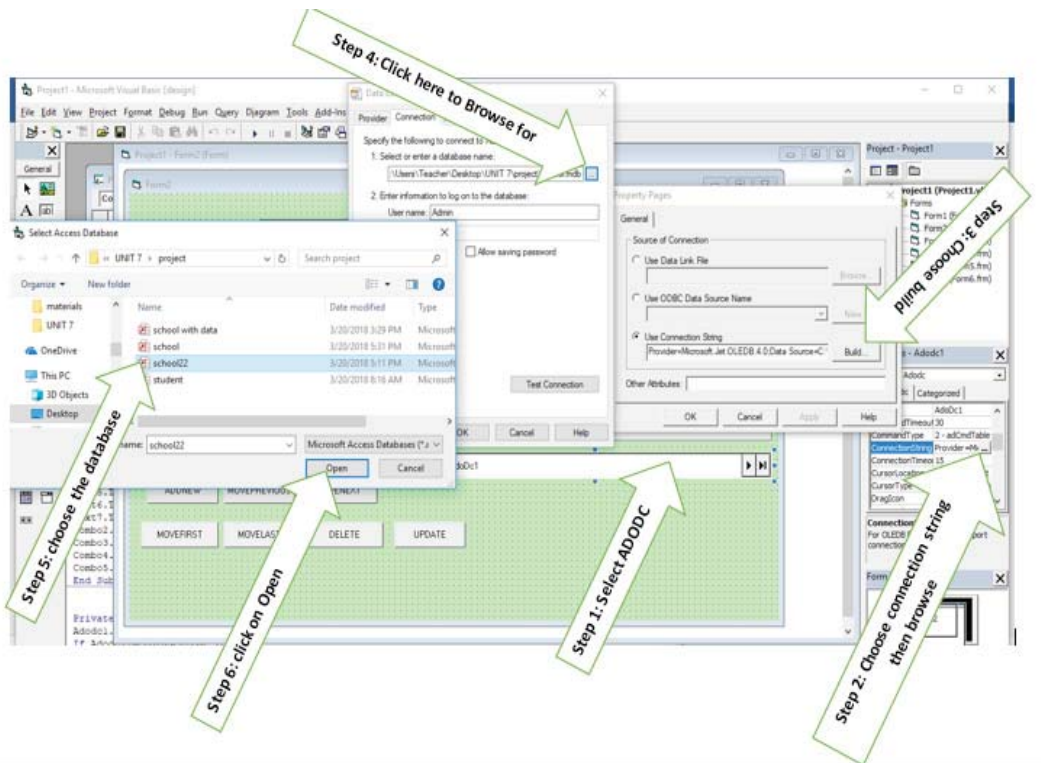

Use of methods

Add record into a database

b. To add a record into a database we use the method AddNew.

Syntax: Controlname.RecordSet.AddNew

Ex. Adodc1.RecordSet.AddNew

c. Delete a record

To delete a record we use delete method:

```
Private Sub CmdDelete_Click()
```

```
Adodc1.RecordSet.Delete
```

```
End Sub
```

To prevent the display of blank record, we move the record:

```
Private Sub CmdDelete_Click()
```

```
Adodc1.Recordset.Delete
```

Adodc1.Recordset.MoveNext' prevent the error in case a record is not available

End sub

d. Refresh method

Refresh method is used to refresh database data; it allows to update the controls according to the new values of the fields of a table.

Ex. *Adodc1.Refresh*

e. Update database fields

To modifying a database fields, you have to use the update method

Private Sub CmdUpdate_click()

Adodc1.UpDateRecord or

Adodc1.Update

End Sub

f. MoveNext method

Put the record pointer to the next record

Private Sub CmdNext_Click()

Adodc1.Recordset.MoveNext

End sub

g. MovePrevious method

Put the pointer on the previous method

Private Sub CmdPrevious_Click()

Adodc1.Recordset.MovePrevious

End Sub

h. MoveFirst method

Put the pointer on the first record of the database

Private sub CmdFirst_Click()

Adodc1.Recrdset.MoveFirst

End sub

i. MoveLast method

Put the pointer on the last record

```
Private Sub CmdLast_Click()  
Adodc1.Recordset.MoveLast  
End sub
```

Counting the records number

We use the method RecordCount:

```
Private Sub CmdCount_Click()  
Adodc1.Recordset.MoveLast  
MsgBox adodc1.Recordset.RecordCount  
End sub
```

6.6.2. Building the interface and accessing the database

- Interface is required to access a related database in order a user can add, modify, retrieve data and so many other interactions.
- Drawing the interface, you have to set properties and then coding
- You have to add the data control to connect your database.
- Now let us add data control to be used to connect database with the following steps below:
- Create a database in Microsoft access and an interface in visual basic6.0 then try to access it from VB form interface.
- Name your database created in Microsoft access for example name it "school"
- Create three tables named for example Table1, Table2 and Table. Fill your database in Table1 with the fields: RegNo, First name, Last name, Gender, Mother's name, Father's name, ID/Passport, Province, District, Sector, Option and class respectively.
- Using visual basic 6.0, draw the interface for your tables with the following controls:
- 12 labels (RegNo, First name, Last name, Gender, Mother's name, Father's name, ID/Passport, Province, District, Sector, Option and class)
- 12text boxes RegNo, First name, Last name, Gender, Mother's name, Father's name, ID/Passport, Province, District, Sector, Option and class)
- Eight command buttons for Add, Delete, Next, Previous, Top, Bottom, Update, and Exit.

Below is VB form that contains all above command buttons. Connect it with your

created database and access all information from school database and do the same for your own basing on created database through SRS. Below are codes that will guide you.

STUDID	FAMILY NAME	OTHER_NAME	GENDER	MOTHER_NAME	FATHER_NAME
1	Gato	Sylvain		Mugabo Peter	Uwimana Justine
5	Uwimana	Claudine	F	Mukamana	Kalisa
6	Pefer	Nkundausoma	F	Micomviza	Rukundo

a. Set properties for the text box

- Data field=name of the field (for this example it is Table2)
- Setting properties for the combo box
- Data source=data control name (for the example above, data control name is Adodc1)
- Data field=name of the field (depending on the name of field in you want to be displayed in database)

1. Codes for combo box (Gender)

Double click the form and write the following codes:

```
Private Sub Form_Load ()
Combo1.AddItem "Male"
Combo1.AddItem "Female"
End Sub
```

Note: You may edit the name `combo1.AddItem` to `cmbgender` or other name you

want.

1. Codes for command buttons

- **Command “Add”**

```
Private Sub cmdadd_Click()  
Data1.Recordset.AddNew  
End Sub
```

Command “Update”

```
Private Sub cmdupdate_Click()  
Data1.Recordset.Update  
End Sub
```

- **Command “Bottom”**

```
Private Sub cmdbottom_Click()  
Data1.Recordset.MoveLast  
End Sub
```

- **Command “Top”**

```
Private Sub cmdtop_Click()  
Data1.Recordset.MoveFirst  
End Sub
```

- **Command “Exit”**

```
Private Sub cmdexit_Click()  
Unload Form1  
End Sub
```

```
Private Sub cmdexit_Click()  
Unload me  
End Sub
```

or

```
Private Sub cmdexit_Click()  
end  
End Su
```

- **Command “Next” (using Data1)**

```
Private Sub cmdnext_Click()  
Data1.Recordset.MoveNext  
If Data1.Recordset.EOF Then  
Data1.Recordset.MovePrevious  
End If End Sub
```

- **Command “Next” (using Adodc1)**

```
Private Sub Command2_Click()  
Adodc1.Recordset.MoveNext  
If Adodc1.Recordset.EOF Then  
Adodc1.Recordset.MovePrevious  
MsgBox “you are at the end”  
End If  
End Sub
```

- **Command “Previous” (using Data1)**

```
Private Sub cmdprevious_Click()  
Data1.Recordset.MovePrevious  
If Data1.Recordset.BOF Then  
Data1.Recordset.MoveNext  
End If End Sub
```

- **Command “Previous” (using Adodc1)**

```
Private Sub Command3_Click()  
Adodc1.Recordset.MovePrevious  
If Adodc1.Recordset.BOF Then  
Adodc1.Recordset.MoveNext  
MsgBox “you are at the end”  
End If  
End Sub
```

- **Command “Delete”**

```
Private Sub cmddelete_Click()  
If MsgBox("Are you sure?", vbQuestion + vbYesNo,  
"Deleting") = vbYes Then  
Data1.Recordset.Delete  
Data1.Recordset.MoveNext  
End If  
End Sub
```

- **Command “Find”**

```
Private Sub cmdfind_Click()  
find = InputBox("Enter parent_id")  
.With Data1.Recordset  
.Index = "primarykey" .Seek "=", find  
End With  
End Sub
```

6.7. PROJECT 7: PRINCIPLES FOR DESIGNING A FRIENDLY AND ERGONOMIC USER INTERFACE

Designing a good user interface is an iterative process. There are appropriate techniques to use during the designing and implementation of a user interface. For good looking and being attractive, the user interface should be SMART so that every designed screen should support single action of real value to the users. This should make it easier to learn, use, add, delete and other interactions for users.

a. Principles of a friendly user interface.

The following table is showing the main principles of a friendly user interface. Each programmer should keep it as a bible to consult during the development of applications in different Programming Languages.

Principles	Explanations
Consistency	The buttons must be placed in consistent places on all windows. The same wording in labels and messages, and a consistent color scheme throughout have to be used. Consistency in user interface allows users to build an accurate mental model of the way that it works
The messages and labels have to be worded appropriately	the displayed text on the screens is a primary source of information for the users. If a is worded poorly then the interface will be perceived poorly by the users. Using full words and sentences, as opposed to abbreviations and codes makes the text easier to understand.
The looking at other applications 'interface must be careful	Never think that another application is doing things right. Unless it follows the user-interface standards and guidelines. is. Although it is always a good idea to look at the work of others to get ideas, it is imperative to know how to distinguish between good user-interface design and bad user-interface design. Too many developers make the mistake of imitating the user interface of another application that was poorly designed
Use color appropriately	Color should be used sparingly in applications. The problem is that some of the users may be color blind. Also, color generally does not port well between platform. What looks good on one system often looks poor on another system. Many people have been to presentations where the presenter said "it looks good on my machine athome."

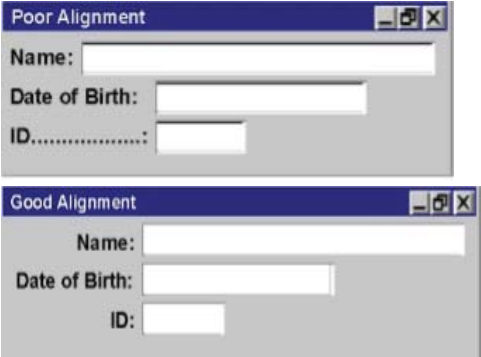
<p>Follow the contrast rule</p>	<p>During the use of color in application, there is a need to ensure that the screens are still readable. The best way to do this, is to follow the contrast rule: Use dark text on light backgrounds and light text on dark backgrounds. It is very easy to read blue text on a white background but very difficult to read blue text on a red background. The problem is that there is not enough contrast between blue and red to make it easy to read, whereas there is a lot of contrast between blue and white.</p>
<p>Choosing of appropriate Fonts</p>	<p>Fonts are also an important part of a user interface. because they often communicate important information to the user. the Fonts that will be easily readable at different resolutions and on different types of displays have to be selected. Wrong choice of font will not facilitate users to read unless there are standard Windows fonts such as New Times Roman, Arial, Georgia, Calibri etc. It is advisable not to use more than two fonts at two or three different point sizes in a single application. Too many fonts can leave your application looking like a monstrous note.</p>
<p>Alignment of fields on the screen</p>	<p>When a screen has more than one editing field, the fields must be organized in a way which is both visually appealing and efficient. Look at the following</p>  <p>The image shows two screenshots of a form titled 'Poor Alignment' and 'Good Alignment'. In the 'Poor Alignment' screenshot, the labels 'Name:', 'Date of Birth:', and 'ID.....:' are left-aligned, but the input fields are not aligned with their respective labels. In the 'Good Alignment' screenshot, the labels are right-aligned and the input fields are left-aligned, creating a clean and organized layout.</p>

Justify data appropriately	For columns of data it is common practice to right justify integers, decimal align floating point numbers, and left justify strings.
Do not create busy screens	<p>Crowded screens are difficult to understand and hence are difficult to use</p> <p>The programmer should understand what the user will be doing with the application. If he/she can think like a user, he/she can create a much better user interface.</p>

b. Principles for an ergonomic user interface

Ergonomics derives from two Greek words: ergon, meaning work, and nomoi, meaning natural laws, to create a word that means the science of work and a person’s relationship to that work. Ergonomics is a field of study that attempts to reduce strain, fatigue, and injuries by improving product design and workspace arrangement. It makes things comfortable and efficient. It is intended to maximize productivity by reducing operator fatigue and discomfort. Human characteristics, such as height, weight, and proportions are considered, as well as information about human hearing, sight, temperature preferences, and so on, in order to reduce or eliminate factors that cause pain or discomfort

There are five aspects of ergonomics: safety, comfort, ease of use, productivity/performance, and aesthetics. Based on these aspects of ergonomics, examples are given of how products or systems could benefit from redesign based on ergonomic principles.

- i. **Safety:** This has to do with the ability to use a device or work with a device without short or long term damage to parts of the body.
- ii. **Comfort:** Comfort in the human-machine interface is usually noticed first. Physical comfort in how an item feels is pleasing to the user.
- iii. **Ease of use:** This has to do with the ability to use a device with no stress
- iv. **Productivity/performance:** Ergonomics addresses the performance of user interface by providing more options to the users, enabling them to easily and quickly skip some instructions as users’ choice.
- v. **Aesthetics:** Signs in the workplace should be made consistent throughout the workplace to not only be aesthetically pleasing, but also so that information is easily accessible.

Project 6 activity

Improve your project by taking into consideration the principles of a friendly user interface and an ergonomic user interface above.



UNIT 7

PROCESS MANAGEMENT AND SCHEDULING ALGORITHM

UNIT 7: PROCESS MANAGEMENT AND SCHEDULING ALGORITHM

Key Unit Competency: To be able to explain how processes are managed by Operating System and to understand process scheduling algorithms

INTRODUCTORY ACTIVITY

Open MS EXCEL, type your school name and save the file as “my school”.

Press a combination of CTRL +ALT+ Delete.

Go to the Task Manager.

Click on Processes Tab and answer the following questions:

- What processes are running?
- Describe what is displayed in the table.
- Right Click on Microsoft EXCEL, Click on End Task. What do you observe? Is MS Excel still open or not? Why?

7.1 PROCESS

Learning activity 7.1.

Read the following text and answer the questions below.

There are two categories of programs. Application programs (usually called just "applications") are programs that people use to get their work done. Computers exist because people want to run these programs. System programs keep the hardware and software running together smoothly. The most important system program is the operating system. The operating system is always present when a computer is running. It coordinates the operation of the other hardware and software components of the computer system. The operating system is responsible for starting up application programs, running them, and managing the resources that they need. When an application program is running, the operating system manages the details of the hardware for it. For example, when you type characters on the keyboard, the operating system determines which application program they are intended for and does the work of getting them there.

- How do you call a program which is running in your computer?
- Through the interface obtained after combining CTRL+ALT+DELETE, which programs are running? What are their differences?
- Write down which ones are consuming a lot of memory space.

7.1.1. Definition

A process is a program in execution. It is an instance of program execution and it is not as same as program code but a lot more than it. A process is an 'active' entity as opposed to program which is considered to be a 'passive' entity. Attributes held by process include hardware state, memory, CPU etc.

The 4 sections in which the process is divided are:

- **Text:** This is the set of instructions, the compiled program code, read in from non-volatile storage, to be executed by the process.
- **Data:** this is the data used by the process when executing. It is made up the global and static variables, allocated and initialized prior to executing the main.
- **Heap of resources:** These are physical or virtual components of limited availability within a computer system that are needed by the process for its execution. They include CPU time, memory (random access memory as well as virtual memory), secondary storage like hard disks and external devices connected to the computer system. The heap is managed via calls to new, delete, malloc, free, etc.
- **Stack:** It is used for local variables. Space on the stack is reserved for local variables when they are declared.

The figure below shows the four sections of a process in memory for efficient working:

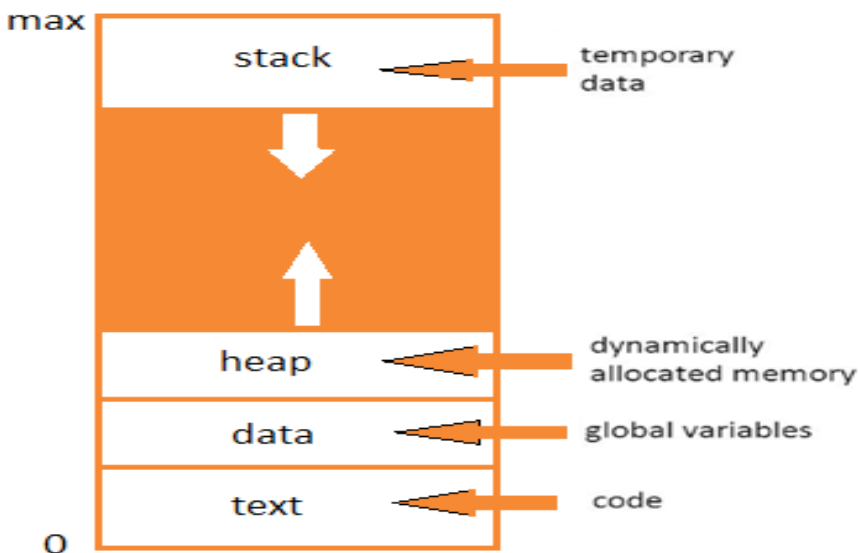

Figure 7.1.: A process in memory

7.1.2. Process execution requirement

A process in execution needs resources like the Central Processing Unit (CPU), memory and Input/output devices. In current computers, several processes share Resources where one processor is shared among many processes. The CPU and the input/output devices are considered as active resources of the system as they provide input and output services during a finite amount of time interval while the memory is considered as passive resource.

A process is executed by a processor through a set of instructions stored in memory. This instruction processing consists of two stages: The processor reads (fetches) instructions from the memory one after another and executes each instruction. Process execution consists of a number of repeated steps of fetching the process instruction and the instruction execution. The execution of a single instruction is called an instruction cycle. Graphically, it is shown by the figure below:

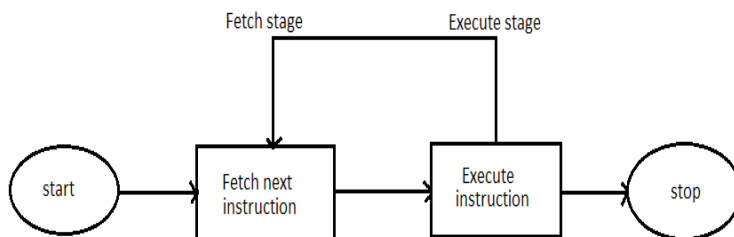

Figure 7.2. Process execution

7.1.3. Process vs. program

The major difference between a program and a process is that a program is a set of instructions to perform a designated task whereas the process is a program in execution. A process is an active entity because it involves some hardware state, memory, CPU etc. during its execution while a program is a passive entity because it resides in memory only. The differences between a program and a process are summarized in the table below:

Program	Process
A program consists of a set of instructions in a programming language	A process is a sequence of instructions in execution.
A program is a static object that exists in a file.	A process is a dynamic object i.e. a program in execution.
A program is in the secondary storage.	A process is loaded into the main memory.
The time span of a program is unlimited meaning that as long as the program is open it is considered to be running even though it is idle.	The time span of a process is limited.
A program is a passive entity which exists in the secondary storage persistently even if the machine reboots.	A process is an active entity since it is always stored in the main memory and disappears if the computer's power is switched off or has finished executing.

Table 1: differences between a program and a process

7.1.4. Process states

When a process executes, it changes the states whereas a process state is defined as the current activity of the process. A process can be in one of the following five states.

- a. **New:** This is the initial state when a process is first created but it has not yet been added to the pool of executable processes.
- b. **Ready:** At this state, the process is ready for execution and is waiting to be allocated to the processor. All ready processes are kept in a queue and they keep waiting for CPU time to be allocated by the Operating System in order to run. A program called scheduler picks up one ready process for execution.
- c. **Running:** At this state, the process is now executing. The instructions within a process are executed. A running process possesses all the resources needed for its execution i.e. CPU time, memory (random access memory as well as virtual memory), secondary storage like hard disks and external devices connected to the computer system. As long as these resources are not available a process cannot go in the running state.
- d. **Waiting:** a process is waiting for some event to occur before it can continue execution. The event may be a user input or waiting for a file to become available.
- e. **Terminated:** This is when a process finishes its execution. A process

terminates when it finishes executing its last statement. When a process terminates, it releases all the resources it had and they become available for other processes.

So a process can be in one of these five states. Its model is also known as five state model and is shown below:

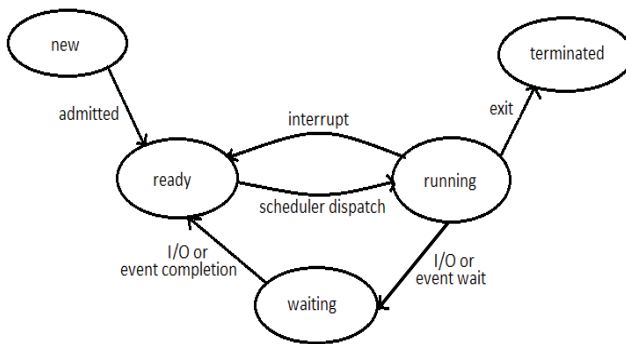

Figure 7.3: process states diagram

7.1.5. Process control block (PCB)

A Process Control Block is a data structure maintained by the Operating System for every process. It is also called Task Control Block and it is storage for information about processes.

When a process is created, the Operating System creates a corresponding PCB and when the process terminates, its PCB is released to the pool of free memory locations from which new PCBs are made. A process can compete for resources only when an active PCB is associated with it.

The table below shows the contents of a PCB with their meanings.

Contents	Meaning
Process ID	This is a unique process number that identifies each process
Process State	This indicates the current state of the process i.e., new, ready, running, waiting and terminated.
Pointer	This is a pointer to parent process. A parent process is a process that creates another process.

Program counter	Program Counter contains the address of the process next instruction to be executed.
CPU registers	These include the accumulator and index registers. Whenever a processor switches from one process to another, the information about the current status of the old process is saved in the register along with the program counter so that the process can be allowed to continue correctly afterwards.
I/O status information	This includes the names of I/O devices used by a process, list of open files and the information about allocation of peripheral devices to a process.
Accounting information	This includes the actual CPU time used in executing a process.
Processor scheduling details	It includes the priority of a process and the address to scheduling queues.

Table 2: Contents of a PCB with their meanings

APPLICATION ACTIVITY 7.1.

1. Do the following question
 - a. Describe what a process is? How does it differ from a program?
 - b. Describe in brief the structure of a Process Control Block.
 - c. Draw a labeled diagram for the process state transitions and explain the different process states.
 - d. What are the top 5 programs that are frequently used at your school?
2. Answer the following questions by true or false:
 - a. A process in the running state is currently being executed by the CPU.
 - b. The process control block (PCB) is a data structure that stores all information about a process.
 - c. CPU scheduling determines which programs are in memory.

7.2. THREAD

Learning Activity 7.2.

Visit the internet and make research and answer the following questions:

- What is a thread? How does it differ from a process?
- Explain the 2 types of threads

7.2.1. Definition of a Thread

A thread is the smallest unit of processing that can be performed in an Operating System. A thread is also called a lightweight process. Threads provide a way to improve application performance through parallelism.

In traditional operating systems, each process has an address space and a single thread of control. However, there are situations in which it is desirable to have multiple threads of control that share a single address space, but run in quasi-parallel, as though they were in fact separate processes.

Each thread belongs to exactly one process and no thread can exist outside a process. Threads provide a suitable foundation for parallel execution of applications on shared memory multiprocessors.

Multiple threads can be executed in parallel on many computer systems. This multithreading generally occurs by time slicing, wherein a single processor switches between different threads. For instance, there are some PCs that contain one processor core but you can run multiple programs at once, such as typing in a document editor while listening to music in an audio playback program; though the user experiences these things as simultaneous, in truth, the processor quickly switches back and forth between these separate processes.

The following figure shows the working of a single-threaded and a multithreaded process:

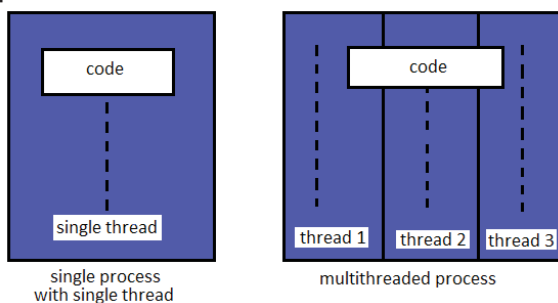

Figure 7.4: single and multithreaded processes

7.2.2 Difference between thread and process

A thread has some similarities to a process. Threads also have a life cycle, share the processor and execute sequentially within a process.

However there are differences as shown in the table below:

Process	Thread
Process cannot share the same memory	Threads can share memory and files.
Process creation is time consuming	Thread creation is not time consuming
Process execution is very slow	Thread execution is very fast
It takes more time to terminate a process	It takes less time to terminate a thread
It takes more time to switch between two processes.	It takes less time to switch between two threads.
Communication between processes is difficult	Communication between threads is easy and efficient.
It is a heavy weight process as it requires more resources.	It is a light weight process as it requires fewer resources.
They are not suitable for exploiting parallelism	They are suitable for exploiting parallelism
Process is bigger compared to a thread and one process may have many threads	A thread is smaller and is part of a process. Many related threads make up a process

Table3: Difference between thread and process

7.2.3 Types of threads

There are 2 types of threads namely User- level threads and Kernel level threads.

A. User - level threads

This type of thread is loaded in the user space only. The User space refers to all of the code in an operating system that lives outside of the kernel. The kernel does not know anything about them. When threads are managed in the user space, each process must have its own thread table. The thread table consists of the information

on the program counter and registers. This is shown in the figure 7.5 below:

Advantages of user - level threads:

- a. Each process can have its own process scheduling algorithm. This will be discussed later in the unit.
- b. User level threads can run on any Operating System.
- c. Faster switching among threads is possible.

Disadvantages of User-level threads

- a. When a user level thread executes a system call, not only that thread is blocked but also all the threads within the process are blocked. This is possible because the Operating System is unaware of the presence of threads and only knows about the existence of a process that constitutes these threads. A system call is a way for user programs to request some service from Operating System.
- b. Multithreaded application using user-level threads cannot take advantage of multiprocessing since the OS is unaware of the presence of threads and it schedules one process at a time.

B. Kernel-Level Threads

These are threads that are managed by the Operating System. There is no thread table in each process as the case of user level threads. The kernel only has the thread table. The thread table keeps track of all the threads in the system. The kernel's thread table holds each thread's registers and state. The information at the kernel level threads is the same as that at the user - level threads but the difference is that the information at the kernel - level is stored in the kernel space and at the user level thread; information is stored in the user space. Kernel space is part of the OS where the kernel executes and provides its services. This is shown in figure 7.5b below.

Advantages of Kernel level threads

- a. The OS is aware of the presence of threads in the processes. If one thread of a process gets blocked, the OS chooses the next one to run either from the same process or from a different one. A thread is blocked if it is waiting for an event, such as the completion of an I/O operation.
- b. It supports multiprocessing. The kernel can simultaneously schedule multiple threads from the same process on multiple processors

Disadvantages of Kernel level threads:

- The kernel-level threads are slow and inefficient. For instance, threads operations are hundreds of times slower than that of user-level threads.
- Since kernel must manage and schedule threads as well as processes. Switching between them is time consuming.

The figure below shows user level and kernel level threads

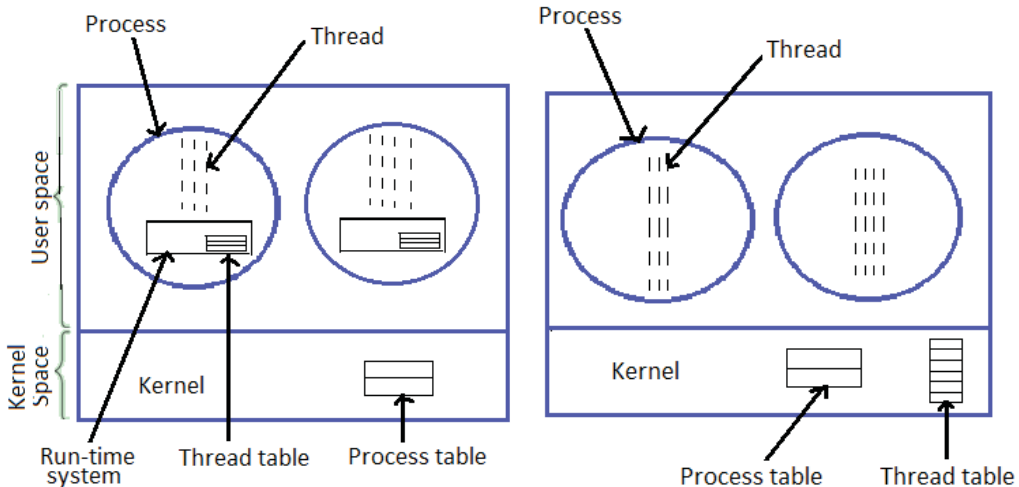

Figure 7.5a: User level thread

Figure 7.5b: Kernel level thread

Difference between User-Level and Kernel-Level Threads

Considering the above explanations of the 2 types of threads, the following table summarizes the differences between them.

User-Level Threads	Kernel-Level Threads
User-level threads are faster to create and manage.	Kernel-level threads are slower to create and manage.
Implementation is by a thread library at the user level.	Operating system supports creation of Kernel threads.
User-level thread is generic and can run on any operating system.	Kernel-level thread is specific to the operating system.
Multi-threaded applications cannot take advantage of multiprocessing.	Kernel level threads support multiprocessing.

Table 4: Difference between User-Level and Kernel-Level Threads

7.2.4 Advantages and disadvantages of threads

The advantages and disadvantages of threads are presented in the table below:

Advantages	Disadvantages
<p>There is efficient communication because they do not need to use interprocess communication.</p> <p>Threads allow utilization of multiprocessor architectures to a greater scale and efficiency.</p> <p>They only need a stack and storage for registers therefore, threads are cheap to create.</p> <p>Threads use very little resources of an operating system in which they are working. That is, threads do not need new address space, global data, program code or operating system resources.</p> <p>Context switching is fast when working with threads. Context switching is the procedure of storing the state of an active thread or process for the CPU when it has to start executing a new one.</p> <p>Use of threads provides concurrency within a process.</p>	<p>Blocking: if the kernel is single threaded, a system call of one thread will block the whole process and CPU may be idle during the blocking period.</p> <p>Security: Since there is, an extensive sharing among threads there is a potential problem of security. It is quite possible that one thread over writes the stack of another thread (or damaged shared data) although it is very unlikely since threads are meant to cooperate on a single task.</p>

Table 5: Advantages and disadvantages of threads

Application Activity 7.2.

Answer the following questions:

1. What are benefits of threads?
2. Discuss the advantages and the disadvantages of
 - a. User level thread
 - b. Kernel level thread

7.3. PROCESS SCHEDULING

Learning Activity 7.3.

During his working session on his computer in the School laboratory, the Laboratory Technician was doing many activities at the same time. By working with his text in Microsoft Word, he was also chatting with his friends on WhatsApp and also listening to his preferred Hip hop songs.

- i. What allowed him to do three activities at the same time on only one computer?

7.3.1 Definition of process scheduling

Process scheduling refers to the order in which the resources are allocated to different processes to be executed. Process scheduling is done by the process manager by removing running processes from the CPU and selects another process on the basis of a particular strategy.

7.3.2 Scheduling Queue

The scheduling queue is a queue that keeps all the processes in the Operating System. The Operating System maintains a separate queue for each of the process states and PCBs of all processes in the same execution state are placed in the same queue. When the state of a process is changed, its PCB is unlinked from its current queue and moved to its new state queue.

The Operating System maintains the following process scheduling queues:

- **Job queue:** this queue keeps all the processes in the system.
- **Ready queue:** this queue keeps a set of all processes residing in main memory, ready and waiting to be executed. A new process is always put in this queue.
- **Device queues:** the processes which are blocked due to unavailability of an I/O device constitute this queue.

The scheduling queues are shown in the figure below:

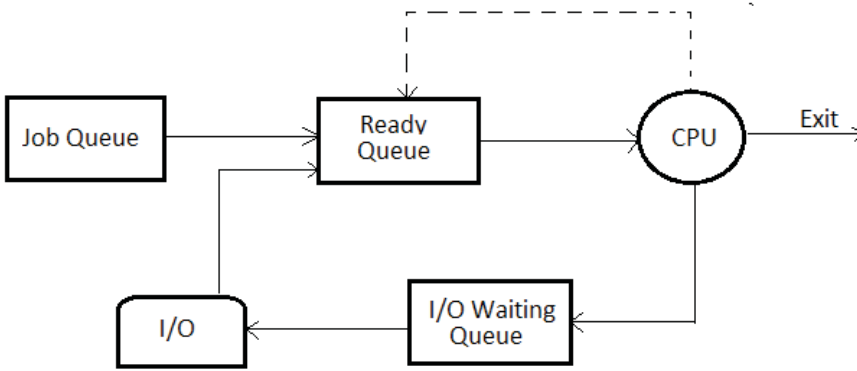

Figure 7.6: Process Scheduling Queues

All the processes entering into the system are put in a queue, called the **job queue**. The processes in the main memory that are ready and waiting for their chance to get executed are put in the queue called the **ready queue**.

It is common that a process undergoing execution may be interrupted temporarily, waiting for some other job to occur like completion of an I/O operation. All such waiting processes are put in a queue called a **device queue**.

A new process enters the ready queue and waits for its execution at the time it is allocated to a CPU.

7.3.4. Process State Model

A process can be in two main states namely running and not running. It is also called “the two process state model”. “The two process state model “is the model where two main states of the process i.e. running and not running are considered.

The two state process model is shown in the figure below:

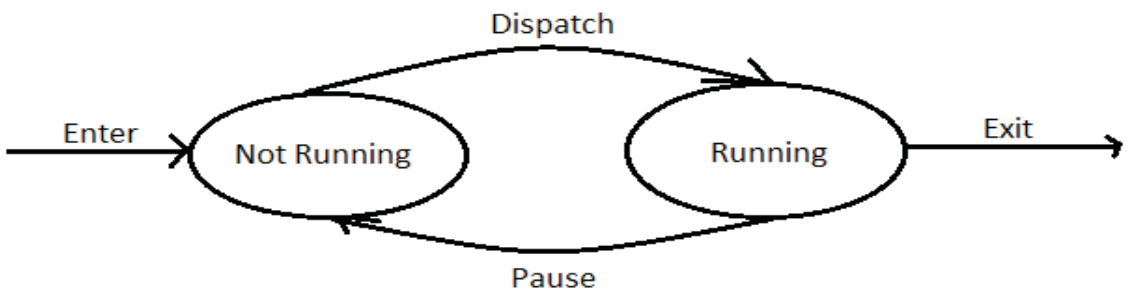

Figure 7.7: Two state process model

Suppose a new process P1 is created, then P1 is in Not Running state. When the CPU becomes free, the Dispatcher gives control of the CPU to P1 that is in Not Running state and waiting in a queue.

The Dispatcher is a program that gives control of the CPU to the process selected by the CPU scheduler.

When the dispatcher allows P1 to execute on the CPU, then P1 starts its execution. Therefore P1 is in running state. If a process P2 with high priority wants to execute on CPU, then P1 should be paused or P1 will be in the waiting state and P2 will be in the running state. When P2 terminates, then P1 again allows the dispatcher to execute it on the CPU.

However there can be abnormalities in the running of processes whereby they block one another. This situation is called **deadlock**.

7.3.4.1. Deadlock

A deadlock is a situation where a process or a set of processes are blocked, waiting for some resource that is held by some other waiting processes. Here a group of processes are permanently blocked as a result of each process having acquired a subset of the resources needed for its completion and waiting for the release of the remaining resource held by other processes in the same group. This makes it impossible for any of the processes to proceed.

A deadlock can be compared to a traffic jam illustrated below:



Figure 7.8: Traffic jam in Kigali City

Coffman (1971) identified four (4) conditions that must hold simultaneously for a deadlock to occur:

- a. Mutual Exclusion: a resource can be used by only one process at a time. If another process requests for that resource then the requesting process must be delayed until the resource becomes released.
- b. Hold-and-Wait: in this condition a process is holding a resource already allocated to it while waiting for an additional resource that is currently being held by other processes.
- c. No preemption: resources granted to a process can be released back to the system after the process has completed its task.
- d. Circular wait: the processes in the system form a circular list or chain where each process in the list is waiting for a resource held by the next process in the list. This is shown in the figure below:

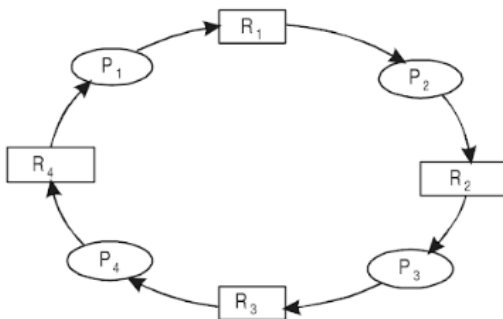

Figure 7.9.: Circular wait

7.3.5. Schedulers

A scheduler is an operating system program that selects the next job to be admitted for execution.

Schedulers are of three types namely: Long-Term Scheduler, Short-Term Scheduler and Medium-Term Scheduler.

a. Long-Term Scheduler

It is responsible for selecting the processes from secondary storage device like a disk and loads them into main memory for execution. It is also called a **job scheduler**. The reason why it is called a long term scheduler is because it executes less frequently as it takes a lot of time for the creation of new processes in the system.

b. Short-Term Scheduler

This scheduler allocates processes from the ready queue to the CPU for immediate processing. It is also called as **CPU scheduler**. Its main objective is to maximize CPU utilization. Short-term schedulers, also known as **dispatchers**. The dispatcher is the module that gives control of the CPU to the process selected by the short-term scheduler. Short-term schedulers are faster than long-term schedulers. They execute at least once every 10 millisecond.

c. Medium Term Scheduler

Medium-term scheduler removes the processes from the memory (swapping). A running process may become suspended if it makes an I/O request therefore it cannot make any progress towards completion. In order to remove the process from memory and make space for other processes, the suspended process is moved to the secondary storage. This process is called **swapping**, and the process is said to be swapped out or rolled out. The medium-term scheduler is in charge of handling the swapped out processes.

The working of the medium term scheduler is shown below:

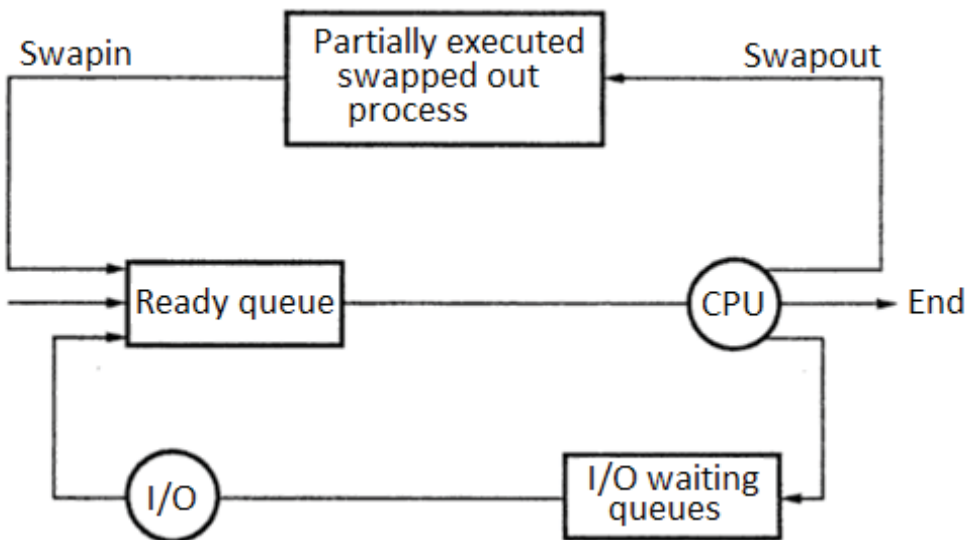

Figure 7.10.: Working of the medium term scheduler

The Comparison of the three different types of schedulers is summarized in the following table.

Long-Term Scheduler	Short-Term Scheduler	Medium-Term Scheduler
It is a job scheduler	It is a CPU scheduler	It is a process swapping scheduler.
Speed is lesser than short term scheduler	Speed is fastest among other two	Speed is medium in between both short and long term scheduler.
It controls the degree of multiprogramming	It provides lesser control over the degree of multiprogramming	It reduces the degree of multiprogramming.
Process state is (New to Ready)	Process state is (Ready to Running)	_____
It selects processes from pool and loads them into memory for execution	It selects those processes which are ready to execute.	It can re-introduce the process into memory and execution can be continued.

Table 6: Comparison of schedulers

Application Activity 7.3.

Choose the suitable word(s) in bold to fill the following blanks:

- An instance of a program execution is called _____ (**Process**, **Instruction**, **Procedure**, **Function**)
- A scheduler which selects processes from secondary storage device is called _____ (**Short term scheduler**, **Long term scheduler**, **Medium term scheduler**, **Process scheduler**).
- The _____ is used as the repository for any information of the process. (**Process state**, **deadlock**, **CPU**, **PCB**).
- _____ is the module that gives control of the CPU to the process selected by the short term scheduler. (**Dispatcher**, **processor**, **aging**).
- _____ Scheduler select the process that is in the ready queue to execute and allocate the CPU to it. (**Short term scheduler**, **Long term scheduler**, **Medium term scheduler**, **dispatcher**).

7.3.4. PROCESS SCHEDULING ALGORITHMS

Learning Activity 7.4.

1. Open multiple applications Microsoft WORD, Microsoft EXCEL and one used Browser. Observe on the Task Manager which one is coming first in the applications list? Explain why?
2. On the Performance Tab, click on Resource Monitor and explain why the order of processes available is changing dynamically?
3. What does the computer base on to place a process at the top and other in middle?

Process scheduling algorithms are procedures used by the job scheduler to plan for the different processes to be assigned to the CPU.

Objectives of Process Scheduling Algorithms

- Maximization of CPU utilization by keeping the CPU as busy as possible.
- Fair allocation of CPU to the processes.
- To maximize the number of processes that complete their execution per time unit. This is called throughput.
- To minimize the time taken by a process to finish its execution.
- To minimize the time a process waits in ready queue.
- To minimize the time it takes from when a request is submitted until the first response is produced.

There are 5 scheduling algorithms used by the process scheduler and they include the following:

- First-Come, First-Served (FCFS) Scheduling
- Shortest-Job-First (SJF) Scheduling
- Priority Scheduling
- Round Robin (RR) Scheduling
- Multiple-Level Queue Scheduling

The above mentioned algorithms are either **non preemptive or preemptive**. Non-preemptive algorithms means that once a process enters the running state, it cannot be preempted until it completes its allocated time. The preemptive scheduling means that a scheduler may preempt a low priority running process anytime when a high priority process enters into a ready state.

7.4.1. First Come, First-Served (FCFS) Scheduling

The basic principle of this algorithm is to allocate processes to the CPU in their order of arrival. FCFS is a non-preemptive scheduling algorithm. This algorithm is managed with a First in First out (FIFO) queue. It is non-preemptive because the CPU has been allocated to a process that keeps it busy until it is released.

When a process enters the ready queue, its process control block (PCB) is linked onto the tail of the queue. When the CPU is done executing a process and is free, the job scheduler selects from the head of the queue. This results into poor utilization of resources in the computer since it cannot utilize resources in parallel. When a set of processes need to use a resource for a short time and one process holds resources for a long time, it blocks all other processes leading to poor utilization of resources.

Key Terms:

- CPU Burst time: this is the time required to complete process execution in the CPU.
- Arrival time: this is the time at which the process arrives in the ready queue.
- Gantt chart: A Gantt chart is a horizontal bar chart illustrating process schedule.
- Completion time: This is the time at which process completes its execution.
- Wait Time: This is the time a process waits in the ready queue.
- Waiting Time = Completion time - Burst Time
- Turnaround Time: this is the total time between submission of a process and its completion.
- Turn Around Time = Completion Time - Arrival Time

For example consider the following set of processes with their arrival time and CPU burst time in milliseconds.

Process	CPU Burst Time (ms)	Arrival time
A	24	0
B	3	0
C	3	0

Case 1: When A, B and C arrive in the order A, B, C

The Gantt chart is shown below:



Figure 7.11a: Gantt chart FCFS algorithm

The wait time of each process is calculated as follows:

Wait Time: Completion Time –Burst time

Process	Wait Time
A	0
B	24
C	27

Average Wait Time (AWT) = $(0+24+27) / 3 = 17\text{ms}$

And Average Turnaround Time (ATAT) = $(24+27+30)/3 = 27\text{ms}$

Case 2: When A, B and C arrive in order B, C, A

The Gantt chart is as follows:

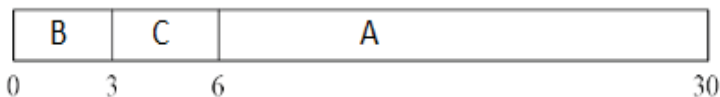

Figure 7.11b: Gantt chart FCFS algorithm

The wait time of each process is calculated as follows:

Wait Time: Completion time - Arrival Time

Process	Wait Time
A	6
B	0
C	3

Average Wait Time (AWT) = $(6+0+3) / 3 = 3\text{ms}$

And Average Turnaround Time (ATAT) = $(3+6+30)/3 = 13\text{ms}$

Case 2 is better than case 1 since AWT of case 2 is smaller than case 1. However the average waiting time under the FCFS algorithm is very long.

7.4.2 Shortest-Job-First (SJF) Scheduling

This is the algorithm that prioritizes the job whose execution time is smaller compared to other jobs already in the ready queue. When the CPU is free, it is assigned to the process of the ready queue which has the smallest CPU burst time. If two processes have the same CPU burst, the FCFS scheduling algorithm is used. SJF may either be preemptive or non preemptive.

Example: a) Non-preemptive SJF

Process	Burst time in ms	Arrival time
A	6	0
B	8	0
C	7	0
D	3	0

Assume the processes arrive in order A, B, C, D.
The Gantt chart is as follows:

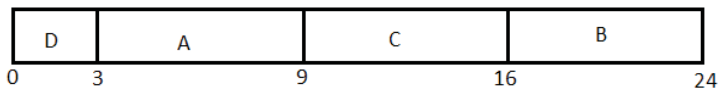

Figure 7.12a: Gantt chart for SJF non preemptive

Process	Wait Time
A	3
B	16
C	9
D	0

The average waiting time is $(0+3+9+16)/4 = 7\text{ms}$

b. Preemptive SJF

Process	CPU Burst	Arrival Time
A	10	0
B	2	2

Assume the processes arrive in the order A, B
The Gantt chart is shown below:

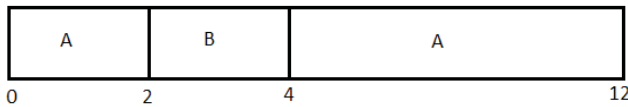

Figure 7.12b: Gantt chart for SJF preemptive

Process	Wait Time
A	$4 - 2 = 2$
B	0

Average waiting time = $(0+2)/2 = 1$ ms

7.4.3. Priority Scheduling

In this algorithm, the CPU is allocated to the highest priority of the processes from the ready queue. Each process has a priority number. If two or more processes have the same priority, then FCFS algorithm is applied.

Priority scheduling can either be preemptive or non-preemptive. The choice is made whenever a new process enters the ready queue while some processes are running. If a newly arrived process has the higher priority than the current running process, the preemptive priority scheduling algorithm preempts the currently running process and allocates the CPU to the new process. On the other hand, the non-preemptive scheduling algorithm allows the currently running process to complete its execution and the new process has to wait for the CPU.

Consider four processes P1, P2, P3 and P4 with their arrival times, required CPU burst (in milliseconds) and priorities as shown in the following table:

Process	P1	P2	P3	P4
Arrival time	0	1	3	4
CPU burst (ms)	7	4	3	2
Priority	4	3	1	2

Assuming that the lower priority number means the higher priority, how will these processes be scheduled according to non-preemptive as well as preemptive priority

scheduling algorithm? Compute the average waiting time and average turnaround time in both cases.

a. Non-preemptive priority scheduling algorithm

The processes will be scheduled as shown in the following Gantt chart:

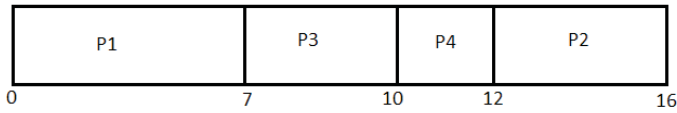

Figure 7.13a: Gantt chart for non-preemptive priority scheduling

Process	Wait Time
P1	0
P2	12-1 = 11
P3	7-3 = 4
P4	10-4 = 6

Average waiting time = $(0+11+4+6)/4 = 5.25\text{ms}$

Average turnaround time = $(7+15+7+8) / 4 = 9.25\text{ms}$

b. Preemptive priority scheduling algorithm

The processes will be scheduled as shown in the Gantt chart below:

Process	P1	P2	P3	P4
Arrival time	0	1	3	4
CPU burst (ms)	7	4	3	2
Priority	4	3	1	2

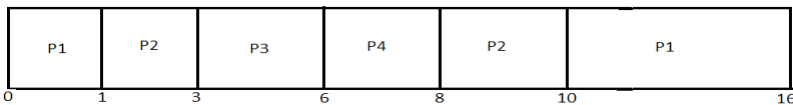

Figure 7.13b: Gantt chart for preemptive priority scheduling

Process	Wait Time
P1	10-1 = 9

P2	$8-2-1=5$
P3	0
P4	$6-4=2$

Average waiting time = $(9+5+0+2)/4 = 4\text{ms}$

Average turnaround time = $(16+9+3+4)/4 = 8\text{ms}$

A priority scheduling algorithm can make some low priority processes wait indefinitely for the CPU causing the problem called **starvation**. Starvation problem is solved by the **Aging** Technique whereby the priority of the processes waiting for a long time in the ready queue is increased.

7.4.4. Round Robin (RR) Scheduling

Round Robin scheduling algorithm is a preemptive algorithm. To implement RR scheduling, ready queue is maintained as a FIFO (First In First Out) queue of the processes. New processes are added to the tail of the ready queue. The CPU scheduler picks the first process from the ready queue and sets a timer to interrupt after 1 time quantum and dispatches the process.

With the RR algorithm, the length of the time quantum is very important. If it is very short, then short processes will be executed very quickly. If it is too large, the response time of the processes is too much which may not be tolerated in interactive environment. Response time is amount of time it takes from when a request is submitted until the first response is produced.

For example:

Process	CPU Burst Time
A	3
B	6
C	4
D	2

Time quantum is 2 milliseconds

The Gantt chart is as follows:

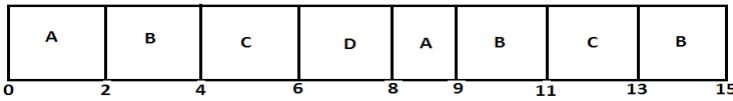

Figure 7.14.: Gantt chart for RR algorithm

The waiting time is calculated as follows:

Process	Waiting time
A	$0+6 = 6$
B	$2+5+2=9$
C	$4+5 = 9$
D	6

Average Wait Time= $(6+9+9+6) / 4 = 7.5\text{ms}$

7.4.5. Multiple-Level Queue Scheduling

In multilevel scheduling, all processes of the same priority are placed in a single queue. The figure 14 below shows the multilevel queue scheduling algorithm. It divides the ready queue into a number of separate queues. The processes are permanently assigned to one queue based on memory size, process priority and process type.

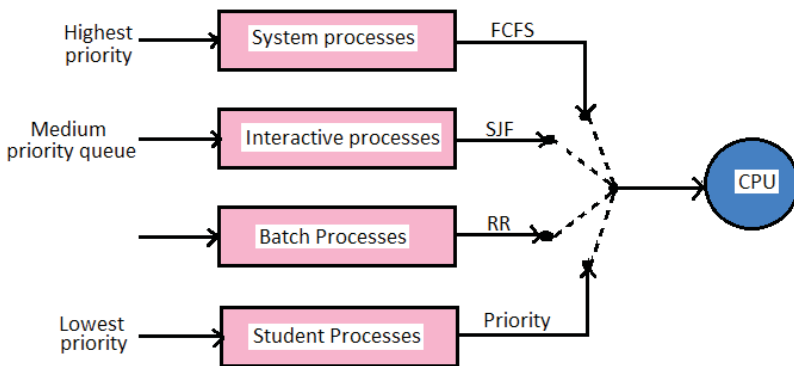

Figure 7.15: Multilevel Queue Scheduling

Each queue has its own scheduling algorithm. One queue may be scheduled by FCFS and another queue by RR method. Once the processes are assigned to the queue, they cannot move from one queue to another.

APPLICATION ACTIVITY 7.4.

Consider the following processes, with the CPU burst time given in milliseconds. The processes are arrived in P1, P2, P3, P4, P5 order of all at time 0.

Process	Burst time	Priority
P1	10	3
P2	1	1
P3	2	3
P4	1	4
P5	5	2

- c. Draw Gantt charts to show the execution using FCFS, SJF, non preemptive priority (small priority number implies higher priority) and RR (quantum =1) scheduling.
- d. What is the waiting time of each process for each one of the above scheduling algorithms?

END OF UNIT ASSESSMENT

Answer the following multiple choice questions.

1. An OS program module that selects the next job to be admitted for execution is called
 - a. Scheduler
 - b. Compiler
 - c. Throughput
 - d. None of the above
2. A short term scheduler executes at least once every
 - a. 1ms
 - b. 10ms
 - c. 5ms
 - d. None of the above
3. A program responsible for assigning the CPU to the process that has been selected by the short term scheduler is known as
 - a. Scheduler
 - b. Dispatcher
 - c. Debugger
 - d. None of the above
4. The indefinite blocking of low priority processes by a high priority process is known as
 - a. Starvation
 - b. Deadlock
 - c. Aging
 - d. None of the above
5. The technique of gradually increasing the priority of processes that wait in the system for a long time is called
 - a. Aging
 - b. Throughput
 - c. FCFS
 - d. None of the above
6. FIFO scheduling is
 - a. Preemptive
 - b. Non preemptive

c. Deadline scheduling

d. None of the above

7. A situation where a process or a set of processes is blocked, waiting for some resource that is held by some other waiting processes:
- Mutual exclusion
 - Hold and wait
 - Deadlock
 - None of the above

II. Answer the following structured questions:

- What do you understand by the following terms?
 - Process
 - Process state
 - Process control block
- Draw a labeled diagram for the process state transitions.
- Explain the following:
 - Short term scheduler**
 - Long term scheduler**
 - Medium term scheduler**
- Compare the process and program.
- What is the role of PCB? List the attributes of PCB.
- What are benefits of threads?
- What are the differences between user level threads and kernel supported threads?
- For the following example, calculate the average waiting time and average turnaround time for the following algorithms.
 - FCFS
 - Preemptive SJF
 - Round Robin (1 time unit)

Process	Arrival time	Burst time
P1	0	8
P2	1	4
P3	2	9
P4	3	5

9. Consider the following set of processes

Process	Arrival time	Burst time
A	0	3
B	1	5
C	3	2
D	9	5
E	12	5

Draw the Gantt chart and calculate the waiting time and the average turnaround time for each of the following scheduling algorithms:

- a. FCFS
 - b. Non preemptive SJF
 - c. Preemptive SJF
10. Differentiate preemptive and non preemptive scheduling giving the application of each of them.
11. Suppose the following jobs arrive for processing at the times indicated. Each job will run the listed amount of time.

Job	Arrival time	Burst time
1	0.0	8
2	0.4	4
3	1.0	1

- a. Give the Gantt chart illustrating the execution of these jobs using the non-preemptive FCFS and SJF scheduling algorithm.
 - b. What is the wait time of each job for the above algorithm?
12. For the following set of processes, find the average waiting time using Gantt chart for
- a. SJF
 - b. Priority scheduling

Process	Burst time	Priority
P1	5	5
P2	3	4
P3	8	3
P4	2	1
P5	1	2

The processes have arrived in the order P2, P1, P4, P3 and P5.



UNIT 8

FILE MANAGEMENT

UNIT 8: FILE MANAGEMENT

Key unit competency

To be able to describe role of operating system in file management and explain file management.

Introductory Activity

Switch on your computer, open a new document of Microsoft word and type the following text: "The price of success is hard work, dedication to the job at hand, and the determination that whether we win or lose, we have applied the best of ourselves to the task at hand."Vince Lombardi

Save the text on the desktop, then answer the following questions:

1. Why is it important to save the document?
2. As you have saved the document on the hard disk, can you give the location (physical address) precisely where it is saved on the Hard Disk?
3. Discuss what happens when you save 2 documents having the same name?
4. Give the difference between document, file and folder?
5. List and explain properties of the saved document?
6. Explain why application software has different icons while folders always have the same icon?
7. Discuss precautions to protect your document from deletion and editing by unauthorized persons?
8. What are the file systems used by operating systems?

8.1. Understanding computer file

Learning Activity 8.1.

1. Observe carefully the figure below and respond to the asked question

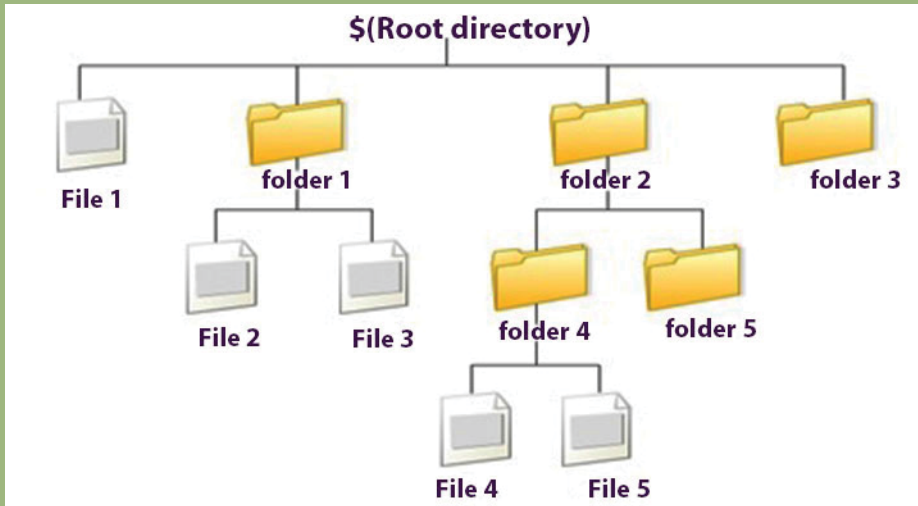

Figure 8.2: File Hierarchy

2. What do you think, the above figure represents?
3. Discuss the role of the root directory in the above figure.
4. Differentiate a file and folder in the above figure.

8.1.1 Definition of a computer file and folder

a) Definition of a computer file

A computer file is a collection of data or information that has a name, called the filename recorded on a memory storage device like hard drive, USB flash drives or portable SD card.

b) Definition of a folder

A *folder* is the virtual location for applications, documents, data or other sub-folders. It is a named collection of related files that can be retrieved, moved, and otherwise manipulated as one entity. So a folder is a special type of file on your computer's file system which contains other files and folders.

c) Difference between File and Folder

- The basic difference between file and folder is that file stores data while folder stores files and other folders.
- The folders, often referred to as directories, are used to organize files on a computer. The folders themselves take up virtually no space on the hard drive.
- The files store data, while folders store files and other folders.
- The file is created by any application program while folder is created by the operating system. The folders are used to organize files on a computer.
- There are many types of files because there are thousands of application programs but folders don't have types because there is only one operating system running the computer
- In case of Microsoft Windows, folders are opened through windows explorer and files are opened using a specific application program.

d) Properties of a File

The basic properties of a file are:

- **Name:** It is the only information which is in human readable form.
- **Identifier:** The file is identified by a unique tag (number) within file system.
- **Type:** It is needed for systems that support different types of files.
- **Location:** Pointer to file location on device.
- **Size:** The current size of the file.
- **Protection:** This controls and assigns the power of reading, writing, executing.
- **Time, date, and user identification:** This is the data for protection, security, and usage monitoring.

Note: In Microsoft Windows operating system, to view properties about a file or folder, right-click it and then select Properties. When a file or folder is selected, its properties can also be displayed by pressing Alt+ Enter.

8.1.2. File Structure

A. Definition

A file structure is defined according to the required format that the operating system can understand like:

- A file has a certain defined structure according to its type.

- A text file is a sequence of characters organized into lines.
- A source file is a sequence of procedures and functions.
- An object file is a sequence of bytes organized into blocks that are understandable by the machine.

When an operating system defines different file structures, it also contains the code to support these file structure.

B. Classifications of file

There are two basic classification of the file: text file and binary file.

- **Text files:** the files that contain text. Each byte is an ANSI character or each 2 bytes is a Unicode character.
- **Binary files:** The bytes in a binary file do not necessarily contain characters. These files require a special interpretation.

C. File attributes

File attributes are settings associated with files that grant and deny certain rights to how a user and the operating system can access that file.

The following are file attributes for the windows operating system:

- **Read-only attribute:** it allows a file to be read only and nothing can be written to the file or changed.
- **Archive attribute:** it tells windows operating to back up the file.
- **System attribute:** system file.
- **Hidden attribute:** File will be hidden.

In Linux operating systems, there are three main file attributes: read (r), write (w), execute (x).

- **Read:** Designated as an "r"; it allows a file to be read, but nothing can be written to or changed in the file.
- **Write:** Designated as a "w"; it allows a file to be written to and changed.
- **Execute:** Designated as an "x"; it allows a file to be executed by users or the operating system.

The following table shows the details:

Access Permission	File	Folder
Read (r)	Users can open and read the file.	Users can view the contents of the folder.
Write (w)	Users can change the file: They can add, delete the contents of the file. It does not include the permission to remove the file completely from the folder as long as they do not have write permissions for the directory where the file is located.	Users can create, rename or delete files in the folder.
Execute (x)	Users can execute the file. This permission is only relevant for files like programs or shell scripts, not for text files.	Users can change into the directory and execute files there.

Table 1: Linux File Access Permission

Notice that access to a certain file is always dependent on the correct combination of access permissions for the file itself and the directory it is located in.

D. File management operations

The operating system maintains a secure and well managed file system for all the users of the computer system. Mechanisms will have to exist to ensure correct and authorized use of any of the files under the file manager's care. The file manager is the most visible to the user, as the user has specific file requirements and expects requirement results to be evidenced. The file manager aims to ensure data integrity and ensures that files are kept secure. In order to do this the file manager maintains accurate information about all the files, their use and their movement throughout any file management system. A file is created, modified or deleted in some way as a direct result of some form of processing activity - which in turn is undertaken by the process manager. As such the file manager needs to ensure that all its files are fully protected from misuse or accidental damage at all times.

The File Manager (FM) has a predetermined policy that states how a file is created, used, stored and retrieved.

D. Typical responsibilities of a File Manager include:

- create and delete files
- allocate and de-allocate file space - communicating availability to others
- track where files are stored - referring to files by symbolic name (the user does not have to worry about exact storage location)
- store files efficiently
- identify and list all the files owned by a particular owner
- add or delete authorized users and their files
- access files efficiently, e.g., to retrieve files just using their symbolic names
- share files
- control access to files, for example preventing a data file from being corrupted
- reallocate file space
- protect files from the failure of the operating system (or hardware)
- be able to store files to new storage media, such as additional disks or drives

E. Directory structure

A directory is basically a set of linked files whereby they are organized in a way suited to the humans that they serve. The file manager will observe a set of rules (a policy) in which it will look after the directory and access rights to the files contained within. Directories are organized on a volume, (HDD, FDD, Tape, etc.). This organization provides a logical and controlled access to files. The normal organization is a tree structure. This provides easy and fast access and searches. Each directory entry will contain fields to indicate:

1. A symbolic name of the file
2. The size and the position of the file on the volume
3. The type of access permitted to the file

F. File Names

Files may be identified as follows:-

Absolute Name (complete name) Volume | Directory Path FileName.Ext

Example: (DOS) C:\public\help\test.hlp

- **Relative Name:** FileName.ext (short name) (Retrievable from current directory)
- **Extension** Indicates file type (contents & use of file)

8.1.3 File System

The File system is used to store and organize data on media, such on hard disk, USB flash disks or portable SD card.

The computers use particular kinds of file systems which depends on the operating system installed on the computer. Normally, the computers organize data in folders and folders contain files and other folders. The Microsoft Windows operating system have two types of file systems FAT (File Allocation Table) and NTFS (New Technology File System).

a) FAT File Systems

The FAT File System is simple, manageable and robust. It was created by Microsoft in 1977 and is widely used and found in different portable and embedded devices. Its organization is represented in the figure below.

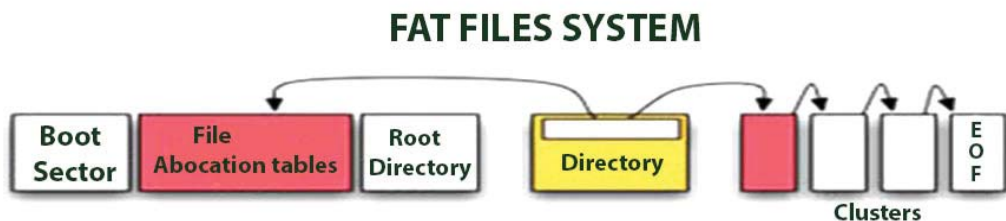

Figure 8.3.: FAT File system

Source: <http://pinnacleeventswnc.com>

Description:

The FAT file system originates from its prominent use of an index table that is allocated at the time of formatting. The index table is made up of clusters. A cluster is a unit of space which is used for storage of files and folders. Each cluster contains entries for storage in the disk. Each entry contains

- The total number of clusters in the file,

- An unused disk space,
- The special reserved areas of the disk.

The root directory of the disk contains the total number of cluster files in each file of that directory. The operating system then traverses the FAT table by looking through the cluster files of each disk file and then making a cluster chain till the end of the file is reached.

The FAT file system offers good performance in light-weight implementations. It makes the data sharing easy and convenient. It is also a useful format for solid state memory cards. Due to technology advancement and the increased need for more space, various versions of FAT file systems have evolved. Some of them are mentioned below:

- FAT 12: it was the first system introduced and had a storage capacity of 32 MB
- FAT16: it has a storage capacity of 2 GB
- FAT32: it is the third and latest file system and has a storage capacity of 8 GB

However, in FAT there is no security of data and it is not easily recoverable. This file system is also used to format the hard disk for 'multi-booting' the OS configuration.

b) NTFS file system

NTFS is a widely popular file system and it was introduced after the FAT file system. It was developed in 1993 and it was first used in the operating system MS Windows 3.1. Its mode of functioning is represented in the following figure.

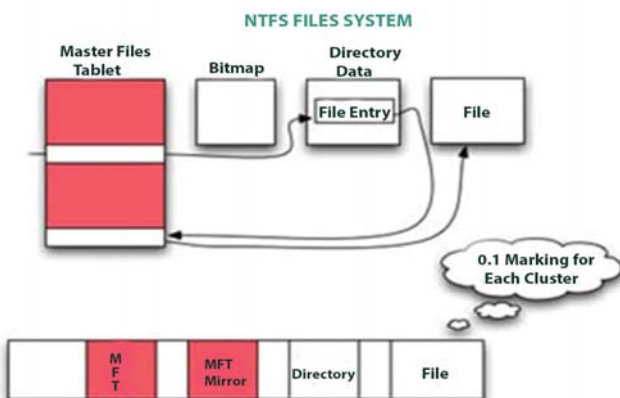

Figure 8.4.: NTFS file system

Source: <http://pinnacleeventswnc.com>

Description:

It supports the data storage capacity up to 256 TB. It is used in all the latest versions of MS Windows such as MS Windows 10, MS Windows 8, MS Windows 7, MS Windows Vista, MS Windows XP, MS Windows 2000.

NTFS has an advanced data structure and sectors writing technique, improved security, and high capability of space utilization. NTFS has several improved features over FAT file system that are stated below:

- It is more stable and reliable
- It supports automatic recovery record the information in case of hard disk crash
- It has high speed to read and write data from the hard drive
- It has high security over individual files and folders
- It supports multi-booting system
- The NTFS's data can be shared and accessed over the network
- It has File Encryption

NTFS system is a better file system. It comes with high security and data safety whereas the FAT file system is low on data security and it can be easily modified and shared by anyone.

c) Comparison between NTFS and FAT File Systems

The File System is the most popular and widely used technique to store data on different types of storage memory devices such as a hard disk, memory card and USB Flash Disk. The data can also be upgraded or degraded while formatting the system. The devices write and store the data in their systems so that the data can be modified, accessed, deleted, or distributed at the time of need. Both NTFS and FAT are two different methods and they store the data in a structured way on a disk partition.

The table below compares the NTFS and FAT File Systems.

Features	NTFS File System	FAT File System
Security	It provides complete security to files and folders in the system.	There is no security of files and folders in the system.
Activity Log	In case of any failure, the files and folders can be easily restored.	In case of any failure, the files and folders are not recovered or restored.
File Compression	It supports flexible per file compression.	No such compression is supported.
File Size	It can be 4GB to 64 GB	It is 4GB Max
OS Compatibility	It only allows accessing on the recognized platforms, on a running computer.	It allows the accessing of files when the computer running on other or different platforms.
Data sharing	It does not allow sharing data between the operating systems.	It allows sharing data between the operating systems.

Table 2: comparison between NTFS and FAT File Systems

As there are various Operating Systems in the world, there are also numerous File Systems used and specific to each OS.

Linux File Systems are ext2, ext3 and ext4 while MAC OS file systems are APFS (Apple File System).

8.1.4. Hierarchical File System

A hierarchical file system shows how drives, folders and files are organized in the operating system. In a hierarchical file system, the drives, folders, and files are displayed in groups, which allows the users to see only files they are interested in.

The example below illustrates the hierarchical file system:

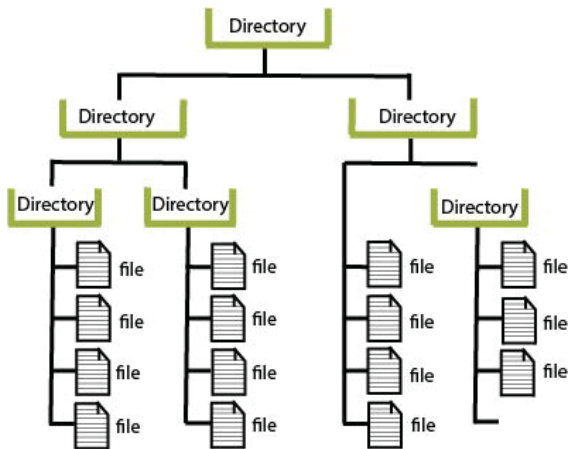

Figure 8.5.: Hierarchical File System

8.1.5. File manipulation functions

The File Manipulation functions allow the user to manipulate directories/folders by creating, opening, saving documents, etc. The following are some of the typical file operations:

1. **Creating:** It helps in creating a new file at the specified location in a computer system. The new file could be a word document, an image file or an excel worksheet.
2. **Saving:** It helps in saving the content written in a file at some specified location. The file can be saved by giving it a name of our choice.
3. **Opening:** It helps in viewing the contents of an existing file.
4. **Modifying:** It helps in changing the existing content or adding new to an existing file.
5. **Closing:** It helps in closing an already open file.
6. **Renaming:** It helps in changing the name of an existing file.
7. **Deleting:** It helps in removing a file from the memory of the computer system.

The functions for File and Directory Manipulation are given in the table below.

Command Name	Use	Arguments
Chdir	Change current directory	scalar directory name
Chmod	Change permissions on files	scalar(mode), list of filenames

Chown	Change ownership of files	scalar(uid),scalar(gid),list of files
Link	Create hard link to a file	scalar(old file),scalar(newfile)
Mkdir	Create a new directory	scalar(filename), scalar(mode)
Rename	Rename a file	scalar(oldname),scalar(newname)
Rmdir	Remove a directory	scalar(filename)
Umask	Display or set umask	scalar(umask)
Unlink	Remove a file	list of filenames

Table 3: File and directory manipulation commands

The application of the above functions will depend on the kind of operating system used. In this case Microsoft Windows is used.

8.1.5.1 Access files and folders using command prompt

Step1 1:

Open **Run command**(Win key+R) and type cmd for command prompt then press enter key. This will open the command prompt.

Step 2:

Now write **“Start file_name or start folder_name”** in the command prompt , **for**

example:- write “start mspaint” it will open ms-paint automatically.

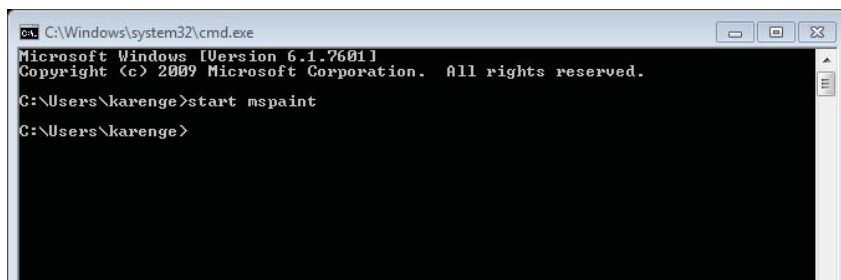

Note: - These steps only allow you to access files, folder or software which is present in the “c” drive or system drive. To access file/folder from another driver you need to change drive in the command prompt, then you will access the files/folders from another drive. You can also hide files and folder using command prompt. To change one drive to another drive, type drive name followed by “:”. It will change default drive(c:) to your required drive

8.1.5.1 File and folder viewing using windows explorer

- Hide/Show hidden files

In most of the operating systems, system files are hidden because an accidental deletion of one of them can make the whole system failing or crashing. Sometimes, the user can decide to see the hidden folders and files or not. To hide or unhide files and folders, do the following actions:

1. Open Folder options on your Windows PC
2. Navigate to **“View”** tab on Folder Option.
3. Scroll down the horizontal scroll bar on the **“Advanced setting”** of the view tab till you get the option **“Hidden files and folder”**.
4. You will get two check boxes under **“Hidden Files and folder”** as
 - Don't show hidden files, folder or drives
 - Show hidden files, folder and drives
5. Just select **“Don't show hidden files, folder or drives”** to hide the hidden files and folder and select **“Show hidden files, folder and drives”** to show those hidden files and folder.
6. Now **“Apply”** all the changes and click on **“OK”**.
That is it.

Assigning the hidden attributes to File/folder in Windows

To assign the hidden attribute to files or folders, do the following steps:

1. Select the file/folder that you want to make hidden.
2. Right click of mouse on that file and choose **“Properties”**.
3. Navigate to **“General”** tab. (By default that will on the general tab. If not then navigate to it)
4. On the **“Attributes”** section you will get a check box **“Hidden”**.
5. Just tick that **“hidden”** check box.
6. Now **“Apply”** all the changes and click on **“OK”**.
7. Now the selected file/folder is hidden. Remove the hidden attribute from a file/folder in Windows

The steps to remove the hidden attributes are:

- a. First you need to show the hidden files or folder to view the hidden files/
- b. folder by following the above process.
- c. Select the file/folder whose hidden attribute you want to remove. (Note: Hidden files/folder are viewed as faded)

- d. Right click of mouse on those files/folder and choose "Properties"
- e. Navigate to "General" tab. (By default that will on the general tab. If not then navigate to it)
- f. On the "Attributes" section you will get an check box "Hidden". Just unchecked that "Hidden" check box. Now "Apply" all the changes and click on "OK".
Now the hidden attribute for the selected file/folder is removed and it is converted to general file/folder.

Application Activity 8.1.

Question A

1. What do understand by a cluster?
2. List and explain various version of FAT file system?
3. Investigate why it important to organize file and folders in hierarchal model?
4. What are the advantage of NTFS file system over the FAT file system?
5. What is the difference between home directory and working directory?
6. Distinguish the absolute path name and relative path name?

Question B

1. How to view and change the file attributes in Windows 10
2. Is it possible to create a folder using application software? Justify your answer?
3. Is it possible to create a file using an operating system? Justify your answer?
4. Differentiate the folder and directory?

8.2. FILE TYPE

Learning Activity 8.2.

Observe carefully the figure below and respond to the asked question



Source: <https://www.sonsuzteknoloji.com/etiket/dosya-uzantilari/>

1. What did you find in the figure above?
2. Discuss why the above files do not have the same graphical representation?
3. How does the operating system recognize the application software that open the file?
4. How can an operating system make use of the file types that it recognizes?

8.2.1. Understanding file type

File type refers to the ability of the operating system to distinguish different types of file such as text files, source files, binary files and others. Many operating systems support many types of files and modern operating system has the following types of files:

a) Ordinary Files or Regular File

Therefore, all files created by a user are Ordinary Files and belong to any type of application program. Ordinary Files are used for storing the information about the user Programs

Example: Notepad, Paint, C Program, Songs, Database, Image

b) Directory files

There are files stored into the particular directory or folder.

Example: a folder named songs which contains many songs.

c) Special Files

The special files are files which are not created by the user and are files needed to run a System and are created by the Operating System. It means all the files of an operating system are referred as special files.

8.2.2. File Extension

a) Definition of a file extension

A file extension also called a file suffix, is the character or group of characters after the period that makes up an entire file name.

Example:

Senior6mpc.vlc(the file extension here is vlc)

The File extension helps the operating system to determine which program on computer the specific file is associated with and indicates the file type.

When a user attempts to open a file, the operating system checks the file extension and open the file using the associated application program. The Operating system uses file extensions to indicate the type of each file.

b) Type File and File Extension

The table below gives some of file type and file extension.

	File type	File extension	File function
1	Executable	exe ,com, bin	Ready to run machine language program

2	Object	obj, o	Compiled ,machine language, not linked
3	Source code	c,cc, java, perl	Source code in various language
4	Batch	bat, sh	Command to the command interpreter
5	Markup	xml, html, tex	Textual data, documents
6	Word processor	xml, rtf, docx	Various word processor formats
7	Library	lib, a, so, dll	Library of routine for programmers
8	Print or view	gif, pdf, jpg	Ascii or binary file in format for printing or viewing
9	Archive	rar, zip, tar	Related grouped into one file, sometime compressed from archiving or storage
10	Multimedia	mpeg,mov,mp3,mp4,avi	Binary file containing audio or Audio visual information

Table 4: File type and extension

c) File Extensions vs File Formats

File extensions and file formats are often used as interchangeably terms which is not true. In reality, however, the file extension is just 3 or 4 characters after the period in the file name while the file format indicates the way in which the data in the file are organized ; in other words it specifies what type of file it is.

Example: In the file name marks.xls, the file extension is xls which indicating that this is a spreadsheet file created in MS Excel.

Application Activity 8.2.

	Categories by Type of Files	File Extensions
1	Audio file formats	
2	Compressed file	
3	Word processor and text file formats	
4	Video file format	
5	System related file formats and file	
6	Spreadsheet file formats	
7	Programming files	
8	Presentation file formats	
9	Internet related file	
10	Image file formats	
11	Font file	
12	Executable file	
13	Disc and media file	

1. File type can be represented by
 - a. file name
 - b. file extension
 - c. file identifier
 - d. none of the mentioned
2. Name and describe the two basic classifications of files.
3. Name and describe the two basic classifications of files.
4. Distinguish between a file type and a file extension.
5. List advantages of operating system "knowing" and supporting many file types.
6. What would happen if you give the name "myFile.jpg" to a text file?
7. Complete the 3rd column of the table below with appropriate extensions of files.

8.3. FILE ACCESS MECHANISMS

Learning Activity 8.3.

Using DOS command, Create a folder structure for the small business company with three departments namely: Accounts, Personnel and Marketing.

The Accounts department wants to organize its files into Invoices Client folder and Expenses Client folder, the Personnel department wants organize its files in Wages Clientfolder, Contract Client folder and Disciplinary Client folder and the Marketing department wants organize its files in Client folder and Public Relations Client folder.

Answer the following questions:

1. How do you access disciplinary folder in personal department?
2. Give the full path to access the public relation folder

The File access mechanism refers to the manner in which the records of a file may be accessed. When a file is used with the Central Processing Unit (CPU), then the stored information in the file must be accessed and read into the memory of a computer system.

Various mechanisms are provided to access a file from the operating system. There are 3 ways to access files: Sequential access, Direct Access and Index Access

8.3.1 Sequential Access method

It is the simplest access mechanism in which information stored in a file are accessed in an order such that one record is processed after the other.

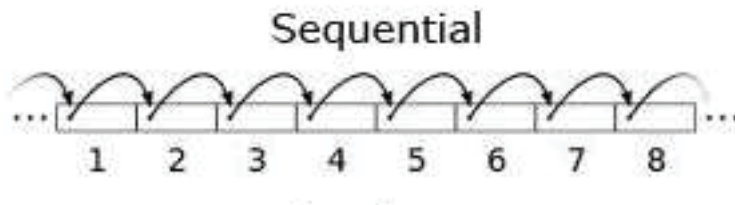

Figure 8.6 Sequential Access of Files.

A sequential access is that in which the records are accessed in some sequence. The information in the file is accessed in order where one record is accessed after another. This access method is the most primitive one.

Sequential access generally supports a few operations:

- **Read Next:** Read a record and advance the tape to the next position.
- **Write Next:** Write a record and advance the tape to the next position.
- rewind
- **Skip n records:** It may or may not be supported. N may be limited to positive numbers, or may be limited to +/- 1.

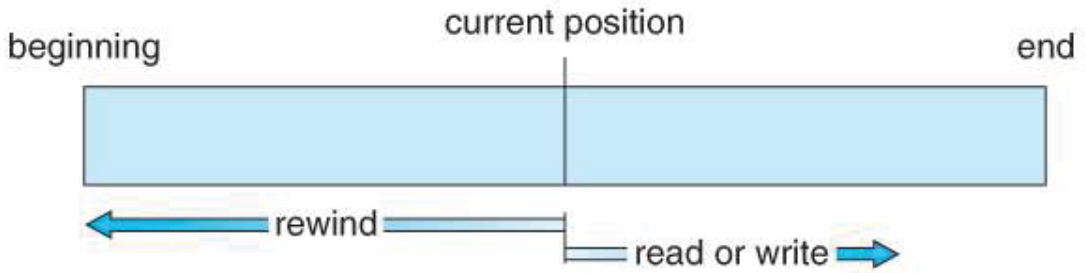

Figure 8.7: Operations on the sequential access of a file

Example:

- Editors and compilers usually access files in this manner.
- Magnetic tape (cassette) operation.

8.3.2 Direct / Access method

It is an alternative method for accessing a file, which is based on the disk model of a file, since disk allows random access to any block or record of a file. In access method, file is viewed as a numbered sequence of blocks or records which are read or written in an arbitrary manner i.e. there is no restriction on the order of reading or writing.

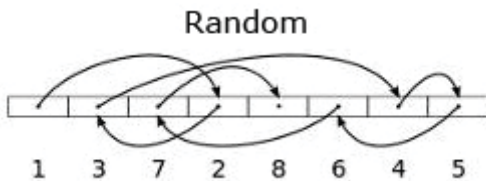

Figure 8.8: Direct Access File mechanism

Direct / Random access is the file access method that access the records directly. Each record has its own address on the file with by the help of which it can be directly accessed for reading or writing. The records need not be in any sequence within the file and they need not be in adjacent locations on the storage medium. Random access jump directly to any record and read that record.

Operations supported by direct / random access method include:

- **Read n:** read record number n.
- **Write n:** write record number n.
- **Jump to record n:** could be 0 or the end of file.
- **Query current record:** used to return back to this record later.

Sequential access can be easily emulated using direct access. The inverse is complicated and inefficient.

Sequential Access	Implementation for direct access
Reset	cp=0 Where cp is current position
Read_next	Read cp; cp=cp+1;
Write_next	Read cp cp=cp+1;

Table 5: Simulation of sequential access on a Direct Access File.

Comparison between Random and Sequential Data Access

Comparing random versus sequential operations is one way of assessing file efficiency in terms of disk use.

a. Sequential file access

- Accessing data sequentially and is much faster than randomly access because of the way in which the disk hardware works.
- Sequential file access allows data to be read from a file or written to a file from beginning to end.
- It is not possible to read data starting in the middle of the file,
- It is not possible to write data to the file starting in the middle using sequential methods.

b. Random Access Files,

- Random access files permit non sequential access to the files' contents.

8.3.3. Indexed sequential access method

In this method an index is created which contains a key field and pointers to the various block. To find an entry in the file for a key value, we first search the index and then use the pointer to directly access a file and find the desired entry. With large files, the index file itself may become too large to be keep in memory. One solution is to create an index for the index file. The primary index file would contain pointers to secondary index files, which would point to the actual data items.

Indexed Sequential Access Method allows records to be accessed either sequentially (in the order they were entered) or randomly /directly (with an index). Each index defines a different ordering of the records.

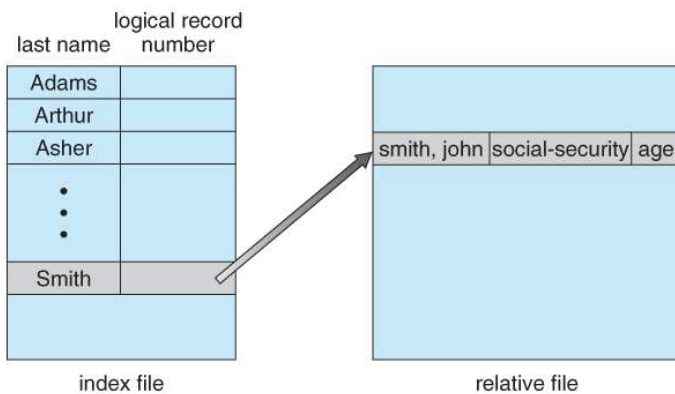

Figure 8.9: Example of index and relative files

Application Activity 8.3.

1. Explain the Indexed Sequential Access Method
2. Compare sequential and direct file access.
3. Explain why it is not possible to write data in the middle of the file using sequential methods?
4. What are advantage of sequential access?
5. File access is independent of any physical medium.
 - a. How does the Operating System implement sequential access on a disk?
 - b. How does the Operating System implement direct access on a magnetic tape?

8.4. FILE SPACE ALLOCATION

Learning Activity 8.4.

Observe the below picture and answer below question

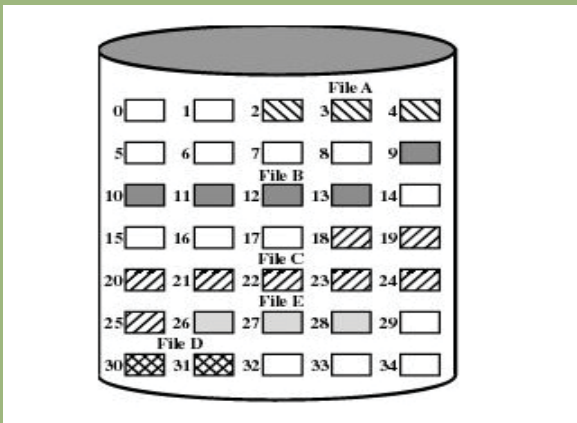

Figure 8.10: Secondary Storage

Source: <https://fr.wikibooks.org>

1. What do you think of the above figure?
2. How does an operating system track the file stored in the secondary memory?
3. Discuss mechanism used by the OS to allocate files memory space on secondary memory?

8.4.1. File space allocation

File space allocation is the method by which data is apportioned physical storage space in the operating system. The kernel allocates disk space to a file or directory in the form of logical blocks.

The logical blocks are not tangible entities. However, the data in a logical block consumes physical storage space on the disk. Each file or directory consists of 0 or more logical blocks. The main idea behind allocation is effective utilization of file space and fast access of the files. There are three types of allocation:

- Contiguous allocation
- Linked allocation
- Indexed allocation

In addition on storing the actual file data on the disk drive, the file system also stores metadata about the files: the name of each file, when it was last edited, exactly where it is on the disk.

8.4. 2 Contiguous allocation

In contiguous allocation, each file occupies contiguous blocks on the disk. The location of a file is defined by the disk address of the first block and its length.



Figure 8.11: Contiguous allocation

Source: <https://fr.wikibooks.org>

Both sequential access and direct/Random access are supported by the contiguous allocation. As it supports random access by using Disk Block Address we can jump directly on the required location.

8.4.3. Linked allocation

In linked allocation, each file is a linked list of disk blocks. The directory contains a pointer to the first and optionally the last block of the file.

Example: a file of 5 blocks which starts at block 4, might continue at block 7, then block 16, block 10, and finally block 27. Each block contains a pointer to the next block and the last block contains a NIL pointer. The value -1 may be used for NIL to differentiate it from block 0.

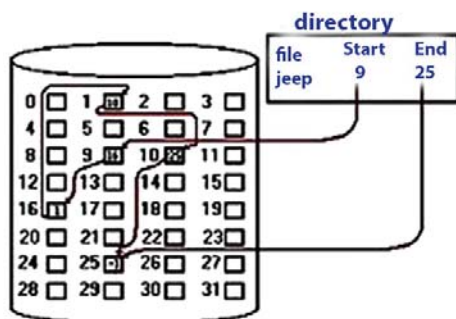

Figure 8.12: Linked allocation

Source: <https://fr.wikibooks.org>

8.5.4. Indexed allocation

Linked allocation does not support random access of files, since each block can only be found from the previous. Indexed allocation solves this problem by bringing all the pointers together into an index block. One disk block is just used to store DBAs (disk block addresses) of a file.

Every file is associated with its own index node. If a file is very large then one disk block may not be sufficient to hold all associated DBAs of that file. If a file is very small, then some disk block space is wasted as DBAs are less and a single disk block could still hold more DBAs.

Application Activity 8.4.

1. The three major methods of allocating disk space that are in wide use are :

- a. contiguous
- b. linked
- c. indexed
- d. all of the mentioned

3. In linked allocation :

- a. each file must occupy a set of contiguous blocks on the disk
- b. each file is a linked list of disk blocks
- c. all the pointers to scattered blocks are placed together in one location
- d. none of the mentioned

5. Contiguous allocation of a file is defined by :

- a. disk address of the first block & length
- b. length & size of the block
- c. size of the block
- d. total size of the file

2. In contiguous allocation :

- a. each file must occupy a set of contiguous blocks on the disk
- b. each file is a linked list of disk blocks
- c. all the pointers to scattered blocks are placed together in one location
- d. none of the mentioned

4. In indexed allocation :

- a. each file must occupy a set of contiguous blocks on the disk
- b. each file is a linked list of disk blocks
- c. all the pointers to scattered blocks are placed together in one location
- d. none of the mentioned

6. One difficulty of contiguous allocation is :

- a. finding space for a new file
- b. inefficient
- c. costly
- d. time taking

8.5. END UNIT ASSESSMENT

1. What do you understand by a file?
2. Using their respective attributes, compare a file and folder?
3. Discuss a situation where file is considered as Executable file?
4. Write a note about the Access methods available in file management?
5. What are the different directory structures available?
6. Discuss different methods for allocation in a File System
7. Discuss different operations that can be performed on a File?
8. Consider a system that supports the strategies of contiguous, linked, and indexed allocation. What criteria should be used in deciding which strategy is best utilized for a particular file?
9. Elaborate on the three major disk space allocation methods in detail?
10. Give an example of an application in which data in a file should be accessed in the following order:
 - a. Sequentially
 - b. Randomly



UNIT 9

MEMORY MANAGEMENT

UNIT 9: MEMORY MANAGEMENT

Key unit competency:

To be able to explain the role of operating system in Memory Management

Introductory Activity

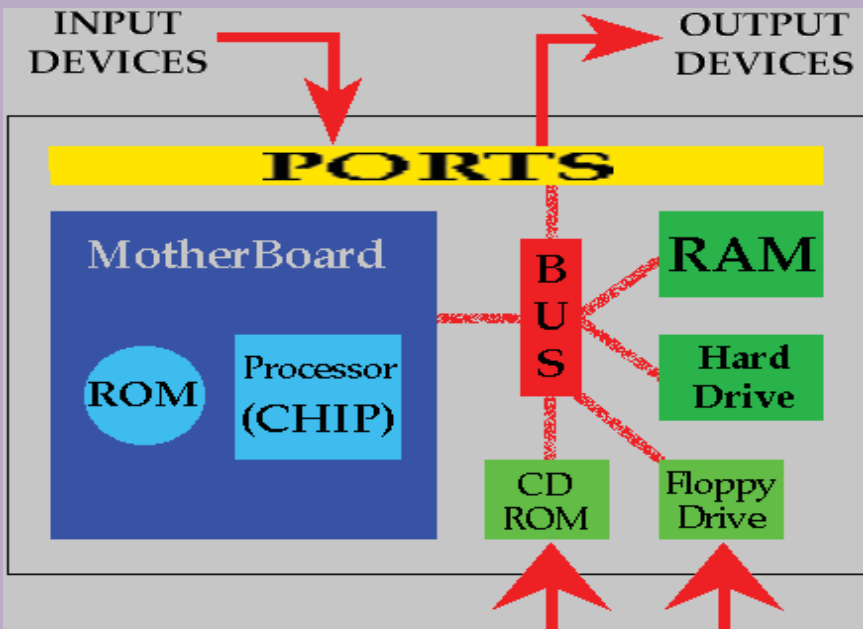

Source: https://images.slideplayer.com/20/5962051/slides/slide_78.jpg

1. What do you think of the above figure?
2. What do you understand by the central processing unit? Discuss parts of the central processing unit?
3. Examine the role of input and output devices in the above figure?
4. Does the computer has a memory? Differentiate a memory and a storage?
5. Investigate the role played by CD Rom, Floppy Drive, Hard drive and RAM in the above figure?
6. What is the name given to the computer program in the execution? Where does it managed from?
7. Analyze the role of BUS in the above figure?
8. Discuss how programs in execution are managed?
9. Discuss how multiprogramming is achieve in computer?

9.1. UNDERSTANDING COMPUTER MEMORY

Learning Activity 9.1.

Uwera Joanna is a student in senior 6 in HEG at Lycee de Kigali, she is brilliant students in History because she has the good ability to memorize and she is worried about the second term exam of history. The history teacher has said that the exam will cover senior 4, 5 and 6. The issue with Uwera is that she can't remember what she learnt in senior 4, 5 and senior 6 term 1. She only remembers very well what was learnt only in second term of senior 6.

Please answer the questions below:

1. Discuss your ability of remembering events happened into your life
2. Are you able to think of 2 situations at the simultaneously?
3. In which part of brain that store what you have memorize or any information
4. Explain why Uwera is able to remember better what she learnt in learnt in second term of senior 6 than what she learnt in senior 4, 5 and senior 6 term 1.
5. Does the computer remember everything? explain how

9.1.1. Definition of computer memory

A computer memory is just like a human brain. It is used to store data and instructions. Computer memory is the storage space in the computer where data is to be processed and instructions required for processing are stored.

The memory is divided into large number of small parts called cells. Each location or cell has a unique address, the addresses varies from zero to memory size minus one.

Memory is the part of the computer that holds data and instructions for processing. The memory works closely with the central processing unit and computer memory is separated from the central processing unit. Memory stores program instructions and data for the programs in the execution.

For example: if the computer memory stores 64 characters, it keeps 64 bytes, then this memory unit has $64 * 1024 = 65536$ kbytes.

Computer memory is also known as place in the computer where data is kept. The computer memory is in two different types

1. RAM (Random Access Memory) that is also known as primary memory, main storage, internal storage, main memory, volatile memory and all these terms are used interchangeably in computer science. This kind of memory stores data for short period of time.
2. ROM (Read Only Memory) also known as permanent memory, non volatile memory. This kind of memory stores data for long period of time.

Computers need a memory because the memory is the place where the processor (central processing unit) does its work.

Note:

- The more memory size in the computer, the better processes execution.
- With more memory, your computer runs fast
- With more computer memory in the computer, you can work on larger documents.

9.1.2. The role of memory in the computer

The main memory holds temporary instructions and data needed by a program in the execution in order to complete any computing tasks. The main memory enables the Central Processing Unit to access instructions and data stored in memory very quickly.

The central processing unit (CPU) loads an application program from the hard disk, such as a word processing into the main memory. When a program is loaded in the main memory, it allows the application program to work efficiently and the CPU can access it from the main memory.

9.1.3. Memory Organization

A memory unit is the collection of storage units. The memory unit stores the binary information in the form of bits. Generally, computer memory is classified into 2 categories:

- Volatile Memory: The memory loses its data, when power is the computer switched off.

- **Non-Volatile Memory:** The memory is a permanent storage and does not lose any data when power is the computer switched off. Slower than primary memories.

9.1.4 Characteristics of computer memory

Computer memory is characterized by its function, capacity, and response times. There are only 2 operations that can be performed on the computer memory: Read and Write

- Read operation is performed when information is transferred from the memory to another device.
- Write operation is performed when information is transferred from another device to the memory.

Note:

- A memory that performs both read and write is RAM.
- ROM can only be written

The performance of a memory system is defined by two different measures: the access time and the cycle time.

- **Access time** is also known as **response time** or **latency** refers to how quickly the memory can respond to a read or a write operation request.
- **Memory cycle time** refers to the minimum period between two successive a read or a write operation requests.

9.1.5. Computer Memory Types

Memory is primarily of three types: magnetic memory, semiconductor memory, optical memory and flash memory.

a. Magnetic Memory

Magnetic memory is the storage of data on magnetized medium. Magnetic storage uses different patterns of magnetization in a magnetisable material to store data and is a form of non-volatile memory.

Example of magnetic storage media is the hard disk.

In the magnetic storage media, the information is accessed using one or more read and write heads. They are used for storing data/information permanently and Central Processing Unit does not access these memories directly.

Characteristics of Magnetic Memory

- It is known as the backup memory.
- It is a non-volatile memory.
- Data is permanently stored even if power is switched off.
- It is used for storage of data in a computer.

b. Semi-conductor memory

Semiconductor memory is a digital electronic data storage device implemented with semiconductor electronic devices on an integrated circuit (IC). Example of semiconductor memory are: cache memory and primary memory

Cache Memory: Cache memory is a very high speed semiconductor memory which can speed up the CPU. It acts as a buffer between the CPU and the main memory.

Note: Data Buffer is a region of a physical memory storage used to temporarily store data while it is being moved from one place to another.

Cache memory is used to hold those parts of data and program which are most frequently used by the CPU. The parts of data and programs are transferred from the disk to cache memory by the operating system, from where the CPU can access them.

Advantages of Cache memory	Disadvantages of Cache memory
<p>The advantages of cache memory are as follows:</p> <ul style="list-style-type: none"> • Cache memory is faster than main memory. • It consumes less access time as compared to main memory. • It stores the program that can be executed within a short period of time. • It stores data for temporary use. 	<p>The disadvantages of cache memory are as follows:</p> <ul style="list-style-type: none"> • Cache memory has limited capacity. • It is very expensive.

Primary Memory (Main Memory): Primary memory holds only those data and instructions on which the computer is currently working on. Main Memory is indirectly accessed by the CPU/ processor. It has a limited capacity and data is lost when power is switched off.

Note: Volatility: a memory is said to be volatile memory when it loses its content when the computer is powered off. All primary memories are volatile.

These memories are not as fast as cache memory. The data and instruction required to be processed resides in the main memory. It is divided into two subcategories RAM and ROM.

Characteristics of semiconductor memories

- These are semiconductor memories.
- Usually volatile memory.
- Data is lost in case computer is switched off.
- It is the working memory of the computer.
- Faster than magnetic memories.

c. Optical memory

Optical storage is the storage of data on an optically readable medium. Data is recorded by making marks in a pattern that can be read back with the aid of light, usually a beam of laser light precisely focused on a spinning optical disc.

Example of optical memory are: CD, DVD and BLUE RAY

d. Flash memory

Flash memory is a non-volatile memory chip used for storage and for transferring data between a personal computer and digital devices

Flash memory has the ability to be electronically reprogrammed and erased. It is often found in USB flash drives, MP3 players, digital cameras and solid-state drives.

9.1.6. The difference between memory and storage

The term memory refers to the amount of RAM installed in the computer whereas the term storage refers to the capacity of the computer's hard disk. Computers have two kinds of storage: temporary and permanent. A computer's memory is used for temporary storage, while a computer's hard drive is used for permanent storage.

9.1.7. Memory Access Methods

Each memory type is a collection of numerous memory locations. To access data from any memory, first it must be located and then the data is read from the memory location.

Following are the methods to access information from memory locations:

- **Random Access:** main memories are random access memories, in which each memory location has a unique address. Using this unique address any memory location can be reached in the same amount of time in any order.
- **Sequential Access:** This method allows memory access in a sequence or in order.
- **Direct Access:** In this mode, information is stored in tracks, with each track having a separate read/write head.

Application Activity 9.1.

1. Using clear example differentiate primary memory and secondary memory
2. Using clear example differentiate volatile memory and non-volatile memory
3. Discuss why main memory is considered as the working memory.
4. Differentiate computer memory and computer storage
5. Discuss the computer memory hierarchy using a clear graphical representation
6. Discuss the access method for the following categories of storage devices a)Magnetic storage, b) optical storage , c) flash storage ,d) semiconductor storage
7. What do you understand about computer memory? In the table below, decide what is true for main memory and for secondary memory

	Characteristic of computer memory	True for Main Memory	True for Secondary Memory
1	Very closely connected to the processor.		
2	Holds programs and data that the processor is actively working with.		
3	Used for long term storage.		
4	The processor interacts with it millions of times per second.		
5	Stored data are easily changed.		
6	Relatively low capacity.		
7	Relatively huge capacity.		
8	Fast access.		
9	Slow access.		
10	Connected to main memory.		
11	Holds programs and data.		
12	Data are organized into files.		

9.2. LOGICAL AND PHYSICAL ADDRESS MEMORY SPACE

Learning Activity 9.2.

Consider a system in which a program can be separated into two parts: codes (Instructions) and data. The CPU knows whether it wants an instruction (instruction fetch) or data (data fetch or store). Therefore, two base and limit register pairs are provided: one for instructions and one for data. The instruction base and limit register pair is automatically read-only, so programs can be shared among different users.

Discuss the advantages and disadvantages of this scheme.

9.2.1. Partitions

One of the first mechanisms used to protect the operating system and to protect processes from each other was the creation of partitions. A partition is a logical division of a memory that is treated as memory unit by operating system

The operating systems in order to manage memory partitions add two hardware registers to the memory address decoder: the **base** and **limit** registers. The **base registers** indicate where the partition starts in memory and the **limit register** indicates the end of the partition.

When a process is placed into the main memory, the memory decoder adds on the value of the base register and the limit register address becomes 'base + X'. Where X is the size the process.

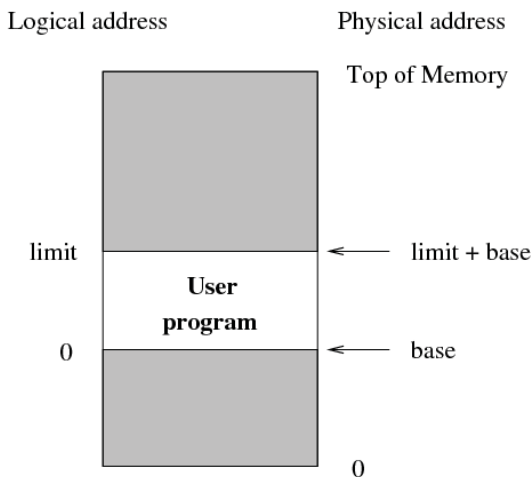

Figure 9.1: Memory partition

There is a memory hard error, when the input address is lower than base address or higher than limit address.

9.2.2. Physical memory address

Physical address is a memory address that is represented in the form of a binary number on the address bus circuitry in order to enable the data bus to access a particular storage cell (partition) of main memory.

Physical Memory is the main memory and its location as seen by the operating system. Generally, the main memory address starts at location 0 and goes up to a top address set by the amount of the main memory.

9.2.3. Logical Memory address

When a process is loaded into the main memory, the CPU binds the base address and the limit address (base and limit registers) of the memory partition where the process is going to reside in the main memory. The address generated by the CPU and added to the process to form the physical address is called as logical address.

Logical address is the memory partition address at which a process appears to reside from the perspective of an executing application program

In the partition system, all processes see memory partition as starting at address 0 defined by base register and going up to the end address defined by the limit register. The process in running in user mode (in execution) cannot modify the value base and limit register. The process sees its logical memory partition as fixed in size.

9.2.4. Address Binding Schemes

Computer memory uses both logical addresses and physical addresses to locate process in the main memory. Address binding allocates a physical memory location to a logical pointer by associating a physical address to a logical address, which is also known as a virtual address. There are 3 types of address binding:

a. Compile Time:

- If it is known in advance that where the process will be placed in memory then absolute code can be generated at the time of compilation.
- If we know in advance that a user process may store at starting from location R and that the generated code will start at that location and extend up from there.
- If at some later time starting location changes then it will be necessary to recompile this code.

b. Load Time:

- If it is not known at compile time that at which particular location the process will reside in memory when the compiler will generate relocatable code to find the address.
- In this case final binding is delayed until load time.
- In this case absolute address will be generated by the loader at the load time

c. Execution Time (Run Time):

- If the process can be moved during its execution from one memory segment to another then address binding must be performed at run time.

- A special hardware-MMU (Memory Management Unit) is used to generate physical addresses.

Note: The runtime mapping from virtual to physical address is done by the memory management unit (MMU) which is a hardware device.

9.2.5. Static Loading

While the operating loads program statically in the main memory then at the time of compilation the complete programs will be compiled and linked without leaving any external program (library or module). The linker combines the object program with object modules into an absolute program which also they are also included in logical addresses.

9.2.6. Dynamic Loading

When the operating loads dynamically program in the main memory then the operating loads only the part of the program(modules , libraries) .Then, operating system references the addresses of the others (library or modules) and they will be loaded in the memory when need by the CPU.

9.2.7. The difference between the static and dynamic loading

In static loading, the absolute program (and data) is loaded into memory in order for execution to start while in dynamic loading, dynamic routines of the library are stored on a disk in re-locatable form and are loaded into memory only when they are needed by the program.

9.2.8. Static vs Dynamic Loading

The choice between Static or Dynamic Loading is to be made at the time of computer program being developed.

9.2.9. Static Linking

As explained above, when static linking is used, the linker combines all other modules needed by a program into a single executable program to avoid any runtime dependency.

9.2.10. Dynamic Linking

When dynamic linking is used, it is not required to link the actual module or library with the program, rather a reference to the dynamic module is provided at the time of compilation and linking.

Application Activity 9.2.

1. What is memory address binding?
2. Discuss overlays in memory management?
3. Discuss the advantage of dynamic loading?
4. What do you understand by relocation register
5. Consider a logical address space of eight pages of 1024 words each, mapped onto a physical memory of 32 frames.
 - a. How many bits are there in the logical address?
 - b. How many bits are there in the physical address?
6. Explain the difference between logical and physical addresses?

9.3. ALLOCATING AND PLACING PARTITIONS IN MEMORY

Learning Activity 9.3.

Observe by comparing below 2 figures and answer questions.

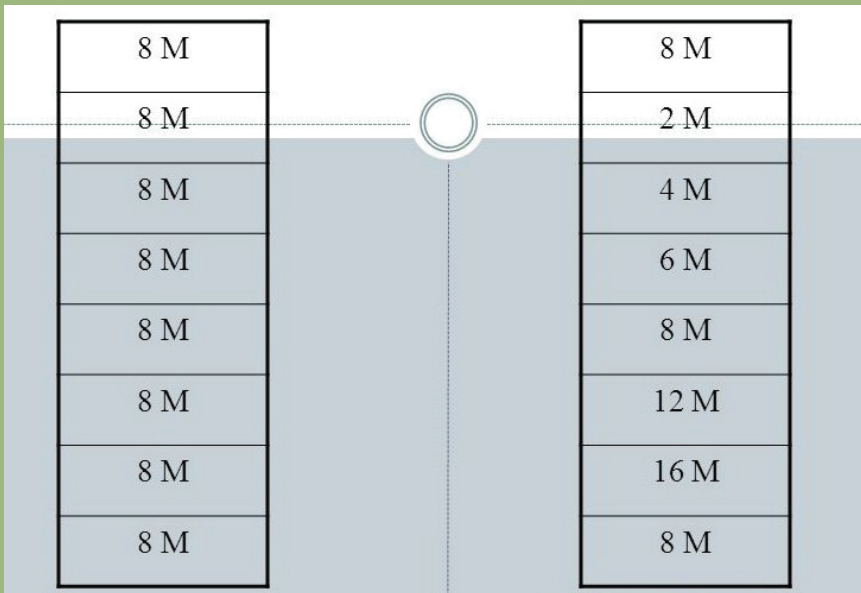

1. Discuss why there is no a partition for the operating system
2. Discuss why memory has partitions of different size?
3. Investigate various algorithm used by the operating system to place processes into the main memory.

The operating system place the process into available partition. The first partition of the main memory is for the operating system and processes are chosen from

the pool of programs waiting to be started (Waiting queue). The operating system chooses a partition size and physical location for a new process arriving in the main memory.

9.3.1. Single Partition Allocation

Single allocation is the simplest memory management technique where there is a partition reserved for the operating system and other partition are reserved for a single application.

Example: Microsoft DOS.

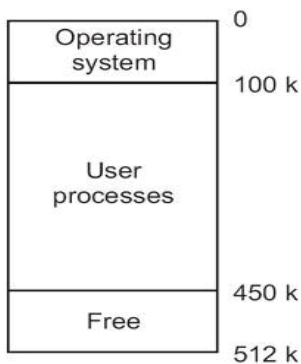

Figure 9.2: Single Partition Allocation

Advantages	Disadvantages
<p>It is simple.</p> <p>It is easy to understand and use.</p>	<p>It leads to poor utilization of processor and memory.</p> <p>Users' job is limited to the size of available memory.</p>

The process of dividing the main memory into a set of non-overlapping blocks of memory is known as fixed partition. There are two types of fixed partitioning and they are:

9.3.2. Equal size partition

The size of each block in fixed partition will be equal. Any process less than the size of partitioning can be loaded in the fixed partition of equal size.



(a) Equal size partition *Figure 9.3. Equal size partition*

Advantages	Disadvantages
<p>Any process whose size is less than or equal to the partition size can be loaded into any available partition.</p> <p>It supports multiprogramming.</p>	<p>If a program is too big to fit into a partition use overlay technique.</p> <p>Memory use is inefficient, i.e.: block of data loaded into memory may be smaller than the partition.</p>

9.3.3. Unequal size partition

The size of each block in fixed partition is varied where processes are assigned to the blocks where it fits exactly: in other words, processes may be queued to use the best available partition. In the unequal size partition compared to equal size partition, memory wastage is minimized and may not give best throughput as some partitions may be unused.

The unequal size partitions use two types of queues where processes are assigned to memory blocks. They are multiple queue and single queue.



(b) Unequal size partition

Figure 9.4: unequal size partition

a. Multiple Queues

Each process is assigned to the smallest partition in which it fits and minimizes the internal fragmentation problem.

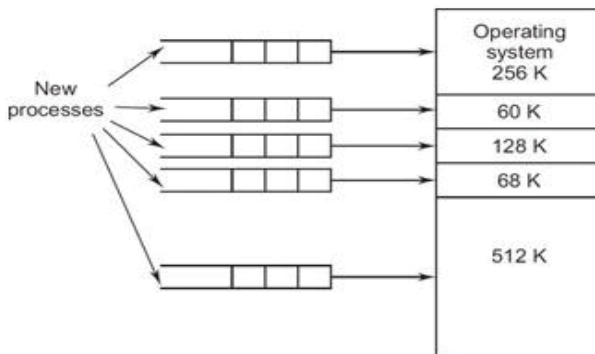

Figure 9.5: Multiple queues

Source: <http://img2018world.pw>

Advantages	Disadvantages
Minimize wastage of memory.	This scheme is optimum from the system point of view. Because larger partitions remains unused.

b. Single Queue

The process is assigned to the smallest available partition and the level of multiprogramming is increased.

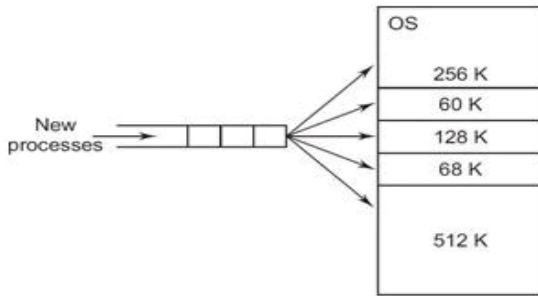

Figure 9.6.: Single queue

Source: <http://img2018world.pw>

Advantages	Disadvantages
It is simple and minimum processing overhead.	<p>The number of partitions specified at the time of system generation limits the number of active processes.</p> <p>Small jobs do not use partition space efficiently.</p>

Fixed size partitions suffer from two types of problems: they are overlays and internal fragmentation.

- **Overlays:** If a process is larger than the size of the partition then it suffers from overlaying problem in which only required information will be kept in memory. Overlays are extremely complex and time consuming task.
- **Internal fragmentation:** If process loaded is much smaller than any partition either equal or unequal, then it suffers from internal fragmentation in which memory is not used efficiently.

9.3.4. Dynamic partitioning

The dynamic partitioning requires more sophisticated memory management techniques. The partitions used are of variable length. When a process is brought into main memory, it allocates exactly as much memory as it requires. Each partition may contain exactly one process. The degree of multiprogramming is bound by the number of partitions. In this method when a partition is free a process is selected from the input queue and is loaded into the free partition. When the process terminates the partition becomes available for another process.

The problem with the dynamic memory allocation is that the memory becomes more and more fragmented and it leads to decline memory usage. This is called 'external fragmentation'.

Advantages	Disadvantages
<ul style="list-style-type: none"> • Partitions are changed dynamically. • It does not suffer from internal fragmentation. 	<ul style="list-style-type: none"> • It is a time consuming process (i.e., compaction). • Wasteful of processor time, because from time to time to move a program from one region to another in main memory without invalidating the memory references.

9.3.5. Placement Algorithm

They are algorithm used by the operating to decide which free block to allocate to a process. The below are Placement Algorithm.

Next-fit : it often leads to allocation of the largest block at the end of memory

First-fit: the algorithm favors allocation near the beginning of the main memory and it tends to create less fragmentation.

Best-fit searches for smallest block: the fragment left behind is small as possible, main memory quickly forms holes too small to hold any process.

Application Activity 9.3.

1. How is memory divided in the single contiguous memory management approach?
2. If, in a single contiguous memory management system, the program is loaded at address 30215, compute the physical addresses (in decimal) that correspond to the following logical addresses:
 - a) 9223 b) 2302 c) 7044
3. In a single contiguous memory management approach, if the logical address of a variable is L and the beginning of the application program is A, what is the formula for binding the logical address to the physical address?
4. If, in a fixed partition memory management system, the current value of the base register is 42993 and the current value of the bounds register is 2031, compute the physical addresses that correspond to the following logical addresses:
 - a) 104 b) 1755 c) 3041
5. Differentiate best fit and next fit allocation algorithms

9.4. MEMORY FRAGMENTATION

Learning Activity 9.4.

Followings are memory partition consecutively: 50 KB, 400 KB, 130 KB, 300 KB, 150 KB, and 70 KB (in that order). The following processes need to be assigned to the above partitions. The following memory space of each process (in order): A = 230 KB, B = 180 KB, C = 130 KB, D = 120 KB, E = 200 KB.

Using the first fit method. Processes have been allocated to partition as follows:

- 50 KB partition has no process assigned to it -> 50 KB free
- 400 KB partition is assigned to processes A and C -> 40 KB free
- 130 KB partition is assigned to process D -> 10 KB free
- 300 KB partition is assigned to process B -> 120 KB free
- 150 KB partition has no process assigned to it -> 150 KB free
- 70 KB partition has no process assigned to it -> 70 KB free

Answer the following questions:

1. Calculate the total amount of free memory?
2. Think of the way these wasted memory can be reused

9.4.1. Memory Fragmentation

Fragmentation occurs in a memory allocation system, when there are many of the free blocks of memory that are too small and these small blocks of memory cannot satisfy any request. There are two type of memory Fragmentation: internal fragmentation and external fragmentation

9.4.2. Internal Fragmentation

Internal Fragmentation: Internal fragmentation is the space wasted inside of allocated memory partition. The Allocated memory partition may be slightly larger than requested memory size. This difference in size is a memory internal to a partition, but which is not used.

Understand Internal Fragmentation

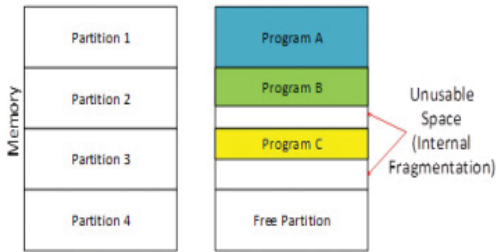

Figure 9.7. Memory internal fragmentation

Consider the figure above where partitions have fixed sized and three processes A, B, C. Processes are going to be assigned to the available partition and the 4th partition is still free. The below are steps used to assign partitions to 3 processes

Step 1: Process A matches the size of the partition, so there is no wastage in that partition.

Step 2: Process B and Program C are smaller than the partition size. So in partition 2 and partition 3 there is remaining free space.

However, this free space is unusable as the memory allocator only assigns full partitions to programs but not parts of it. This wastage of free space is called internal fragmentation.

9.4.3. External Fragmentation

External Fragmentation occurs when a process is allocated to a memory partition using dynamic memory allocation and a small piece of memory is left over that cannot be effectively used.

Understanding external fragmentation

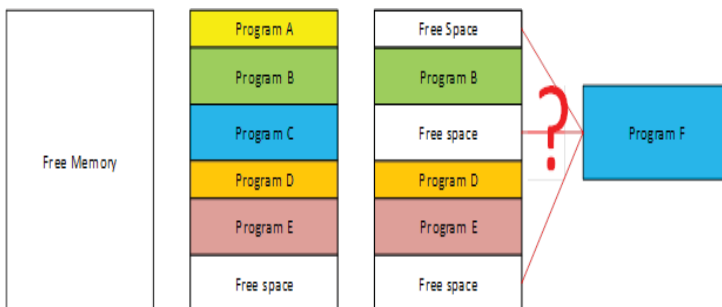

Figure 9.8. External fragmentation

In dynamic memory allocation, the allocator allocates only the exact needed size for that program. First memory is completely free. Then the processes A, B, C, D and E of different sizes are loaded one after the other and they are placed in memory contiguously in that order. Then later, process A and process C closes and they are unloaded from memory.

Now there are three free space areas in the memory, but they are not adjacent. Now a large process called process F is going to be loaded but neither of the free space block is not enough for process F. The addition of all the free spaces is definitely enough for process F, but due to the lack of adjacency that space is unusable for process F. This is called External Fragmentation.

9.4.4. Difference between Internal and External Fragmentation

The difference between Internal and External Fragmentation are following:

- Internal Fragmentation occurs when a fixed size memory allocation technique is used. External fragmentation occurs when a dynamic memory allocation technique is used.
- Internal fragmentation occurs when a fixed size partition is assigned to a program/file with less size than the partition making the rest of the space in that partition unusable. External fragmentation is due to the lack of enough adjacent space after loading and unloading of programs or files for some time because then all free space is distributed here and there.
- External fragmentation can be mined by compaction where the assigned blocks are moved to one side, so that contiguous space is gained. However, this operation takes time and also certain critical assigned areas for example system services cannot be moved safely. We can observe this compaction step done on hard disks when running the disk defragmenter in Windows.
- External fragmentation can be prevented by mechanisms such as segmentation and paging. Here a logical contiguous virtual memory space is given while in reality the files/programs are splitted into parts and placed here and there.
- Internal fragmentation can be maimed by having partitions of several sizes and assigning a program based on the best fit. However, still internal fragmentation is not fully eliminated.

Segmentation

Segmentation is a memory management technique in which each job is divided into several segments of different sizes, one for each module that contains pieces that perform related functions. Each segment is actually a different logical address space of the program.

When a process is to be executed, its corresponding segmentation are loaded into non-contiguous memory though every segment is loaded into a contiguous block of available memory.

Segmentation memory management works very similar to paging but here segments are of variable-length where as in paging pages are of fixed size.

A program segment contains the program's main function, utility functions, data structures, and so on. The operating system maintains a **segment map table** for every process and a list of free memory blocks along with segment numbers, their size and corresponding memory locations in main memory. For each segment, the table stores the starting address of the segment and the length of the segment. A reference to a memory location includes a value that identifies a segment and an offset.

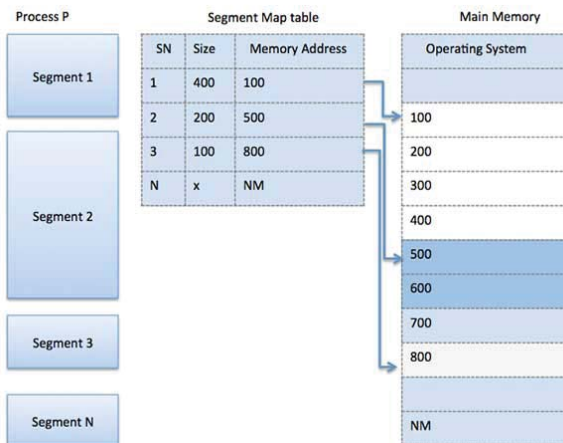

Figure 9.9 segmentation

Source: <https://www.tutorialspoint.com>

Swapping

Swapping is a mechanism in which a process can be swapped temporarily out of main memory (or move) to secondary storage (hard disk). The process makes that memory available to other processes. Later, the system can swap back the process from the secondary storage to main memory.

However performance is usually affected by swapping process, Swapping allow to run multiple and big processes in parallel. That's the reason Swapping is also known

as a technique for memory compaction.

The below figure explain how the swapping is achieved

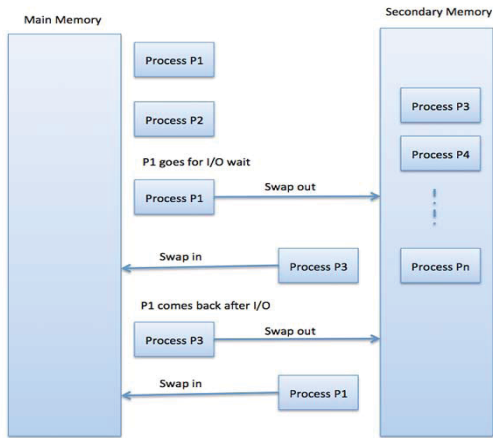

Figure 9.10: Swapping Mechanism

Source: <https://www.tutorialspoint.com>

Note that the total time taken by swapping process includes the time it takes to move the entire process to a secondary disk and then to copy the process back to memory, as well as the time the process takes to regain main memory.

Example:

Let us assume that the user process is of size 2048KB and on a standard hard disk where swapping will take place has a data transfer rate around 1 MB per second. The actual transfer of the 1000K process to or from memory will take

$$2048\text{KB} / 1024\text{KB per second} = 2 \text{ seconds} = 2000 \text{ milliseconds}$$

Now considering in and out time, it will take complete 4000 milliseconds plus other overhead where the process competes to regain main memory.

Application Activity 9.4.

1. What do you understand by the dynamic memory allocation?
2. Discuss fixed partitions?
3. Differentiate internal fragmentation and external fragmentation?
4. What is memory compaction? Discuss reason why memory compaction is used.

9.5. VIRTUAL MEMORY CONCEPTS

Learning Activity 9.5.

Observe below picture and answer follow question

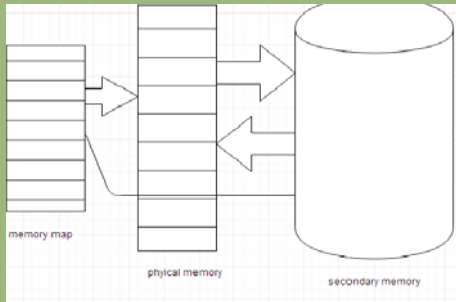

1. What do you think of picture above?
2. Discuss how a program is loaded from the secondary memory to the main memory?
3. Discuss the technic used by the operating system to move a process from the main memory to secondary memory?
4. Discuss what will happen if the program is greater than the main memory?

9.5.1. Memory segmentation

A Memory Management technique in which memory is divided into variable sized chunks which can be allocated to processes. Each chunk is called a **Segment**. A table stores the information about all such segments and is called **Segment Table**.

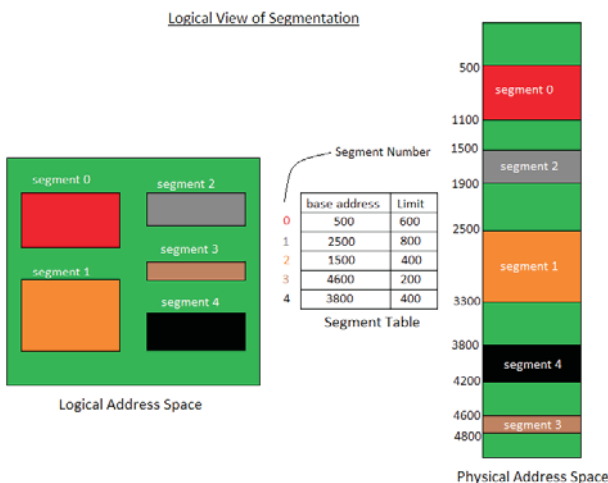

Figure 9.11.: logical view of segmentation

Source: <https://dreamcometrue.quora.com/Operating-Systems-Segmentation>

Segment Table: It maps two dimensional Logical address into one dimensional Physical address.

It's each table entry has

- **Base Address:** It contains the starting physical address where the segments reside in memory.
- **Limit:** It specifies the length of the segment.

Advantages of Segmentation:

- No Internal fragmentation.
- Segment Table consumes less space in comparison to Page table in paging.

Disadvantage of Segmentation:

- As processes are loaded and removed from the memory, the free memory space is broken into little pieces, causing External fragmentation.

9.5.2. Memory swapping

Swapping is a useful technique that enables operating system to execute programs by moving the program from and to the main memory. When the operating system needs data from the disk, it exchanges a portion of data (called a page or segment) in main memory with a portion of data on the disk.

9.5.3. Virtual memory

a. Understanding the virtual memory

Virtual memory is a technical concept that lets the execution of different processes which are not totally in memory. One main benefit of this method is that programs can be larger than the physical memory.

Virtual memory abstracts primary memory into a very large, consistent array of storage that divides logical memory as viewed by the user from that of physical memory. This technique is used to free programmers from the anxiety of memory storage limitations.

b. Uses of Virtual Memory

Virtual memory also permits processes for sharing files easily and for implementing shared memory. Moreover, it offers a well-organized mechanism for process creation. Virtual memory is not that easy to apply and execute. However, this technique may substantially decrease performance if it is not utilized carefully.

c. Virtual Address Space (VAS)

The virtual address space of any process is defined as the logical (or virtual) view of how any process gets stored in memory. Normally, this view is where a process begins at a certain logical address (addresses location 0) and then exists in contiguous memory.

Although, the fact is physical memory might be structured in the form of page frames and where the physical page frames are assigned to a process that may not be adjacent to each other. It depends on to the memory management unit (MMU) which maps logical pages to physical page frames in memory.

9.5.4. Concept of Demand Paging

Think of how an executable program could have loaded from within a disk into its memory. One choice would be to load the complete program in physical memory at program at the time of execution. However, there is a problem with this approach, that you may not at first need the entire program in memory. So the memory gets occupied unnecessarily.

An alternative way is to initially load pages only when they are needed / required. This method is termed as **demand paging**. It is commonly utilized in virtual memory systems.

Using this demand paged virtual memory, pages gets only loaded as they are demanded at the time of program execution; pages which are never accessed will never load into physical memory.

A demand paging scheme is similar to a paging system with swapping feature where processes exists in secondary memory (typically in a disk). As you want to execute any process, you swap it into memory internally. Rather than swapping the complete process into memory, you can use a “lazy swapper”. A “lazy swapper” in no way swaps a page into memory unnecessarily unless that page required for execution.

9.5.5. Hardware Required for the Concept of Demand Paging

The hardware required for supporting demand paging is the same that is required for paging and swapping:

- **Page table:** Page table has the capability to mark an entry invalid or unacceptable using a valid-invalid bit.

- **Secondary memory:** Secondary memory retains those pages which are not there in main memory. The secondary memory is generally a high-speed disk. It is also known as swap device and the segment of disk used for this purpose is termed as swap space.

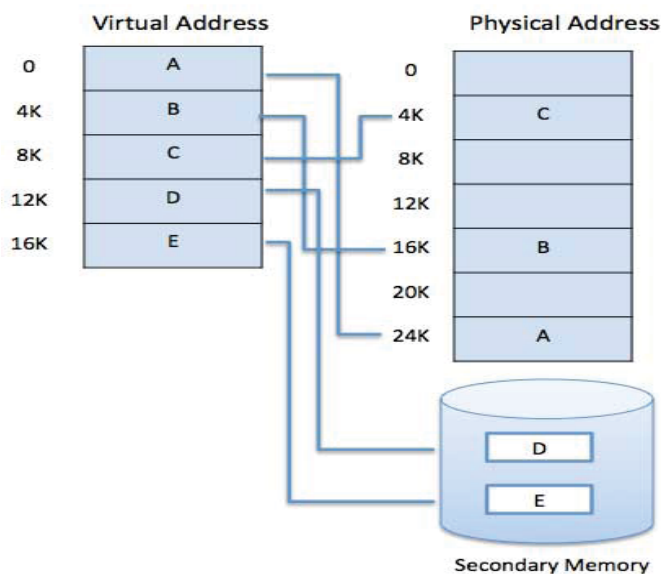

Figure 9.12.: Demand Paging
Source: <https://www.tutorialspoint.com>

The main advantage of the Virtual memory is that programs can allocate a memory larger than physical memory. Virtual memory serves two purposes:

- First, it allows extending the use of physical memory by using the hard disk.
- Second, it allows having memory protection, because each virtual address is translated to a physical address.

9.5.6. Paging

A computer can address more memory than the amount physically installed on the system. This extra memory is actually called virtual memory and it is a section of a hard that's set up to emulate the computer's RAM. Paging technique plays an important role in implementing virtual memory.

Paging is a memory management technique in which process address space is broken into blocks of the same size called pages (size is power of 2, between 512 bytes and 8192 bytes). The size of the process is measured in the number of pages.

Similarly, main memory is divided into small fixed-sized blocks of (physical) memory called frames and the size of a frame is kept the same as that of a page to have

optimum utilization of the main memory and to avoid external fragmentation.

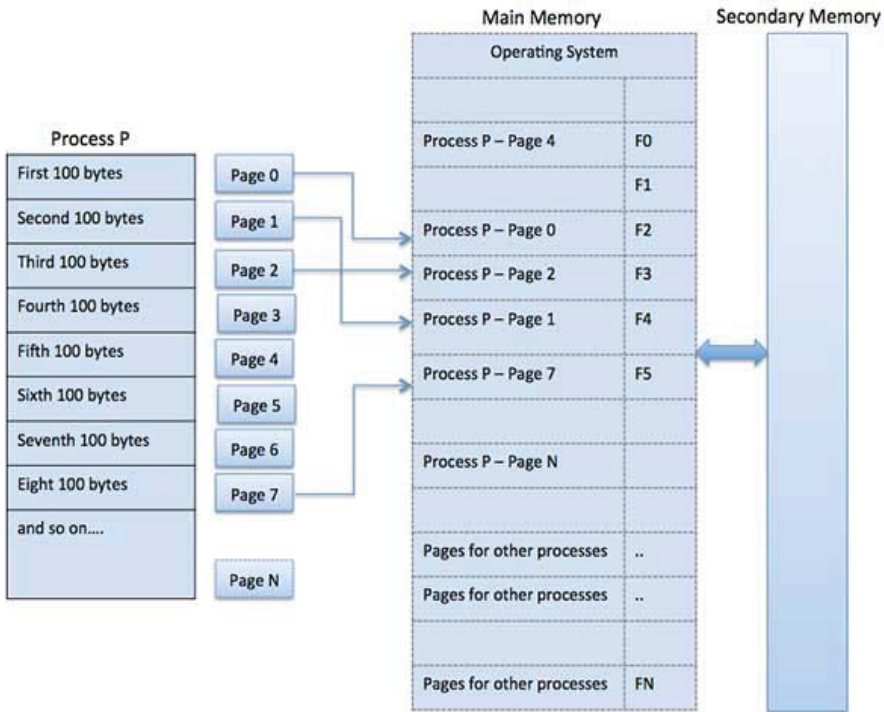

Figure 9.13: Paging
Source: <https://www.tutorialspoint.com>

Address Translation

Page address is called logical address and represented by page number and the offset.

$$\text{Logical Address} = \text{Page number} + \text{page offset}$$

Frame address is called physical address and represented by a frame number and the offset.

$$\text{Physical Address} = \text{Frame number} + \text{page offset}$$

A data structure called **page map table** is used to keep track of the relation between a page of a process to a frame in physical memory.

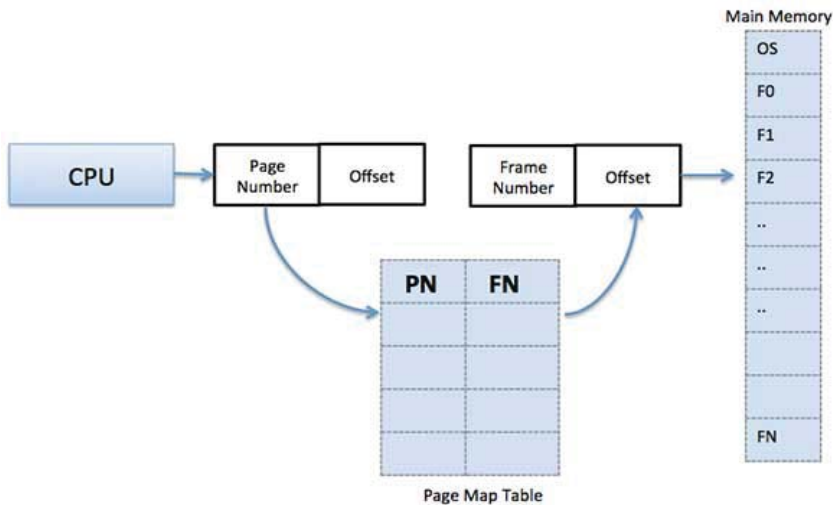

Figure 9.14.: Mapping

Source: <https://www.tutorialspoint.com>

When the system allocates a frame to any page, it translates this logical address into a physical address and creates entry into the page table to be used throughout execution of the program.

When a process is to be executed, its corresponding pages are loaded into any available memory frames. Suppose you have a program of 8Kb but your memory can accommodate only 5Kb at a given point in time, then the paging concept will come into picture. When a computer runs out of RAM, the operating system (OS) will move idle or unwanted pages of memory to secondary memory to free up RAM for other processes and brings them back when needed by the program.

This process continues during the whole execution of the program where the OS keeps removing idle pages from the main memory and write them onto the secondary memory and bring them back when required by the program.

Advantages and Disadvantages of Paging

Here is a list of advantages and disadvantages of paging:

- Paging reduces external fragmentation, but still suffer from internal fragmentation.
- Paging is simple to implement and assumed as an efficient memory management technique.
- Due to equal size of the pages and frames, swapping becomes very easy.

- Page table requires extra memory space, so may not be good for a system having small RAM.

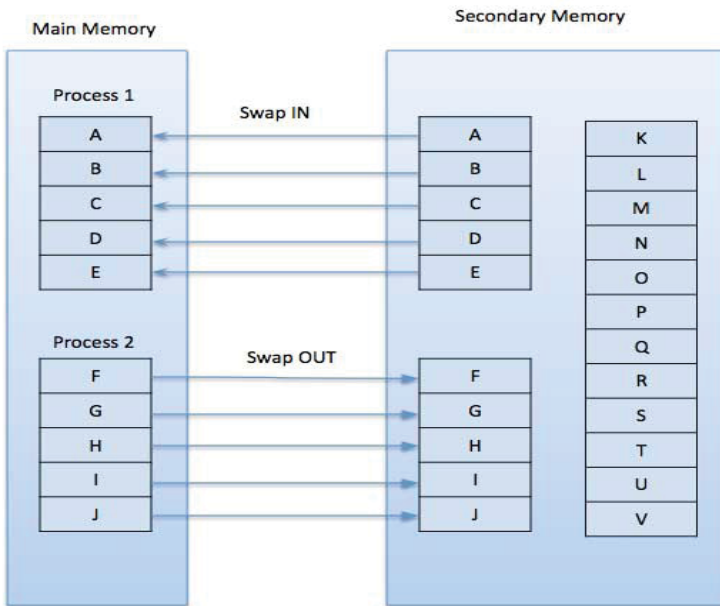

Figure 9.15.: Process execution using paging
Source: <https://www.tutorialspoint.com>

While executing a program, if the program references a page which is not available in the main memory because it was swapped out a little ago, the processor treats this invalid memory reference as a **page fault** and transfers control from the program to the operating system to demand the page back into the memory.

Advantages

Following are the advantages of Demand Paging –

- Large virtual memory.
- More efficient use of memory.

Application Activity 9.5.

4. What do you understand by the dynamic memory allocation?
5. Discuss fixed partitions?
6. Differentiate internal fragmentation and external fragmentation?
7. What is memory compaction? Discuss reason why memory compaction is

END UNIT ASSESSMENT

1. Explain the use of Dynamic loading in memory management?
2. Explain the memory Swapping?
3. Discuss the advantage of Dynamic Loading?
4. What do you understand by Dynamic Linking?
5. Explain external fragmentation and internal fragmentation?
6. What do you understand by Paging? Give advantages of paging in memory management?
7. Discuss Memory Compaction concept?
8. What are the differences between pager and swapper?
9. Define the virtual memory? What are advantages of virtual memory?
10. Consider a user program of logical address of size 6 pages and page size is 4 bytes. The physical address contains 300 frames. The user program consists of 22 instructions a, b, c . . . u, v. Each instruction takes 1 byte. Assume at that time the free frames are 7, 26, 52, 20, 55, 6, 18, 21, 70, and 90.

Find the following?

- a. Draw the logical and physical maps and page tables?
- b. Allocate each page in the corresponding frame?
- c. Find the physical addresses for the instructions m, d, v, r?
- d. Calculate the fragmentation if exist?



UNIT 10

COLLECTIONS IN JAVA

UNIT 10: COLLECTIONS IN JAVA

Key unit competency

To be able to use collections to store data in Java

Introductory Activity

Study the following scenario:

Urumuri Primary School in Gakenke District is a School with Administrators, Teachers and Students (Boys and Girls). The number of students changes every year. At lunch time, every student is called to have lunch and finally realizes that the served food is not the same for all.

1. Discuss on how the new comers will be assigned to classrooms and the outgoing students will be removed from the lists of students.
2. Suggest how the students will be called to get their lunch boxes
3. Show how the Stack theory can be implemented in the above Scenario.
4. Draw and explain the school organization structure.

10.1. INTRODUCTION TO THE COLLECTION FRAMEWORK

Learning Activity 10.1.

Discuss on the following java terms:

- A collection
- Java collection
- Framework
- Framework in Java
- Java collection Framework(JCF)

In Java, dynamically allocated data structures (such as ArrayList, LinkedList, Vector, Stack, HashSet, HashMap, Hashtable) are supported in a unified architecture called "Collection", a framework which mandates the common behaviors of all the classes. The collection framework provides a unified interface to store, retrieve and manipulate the elements of a collection, regardless of the underlying and actual imple-

mentation. This allows the programmers to program at the interfaces, instead of the actual implementation.

10.1.1. A collection

A collection is a data structure which contains and processes a set of data. The data stored in the collection is encapsulated and the access to the data is only possible via predefined methods.

10.1.2. Collections in java

Java Collection simply means a single unit of objects. It is a framework that provides an architecture to store and manipulate the group of objects. All the operations performed on data such as searching, sorting, insertion, manipulation, deletion, etc. can be performed by Java Collections.

10.1.3. Framework

Frameworks are large bodies of prewritten code to which new code is added to solve a problem in a specific domain.

A framework, or software framework, is a platform for developing software applications. It provides a foundation on which software developers can build programs for a specific platform. For example, a framework may include predefined classes and functions that can be used to process input, manage hardware devices, and interact with system software. This streamlines the development process since programmers don't need to reinvent the wheel each time they develop a new application.

10.1.4. Framework in java:

It provides a ready-made architecture and represents a set of classes and interface.

10.1.5. Java Collection framework (JFC):

The Java Collection Framework (JCF) is a collection of interfaces and classes in the packages `java.util` and `java.concurrent` which helps in storing and processing the data efficiently or a set of classes and interfaces that implement commonly reusable collection data structures and represents a single unit of objects. JFC provides both interfaces that define various collections and classes that implement them. Interfaces (Set, List, Queue, Map, etc.) and classes (ArrayList, Vector, LinkedList, PriorityQueue, Harshesh, LinkedHashSet, TreeSet, etc.) work in a manner of a library.

10.1.6. Structure of Java Collections Framework

Below is the diagram picturing the different collection classes and interface.

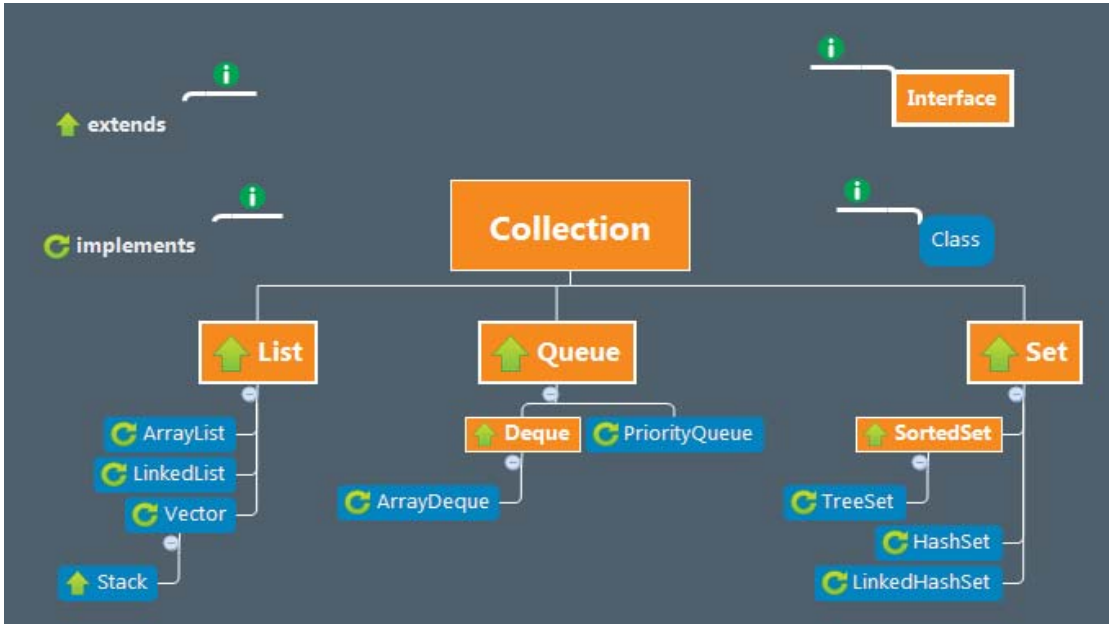

Application Activity 10.1.

1. Explain the following: Collection and Collections Framework.
2. What are the benefits of Java Collections Framework?
3. What are the basic interfaces of Java Collections Framework?
4. List at least 2 practices related to Java Collections Framework.
5. What is the use of Java Collections Framework?

10.2 Java - The collection interfaces and Classes

An interface is a contract (or a protocol, or a common understanding) of what the classes can do. When a class implements a certain interface, it promises to provide implementation to all the abstract methods declared in the interface. Interface defines a set of common behaviors. The classes implement the interface, agree to these behaviors and provide their own implementation to the behaviors. This allows to program at the interface, instead of the actual implementation.

10.2.1 Java Collections – List interface

Learning Activity 10.2.

We want to develop an application called Travel in which will display the travels from the traveling agency companies Alpha Ltd and Beta Ltd and place an order from customers.

Answer the following questions:

1. How should we design our application by considering the list interfaces?
2. What are the methods that will be used by/ the application to keep the travels for every company?
3. Display the travels available from vendors like "Alpha" and "Beta".

A List is an ordered Collection (sometimes called a sequence) of elements. The Lists may contain duplicate elements. The elements can be inserted or accessed by their position in the list, using a zero-based index. The `java.util.List` interface is a subtype of the `java.util.Collection` interface. It represents an ordered list of objects, meaning that the elements of a List can be accessed in a specific order, and by an index too. The same element can be added more than once to a List.

The Java platform contains two general-purpose List implementations. **ArrayList** which is usually the better-performing implementation, and **LinkedList** which offers better performance under certain circumstances.

Here are examples of how to create a List instance:

- `List listA = new ArrayList ();`
- `List listB = new LinkedList ();`

10.2.1.1 Java ArrayList class

a. Understanding the ArrayList Class

The `ArrayList` class extends `AbstractList` and implements the List interface. The `ArrayList` supports dynamic arrays that can grow as needed and it contains duplicate elements. The Array lists are created with an initial size. When this size is exceeded, the collection is automatically enlarged. When objects are removed, the array may be shrunk. The Java `ArrayList` class uses a dynamic array for storing the elements.

An array averts many of the most common problems of working with arrays, specifically the following:

- An array list automatically resizes itself whenever necessary;
- An array list allows to insert elements into the middle of the collection
- An array list lets the items to be deleted. When an item is deleted from an array list, any subsequent items in the array are automatically moved forward one position to fill the spot that was occupied by the deleted item.
- The ArrayList class uses an array internally to store the data added to the array list: When an item is added to the array list, and the underlying array is full, the ArrayList class automatically creates a new array with a larger capacity and copies the existing items to the new array before it adds the new item.

b. ArrayList has three constructors:

Constructor	Description
ArrayList ()	It creates an empty ArrayList
ArrayList(Collection c)	It is used to build an array list that is initialized with the elements of the collection c.
ArrayList(int capacity)	It is used to build an array list that has the specified initial capacity.

c. Methods of Java ArrayList class

There are number of methods available which can be used directly using object of ArrayList class. Some of the important ones are:

SN	Methods of Java ArrayList class	Description
1	add (Object o):	This method adds an object o to the arraylist.
2	add (int index, Object o):	It adds the object o to the array list at the given index.
3	remove(Object o):	Removes the object o from the ArrayList.
4	remove (int index):	Removes element from a given index.
5	set (int index, Object o):	Used for updating an element. It replaces the element present at the specified index with the object o.
8	Object get(int index):	It returns the object of list which is present at the specified index.

9	int size():	It gives the size of the ArrayList – Number of elements of the list.
11	clear():	It is used for removing all the elements of the array list in one go. The below code will remove all the elements of ArrayList whose object is obj

d. Creating, declaring an ArrayList Object

To create an array list, an ArrayList variable is firstly declared and the ArrayList constructor is called to instantiate an ArrayList object and assign it to the variable.

```
ArrayList signs = new ArrayList();
```

Here are a few things to note about creating array lists:

- The ArrayList class is in the java.util package, so the program must import either java.util.ArrayList or java.util.*.
- Unlike an array, an array list doesn't make the user specify a capacity even if it is possible.

Example that creates an array list with an initial capacity of 100:

```
ArrayList signs = new ArrayList(100);
```

e. Adding Elements

After an array list is created, the add method to add objects to the array list is the used. An array lists is indexed starting with zero and when it is already at its capacity when an element is added, the array list automatically expands its capacity.

Example: `signs.add("Peter");`

If a type when is specified during the creation of the array list, the added objects via the add method must be of the correct type. An object can be inserted at a specific position in the list by listing the position in the add method.

Syntax: `ArrayList<String>nums = new ArrayList<String>();`

f. Accessing Elements

To access a specific element in an array list, the get method can be used, which specifies the index value of the element to be retrieved. Here's a for loop that prints all the strings in an array list:

```
for (inti = 0; i<nums.size(); i++)
```

```
System.out.println(nums.get(i));
```

Here the size method is used to set the limit of the for loop's index variable. The easiest way to access all the elements in an array list is to use an enhanced "for" statement, which allows to retrieve the elements without bothering with indexes or the get method.

For example:

```
For (String s: nums)
```

```
System.out.println(s);
```

To know the index number of a particular object in an array list a reference to the object is known, the indexOf method is used.

g. Printing an ArrayList

Arrays are usually useful when working with arbitrarily large number of data having the same type. It is usually convenient if we can print the contents of an array.

```
package printarraylist;
import java.util.*;
public class PrintArrayList {
    public static void main (String[] args) {
        ArrayList<String> nums = new ArrayList<String>();
        nums.add("One");
        nums.add("Two");
        nums.add("Three");
        nums.add("Four");
        System.out.println(nums);
    }
}
```

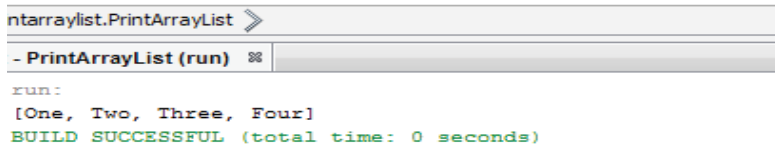

```
ntarraylist.PrintArrayList >
- PrintArrayList (run)
run:
[One, Two, Three, Four]
BUILD SUCCESSFUL (total time: 0 seconds)
```

- **Print Array In Java Using Default toString()**

The toString method of the ArrayList class (as well as other collection classes) is designed to make it easy to quickly print out the contents of the list. It returns the contents of the array list enclosed in a set of brackets, with each element value separated by commas. The toString method of each element is called to obtain the element value.

Below is a Simple Program That Prints An Array In Java using Arrays.toString().

```

package printingarraylist;
import java.util.Arrays;
public class Printingarraylist {
private static void printArray(int[] anArray) {
    System.out.println(Arrays.toString(anArray));
}
public static void main(String[] args) {
int[] testArray = { 1, 2, 3, 4, 5, 6, 7, 8, 9, 10 };
printArray(testArray);
}
}

```

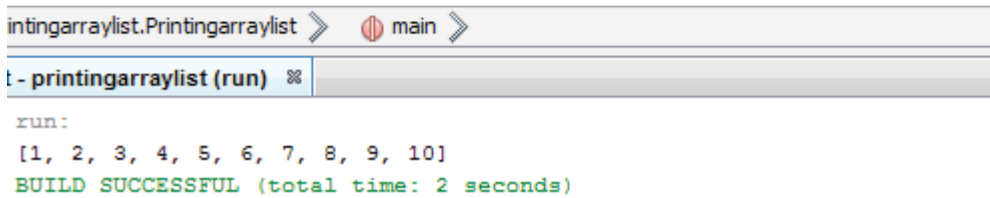

```

printingarraylist.Printingarraylist > main >
t - printingarraylist (run) %
run:
[1, 2, 3, 4, 5, 6, 7, 8, 9, 10]
BUILD SUCCESSFUL (total time: 2 seconds)

```

The following is generalArrayList Example in Java

```

package arraylist1;
import java.util.*;
public class ArrayList1 {
    public static void main(String[] args) {
        /*Creation of ArrayList: I'm going to add String elements so I made it of string type */
        ArrayList<String>obj = new ArrayList<String>();
        /*This is how elements should be added to the array list*/
        obj.add("Peter");
        obj.add("TOM");
        obj.add("Jim");
        obj.add("Alice");
        obj.add("Sam");
        /* Displaying or Printing an array list element */
        System.out.println("Currently the array list has following elements:"+obj);
        /*Add element at the given index*/
        obj.add(0, "Kayiranga");
        obj.add(1, "Damas");
    }
}

```

```

/*Remove elements from array list like this*/
obj.remove("Peter");
obj.remove("Tom");
System.out.println("Current array list is:"+obj);
/*Remove element from the given index*/
obj.remove(1);
System.out.println("Current array list is:"+obj);
}
}

```

Output:

```

Input - arraylistz (run)
run:
Currently the array list has following elements:[Peter, TOM, Jim, Alice, Sam]
Current array list is:[Kayiranga, Damas, TOM, Jim, Alice, Sam]
Current array list is:[Kayiranga, TOM, Jim, Alice, Sam]
BUILD SUCCESSFUL (total time: 0 seconds)

```

10.2.1.2. Java - LinkedList class

The Linked list implementation of the List interface implements all optional List operations and permits all elements (including null). In addition to implementing the List interface, LinkedList provides uniformly named methods to get, remove and insert an element at the beginning and end of the List. These operations allow LinkedList to be used as a stack, queue, or double-ended queue (deque). It provides a linked-list data structure and inherits the AbstractList class.

a. Creating, declaring a LinkedList

As with any other kind of object, creating a linked list is a two-step affair. First, declare a LinkedList variable; then call one of the LinkedList constructors to create the object, as in this example:

LinkedList officers = new LinkedList (); // Here a linked list is created and assigned to the variable officers.

Here's a statement that creates a linked list that holds strings:

LinkedList<String> officers = new LinkedList<String> ();

Then add only String objects to this list.

b. Adding Items to a LinkedList

The LinkedList class gives many ways to add items to the list. The most basic is the add method, which works pretty much the same way that it does for the ArrayList class.

Here's an example:

```
public class LinkedList {
    public static void main(String[] args) {
        LinkedList<String> officers = new
        LinkedList<String>();
        officers.add("James");
        officers.add("Peter");
        officers.add("Tom");
        for (String s: officers)
            System.out.println(s);
    }
}
```

The add method adds these items to the end of the list. So the resulting output is this:

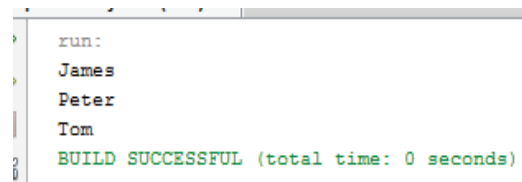

```
run:
James
Peter
Tom
BUILD SUCCESSFUL (total time: 0 seconds)
```

The addLast method works the same way, but the addFirst method adds items to the front of the list. Consider these statements:

```
import java.util.*;
public class Arraylist {
    public static void main(String[] args) {
        LinkedList<String> officers = new
        LinkedList<String>();
        officers.addFirst("James");
        officers.addFirst("Peter");
        officers.addFirst("Tom");
        for (String s: officers)
            System.out.println(s);
    }
}
```

Here the resulting output shows the officers in reverse order:

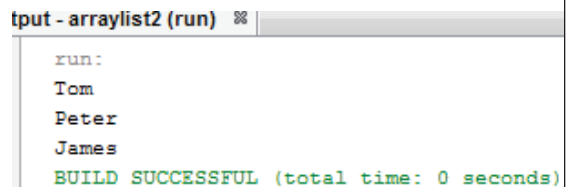

```
tput - arraylist2 (run) x
run:
Tom
Peter
James
BUILD SUCCESSFUL (total time: 0 seconds)
```

To insert an object into a specific position into the list, specify the index in the add method, as in this example:

<pre>import java.util.*; public class ArrayList2 { public static void main(String[] args) { LinkedList<String> officers = new LinkedList<String>(); officers.add("James"); officers.add("Peter"); officers.add("Tom"); officers.add(2, "John"); for (String s: officers) System.out.println(s); } }</pre>	<p>The console output from these statements is this:</p> <pre>run: James Peter John Tom BUILD SUCCESSFUL (total time: 0 seconds)</pre>
---	--

c. Retrieving Items from a LinkedList

Get method is used to retrieve an item based on its index. If an invalid index number is passed to it, the get method throws the unchecked `IndexOutOfBoundsException`. An enhanced "for" loop to retrieve all the items in the linked list can also be used. The examples in the preceding section use this enhanced for loop to print the contents of the officers linked list:

```
for (String s: officers)
System.out.println(s);
```

Some methods retrieve the first item in the list:

Method	Description
getFirst	Retrieves the first item from the list. This method doesn't delete the item. If the list is empty, <code>NoSuchElement-Exception</code> is thrown
element:	Identical to the getFirst method.
peek:	Similar to getFirst but doesn't throw an exception if the list is empty.
peekFirst:	Identical to peek. Only the name of the method is changed to protect the innocent.
remove:	Similar to getFirst but also removes the item from the list. If the list is empty, it throws <code>NoSuchElementException</code> .

d. Updating LinkedList Items

As with the ArrayList class, the set method can be used to replace an object in a linked list with another object.

<pre>officers.add("Peter"); officers.add("Jim"); officers.add("Tom"); System.out.println("the original officers are:"); System.out.println(officers); // replace Tom with John officers.set (2, "John"); System.out.println("Tom is replaced:"); System.out.println(officers); } }</pre>	<p>The output from this code looks like this:</p> <pre>run: the original officers are: [Peter, Jim, Tom] Tom is replaced: [Peter, Jim, John] BUILD SUCCESSFUL (total time: 0 seconds)</pre>
--	---

e. Removing LinkedList Items

Several of the methods that retrieve items from a linked list and also remove the items have been seen. The remove, removeFirst, and poll methods remove the first item from the list, and the removeLast method removes the last item. Any arbitrary item can be removed by specifying either its index number or a reference to the object to be removed on the remove

method. To remove item 3, for example, use a statement like this:

officers.remove(3);

If a reference to the item to be removed is there, use the remove method, like this:

officers.remove(Jim);

To remove all the items from the list, use the clear method:

officers.clear();

The following program illustrates several of the methods supported by LinkedList and support above collection method:

<pre> package linked list; import java.util.*; public class Linkedlist { public static void main(String args[]) { // create a linked list LinkedList ll = new LinkedList(); // add elements to the linked list ll.add("F"); ll.add("B"); ll.add("D"); ll.add("E"); ll.add("C"); ll.addLast("Z"); ll.addFirst("A"); ll.add(1, "A2"); System.out.println("Original contents of ll: " + ll); // remove elements from the linked list ll.remove("F"); ll.remove(2); </pre>	<pre> System.out.println("Contents of ll after deletion: " + ll); // remove first and last elements ll.removeFirst(); ll.removeLast(); System.out.println("ll after deleting first and last: " + ll); // get and set a value Object val = ll.get(2); ll.set(2, (String) val + " Changed"); System.out.println("ll after change: " + ll); } </pre> <p>Output:</p> <pre> run: Original contents of ll: [A, A2, F, B, D, E, C, Z] Contents of ll after deletion: [A, A2, D, E, C, Z] ll after deleting first and last: [A2, D, E, C] ll after change: [A2, D, E Changed, C] BUILD SUCCESSFUL (total time: 5 seconds) </pre>
--	--

f. Java LinkedList Example: Book

```

import java.util.*;
class Book {
    int id;
    String book_title, author, publisher;
    int quantity;
    public Book(int id, String book_title, String author, String publisher, int quantity) {
        this.id = id;
        this.book_title = book_title;
        this.author = author;
        this.publisher = publisher;
        this.quantity = quantity;
    }
}

```

```

public class LinkedListExample {
public static void main(String[] args) {
    //Creating list of Books
    List<Book> list=new LinkedList<Book>();
    //Creating Books
    Book b1=new Book(101,"Introduction to Java","Martin",10);
    Book b2=new Book(102,"Data Communications & Networking","James","Alph"4);
    Book b3=new Book(103,"Operating System","John","Samuel",6);
    //Adding Books to list
    list.add(b1);
    list.add(b2);
    list.add(b3);
    //Traversing list
    for(Book b:list){
        System.out.println(b.id+" "+b. book_title + " "+b.author+ " "+b.publisher+ " "+b.quantity);
    } } }

```

10.2.1.3 Java - vector class

Vectors (the `java.util.Vector` class) are commonly used instead of arrays, because they expand automatically when new data is added to them. If a primitive type in a Vector is to be put, put it inside an object (eg, to save an integer value use the Integer class or define your own class).

The `java.util.Vector` class implements a dynamic array of objects. Similar to an Array, it contains components that can be accessed using an integer index. The size of a Vector can grow or shrink as needed to accommodate adding and removing items. Vector is synchronized. This means that if one thread is working on Vector, no other thread can get a hold of it. Unlike ArrayList, only one thread can perform an operation on vector at a time.

Class declaration for `java.util.Vector` class

a. Class constructors

Constructor	Description
<code>Vector()</code>	Creates a default vector for which initial capacity is 10.

Vector(int size)	Creates a vector whose initial capacity is specified by size.
Vector(int size, intincr)	Creates a vector whose initial capacity is specified by size and increment is specified by incr. It specifies the number of elements to allocate each time that a vector is resized upward.
Vector(Collection c)	Creates a vector that contains the elements of collection c

There exist Vector class methods which are used in Java collections. Here is an example of how these methods are used:

Example that can support some of the above said method:

```

package vector;
import java.util.*;
public class Vector {
    public static void main(String args[]){
        // initial size is 3, increment is 2
        java.util.Vector v = new java.util.Vector(3, 2);
        System.out.println("Initial size: " + v.size());
        System.out.println("Initial capacity: " +
            v.capacity());
        v.addElement(new Integer(1));
        v.addElement(new Integer(2));
        v.addElement(new Integer(3));
        v.addElement(new Integer(4));
        System.out.println("Capacity after four
            additions: " + v.capacity());
        v.addElement(new Double(5.45));
        System.out.println("Current capacity: " +
            v.capacity());
        v.addElement(new Double(6.08));
        v.addElement(new Integer(7));
        System.out.println("Current capacity: " +
            v.capacity());
        v.addElement(new Float(9.4));
        v.addElement(new Integer(10));
        System.out.println("Current capacity: " +
            v.capacity());
        v.addElement(new Integer(11));
        v.addElement(new Integer(12));
        System.out.println("First element: " +
            (Integer)v.firstElement());
        System.out.println("Last element: " +
            (Integer)v.lastElement());
        if(v.contains(new Integer(3)))
            System.out.println("Vector contains 3.");
        v.addElement(new Integer(11));
        v.addElement(new Integer(12));
        System.out.println("First element: " +
            (Integer)v.firstElement());
        System.out.println("Last element: " +
            (Integer)v.lastElement());
        if(v.contains(new Integer(3)))
            System.out.println("Vector contains 3.");
    }
}

```

```
// enumerate the elements in the vector.
Enumeration vEnum = v.elements();
System.out.println("\nElements in vector:");
while(vEnum.hasMoreElements())
System.out.print(vEnum.nextElement() + "
");
System.out.println();
}
}
```

The output

```
it - vector (run) %
run:
Initial size: 0
Initial capacity: 3
Capacity after four additions: 5
Current capacity: 5
Current capacity: 7
Current capacity: 9
First element: 1
Last element: 12
Vector contains 3.

Elements in vector:
1 2 3 4 5.45 6.08 7 9.4 10 11 12
BUILD SUCCESSFUL (total time: 0 seconds)
```

Application Activity 10.2.

1. Discuss when to use ArrayList and LinkedList in Java?
2. Write a program that do the following:
 - Create linkedList from linked list with assigned to the variable district.
 - Add the following district in the List (Gakenke, Rubavu, Gasabo, Nyagatare, Nyabihu)
 - Add Bugesera District to the front of list and Karongi to the 4th position
 - Replace Gasabo District with Nyarugenge
 - Retrieving the Second District using Index
 - Show the Size and Remove the last district in the List

Note: After every operation display output

3. What are similarities and difference between ArrayList and Vector?

10.2.2. Java Collections – Set interface and implementations

Learning Activity 10.3.

Study the following part of Java Program and answer the following?

```
Set setA = new HashSet ();
String element = "element 1";
setA.add(element);
System.out.println(setA.contains(element));
```

1. Outline the method used in the above program?
2. What is HashSet in the above program?
3. List and explain Set implementations using by Internet or books help

Basically, a Set is a type of collection that does not allow duplicate elements. That means an element can only exist once in a Set. It models the set abstraction in mathematics. A Set is an unordered collection of objects.

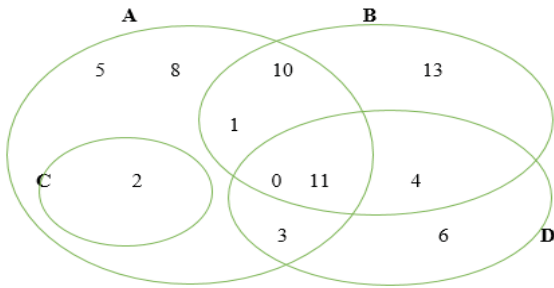

a. The following are the methods that are declared by a set:

Method	Description
add():	Adds an object to the collection.
clear():	Removes all objects from the collection.
contains():	Returns true if a specified object is an element within the collection.
isEmpty():	Returns true if the collection has no elements.
iterator():	Returns an Iterator object for the collection, which may be used to retrieve an object.
remove():	Removes a specified object from the collection.
size():	Returns the number of elements in the collection.

b. Set Implementations

The Java Collections Framework provides three major implementations of the Set interface: **HashSet**, **LinkedHashSet** and **TreeSet**.

1. Java - HashSet class

This class implements the Set interface backed by a hash table, It creates a collection that uses a hash table for storage. A hash table stores information by using a mechanism called hashing. In hashing, the informational content of a key is used to determine a unique value, called its hash code.

The following table lists the constructors associated with Java HashSet:

Constructor	Description
HashSet()	It is used to construct a default HashSet.

HashSet(Collection c)	It is used to initialize the hash set by using the elements of the collection c.
HashSet(int capacity)	It is used to initialize the capacity of the hash set to the given integer value capacity. The capacity grows automatically as elements are added to the HashSet.

The methods of Java HashSet are:

Method	Description
void clear()	It is used to remove all of the elements from this set.
boolean contains(Object o)	It is used to return true if this set contains the specified element.
boolean add(Object o)	It is used to add the specified element to this set if it is not already present.
boolean isEmpty()	It is used to return true if this set contains no elements.
boolean remove(Object o)	It is used to remove the specified element from this set if it is present.
Object clone()	It is used to return a shallow copy of this HashSet instance: the elements themselves are not cloned.
Iterator iterator()	It is used to return an iterator over the elements in this set.
int size()	It is used to return the number of elements in this set.

The following program illustrates several of the methods supported by HashSet

<pre>import java.util.*; package hash; import java.util.*; public class Hash { public static void main(String[] args) { // create a hash set HashSet hs = new HashSet(); // add elements to the hash set hs.add("B"); hs.add("A"); hs.add("D");</pre>	<pre>hs.add("E"); hs.add("C"); hs.add("F"); System.out.println(hs); }} output - hashset (run) ✖ run: [A, B, C, D, E, F] BUILD SUCCESSFUL (total time: 0 seconds) </pre>
---	---

Java HashSet Example: Book

This is a HashSet example where we are adding books to set and printing all the books.

```
import java.util.*;
class Book {
int id;
String book_title,author,publisher;
int quantity;
public Book(int id, String book_title, String author, String publisher, int quantity) {
    this.id = id;
    this.book_title = book_title;
    this.author = author;           //The body of class constructor
    this.publisher = publisher;
    this.quantity = quantity;
} }
public class HashSetExample {
public static void main(String[] args) {
    HashSet<Book> set=new HashSet<Book>();
    //Creating Books
    Book b1=new Book(101,"Introduction to Java","Martin",10);
    Book b2=new Book(102,"Data Communications & Networking","James","Alph"4);
    Book b3=new Book(103,"Operating System","John","Samuel",6);
    //Adding Books to HashSet
    set.add(b1);
    set.add(b2);
    set.add(b3);
    //Traversing HashSet
    for(Book b:set){
        System.out.println(b.id+" "+b.book_title+" "+b.author+" "+b.publisher+" "+b.quantity; } }
}
```

Output

101 Introduction to Java Martin 10
102 Data Communications & Networking James Alpha 4
103 Operating System John Samuel 6

10.2.2.2. Java LinkedHashSet Class

Java LinkedHashSet class is a Hash table and Linked list implementation of the set interface. It inherits HashSet class and implements Set interface.

The important points about Java LinkedHashSet class are:

- Contains unique elements only like HashSet.
- Provides all optional set operations, and permits null elements.
- Maintains insertion order.

LinkedHashSet class is declared like this:

```
public class LinkedHashSet<E> extends HashSet<E> implements Set<E>, Cloneable, Serializable  
LinkedHashSet<String> hs = new LinkedHashSet<String>();
```

Constructors of Java LinkedHashSet class

Constructor	Description
HashSet()	It is used to construct a default HashSet.
HashSet(Collection c)	It is used to initialize the hash set by using the elements of the collection c.
LinkedHashSet(int capacity)	It is used to initialize the capacity of the linkedhashset to the given integer value capacity.
LinkedHashSet(int capacity, float fillRatio)	It is used to initialize both the capacity and the fill ratio (also called load capacity) of the hash set from its argument.

Unlike HashSet, LinkedHashSet builds a link-list over the hash table for better efficiency in insertion and deletion (in the expense of more complex structure). It maintains its elements in the insertion-order (i.e., order of add()).

<pre> package linkedhashset; import java.util.LinkedHashSet; public class Linkedhashset { public static void main(String[] args) { LinkedHashSet<String>linkedset = new LinkedHashSet<String>(); // Adding element to LinkedHashSet linkedset.add("A"); linkedset.add("B"); linkedset.add("C"); linkedset.add("D"); //This will not add new element as A already exists linkedset.add("A"); linkedset.add("E"); System.out.println("Size of LinkedHashSet = " + linkedset.size()); System.out.println("Original </pre>	<pre> LinkedHashSet:" + linkedset); System.out.println("Removing D from LinkedHashSet: " + linkedset. remove("D")); System.out.println("Trying to Remove Z which is not "+"present: " + linkedset.remove("Z")); System.out.println("Checking if A is present=" + linkedset.contains("A")); System.out.println("Updated LinkedHashSet: " + linkedset); } } } Output: </pre> <div style="border: 1px solid gray; padding: 5px; margin-top: 5px;"> <pre> out - linkedhashset (run) % run: Size of LinkedHashSet = 5 Original LinkedHashSet: [A, B, C, D, E] Removing D from LinkedHashSet: true Trying to Remove Z which is not present: false Checking if A is present=true Updated LinkedHashSet: [A, B, C, E] BUILD SUCCESSFUL (total time: 0 seconds) </pre> </div>
--	--

Java LinkedHashSet Example: Book

```

import java.util.*;
class Book {
int id;
String book_title,author,publisher;
int quantity;
public Book(int id, String book_title, String author, String publisher, int quantity) {
this.id = id;
this.book_title = book_title;
this.author = author;
this.publisher = publisher;
this.quantity = quantity;
}
}

```

```

public class LinkedHashSetExample {
public static void main(String[] args) {
    LinkedHashSet<Book> hs=new LinkedHashSet<Book>();
    //Creating Books
    Book b1=new Book(101,"Introduction to Java","Martin",10);
    Book b2=new Book(102,"Data Communications & Networking","James","Alpha"4);
    Book b3=new Book(103,"Operating System","John","Samuel",6);
    //Adding Books to hash table
    hs.add(b1);
    hs.add(b2);
    hs.add(b3);
    //Traversing hash table
    for(Book b:hs){
System.out.println(b.id+" "+b. book_title +""+b.author+""+b.publisher+""+b.quantity);
    }}
}

```

Output

```

101Introduction to JavaMartin 10
102 Data Communications & Networking James Alpha 4
103 Operating System John Samuel 6

```

10.2.3. Java-class TreeSet class

The Java TreeSet class implements the Set interface that uses a tree for storage. It inherits AbstractSet class and implements NavigableSet interface. The objects of TreeSet class are stored in ascending order.

a. Constructors of Java TreeSet class

Constructor	Description
TreeSet()	It is used to construct an empty tree set that will be sorted in an ascending order according to the natural order of the tree set.

TreeSet(Collection c)	It is used to build a new tree set that contains the elements of the collection c.
TreeSet(Comparator comp)	It is used to construct an empty tree set that will be sorted according to given comparator.
TreeSet(SortedSetss)	It is used to build a TreeSet that contains the elements of the given SortedSet.

b. Some Methods of Java TreeSet

Method	Description
boolean addAll(Collection c)	It is used to add all of the elements in the specified collection to this set.
boolean contains(Object o)	It is used to return true if this set contains the specified element.
boolean isEmpty()	It is used to return true if this set contains no elements.
boolean remove(Object o)	It is used to remove the specified element from this set if it is present.
void add(Object o)	It is used to add the specified element to this set if it is not already present.

Set has its implementation in various classes like HashSet, TreeSet, LinkedHashSet. The following is an example to explain Set functionality

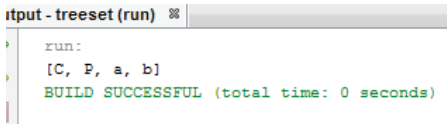
<pre>package treeset; import java.util.*; public class TreeSet { public static void main (String[] args) { ArrayList addletter = new ArrayList(); addletter.add("a"); addletter.add("b"); addletter.add("P"); addletter.add("C");</pre>	<pre>addletter.add("C"); //will not be added // Creating a TreeSet object from ArrayList TreeSet letter = new TreeSet(addletter); // [Compiler,GeeksQuiz,GeeksforGeeks, Practice] System.out.println(letter); } } Output:</pre> 
--	---

10.2.2.4. The difference between Set and List is:

- List is a collection class which extends AbstractList class whereas Set is a collection class which extends AbstractSet class, but both implements Collection interface.
- List interface allows duplicate values (elements) whereas Set interface does not allow duplicate values which means that List can contain duplicate elements whereas Set contains unique elements only
- Set is unordered while List is ordered. List maintains the order in which the objects are added.

Application Activity 10.3.

1. What is the output of this program?

```
import java.util.*;
class Output
{
public static void main(String args[])
{
HashSetobj = new HashSet();
obj.add("A");
obj.add("B");
obj.add("C");
System.out.println(obj + " " + obj.size());
}
}
```

2. What is the difference between a HashSet and a TreeSet?

10.2.3 Java Collections – Map interface

Learning Activity 10.4.

Study the following part of Java Program and answer the following questions?

```
Map<Integer, String>mapmarks = new HashMap<>();
mapmarks.put(80, "tom");
mapmarks.put(75, "Alice");
mapmarks.put(65, "Antoine");
mapmarks.put(50, "peter");
System.out.println(mapmarks);
```

1. Outline the method used in the above program;
2. What is HashMap in the above program?
3. List and explain Map implementations by using Internet connection or books.
4. Analyze the program and give the output.

A Map is a collection or an object that maps keys to values. A map cannot contain duplicate keys: Each key can map to at most one value. Maps are perfectly for key-value association mapping such as dictionaries. Use Maps when there is a need to retrieve and update elements by keys, or perform lookups by keys.

A Map is an object that maps keys to values or is a collection of attribute-value pairs. It models the function abstraction in mathematics. The following picture illustrates a map:

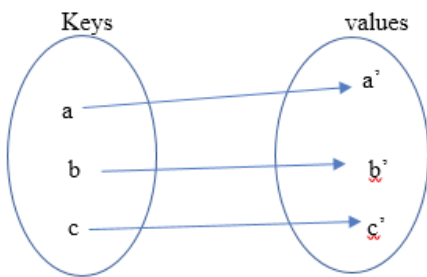

A map models mathematical function abstraction

Note that a Map is not considered to be a true collection, as the Map interface does not extend the Collection interface.

Methods of Map:

Method	Description
public Object put(Object key, Object value)	is used to insert an entry in this map.
public void putAll(Map map)	is used to insert the specified map in this map
public Object remove(Object key)	is used to delete an entry for the specified key.
public Object get(Object key)	is used to return the value for the specified key.

<code>public boolean containsKey(Object key)</code>	is used to search the specified key from this map.
<code>public Set keySet()</code>	returns the Set view containing all the keys.
<code>public Set entrySet()</code>	returns the Set view containing all the keys and values.

The next is a Java program to demonstrate how Map interface works

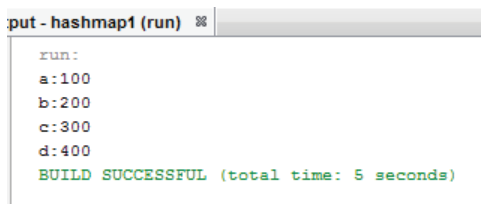
<pre> package hashmap; import java.util.*; public class Hashmap { public static void main(String[] args) { HashMap<String,Integer>hm = new HashMap<String,Integer>(); hm.put("a", new Integer(100)); hm.put("b", new Integer(200)); hm.put("c", new Integer(300)); hm.put("d", new Integer(400)); // Returns Set view Set<Map.Entry<String,Integer>>st = hm.entrySet(); for (Map.Entry<String,Integer>me:st) { System.out.print(me.getKey()+":"); System.out.println(me.getValue()); } } } </pre>	<p>Output:</p>  <pre> run: a:100 b:200 c:300 d:400 BUILD SUCCESSFUL (total time: 5 seconds) </pre>
---	--

a. Map implementation

The Java platform contains three general-purpose Map implementations: HashMap, TreeMap, and LinkedHashMap. Their behavior and performance are precisely analogous to HashSet, TreeSet, and LinkedHashSet, as described in The Set Interface section. A Map cannot contain duplicate keys and each key can map to at most one value. Some implementations allow null key and null value (HashMap and LinkedHashMap) but some does not (TreeMap). The order of a map depends on specific implementations, e.g TreeMap and LinkedHashMap have predictable order, while HashMap does not.

10.2.3.1. Java - HashMap Class

This implementation uses a hash table as the underlying data structure. It implements all of the Map operations and allows null values and one null key. This class is roughly equivalent to Hashtable - a legacy data structure before Java Collections Framework, but it is not synchronized and permits nulls. HashMap does not guarantee the order of its key-value elements. Therefore, consider to use a HashMap when order does not matter and nulls are acceptable.

Note: HashMap does not maintain any order neither based on key nor on basis of value, If the keys is wanted to be maintained in a sorted order, TreeMap needs to be used.

The HashMap class uses a hashtable to implement the Map interface. This allows the execution time of basic operations, such as get() and put(), to remain constant even for large sets.

The following is the list of constructors supported by the HashMap class.

Constructor	Description
HashMap()	This constructor constructs a default HashMap.
HashMap(Map m)	This constructor initializes the hash map by using the elements of the given Map object m .
HashMap(int capacity)	This constructor initializes the capacity of the hash map to the given integer value, capacity.
HashMap(int capacity, float fillRatio)	This constructor initializes both the capacity and fill ratio of the hash map by using its arguments.

Some HashMap methods

Method	Description
void clear()	Removes all mappings from this map.
Object clone()	Returns a shallow copy of this HashMap instance: the keys and values themselves are not cloned.
Set entrySet()	Returns a collection view of the mappings contained in this map.
Object get(Object key)	Returns the value to which the specified key is mapped in this identity hash map, or null if the map contains no mapping for this key.
int size()	Returns the number of key-value mappings in this map.

Example:

The following program illustrates several of the methods supported by this collection –

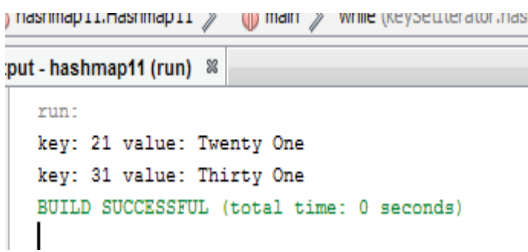
<pre>package hashmap11; import java.util.*; public class Hashmap11 { public static void main(String[] args) { HashMap<String, Integer> cache = new HashMap<String, Integer>(); Hashtable<Integer, String> source = new Hashtable<Integer, String>(); HashMap<Integer, String> map = new HashMap(source); map.put(21, "Twenty One"); map.put(31, "Thirty One"); Iterator<Integer>keySetIterator = map. keySet().iterator(); while(keySetIterator.hasNext()){ Integer key = keySetIterator.next(); System.out.println("key: " + key + " value: " + map.get(key)); } } }</pre>	<p>Output</p> 
---	--

10.2.3.2. Java- LinkedHashMap

Java LinkedHashMap class is Hash table and Linked list implementation of the Map interface, with predictable iteration order. It inherits HashMap class and implements the Map interface.

The important points about Java LinkedHashMap class are:

- A LinkedHashMap contains values based on the key.
- It contains only unique elements.
- It may have one null key and multiple null values.
- It is same as HashMap instead maintains insertion order.

Java LinkedHashMap Example: Creating and traversing the book

```
import java.util.*;
class Book {
int id;
String book_title,author,publisher;
int quantity;
public Book(int id, String book_title, String author, String publisher, int quantity) {
    this.id = id;
this.book_title = book_title;
this.author = author;
this.publisher = publisher;
this.quantity = quantity;
}
}
public class MapExample {
public static void main(String[] args) {
    //Creating map of Books
    Map<Integer,Book> map=new LinkedHashMap<Integer,Book>();
    //Creating Books
    Book b1=new Book(101,"Let us C","Yashwant Kanetkar","BPB",8);
    Book b2=new Book(102,"Data Communications & Networking","Forouzan","Mc Graw Hill",4);
    Book b3=new Book(103,"Operating System","Galvin","Wiley",6);
    //Adding Books to map
    map.put(2,b2);
    map.put(1,b1);
    map.put(3,b3);
    //Traversing map
    for(Map.Entry<Integer, Book>entry:map.entrySet()){
int key=entry.getKey();
    Book b=entry.getValue();
    System.out.println(key+" Details:");
    System.out.println(b.id+" "+b.book_title+" "+b.author+" "+b.publisher+" "+b.quantity);
    } }
}
```

10.2.3.3. Java – TreeMap class

This implementation uses a red-black tree as the underlying data structure. A TreeMap is sorted according to the natural ordering of its keys, or by a Comparator provided at creation time. This implementation does not allow nulls. So consider using a TreeMap when Map is wanted to sort its key-value pairs by the natural order of the keys (e.g. alphabetic order)

- **Difference between Map and Set**

The Map object has unique keys each containing some value, while Set contain only unique values.

Application Activity 10.4.

1. Describe various implementations of the Map interface and their use case differences.
2. How is HashMap implemented in Java? How does its implementation use hashCode and equals methods of objects?
3. Write a program to do the following :
 - create HashMap from copying data from another Map
 - adding key and value in Java HashMap
 - Retrieving value from HashMap
 - Show the Size and Clear value in HashMap
 - Sorting HashMap on keys and values entered using TreeMap.

10.2.4. Java collections – Queue interface

Learning Activity 10.5.

Obverse carefully the figure below and answer the related questions:



1. Describe what you see on the above figure
2. According to the Figure: how the teller serves the customer?
3. With example discuss FIFO.

a. Definition

Queue means 'waiting line'. A Queue is designed in such a way so that the elements added to it are placed at the end of Queue and removed from the beginning of Queue. In programming a Queue is a collection or data structure for holding elements prior to processing like queues in real-life scenarios.

b. First In First Out or FIFO

Let's consider that a queue holds a list of waiting customers in a bank's counter. Each customer is served one after another, by following their orders of arriving. The first customer comes is served first, and after him is the 2nd, the 3rd, and so on. When the customer is served, he or she leaves the counter (removed from the queue), and the next customer is picked to be served next. Other customers who come later are added to the end of the queue. This processing is called First In First Out or FIFO. The **FIFO** principle is that items stored first are retrieved first.

c. Queue methods

The **Queue** interface defines some methods for acting on the first element of the list, which differ in the way they behave, and the result they provide.

- **peek()**

In computer science, peek is an operation on certain abstract data types, specifically sequential collections such as stacks and queues, which returns the value of the top ("front") of the collection without removing the element from the collection. It thus returns the same value as operations such as "pop" or "dequeue", but does not modify the data. If the list is empty, it returns null.

Key points:

peek ():

- Retrieves, but does not remove, the head of this queue, or returns null if this queue is empty.
- Returns: the head of this queue, or null if this queue is empty

- **element()**

The `element()` method behaves like `peek()`, so it again retrieves the value of the first element without removing it. Unlike `peek()`, however, if the list is empty `element()` throws a `NoSuchElementException`

- **poll()**

The poll() method retrieves the value of the first element of the queue by removing it from the queue. At each invocation it removes the first element of the list and if the list is already empty it returns null but does not throw any exception.

- **remove()**

The remove() method behaves as the poll() method, so it removes the first element of the list and if the list is empty it throws a NoSuchElementException

- **boolean add():**

This method adds the specified element at the end of Queue and returns true if the element is added successfully or false if the element is not added that basically happens when the Queue is at its max capacity and cannot take any more elements.

d. Queue Implementations

Queue interface in Java collections has two implementations: **LinkedList** and **Priority Queue**.

- LinkedList is a standard queue implementation. Queue q1 = new LinkedList ();
- **Priority Queue** stores its elements internally according to their natural order.

PriorityQueue class is a priority queue based on the heap data structure. By default, we know that Queue follows First-In-First-Out model but sometimes we need to process the objects in the queue based on the priority. That is when Java PriorityQueue is used. For example, let's say we have an application that generates stocks reports for daily trading session. This application processes a lot of data and takes time to process it. So, customers are sending request to the application that is actually getting queued, but we want to process premium customers first and standard customers after them. So in this case PriorityQueue implementation in java can be really helpful. Example of how to create a Queue instance:

```
Queue q2 = new PriorityQueue();
```

1. Adding and Accessing Elements

To add elements to a Queue you call its add() method. This method is inherited from the Collection interface.

Here are examples:

```
Queue queueA = new LinkedList ();
```

```
queueA.add("element 1");
```

```
queueA.add("element 2");
```

The order in which the elements added to the Queue are stored internally, depends on the implementation. The same is true for the order in which elements are retrieved from the queue. You can peek at the element at the head of the queue without taking the element out of the queue. This is done via the `element()` method.

Here is how that looks: `Object firstElement = queueA.element();`

2. Removing Elements

To remove elements from a queue, you call the `remove()` method. This method removes the element at the head of the queue. In most Queue implementations the head and tail of the queue are at opposite ends. It is possible, however, to implement the Queue interface so that the head and tail of the queue is in the same end. In that case you would have a stack.

Remove example: `Object firstElement = queueA.remove();`

3. Generic Queue

By default, any Object can be put into a Queue, Java Generics makes it possible to limit the types of object you can insert into a Queue.

Example: **`Queue<MyObject> queue = new LinkedList<MyObject> ();`**

Another type of collection that allows to add objects to the end of the collection and remove them from the top. Queues are commonly used in all sorts of applications, from data processing applications to sophisticated networking systems. This queue class is named **GenQueue** and has the following methods:

- **enqueue:** This method adds an object to the end of the queue. (insertion of element in Queue)
- **dequeue:** This method retrieves the first item from the queue. The item is removed from the queue in the process. (Deletion of element in Queue)

Java Queue Examples:

<pre>1. package queuemethod; import java.util.Queue; import java.util.LinkedList; public class Queuemethod { public static void main(String[] args) { Queue<Integer> qi = new LinkedList<>(); qi.add(50); qi.add(100); qi.add(25); // peek() method Integer A = qi.peek(); System.out.println("peek always returns the first value:"+A); A = qi.peek(); System.out.println("peek always returns the first value:"+A); System.out.println("In the end the list still contains all the three elements inserted:"+qi); //poll() method</pre>	<pre>Integer B = qi.poll(); System.out.println("the first valueof the first poll:"+B); B = qi.poll(); System.out.println("the first poll() extracts and removes the first value:"+B); System.out.println("the second poll() extracts and removes the value :"+qi); // Integer C = qi.poll(); System.out.println("the first value of the second pool:"+C); C = qi.poll(); System.out.println("The third poll() call returns null,because the list at the end does not contain any element:"+C); System.out.println("The elements of third pool will be Empty:"+qi); } } Result: ut-Queuemethod(run) the first valueof the first poll:50 the first poll() extracts and removes the first value:100 the second poll() extracts and removes the value : [25] the first value of the second pool:25 The third poll() call returns null,because the list at the end does not contain any element:null The elements of third pool will be Empty:[] BUILD SUCCESSFUL (total time: 0 seconds) </pre>
---	--

2. Removing

```
package queuemethod;
import java.util.Queue;
import java.util.LinkedList;
public class Queuemethod {
    public static void main(String[] args) {
        Queue<Integer> qi = new LinkedList<>();
qi.add(50);
qi.add(100);
        Integer A = qi.remove();
System.out.println("the first value is:"+A);
```



```

    A = qi.remove();
System.out.println("after remove the first value is:"+A);
    A = qi.remove();
System.out.println(A);
System.out.println(qi);
}
}

```

From the following result, the third remove() call throws a NoSuchElementException because it has been executed on an empty queue. This behavior, is what makes it different from the poll() method.

```

package queuemethod;
import java.util.Queue;
import java.util.LinkedList;
public class Queuemethod {
    public static void main(String[] args) {
        Queue<Integer> qi = new LinkedList<>();
        qi.add(50);
        qi.add(100);
        Integer A = qi.remove();
        System.out.println("the firrst valueis:"+A);
        A = qi.remove();
        System.out.println("after remove the first value is:"+A);
        A = qi.remove();
        System.out.println(A);
        System.out.println(qi);
    }
}

```

```

run:
the firrst valueis:50
after removethe firrst valueis:100
Exception in thread "main" java.util.NoSuchElementException
    at java.util.LinkedList.removeFirst(LinkedList.java:270)
    at java.util.LinkedList.remove(LinkedList.java:685)
    at queuemethod.Queuemethod.main(Queuemethod.java:16)
C:\Users\ITOFFICER\AppData\Local\NetBeans\Cache\8.2\executor-snippets\run.xml:53: Java returned: 1
BUILD FAILED (total time: 0 seconds)

```

3. examples illustrate the difference in behavior between the peek() method and element() method when invoked on a empty queue

a. peek()

```
package queuemethod;
import java.util.Queue;
import java.util.LinkedList;
public class Queuemethod {
    public static void main(String[] args) {
        Queue<Integer> qi = new LinkedList<>();
        System.out.println("the result is:\t"+qi.peek());
    }
}
```

```
queuemethod.Queuemethod > main >
out - Queuemethod (run) ✖
run:
the result is: null
BUILD SUCCESSFUL (total time: 1 second)
```

b. *element()* Let's do the same test but this time using the *element()* method:

```
package queuemethod;
import java.util.Queue;
import java.util.LinkedList;
public class Queuemethod {
    public static void main(String[] args) {
        Queue<Integer> qi = new LinkedList<>();
        System.out.println("the result is:\t"+qi.element());
    }
}
```

```
queuemethod.Queuemethod >
out - Queuemethod (run) ✖
run:
Exception in thread "main" java.util.NoSuchElementException
    at java.util.LinkedList.getFirst(LinkedList.java:244)
    at java.util.LinkedList.element(LinkedList.java:663)
    at queuemethod.Queuemethod.main(Queuemethod.java:7)
C:\Users\ITOFFICER\AppData\Local\NetBeans\Cache\8.2\executor-snippets\run.xml:53: Java returned: 1
BUILD FAILED (total time: 0 seconds)
```

• Characteristics of queue

Basically, a queue has a head and a tail. New elements are added to the tail, and to-be-processed elements are picked from the head. The following picture illustrates a typical queue:

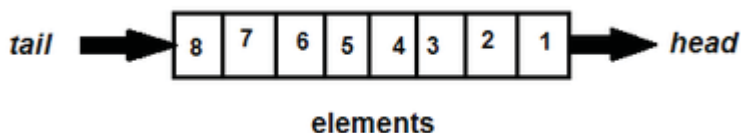

Elements in the queue are maintained by their insertion order. The Queue interface abstracts this kind of queue. Another kind of queue is double ended queue, or deque.

A deque has two heads, allowing elements to be added or removed from both ends. The following picture illustrates this kind of queue:

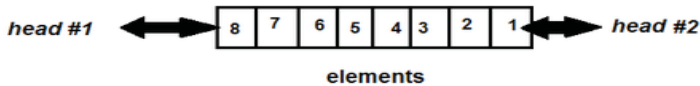

The Dequeue interface abstracts this kind of queue, and it is a sub interface of the Queue interface. And the LinkedList class is a well-known implementation. Some implementations accept null elements, some do not. Queue does allow duplicate elements, because the primary characteristic of queue is maintaining elements by their insertion order. Duplicate elements in terms of equals contract are considered distinct in terms of queue, as there are no two elements having same ordering.

Additionally, the Java Collection Framework provides the BlockingQueue interface that abstracts queues which can be used in concurrent (multi-threading) context.

A blocking queue waits for the queue to become non-empty when retrieving an element and waits for space become available in the queue when storing an element. Similarly, the BlockingDeque interface is blocking queue for double ended queues.

Application Activity 10.5.

1. What is Java Priority Queue?
2. Explain the method used in Queue interface and write a program that those are applicable.
3. What is the difference between poll() and remove() in a PriorityQueue?
4. Give a question where students write a program by applied the queue interface
5. Write a program and ask students to interpret is an give output

10.2.5 Java collections – Stack

Learning Activity 10.6.

Obverse carefully the following figure and respond to the asked questions:



1. Describe what you see on the above figure
2. According to the Figure: how the teller serves the customer?
3. With example discuss FIFO.

A stack is a container of objects that are inserted and removed according to the last-in first-out (LIFO) principle. In computer science, a stack is an abstract data type that serves as a collection of elements, with two principal operations:

- **push**, which adds an element to the collection
- **pop**, which removes the most recently added element that was not yet removed.

a. Operations on Stack

The **Push** operation stores something on the top of the stack and the Pop operation retrieves something from the top of the stack.

The following figures represent the stack operations.

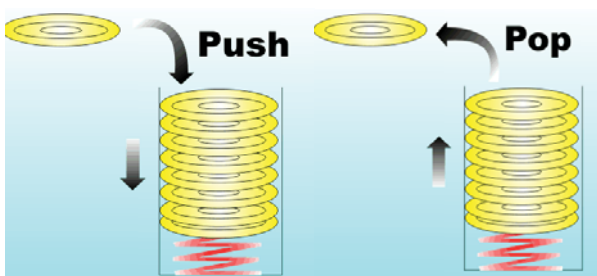

As shown on the above figure push is when the element adds to the top of collection and when that element retrieved is what called Pop

Stack methods:

Stack methods	Description
<code>push ();</code>	add/inserts new element/object into stack
<code>pop ();</code>	removes and return top of the stack
<code>peek ();</code>	returns top of the stack (just returns but doesn't remove unlike <code>pop ()</code> operation)
<code>boolean empty ();</code>	check whether invoking stack is empty or not returns true, if stack is empty; otherwise, false

b. LIFO Stack (Last In First Out)

A stack is a last-in-first-out (LIFO) data structure; in other words, the first thing to be removed is the item most recently added. A **push** is when you put a new item onto the stack, and a **pop** is when you take it off.

Some Applications of stack:

- The simplest application of a stack is to reverse a word. You push a given word to stack - letter by letter - and then pop letters from the stack.
- Another application is an “undo” mechanism in text editors; this operation is accomplished by keeping all text changes in a stack.

Example:

<pre>package stack; import java.util.*; public class STACK { public static void main(String[] args) { Stack<String> stack = new Stack<String>(); stack.push("Peter"); // Insert "Peter" in the stack stack.push("Paul"); // Insert "Paul" in the stack stack.push("Tom"); // Insert "Tom" in the stack stack.push("Emma"); // Insert "Emma" in the stack } }</pre>	<pre>System.out.println("the top name of the stack is "+stack.peek()); stack.pop(); // removing the top ("Emma") stack.pop(); // removing the next top ("Tom") } }</pre> <p>Output:</p> <pre>put - STACK (run) % run: currently top name of the stack is Emma the top name of the stack after removing is Paul BUILD SUCCESSFUL (total time: 0 seconds)</pre>
--	--

Application activity 10.6

1. Give the output of the following program:

```
Package stackimpl;
import java.util.Stack;
public class StackImpl<E>
{
    private Stack<E> stack;
    public StackImpl()
    {
        stack = new Stack<E>();
    }
    public boolean empty()
    {
        return stack.empty();
    }

    public E peek()
    {
        return stack.peek();
    }
    public E pop()
    {
        return stack.pop();
    }
    public E push(E item)
    {
        return stack.push(item);
    }
    public int search(Object o)
    {
        return stack.search(o);
    }
    public static void main(String...arg)
    {
        StackImpl<Integer> stack = new
        StackImpl<Integer>();
        System.out.println("element pushed :
        "+ stack.push(3));
        System.out.println("element pushed :
        "+ stack.push(4));
```

```
System.out.println("element pushed
: "+ stack.push(-19));
System.out.println("element pushed
: "+ stack.push(349));
System.out.println("element pushed
: "+ stack.push(35));
System.out.println("element popped :
"+ stack.pop());
System.out.println("element popped :
"+ stack.pop());
System.out.println("Element peek : "
+ stack.peek());
System.out.println("position of
element 349 "+ stack.search(3));
while (!stack.empty())
```

```
{
    System.out.println("element popped :
    "+ stack.pop());
}
}
```

2. What is the output of this program?

```
import java.util.*;
class stack
{
    public static void main(String args[])
    {
        Stack obj = new Stack();
        obj.push(new Integer(3));
        obj.push(new Integer(2));
        obj.pop();
        obj.push(new Integer(5));
        System.out.println(obj);
    }
}
```

10.2.6. Java collection – Tree

Learning Activity 10.6.

Obverse carefully this figure and answer to the following questions:

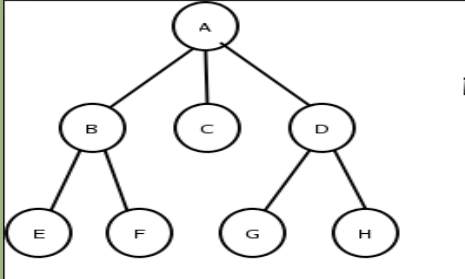

1. What is a node in tree?
2. Illustrate relationship between A and B; E and F?
3. Draw your school organization structure?

a. Definition

A tree, T , by definition, is a non-empty set of elements where one of these elements is called the root and the remaining elements are partitioned further into sub trees of T .

A Tree is a non-linear data structure where data objects are organized in terms of hierarchical relationship. The structure is non-linear in the sense that, unlike simple array and linked list implementation, data in a tree is not organized linearly.

A **tree** data structure is a powerful tool for organizing data objects based on keys. it can be defined as a collection of entities called nodes linked together to simulate a hierarchy. It is equally useful for organizing multiple data objects in terms of hierarchical relationships (think of a “family tree”, where the children are grouped under their parents in the tree).

a. Node in a Tree

Each data element is stored in a structure called a **node**. The topmost or starting node of the (inverted) tree is called the **root node**. All nodes are linked with an edge and form hierarchical sub trees beginning with the root node.

b. Components of a Tree

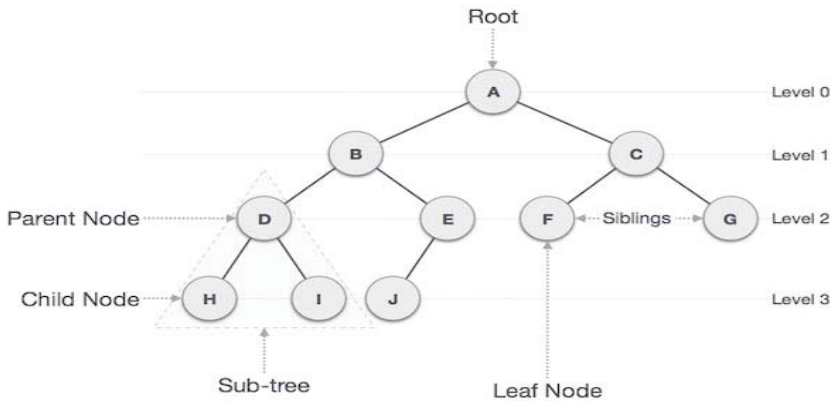

Figure: A family tree

<https://www.tutorialspoint.com>

The descendants of A are arranged in a hierarchical fashion. A, at the top of the (inverted) tree, represents the root node. A's children are B and C. B's children are D and E. C's children are F and G. F has no children, E has one, and D has two. They are listed in the same hierarchical manner. The link between each of the nodes is called an *edge*. This link signifies the relationship that one node has with another, such as B's children, F's sibling, A's descendant, and so forth. Sometimes, the ending nodes of the tree are called **leaves**.

- **Node:** stores a data element.
- **Parent:** single node that directly precedes a Node, all nodes have one parent except root (has 0)
- **Child:** one or more nodes that directly follow a node
- **Ancessor:** any node which precedes a node. itself, its parent, or an ancestor of its parent
- **Descendent:** any node which follows a node. itself, its child, or a descendent of its child
- **Root:** The node at the top of the tree is called root. There is only one root per tree and one path from the root node to any node.

More Tree Terminology

- **Leaf (external) node:** node with no children
- **Internal node:** non-leaf node
- **Siblings:** nodes which share same parent

- **Subtree:** a node and all its descendants. Ignoring the node's parent, this is itself a tree
- **Ordered tree:** tree with defined order of: tree with defined order of children. Enables ordered traversal
- **Binary tree:** each node can have at least two children, ordered tree with up to two. children per node
- **Path:** Path refers to the sequence of nodes along the edges of a tree.
- **Visiting:** Visiting refers to checking the value of a node when control is on the node.
- **Traversing:** Traversing means passing through nodes in a specific order.
- **Levels:** Level of a node represents the generation of a node. If the root node is at level 0, then its next child node is at level 1, its grandchild is at level 2, and so on.

c. Advantages of a tree (Order of items in a tree)

The Tree data structure is useful on occasions where linear representation of data does not suffice, such as creating a family tree. Java provides two in-built classes, TreeSet and TreeMap, in Java Collection Framework that cater to the needs of the programmer to describe data elements in the aforesaid form.

Treemap main advantage is that it allows to store the key-value mappings in a sorted order

Some Applications of Trees

- Storing naturally hierarchical data eg. File system
- Trees can hold objects that are sorted by their keys
- An operating system maintains a disk's file system as a tree, where file folders act as tree nodes

d. Storing elements in a tree

When an object contains two pointers to objects of the same type, structures can be created that are much more complicated than linked lists, the most basic and useful structures of this type used is binary trees. Each of the objects in a binary tree contains two pointers, typically called left and right.

- **Binary Tree**

A **binary tree** is a recursive data structure where each node can have 2 children at most. A common type of **binary tree** is a **binary search tree**, in which every node

has a value that is greater than or equal to the node values in the left sub-**tree**, and less than or equal to the node values in the right sub-tree. A binary tree of integers would be made up of objects of the following type:

```
classTreeNode {  
    int item; // The data in this node.  
    TreeNode left; // Pointer to the left subtree.  
    TreeNode right; // Pointer to the right subtree.  
}
```

e. Data representation

The simplest data representation is Nodes and Links; so a list of Nodes such as 1,2,3,4,5, and a list of links such as 1:2, 1:3, 2:4, 2:5 would represent the tree below:

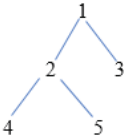

f. Traversing the Tree

- Depth-First Search: is a type of traversal that goes deep as much as possible in every child before exploring the next sibling.

here are several ways to perform a depth-first search: in-order, pre-order and post-order.

Example:

```
privateBinaryTreecreateBinaryTree() {  
    BinaryTreebt = new BinaryTree();  
    bt.add(6);  
    bt.add(4);  
    bt.add(8);  
    bt.add(3);  
    bt.add(5);  
    bt.add(7);  
    bt.add(9);  
    returnbt;  
}
```

The in-order traversal in the console output: 3 4 5 6 7 8 9

The pre-order traversal in the console output: 6 4 3 5 8 7 9

Here are the nodes in post-order: 3 5 4 7 9 8 6

- **Breadth-First Search:** This is another common type of traversal that visits all the nodes of a level before going to the next level.

In this case, the order of the nodes will be: 6 4 8 3 5 7 9

Example of TreeMap that store the element:

```
import java.util.Map;
public class TreeMap {
    public static void main(String[] args) {
        Map<Integer, String >emplInfo = new TreeMap<Integer,String>();
        emplInfo.put(20,"kalisa");
        emplInfo.put(4,"Emmy");
        emplInfo.put(9,"Diane");
        emplInfo.put(15,"Karera");
        System.out.println(emplInfo);
    }
}
```

Example of TreeMap that store the element:

<pre>import java.util.Map; public class TreeMap { public static void main(String[] args) { Map<Integer, String >emplInfo = new TreeMap<Integer,String>(); emplInfo.put(20,"kalisa"); emplInfo.put(4,"Emmy"); emplInfo.put(9,"Diane"); emplInfo.put(15,"Karera"); System.out.println(emplInfo); } }</pre>	<p>Output:</p>  <pre>Debugger Console TreeMap (run) run: {4=Emmy, 9=Diane, 15=Karera, 20=kalisa} BUILD SUCCESSFUL (total time: 0 seconds)</pre>
--	---

Application Activity 10.7.

- 1) List the nodes of the tree below in preorder, post order, and breadth-first order.

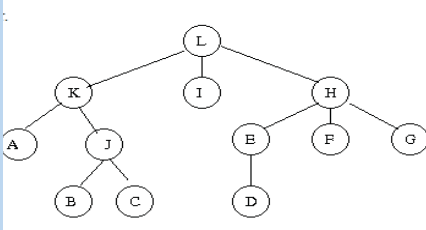

2. Write an example showing basic operations on TreeMap like creating an object, adding key-value pair objects, getting value by passing key object, checking whether the map has elements or not, deleting specific entry, and size of the TreeMap.

END UNIT ASSSSMENT

1. Describe the Collections type hierarchy. What are the main interfaces, and what are the differences between them?
2. What is the difference between: List and Set? List and Map? ArrayList and Vector?
3. How to create a List instance?
4. What is Queue and Stack, list their differences?
5. Write a Java program to insert an element into the array list at the first position.
6. Write a Java program to search a key in a Tree Map



UNIT 11

JAVA ENTERPRISE WEB APPLICATIONS

UNIT 11: JAVA ENTERPRISE WEB APPLICATIONS

Key unit competency

To be able to design and run a java enterprise web application

Introductory Activity

Observe the figure below and answer questions:

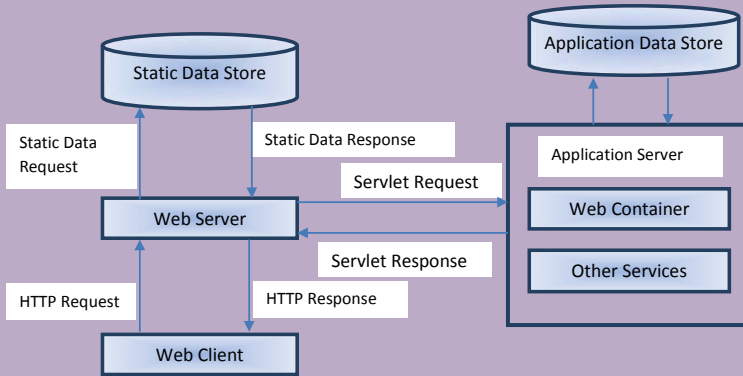

1. Describe what you see.
2. Give a meaning of each arrow in the figure.
3. Explain the whole process illustrated in the figure above.
4. Describe a web server.
5. Describe a web container.

11.1 Tomcat

Activity 11.1.

Describe and illustrate the difference between web server and application server?

11.1.1. Definition of Apache Tomcat:

Apache Tomcat is a web server and application server that is used to serve Java applications. Tomcat employs a hierarchical and modular architecture as shown below:

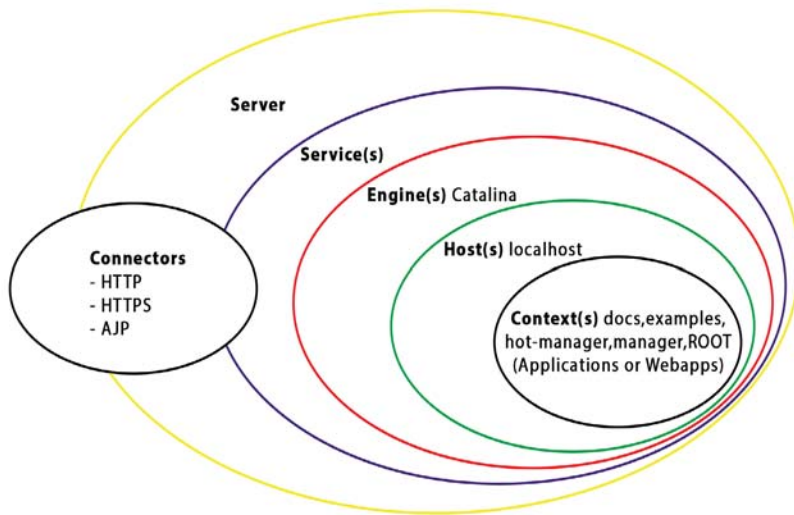

Figure 11.1: Tomcat architecture

11.1.2. Terms

a. Server

In the Tomcat world, a Server represents the whole container. Tomcat provides a default implementation of the Server interface, and this is rarely customized by users.

b. Service

A Service is an intermediate component which lives inside a Server and ties one or more Connectors to exactly one Engine.

c. Engine

An Engine represents request processing channel for a specific Service. As a Service may have multiple Connectors, the Engine received and processes all requests from these connectors, handing the response back to the appropriate connector for transmission to the client.

d. Host

A Host is an association of a network name, e.g. `www.yourcompany.com`, to the Tomcat server. An Engine may contain multiple hosts, and the Host element also supports network aliases such as `yourcompany.com` and `abc.yourcompany.com`.

e. Connector

A Connector handles communications with the client. Connectors provide instructions for the ports an application server listens to for incoming requests with incoming requests being directed to configured web application.

f. Context

A Context represents a web application. A Host may contain multiple contexts, each with a unique path. The Context interface may be implemented to create custom Contexts, but this is rarely the case because the Standard Context provides significant additional functionality.

11.1.3. The components of Tomcat are:

Tomcat itself is comprised of three main components: Jasper, Catalina, and Coyote. These components combined allow for the parsing and compilation of Java Server Pages into java servlet code, the delivery of these servlets, and request processing.

a. Jasper

Jasper is Apache Tomcat's Java Server Pages Engine. Jasper describes JSP files compiling them into Java code as servlets to be handled by Catalina. At runtime, Jasper detects changes to JSP files and recompiles them.

b. Catalina

Catalina is Apache Tomcat's servlet container. Catalina implements the specifications for servlet and Java Server Pages (JSP).

c. Coyote

Coyote is Apache Tomcat's HTTP Connector component supporting the HTTP 1.1 protocol. Coyote listens for incoming connections on configured TCP ports on the server and forwards requests to the Tomcat Engine for processing and returning a response to the requesting client.

Application Activity 11.1.

1. Describe what Tomcat is?
2. Explain the architecture of Tomcat.
3. Explain the role of each one the main components of Tomcat.

11.2. Installation and configuration of tomcat configuration directory

Activity 11.2.

Switch on computers in your school computer lab and answer the following questions:

1. Examine the type and version of operating system running on your computer.
2. Observe the web server software installed on your computer.

11.2.1. Installing Tomcat

a. Requirements for Installing

To install and configure Tomcat, first download the Latest version of Tomcat and Netbeans with Java Development Kit (JDK). You should choose the appropriate downloads based on your operating system.

b. Installing Tomcat Using Windows Service Installer

- The first thing you need to do is install the **NetBeans with Java Development Kit (JDK)**
- Download the Apache Tomcat Windows service installer from the Tomcat download page.

In our case we are going to install Tomcat version 9.0.6. Follow the steps, choose the installation location, and the installer will take care of extracting and copying files to correct directory, and configuring Environment variables and service properties. Figures below show the running Tomcat installer for Windows.

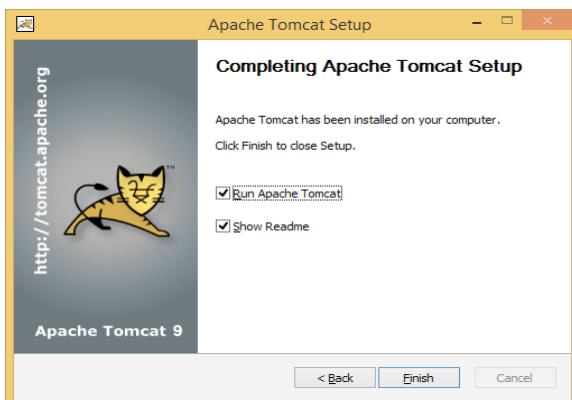

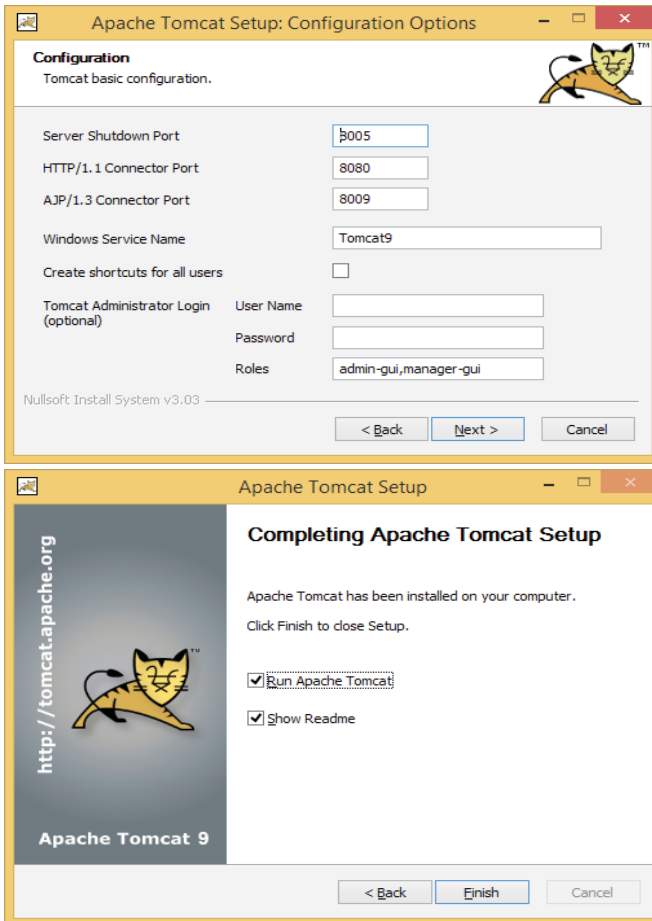

Figure 11. 1: Tomcat installation windows

c. Testing Your Tomcat Installation

To test the Tomcat installation, you need to first start the Tomcat server using a folder which is placed in your Windows Start menu with shortcuts that allow you to start and stop your Tomcat server from there.

Once Tomcat has started, open your browser to the following URL: `http://localhost:8080/`

You should see a page similar to that shown in Figure 11-3.

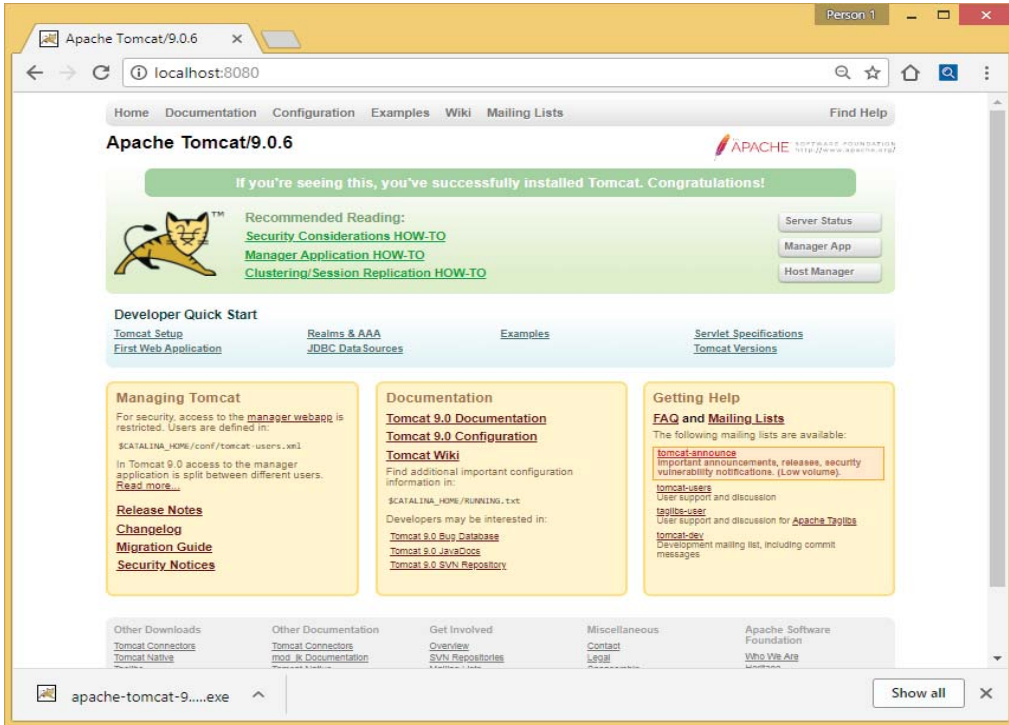

Figure 11. 2: Tomcat home page

11.2.2. Configuration of tomcat configuration directory

This directory contains all the configuration files for the Tomcat server. The most important ones are:

- Server.xml
- Tomcat-user.xml[add user]
- Web.xml
- Context.xml

a. Server.xml

The main Tomcat configuration file is server.xml, located in conf directory.

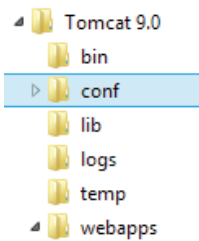

Figure 11. 3: Location of the conf directory

The main Tomcat elements like engines, hosts, and contexts are configured here. This file is located in the CATALINA_HOME/conf directory and can be considered the heart of Tomcat. It allows you to completely configure Tomcat using XML configuration elements. Tomcat loads the configuration from server.xml file at startup, and any changes to this file require server restart.

CATALINA_HOME: This represents the root of your Tomcat installation. When we say, “This information can be found in your \$CATALINA_HOME/README.txt file” we mean to look at the README.txt file at the root of your Tomcat install.

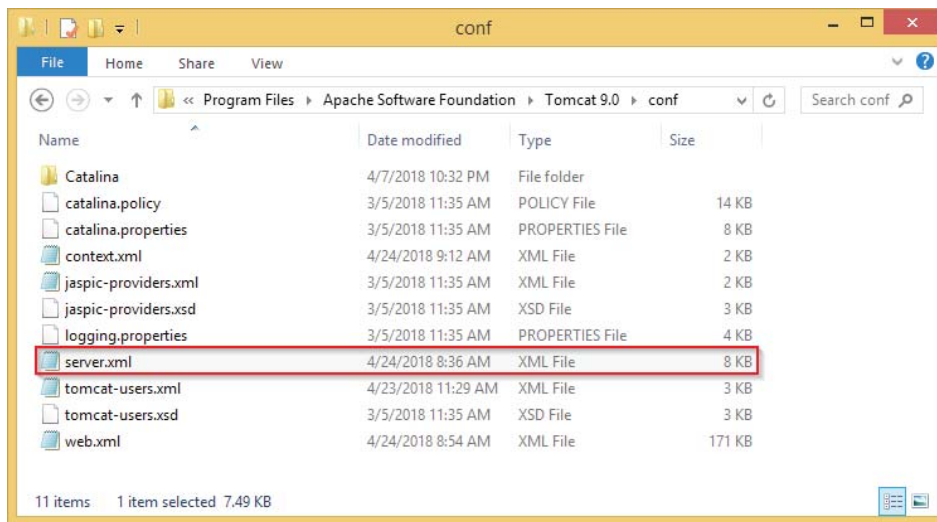

Figure 11. 4: Location of server.xml file

The default server.xml is reproduced as follows (after removing the comments and minor touch-ups):

```
<?xml version="1.0" encoding="UTF-8"?>
<Server port="8005" shutdown="SHUTDOWN">
<Listener className="org.apache.catalina.startup.VersionLoggerListener" />
<Listener className="org.apache.catalina.core.AprLifecycleListener" SSLEngine="on" />
<Listener className="org.apache.catalina.core.JreMemoryLeakPreventionListener" />
<Listener className="org.apache.catalina.mbeans.GlobalResourcesLifecycleListener" />
<Listener className="org.apache.catalina.core.ThreadLocalLeakPreventionListener" />
<GlobalNamingResources>
<Resource name="UserDatabase" auth="Container"
```

```

type="org.apache.catalina.UserDatabase"
description="User database that can be updated and saved"
    factory="org.apache.catalina.users.MemoryUserDatabaseFactory"
    pathname="conf/tomcat-users.xml" />
</GlobalNamingResources>
<Service name="Catalina">
<Connector port="8080" protocol="HTTP/1.1"
    connectionTimeout="20000"
    redirectPort="8443" />
<Connector port="8009" protocol="AJP/1.3" redirectPort="8443" />
<Engine name="Catalina" defaultHost="localhost">
<Realm className="org.apache.catalina.realm.LockOutRealm">
<Realm className="org.apache.catalina.realm.UserDatabaseRealm"
    resourceName="UserDatabase"/>
</Realm>
<Host name="localhost" appBase="webapps"
    unpackWARs="true" autoDeploy="true">
<Valve className="org.apache.catalina.valves.AccessLogValve" directory="logs"
    prefix="localhost_access_log" suffix=".txt"
    pattern="%h %l %u %t &quot;%r&quot; %s %b" />
</Host>
</Engine>
</Service>
</Server>

```

Understanding codes

- **Server**

Server (Line 2) is top component, representing an instance of Tomcat. It can contains one or more services, each with its own engines and connectors.

```
<Server port="8005" shutdown="SHUTDOWN">
```

- **Common Attributes**

- **className** - Java class name of the implementation to use. This class must implement the org.apache.catalina.Server interface.

If no class name is specified, the standard implementation will be used.

- **Address** - The TCP/IP address on which this server waits for a shutdown command. If no address is specified, localhost is used.
- **Port** - The TCP/IP port number on which this server waits for a shutdown command. Set to -1 to disable the shutdown port.
- **Shutdown** - The command string that must be received via a TCP/IP connection to the specified port number, in order to shut down Tomcat.
- **Listeners**

The Server contains several Listeners (Lines 3-7). A Listener element defines a component that performs actions when specific events occur, usually Tomcat starting or Tomcat stopping.

For example the **Version Logging Lifecycle Listener** logs Tomcat, Java and operating system information when Tomcat starts.

- **Global Naming Resources**

The element (Line 9-15) defines the JNDI (Java Naming and Directory Interface) resources, that allows Java software clients to discover and look up data and objects via a name. The default configuration defines a JNDI name called UserDatabase via the element (Line 10-14), which is a memory-based database for user authentication loaded from conf/tomcat-users.xml.

```
<GlobalNamingResources>
<Resource name="UserDatabase" auth="Container"
type="org.apache.catalina.UserDatabase"
description="User database that can be updated and saved"
factory="org.apache.catalina.users.MemoryUserDatabaseFactory"
pathname="conf/tomcat-users.xml" />
</GlobalNamingResources>
```

You can define other global resource JNDI such as MySQL database to implement connection pooling.

- **Services**

A Service associates one or more Connectors to an Engine. The default configuration defines a Service called "Catalina", and associates two Connectors: HTTP and AJP to the Engine.

```
<Service name="Catalina">
```

- **Connectors**

A Connector is associated with a TCP port to handle communications between the Service and the clients. The default configuration defines two Connectors: HTTP/1.1: Handle HTTP communication and enable Tomcat to be an HTTP server. Clients can issue HTTP requests to the server via this Connector, and receive the HTTP response messages.

```
<Connector port="8080" protocol="HTTP/1.1"  
    connectionTimeout="20000"  
    redirectPort="8443" />
```

The default chooses TCP port 8080 to run the Tomcat HTTP server, which is different from the default port number of 80 for HTTP production server. You can choose any number between 1024 to 65535, which is not used by any application to run your Tomcat server.

The **connectionTimeout** attribute define the number of milliseconds this connector will wait, after accepting a connection, for the request URI line (request message) to be presented. The default is 20 seconds.

The **redirect** attribute re-directs the Secure Sockets Layer (SSL) requests to TCP port 8443. AJP/1.3: Apache JServ Protocol connector to handle communication between Tomcat server and Apache HTTP server.

```
<Connector port="8009" protocol="AJP/1.3" redirectPort="8443" />
```

You could run Tomcat and Apache HTTP servers together, and let the Apache HTTP server handles static requests and PHP; while Tomcat server handles the Java Servlet/JSP.

- Containers

Tomcat refers to Engine, Host, Context, and Cluster, as container. The highest-level is Engine; while the lowest-level is Context. Certain components, such as Realm and Valve, can be placed in a container.

- **Engine**

A Engine is the highest-level of a container. It can contains one or more Hosts. You

could configure a Tomcat server to run on several hostnames, known as virtual host.

```
<Engine name="Catalina" defaultHost="localhost">
```

The Catalina Engine receives HTTP requests from the HTTP connector, and direct them to the correct host based on the hostname/IP address in the request header.

- **Realm**

A Realm is a database of user, password, and role for authentication (i.e., access control). You can define Realm for any container, such as Engine, Host, and Context, and Cluster.

```
<Realm className="org.apache.catalina.realm.LockOutRealm">
```

```
<Realm className="org.apache.catalina.realm.UserDatabaseRealm"  
    resourceName="UserDatabase"/>
```

```
</Realm>
```

The default configuration defines a Realm (UserDatabaseRealm) for the Catalina Engine, to perform user authentication for accessing this engine. It uses the JNDI name UserDatabase defined in the GlobalNamingResources. Besides the UserDatabaseRealm, there are: JDBCRealm (for authenticating users to connect to a relational database via the JDBC driver); DataSourceRealm (to connect to a DataSource via JNDI; JNDIRealm (to connect to an LDAP directory); and MemoryRealm (to load an XML file in memory).

- **Hosts**

A Host defines a virtual host under the Engine, which can in turn support many Contexts (webapps).

```
<Host name="localhost" appBase="webapps"
```

```
    unpackWARs="true" autoDeploy="true">
```

The default configuration define one host called localhost. The appBase attribute defines the base directory of all the webapps, in this case, webapps. By default, each webapp's URL is the same as its directory name. For example, the default Tomcat installation provides four webapps: docs, examples, host-manager and manager under the webapps directory. The only exception is ROOT, which is identified by an empty string. That is, its URL is https://localhost:8080/. The unpackWARs specifies whether WAR-file dropped into the webapps directory shall be unzipped. For

unpackWARs="false", Tomcat will run the application from the WAR-file directly, without unpacking, which could mean slower execution. The autoDeploy attribute specifies whether to deploy application dropped into the webapps directory automatically.

- **Valve**

A Valve can intercept HTTP requests before forwarding them to the applications, for pre-processing the requests. A Valve can be defined for any container, such as Engine, Host, and Context, and Cluster. In the default configuration, the AccessLogValve intercepts an HTTP request and creates a log entry in the log file, as follows:

```
<Valve className="org.apache.catalina.valves.AccessLogValve" directory="logs"
    prefix="localhost_access_log" suffix=".txt"
    pattern="%h %l %u %t &quot;%r&quot; %s %b" />
```

b. Tomcat-user.xml[add user]

Tomcat-users.xml is one of the Tomcat configuration files. An example of the tomcat-users.xml file is shown below:

```
<?xml version='1.0' encoding='cp1252'?>
<tomcat-users xmlns="http://tomcat.apache.org/xml"
    xmlns:xsi="http://www.w3.org/2001/XMLSchema-instance"
    xsi:schemaLocation="http://tomcat.apache.org/xml tomcat-users.xsd"
    version="1.0">
<role rolename="manager-gui"/>
<user username="tomcat" password="tomcat" roles="manager-gui, manager-script, manager-jmx"/>
</tomcat-users>
```

By default, access to the manager application is disabled; this can be accessed only by an authenticated user. The default realm for the manager application is **tomcat-users.xml**.

To set up the manager application, add a user with the manager role to this file. You can find the role names in the web.xml file of the Manager web application. The available roles are:

- manager-gui — Access to the HTML interface.

- manager-status — Access to the “Server Status” page only.
 - manager-script — Access to the tools-friendly plain text interface that is described in this document, and to the “Server Status” page.
 - manager-jmx — Access to JMX proxy interface and to the “Server Status” page.
- **Using Tomcat Server Management App**

Add a user and a role elements in the TOMCAT_ROOT_DIR\config\tomcat-users.xml configuration file as shown below:

```
<tomcat-users xmlns="http://tomcat.apache.org/xml"
  xmlns:xsi="http://www.w3.org/2001/XMLSchema-instance"
  xsi:schemaLocation="http://tomcat.apache.org/xml tomcat-users.xsd"
  version="1.0">
<role rolename="manager-gui"/>
<user username="tomcat" password="tomcat" roles="manager-gui"/>
</tomcat-users>
```

The above entry in the tomcat-users.xml allows access to the manager web app provided by default with each Tomcat instance. The user name and the password in the example could be any legal value. Once you have added above entry in the **tomcat-users.xml** configuration file, save changes and restart the Tomcat server.

Notice: In case you fail to save changes, run the editor as Administrator.

You should be able to login to tomcat by one of the ways:

- http://localhost:8080/ and click the “Manager App” button
- http://localhost:8080/manager/html

This will prompt for the user name and password. Enter the values from the tomcat-users.xml.

In the codes provided above, the user name is “**tomcat**” and the password is “**tomcat**”

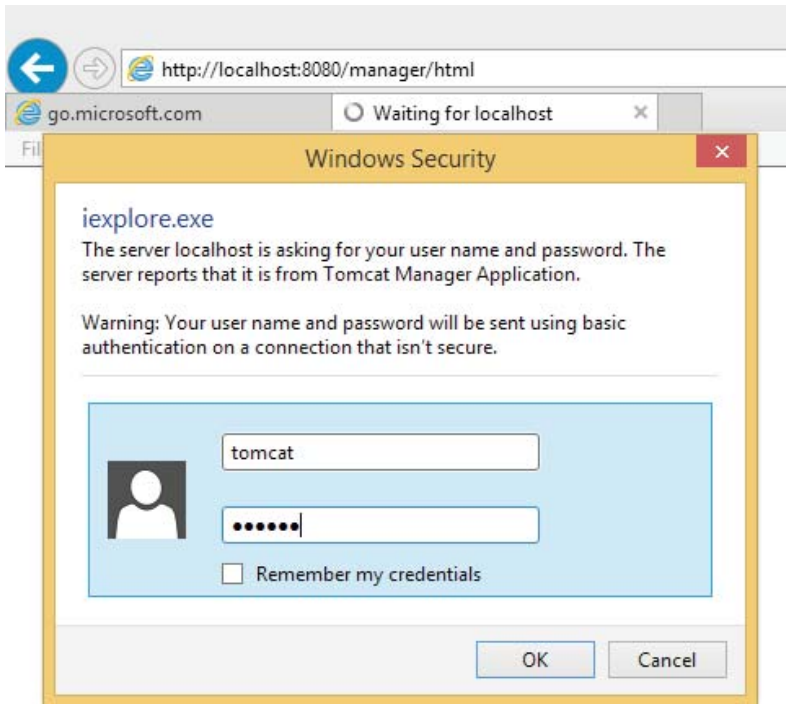

Figure 11. 5: Web application manager login window

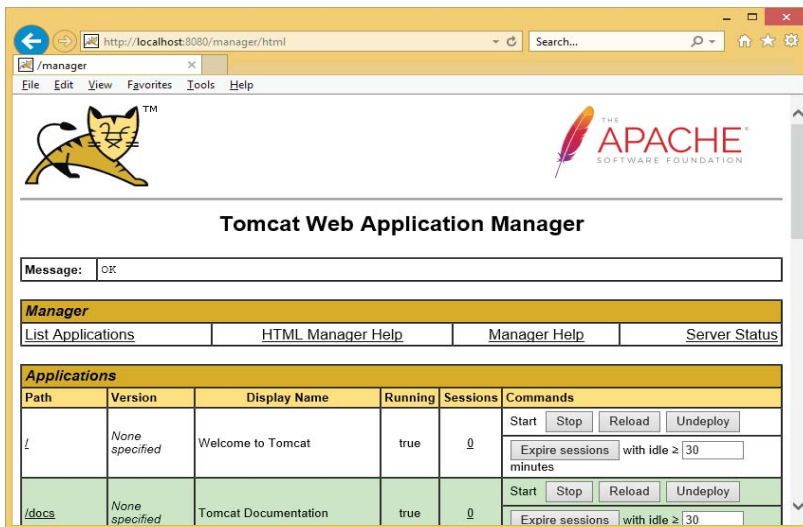

Figure 11. 6: Web application Manager Window

c. Tomcat web.xml

It is one of the main configuration files for the Tomcat server. It is located in the TOMCAT_ROOT_DIR\conf folder. This configuration file is used for basic web application's configuration shared by all web applications that will be deployed on the Tomcat server instance.

Below is the web.xml with no options:

```
<?xml version="1.0" encoding="ISO-8859-1"?>
<web-app xmlns="http://xmlns.jcp.org/xml/ns/javaee"
  xmlns:xsi="http://www.w3.org/2001/XMLSchema-instance"
  xsi:schemaLocation="http://xmlns.jcp.org/xml/ns/javaee
    http://xmlns.jcp.org/xml/ns/javaee/web-app_4_0.xsd"
  version="4.0">
...
</web-app>
```

The above simplified web.xml contains <web-app> element which will contain options for operating all web applications deployed in this Tomcat instance. The <web-app> element represents the configuration options for a web application. It is required that all deployment descriptors must confirm to XML schema for the Servlet 4.0. Web-app is the root element for the deployment descriptor, web.xml file.

d. Tomcat context.xml

In Tomcat, the Context Container represents a single web application running within a given instance of Tomcat. A web site is made up of one or more Contexts. For each explicitly configured web application, there should be one context element either in server.xml or in a separate context XML fragment file.

Here is an example of context.xml

```
<?xml version="1.0" encoding="UTF-8"?>
<!-- The contents of this file will be loaded for each web application -->
<Context>
<!-- Default set of monitored resources. If one of these changes, the -->
<!-- web application will be reloaded. -->
<WatchedResource>WEB-INF/web.xml</WatchedResource>
<WatchedResource>WEB-INF/tomcat-web.xml</WatchedResource>
<WatchedResource>${catalina.base}/conf/web.xml</WatchedResource>
<!-- Uncomment this to disable session persistence across Tomcat restarts -->
<!--
<Manager pathname="" />
-->
</Context>
```

Application Activity 11.2.

Having Apache Tomcat server installed on your computer, do the following:

1. Change its connector port and set it to: 9999
2. Add a user with the following credentials:
 - a. Username: tomcat
 - b. Password: secret
 - c. Permission: Access to the "Server Status" page only
3. Put `http://localhost:9999` in your browser and run it to make sure that it is working.
4. What happens when you open the "Manage App" using the "tomcat" and "secret" for username and password?
5. Where should you use the username and password indicated in question 4?

11.3 Hypertext Transfer Protocol (HTTP) request / response

11.3.1. Http

Activity 11.3

Describe how web servers handle requests from different clients?

HTTP is an asymmetric request-response client-server protocol. An HTTP client sends a request message to an HTTP server. The server, in turn, returns a response message. In other words, HTTP is a pull protocol, the client pulls information from the server (instead of server pushes information down to the client).

a. Key element of HTTP request

Below are the components of an http request:

- URL
- Form data
- HTTP method(if present)

- Cookies
- **Uniform Resource Locator (URL)**

It is a reference to a web resource that specifies its location on a computer network and a mechanism for retrieving it.

Example: <https://irembo.gov.rw/rolportal/web/rol/aboutus>

- **Form data**

Data collected using HTML form is called form data and in HTTP request it is optional information. If it is present then it will be present in header or body part of the HTTP request depending on the HTTP method present in the request.

- **HTTP method**

It indicates desired action to be performed on dynamic web resources. HTTP has a different method and in Servlet we implement that method based on action to be performed.

HTTP method	Description
Head	To send header part data
Trace	To resend the receive request
Put	Help us to put file into server
Delete	Remove file from server
Options	It determines which of the HTTP method server support and return appropriate error
Post	It is used to post data into server
Get	It is used to get data from server

b. Key element of HTTP response

An HTTP response consist of the following:

- * Status code
- * Content type
- * Actual content
- * Cookies(if present)
- **Status code**

Status code represent status of HTTP request. It is a mandatory information and it

will be present in Header part of HTTP response.

Status code	Status
200	Servlet successfully handled the request
404	Request resources not found at server side
500	Internal server error

- **Content Type**

Content type tells the browser what type of content it is going to receive so that it can prepare itself to handle response data. It is a mandatory information and it is present in header part of HTTP request.

List of Content Type

Text/html

application/pdf

video/quicktime

image/jpeg

application/x-zip

11.3.2. Request-Response Process

This sections provides the logical breakdown of the HTTP request-response process.

After the client sends its request to a server, it is helpful to define a set of logical steps which the server must perform before a response is sent.

The following steps are performed in the normal response process:

- Authorization translation
- Name translation
- Path checks
- Object type
- Respond to request
- Log the transaction

If at any time one of these steps fail, another step must be performed to handle the

error and inform the client about what happened.

Application Activity 11.3

1. Explain the process of http request.
2. Explain the process of http response.

11.4 Web application

Activity 11.4

Explain the difference between a website and web application.

11.4.1. The definition of web application

A web application is a collection of servlets, html pages, classes, and other resources that can be bundled and run on multiple containers from multiple vendors. Briefly, a web application is a container that can hold any combination of the following list of objects:

- Servlets
- Java Server Pages (JSPs)
- Utility classes - is a static class that perform small and repetitive operations on a kind of instance (example of utils classes ArrayUtils or IOUtils from Apache)
- Static documents, including HTML, images, JavaScript libraries, cascading style sheets (CSS), and so on
- Client-side classes
- Meta-information describing the web application (Metadata is data that describes other data.)

11.4.2. Servlet

A Java servlet is a platform-independent web application component that is hosted in a servlet container. Servlets communicate with web clients using a request/response model managed by a servlet container, such as Apache Tomcat.

11.4.3. Servlet context

The servlet context is an object that is created when the web-application is started

in a servlet container and destroyed when the web-application is undeployed or stopped. The servlet context object usually contains initialization parameters in the form of a web.xml document.

11.4.4. Servlet container

It is the component of a web server that interacts with Java servlets. The container is responsible to manage the life-cycle of servlet. Web server hands the request to web container in which servlet is deployed and not to Servlet itself. Then container provides request and response to servlet. Tomcat is the example of Servlet container. Servlet Container provides the following services:

- It manages the servlet life cycle.
- The resources like servlets, JSP pages and HTML files are managed by servlet container.
- It appends session ID to the URL path to maintain session (Session means a particular interval of time. The container uses session ID to identify the particular user.)
- Provides security service.
- It loads a servlet class from network services, file systems like remote file system and local file system.

Life Cycle of a Servlet

The life cycle of the servlet is as follows:

1. Servlet class is loaded.
2. Servlet instance is created.
3. init method is invoked.
4. service method is invoked.
5. destroy method is invoked.

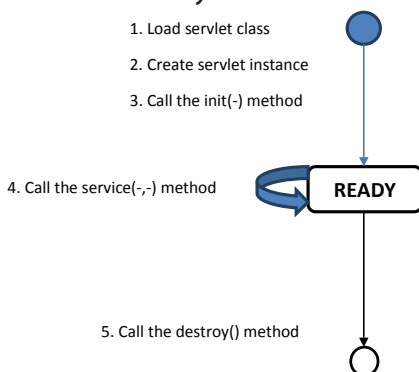

Figure 11. 7: Servlet life cycle

As displayed in the above diagram, there are three states of a servlet: **new**, **ready** and **end**. The servlet is in new state if servlet instance is created. After invoking the `init()` method, Servlet comes in the ready state. In the ready state, servlet performs all the tasks. When the web container invokes the `destroy()` method, it shifts to the end state.

11.4.5. Java server pages (JSP) files

Java Server Pages (JSP) is a technology for developing Webpages that supports dynamic content. This helps developers insert java code in HTML pages by making use of special JSP tags, most of which start with `<%` and end with `%>`. Using JSP, you can collect input from users through Webpage forms, present records from a database or another source, and create Webpages dynamically.

JSP tags can be used for a variety of purposes, such as retrieving information from a database or registering user preferences, accessing JavaBeans components, passing control between pages, and sharing information between requests, pages etc. A JSP document must end with a `.jsp` extension.

The following code contains a simple example of a JSP file:

```
<HTML>
<BODY>
<% out.println("MURAKAZA NEZA!"); %>
</BODY>
</HTML>
```

A JSP file is a server-generated web page. It contains Java code. The code is parsed by the web server, which generates HTML that is sent to the user's computer.

11.4.6. Configuration file

It is a file that contains configuration information for a particular web application. When the application is executed, it consults the configuration file to see what parameters are in effect

a. Deployment descriptor

A web application's deployment descriptor describes the classes, resources and configuration of the application and how the web server uses them to serve web requests. When the web server receives a request for the application, it uses the

deployment descriptor to map the URL of the request to the code that ought to handle the request.

The deployment descriptor is a file named **web.xml**. It resides in the app's Web application Archive (WAR) under the **WEB-INF/** directory. The file is an XML file whose root element is **<web-app>**.

The location of WEB-INF Directory

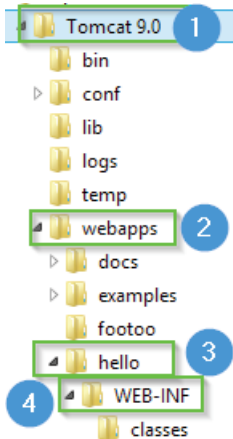

Figure 11. 8: The WEB-INF Directory

The root directory of your web application can have any name. In the above example the root directory name is **webapps**.

The **WEB-INF** directory is located just below the web app root directory. This directory is a meta information directory.

Here is a simple **web.xml** example that maps all URL paths (**/***) to the servlet class **mysite.server.ComingSoonServlet**:

```
<web-app xmlns="http://java.sun.com/xml/ns/javaee" version="2.5">
  <servlet>
    <servlet-name>comingsoon</servlet-name>
    <servlet-class>mysite.server.ComingSoonServlet</servlet-class>
  </servlet>
  <servlet-mapping>
    <servlet-name>comingsoon</servlet-name>
    <url-pattern>/*</url-pattern>
  </servlet-mapping>
```

</web-app>

11.4.7. Manage Web Applications

In many production environments it is very useful to have the capability to manage your web applications without having to shut down and restart Tomcat. The interface is divided into six sections:

- **Message** - Displays success and failure messages.
- **Manager** - General manager operations like list and help.
- **Applications** - List of web applications and commands.
- **Deploy** - Deploying web applications.
- **Diagnostics** - Identifying potential problems.
- **Server Information** - Information about the Tomcat server.

a. Message

Displays information about the success or failure of the last web application manager command you performed. If it succeeded **OK** is displayed and may be followed by a success message. If it failed **FAIL** is displayed followed by an error message.

Path	Version	Display Name	Running	Sessions	Commands
/	None specified	Welcome to Tomcat	true	0	Start Stop Reload Undeploy Expire sessions with idle ≥ 30 minutes
/docs	None specified	Tomcat Documentation	true	0	Start Stop Reload Undeploy Expire sessions with idle ≥ 30 minutes
/examples	None specified	Servlet and JSP Examples	true	0	Start Stop Reload Undeploy Expire sessions with idle ≥ 30 minutes
/host-manager	None specified	Tomcat Host Manager Application	true	0	Start Stop Reload Undeploy Expire sessions with idle ≥ 30 minutes
/manager	None specified	Tomcat Manager Application	true	1	Start Stop Reload Undeploy Expire sessions with idle ≥ 30 minutes

b. Manager

The Manager section has three links:

- **List Applications** - Redisplay a list of web applications.

- **HTML Manager Help** - A link to this document.
- **Manager Help** - A link to the comprehensive Manager App HOW TO.

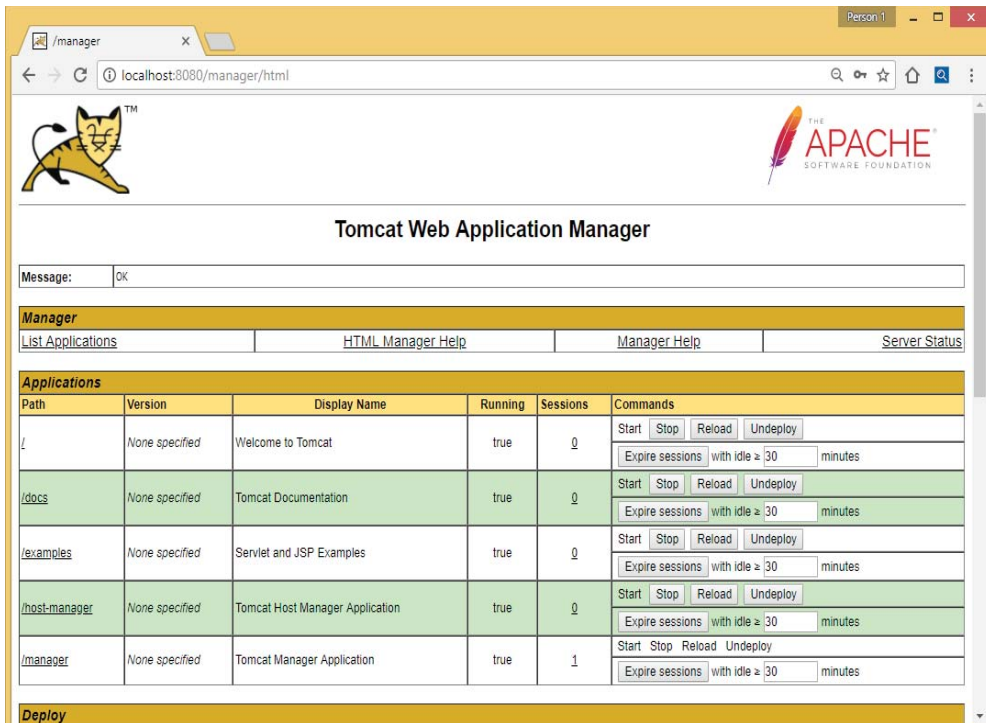

c. Applications

The Applications section lists information about all the installed web applications and provides links for managing them.

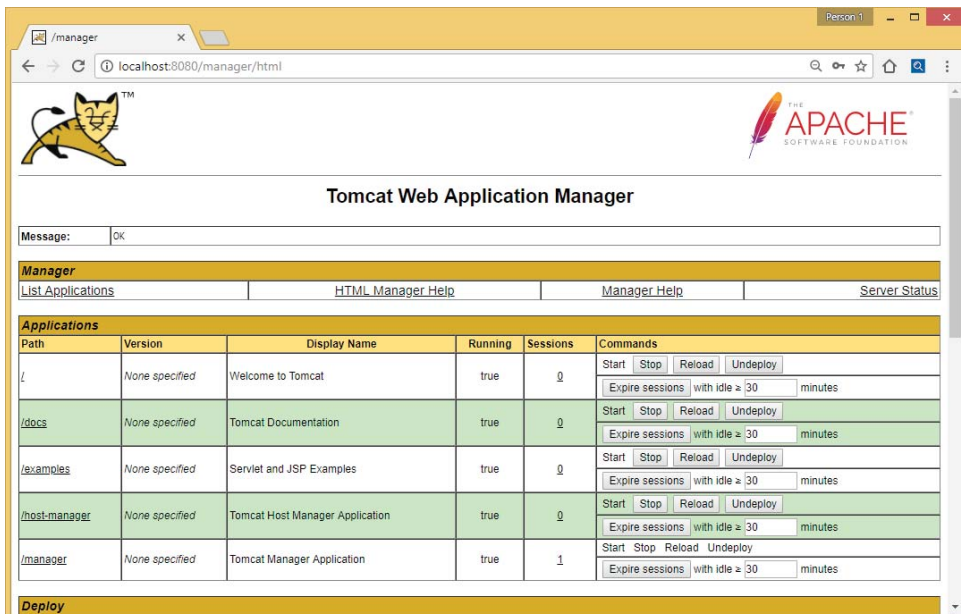

For each web application the following is displayed:

- **Path** - The web application context path.
- **Display Name** - The display name for the web application if it has one configured in its “web.xml” file.
- **Running** - Whether the web application is running and available (true), or not running and unavailable (false).
- **Sessions** - The number of active sessions for remote users of this web application. The number of sessions is a link which when submitted displays more details about session usage by the web application in the Message box.
- **Commands** - Lists all commands which can be performed on the web application. Only those commands which can be performed will be listed as a link which can be submitted. No commands can be performed on the manager web application itself. The following commands can be performed:
 - **Start** - Start a web application which had been stopped.
 - **Stop** - Stop a web application which is currently running and make it unavailable.
 - **Reload** - Reload the web application so that new “.jar” files in /WEB-INF/lib/ or new classes in /WEB-INF/classes/ can be used.
 - **Undeploy** - Stop and then remove this web application from the server.

Steps to open the Servlet and JSP examples

Step1: Click on */Examples* in the path column

Step2: Click on Servlet examples

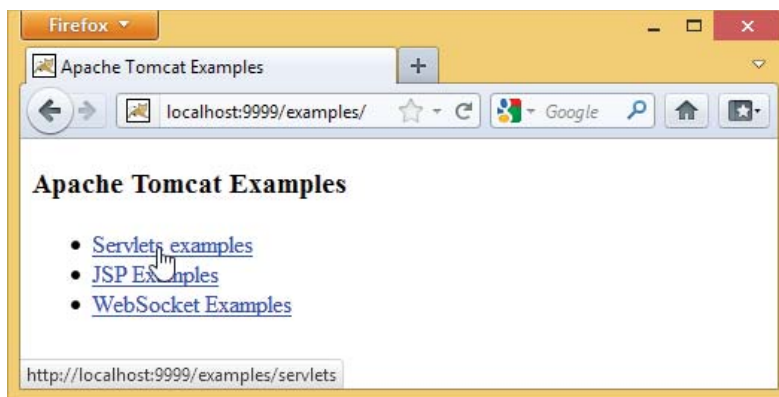

Figure 11. 9: Apache Tomcat examples

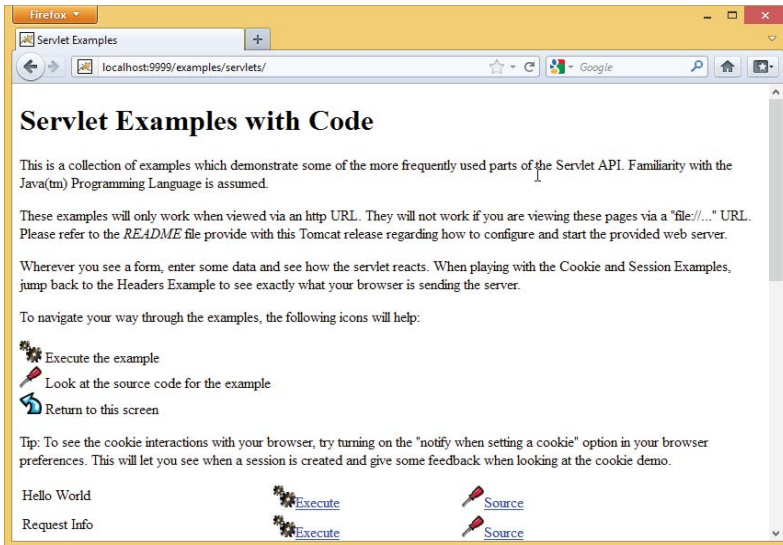

Figure 11. 10: Servlet examples

d. Deploy

Once you have written a web application, it must be hosted on the application server before it can be opened in the browser. The task is called deployment. Web applications can be deployed using files or directories located on the Tomcat server or you can upload a web application archive (WAR) file to the server.

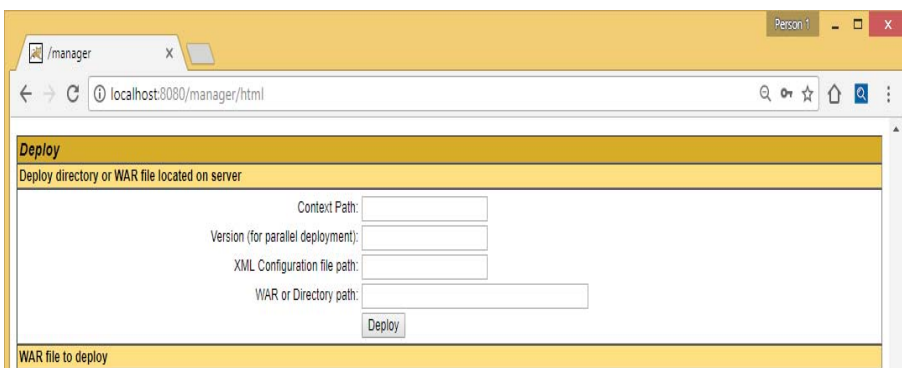

Figure 11. 11: Deployment section in Web Application Manager

a. Deploy directory or WAR file located on server

Deploy and start a new web application, attached to the specified *Context Path*: (which must not be in use by any other web application). This command is the logical opposite of the *Undeploy* command.

- **Deploy a Directory or WAR by URL**

Install a web application directory or ".war" file located on the Tomcat server. If

no *Context Path* is specified, the directory name or the war file name without the “.war” extension is used as the path. The *WAR or Directory URL* specifies a URL (including the file: scheme) for either a directory or a web application archive (WAR) file.

In this example the web application located in the directory **C:\path\to\foo** on the Tomcat server (running on Windows) is deployed as the web application context named **/foo**.

Context Path: /foo

WAR or Directory URL: file:C:/path/to/foo in our example it is **C:\Program Files\Apache Software Foundation\Tomcat 9.0\webapps\examples\jsp\include**

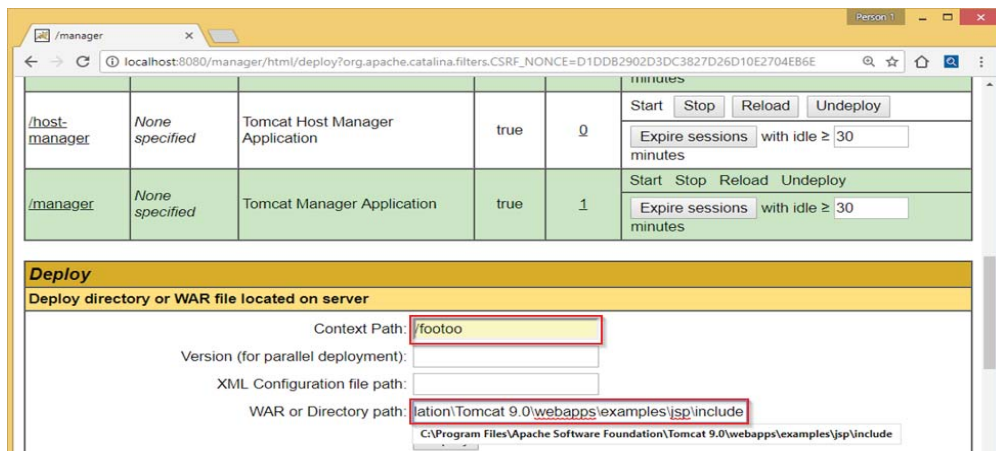

Figure 11. 12: Deploy directory or WAR file by URL

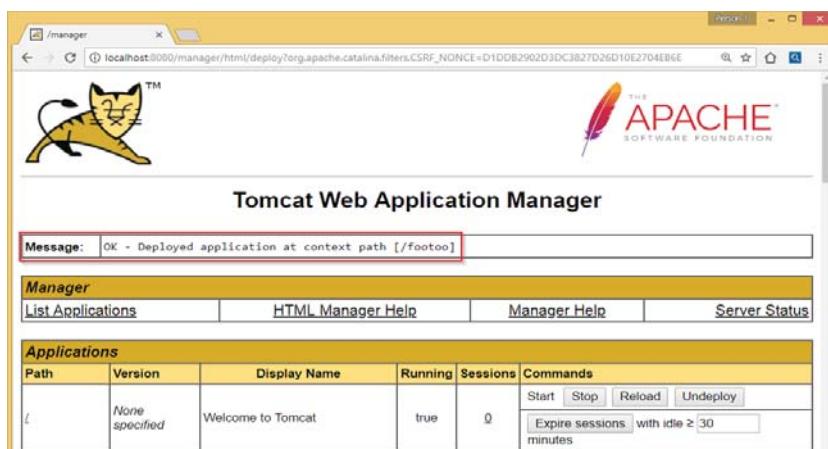

Figure 11. 13: Successful Deployment message

11.4.8. Using the documentation

Apache Tomcat has its built in documentation which will assist you in downloading and installing Apache Tomcat, and using many of the Apache Tomcat features. To explore this documentation, go to the Apache Tomcat home page and click on documentation as shown in the figure below:

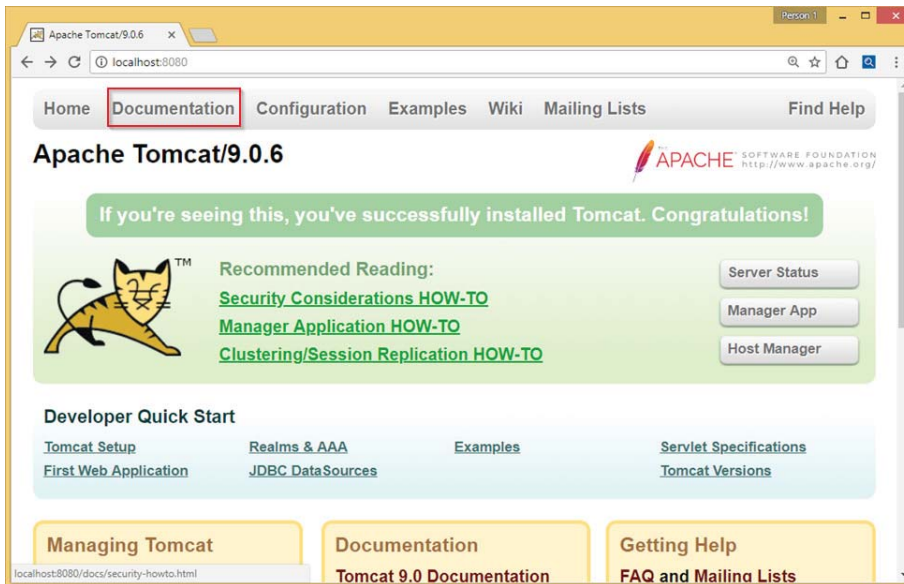

Figure 11. 14: Tomcat documentation link

Application Activity 11.4

1. Why would you prefer to develop a web application?
2. Explain the functional difference between JSP and servlet?
3. Explain the servlet life cycle.
4. Write a JSP to display a message of welcome to your school.

11.5. A Uniform Resource Locator (URL)

Activity 11.5

Open your browser and enter the following website addresses:

http://www.reb.rw/index.php?id=270

http://www.reb.rw

Question: Compare the outputs and indicate the differences and resemblances.

11.5.1. Definition of URL

URL is the global address of documents and other resources on the World Wide Web. Its main purpose is to identify the location of a document and other web resources available on the Internet, and specify the mechanism for accessing it through a web browser.

For instance, if you look at the address bar of your browser you will see:

http://www.reb.rw/index.php?id=270

11.5.2. The URL Syntax

The general syntax of URLs is the following: *scheme://host:port/path?query-string#fragment-id*

A URL has a linear structure and normally consists of some of the following:

- **Scheme name** — The scheme identifies the protocol to be used to access the resource on the Internet. The scheme names followed by the three characters *://* (a colon and two slashes). The most commonly used protocols are *http://*, *https://*, *ftp://*, and *mailto://*.
- **Host name** — The host name identifies the server where resource is located. A hostname is a domain name assigned to a server computer. This is usually a combination of the host's local name with its parent domain's name. For example, *http://www.reb.rw* consists of host's machine name *www* and the domain name *.reb.rw*
- **Port Number** — Servers often deliver more than one type of service, so you must also tell the server what service is being requested. These requests are made by port number. Well-known port numbers for a service are normally omitted from the URL. For example, web service HTTP is commonly delivered on port 80.
- **Path** — The path identifies the specific resource within the host that the user wants to access. For example, */html/html-url.php*
- **Query String** — The query string contains data to be passed to server-side scripts, running on the web server. For example, parameters for a search. The query string preceded by a question mark, is usually a string of name and value pairs separated by ampersands, for example, *?first_name=John&last_name=Corner*.
- **Fragment identifier** — The fragment identifier, if present, specifies a part or a position within the overall resource or document. The fragment identifier introduced by a hash mark "*#*" is the optional last part of a URL for a document. When fragment identifier used with HTTP, it usually specifies a section or location within the page, and the browser may scroll to display that part of the page.

11.5.3. Static and dynamic web pages

a. Static

A static page is one that is usually designed in plain HTML and the content is always same. A static website contains Web pages with fixed content. Each page is coded in HTML and displays the same information to every visitor. Static sites are the most basic type of website and are the easiest to create. A static site can be built by simply creating a few HTML pages and publishing them to a Web server.

Advantages of static websites and web pages

- Easy to develop
- Cheap to develop
- Cheap to host

b. Dynamic

Dynamic webpages can show the different content or information based on the results of a search or some other request. It is designed by server side scripting language like PHP, ASP, JSP with HTML, CSS.

Advantages of dynamic websites and web pages

- Much more functional website
- Much easier to update
- Can connect with database
- New content brings people back to the site and helps in the search engines
- Can work as a system to allow staff or users to collaborate

Application Activity 11.5

1. Describe what you see on the URL given below: http://primature.gov.rw/home.html?no_cache=1&tx_drblob_pi1%5BdownloadUid%5D=484
2. Discuss the advantages of dynamic websites and web pages.
3. What are the barriers of static websites and webpages?

11.6. Project creation

Activity 11.6

You are requested to make a proposal of the website for your school,

1. Explain the process to create that website and test it on your computer.
2. Show the director of the school the cost of the website.

11.6.1. Project creation using Tomcat

Once you get Tomcat up and running on your server, the next step is configuring its basic settings. If you plan to create a Web service that uses Apache Tomcat as its server, it must be configured before you begin creating your Web service. Following are the steps to configure the Tomcat Server:

Step 1:Configure Tomcat Server

The Tomcat configuration files are located in the “conf” sub-directory of your Tomcat installed directory, e.g. “C:\Program Files\Apache Software Foundation\Tomcat 9.0\conf”. There are 4 configuration XML files:

1. server.xml
2. web.xml
3. context.xml
4. tomcat-users.xml

Step 1(a) “conf\server.xml” - Set the TCP Port Number

1. Use a programming text editor (e.g., NotePad++, TextPad) to open the configuration file “server.xml”, under the “conf” sub-directory of Tomcat installed directory.

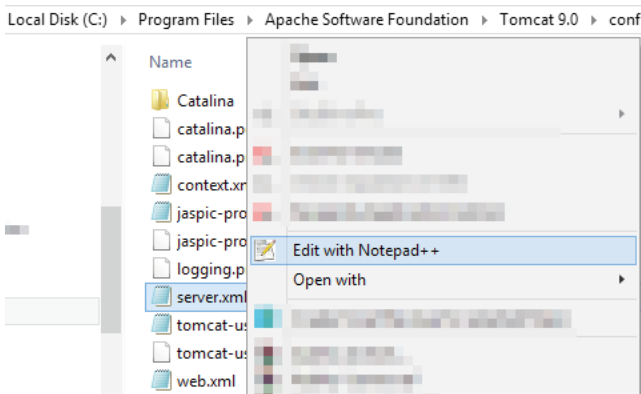

Figure 11. 15: Opening the server.xml file

2. The default TCP port number configured in Tomcat is 8080, you may choose any number between 1024 and 65535, which is not used by an existing application. We shall choose 9999 in this example.
3. Locate the following lines (around Line 69) that define the HTTP connector, and change port="8080" to port="9999".

Notice: Remember to save changes

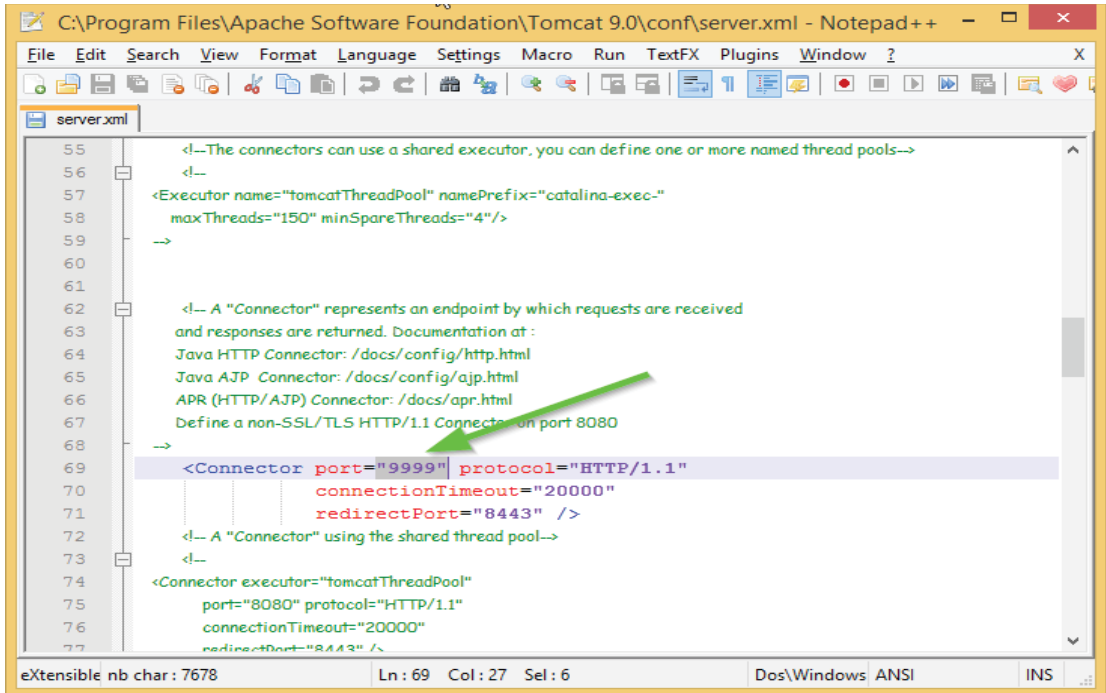

Figure 11. 16: Setting the port number to 9999

Step 1(b) "conf\web.xml" - Enabling Directory Listing

Directory listing is a web server function that displays a list of all the files when there is not an index file, such as index.php and default.asp in a specific website directory.

Again, use a programming text editor to open the configuration file "web.xml", under the "conf" sub-directory of Tomcat installed directory.

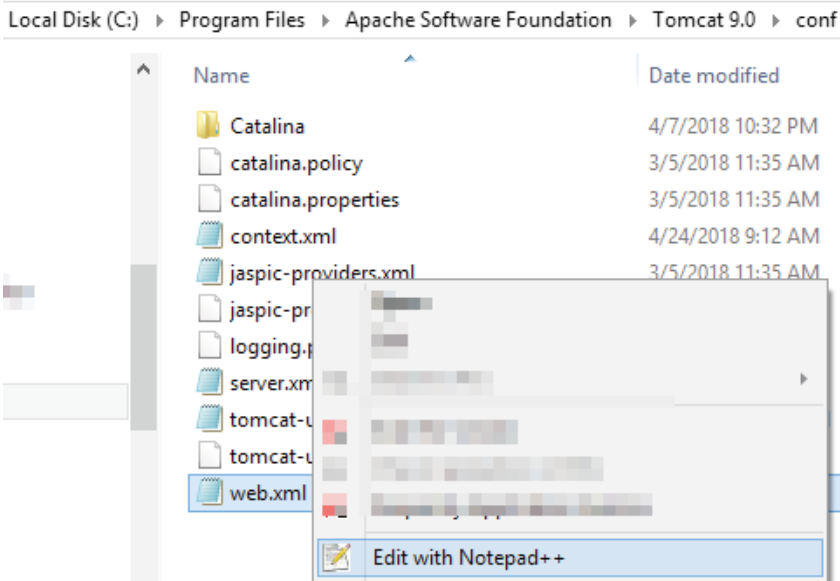

Figure 11. 17: Opening the web.xml file

We shall enable directory listing by changing “listings” from “false” to “true” for the “default” servlet. Locate the following lines (around Line 108) that define the “default” servlet; and change the “listings” from “false” to “true”.

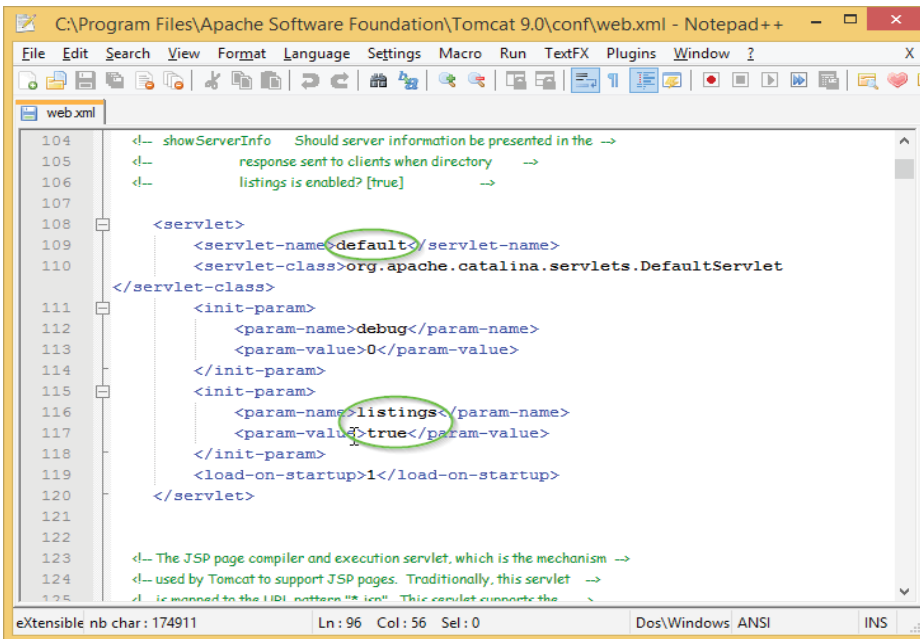

Figure 11. 18: Setting the listing value to true

Step 1(c) “conf\context.xml” - Enabling Automatic Reload

We shall add the attribute `reloadable="true"` to the `<Context>` element to enable automatic reload after code changes. Again, this is handy for test system but not for production, due to the overhead of detecting changes.

Locate the `<Context>` start element (around Line 19), and change it to `<Context reloadable="true">`.

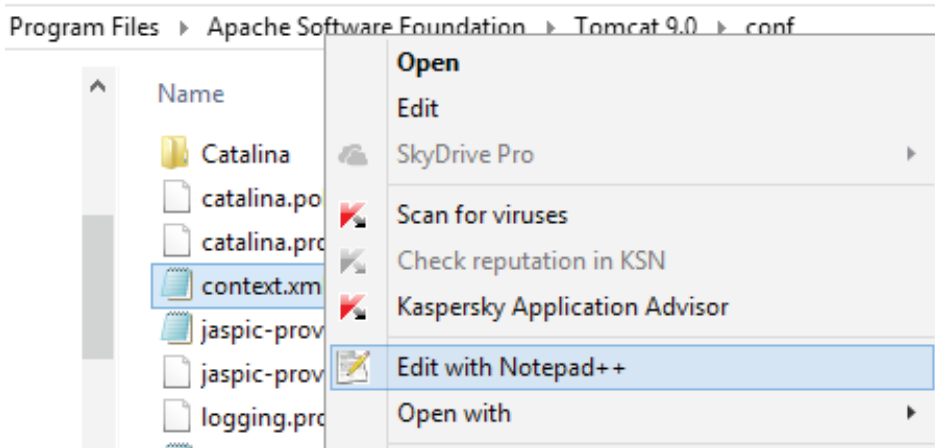

Figure 11. 19: Opening the context.xml file

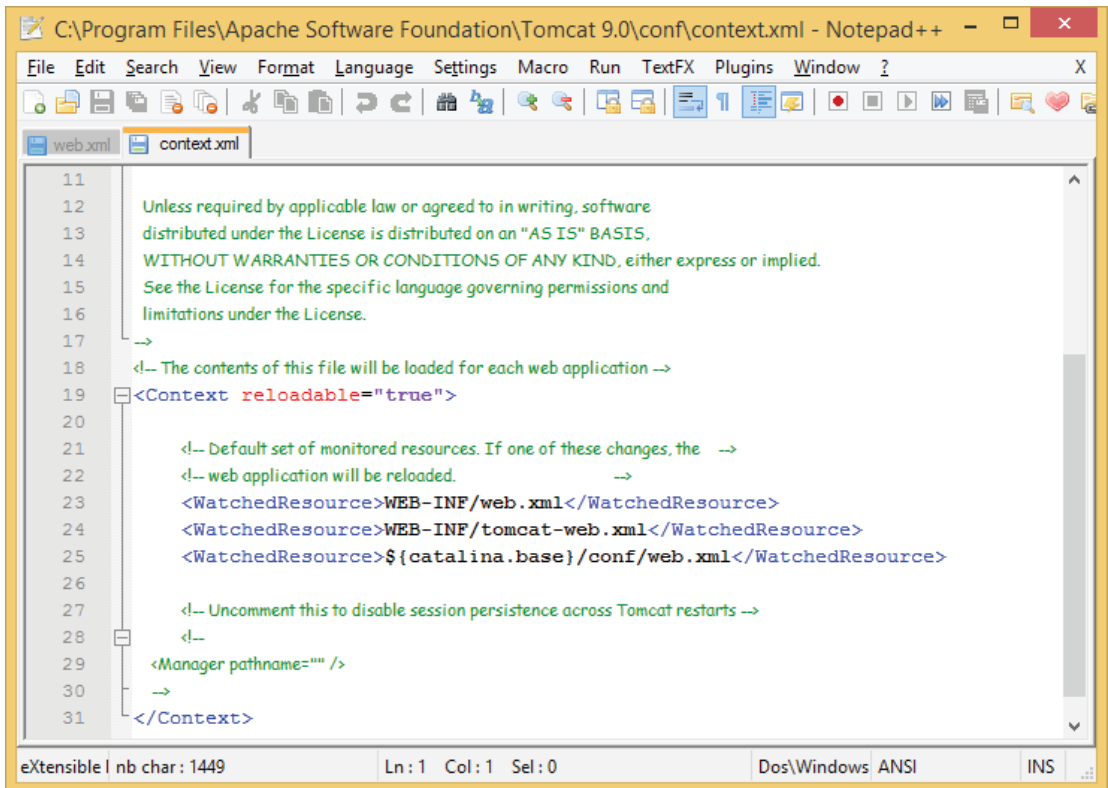

Figure 11. 20: Setting the reload value to true

Step 2(a) Start Server

By default, Tomcat is set to start automatically when windows starts. But after configuring Tomcat basic settings, the next step is to restart the server in order to ensure that all configurations take effect. To do so, open the Tomcat configuration properties, stop and start it as follows:



Figure 11. 21: Starting Tomcat and Stopping Tomcat

Step 2(b) Start a Client to Access the Server

Start a browser (Firefox, Chrome) as an HTTP client. Issue URL "http://localhost:9999" to access the Tomcat server's welcome page. The hostname "localhost" (with IP address of 127.0.0.1) is meant for local loop-back testing inside the same machine.

Step 3: Develop and Deploy a WebApp

The container that holds the components of a web application is the directory structure in which it exists. The first step in creating a web application is creating this directory structure.

Step 3(a) Create the Directory Structure for your WebApp

The root directory of our web application should be placed under /webapps as indicated in the figure below:

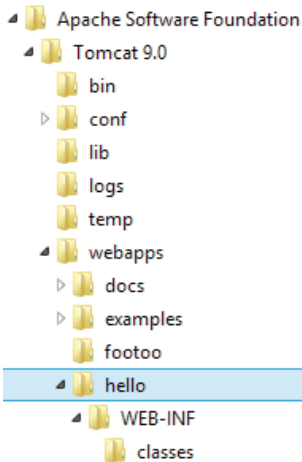

Figure 11.24: Web application directory structure

Let us call our first webapp “**hello**”. Go to Tomcat’s “webapps” sub-directory and create the following directory structure for your webapp “**hello**” (as illustrated):

Under Tomcat’s “webapps”, create your webapp’s root directory “hello”

1. (i.e., “<TOMCAT_HOME>\webapps\hello”).
Under “hello”, create a sub-directory “WEB-INF”
2. (i.e., “<TOMCAT_HOME>\webapps\hello\WEB-INF”).
Under “WEB-INF”, create a sub-sub-directory “classes”
3. (i.e., “<TOMCAT_HOME>\webapps\hello\WEB-INF\classes”).

You need to keep your web resources (e.g., HTMLs, CSSs, images, scripts, servlets, JSPs) in the proper directories:

- “hello”: This is called the context root (or document base directory) of your webapp. You should keep all your HTML files and resources visible to the web users (e.g., HTMLs, CSSs, images, scripts, JSPs) under this context root.
- “hello/WEB-INF”: This directory, although under the context root, is not visible to the web users. This is where you keep your application’s web descriptor file “web.xml”.
- “hello/WEB-INF/classes”: This is where you keep all the Java classes such as servlet class-files.

You can issue the following URL to access the web application “hello”:

<http://localhost:9999/hello>

You should see the directory listing of the directory “<TOMCAT_HOME>\webapps\hello”, which shall be empty at this point of time. (Take note that we have earlier enabled directory listing in “web.xml”. Otherwise, you will get an error “404 Not Found”).



Figure 11. 25: Directory listing

Step 3(b) Write a Welcome Page

Create the following HTML page and save as “HelloHome.html” in your application’s root directory “hello”.

1. <html>
2. <head><title>My Home Page</title></head>
3. <body>
4. <h1>My Name is MUGISHA.
 This is my HOME.</h1>
5. </body>
6. </html>

You can browse this page by issuing this URL:

<http://localhost:9999/hello/HelloHome.html>

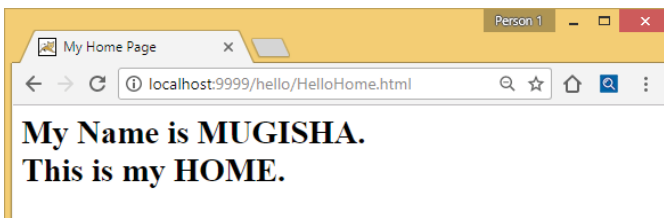

Figure 11. 26: Welcome page

11.6.2. Steps to create web application project in Netbeans IDE

To create a servlet application in Netbeans IDE, you will need to follow the following (simple) steps:

1. Open Netbeans IDE, Select **File -> New Project**

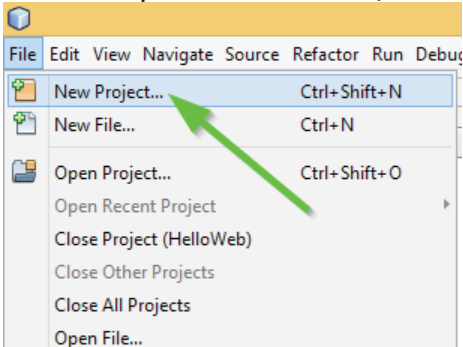

Figure 11.27: Creating a new project

2. Select **Java Web -> Web Application**, then click on Next,

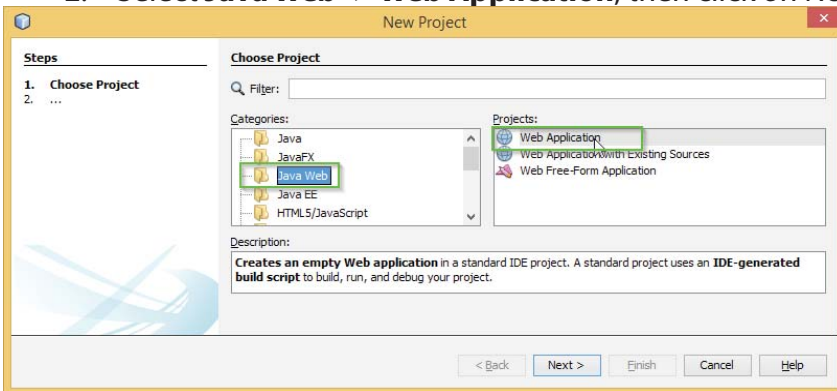

Figure 11.28: Choosing Java Web Application

3. Give a name to your project and click on Next,

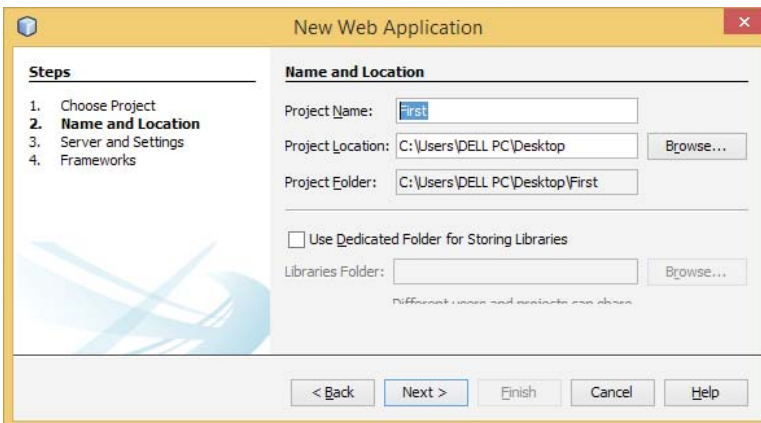

Figure 11.29: Defining the project name

4. Click **Finish**
5. The complete directory structure required for the Servlet Application will be created automatically by the IDE.

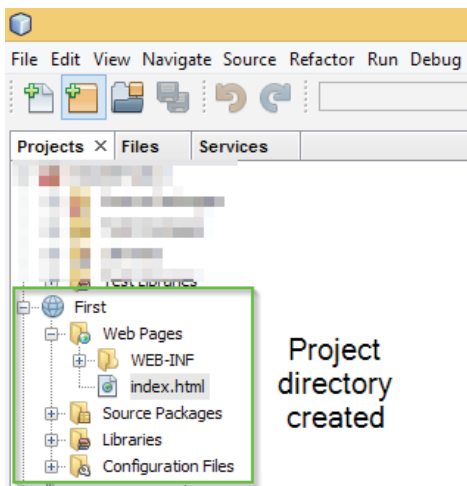

Figure 11.30: Project directory structure

6. To create a Servlet, open Source Package, right click on default packages -> New -> Servlet.

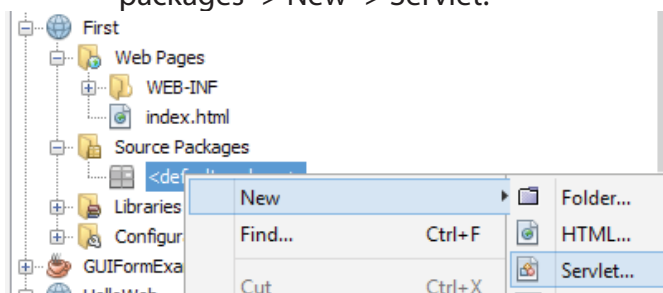

Figure 11.31: Creating a new servlet

7. Give a Name to your Servlet class file

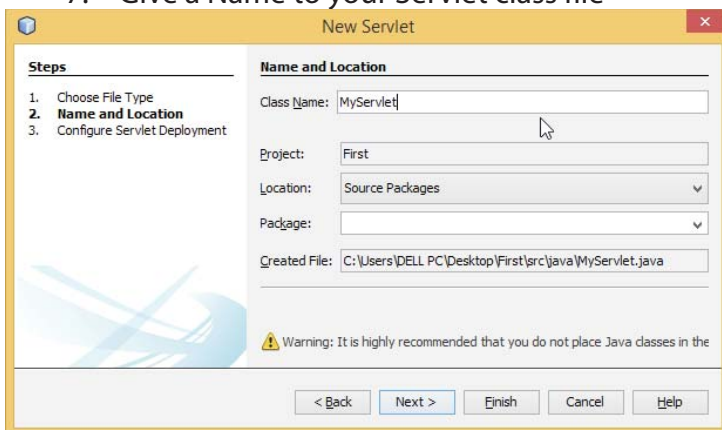

Figure 11.32: Naming servlet class file

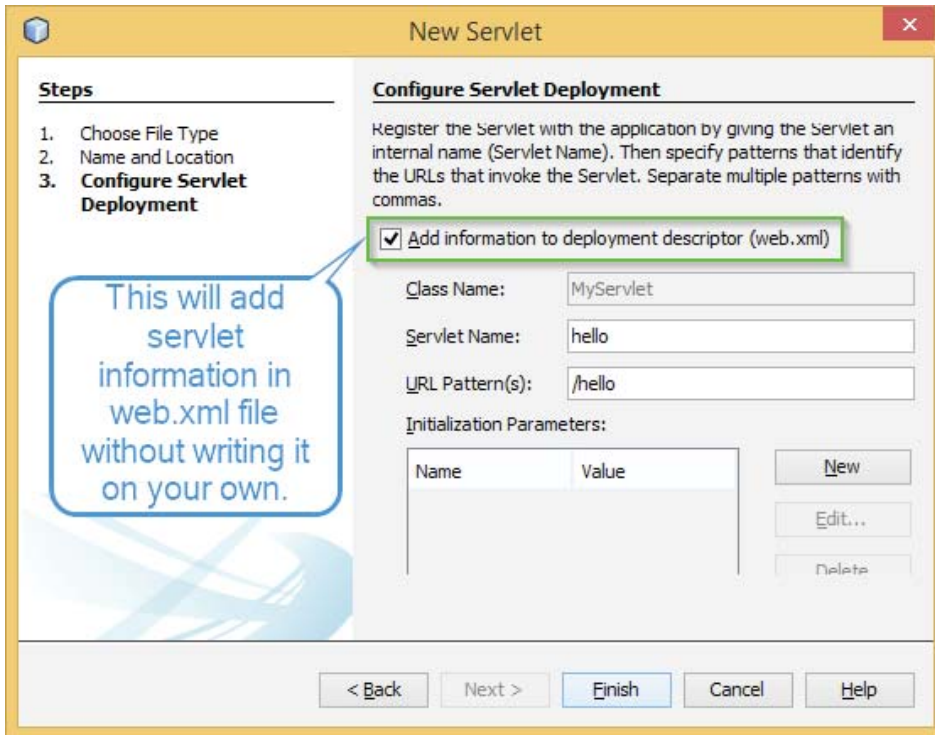

Figure 11.33: Defining the servlet name

8. Now, your Servlet class is ready.

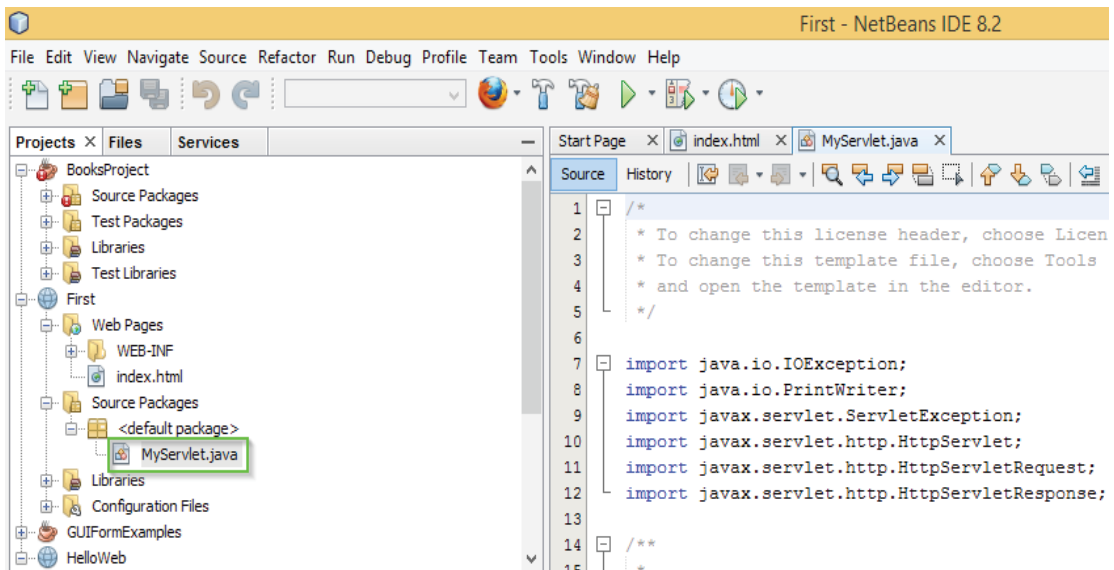
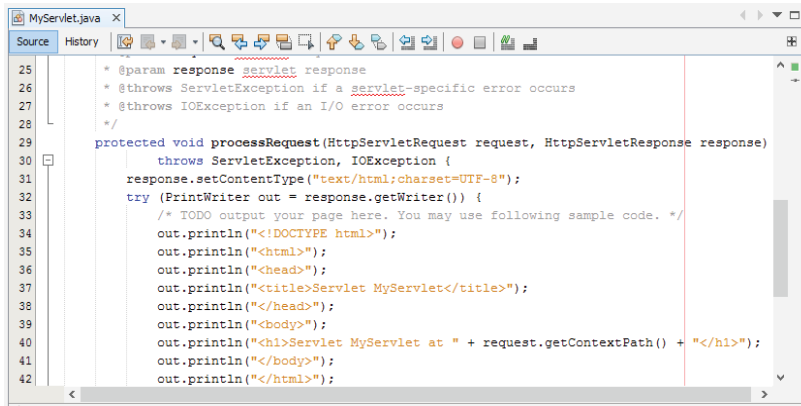

Figure 11.34: Location of the servlet

9. Write some code inside your Servlet class.



```
25 * @param response servlet response
26 * @throws ServletException if a servlet-specific error occurs
27 * @throws IOException if an I/O error occurs
28 */
29 protected void processRequest(HttpServletRequest request, HttpServletResponse response)
30     throws ServletException, IOException {
31     response.setContentType("text/html;charset=UTF-8");
32     try (PrintWriter out = response.getWriter()) {
33         /* TODO output your page here. You may use following sample code. */
34         out.println("<!DOCTYPE html>");
35         out.println("<html>");
36         out.println("<head>");
37         out.println("<title>Servlet MyServlet</title>");
38         out.println("</head>");
39         out.println("<body>");
40         out.println("<h1>Servlet MyServlet at " + request.getContextPath() + "</h1>");
41         out.println("</body>");
42         out.println("</html>");
```

Figure 11.35: Adding codes to the servlet

10. Create an HTML file, right click on **Web Pages** -> **New** -> **HTML**

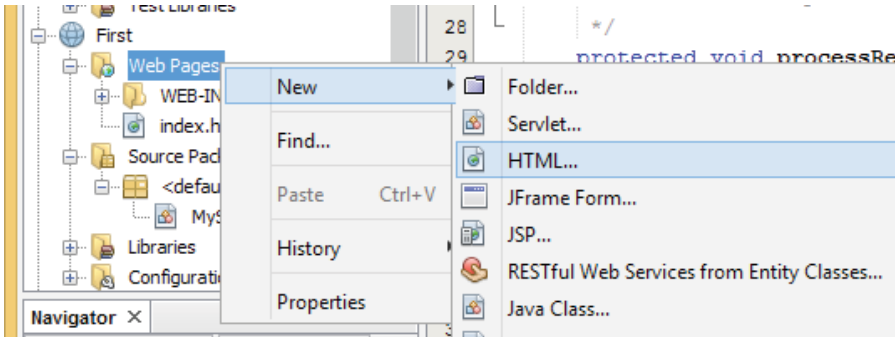

Figure 11.36: Creating an html file

11. Give it a name. We recommend you to name it index, because browser will always pick up the index.html file automatically from a directory. Index file is read as the first page of the web

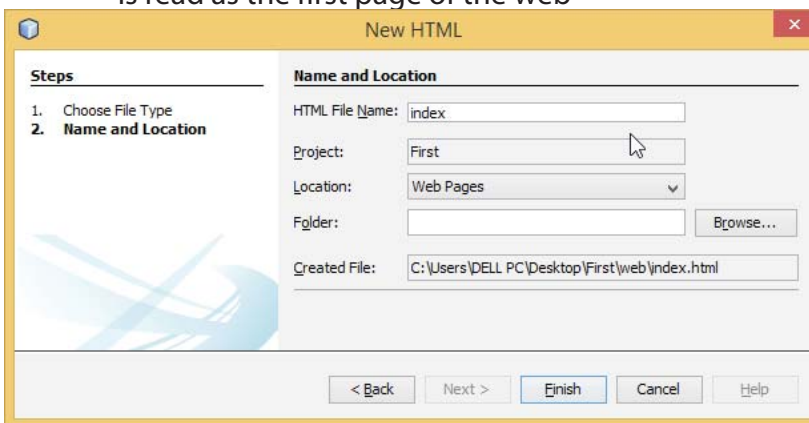

Figure 11.37: Naming the html file

12. Write some code inside your HTML file. We have created a hyperlink to our Servlet in our HTML file.

```
4 To change this template file, choose Tools | Templates
5 and open the template in the editor.
6 -->
7 <html>
8   <head>
9     <title>TODO supply a title</title>
10    <meta charset="UTF-8">
11    <meta name="viewport" content="width=device-width, initial-scale=1.0">
12  </head>
13  <body>
14    <div>Click here to go to<a href="hello">MyServlet page</a></div>
15  </body>
16 </html>
17
```

Figure 11.38: Writing codes inside html

13. Edit **web.xml** file. In the web.xml file you can see, we have specified the **url-pattern** and the **servlet-name**, this means when hello url is accessed our Servlet file will be executed.

```
1 <?xml version="1.0" encoding="UTF-8"?>
2 <web-app version="3.1" xmlns="http://xmlns.jcp.org/xml/ns/javaee" xmlns:xsi="http://www.w3.org/2001/XMLSchema-instance" xsi:schemaLocation="http://xmlns.jcp.org/xml/ns/javaee http://xmlns.jcp.org/xml/ns/javaee/web-app_3_1.xsd">
3   <servlet>
4     <servlet-name>hello</servlet-name>
5     <servlet-class>MyServlet</servlet-class>
6   </servlet>
7   <servlet-mapping>
8     <servlet-name>hello</servlet-name>
9     <url-pattern>/hello</url-pattern>
10  </servlet-mapping>
11  <welcome-file-list>
12    <welcome-file>index.html</welcome-file>
13  </welcome-file-list>
14  <session-config>
15    <session-timeout>
16      30
17    </session-timeout>
18  </session-config>
```

Figure 11.39: Defining a URL to the servlet

14. Click on the link created, to open your Servlet.

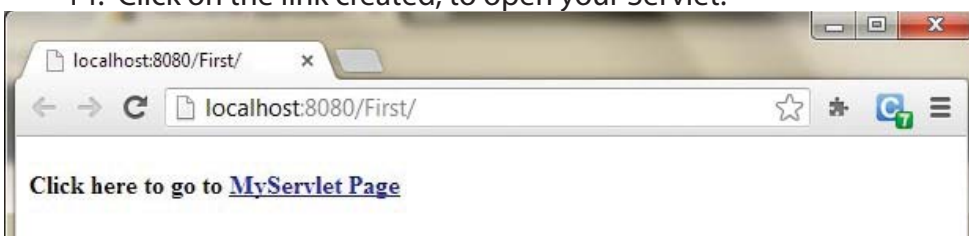

Figure 11.40: Opening the index page

15. Our First Servlet class is running



Figure 11.41: Servlet page

11.6.3. Http Session

Session is a conversational state between client and server and it can consist of multiple request and response between client and server. This is how a HttpSession object is created.

```
protected void doPost(HttpServletRequest req,  
    HttpServletResponse res)  
    throws ServletException, IOException {  
    HttpSession session = req.getSession();  
}
```

a. .setAttribute()

You can store the user information into the session object by using `setAttribute()` method and later when needed this information can be fetched from the session. This is how you store info in session. Here we are storing username, emailid and usage in session with the attribute name `uName`, `uemailId` and `uAge` respectively.

```
session.setAttribute("uName", "Mukamana");  
session.setAttribute("uemailId", "mukamana@gmail.com");  
session.setAttribute("uAge", "30");
```

This first parameter is the attribute name and second is the attribute value. For e.g. `uName` is the attribute name and `Mukamana` is the attribute value in the code above.

b. .getAttribute

To get the value from session we use the `getAttribute()` method of HttpSession interface. Here we are fetching the attribute values using attribute names.

```
String userName = (String) session.getAttribute("uName");  
String userEmailId = (String) session.getAttribute("uemailId");  
String userAge = (String) session.getAttribute("uAge");
```

Session Example

index.html

```
<form action="login">  
  User Name:<input type="text" name="userName"/><br/>  
  Password:<input type="password" name="userPassword"/><br/>  
<input type="submit" value="submit"/>  
</form>
```

MyServlet1.java

```
import java.io.*;  
import javax.servlet.*;  
import javax.servlet.http.*;  
public class MyServlet1 extends HttpServlet {  
    public void doGet(HttpServletRequest request, HttpServletResponse response){  
        try{  
            response.setContentType("text/html");  
            PrintWriter pwriter = response.getWriter();  
            String name = request.getParameter("userName");  
            String password = request.getParameter("userPassword");  
            pwriter.print("Hello "+name);  
            pwriter.print("Your Password is: "+password);  
            HttpSession session=request.getSession();  
            session.setAttribute("uname",name);  
            session.setAttribute("upass",password);  
            pwriter.print("<a href='welcome'>view details</a>");  
            pwriter.close();  
        }catch(Exception exp){  
            System.out.println(exp);  
        }  
    }  
}
```

MyServlet2.java

```
import java.io.*;  
import javax.servlet.*;
```

```

import javax.servlet.http.*;
public class MyServlet2 extends HttpServlet {
    public void doGet(HttpServletRequest request, HttpServletResponse response){
        try{
            response.setContentType("text/html");
            PrintWriter pwriter = response.getWriter();
            HttpSession session=request.getSession(false);
            String myName=(String)session.getAttribute("uname");
            String myPass=(String)session.getAttribute("upass");
            pwriter.print("Name: "+myName+" Pass: "+myPass);
            pwriter.close();
        }catch(Exception exp){
            System.out.println(exp);
        }
    }
}

```

web.xml

```

<web-app>
<servlet>
<servlet-name>Servlet1</servlet-name>
<servlet-class>MyServlet1</servlet-class>
</servlet>
<servlet-mapping>
<servlet-name>Servlet1</servlet-name>
<url-pattern>/login</url-pattern>
</servlet-mapping>
<servlet>
<servlet-name>Servlet2</servlet-name>
<servlet-class>MyServlet2</servlet-class>
</servlet>
<servlet-mapping>
<servlet-name>Servlet2</servlet-name>

```

```
<url-pattern>/welcome</url-pattern>
```

```
</servlet-mapping>
```

```
</web-app>
```

The output will be as follows:

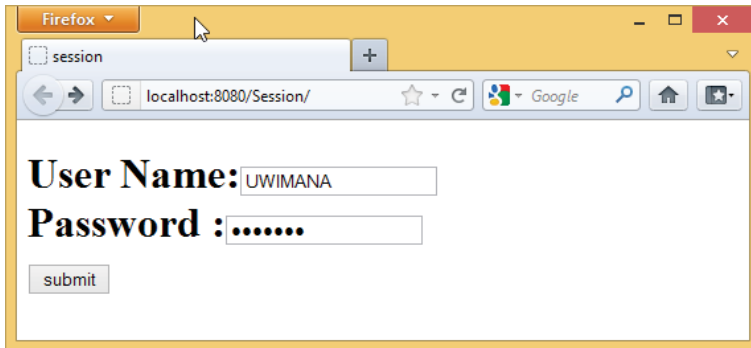

Figure 11.42: Home page

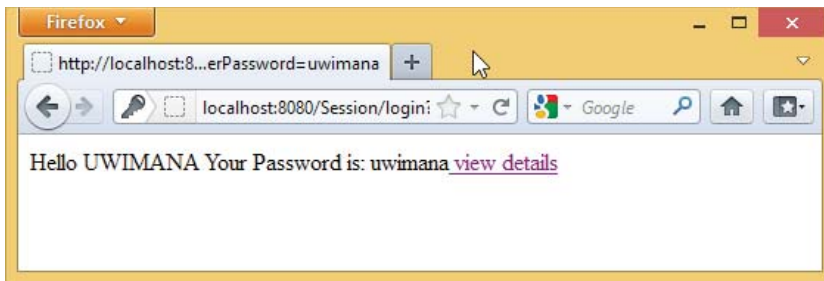

Figure 11.43: Login page

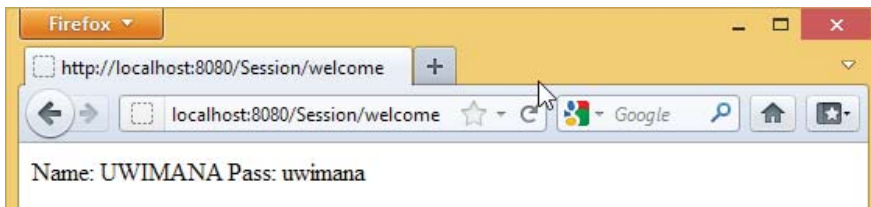

Figure 11.44: Login details

Application Activity 11.6

1. Create a web application project as follows:
 - Location: Desktop/Senior6
 - Title of the index page: Library
 - Message: Welcome to the school library.
 - Class Name: LibraryServlet
 - Servlet Name: LibraryServlet
 - Your servlet page should list some of the books

11.7 Java Server Pages

Activity 11.7

Look at the codes indicated below and explain the difference between them.

Index1	Index2
<pre><%@page contentType="text/html" pageEncoding="UTF-8"%> <!DOCTYPE html> <html> <head> <meta http-equiv="Content-Type" content="text/html; charset=UTF-8"> <title>Expression</title> </head> <body> <% String str = "Hello world"; %> <%= str %> </body> </html></pre>	<pre><html> <head> <meta http-equiv="Content-Type" content="text/html; charset=UTF-8"> <title>Expression</title> </head> <body> Hello world! </body> </html></pre>

11.7.1 Introduction

Java Server Pages (JSP) is a standard Java extension that is defined on top of the servlet Extensions. The goal of JSPs is the simplified creation and management of dynamic Web pages. JSPs allow you to combine the HTML of a Web page with pieces of Java code in the same document. The Java code is surrounded by special tags that tell the JSP container that it should use the code to generate a servlet, or part of one. The benefit of JSPs is that you can maintain a single document that represents both the page and the Java code that enables it. The JSP tags begin and end with angle brackets, just like HTML tags, but the tags also include percent signs, so all JSP tags are denoted by `<% JSP code here %>`

11.7.1 Creating a new JSP page in netbeans

To create a JSP page, the following steps are necessary:

1. Right click on your project's name ->New -> JSP(in this example, the project is "Senior6")

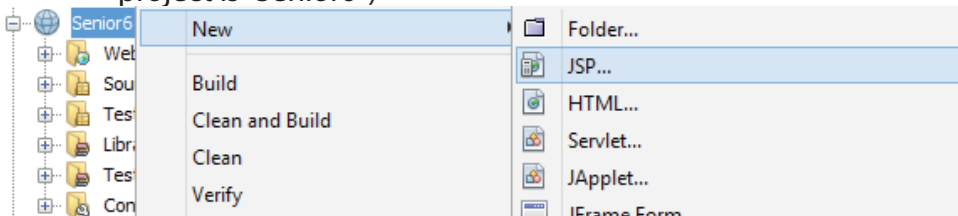

Figure 11.45: Creating a new JSP

2. Enter a name for your JSP. Then click Finish:

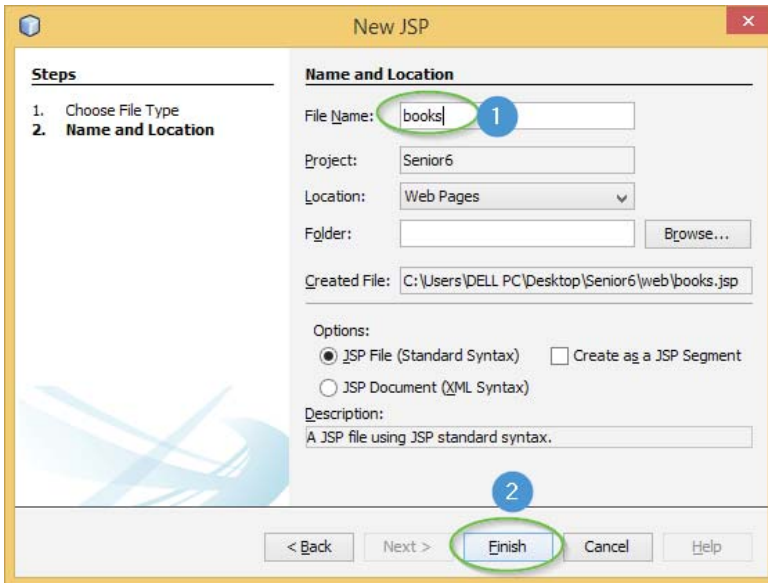

Figure 11.46: Defining a JSP name

3. Netbeans creates a skeleton JSP page comprising of little more than the <head> and <body> tags and a couple of commented-out sample bean directives.
4. Add codes as follows:

```

9 <html>
10 <head>
11 <meta http-equiv="Content-Type" content="text/html; charset=UTF-8">
12 <title>JSP Page</title>
13 </head>
14 <h2>Choose books</h2>
15 <form method="get">
16 <input type="checkbox" name="book" value="Apache Tomcat Cookbook">Apache
17 <input type="checkbox" name="book" value="Thinking in java">Java
18 <input type="checkbox" name="book" value="Java EE Web application">J2EE
19 <input type="checkbox" name="book" value="C programming">C
20 <input type="submit" value="Query">
21 </form>
22 <%
23 String[] books = request.getParameterValues("book");
24 if (books != null) {
25 %>
26 <h3>You have selected book(s):</h3>
27 <ul>
28 <%
29 for (String book : books) {
30 %>
31 <li><%= book %></li>
32 <%
33 }
34 %>
35 </ul>
36 <%
37 }
38 %>
39 <br /><a href="<%= request.getRequestURI() %>">BACK</a>
40 </html>

```

Figure 11.47: JSP codes

- To run your JSP page select it in the explorer or source editor and hit F6 or the  button. The output in the browser looks like this:

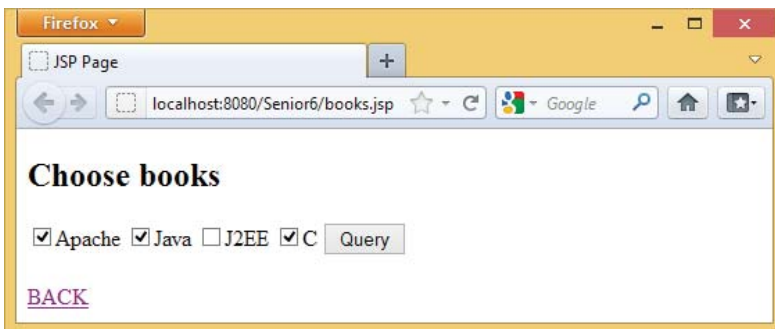

Figure 11.48: JSP home page

- After making selection of books, click on the query button, the output will look like this:

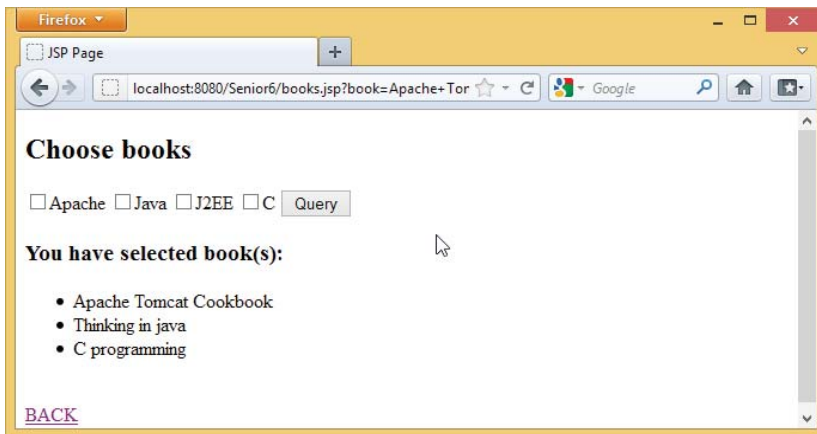

Figure 11.49: JSP output

11.7.3. JSP directives

Directives are messages to the JSP container and are denoted by the “@”:

```
<%@ directive {attr="value"}* %>
```

Directives do not send anything to the **out** stream, but they are important in setting up your JSP page’s attributes and dependencies with the JSP container. For example, the line:

`<%@ page language="java" %>` says that the scripting language being used within the JSP page is Java.

The most important directive is the page directive. It defines a number of page dependent attributes and communicates these attributes to the JSP container. These attributes include: **language, extends, import, session, buffer, autoFlush, isThreadSafe, info and errorPage**. For example:

```
<%@ page session="true" import="java.util.*" %>
```

This line first indicates that the page requires participation in an HTTP session. The import attribute describes the types that are available to the scripting environment.

11.7.4. JSP scripting elements

Once the directives have been used to set up the scripting environment you can utilize the scripting language elements. JSP has three scripting language elements—**declarations, scriptlets, and expressions**. A declaration will declare elements, a scriptlet is a statement fragment, and an expression is a complete language expression. In JSP each scripting element begins with a “<%”. The syntax for each is:

`<%! declaration %>`

`<% scriptlet %>`

`<%= expression %>`

White space is optional after "`<%!`", "`<%`", "`<%=`", and before "`%>`."

All these tags are based upon XML; you could even say that a JSP page can be mapped to a XML document. The XML equivalent syntax for the scripting elements above would be:

`<jsp:declaration> declaration </jsp:declaration>`

`<jsp:scriptlet> scriptlet </jsp:scriptlet>`

`<jsp:expression> expression </jsp:expression>`

In addition, there are two types of comments:

`<%-- jsp comment --%>`

`<!-- html comment -->`

The first form allows you to add comments to JSP source pages that will not appear in any form in the HTML that is sent to the client. Of course, the second form of comment is not specific to JSPs, it's just an ordinary HTML comment.

a. Declaration

Declarations are used to declare variables and methods in the scripting language used in a JSP page. The declaration must be a complete Java statement and cannot produce any output in the **out** stream. In the **Hello.jsp** example below, the declarations for the variables **loadTime**, **loadDate** and **hitCount** are all complete Java statements that declare and initialize new variables.

`<%@page contentType="text/html" pageEncoding="UTF-8"%>`

`<!DOCTYPE html>`

`<%-- This JSP comment will not appear in the
generated html --%>`

`<%-- This is a JSP directive: --%>`

`<%@ page import="java.util.*" %>`

`<%-- These are declarations: --%>`

`<%!`

`long loadTime= System.currentTimeMillis();`

`Date loadDate = new Date();`

`int hitCount = 0;`

```

%>
<html><body>
<%-- The next several lines are the result of a
JSP expression inserted in the generated html;
the '=' indicates a JSP expression --%>
<H1>This page was loaded on <%= loadDate %></H1>
<H1>Hello, world! It's <%= new Date() %></H1>
<H2>Here's an object: <%= new Object() %></H2>
<H2>This page has been up
<%= (System.currentTimeMillis()-loadTime)/1000 %>
seconds</H2>
<H3>Page has been accessed <%= ++hitCount %>
times since <%= loadDate %></H3>
<%-- A "scriptlet" that writes to the server
console and to the client page.
Note that the ';' is required: --%>
<%
System.out.println("Goodbye");
out.println("<h1>Murabehe!</h1>");
%>
</body></html>

```

When you run this program you will see that the variables **loadTime**, **loadDate** and **hitCount** hold their values between hits to the page, so they are clearly fields and not local variables. At the end of the example is a scriptlet that writes "Goodbye" to the Web server console and "Murabehe" to the implicit **JspWriter** object **out**.

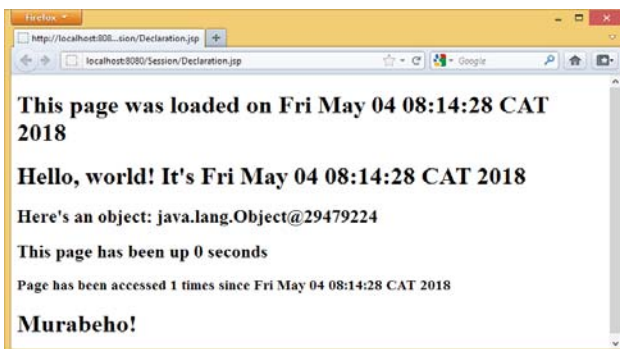

Figure 11. 50: Variable output

b. Scriptlets

Scriptlets are used to insert Java code in your JSP page. The Java code is enclosed within tags `<% %>`, which are known as Scriptlet Tags. A JSP Scriptlet tag may hold the Java code comprising java expressions, statements or variable. JSP comes with a built-in Java object named `out` which allows us to write a text to the JSP web page, below is an example of how we can use the in-built `out` object within the scriptlet tag to display a message on a web page.

```
<%@page contentType="text/html" pageEncoding="UTF-8"%>
<!DOCTYPE html>
<html>
<head>
<meta http-equiv="Content-Type" content="text/html; charset=UTF-8">
<title>First JSP</title>
</head>
<body>
<% out.println("Saying hello from Java using Scriptlet Tag"); %>
</body>
</html>
```

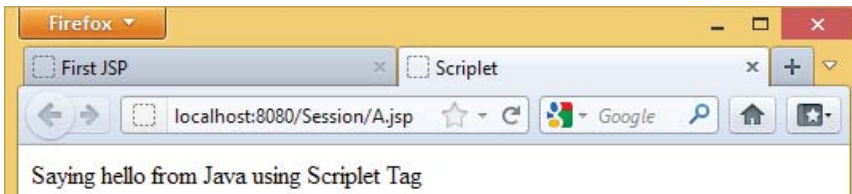

Figure 11.51: Scriptlet

c. Expressions

Expression tag evaluates the expression placed in it, converts the result into String and send the result back to the client through response object. Java expressions result in a value, hence JSP Expression tags are used to enclose java expressions that yield a value to be printed on a JSP web page. The Java expressions are enclosed in within `<%= %>` tags.

JSP expression tag Examples

```

<%@page contentType="text/html" pageEncoding="UTF-8"%>
<!DOCTYPE html>
<html>
<head>
<meta http-equiv="Content-Type" content="text/html; charset=UTF-8">
<title>Expression</title>
</head>
<body>
<% String str = "Hello world"; %>
<%= str %>
</body>
</html>

```

Executing this JSP prints the value of java expression str which yields a value of String object.

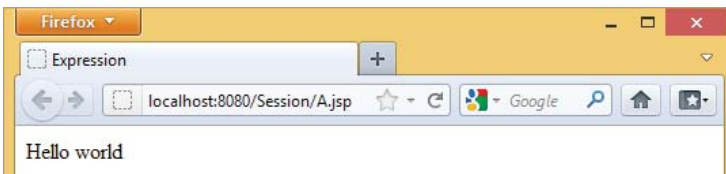

Figure 11.52: JSP expression which returns the value of a Java variable

```

<%@page contentType="text/html" pageEncoding="UTF-8"%>
<!DOCTYPE html>
<html>
<head>
<meta http-equiv="Content-Type" content="text/html; charset=UTF-8">
<title>Expression</title>
</head>
<body>
<%! public int add(int a, int b)
{
int sum = a + b;
return sum;
}

```

```
%>
```

```
The Sum of two integers is : <%= add(30,35) %>
```

```
</body>
```

```
</html>
```

Executing this JSP prints the value of java expression str which yields a value of String object.

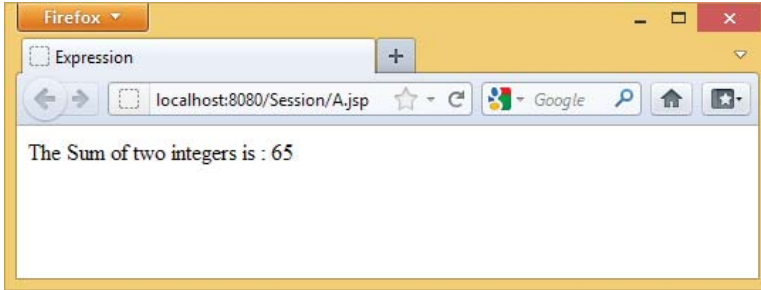

Figure 11.53: JSP expression which returns the value from a Java method

11.7.5. JSP page attributes and scope

By poking around in the HTML documentation for servlets and JSPs, you will find features that report information about the servlet or JSP that is currently running. The following example displays a few of these pieces of data.

```
#!/ c15:jsp:PageContext.jsp
<%--Viewing the attributes in the pageContext--%>
<%-- Note that you can include any amount of code
inside the scriptlet tags --%>
<%@ page import="java.util.*" %>
<html><body>
Servlet Name: <%= config.getServletName() %><br>
Servlet container supports servlet version:
<% out.print(application.getMajorVersion() + ""
+ application.getMinorVersion()); %><br>
<%
session.setAttribute("My country", "Rwanda");
for(int scope = 1; scope <= 4; scope++) { %>
<H3>Scope: <%= scope %></H3>
<% Enumeration e =
```

```

pageContext.getAttributeNamesInScope(scope);
while(e.hasMoreElements()) {
out.println("\t<li>" +
e.nextElement() + "</li>");
}
}
%>
</body></html>
//:~

```

This example also shows the use of both embedded HTML and writing to **out** in order to output to the resulting HTML page.

The first piece of information produced is the name of the servlet, which will probably just be "JSP" but it depends on your implementation. You can also discover the current version of the servlet container by using the application object. Finally, after setting a session attribute, the "attribute names" in a particular scope are displayed. You don't use the scopes very much in most JSP programming; they were just shown here to add interest to the example. There are four attribute scopes, as follows: The *page scope* (scope 1), the *request scope* (scope 2), the *session scope* (scope 3). Here, the only element available in session scope is "My country," added right before the **for** loop), and the *application scope* (scope 4), based upon the **Servlet Context** object.

Application Activity 11.7

1. Why could you use JSP instead of Servlets?
2. How is JSP combined with HTML?
3. Create a JSP web form with the following characteristics:
 - a. The form should contain input boxes to receive student's names and the year of study.
 - b. A command button to submit recorded information
 - c. When the "submit" button is clicked, the form will display a message as follows: Hello "**student's names**", you study in "**year of study**"

11.8 standard Tag Library (JSTL)

Activity 11.7

1. Explain how paired and unpaired tags are used?
2. Provide an example for each one of the following types of tags:
 - a. Formatting tags
 - b. Page Structure tags
 - c. Control tags

11.8.1. Introduction

The JavaServer Pages Standard Tag Library (JSTL) is a collection of useful JSP tags which encapsulates the core functionality common to many JSP applications.

JSTL has support for common, structural tasks such as iteration and conditionals, tags for manipulating XML documents, internationalization tags, and SQL tags. It also provides a framework for integrating the existing custom tags with the JSTL tags.

To use any of the libraries, you must include a <taglib> directive at the top of each JSP that uses the library.

11.8.2. Classification of the JSTL Tags

The JSTL tags can be classified, according to their functions, into the following JSTL tag library groups that can be used when creating a JSP page:

- **Core Tags**
 - **Formatting tags**
 - **SQL tags**
 - **XML tags**
 - **JSTL Functions**
- a. **Core Tags**

The core group of tags are the most commonly used JSTL tags. Following is the syntax to include the JSTL Core library in your JSP –

```
<%@ taglib prefix = "c" uri = "http://java.sun.com/jsp/jstl/core" %>
```

Following table lists out the core JSTL Tags

SN	Tag & Description
1	< c:out >: Like <%= ... >, but for expressions. It displays the result of an expression
2	< c:set >: Sets the result of an expression evaluation in a 'scope' .
3	< c:remove >: Removes a scoped variable (from a particular scope, if specified).
4	< c:catch >: Catches any Throwable that occurs in its body and optionally exposes it.
5	< c:if >: Simple conditional tag which evaluates its body if the supplied condition is true.
6	< c:choose >: Simple conditional tag that establishes a context for mutually exclusive conditional operations, marked by < when > and < otherwise >.
7	< c:when >: Subtag of < choose > that includes its body if its condition evaluates to 'true' .
8	< c:otherwise >: Subtag of < choose > that follows the < when > tags and runs only if all of the prior conditions evaluated to 'false' .
9	< c:import >: Retrieves an absolute or relative URL and exposes its contents to either the page, a String in 'var' , or a Reader in 'varReader' .
10	< c:forEach >: The basic iteration tag, accepting many different collection types and supporting subsetting and other functionality .
11	< c:forEachTokens >: Iterates over tokens, separated by the supplied delimiters.
12	< c:param >: Adds a parameter to a containing 'import' tag's URL.
13	< c:redirect >: Redirects to a new URL.
14	< c:url >: Creates a URL with optional query parameters

Below is a simple example of tag:

```
<%@ taglib uri="http://java.sun.com/jsp/jstl/core" prefix="c" %>
<html>
<head>
<title>Core Tag Example</title>
</head>
<body>
```

```

<c:forEach var="j" begin="1" end="3">
  Item <c:out value="\${j}"/><p>
</c:forEach>
</body>
</html>

```

Output

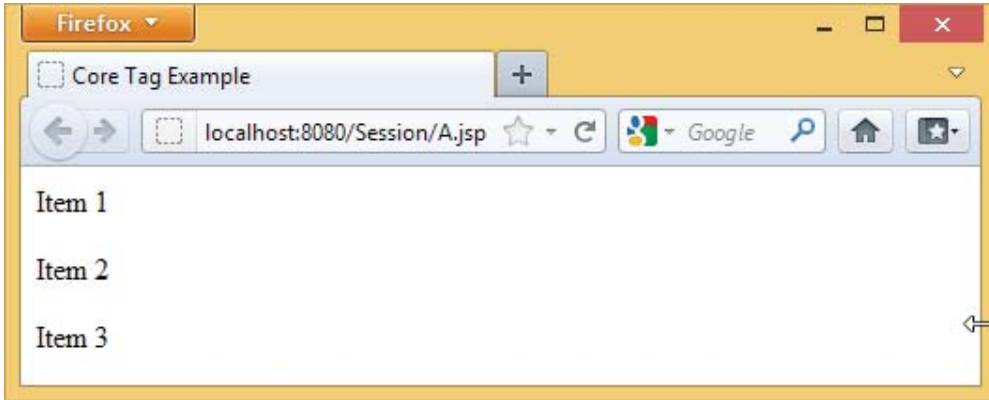

Figure 11.54: Utilisation of `c:forEach` tag

b. Formatting Tags

The JSTL formatting tags are used to format and display text, the date, the time, and numbers for internationalized Websites. Following is the syntax to include formatting library in your JSP.

```
<%@ taglib prefix = "fmt" uri = "http://java.sun.com/jsp/jstl/fmt" %>
```

Following table lists out the formatting JSTL Tags.

SN	Tag & Description
1	< fmt:formatNumber >: To render numerical value with specific precision or format.
2	< fmt:parseNumber >: Parses the string representation of a number, currency, or percentage.
3	< fmt:formatDate >: Formats a date and/or time using the supplied styles and pattern.
4	< fmt:parseDate >: Parses the string representation of a date and/or time
5	< fmt:bundle >: Loads a resource bundle to be used by its tag body.

6	< fmt:setLocale >: Stores the given locale in the locale configuration variable.
7	< fmt:setBundle >: Loads a resource bundle and stores it in the named scoped variable or the bundle configuration variable.
8	< fmt:timeZone >: Specifies the time zone for any time formatting or parsing actions nested in its body.
9	< fmt:setTimeZone >: Stores the given time zone in the time zone configuration variable
10	< fmt:message >: Displays an internationalized message.
11	< fmt:requestEncoding >: Sets the request character encoding

c. SQL Tags

The JSTL SQL tag library provides tags for interacting with relational databases (RDBMSs) such as **Oracle, MySQL, or Microsoft SQL Server**.

Following is the syntax to include JSTL SQL library in your JSP –

```
<%@ taglib prefix = "sql" uri = "http://java.sun.com/jsp/jstl/sql" %>
```

Following table lists out the SQL JSTL Tags

SN	Tag & Description
1	< sql:setDataSource >: Creates a simple DataSource suitable only for prototyping
2	< sql:query >: Executes the SQL query defined in its body or through the sql attribute.
3	< sql:update >: Executes the SQL update defined in its body or through the sql attribute.
4	< sql:param >: Sets a parameter in an SQL statement to the specified value.
5	< sql:dateParam >: Sets a parameter in an SQL statement to the specified java.util.Date value.

6	<sql:transaction > : Provides nested database action elements with a shared Connection, set up to execute all statements as one transaction.
---	---

d. XML tags

The JSTL XML tags provide a JSP-centric way of creating and manipulating the XML documents. Following is the syntax to include the JSTL XML library in your JSP.

```
<%@ taglib prefix = "x"
uri = "http://java.sun.com/jsp/jstl/xml" %>
```

Following is the list of XML JSTL Tags

SN	Tag & Description
1	<x:out> : Like <code><%= ... ></code> , but for XPath expressions.
2	<x:parse> : Used to parse the XML data specified either via an attribute or in the tag body.
3	<x:set > : Sets a variable to the value of an XPath expression.
4	<x:if > : Evaluates a test XPath expression and if it is true, it processes its body. If the test condition is false, the body is ignored.
5	<x:forEach> : To loop over nodes in an XML document.
6	<x:choose> : Simple conditional tag that establishes a context for mutually exclusive conditional operations, marked by <when> and <otherwise> tags.
7	<x:when > : Subtag of <choose> that includes its body if its expression evaluates to 'true'.
8	<x:otherwise > : Subtag of <choose> that follows the <when> tags and runs only if all of the prior conditions evaluates to 'false'.
9	<x:transform > : Applies an XSL transformation on a XML document
10	<x:param > : Used along with the transform tag to set a parameter in the XSLT stylesheet

e. JSTL Functions

JSTL includes a number of standard functions, most of which are common string manipulation functions. Following is the syntax to include JSTL Functions library in

your JSP –

```
<%@ taglib prefix = "fn"  
uri = "http://java.sun.com/jsp/jstl/functions" %>
```

Following table lists out the various JSTL Functions

SN	Function & Description
1	fn:contains(): Tests if an input string contains the specified substring.
2	fn:containsIgnoreCase(): Tests if an input string contains the specified substring in a case insensitive way.
3	fn:endsWith(): Tests if an input string ends with the specified suffix.
4	fn:escapeXml(): Escapes characters that can be interpreted as XML markup.
5	fn:indexOf(): Returns the index within a string of the first occurrence of a specified substring.
6	fn:join(): Joins all elements of an array into a string.
7	fn:length(): Returns the number of items in a collection, or the number of characters in a string.
8	fn:replace(): Returns a string resulting from replacing in an input string all occurrences with a given string.
9	fn:split(): Splits a string into an array of substrings.
10	fn:startsWith(): Tests if an input string starts with the specified prefix.
11	fn:substring(): Returns a subset of a string.
12	fn:substringAfter(): Returns a subset of a string following a specific substring.
13	fn:substringBefore(): Returns a subset of a string before a specific substring.
14	fn:toLowerCase(): Converts all of the characters of a string to lower case.
15	fn:toUpperCase(): Converts all of the characters of a string to upper case.
16	fn:trim(): Removes white spaces from both ends of a string.

Application Activity 11.7

Identify and explain different tags found in the codes below:

```
<%@ page language="java" contentType="text/html; charset=US-ASCII"
    pageEncoding="US-ASCII"%>
<!DOCTYPE html PUBLIC "-//W3C//DTD HTML 4.01 Transitional//EN" "http://www.w3.org/TR/
html4/loose.dtd">
<html>
<head>
<meta http-equiv="Content-Type" content="text/html; charset=US-ASCII">
<title>Home Page</title>
<%@ taglib uri="http://java.sun.com/jsp/jstl/core" prefix="c" %>
<style>
table,th,td
{
border:1px solid black;
}
</style>
</head>
<body>
<%-- Using JSTL forEach and out to loop a list and display items in table --%>
<table>
<tbody>
<tr><th>ID</th><th>Name</th><th>Role</th></tr>
<c:forEach items="${requestScope.empList}" var="emp">
<tr><td><c:out value="${emp.id}"></c:out></td>
<td><c:out value="${emp.name}"></c:out></td>
<td><c:out value="${emp.role}"></c:out></td></tr>
</c:forEach>
</tbody>
</table>
<br><br>
```

```

<%-- simple c:if and c:out example with HTML escaping --%>
<c:if test="{requestScope.htmlTagData ne null}">
<c:out value="{requestScope.htmlTagData}" escapeXml="true"></c:out>
</c:if>
<br><br>
<%-- c:set example to set variable value --%>
<c:set var="id" value="5" scope="request"></c:set>
<c:out value="{requestScope.id}" ></c:out>
<br><br>
<%-- c:catch example --%>
<c:catch var="exception">
<% int x = 5/0;%>
</c:catch>
<c:if test="{exception ne null}">
<p>Exception is : {exception} <br>
Exception Message: {exception.message}</p>
</c:if>
<br><br>
<%-- c:url example --%>
<a href="{c:url value="{requestScope.url}"></c:url}">JournalDev</a>
</body>
</html>

```

11.9 Java Database Connectivity (JDBC) connection

Activity 11.7

1. Illustrate how websites communicate with databases?
2. What are the benefits of having a website which is connected to a database?

JDBC is a standard Java application programming interfaces (APIs) for database-independent connectivity between the Java programming language and a wide range of databases.

The JDBC library includes APIs for each of the tasks mentioned below that are commonly associated with database usage.

- Making a connection to a database.
- Creating SQL or MySQL statements.
- Executing SQL or MySQL queries in the database.
- Viewing & Modifying the resulting records.

Fundamentally, JDBC is a specification that provides a complete set of interfaces that allows for portable access to an underlying database.

11.9.1. Common JDBC Components

The JDBC API provides the following interfaces and classes:

- **Driver Manager:** This class manages a list of database drivers. Matches connection requests from the java application with the proper database driver using communication sub protocol. The first driver that recognizes a certain subprotocol under JDBC will be used to establish a database Connection.
- **Driver:** This interface handles the communications with the database server. You will interact directly with Driver objects very rarely. Instead, you use DriverManager objects, which manages objects of this type. It also abstracts the details associated with working with Driver objects.
- **Connection:** This interface with all methods for contacting a database. The connection object represents communication context, i.e., all communication with database is through connection object only.
- **Statement:** You use objects created from this interface to submit the SQL statements to the database. Some derived interfaces accept parameters in addition to executing stored procedures.
- **ResultSet:** These objects hold data retrieved from a database after you execute an SQL query using Statement objects. It acts as an iterator to allow you to move through its data.
- **SQLException:** This class handles any errors that occur in a database application.

11.9.2. Load Driver

1. Download MySQL Connector/J, name 'mysql-connector-java-5.1.46.zip' from the Official Site at <https://dev.mysql.com/downloads/connector/j> Extract the zip file to a folder, you will see file 'mysql-connector-java-5.1.46-bin.jar' which is the library file that we want. Just copy the file to the library folder, for example to "C:\Program Files\Java\jdk1.6.0_02\lib" directory.
2. Start Netbeans and create a new project (File->New Project; a window

will appear. Select Java from the Categories list and Java Application from the Projects list. Click Next. In the New Java Application window, enter the name and location of the project.)

3. Add JDBC Driver to the “First” project on NetBeans (Add a library).
 - a. In Projects window, right click the project name and select Properties.

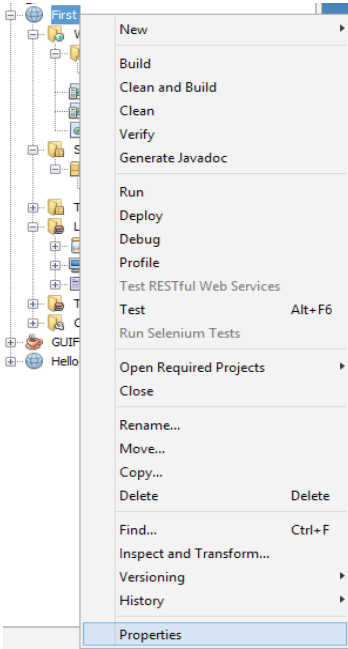

Figure 11.225: Project properties

- b. Project Properties window appears. The Categories on left side, select Libraries. And on right side in Compile tab, click Add JAR/Folder.

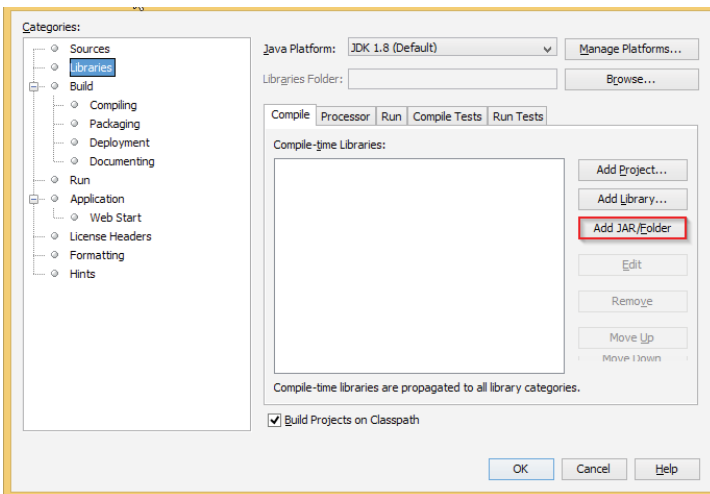

Figure 11.56: Adding project libraries

- c. New Window appears, browse to the file 'mysql-connector-java-5.0.6-bin.jar' and click Open.

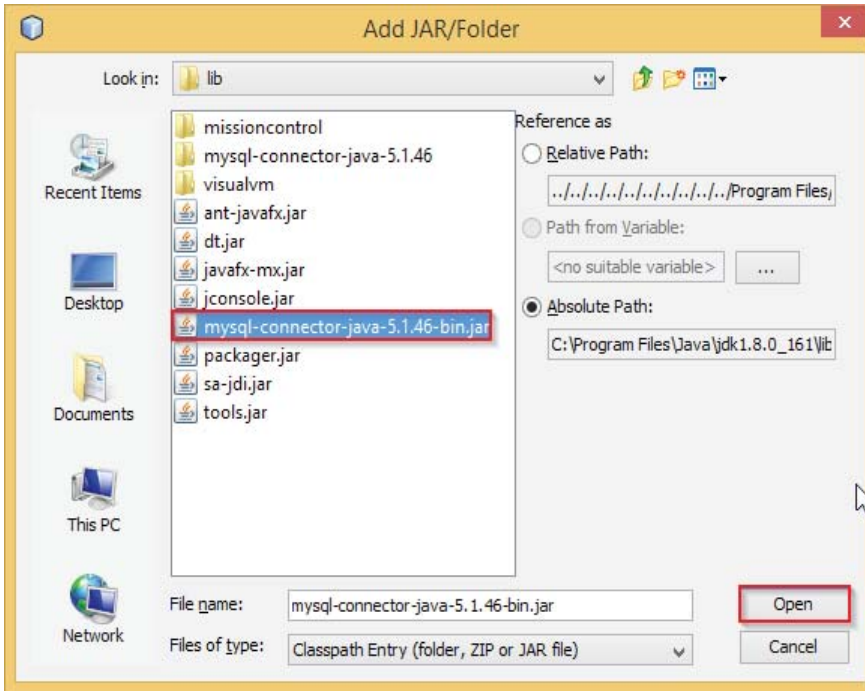

Figure 11.57: Defining path to MySQL connector

- d. You will see the .jar file was added to the project. Click OK to finish.

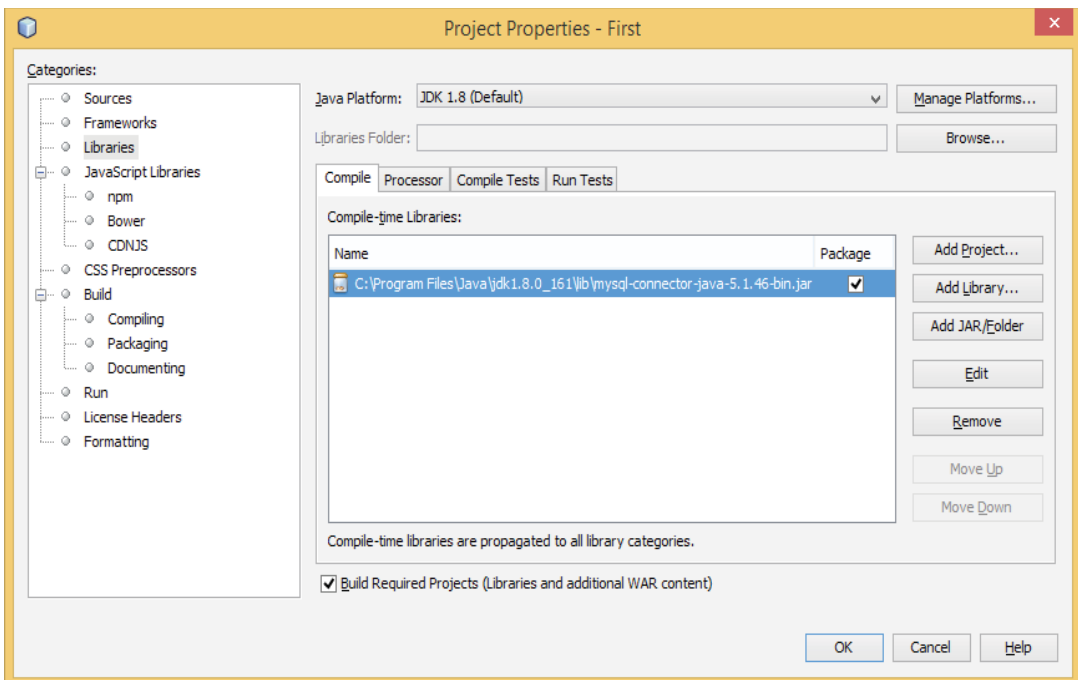

Figure 11. 23: Project libraries

Note: You should keep `mysql-connector-java-5.1.46-bin.jar` in the directory that you won't delete it (ex. not in temp folder). May be in the same directory that keep common library files. If you delete the file without delete a link from the project, the project will show error about missing library.

11.9.3. Connecting to the database

Supposing we have a table named `books` in a MySQL database called **ebooks** with the following fields:

#	Column	Type
1	<u>id</u>	int(11)
2	title	varchar(50)
3	author	varchar(50)
4	price	float
5	qty	int(11)

Figure 11. 24: Table properties

Insert some sample records:

id	title	author	price	qty
1001	Java for beginners	UMUHOZA	12500	11
1002	Advanced Java Programming	MUHIRE	15000	22
1003	More Java for Beginners	NYIRANEZA	18000	33
1004	Java Web Application	RUKUNDO	15550.5	55
1005	JDBC	KAMANA	13500	66

Figure 11. 25: Sample data in table

a. Writing code to connect to the database

Use the `<sql:setDataSource>` tag to create a data source to our database like this:

```
1 <sql:setDataSource
2   var="myDB"
3   driver="com.mysql.jdbc.Driver"
4   url="jdbc:mysql://localhost:3306/ebooks"
5   user="root"password="secret"
6 />
```

Remember to change the **user** and **password** attributes according to your MySQL settings. Note that the data source is assigned to a variable called **myDB** for reference later.

b. Writing code to query the records

Use the **<sql:query>** tag to create a query to the database as follows:

```
1 <sql:queryvar="list_users"dataSource="{myDB}">
2   SELECT * FROM books;
3 </sql:query>
```

Note that the **dataSource** attribute refers to the data source **myDB** created in the previous step, and result of this query is assigned to a variable called **listUsers** for reference later.

c. Writing code to display the records

Use the **<c:forEach>** tag to iterate over the records returned by the **<sql:query>** tag. And for each record, use the **<c:out>** tag to print value of a column in the table, like this:

```
1 <c:forEach var="books" items="{books.rows}">
2   <td><c:out value="{books.id}" /></td>
3   <td><c:out value="{books.title}" /></td>
4   <td><c:out value="{books.author}" /></td>
5   <td><c:out value="{books.price}" /></td>
6   <td><c:out value="{books.qty}" /></td>
7 </c:forEach>
```

Note that the **items** attribute of the `<c:forEach>` tag refers to the **listUsers** variable assigned by the `<sql:query>` tag.

d. The complete JSP code

Now we wire the above pieces together to form a complete JSP page with taglib directives to import JSTL tags and HTML code to display the books list in tabular format. Code of the complete JSP page is as follows (**books.jsp**):

```
<%@ taglib uri="http://java.sun.com/jsp/jstl/core" prefix="c" %>
<%@ taglib uri="http://java.sun.com/jsp/jstl/sql" prefix="sql" %>
<%@page contentType="text/html" pageEncoding="UTF-8"%>
<!DOCTYPE html>
<html>
<head>
<meta http-equiv="Content-Type" content="text/html; charset=UTF-8">
<title>JSP List books</title>
</head>
<body>
<sql:setDataSource
    var="myDB"
    driver="com.mysql.jdbc.Driver"
    url="jdbc:mysql://localhost:3306/ebooks"
    user="root" password=""
/>
<sql:query var="books" dataSource="{myDB}">
    SELECT * FROM books;
</sql:query>
<div align="center">
<table border="1" cellpadding="5">
<caption><h2>List of books</h2></caption>
<tr>
<th>ID</th>
<th>Title</th>
<th>Author</th>
<th>Price</th>
```

```

<th>Quantity</th>
</tr>
<c:forEach var="books" items="\${books.rows}">
<tr>
<td><c:out value="\${books.id}" /></td>
<td><c:out value="\${books.title}" /></td>
<td><c:out value="\${books.author}" /></td>
<td><c:out value="\${books.price}" /></td>
<td><c:out value="\${books.qty}" /></td>
</tr>
</c:forEach>
</table>
</div>
</body>
</html>

```

e. Testing the application

Supposing we put the **books.jsp** file inside the web application called **First** on localhost Tomcat, type the following URL to run the list books JSP page:

<http://localhost:8080/First/books.jsp>

The following page should appear:

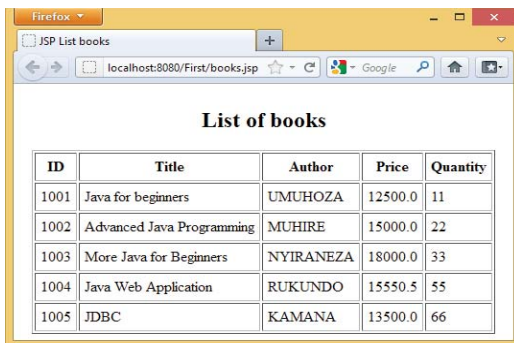

ID	Title	Author	Price	Quantity
1001	Java for beginners	UMUHOZA	12500.0	11
1002	Advanced Java Programming	MUHIRE	15000.0	22
1003	More Java for Beginners	NYIRANEZA	18000.0	33
1004	Java Web Application	RUKUNDO	15550.5	55
1005	JDBC	KAMANA	13500.0	66

Figure 11. 26: Displaying data in a JSP form

11.9.4. Inserting data into tables

We need 2 files to insert a new book record in the books table created in the previous section in MySQL:

- index.html: for getting the values from the user
- addbooks.jsp: A JSP file that process the request

Codes for index.html are as follows:

```
<!DOCTYPE html>
<html>
<body>
<form method="post" action="addbook.jsp">
ID:
<input type="text" name="id">
<br><br>
Title:
<input type="text" name="title">
<br><br>
Author:
<input type="text" name="author">
<br><br>
Price: <input type="text" name="price">
<br><br>
Quantity:
<input type="text" name="qty">
<br><br>
<input type="submit" value="submit">
</form>
</body>
</html>
```

Codes for addbooks.jsp are as follows:

```
<%@ page language="java" contentType="text/html; charset=ISO-8859-1"
pageEncoding="ISO-8859-1"%>
<%@page import="java.sql.*,java.util.*"%>
<%@ taglib uri="http://java.sun.com/jsp/jstl/core" prefix="c" %>
<%@ taglib uri="http://java.sun.com/jsp/jstl/sql" prefix="sql" %>
<%
String id=request.getParameter("id");
String title=request.getParameter("title");
String author=request.getParameter("author");
String price=request.getParameter("price");
```



```

String qty=request.getParameter("qty");
try
{
Class.forName("com.mysql.jdbc.Driver");
Connection conn = DriverManager.getConnection("jdbc:mysql://localhost:3306/ebooks", "root",
""");
Statement st=conn.createStatement();
int      i=st.executeUpdate("insert      into      books(id,title,author,price,      qty)
values('"+id+"','"+title+"','"+author+"','"+price+"','"+qty+"')");
out.println("Data is successfully inserted!");
}
catch(Exception e)
{
System.out.print(e);
e.printStackTrace();
}
%>

```

Output:

The screenshot shows a web browser window with the address bar displaying `http://localhost:8080/First/index1.html`. The page content includes a form with the following fields and values:

- ID: 1008
- Title: Communication Technology
- Author: Fountain Publishers
- Price: 12000
- Quantity: 12

A "submit" button is located at the bottom left of the form area.

Figure 11. 27: Adding a new record

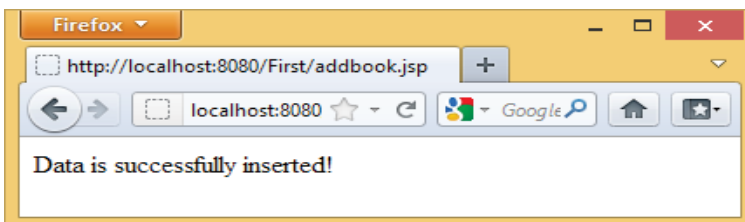

Figure 11. 28: New record successfully added

	id	title	author	price	qty
	1001	Java for beginners	UMUHOZA	12500	11
	1002	Advanced Java Programming	MUHIRE	15000	22
	1003	More Java for Beginners	NYIRANEZA	18000	33
	1004	Java Web Application		15550.5	55
	1005	JDBC		13500	66
	1006	Visual basic	Peter	23	21
	1007	Computer Science	Herman Oduor	120	1
	1008	Information and Communication Technology	Fountain Publishers	12000	12

The book is saved in the database

Figure 11. 29: New record within the database

11.9.5. Updating tables

To update data into books table created in the previous section, we need 3 files:

- **index.jsp:** To retrieve data from database with an update option.
- **update.jsp:** Show the book data as per the selected id of book (Suppose you select book id 1001, then it show only the information of id 1001).
- **update-process.jsp:** Process the user data after edit.

index.jsp:

```

<%@page contentType="text/html" pageEncoding="UTF-8"%>
<!DOCTYPE html>
<%@ page import="java.sql.*" %>
<%@ page import="java.io.*" %>
<%@page import="java.sql.DriverManager"%>
<%@page import="java.sql.ResultSet"%>
<%@page import="java.sql.Statement"%>
<%@page import="java.sql.Connection"%>
<%
String id = request.getParameter("id");
String driver = "com.mysql.jdbc.Driver";
String connectionUrl = "jdbc:mysql://localhost:3306/";
String database = "ebooks";
String userid = "root";
String password = "";
try {
Class.forName(driver);
} catch (ClassNotFoundException e) {
e.printStackTrace();

```

```

}
Connection connection = null;
Statement statement = null;
ResultSet resultSet = null;
%>
<html>
<body>
<h1>Retrieve data from database in jsp</h1>
<table border="1">
<tr>
<td>id</td>
<td>Title</td>
<td>Author</td>
<td>Price</td>
<td>Quantity</td>
<td>update</td>
</tr>
<%
try{
connection = DriverManager.getConnection(connectionUrl+database, userid, password);
statement=connection.createStatement();
String sql = "select * from books";
resultSet = statement.executeQuery(sql);
while(resultSet.next()){
%>
<tr>
<td><%=resultSet.getString("id") %></td>
<td><%=resultSet.getString("title") %></td>
<td><%=resultSet.getString("author") %></td>
<td><%=resultSet.getString("price") %></td>
<td><%=resultSet.getString("qty") %></td>
<td><a href="update.jsp?id=<%=resultSet.getString("id")%>">update</a></td>
</tr>
<%

```

```

}
connection.close();
} catch (Exception e) {
e.printStackTrace();
}
%>
</table>
</body>
</html>

```

Output:

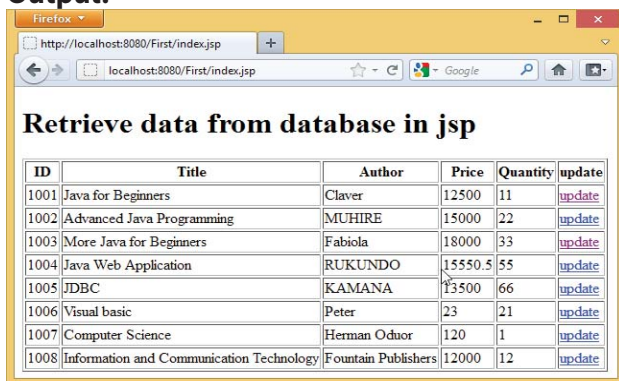

Figure 11. 30: Index page with the option for update

update.jsp:

```

<%@page contentType="text/html" pageEncoding="UTF-8"%>
<!DOCTYPE html>
<%@page import="java.sql.DriverManager"%>
<%@page import="java.sql.ResultSet"%>
<%@page import="java.sql.Statement"%>
<%@page import="java.sql.Connection"%>
<%
String id = request.getParameter("id");
String driver = "com.mysql.jdbc.Driver";
String connectionUrl = "jdbc:mysql://localhost:3306/";
String database = "ebooks";
String userid = "root";
String password = "";

```

```

try {
Class.forName(driver);
} catch (ClassNotFoundException e) {
e.printStackTrace();
}
Connection connection = null;
Statement statement = null;
ResultSet resultSet = null;
%>
<%
try{
connection = DriverManager.getConnection(connectionUrl+database, userid, password);
statement=connection.createStatement();
String sql ="select * from books where id="+id;
resultSet = statement.executeQuery(sql);
while(resultSet.next()){
%>
<!DOCTYPE html>
<html>
<body>
<h1>Update data from database in jsp</h1>
<form method="post" action="update-process.jsp">
<input type="hidden" name="id" value="<%=resultSet.getString("id") %>">
<input type="text" name="id" value="<%=resultSet.getString("id") %>">
<br>
ID:<br>
<input type="text" name="id" value="<%=resultSet.getString("id") %>">
<br>
Title:<br>
<input type="text" name="title" value="<%=resultSet.getString("title") %>">
<br>
Author:<br>
<input type="text" name="author" value="<%=resultSet.getString("author") %>">
<br>

```

```

Price:<br>
<input type="text" name="price" value="<%=resultSet.getString("price") %>">
<br>
Quantity:<br>
<input type="text" name="qty" value="<%=resultSet.getString("qty") %>">
<br><br>
<input type="submit" value="Update">
</form>
<%
}
connection.close();
} catch (Exception e) {
e.printStackTrace();
}
%>
</body>
</html>

```

Output:

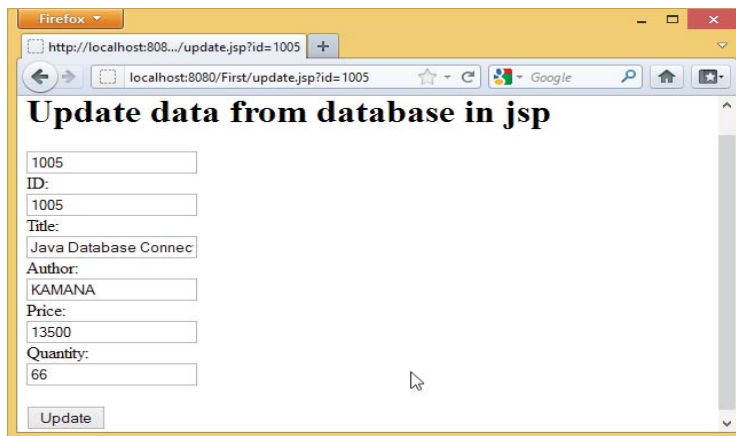

Figure 11. 31: Making changes to an existing record

update-process.jsp

```

<%@page contentType="text/html" pageEncoding="UTF-8"%>
<!DOCTYPE html>
<%@ page import="java.sql.*" %>
<%! String driverName = "com.mysql.jdbc.Driver";%>
<%!String url = "jdbc:mysql://localhost:3306/ebooks";%>

```

```

<%!String user = "root";%>
<%!String psw = "";%>
<%
String id = request.getParameter("id");
String title=request.getParameter("title");
String author=request.getParameter("author");
String price=request.getParameter("price");
String qty=request.getParameter("qty");
if(id != null)
{
Connection con = null;
PreparedStatement ps = null;
int personID = Integer.parseInt(id);
try
{
Class.forName(driverName);
con = DriverManager.getConnection(url,user,psw);
String sql="Update books set id=?,title=?,author=?,price=?,qty=? where id="+id;
ps = con.prepareStatement(sql);
ps.setString(1,id);
ps.setString(2, title);
ps.setString(3, author);
ps.setString(4, price);
ps.setString(5, qty);
int i = ps.executeUpdate();
if(i > 0)
{
out.print("Record Updated Successfully");
}
else
{
out.print("There is a problem in updating Record.");
}
}
}

```

```

}
catch(SQLException sql)
{
request.setAttribute("error", sql);
out.println(sql);
}}
%>

```

Output:

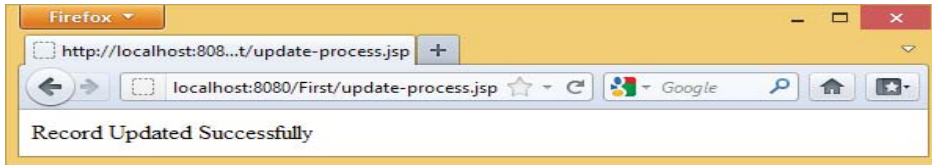

Figure 11. 32: Successful update confirmation message

After update the data the table look like this.

	id	title	author	price	qty
<input type="checkbox"/> Edit <input type="checkbox"/> Inline Edit <input type="checkbox"/> Copy <input type="checkbox"/> Delete	1001	Java for Beginners	Claver	12500	11
<input type="checkbox"/> Edit <input type="checkbox"/> Inline Edit <input type="checkbox"/> Copy <input type="checkbox"/> Delete	1002	Advanced Java Programming	MUHIRE	15000	22
<input type="checkbox"/> Edit <input type="checkbox"/> Inline Edit <input type="checkbox"/> Copy <input type="checkbox"/> Delete	1003	More Java for B		18000	33
<input type="checkbox"/> Edit <input type="checkbox"/> Inline Edit <input type="checkbox"/> Copy <input type="checkbox"/> Delete	1004	Java Web Application	RUKUNDO	15550.5	55
<input type="checkbox"/> Edit <input type="checkbox"/> Inline Edit <input type="checkbox"/> Copy <input type="checkbox"/> Delete	1005	Java Database Connection	KAMANA	13500	66
<input type="checkbox"/> Edit <input type="checkbox"/> Inline Edit <input type="checkbox"/> Copy <input type="checkbox"/> Delete	1006	Visual basic	Peter	23	21
<input type="checkbox"/> Edit <input type="checkbox"/> Inline Edit <input type="checkbox"/> Copy <input type="checkbox"/> Delete	1007	Computer Science	Herman Oduor	120	1
<input type="checkbox"/> Edit <input type="checkbox"/> Inline Edit <input type="checkbox"/> Copy <input type="checkbox"/> Delete	1008	Information and Communication Technology	Fountain Publishers	12000	12

Figure 11. 33: Updated title within the table

Application Activity 11.9

Develop a web application that connects to a database. You could use MySQL database. The program could collect data from the user (via a form) and store it in a database table.

End unit assessment

1. How can you change the connector port while configuring Apache Tomcat?
2. How does the servlet container interact with java servlet?
3. How could you access and run Tomcat Servlet and JSP examples?
4. Develop a web application so that it stores information in a session variable. Use the session variable in the JSP output page.



UNIT 12

INTRODUCTION TO COMPUTER GRAPHICS

Unit 12. INTRODUCTION TO COMPUTER GRAPHICS

Introductory Activity

Observe the picture below and answer the following questions:

1. Describe what you see.
2. Describe how the pictures inside are arranged. Are these pictures created using the same material?
3. How can you measure the size of each picture?
4. Is it easy to modify these pictures? Explain.
5. Explain the areas where pictures are used.
6. Why is it important to have good pictures in business advertisement?
7. Nowadays, youth like posting their nakedness pictures on social media. Discuss the inconvenience.

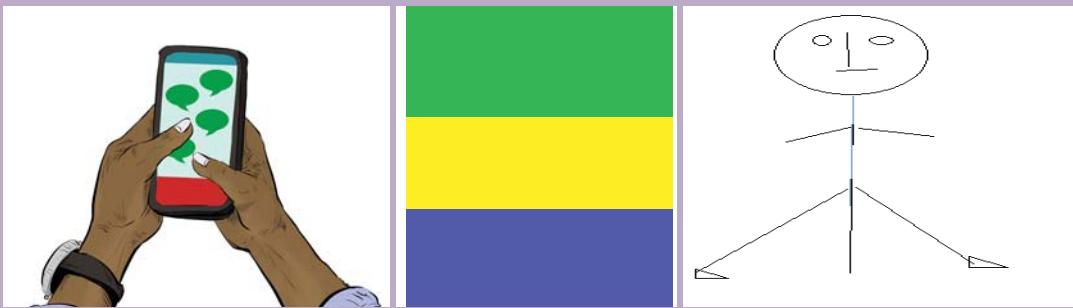

Figure 12.1. variety of pictures

12.1 Definition of Computer graphics terms

Activity 12.1

By using different mobile phones, take pictures of the same group of students in your classroom. After saving those pictures in one folder and observing carefully, give the difference between them. Explain what could be the cause of that difference.

12.1.1 Introduction

The human perception of the world is done through the five senses among which the view is very important. Our brain recognizes the faces of people and the shapes of things because they retain their pictures.

Currently, the use of computers has helped to digitalise the images and the work of drawing became easier than before. Consequently, a new area of application of computer science called computer graphics was born and hence pictures and images are used in different areas of the human life for its development. Computer Graphics involves the ways in which images can be displayed, manipulated and stored using a computer. Computer graphics provides the software and hardware techniques or methods for generating images.

12.1.2. Definition of different terms

Computer graphics can be defined in two ways depending on the circumstances:

Computer Graphics is an art of drawing pictures, lines, charts, etc, using computers with the help of programming. Computer graphics are made up of number of pixels. A pixel is the smallest graphical picture or unit represented on the computer screen.

or

Computer graphics are pictures and films created by using computers. Usually, the term refers to computer-generated image data created with help from specialized graphical hardware and software.

Computer graphics can be classified into two categories: **Raster** or **Bitmap** graphics and **Vector** or **Object-oriented** graphics.

1. Raster (Bitmap) Graphics

These are pixel based graphics and the pixels can be modified individually.

- The images are easy to edit in memory and display on TV monitors owing to the arrangement of the pixels in a rectangular array.
- The image size is determined on the basis of image resolution.
- These images cannot be scaled easily; resizing do not work very well and can significantly distort the image.
- Bitmap graphics are used for general purpose images and in particular photographs.

2. Vector (Object-oriented) Graphics

These graphics are mathematically based images.

- Vector based images have smooth edges and therefore used to store images composed of lines, circles and polygons.
 - These images can easily be re-scaled and rotated.
 - They can not easily accommodate complex images such as photographs where colour information varies from pixel to pixel.
 - Vector graphics are well suited for graphs, e.g. in spreadsheets and for scalable fonts, e.g. postscript fonts
3. A **model of an object** is a physical representation that shows what it looks like or how it works. The model is often smaller than the object it represents
 4. The computer **resolution** is the number of pixels (individual points of color) contained on a display monitor, expressed in terms of the number of pixels on the horizontal axis and the number on the vertical axis.
 5. A pixel is the smallest element of a picture that can be represented on the screen of a device like a computer. Pixels per inch (PPI) or pixels per centimeter (PPCM) are measurements of the **pixel density** (resolution) of an electronic image device, such as a computer monitor or television **display**, or image digitizing device such as a camera or image scanner.
 6. **2D (2Dimensional)** images are objects that are rendered visually on paper, film or on screen in two planes representing width and height (X and Y). Two-dimensional structures are also used in the construction of 3D objects.



Figure 12.2 2D image

7. **3D** computer graphics or three-dimensional computer graphics, (in contrast to 2D computer graphics) are graphics that use a three-dimensional representation of geometric data (often Cartesian) that is stored in the computer for the purposes of performing calculations and rendering 2D image.



Figure 12.3 3D image

8. A color scheme is the choice of colors used in design for a range of media. For example, the use of a white background with black text is an example of a basic and commonly default color scheme in writing.
9. 8-bit color graphics is a method of storing image information in a computer's memory or in an image file, such that each pixel is represented by one (8-bit) byte. The maximum number of colors that can be displayed at any one time is $2^8=256$.
10. 16-bit color graphics also called High color is a method of storing image information in a computer's memory or in an image file where computer and monitors can display as many as $2^{16}=65,536$ colors, which is adequate for most uses. Each pixel is represented by two bytes i.e 16 bits, but some devices also support 15-bit high color. However, graphic intensive video games and higher resolution video can benefit from and take advantage of the higher color depths.
11. **32-bit color graphics** is a method of storing image information in a computer's memory or in an image file where computer and monitors can display as many as $2^{32}=4,294,967,296$ colors, which is adequate for most uses. Each pixel is represented by four (4) bytes i.e 32 bits.

a. Image compression

Image compression is minimizing the size in bytes of a graphic file without degrading the quality of the image to an unacceptable level. The reduction in file size allows more images to be stored in a given amount of disk or memory space. It also reduces the time required for images to be sent over the Internet or downloaded from web pages. Know an image's file size and dimensions before or after uploading it into the Library

b. Determination of an image's file size and dimensions

The determination of an image's file size and dimensions differs according to the Operating System being used.

On MS Windows computers, Open the image in Windows Explorer to check dimensions and file size by clicking the Windows Start button on the taskbar. After opening the folder containing the image, right clicking the icon of the image file, and in the pop up menu, click on property and details. The result will look like below. The wanted information are circled with red line.

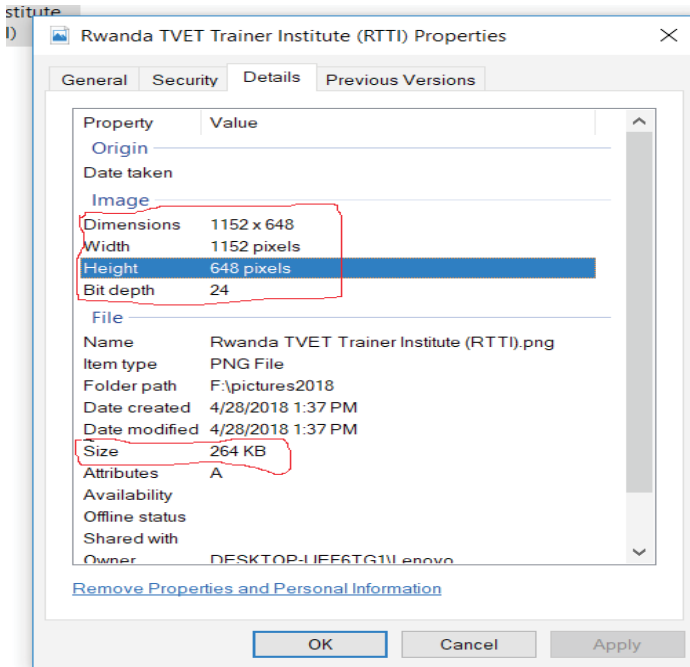

Figure 12.4 image size interface

c. Calculating size of an uncompressed image file

A byte is a unit of storage in computing, and unfortunately, a byte isn't big enough to hold a pixel's worth of information. It actually takes 2 to 3 bytes to store one pixel of a color image.

So the pixels in the image store a color at a given point in the image, but it takes 2 to 3 bytes of storage to record this value. If we consider 3 bytes of storage, the file size of a color image is: $\text{width} * \text{height} * 3 = 36,636,672$ which gives us the file size in bytes.

But this is a big number, so we want to convert it to megabytes. There are 1,024 bytes in a kilobyte. There are 1,024 kilobytes in a megabyte. So the file size of a color image in megabytes is: $\text{width} * \text{height} * 3 / (1024 * 1024) = 34.9\text{MB}$

d. Graphics file format/image file format:

Image file formats are standardized means of organizing and storing digital images. Image files are composed of digital data in one of the formats that can be rasterized for use on a computer display or printer. An image file format may store data in uncompressed, compressed, or vector formats. Once rasterized, an image becomes a grid of pixels, each of which has a number of bits to designate its color equal to the color depth of the device displaying it.

There are 5 main formats in which to store images including TIFF, JPEG, GIF, PNG and **Raw image files**. Their differences are given in the table below:

Standardized graphic file formats	Features
TIFF	<p>TIFF stands for Tagged Image File Format. TIFF images create very large file sizes. TIFF images are uncompressed and thus contain a lot of detailed image data (which is why the files are so big) TIFFs are also extremely flexible in terms of color (they can be grayscale, or CMYK for print, or RGB for web) and content (layers, image tags).</p> <p>TIFF is the most common file type used in photo software (such as Photoshop), as well as page layout software (such as Quark and InDesign), again because a TIFF contains a lot of image data.</p>
JPEG	<p>JPEG stands for Joint Photographic Experts Group, which created this standard for this type of image formatting. JPEG files are images that have been compressed to store a lot of information in a small-size file. Most digital cameras store photos in JPEG format, because then you can take more photos on one camera card than you can with other formats.</p> <p>JPEG files are bad for line drawings or logos or graphics, as the compression makes them look "bitmappy" (jagged lines instead of straight ones).</p>

GIF	GIF stands for Graphic Interchange Format. This format compresses images but, as different from JPEG, the compression is lossless (no detail is lost in the compression, but the file can't be made as small as a JPEG).
PNG	PNG stands for Portable Network Graphics. It was created as an open format to replace GIF, because the patent for GIF was owned by one company and nobody else wanted to pay licensing fees. It also allows for a full range of color and better compression.
Raw image files	<p>Raw image files contain data from a digital camera (usually). The files are called raw because they haven't been processed and therefore can't be edited or printed yet. There are a lot of different raw formats—each camera company often has its own proprietary format.</p> <p>Raw files usually contain a vast amount of data that is uncompressed. Because of this, the size of a raw file is extremely large. Usually they are converted to TIFF before editing and color-correcting.</p>

Application Activity 12.1.

1. Define an image.
2. Define vector graphics and raster graphics.
3. Define a pixel.
4. What is computer resolution?
5. How an image size is calculated?
6. Briefly describe two basic types of Graphics file formats.
7. List two categories of images in computer graphics.
8. In which graphic system are images easily scalable?
9. By using image taken with your camera or retrieved in your computer, determine its size.

12.2 Images capturing tools

Activity 12.2

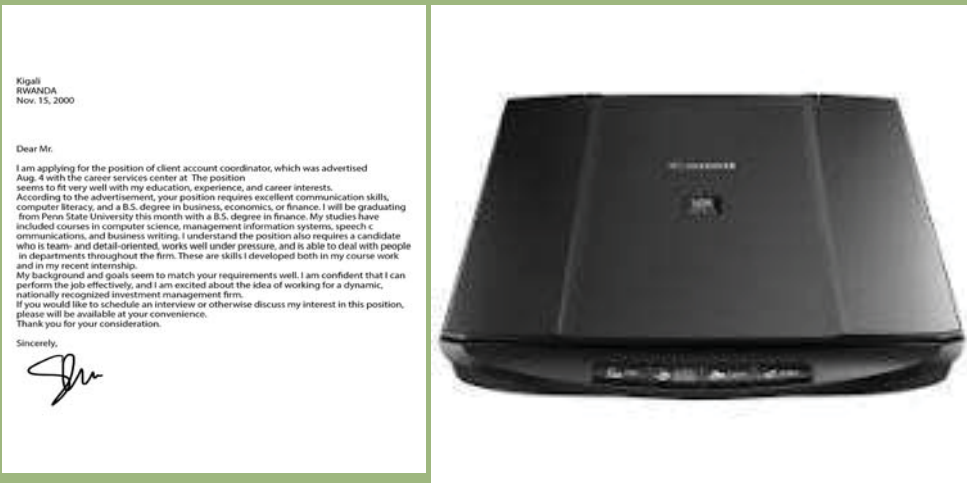

12.6 Figure Picture taking tools

Source: <https://www.debenhamsplus.com>

Source: http://tclp-lagny.net/?attachment_id=941

1. Describe what you see
2. What are the roles of the above devices?
3. Which device is most useful in our days in photo capturing? Why?
4. Describe the functioning of each device and describe the parts of each

12.2.1 Digital camera

a. Definition

A digital camera is a camera which produces digital images that can be stored in a computer and displayed on screen. It records and stores photographic images in digital format.

These stored images can be uploaded to a computer immediately or stored in the camera to be uploaded into a computer or printer later.

Digital cameras use an image sensor instead of photographic film.

2. Digital camera parts

There are 10 basic camera parts to identify in today's digital world. These parts will inevitably be found on most cameras being digital compact or single-lens reflex camera (SLR)

- **Lens**

The lens is one of the most vital parts of a camera. The light enters through the lens, and this is where the photo process begins. Lenses can be either fixed permanently to the body or interchangeable. They can also vary in focal length, aperture, and other details.

- **Viewfinder**

The viewfinder can be found on all digital single-lens reflex cameras (DSLR) and some models of digital compacts. On DSLRs, it will be the main visual source for image-taking, but many of today's digital compacts have replaced the typical viewfinder with Liquid Crystal Display (LCD) screen.

- **Body**

The body is the main portion of the camera, and bodies can be a number of different shapes and sizes. DSLRs tend to be larger bodied and a bit heavier, while there are other consumer cameras that are a conveniently smaller size and even able to fit into a pocket.

- **Shutter Release**

The shutter release button is the mechanism that "releases" the shutter and therefore enables the ability to capture the image. The length of time the shutter is left open

or “exposed” is determined by the shutter speed.

- **Aperture**

The aperture affects the image’s exposure by changing the diameter of the lens opening, which controls the amount of light reaching the image sensor. Some digital compacts will have a fixed aperture lens, but most of today’s compact cameras have at least a small aperture range.

- **Image Sensor**

The image sensor converts the optical image to an electronic signal, which is then sent to the memory card. There are two main types of image sensors that are used in most digital cameras: complementary metal-oxide-semi conductor (CMOS) and charge-coupled device (CCD) Both forms of the sensor accomplish the same task, but each has a different method of performance.

- **Memory Card**

The memory card stores all of the image information, and they range in size and speed capacity.

- **LCD Screen**

The LCD screen is found on the back of the body and can vary in size. On digital compact cameras, the LCD has typically begun to replace the viewfinder completely. On DSLRs, the LCD is mainly for viewing photos after shooting, but some cameras do have a “live mode” as well.

- **Flash**

The on-board flash will be available on all cameras except some professional grade DSLRs. It can sometimes be useful to provide a bit of extra light during dim, low light situations.

- **User Controls**

The controls on each camera will vary depending on the model and type. The basic digital compacts may only have auto settings that can be used for different environments, while a DSLR will have numerous controls for auto and manual shooting along with custom settings.

Those parts can be seen on the following picture.



Figure 12.7 digital camera and its parts

Source: <https://airfreshener.club/quotes/parts-of-a-camera-worksheet.html>

c. Importing pictures using USB cable

The images taken by using a camera are stored automatically in its memory. However, for different purposes, the images can be printed or inserted in documents for illustrations. The camera is then connected to the printer or the computer by using a USB cable appropriately designed for such action. The fact of taking pictures from the camera to the computer is called importing pictures.

The following steps are followed to successfully import a picture from camera to computer by using a USB cable.

Step1

Connect one end of the USB cable to the port in your camera.

Step2

Connect the other end of the USB cable to the USB port in the computer. This may be in the front or back of the computer.

Step3

Turn on the camera

Step4

A dialog box may appear on the screen. If it does, select “View Files” or “Open Folder.” If the dialog does not appear, click the Windows “Start” menu, select “Computer” and then choose the drive labeled for the connected camera.

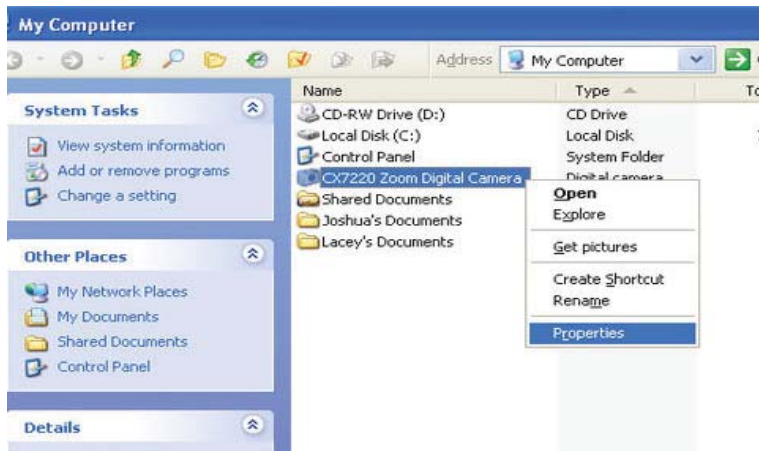

Figure 12.11 Dialog box of different folders

Step5

The pictures are probably located in a particular photo folder on the camera. Open that folder. Drag individual photos from the folder to the desktop or some other folder on the computer. All the photos can be selected by pressing “Ctrl-A” and then pasted into a folder on the computer by pressing “Ctrl-V.”

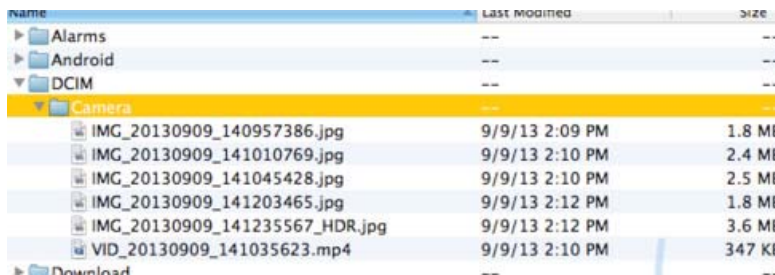

Figure 12.12 Many photo on folder of camera

12.2.2 Scanner

a. Definition

A scanner is an electronic device which can capture images from physical items (printed text, handwriting, photographic prints, posters, magazine pages, and similar sources) and convert them into digital formats, which in turn can be stored in a computer, and viewed or modified using software applications.

Very high resolution scanners are used for scanning for high-resolution printing, but lower resolution scanners are adequate for capturing images for computer display.

b. The different parts of scanner

A scanner has the following five (5) parts visible externally:

- (1) Start button,
- (2) Copy button,
- (3) Scan to E-mail button,
- (4) Scan to Web button,
- (5) Scanner cover

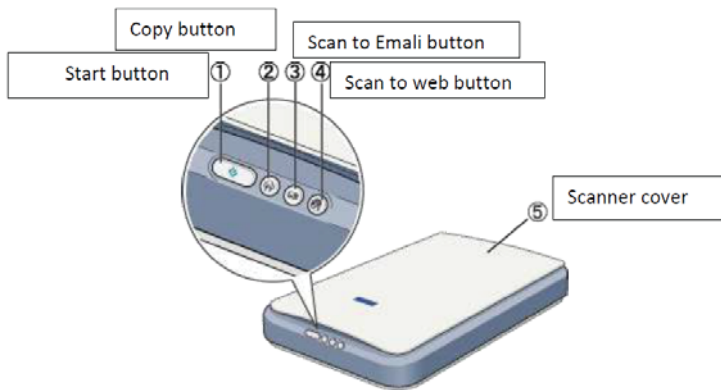
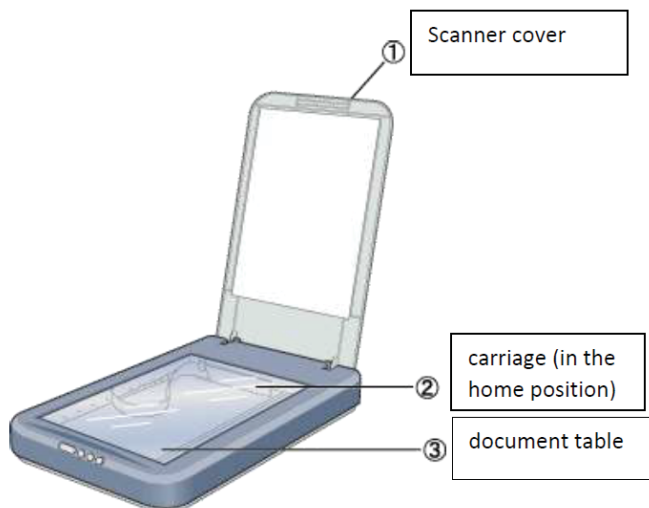

Figure 12.13 External visible parts of a scanner

Source: <https://files.support.epson.com>

When the cover is opened, the scanner looks like the following picture where there are two more parts namely the carriage (in the home position) and the document table.



Source: <https://files.support.epson.com>

In the back of a scanner, there are the 4 elements: (1) transportation lock, (2) power inlet, (3) film adapter connector and (4) USB port.

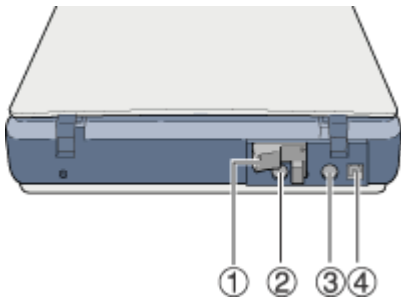

Source: <https://files.support.epson.com>

NB: Newly manufactured scanners may not have their parts arranged as shown in different images on scanners

Application Activity 12.2.

1. Compare digital camera to scanner? List the importance of digital camera in computer graphic.
2. With your camera, take a picture of the school computers, import it in your computer and insert it in one of your text documents created in MS Word.
3. At your school, what are the advantages and disadvantages of keeping scanned documents?
4. By using your scanner in computer laboratory, scan your student card and insert it in one text document created in MS Word.
5. Give the names of the 3 scanner parts indicated in the following image.

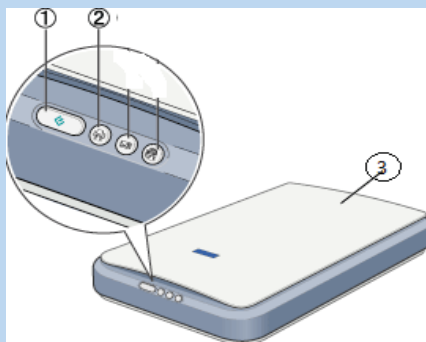

Source: <https://files.support.epson.com>

Area of graphics use

Computer graphics can be applied in various areas. Examples are such as follows:

12.3 Computer-Aided Design

Activity 12.3

After visiting the school library take different books and magazines and answer the following questions:

1. Describe how the books and magazines covers look.
2. What is importance of having attractive picture on first page of any magazine?
3. Which ways can be used to advertise your school?
4. List other fields where the photo are important to use

In engineering and architectural systems, the products are modeled using computer graphics commonly referred as CAD (Computer Aided Design). In many design applications like automobiles, aircraft, spacecraft, etc., objects are modeled in a wireframe outline that helps the designer to observe the overall shape and internal features of the objects.

12.3.2 Computer Art:

A variety of computer methods are available for artists for designing and specifying motions of an object. The object can be painted electronically on a graphic tablet using stylus with different brush strokes, brush widths and colors. The artists can also use combination of 3D modeling packages, texture mapping, drawing programs and CAD software to paint and visualize any object.

12.3.3 Entertainment:

Computer graphics methods are widely used in making motion pictures, music videos and television shows. Graphics objects can be combined with live actions or can be used with image processing techniques to transform one object to another.

12.3.4 Education and training:

Computer graphics can make better the understanding of the functioning of a system. In physical systems, biological systems, population trends, etc., models make it easier to understand. In some training systems, graphical models with simulations help a trainee to train in virtual reality environment. For example, practice session or training of ship captains, aircraft pilots, air traffic control personnel.

12.3.5 Image processing:

Image processing provides techniques to modify or interpret existing images. One can improve picture quality through image processing techniques. For instance, in medical applications, image processing techniques can be applied for image enhancements and is been widely used for CT (Computer X-ray Tomography) and PET (Position Emission Tomography) images.

12.3.6 Graphical User Interface:

GUI is commonly used to make a software package more interactive. There are multiple window systems, icons, menus, which allow a computer setup to be utilized more efficiently.

- a. **Logo** (abbreviation of logotype, from Greek: is a graphic mark, emblem, or symbol used to aid and promote public recognition. It may be of an abstract or figurative design or include the text of the name it represents as in a logotype or wordmark.
- b. **Advertising** is communicated through various mass media, including traditional media such as newspapers, magazines, television, radio, outdoor advertising or direct mail; and new media such as search results, blogs, social media, websites or text messages. The actual presentation of the message in a medium is referred to as an advertisement
- c. **An illustration** is a decoration, interpretation or visual explanation of a text, concept or process, designed for integration in published media, such as posters, flyers, magazines, books, teaching materials, animations, video games and films.
- d. **A magazine** is a publication, usually a periodical publication, which is printed or electronically published (sometimes referred to as an online magazine). Magazines are generally published on a regular schedule and contain a variety of content.

Conclusion

Computer Graphics involves ways in which images can be displayed, manipulated and stored using computers. Computer graphics images can be categorised into raster graphics, which as pixel-based graphics, and vector graphics, which are mathematically represented. Computer graphics is applicable in various areas such as computer-aided design, computer art, entertainment, as well as in education and training.

Application Activity 12.3.

5. Why is it important to use graphics in advertisement?
6. In Rwanda, how computer graphics is used in entertainment?
7. How your school logo is designed? Explain how can you modify it using computer graphic
8. Differentiate computer art to computer aid design
9. Discuss how computer graphics is used in entertainment in our country

12.4 Graphics software, features and editing tools

Activity 12.4

1. Describe what you see on the pictures below
2. How is it the appearance of those pictures?
3. In which way a picture can be modified?
4. Which tools can you use to modify or to create a picture?

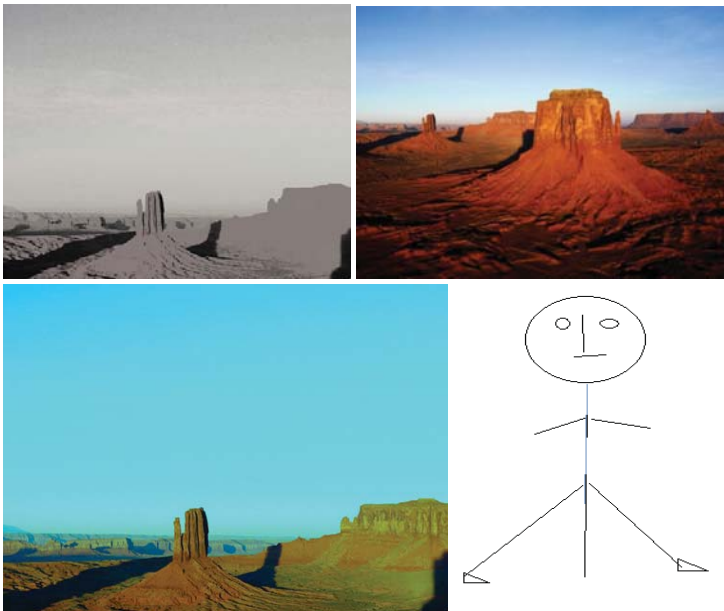

Figure 12.14 variety of picture

Source: <https://e-nautia.com/lesab.mohcyn/disk?p=8371633>

12.4.1 Graphic softwares

Computer graphics is mostly mastered by practicing; such as by writing and testing programs that produce a variety of pictures. An environment that allows one to write and execute programs is required. The environment should generally include hardware for display of pictures, and software tools that written programs can use to perform the actual drawing of pictures. This part presents the commonly used software for producing graphics.

a. Microsoft Paint

Microsoft Paint or 'MS Paint' is a basic graphics/painting utility that is included in all the Microsoft Windows versions. MS Paint can be used to draw, colour and edit pictures, including imported pictures from a digital camera for example. MS Paint is found in the windows start menu within the Accessories Folder.

The primary features of MS Paint are simple drawing tools that you can use to easily draw on a blank canvas or existing image. Beyond that, Paint includes cropping, resizing, rotating, skewing, and selection tools to further.

b. Microsoft Office Picture Manager

Microsoft Office Picture Manager (code named Microsoft Picture Library) is a raster graphics editor introduced in Microsoft Office 2003 and included up to Office 2010. The Basic image editing features include colour correct, crop, resize, and rotate.

With Microsoft Office Picture Manager, you can manage, edit, share, and view your pictures from where you store them on your computer. There are picture editing tools to crop, expand, or copy and paste.

Microsoft Office Picture Manager allows easily managing and editing. Picture Manager is used to adjust the brightness and contrast of an image.

c. Adobe Photoshop

Adobe Photoshop is a raster graphics editor developed and published by Adobe Systems for MacOS and Windows.

Adobe Photoshop is the predominant photo editing and manipulation software on the market. Its uses range from full featured editing of large batches of photos to creating intricate digital paintings and drawings that mimic those done by hand.

12.4.2 Graphic features

12.4.2.1 Definition

Graphic features are pictures and other images that accompany a piece of text to improve its meaning for the reader. Some examples of graphic features include **photographs, drawing, maps, charts and diagrams**. While graphic features may sometimes be purely decorative, they are more often used to make the meaning of a text clearer.

Example of graphic features





Text Feature	Purpose	Example
Photograph	Shows what something looks like (taken with a camera)	
Illustration	Shows what something looks like (drawn by an artist)	
Caption	Explains what a photograph or illustration is about	
Labels	Tells the names of certain parts of a photograph or illustration	
Graph	Organizes and helps compare information in a visual way	 The human body is made of: 53% water 47% other elements
Table	Organizes facts and numbers in a visual way so it is easier to read	 How much does your heart beat? Number of Beats Amount of Time 90 MINUTE 129,000 DAY 3.8 million MONTH 47.3 million YEAR

Figure 12.15 graphic features

Source: <http://www.pmdentalcollege.com>

12.4.3 Graphic editing tools

a. Tools in MS-Paint

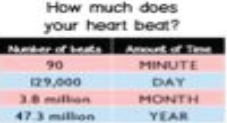
Starting the Microsoft Paint program in Windows

1. Choose Start->All Programs->Accessories->Paint.

2. Click the application icon and click Open.

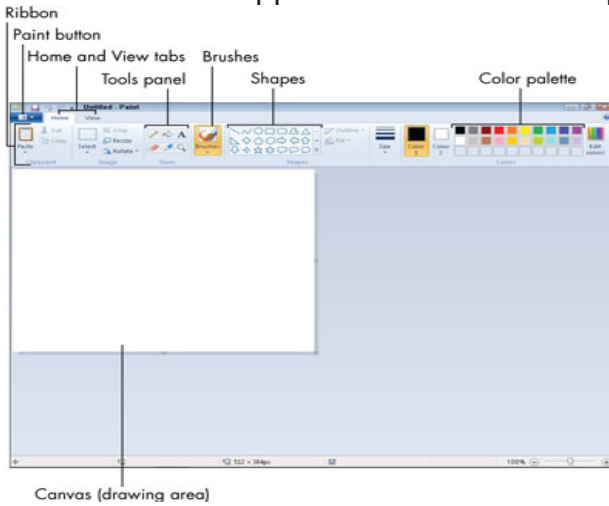

Figure 12.16 MS paint environment

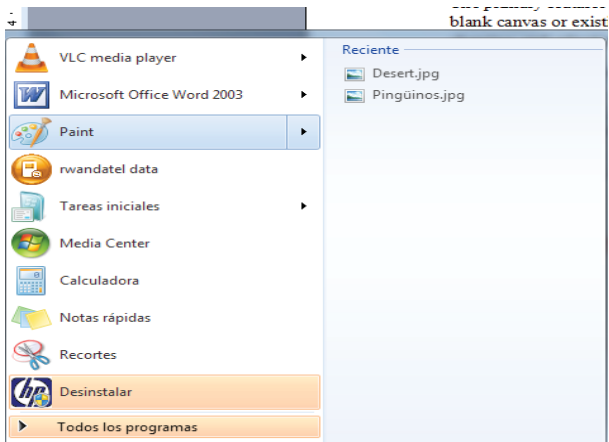

Figure 12.17 Open MS paint

• Copy and paste

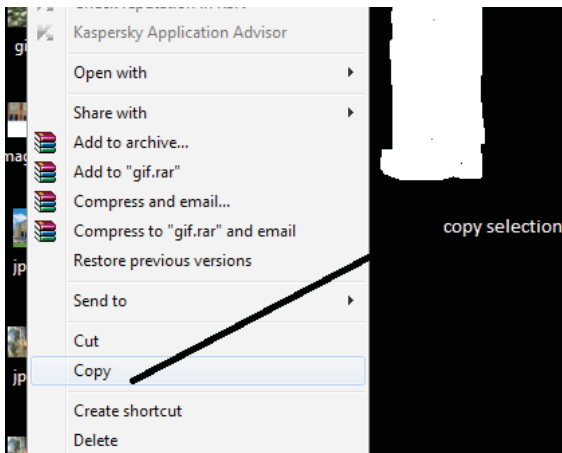

Figure 12.17 copy and paste image

Rightclick on image->select copy->open new document->ctrl+V

- **Resize**

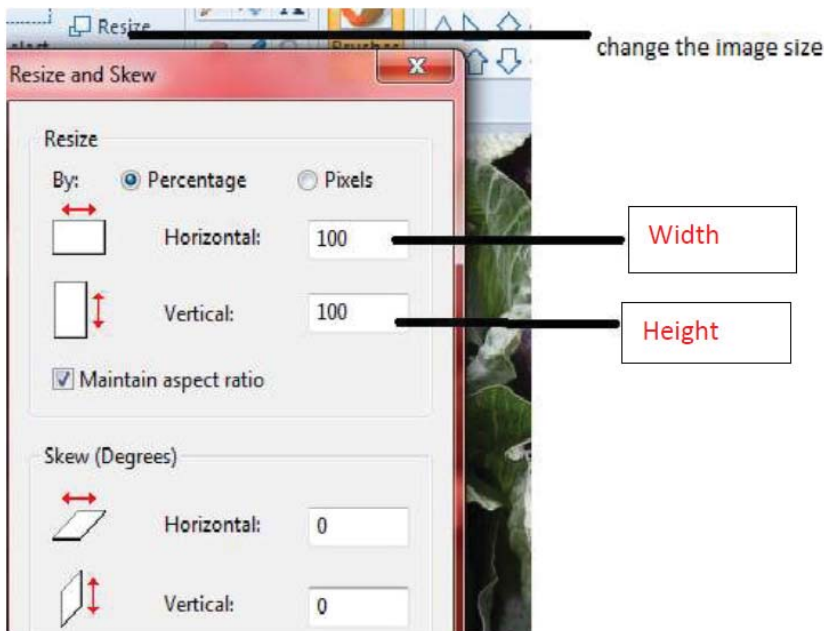

Figure 12.18 resizing image

- **Texture**

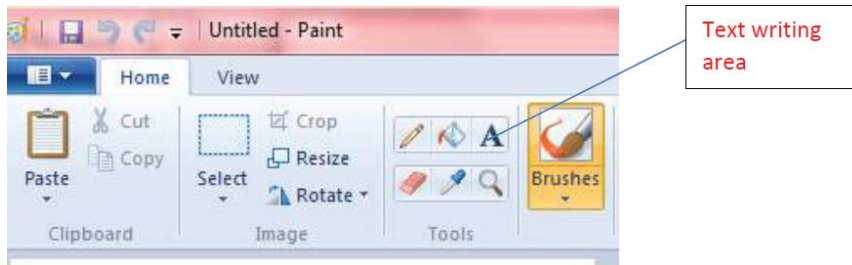

Figure 12.19 Texture

- **Rotate**

- **Rotate**

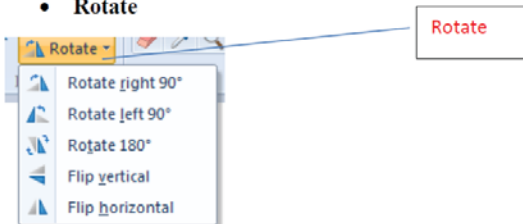

Figure 12.20 Rotate

- **Before**

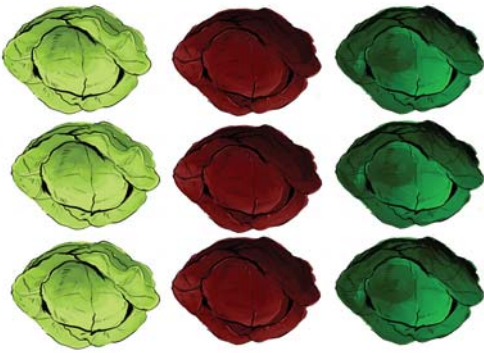

Figure 12.21 Image before change its disposition

- **After**



Figure 12.20 image after change its position

c. **Tools in Ms Office picture manager**

Step1.

Starting the Microsoft office picture manager

Microsoft Office comes with its own Picture Manager. You can open the Picture Manager by clicking Start, choosing All Programs (or Programs), choosing the Microsoft Office folder, choosing Microsoft Office Tools, and clicking Microsoft Picture Manager.

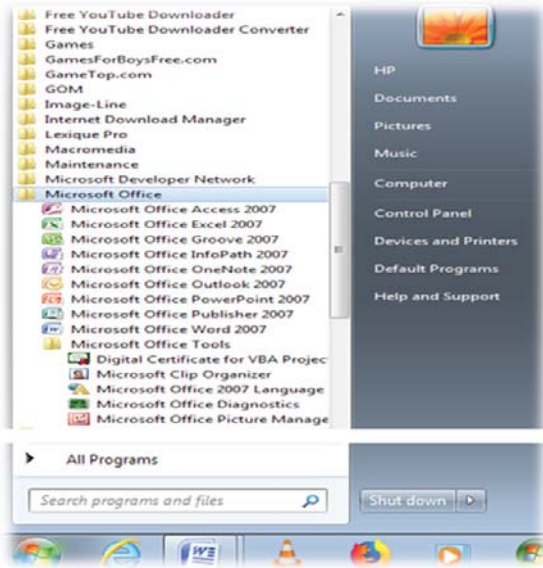

Figure 12.21 Launch Ms picture manage

Step2.

Using Picture Manager editing tools for adjustment:

- **Brightness and contrast:** Select the brightness and contrast menu entry. The task pane will display a range of control sliders; you can use these to adjust any exposure issues (too bright, too dark etc).

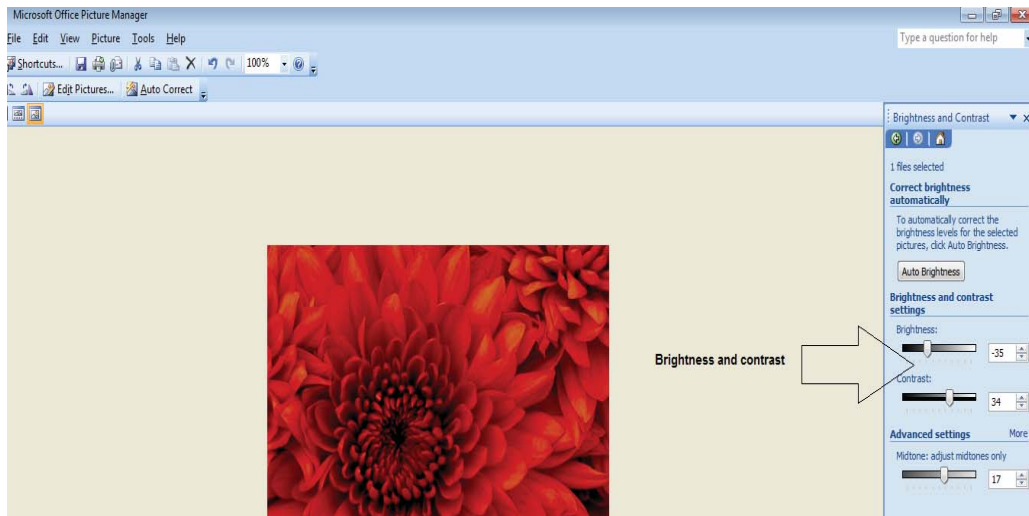

Figure 12.22 Brightness and contrast tool

- **Color:** Select the Color option from the Edit Pictures menu. Use the sliders to adjust the Hue and Saturation.

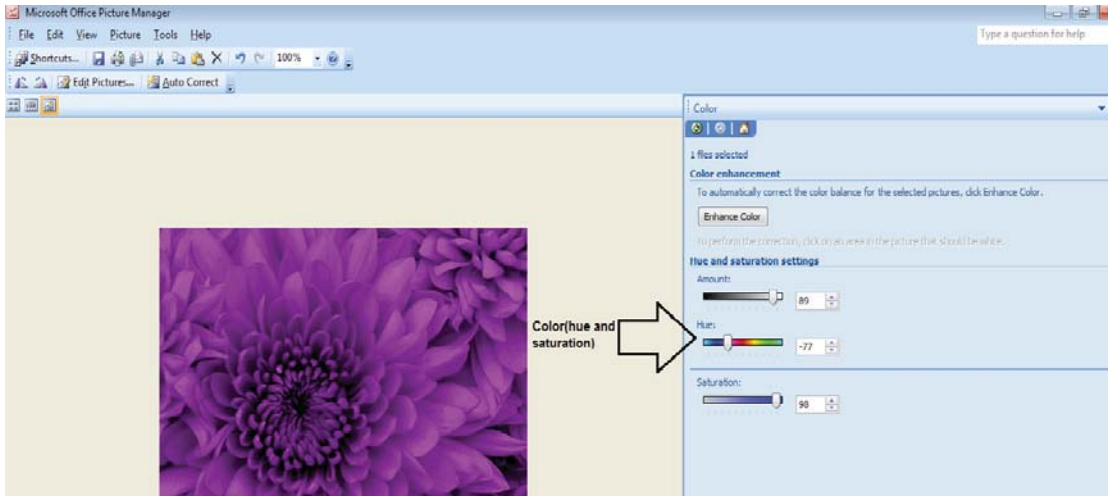

Figure 12.23 Colour

- **Crop:** Select the Crop option. You will notice the crop is previewed on the image; you can click and drag the crop area to reposition it. Grab the little black crop marks in the corners or on the edges to scale the image.

Click OK to cut the photo to the crop.

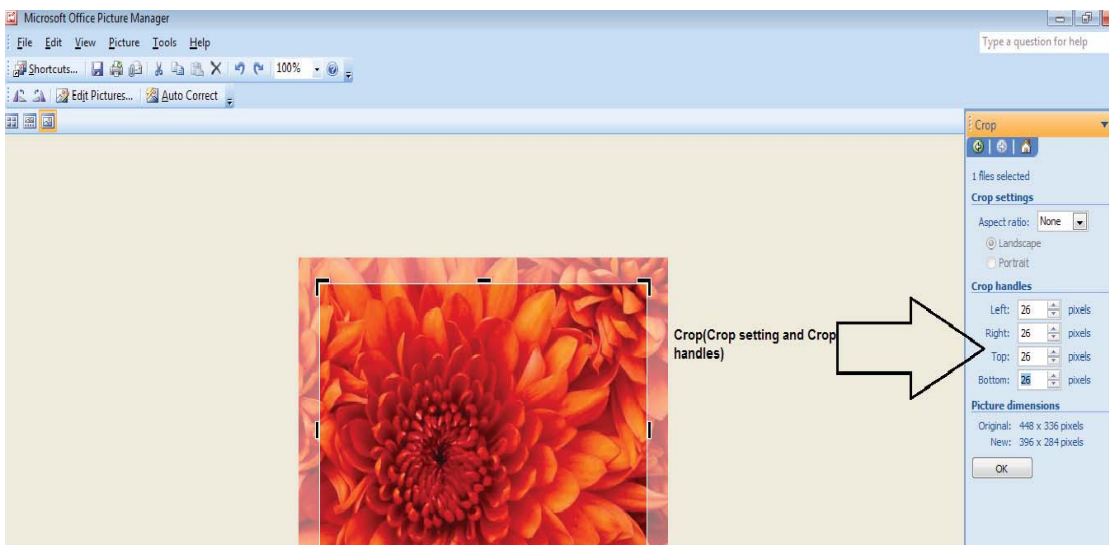

Figure 12.24 Crop

- **Red-eye removal:** Select Red eye removal from the Edit Pictures menu. Click the mouse cursor several times over all the red eye areas you want to remove, and then click OK.

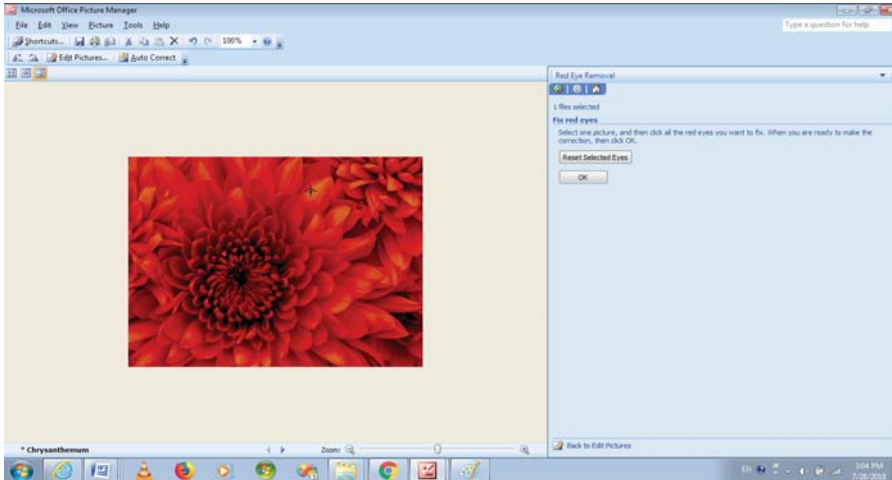

Figure 12.25 Red-eye removal

- **Resize your picture:** On the Edit Pictures menu select Re-size to display the resize.

Choose the Predefined setting of Document – Small (800 x 600), this is perfect for working in Word without slowing it down. This will also reduce the size of the file, perfect if you intend on emailing the document as an attachment.

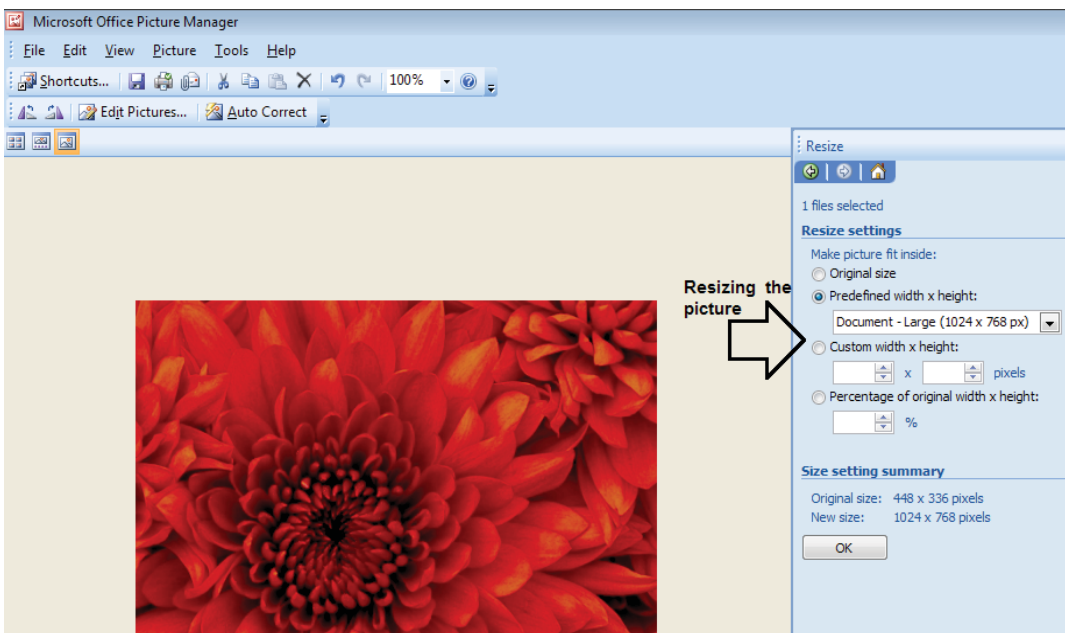

Figure 12.26 Resizing the picture

After editing a picture, you can either File > Save to save the photo in its modified format, or File > Save As... to give it a new filename (allowing you to keep the original source file intact).

d. Tools in Photoshop

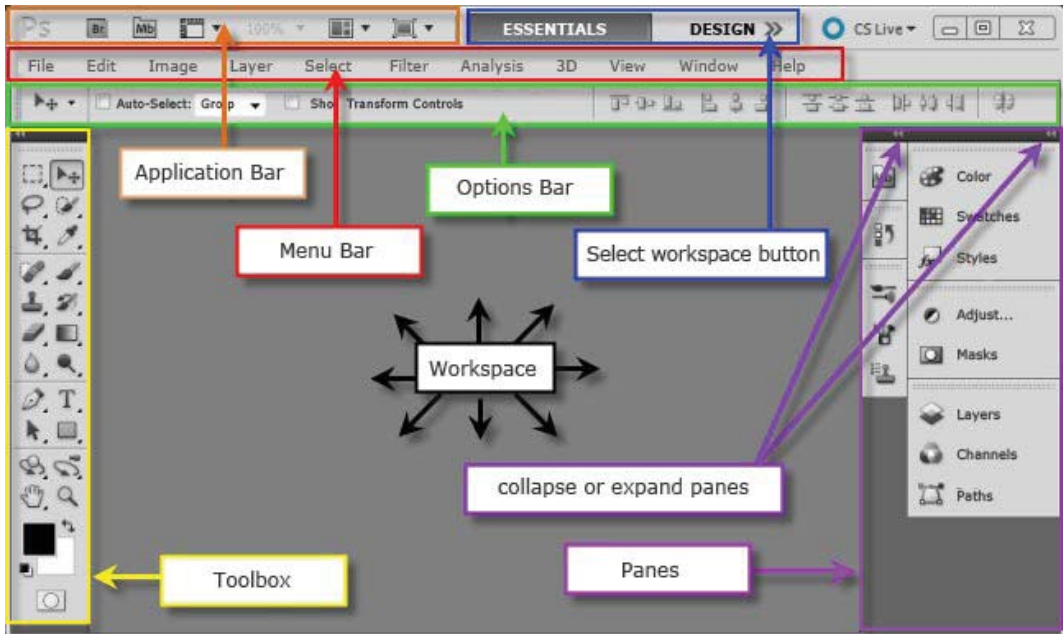

Figure 12.27 Photoshop environment

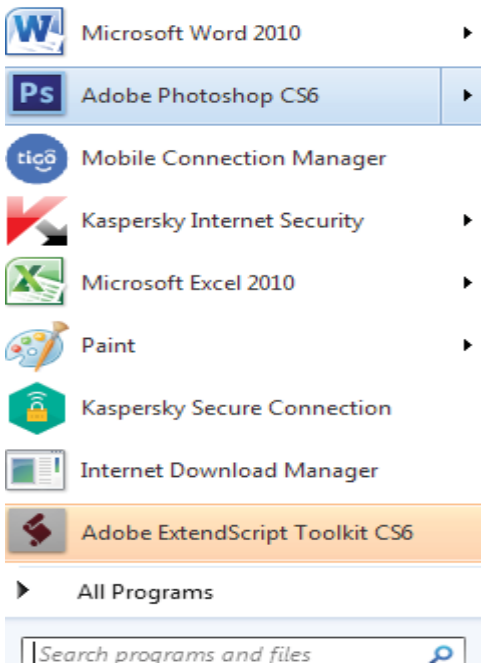

Figure 12.28 Launch Photoshop

1. Photoshop editing tools

To change the image size, go through these steps:

Start->photoshop->File->open (choose an image where it is stored)->image
(in menu bar)

->image size->fill the new width and height in pixel dimension->ok

For this exercise, consider the image below which is with its original dimensions:

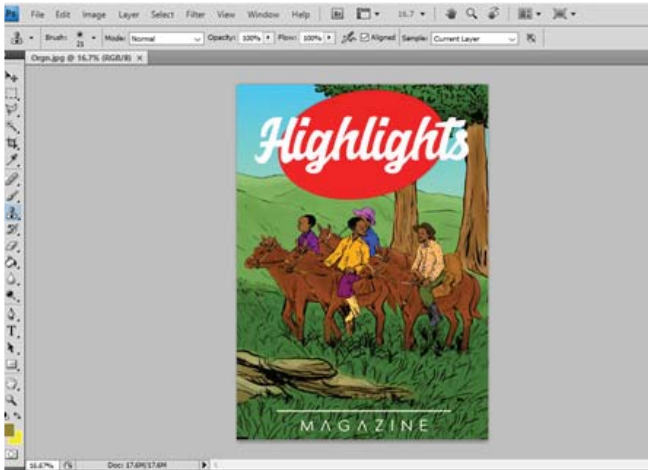

Figure 12.29. Image with its original dimensions

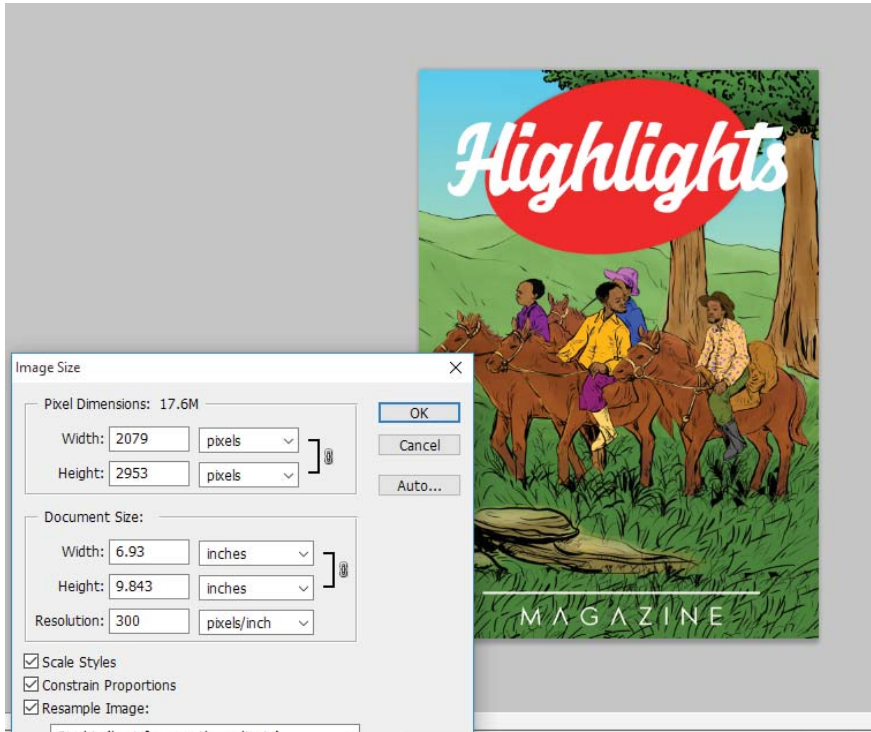

Figure 12.30 image size

After changing the dimension the size of image, will be changed.

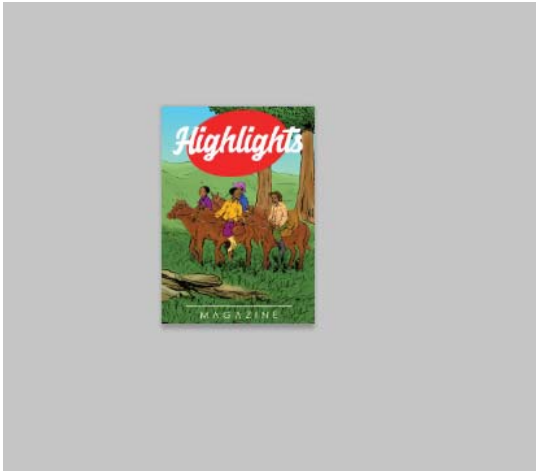

Figure 12.31 resized image

Canvas size

Canvas size is different from image size in the sense that canvas size changes the limits of the photoshop document, but not the pixels contained therein.



Figure 12.32 canvas size

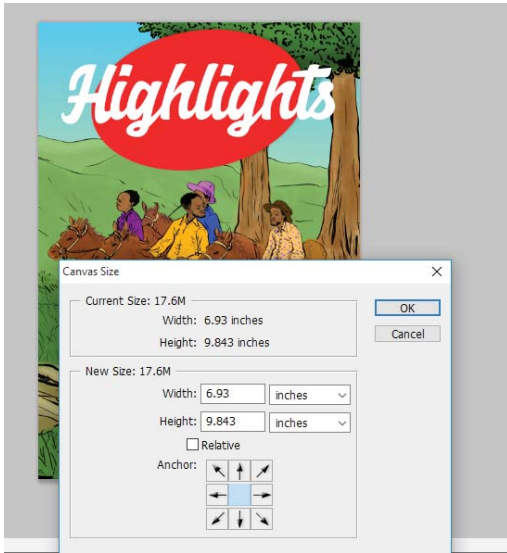

Figure 12.33 canvas size interface



Figure 12.34 Canvas size image result

2. Colour picker tools

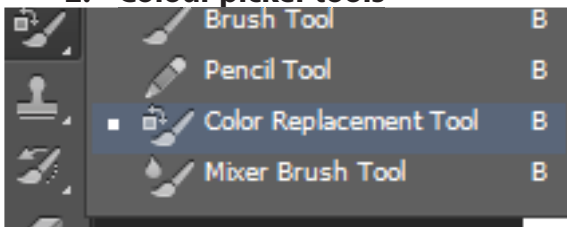

Figure 12.35 Colour picker tools

Letter or text highlighted



Figure 12.36 Letter or text highlighted

This is the result of highlighted letter or text



Figure 12.37 The result of highlighted letter or text

In Photoshop, Adobe introduced the **Color Picker** to make the selection of a **color** even easier. (To access the **Color Picker** with a painting tool selected, click anywhere in the image area and drag to select a **color**.)

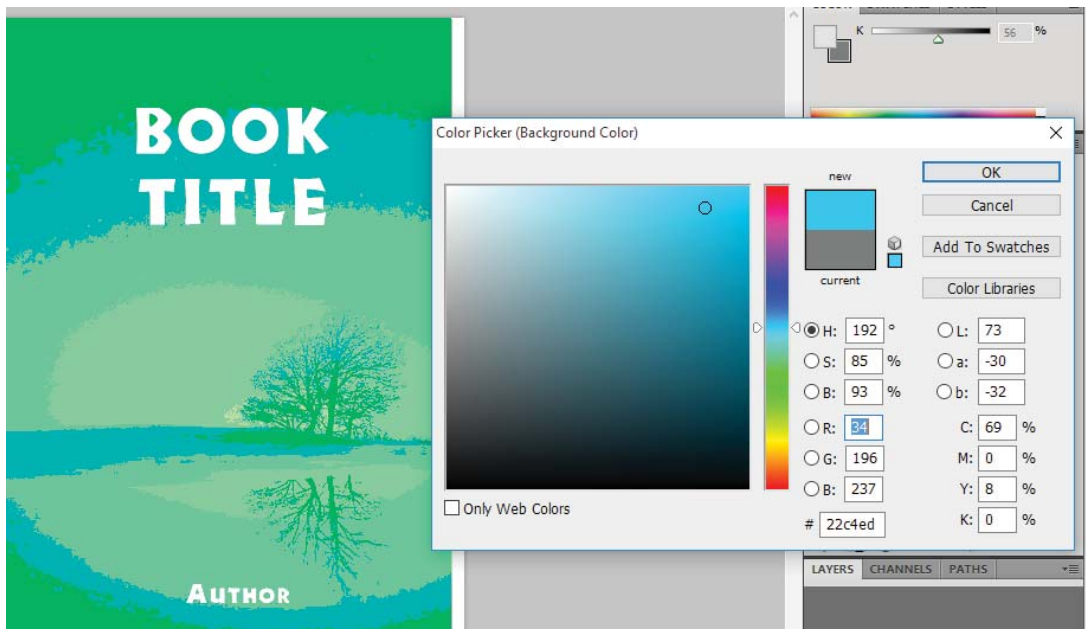

Figure 12.38 coloured image

Magic wand

The Magic Wand Tool, known simply as the **Magic Wand**, is one of the oldest selection tools in Photoshop. Unlike other selection tools that select pixels in an image based on shapes or by detecting object edges, the Magic Wand selects pixels based color

Eraser tool

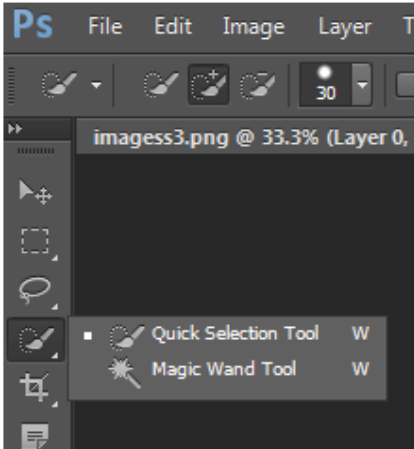

Figure 12.39 Magic wand tool

Eraser

An **eraser** is an article of stationery that is used for removing writing from paper or skin. Erasers have a rubbery consistency and come in a variety of shapes, sizes and colours.



Figure 12.40 image is erased

Gradient tool

A **gradient** is a set of colors arranged in a linear order, sometimes known as the “**gradient tool**” or “**gradient fill tool**”: it works by filling the selection with colors from a **gradient**.

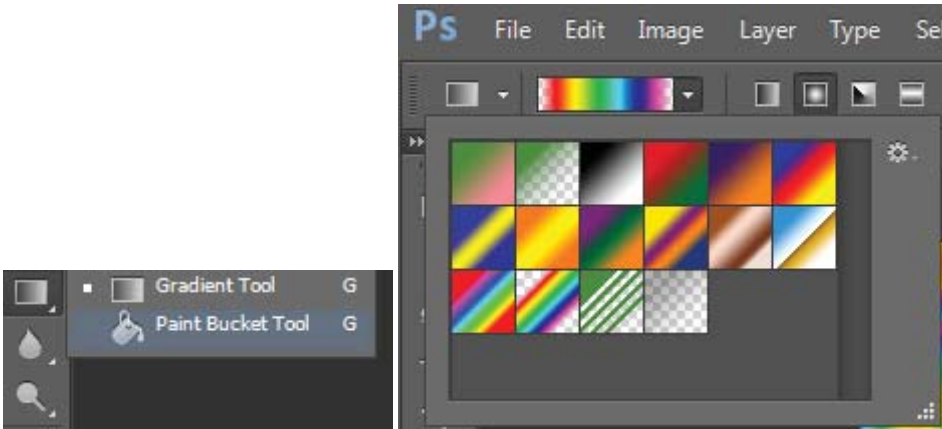

Figure 12.41 image gradient tool

This is the gradient image result

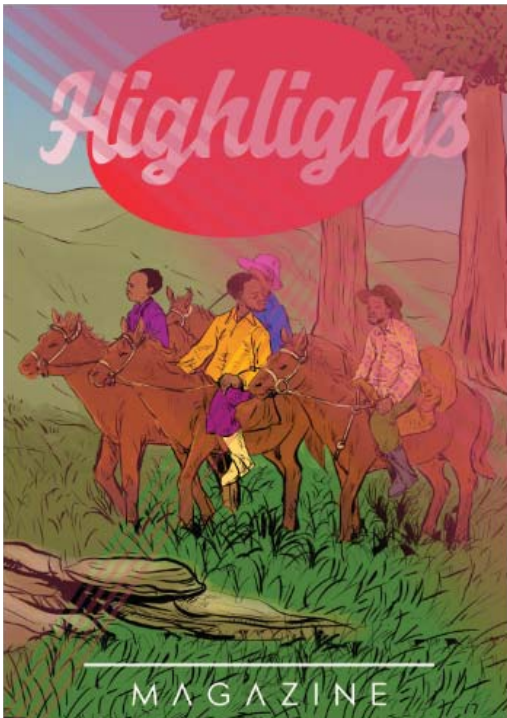

Figure 12.42 Gradient image

Paint bucket

The **paint bucket** tool generally comes along with image editing software. What it does is fill an area on the image with a selected color. The tool usually fills to the boundaries of a solid color. As an example if you have a black box and apply red with the **paint bucket** tool it will convert the entire box to red.

Paint bucket tool

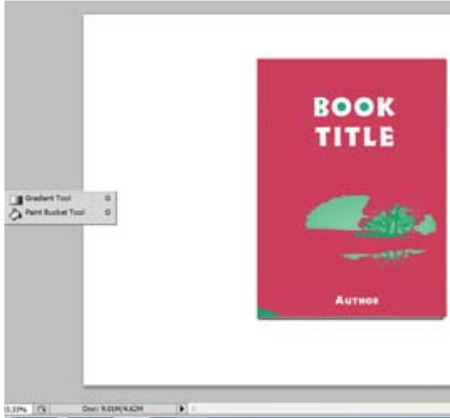

Figure 12.43 paint bucket

The result of paint bucket image

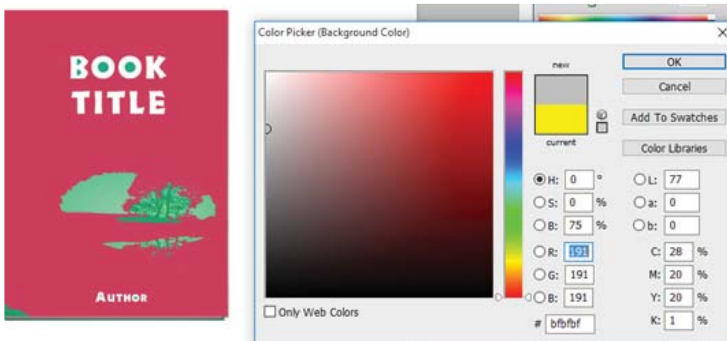

Figure 12.44 the result of paint bucket

Sharpen; the Sharpen tool focuses soft limits in a photo to increase clarity or focus

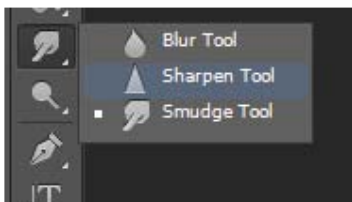

Figure 12.45 sharpen

Smudge

The **smudge tool** is used to smear paint on your canvas. The effect is much like finger painting. You can use the **smudge tool** by clicking on the **smudge** icon and clicking on the canvas and while holding the mouse button down, dragging in the direction you want to **smudge**.



Figure 12.46 Smudge

Clone stamp tool

Clone stamp is used in digital image editing to replace information for one part of a picture with information from another part. In other image editing software, its equivalent is sometimes called a **clone** brush.



Figure 12.47 Clone stamp

Shape

A **shape** is the form of an object or its external boundary, outline, or external surface, as opposed to other properties such as color, texture or material composition

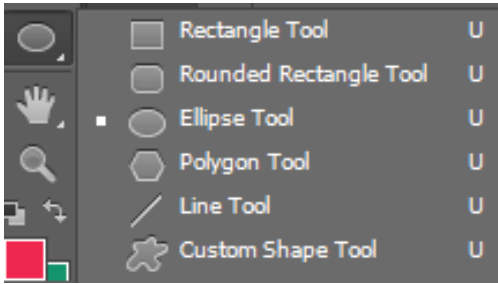

Figure 12.48 Shapes

Line: is a basic concept of elementary geometry

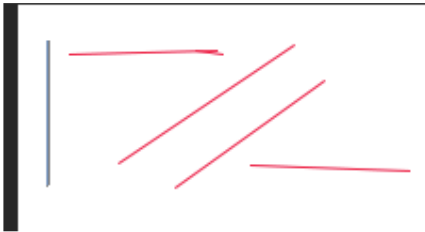

Figure 12.49 Lines

Rectangle: is a quadrilateral with four right angles a plane figure with four straight sides and four right angles, especially one with unequal adjacent sides, in contrast to a square



Figure 12.50 Rectangle

Lasso tool: it is used to create a selection area within or around a particular object. The difference is that it allows the user to more easily select along individual short paths on difficult object limit where the **tool** can't be used



Figure 12.51 Lasso

Polygon lasso

The **Polygonal Lasso Tool** is hiding behind the standard Lasso Tool in the Tools panel. Once you've selected the Polygonal Lasso Tool, it will appear in place of the standard Lasso Tool in the Tools panel.

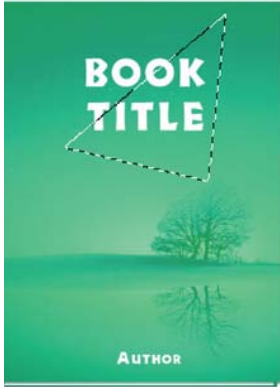

Figure 12.52 polygon lasso

The result of polygon lasso



Figure 12.53 polygon lasso

Crop

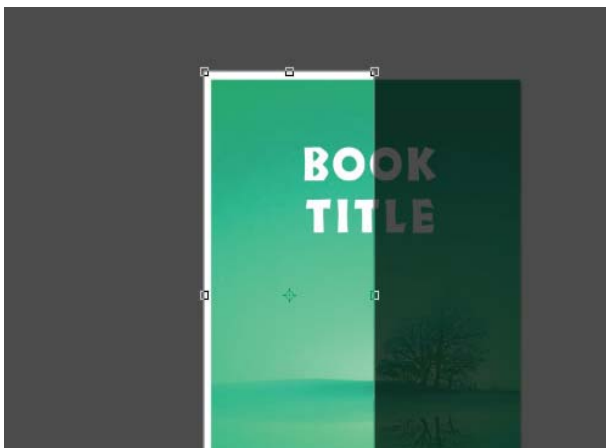

Figure 12.54 crop

Rotate

This **tool** is used to **rotate** the active layer, a selection or a path. When you click on the image or the selection with this **tool**, a grid or an outline is superimposed and a rotation information dialog is opened. There, you can set the rotation axis, marked with a point, and the rotation angle.

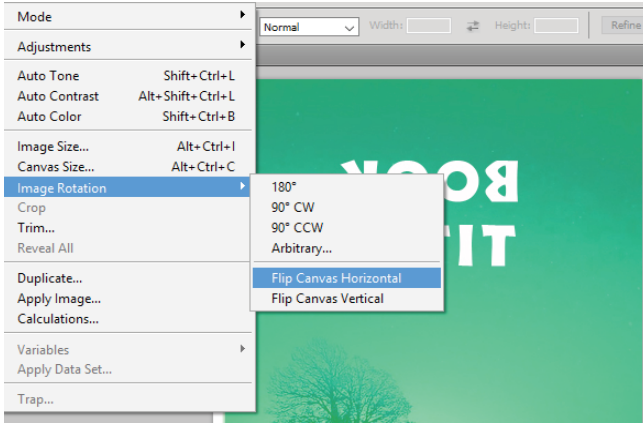

Figure 12.55 Rotate image

Original image



Figure 12.56 original image

This image is rotated



Figure 12.57 Rotated image

Flip canvas horizontal

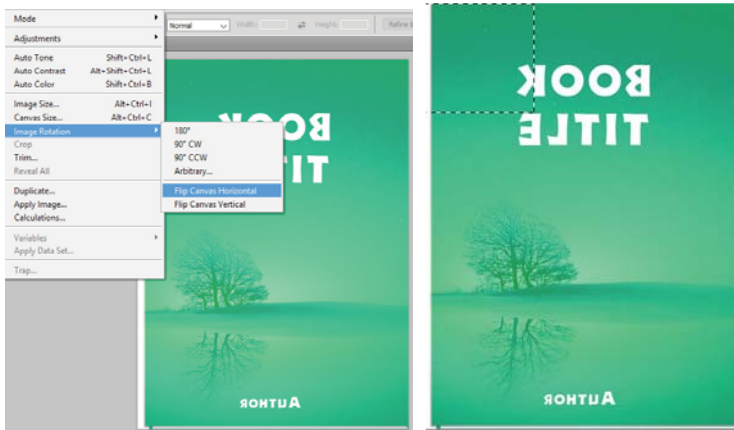

Figure 12.58 Flip canvas horizontal

Application Activity 12.4.

1. What is the importance of Ms Paint in computer graphics?
2. Differentiate Photoshop from MS office picture manager
3. Discuss the use of Ms Office picture manager in graphics
4. Differentiate Paint from Photoshop
5. What is the use of Lasso tool in Photoshop
6. Distinguish image size to canvas size
7. What is the use of Gradient Tool?

12.5 Basic Graphic elements

Activity 12.5

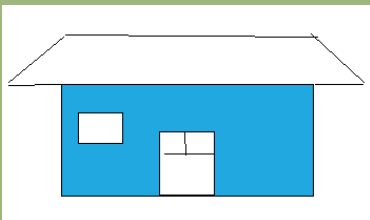

Observe the picture above and answer the following questions:

1. Describe what you see on the picture
2. What are the elements which make this picture?
3. how can you put different parts of this image

12.5.1 Graphic elements

Graphic elements are the simplest building blocks of graphics. Just as bricks are the basic elements of a building, graphic elements are used to create graphics.

12.5.2 Basic graphic element types

The basic graphic elements are the following:

Line is probably the most fundamental of all the elements of design. A more usable definition might be that line is the path of a dot, point etc. through space and that is always has more length than thickness. Lines are not all the same, especially in art

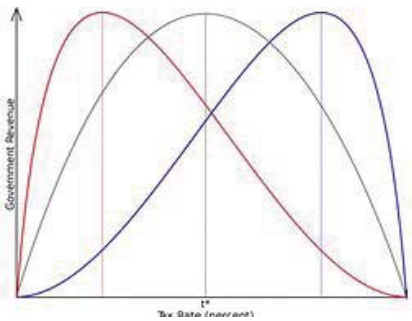

interparts, connect two points. The difference is the ; dips and turns from Point A to Point B. Curves are or straight lines and have a feel that is more fluid and

The **circle** is a perfect shape, meaning that it is the same no matter how you look at it.



An **oval** is a closed curve in a plane which “loosely” resembles the outline of an egg. The term is not very specific, but in some areas it is given a more precise definition, which may include either one or two axes of symmetry.



A **rectangle** is a plane figure with four straight sides and four right angles, especially one with unequal adjacent sides, in contrast to a square.

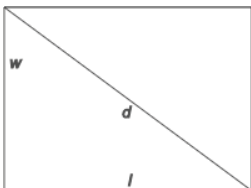

A **brush** is a tool with bristles, wire or other filaments, used for cleaning, grooming hair, make up, painting, surface finishing and for many other purposes.



Polyline

A polyline is a connected sequence of straight lines. To the eye, a polyline can appear as a smooth curve. Simple polyline attributes are colour and thickness. The simplest polyline is a single straight line segment. A line segment is specified by its two endpoints, such as (x_1, y_1) and (x_2, y_2) . When there are several lines in a polyline, each one is called an edge, and two adjacent lines meet at a vertex.

The edges of a polyline can cross one another but a polyline does not have to be closed. A polygon has its first and last points connected by an edge. If no two edges cross, the polygon is called a simple polygon. An example of a polyline is shown in figure 12.60 and a polygon is shown in figure 12.61

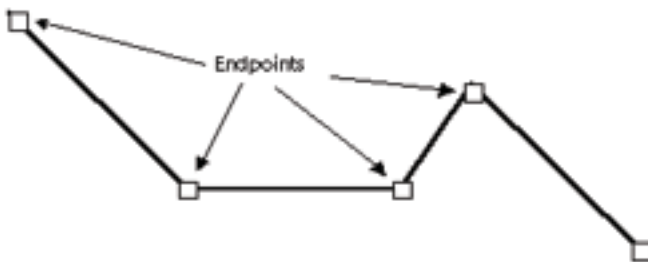

Figure 12.60 Polyline

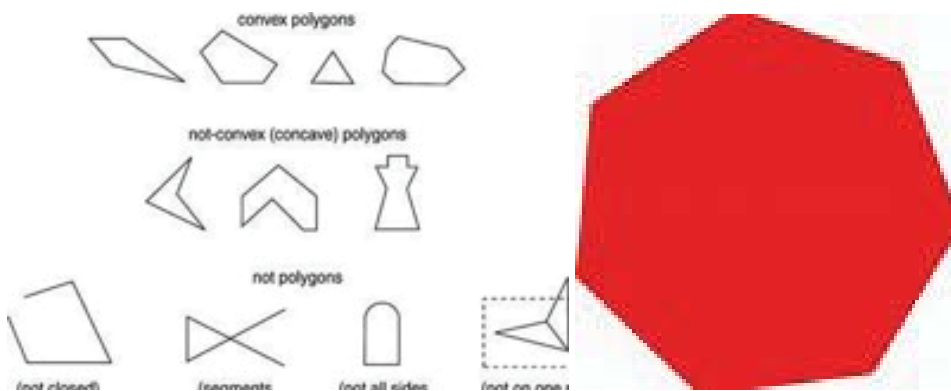

Figure 12.61 Polygon

The polygon element defines a closed shape consisting of a set of connected straight line segments. The last point is connected to the first point.

Text

Some graphics devices have two distinct display modes: text mode and graphics mode. In text mode, text is generated using a built-in character generator. Text in graphics mode is drawn. Text attributes are such as colour, size, font, spacing and orientation.

Filled Regions

A filled region is a shape filled with some colour or pattern. An example is a filled polygon as shown in figure.

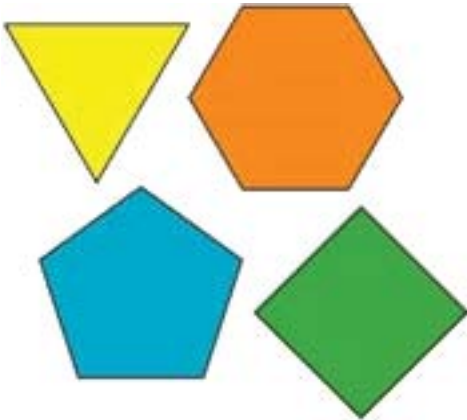

Figure 12.62 shapes filled colour

Application Activity 12.5.

1. Describe the graphic element?
2. Describe basic elements in computer graphics
3. Differentiate an oval to a circle
4. Describe the use of brush in computer graphic?

END UNIT ASSESSMENT

A. Written assessment

Define the following terms:

- Brush
- Shape
- Lasso tool
- Bitmap
- Advertisement

1. Match the following tools in column A with their corresponding use in column B

Column A

- Lens
- Crop
- Magic wand colour
- Gradient
- Paint bucket

Column B

- a. tool used to select pixels in an image based on shapes
- b. part of camera where light enters through
- c. a tool used to fill an area on the image with a selected colour
- d. set of colours arranged in a linear
- e. cut the parts which you do not need.

2. What is polygon? Give an example
3. Explain the importance of computer graphic in decoration service
4. Write in full words the following abbreviation and explain them:
JPEG - TIFF - PNG
5. Distinguish 8-bit colour to high colour graphics
6. What is the use of USB port on digital camera
7. Differentiate 2D image to 3D image
8. Discuss the difference between Ms Paint and Adobe Photoshop
9. In Rwanda, computer graphics are used in advertising and entertainment.
Discuss

B. Practical work

Create a simple image using some of the drawing tools in Paint(Pencil, brush and

shapes)

- a. Selecting and moving parts of an image
 - b. Selecting and copying parts of an image
 - c. Save the image in JPG format
 - d. Copy that image in a word document
1. Using Adobe Photoshop, draw a ball as shown bellow



2. Create a line, polygon and a square using Paint. Make the shape outlines coloured and filled with effects where possible. Save the file as SHAPES
3. Take a picture of yourself using a digital camera and edit the photo in a way you wish using various tools on the toolbox and menu. In case of absence of camera, use any available photo on your computer and perform editing functioning to crop, resize, rotate and change the light of the picture.



UNIT 13

MULTIMEDIA

UNIT 13: MULTIMEDIA

Key unit competency

To be able to explain the different use of multimedia and interactive multimedia applications and to use multimedia software to create video.

Introductory Activity

Observe the figure below and answer the following questions.



1. Describe what you see.
2. What materials or tools are used?
3. Explain the method used to achieve their objectives?
4. What is the importance of multimedia in meetings organization?
5. What else technologies can be used to share information between individuals and institutions?

13.1. INTRODUCTION TO MULTIMEDIA

Activity 13.1.

1. What do you understand by Multimedia?
2. Discuss the role of multimedia in daily life.
3. Discuss the software used in multimedia.

13.1.0 Definition

Multimedia is the content that uses a combination of different forms of content such as text, audio, images, animations, video and interactive content. Multimedia contrasts with media that uses only rudimentary computer displays such as text-only or traditional forms of printed or hand-produced material.

Multimedia can be recorded and played, displayed, interacted with or accessed by information content processing devices, such as electronic devices, but can also be part of a live performance. **Multimedia devices** are electronic media devices used to store and experience multimedia content.

13.1.1 Different types of media

Media are the collective communication outlets or tools used to store and deliver information or data. Modern media come in many different formats, including print media (books, magazines, newspapers), television, movies, video games, music, cell phones, various kinds of software, and the internet.

1. Print Media

The term 'print media' is used to describe the traditional or "old-fashioned" print-based media, including newspapers, magazines, books, and comics or graphic novels.

2. Television

Television (TV) is a telecommunication medium used for transmitting moving images in monochrome (black and white), or in colour, and in two or three dimensions and sound. The term can refer to a television set, a television program ("TV show"), or the medium of television transmission. Television is a mass medium for advertising, entertainment and news.

3. Movies

Movies, also known as **films**, are a type of visual communication which uses moving pictures and sound to tell stories or inform (help people to learn). People in every part of the world watch movies as a type of entertainment, a way to have fun.

4. Video Games

A **video game** is an electronic game that involves interaction with a user interface to generate visual feedback on a video device such as a TV screen or computer monitor.

13.1.2 Media applications

Multimedia finds its application in various areas including, but not limited to, advertisements, art, education, entertainment, engineering, medicine, mathematics, business, scientific research, spatial temporal applications, etc.. Several examples are as follows:

1. Creative industries

Creative industries use multimedia for a variety of purposes ranging from fine arts, to entertainment, to commercial art, to journalism, to media and software services.

2. Commercial uses

Much of the electronic used by commercial artists and graphic designers is multimedia. Exciting presentations are used to grab and keep attention in advertising. Business to business, and interoffice communications are often developed by creative services firms for advanced multimedia presentations beyond simple slide shows to sell ideas or liven up training.

3. Entertainment and fine arts

Multimedia is heavily used in the entertainment industry, especially to develop special effects in movies and animations (VFX, 3D animation, etc.). Multimedia games are a popular pastime and are software programs available either as CD-ROMs or online. Some video games also use multimedia features. Multimedia applications that allow users to actively participate instead of just sitting by as passive recipients of information are called interactive multimedia. In the arts, there are multimedia artists, whose minds are able to blend techniques using different media that in some way incorporates interaction with the viewer.

4. Education

In education, multimedia is used to produce computer-based training courses (popularly called CBTs) and reference books like encyclopedia and almanacs. A CBT lets the user go through a series of presentations, text about a particular topic, and associated illustrations in various information formats. Edutainment is the combination of education with entertainment, especially multimedia entertainment.

5. Journalism

Newspaper companies all over the world are trying to embrace the new phenomenon by implementing its practices in their work.

6. Engineering

Software engineers may use multimedia in computer simulations for anything from entertainment to training such as military or industrial training. Multimedia for software interfaces are often done as collaboration between creative professionals and software engineers.

7. Mathematical and scientific research

In mathematical and scientific research, multimedia is mainly used for modeling and simulation. For example, a scientist can look at a molecular model of a particular substance and manipulate it to arrive at a new substance.

8. Medicine

In medicine, doctors can get trained by looking at a virtual surgery or they can simulate how the human body is affected by diseases spread by viruses and bacteria and then develop techniques to prevent them. Multimedia applications such as virtual surgeries also help doctors to get practical training.

13.1.3. Hardware and software requirements

Multimedia is the one industry which requires different equipments to be used. It requires Hardware and Software equipment as listed below.

a. Hardware

27" standalone iMac

- 15" monitor with multiple video inputs
- scanner
- DV/DVD recording :is an optical disc **recorder** that uses optical disc **recording** technologies to digitally record analog or digital signals onto blank writable **DVD** media
- DVD/VCR recording deck: is an electromechanical device that records analog audio and analog video from broadcast television or other source on a removable, magnetic **tape** videocassette, and can play back the **recording**.
- DV/VCR recording deck
- DV recording deck
- Whiteboard

b. Software used in multimedia

Software	Description
Adobe Acrobat Pro	Protect documents and accelerate information exchange with PDF
Adobe Creative Suite Master Collection	Contribute, Dreamweaver, Fireworks, Flash Pro, Illustrator, InDesign, Photoshop, Premier Pro, and supporting applications
Facetime	Make video calls
Final Cut Studio Pro	Video Editing. Package includes Soundtrack Pro, Cinema Tools, and DVD Studio
HandBrake	Video encoder
iCal	Personal calendar application
iChart	HIPAA compliant digital medical assistant to manage patient records
iLife	iDVD, GarageBand, iMovie, iPhoto and iWeb.
Image Capture	Upload pictures from digital cameras or scanners
iSync	Provides built-in support for a number of third-party mobile devices.
iTunes	Download media for Mac, PC, iPod and iPhone
iWork	Create documents, spreadsheets, and presentations on the MAC
Microsoft Office Suite	Excel, PowerPoint, Word and Access
PhotoBooth	Take photos and videos with camera
Preview	Display images and PDF documents

Application Activity 13.1.

1. Explain how multimedia can be applied in education
2. State different software and hardware required for multimedia applied in education.
3. What kind of headphone can you use to protect your ears from the noise

13.2. Interactive multimedia

Activity 13.2.

4. What do you understand by Hyperlink?
5. In PowerPoint presentation, discuss different steps followed to create hyperlinks.

13.2.1 PowerPoint presentation

a. Creating Hypertext in the same document

Whenever the internet is used in Microsoft office 2013, **hyperlinks are used** to navigate from one webpage to another. **Web addresses or email addresses are included** in PowerPoint presentation through hyperlinks.

Hyperlinks have **two basic parts**: the **address** of the webpage, email address, or other location they are linking to, and the **display text** (which can also be a picture or shape). For example, the address could be **https://www.youtube.com**, and **YouTube** could be the display text. In some cases, the display text might be the same as the address. When creating a hyperlink in PowerPoint, choose both the address and the display text or image.

1. Steps Creating Hyperlink

Step1: Select the image or text you want to make a hyperlink.

Step2: Right-click the selected text or image, then click **Hyperlink**.

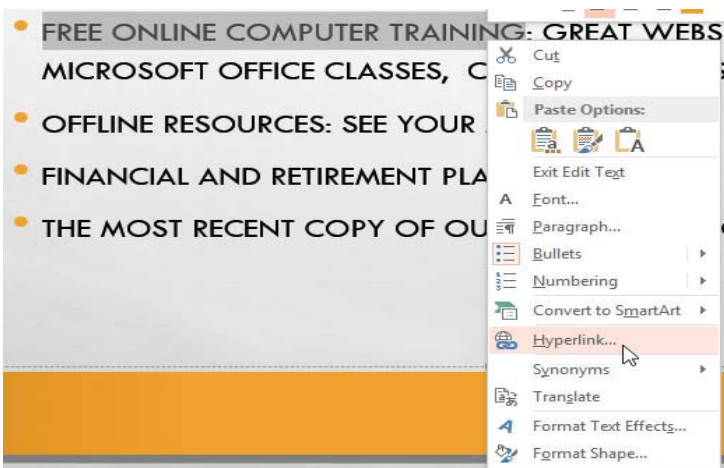

Figure 13.1: Image location

Step3: The **Insert Hyperlink** dialog box will open. You can also get to this dialog box from the Insert tab by clicking Hyperlink.

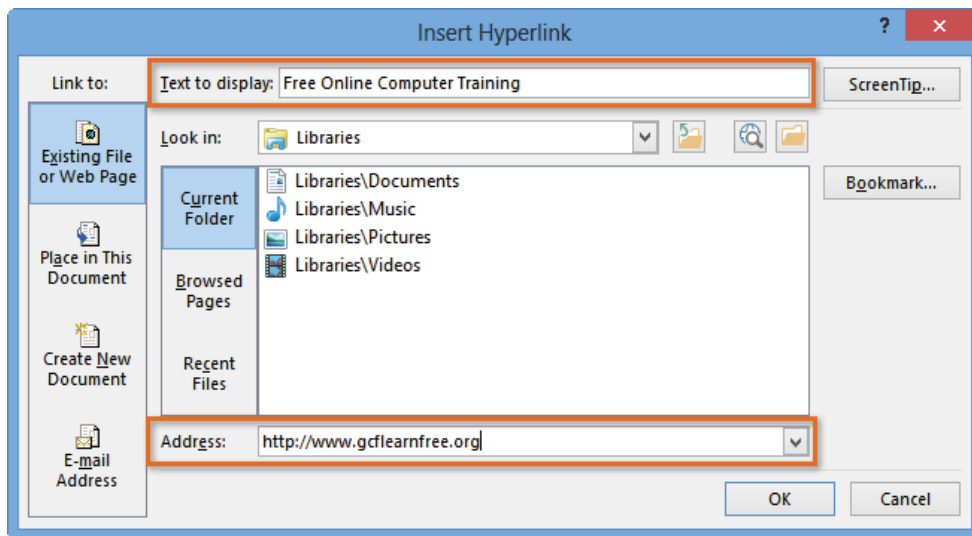

Figure 13.2: Dialog box for inserting Hyperlink

Step4: If you selected text, the words will appear in the **Text to display** field at the top. You can change this text if you want.

b. Creating Hyperlink to another presentation

You can easily link to a specific slide in another presentation. Follow these steps:

Step1: Select the object on the slide that you want to use for the hyperlink.

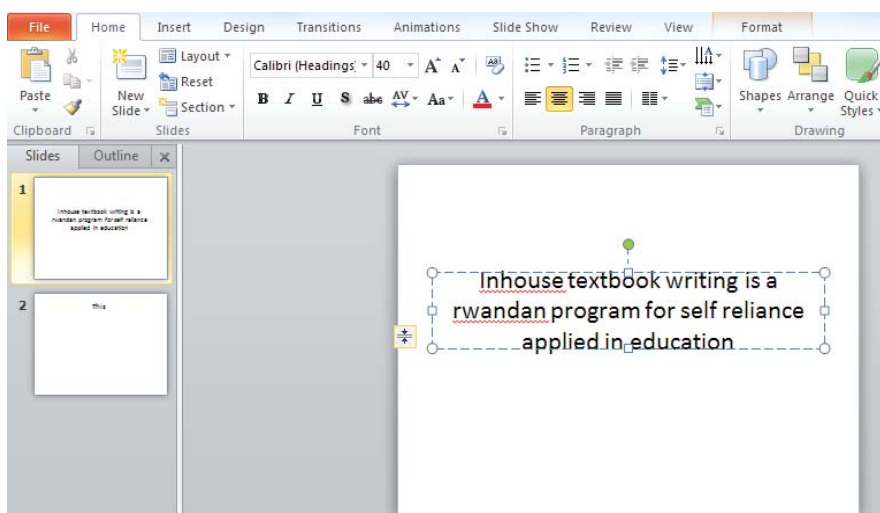

Figure 13.3: Creating Hyperlink to another presentation

Step2: Choose Insert > Hyperlink (2013: Insert tab> Links group> Hyperlink) or press Ctrl-K.

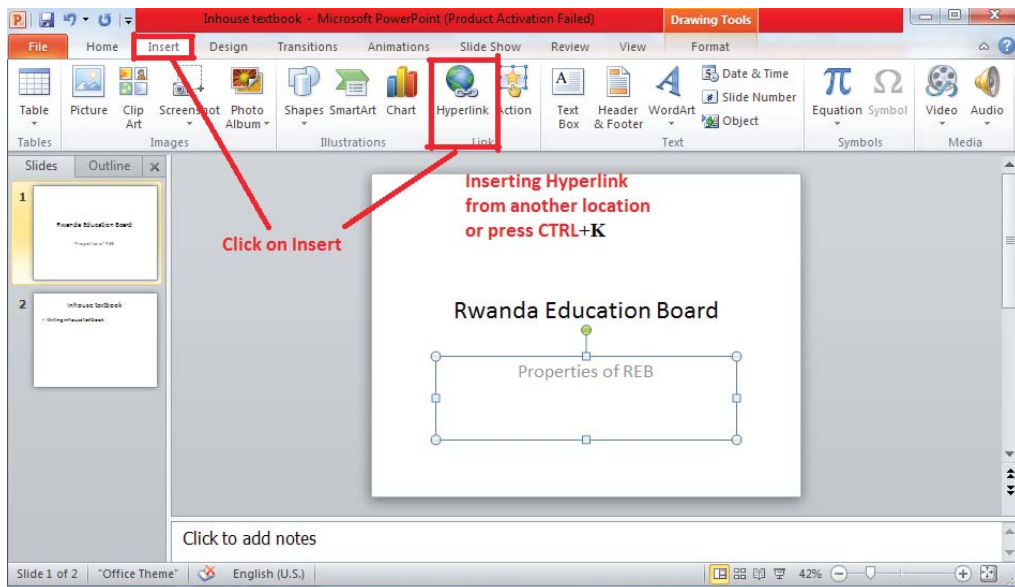

Figure 13.4: Hyperlink Location

Step3: In the insert Hyperlink dialog box, choose Existing File or Web Page from the Link to bar at the left.

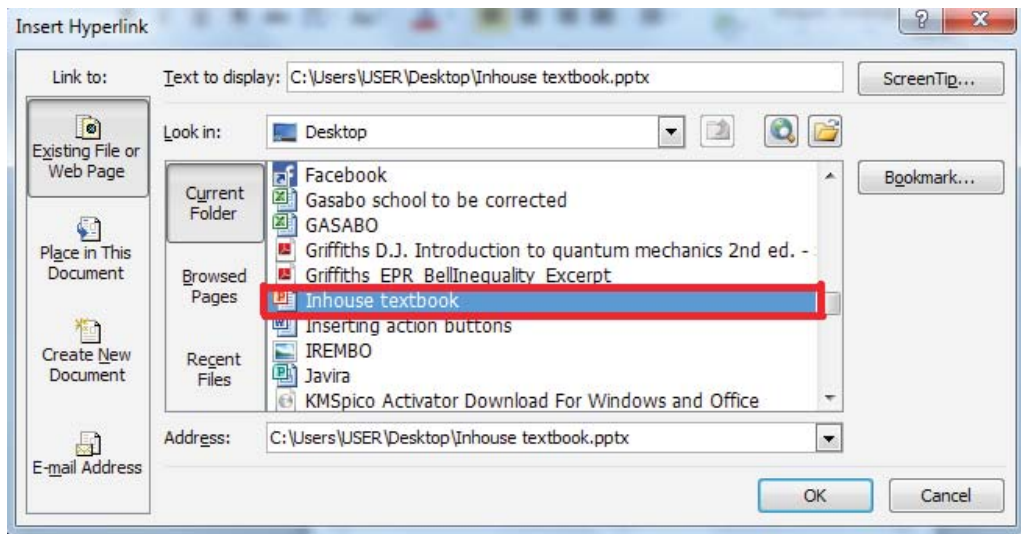

Figure 13.5: Inserting Hyperlink to an existing document

Step4: Click the Bookmark button.

The Select a Place in Document dialog box opens, listing all the slides in the

presentation to which you're linking.

Step5: Select a Place in Document dialog box

Choose the slide you want and click OK.

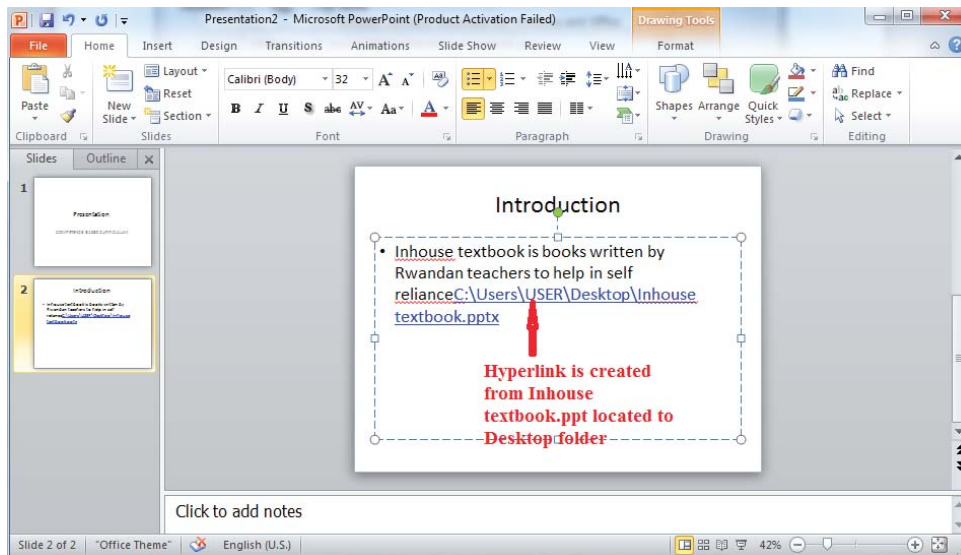

Figure 13.6: Selecting slide to create hyperlink

Note: If your object is an Action Button, the Action Settings dialog box opens. Choose the Hyperlink To option. From the drop-down list, choose Other PowerPoint Presentation. Navigate to the presentation and click OK. The Hyperlink to Slide dialog box opens, which is just like the Select Place in Document dialog box, listing the slides. Choose the one you want and click OK twice.

c. Creating Hyperlink to a file

Step1: Press CTRL+K

Step2: Right-click the selected text or image, then click **Hyperlink**. The **Insert Hyperlink** dialog box will appear.

Step3: On the left side of the dialog box, click Existing File or Webpage.

Click the drop-down arrow to browse for your file.

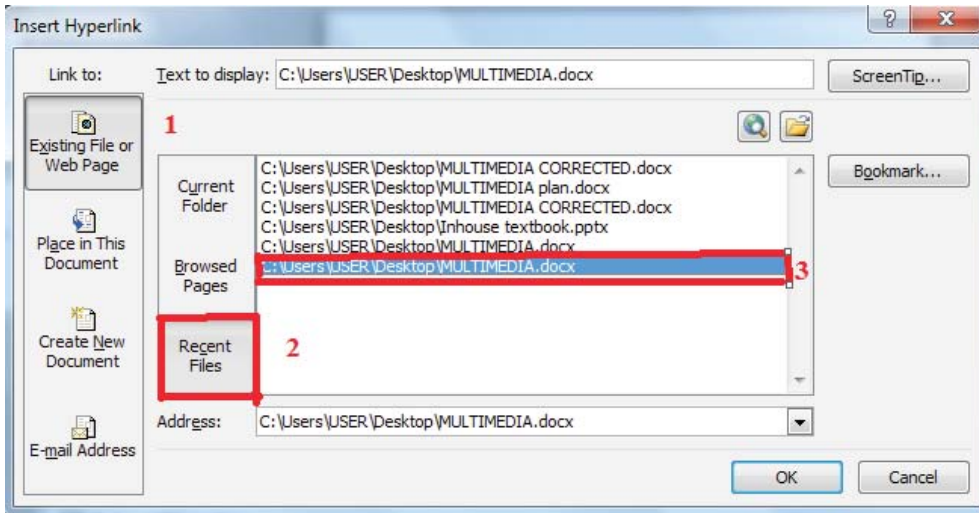

Figure 13.6: Locating existing file

After selecting the desired file, Click OK button

Step4: Desired Hyperlinks prompted

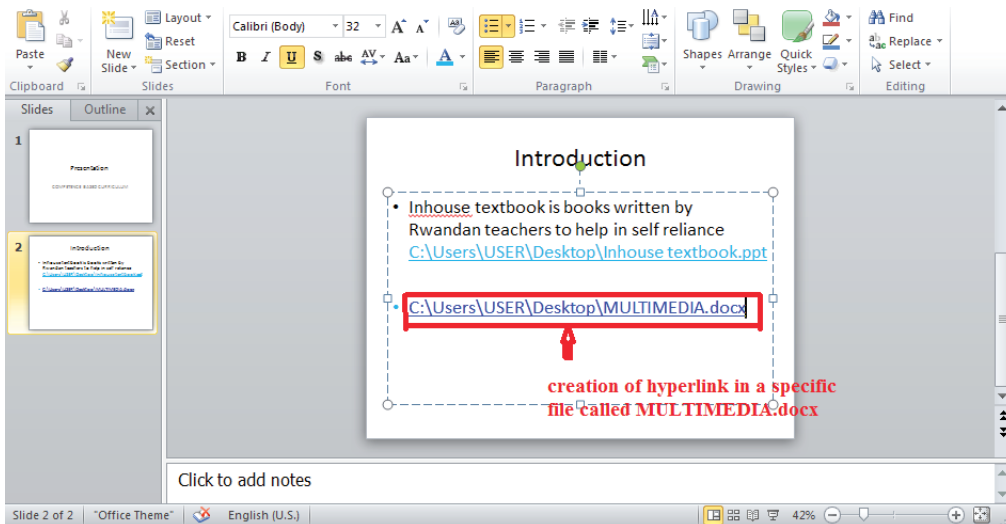

Figure 13.7: Desired Hyperlink prompted

d. Creating a hyperlink to an email address

Step1: Right-click the selected text or image, then click **Hyperlink**.

Step2: The **Insert Hyperlink** dialog box will open.

Step3: On the left side of the dialog box, click **Email Address**.

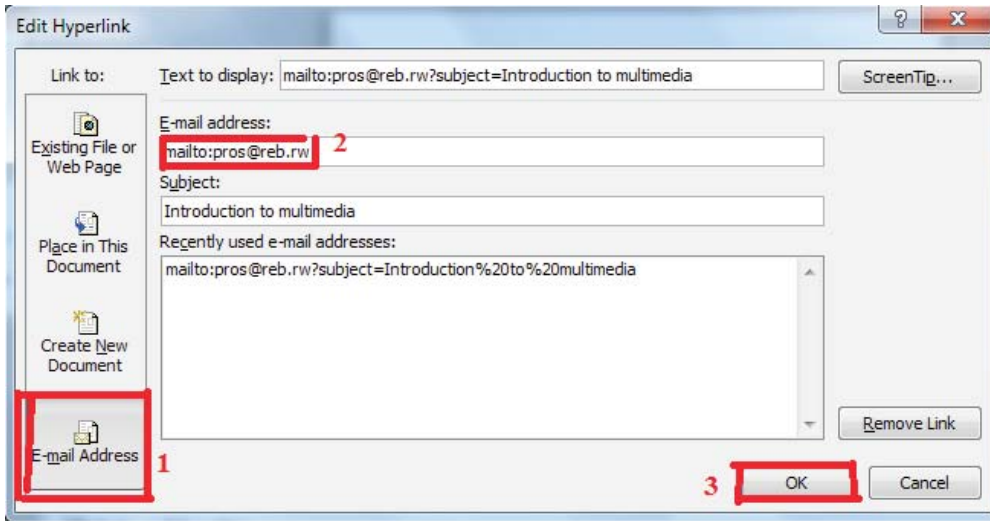

Figure 13.8: Creating Hyperlink to email address

Step4: Type the email address you want to connect to in the **Email Address** box, then click **OK**.

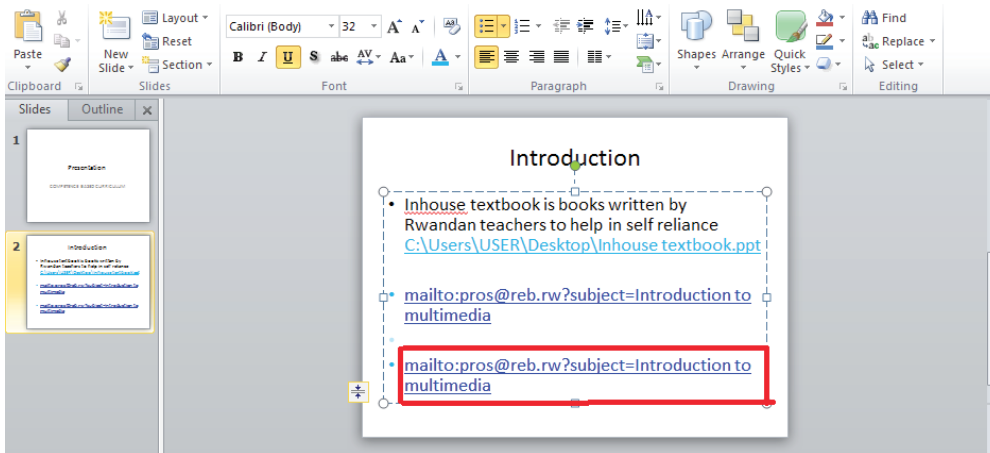

Figure 13.9: Choosing e-mail to be addressed

PowerPoint often recognizes email and web addresses as you type and will format them as hyperlinks automatically after you press the **Enter key** or **spacebar**.

If you plan to display your presentation on a different computer, your hyperlink to another file may not work. You have to make sure that you have a copy of the linked file on the new computer and always it is good to test hyperlinks before giving a presentation.

Application Activity 13.2.

1. In Computer lab, create PowerPoint presentation
2. Create hyperlink in the same document, Create hyperlink to another presentation,
3. Create hyperlink to another file and
4. Create Hyperlink to email address
5. How can you protect your hyperlink created to an email address for not being hacked?

13.3. Creating action buttons

Activity 13.3.

1. What do you understand by Action button in PowerPoint presentation?
2. Discuss different types of action buttons and their roles.
3. In an opened PowerPoint presentation, create an action button.

a. Action Buttons play or stop

Another tool used to connect to a webpage, file, email address, or slide is called **an action button**. **Action buttons** are **built-in button** shapes added to a presentation and set to link to another slide, play a sound, or perform a similar action.

Action buttons can be inserted on one slide at a time, or an action button can be inserted to show up on every slide. The second option can be useful if every slide has to be linked back to a specific slide, like the title page or table of contents.

To insert an action button on one slide:

Step1: Click the Insert tab.

Step2: Click the Shapes command in the Illustrations group. A drop-down menu will appear with the action buttons located at the very bottom.

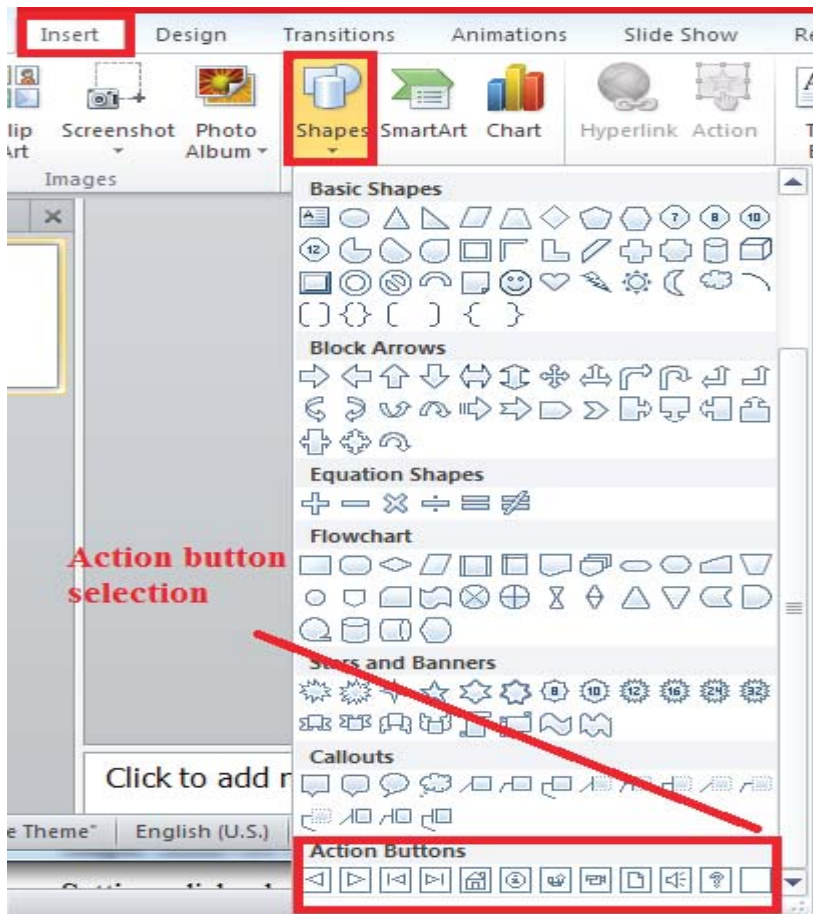

Figure 13.10: Shape command

Step3: Select the desired **action button**.

Step4: Insert the button onto the slide by clicking the desired location. The Action Settings dialog box will appear.

Step5: Select the **Mouse Click** or **Mouse Over** tab. Selecting the **Mouse Click** tab means the action button will perform its action only when clicked. Selecting the **Mouse Over** tab will make the action button perform its action when the mouse is moved over it.

Step6: in the **Action on click** section, select **Hyperlink to:** then click the drop-down arrow and choose an option from the menu.

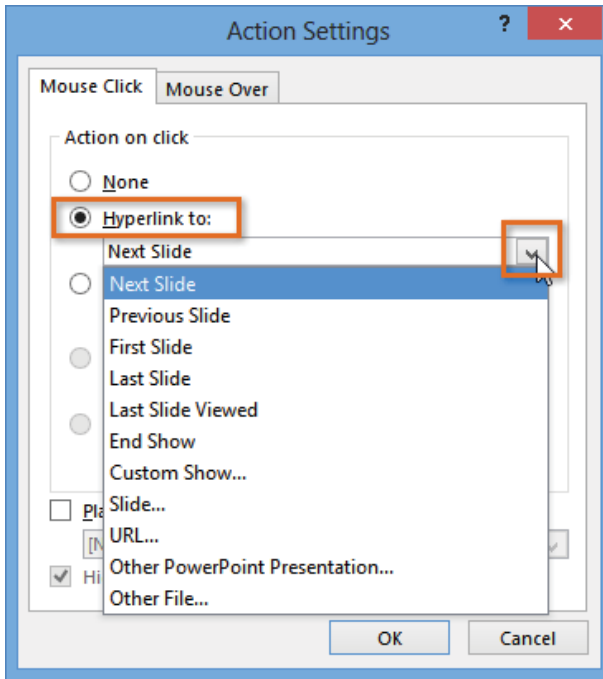

Figure 13.11: Action settings

Step7: Check the **Play Sound** box if you want a sound to play when the action button is clicked. Select a sound from the drop-down menu, or select **other sound** to use a sound file on your computer.

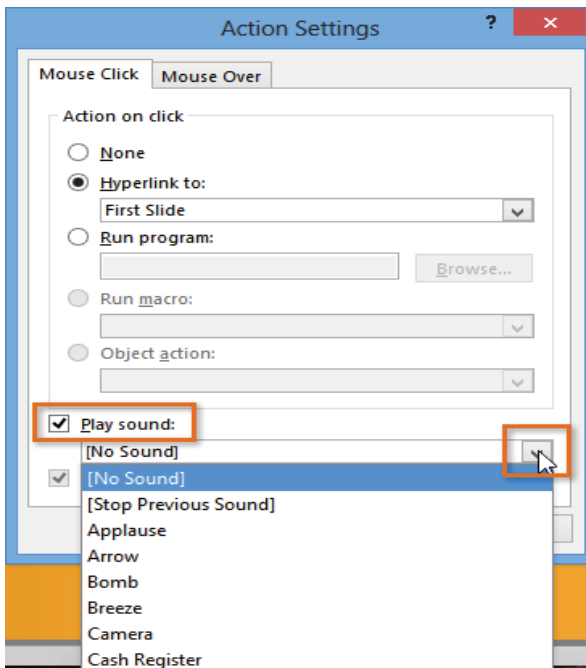

Figure 13.12: Selecting the Play sound

Step8: Click OK.

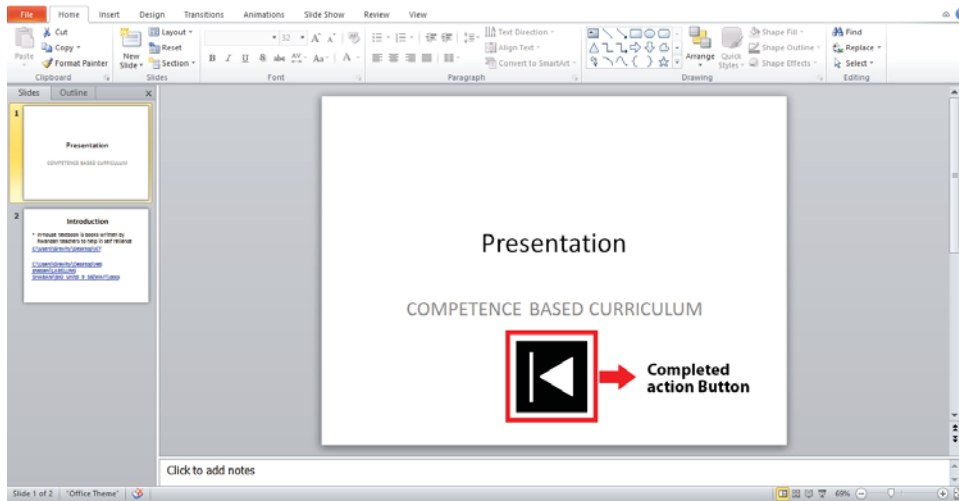

Figure 13.13: Action button for playing

b. Action Button for playing a CD

When you want to play a CD, the following action buttons must take effect, and you need to follow the same process for creating action buttons to create them.

1. Action button for previous media
2. Action button for next media
3. Action button for start or begin or play
4. Action button for end or stop

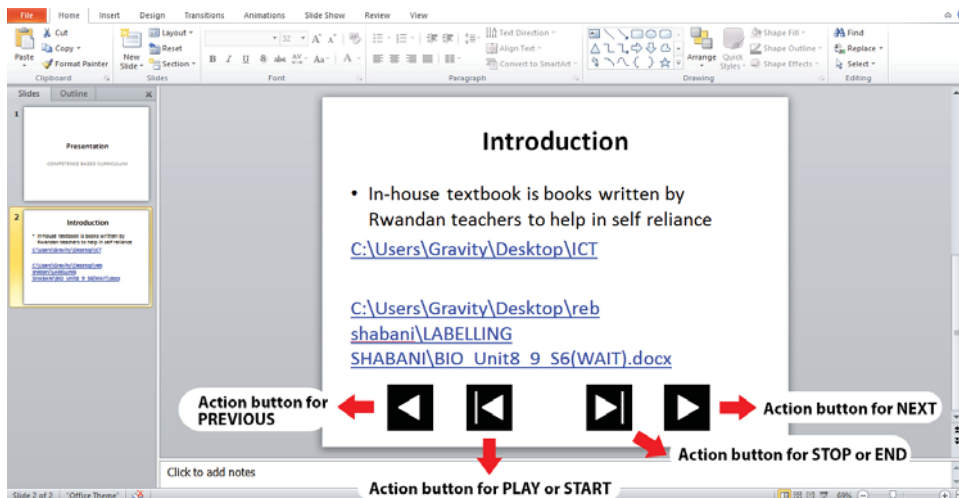

Figure 13.14: Different Action button for playing

Application Activity 13.3.

1. In a created PowerPoint presentation
 - a. Create action button for playing an audio song
 - b. Create action button for next and previous song
2. Create action button for stopping song Tom who is a friend of Antoine is working in video and audio editing. Antoine has a birthday party of his son and he wants to take an audio sound of each event. Tom told him that he will do it as an expert and a friend for free, what are the advantages for Antoine.
3. In a slide, create an action button to play a movie that you selected.

13.4. Digital Audio recording and Editing

Activity 13.4.

1. What is an audio sound?
2. Discuss the format of an audio sound that you may know.
3. What do you think about audio sound recording?
4. Discuss which software can edit an audio sound and how?

An audio file format is a file format for storing audio. There are various audio file formats and they all encode audio data in different ways. There are two different approaches; compressed or non-compressed formats.

1. Uncompressed formats

Uncompressed audio formats are always lossless, meaning that all original audio information is retained. If there is unlimited storage space, an uncompressed - or lossless file format is the way to go. While working with audio (ie making music), also stick with uncompressed formats.

There are two main format options here, AIFF and WAV. Neither of these requires a license to use.

WAV is the most recommended as it is more widely used and supported.

Uncompressed audio in CD-quality (sample rate of 44.1 kHz and a bit depth of 16 bits) takes about 10MB for one minute of stereo audio.

1. Compressed formats

Compressed audio formats are primarily lossy formats, meaning that audio information is reduced. If an audio needs to be distributed over the internet, a compressed format is the best option.

Although MP3 is very popular but it does require a license, even for audio distribution. The existing and most used audio formats are:

- a. **3GP and 3G2, (3GPP file format)** is a **multimedia container format** defined by the Third Generation Partnership Project (3GPP) which is multimedia services. It is used on 3G mobile phones but can also be played on some 2G and 4G phones.
- b. **MP3 (MPEG-1 Audio Layer-3)** is a standard technology and format for compressing a sound sequence into a very small file (about one-twelfth the size of the original file) while preserving the original level of sound quality when it is played. MP3 provides near CD quality audio.
- c. **WAVE or WAV** format is the short form of the Wave Audio File Format (rarely referred to as the audio for Windows). WAV format is compatible with Windows, Macintosh or Linux. Despite the fact that the WAV file can hold compressed audio, the most common use is to store it just as an uncompressed audio in linear PCM (LPCM).

13.4.1 Use of different tools to record sound

a. Microphone

A **microphone** is a device that captures audio by converting sound waves into an electrical signal. A microphone placement technique is how microphones are positioned in relation to the instrument or voice. Technique is the general strategy used in microphone placement. The location of the microphones while recording will make a big difference in the got sound. Microphones can just be plunked down and recorded, but a little experimentation can go a long way in getting a better sound.

Process to record sound using Microphone

The process to record sound depends on the version of MS Windows used. Up to the MS Windows 7, follow the next steps. The steps will be almost similar if you use new versions of MS Windows.

Step1: Click on the Start button, and then click **All Programs > Accessories > Entertainment > Volume Control** to display the Volume Control box.

Step2: Otherwise, use your right mouse button to click on the Volume icon  on your taskbar. Then, select “Open Volume Control.”

step3: In the Volume Control box, set the Volume Control Balance **1** at least to a middle level. Also, make sure that “Mute all” **2** is not selected.

Step4: In the same Volume Control box, view the Microphone Balance.

step5: If Microphone balance is not displayed, click on **Options > Properties**. In the Show the Following Volume Controls field, select “Microphone” and click **OK**.

Step6: Set the Microphone balance at a middle level and make sure the Mute box **3** is **not** selected.

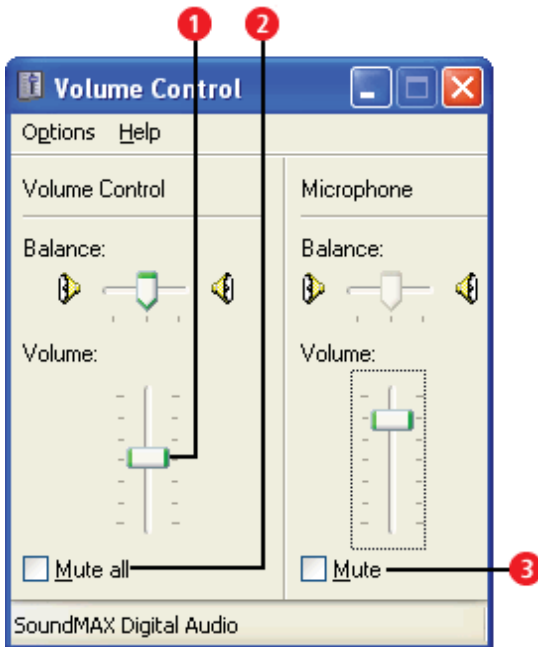

Screen 1: Volume Control Box

We recommend that you check the recording settings on your computer.

Step7: From the same Volume Control box, click on **Options > Properties** and select “Recording” **4**. Make sure “Microphone” **5** is checked and click **OK**.

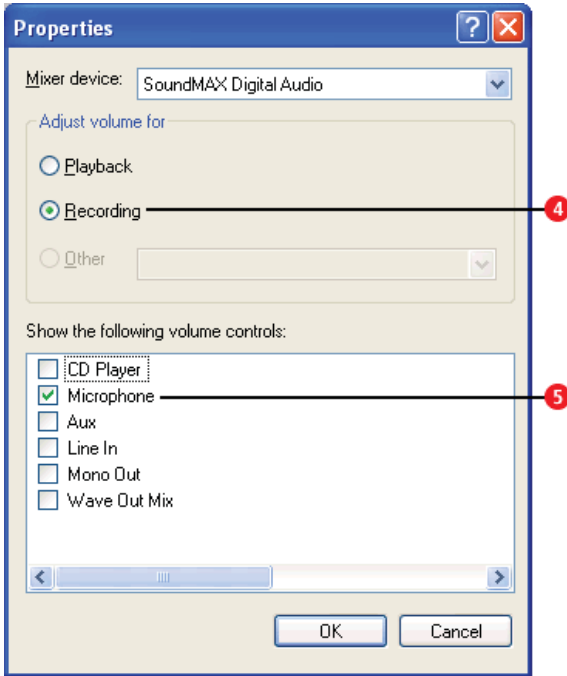

Screen 2: Volume Control Properties

Step8: The Recording Control screen appears when you click **OK** in the screen above. Make sure the recording volume is set at a middle level **6** and “Select” is checked **7**.

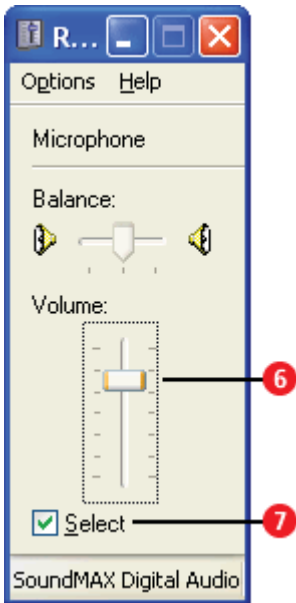

Screen 3: Recording Control Screen

Application Activity 13.4.

1. What is the best audio format recommended? Explain why.
2. A part from the musical instruments described above, explain other five musical instruments used to deal with sound.
3. In Rwandan culture, describe the elements which can be linked by this topic to manage sounds?

13.4.2 Editing Audio Sound

Activity 13.5.

1. What do you think about audio editing?
2. Discuss software used when editing audio sound.
3. Explain what are the processes to edit audio sound?

Audio editing is the process of manipulating audio to alter length, speed, and volume or to create additional versions such as loops. Audio editing is almost always done using a computer and audio editing software but used to be done with analogue tape and razor blades by splicing and taping in a pre-digital world.

a. Fade-In and Fade-Out

In audio engineering, a **fade** is a gradual increase or decrease in the level of an audio signal. The term can also be used for film cinematography or theatre lighting in much the same way (see fade- filmmaking and fade- lighting).

A recorded song may be gradually reduced to silence at its end (fade-out), or may gradually increase from silence at the beginning (**fade-in**).

As there are many software applications used in multimedia for sound editing and management, in this section, let us use Audacity. **Audacity** is a free and open-sourcedigital audio editor and recording application software, available for Windows, macOS/OS X and Unix-like operating systems. Audacity was started in the fall of 1999 by Dominic Mazzoni and Roger Dannenberg at Carnegie Mellon University and was released on May 28, 2000 as version 0.8.

As of October 10, 2011, it was the 11th most popular download from SourceForge,

with 76.5 million downloads. Audacity won the SourceForge 2007 and 2009 Community Choice Award for Best Project for Multimedia. In March 2015, hosting was moved to FossHub and by February 21, 2017 it had exceeded 51.8 million downloads there. It is under the terms of the GNU General Public License.

Steps to Fade In/Out

Step1: Open Audacity software

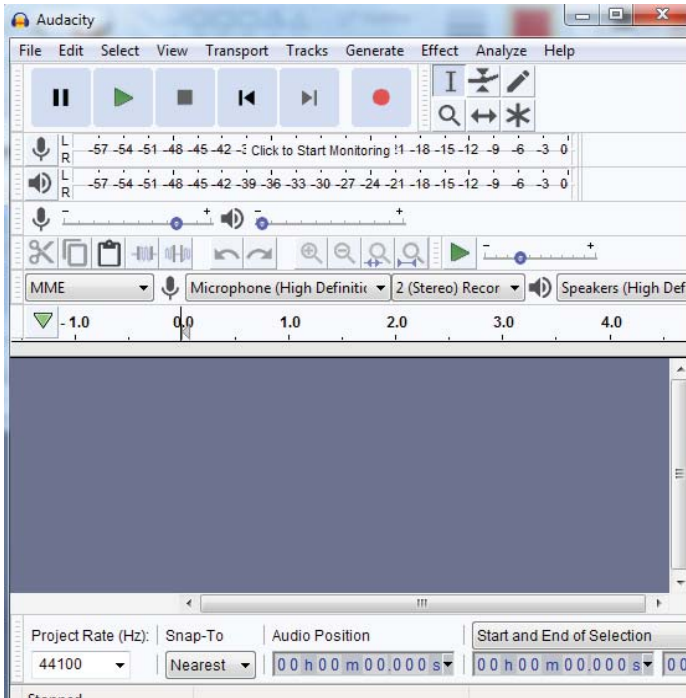

Figure 13.15: Opened audacity software

Step2: Go to file to import audio sound to Fade In or press CTRL+SHIFT+ I

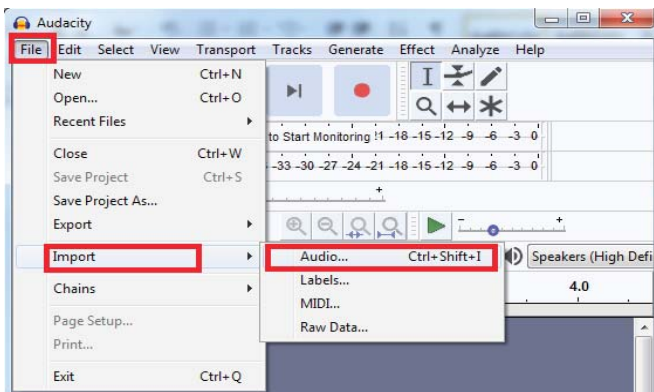

Figure 13.16: Importing audio sound

Step3: Import Audio Sound to Fade In or to Fade Out, Then Click **Open**

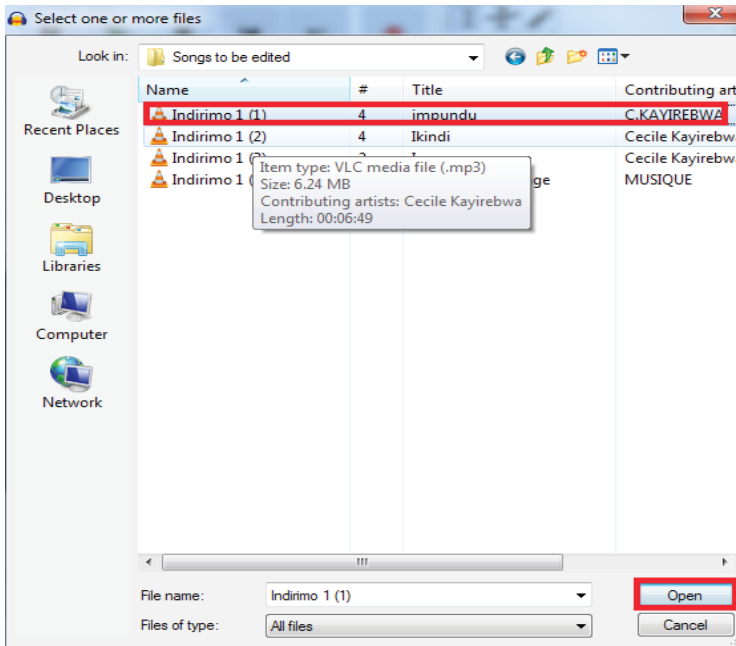

Figure 13.17: Dialog box for audio to be fade

Step4: Select the Sound to Fade in or Out by Pressing CTRL+A

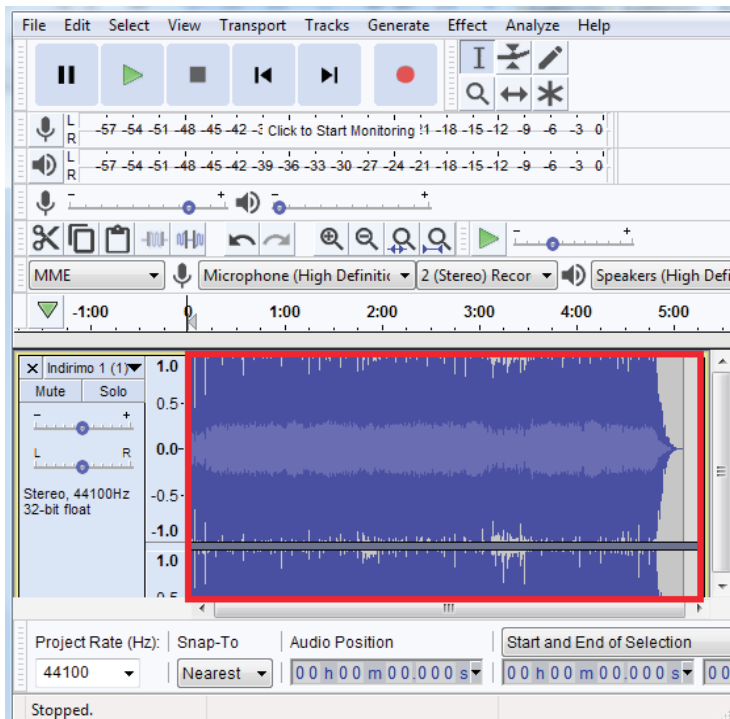

Figure13.18: Selecting the region to be fade

Step 4: Select Effect and click on Fade In/Out

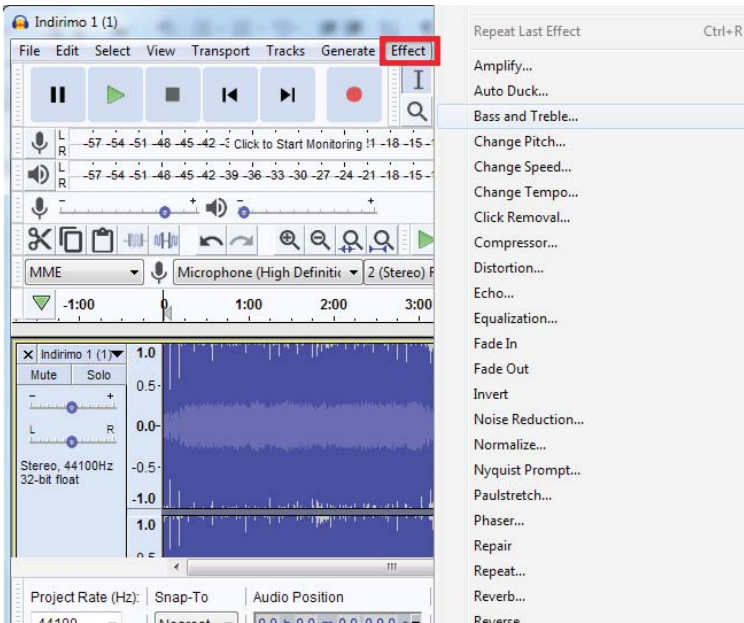
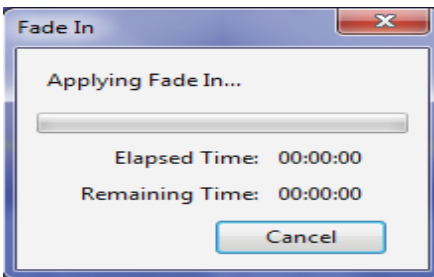

Figure 13.19: Opening Effect

Step5: After selecting effect, you can Fade In/Out depending on what you want to do. The below figure shows the process of sound fade in when using audacity software.



The figure below shows the audio song “**INDIRIMBO 1(1)**” after being Faded In

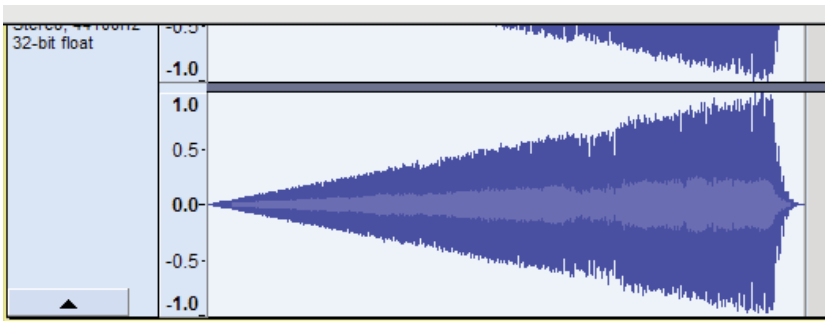
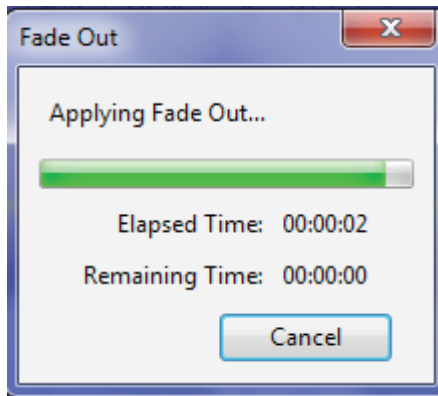

Figure13.20: Fade in image

The figure below shows the process of FADE Out, when an audio song is being Faded out



After Fading Out, the figure below shows audio songs after being Fade out.

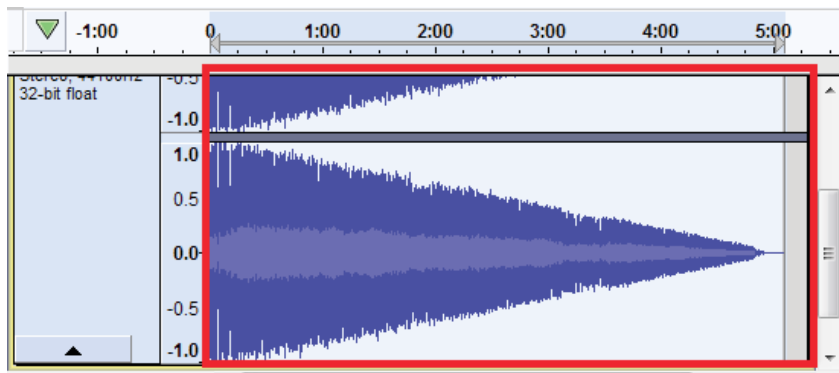

Figure13.20: Fade out image

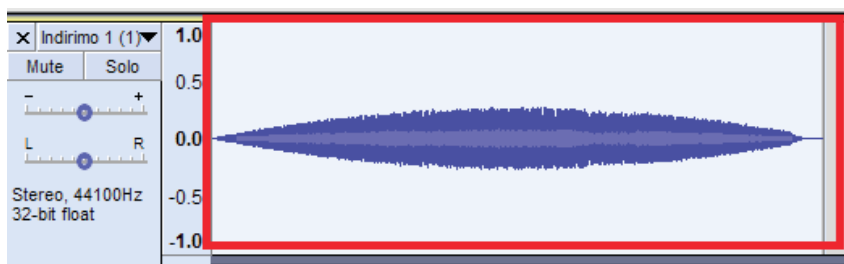

Figure13.21: Fade in/ out image

b. Crop

To crop audio is to make it start where you want to be started and end at the point you wish to be ended. The following are the steps in adobe flash player to crop an audio sound.

Step1: Importing audio in audacity software, and select the area to crop from to where you don't want to be played.

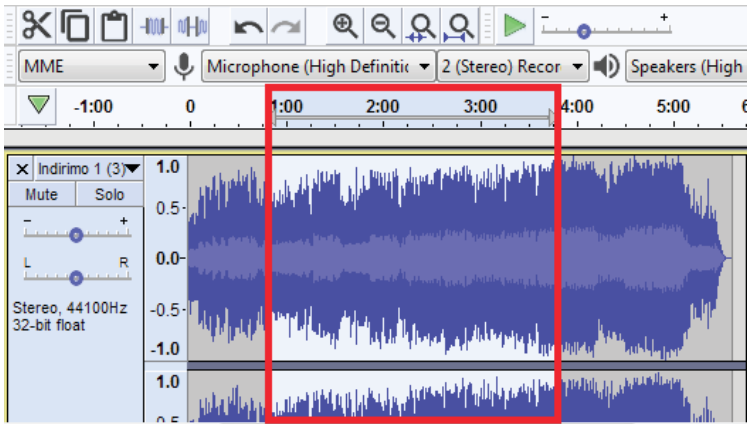

Figure13.22: Selecting region to crop

Step2: Click on cut sign, the unwanted area will be removed and you remain with the wanted part.

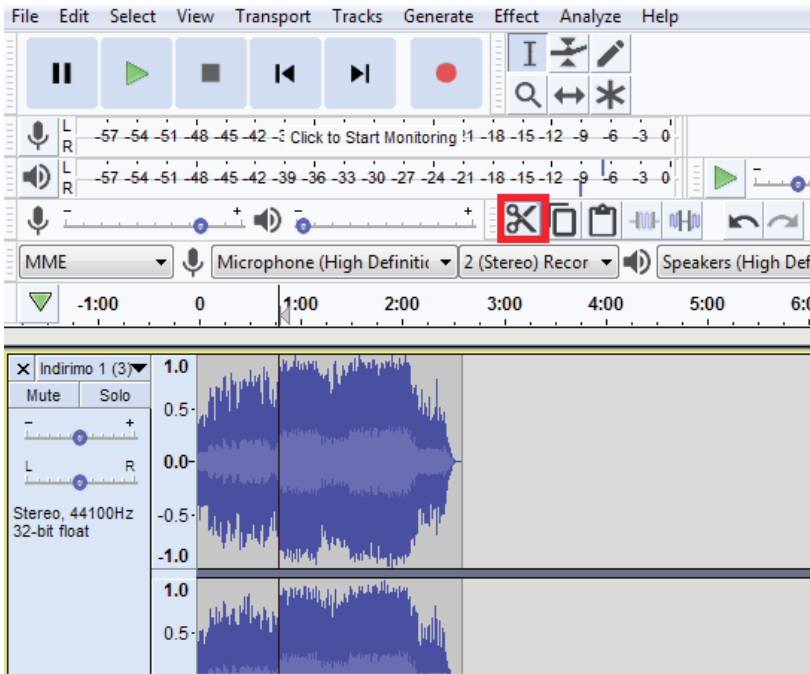

Figure13.23: After cropping image

c. Echo

Echo is a reflection of **sound** that arrives at the listener with a delay after the direct **sound**. The delay is proportional to the distance of the reflecting surface from the source and the listener.

Here is how you can have echo in your audio sound:

Step 1: In audacity software, click on Echo from Effect

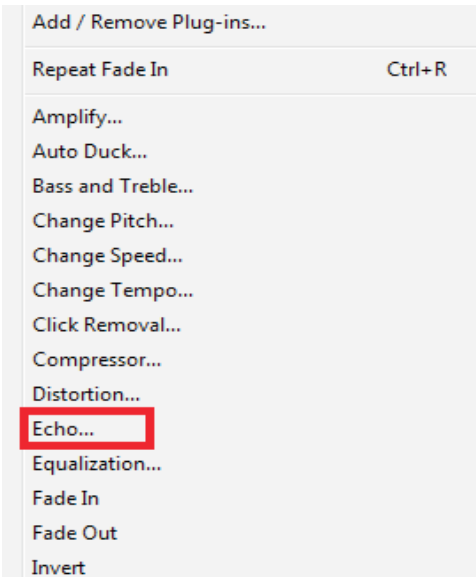

Step2: Set the time of reflection, then Click **OK**

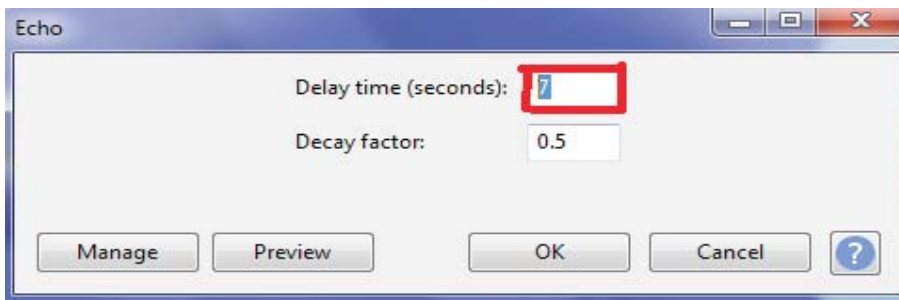

Figure13.24: Setting time to echo

d. Increasing or decreasing volume,

Open the audio file in Audacity. Remember, do not make trim changes in Audacity. On the left side of the screen is the gain (in dB), which can be adjusted to increase or decrease the volume of the recording.

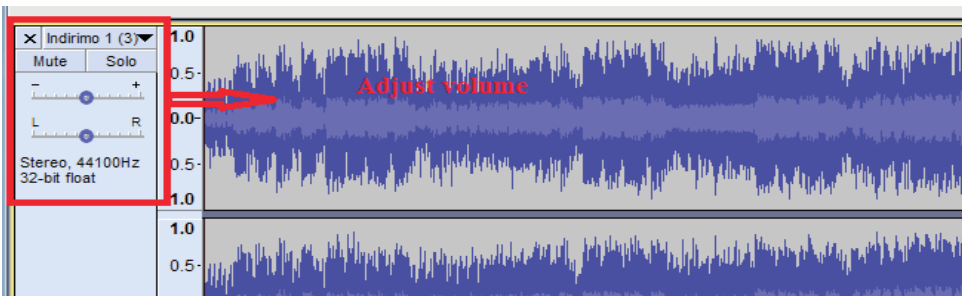

Figure13.25: Fade in image

Once you have adjusted the volume of the recording to your liking, save the audio file in its original location. When you reopen the file in Proclaim the audio level changes will be reflected.

e. Reducing noise

Step1: In imported sound Audacity Software, Select a Region of Pure Noise

Hopefully you have a good sample area, but Audacity can do amazing things even if only with a few seconds of data. You can see in the bottom track a grey area that is selected as our noise profile.

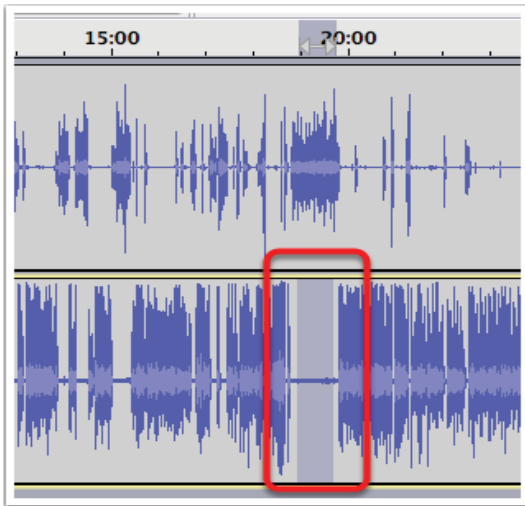

Step2: Select Noise Reduction

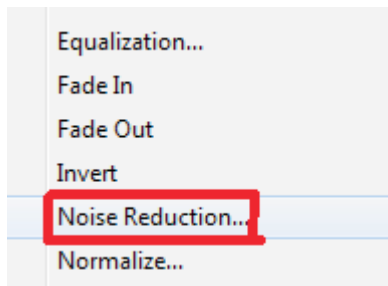

Figure13.26: Noise reduction

Step3: Click Get Noise Profile

When you click this, the window will go away and it won't look like Audacity did anything at all, but in fact you've just told it, "This is what noise looks like".

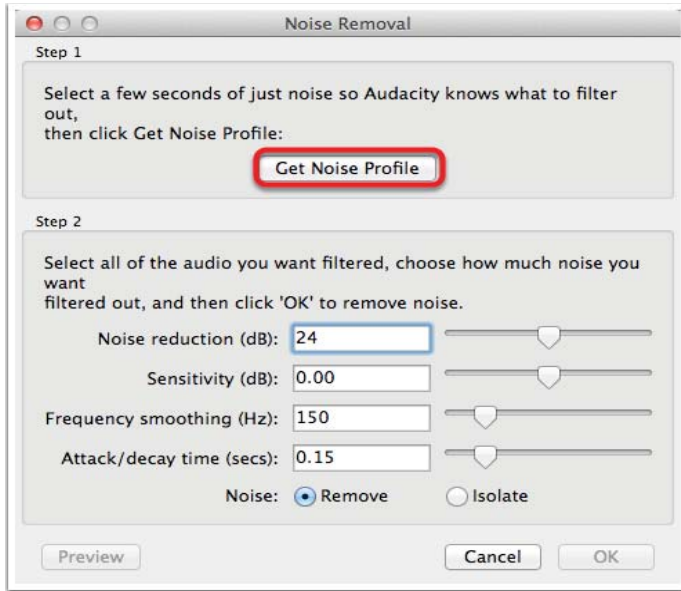

Figure13.27: Setting the number of Decibels

Select the Entire Track

Select entire track, or all of the area where is the noise to be removed. You should see a yellow border around the track if you've selected it properly.

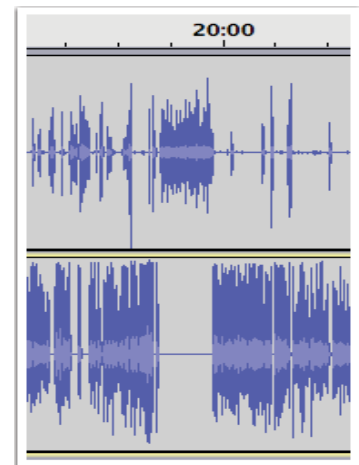
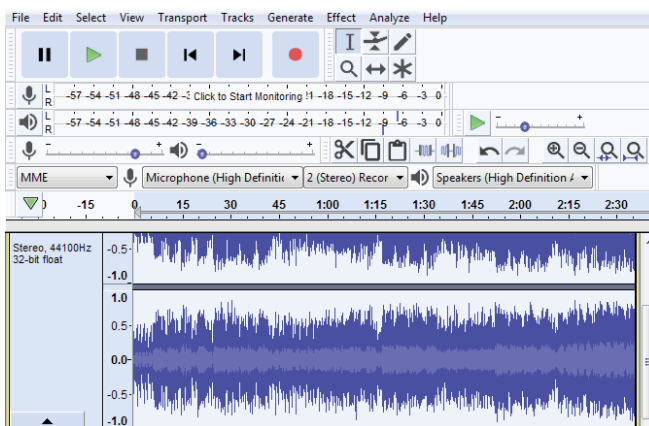

Figure13.28: Image after noise reduction

f. Humming

After removing noise vocals, you need to select all region of sound to remove again noise; in that case you will find the sound is humming.

Step1: Select the region where is the hum, Go to effect and select Noise reduction then click on Get Noise Profile, the image below will be produced

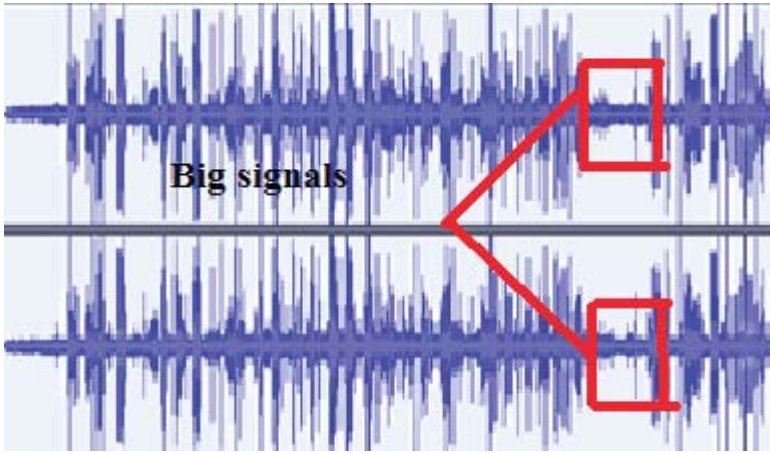

Figure13.29: Image after removing vocals

Step2: Select the region of the whole song, go to effect and Select Noise Reduction the click **OK**, the figure above will be produced which is different from the above figure.

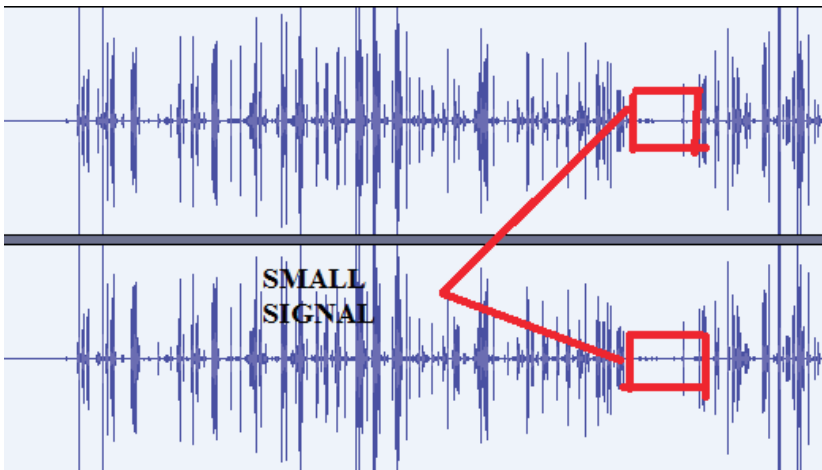

Figure13.30: Image after humming

g. Remove vocal

Go to Effect, Amplify and choose a negative level value, then click **OK**. You want to play around with the exact values until you find one that works best for your specific track.

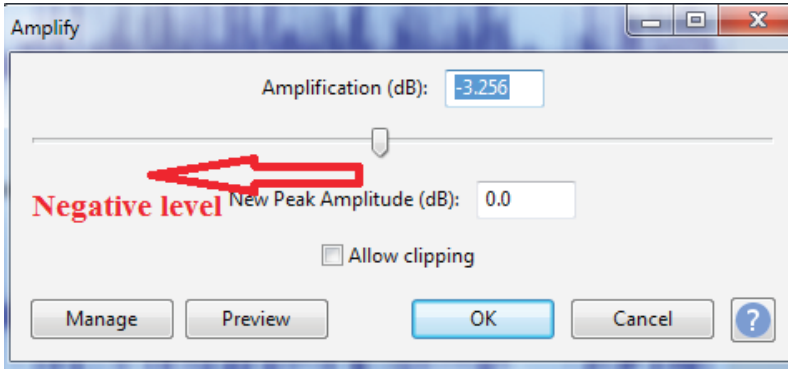

Figure13.31: Choosing negative level

h. Equalizer

Equalization is the process of adjusting the balance between frequency components within an electronic signal. The most well-known use of equalization is in sound recording and reproduction but there are many other applications in electronics and telecommunications. The circuit or equipment used to achieve equalization is called an equalizer. To do this, follow these steps.

Step1: With imported sound, select Effect and Click on Equalization

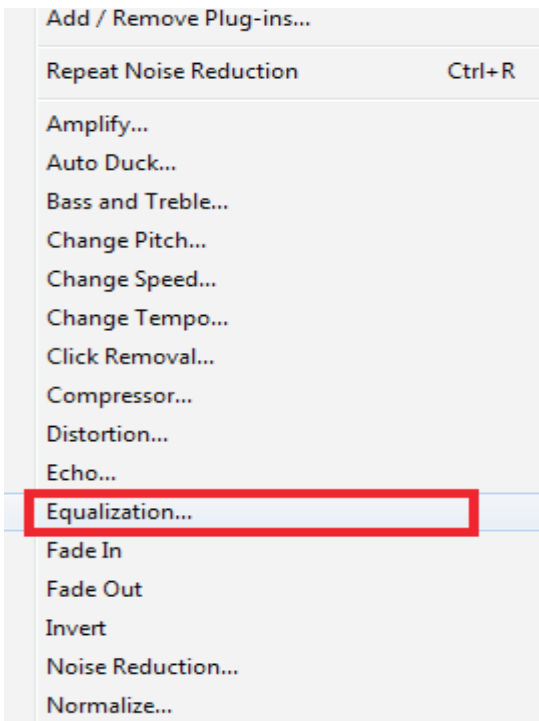

Figure13.32: Click on equalization

Step2: Set Equalizer to the needed Decibel

After clicking on Equalization, equalization table will appear, measured in decibel, the line in green was located at the level of 0dB, then you drag to the appropriate equalization you want to be, here it is dragged from 0dB to 15dB

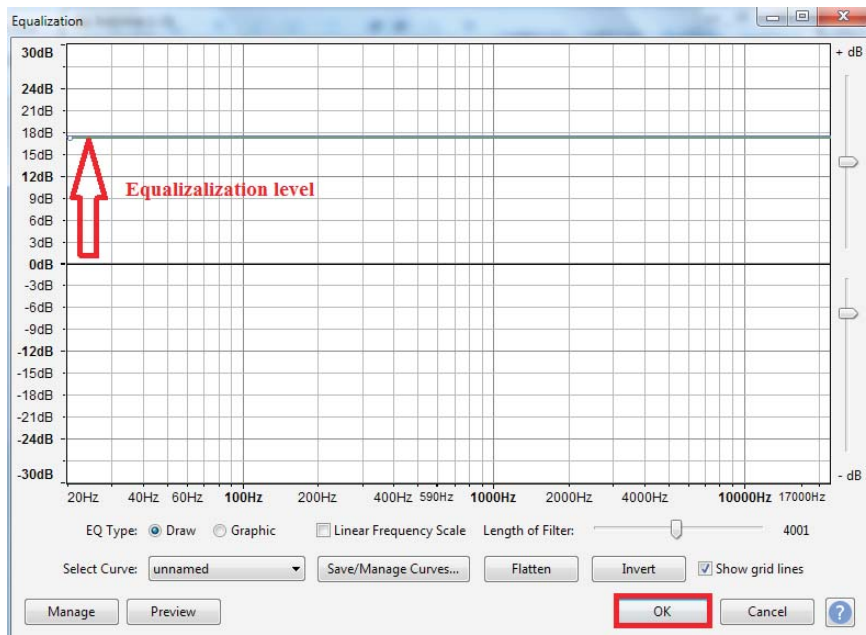

Figure13.33: Equalization from 0 to 18 dB

Application Activity 13.5.

1. Using audacity software that you have installed on your computer, do the following:
 - a. Use a smartphone/ digital camera, etc and record a sound
 - b. Import the recorded sound and do all necessary operation to be an audible or quality sound such as crop Fade In/out, remove vocals, remove noise
 - c. Create sound humming
 - d. Set different Decibels to create equalization.

13.4. Digital Video recording and editing

Activity 13.6.

1. In group of five students, discuss different video formats and software to edit videos
2. What is the preparation required to take a video that may be displayed in your classroom?

13.4.1 Various Video format

A video **file format** is a type of file format for storing digital video data on a computer system. Video is almost always stored in compressed form to reduce the file size.

a. Audio Video Interleave (.avi)

Audio Video Interleave known by its initials AVI, is a multimedia container format introduced by Microsoft in November 1992 as part of its **Video** for Windows software. AVI files can contain both **audio** and **video** data in a file container that allows synchronous **audio** with **video** playback Flash Video (.flv, .swf)

b. .M4V and .MP4

.m4v and .mp4 are very similar and are both part of MPEG-4 which was based on the Quicktime file format. .m4v was created by Apple as an extension of MPEG-4 with the option of proprietary Apple DRM to keep their files from playing on non-apple devices.

13.4.2 Digital video Recording

A **digital video recorder (DVR)** is a consumer electronics device designed for recording video in a digital format within a mass storage device such as USB flash drive, hard disk drive or any other storage device. There are many software to manage and edit a digital video. Some are proprietary while others are Open Source software.

Set up your recording environment

With Snagit (Snagit is a screenshot program that captures video display and audio output. Originally for the Microsoft Windows operating systems, recent versions have also been available for macOS, but with fewer features.), it doesn't take long

to create great videos of any computer-related process. To begin, close or minimize any programs not involved in the process, especially ones that might trigger alerts or popups. Then, open the programs you want to record and arrange them on your screen. The steps to record an audio are the Following.

a. Launch Snagit

Open Snagit and select the video tab. Start with your webcam on if you want to explain what your video will demonstrate or give it a personal touch.

b. Prepare to record

Write down a list of the key talking points or things you want to be sure to include in your video. It won't take long, and will be helpful to reference when you're recording. With your talking points in hand, click the capture button in Snagit, and select part of the screen to record.

c. Make a test recording

Check that microphone audio recording is on, and system audio (the noises that come from your computer) is on if you need it in your video. Click record to do a quick test. While recording, go through a couple of the steps of your process. Then, stop the test recording and play it back to make sure everything worked the way it should.

d. Record your video

Once your test recording looks and sounds the way you want it, you're ready to record your video. Click the Capture button, select the recording area, and click record. The countdown will play and then you can talk through your entire process.

If you make a mistake or stumble over a portion, instead of restarting the recording, reset to a point in the process just before the mistake and go from there. You can remove mistakes later.

e. Review your video

When you are finished, stop your recording. The video is brought into the software editor, where you can watch it and cut out any mistakes.

f. Share your video

Use the share menu to save your final video to your computer, or send it to Screencast.com, Youtube, or Google Drive for immediate sharing.

13.4.3 Digital video editing

a. Video editing

Video editing is the process of manipulating and rearranging **video** shots to create a new work. **Editing** is usually considered being one part of the post production process.

Video clips are short **clips** of **video**, usually part of a longer recording. The term is also more loosely used to mean any short **video** less than the length of a traditional television program. The steps are as follow:

Step1: Select Edit, New Symbol then press **OK**

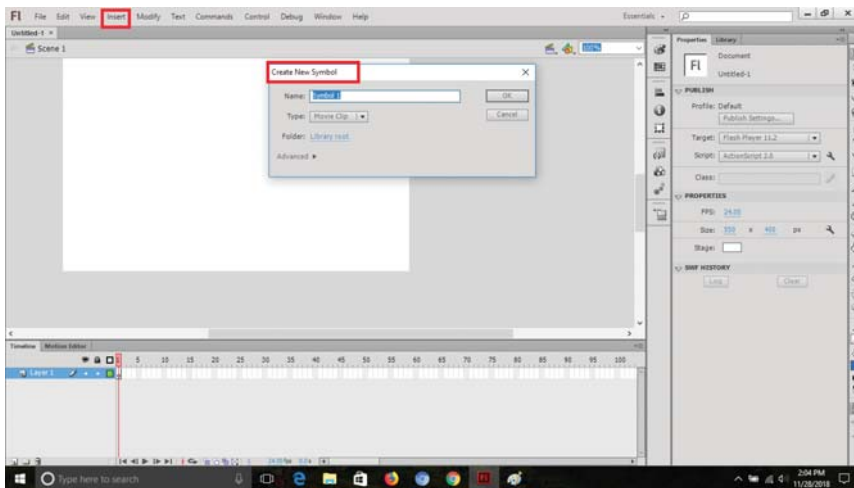

Figure 13.34: Selecting Edit and New symbol

Step2: Import an image from the Library, and place it on the clip background

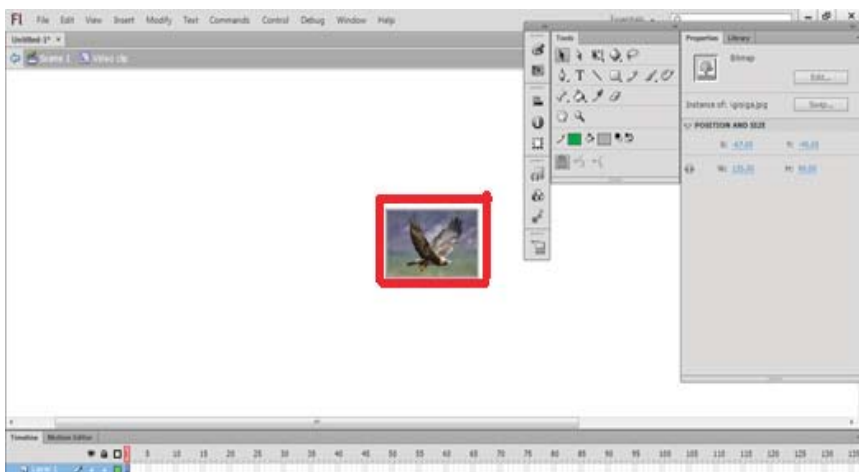

Figure 13.35: Importing image

Step3: Press **CTRL +B**, to highlight the background of animated image for being edited using different tools.

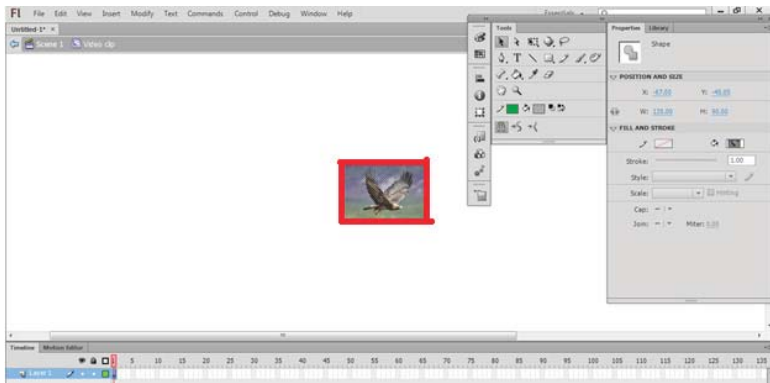

Figure 13.36: Highlighting the background of animated image

Step4: Use different tools to do animation of the imported image in the background in different frames chosen.

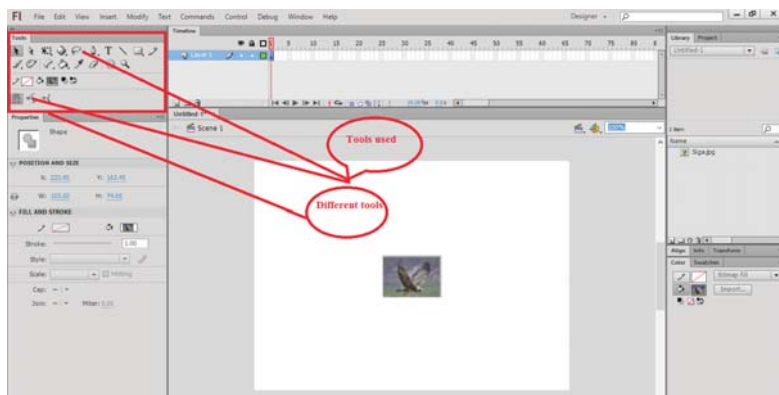

Figure 13.37: Tools used to edit image

Step5: Select all Frames and right click to Copy them to the next frames

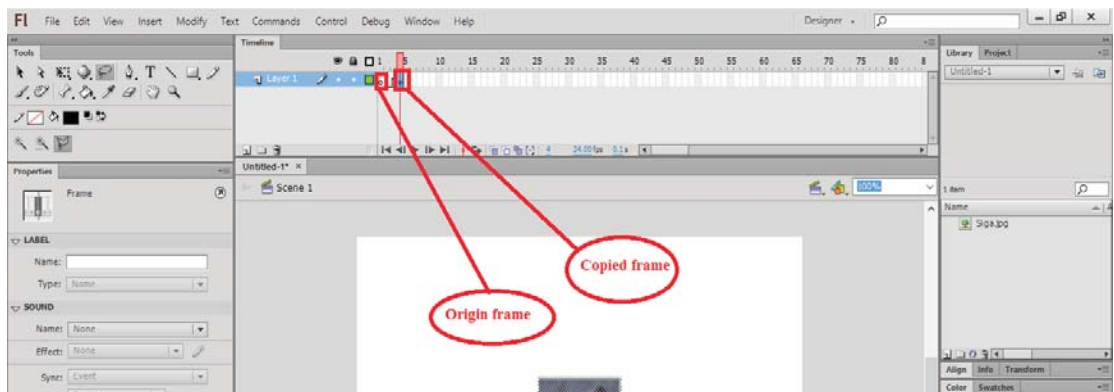

Figure 13.38: Copying frame to another

Step6: Select all frames and right click then press to **Reverse frames** for reversing the created frames.

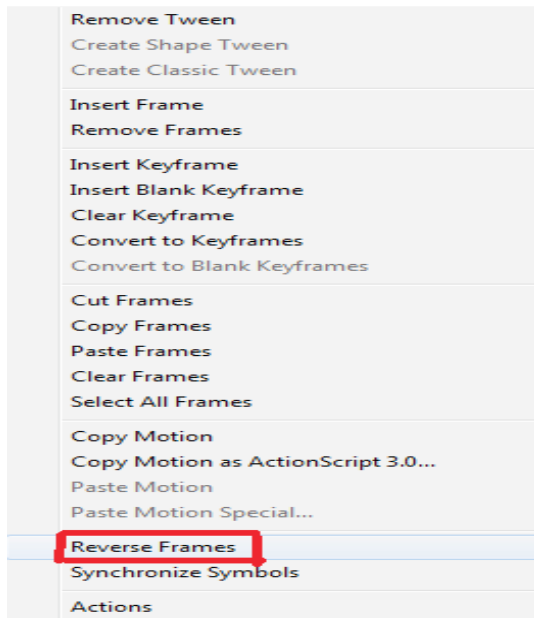

Figure 13.39: Reversing frames

Step7: Click **Scene1** to come back to scene one and import another image

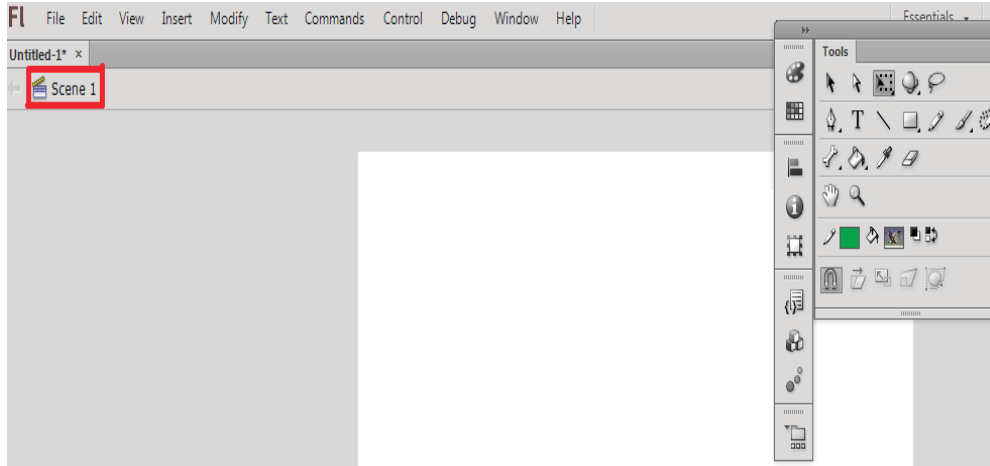

Figure 13.40: Importing another image

Step8: Resizing the image using free transform tool and zoom in and out depending on the desired motion.

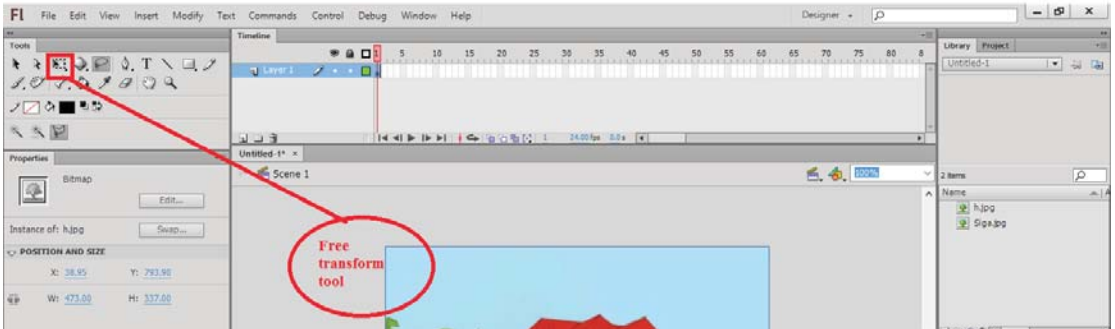

Figure 13.41: Using free transform to resize an imported image

Step 9: Select Frames and Right click to create **Classic tween**, here 60 is used as frame and Press F6, to resize the image

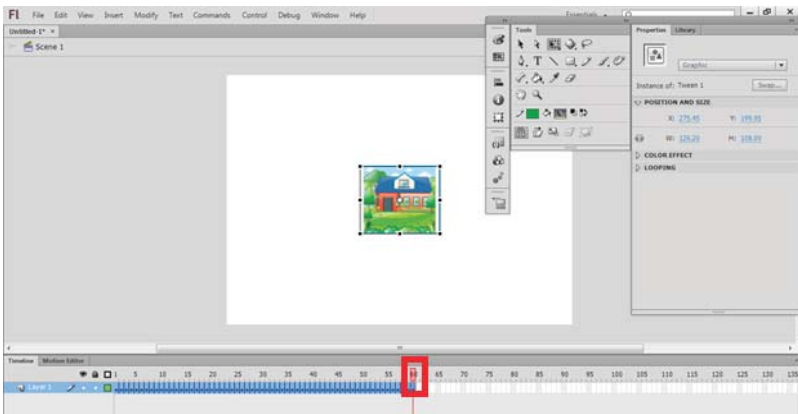

Figure 13.42: Classic tween creation

Step10: Press **CTRL +ENTER** to display animation to the level of 60 frames

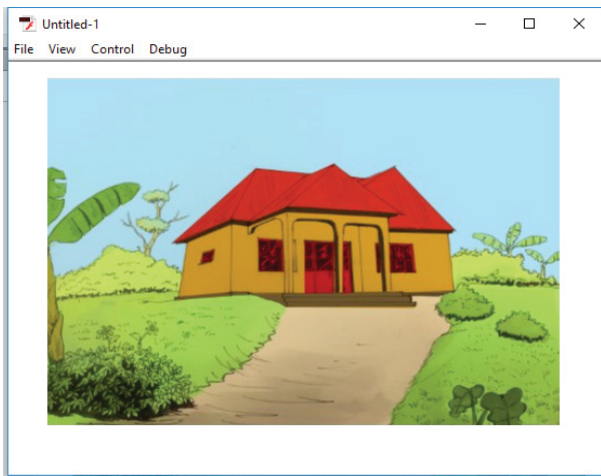

Figure 13.42: Displaying animation

Step 11: Create new Layer, and go to windows then click on Library

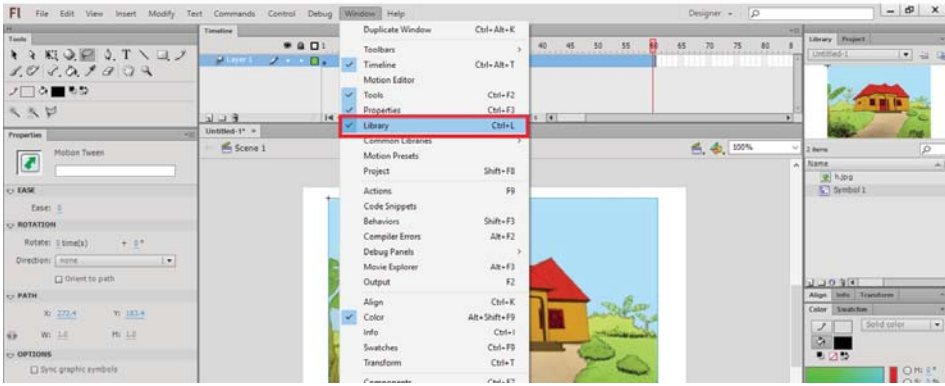

Figure 13.43: Selecting Library

Step12: Insert movie on Layer two by dragging Layer 1 to Layer 2

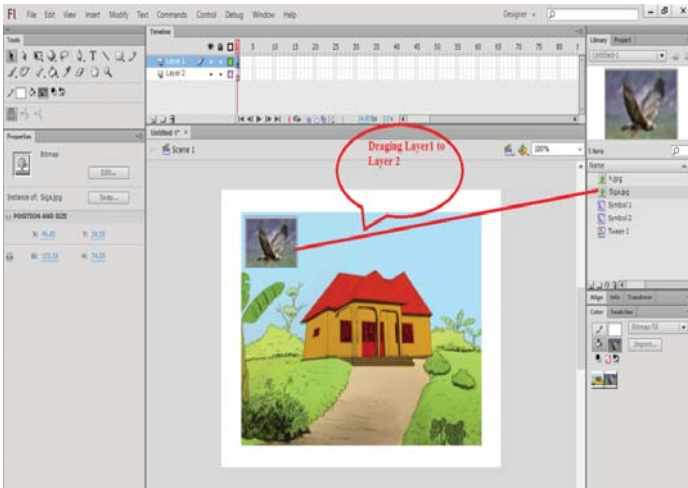

Figure 13.44: Dragging Layer 1 to Layer 2

Step13: On Layer Two Create Classic tween, by selecting frame 60

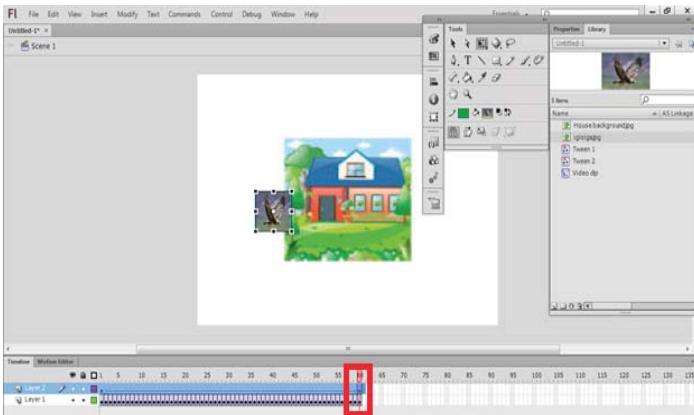

Figure 13.45: Classic tween creation

Step14: Change moving position and Press CTRL+ ENTER to review the clip

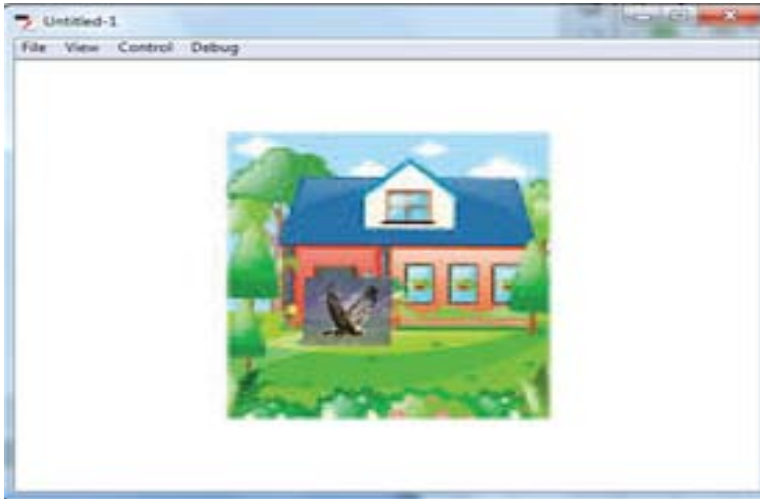

Figure 13.46: Changing moving position

Step15: Select File and click on Export movie, Rename the file and Click Save to specified folder

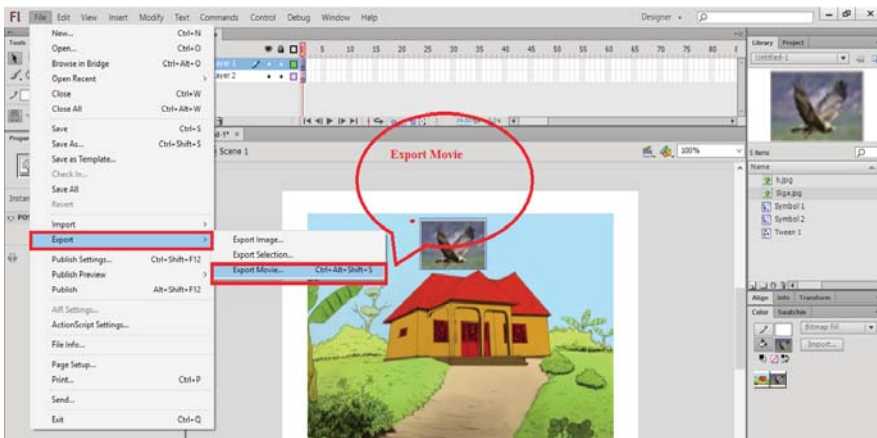

Figure 13.47: Export movie

b. Deleting unwanted clip video

The universal character of AVS Video Converter is probably the main secret of its popularity. This compact tool is ideal not only for converting files, it can also be used for simple video editing and burning the resulting videos to discs.

The **Edit** function is the one that causes most of the problems as it implies working with the timeline. The following guides will give some tips on editing video

with AVS Video Converter, in particular, on how to delete unnecessary parts from files.

Step 1: Run AVS Video Converter and select your input video file

To select a video you would like to convert hit the **Browse...** button next to the **Input File Name** field. In the opened Windows Explorer window browse for the necessary video file:

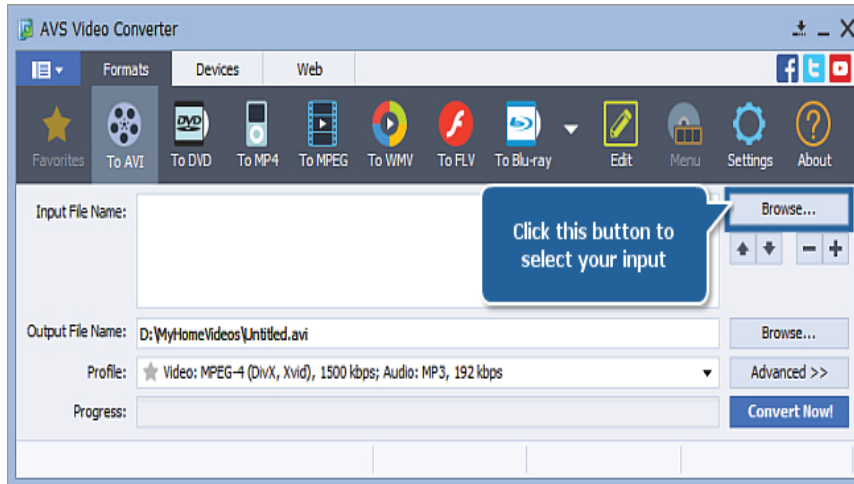

Figure 13.48: Video input

Step 2: Switch to the Edit area

Once the input video is loaded, press the **Edit** button on the **Main Toolbar** to open the **Edit Input File(s)** window.

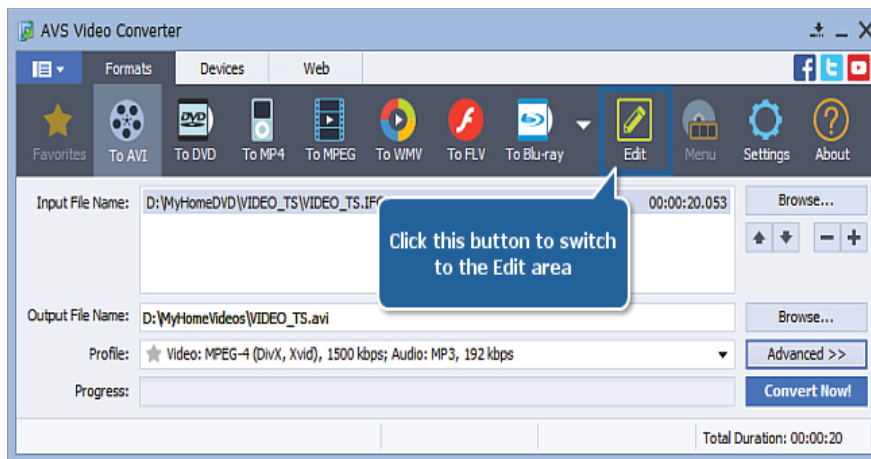

Figure 13.49: Editing Area

The video file(s) you loaded into the software will be represented on the Timeline. The following **components** will help **navigate the video**:

1. The **Timeline Scale** in the upper part of the **Timeline** shows the file in its chronological sequence – in hh.mm.ss format. Use the Zoom slider on the right to zoom in or **zoom** out the scale.
2. The **Preview Area** located in the right part of the **Edit Input File(s)** screen allows you to visually control the editing process. The current position of the cursor is always displayed in this area. By default it displays the very first frame of the video you imported into the program.

Step 3: Delete a part of the video file: set start/end of the deletion area

Navigate the file (use the tips provided at **Step 3**) to find the initial moment of the episode you wish to cut out. Left-click on the timeline to place a cursor, Use playback controls located in the **Preview Area**, hotkeys or simply drag the cursor to adjust its position. When ready, press **Trim Start** right above the timeline to set the initial point of the area you wish to delete. Perform the same actions to find the final point of the area you wish to delete. Press the **Trim End** button to set a marker.

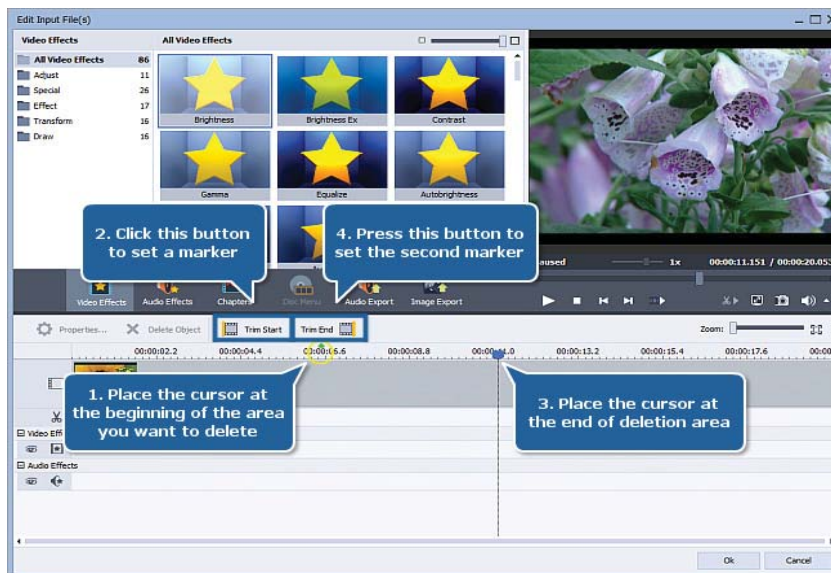

Figure 13.50 Selecting trim Area

As soon as you set the second marker, a blue-colored area will appear in the **Deletions** area highlighting the deleted part on the timeline.

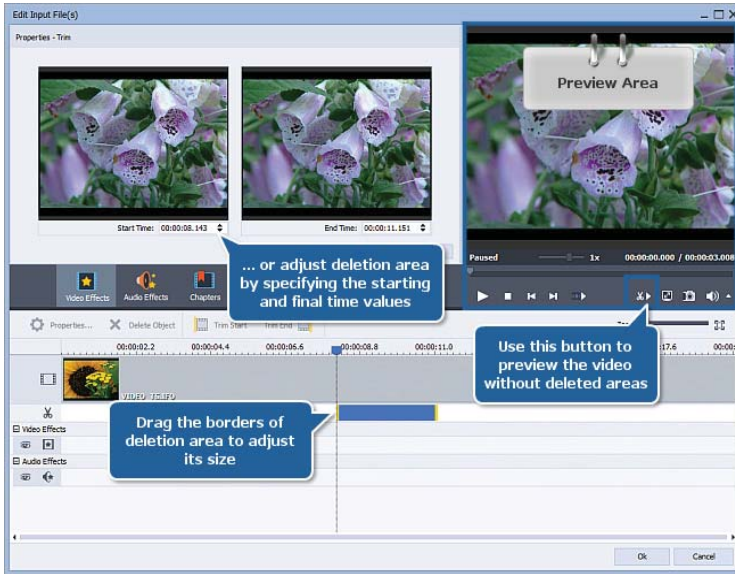

Figure 13.51: Blue color in Trim area

Note: you can add more than one area of deleting to your video just by going through the same procedure once again. The active area of deletion is marked by yellow stripes at the limits of the area.

Step 4: Delete a part of the video file: adjust the size of the selected area

You can change the size of the selected area for deletion by adjusting its borders. To adjust the borders:

- Drag the borders of the area of deletion with the mouse.
- Adjust the borders in the **Properties - Trim** window. Double-click an area of deletion to access this window. It will be displayed in the left part of the **Edit Input File(s)** screen. The **Properties - Trim** screen contains 2 windows which display the initial and final points of the area of deletion. Use the arrows or enter the hh.mm.ss manually to adjust the borders of the area.

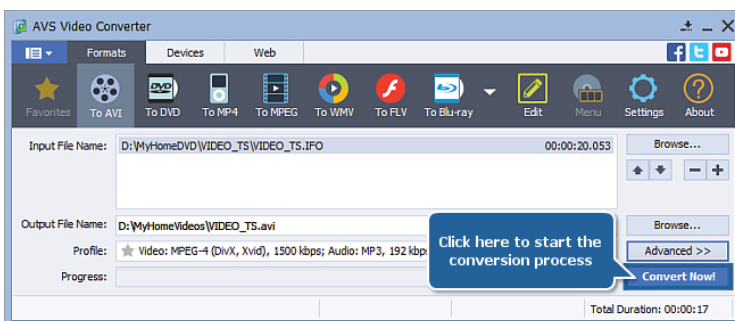



Figure 13.52: Deleting unwanted part of video

After you convert the file all the areas marked this way will disappear from the resulting file.

To preview your video without the selected areas for deletion first press **the Preview Trim Result**  button in the **Preview Area**, then click the **Play**  button.

Step 5: Convert your video

After you have set all the areas of deletion, click the **OK** button to accept the changes and close the **Edit Input File(s)** window. It will bring you back to the main screen. Configure conversion parameters as you need and press **Convert Now!**

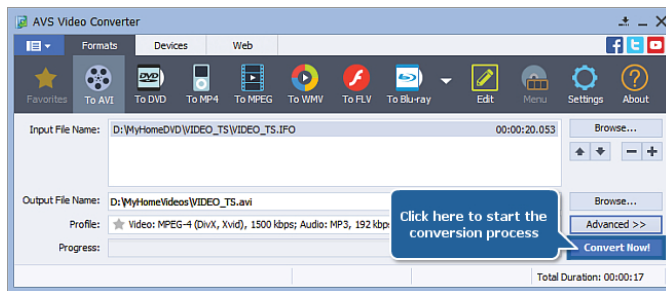

Figure 13.53: Conversion parameter setting

Wait while the software converts your video. It might take up to several hours depending on your computer capabilities. The edited video of a new format is now ready to be watched.

c. Add text with ms windows movie maker

MS Windows Movie Maker has always been one of the most popular software for simple video editing. It can join video files, lets you add audio and music to your video, apply video transitions, create slideshows and many more. The software is pretty easy to use. Here is how to add captions to video in Movie Maker:

Step 1: Open Movie Maker and add the video clips;

Step 2: Then click on **Home** tab and choose **Caption**;

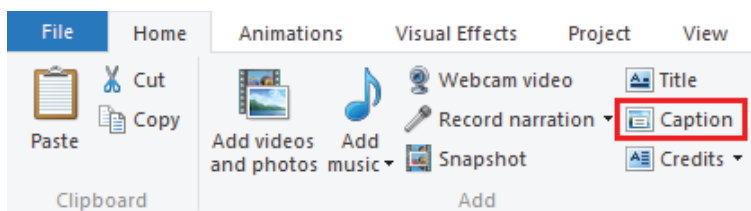

Figure 13.54: Adding caption

Step 3: As soon as you click it, Windows Movie Maker will insert a special window where you can type words for your video;

Step 4: Make edits to your caption if necessary.

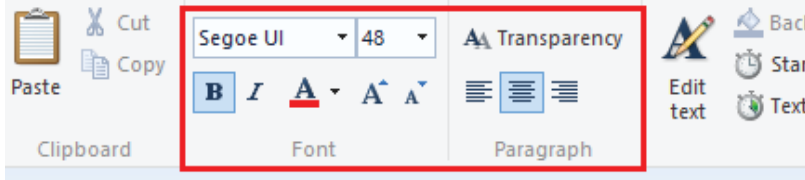

Figure 13.55: Adding word to video

Step 5: Save your video track to apply changes.

It is a convenient and simple software that provides a multi-functional message editor. You can change position, font and size. Moreover, you can choose the transition effect to your wording and make it appear in an unusual way.

d. Morphing

Morphing is a special effect in motion pictures and animations that changes (or morphs) one image or shape into another through a seamless transition. Most often it is used to depict one person turning into another through technological means or as part of a fantasy or surreal sequence.

In this practice, JockSource movie and Sheep source movie is going to be used

Begin by opening After Effects Software and importing the two Quicktime files: Jock-Source.mov and Sheep-Source.mov.

Step1: In the project window, drag one of the footage items onto the composition icon at the bottom of the window, so it creates a new composition at the same size and frame rate as the source file. The composition should be 320 x 320, square pixels at 25 fps.

Change the composition settings to have duration of six seconds, and then drag the other footage file into the composition. Call it "**Reshape-Morph project**"



Figure 13.56: Importing image to be morphed

Step2: Arrange the footage items so that the bottom layer is Jock, beginning at frame 0, and the top layer is the Sheep, starting at the three-second mark. There should be a one-second overlap, which is where the effect will take place. To make things simpler, split the Jock layer at the 3:00 point, then go to the four second mark (4:00) and split the Sheep layer, so our effect can be applied to layers only as long as it's used. From this point on, when referred to the "Jock layer" and the "Sheep layer" the one-second layers is referenced, and not the other, longer clips.

Click on graphic to view larger image.

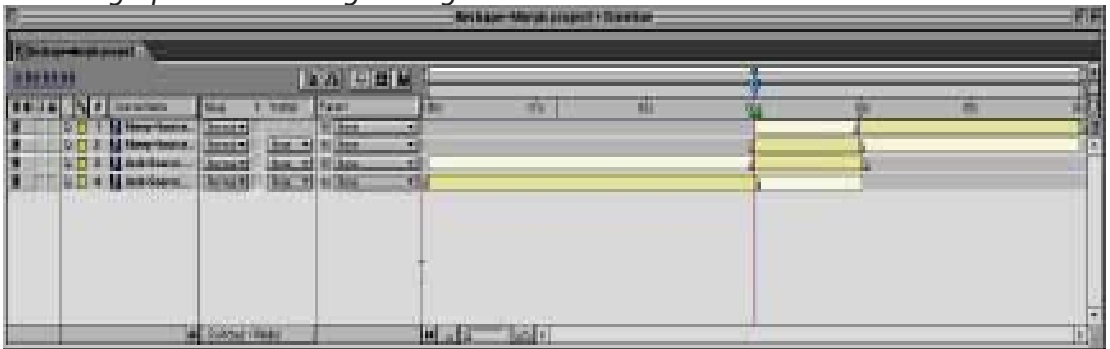

Figure 13.57: Arrangement of footage

Step3: The first step in creating morph effect is to create a mask around the object. Turn off the Sheep layer and go to the 3-second mark where the Jock layer begins. If Jock layer is selected in the timeline, pressing "i" will take to the in-point. Using the pen tool, draw a mask around Jock and make sure it is closed. It is easier to draw a mask when the image is greyscale, so click on the green button at the bottom of the composition window so the green channel will be appeared. It may

also find it easier if zoom set to 200% or even more.

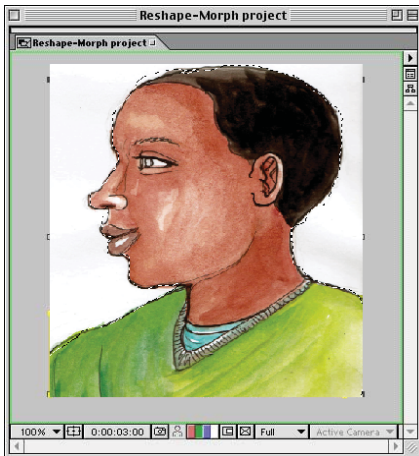

Figure 13.58: Creating mask

Step4: Because Jock moves during the one second, the shape is needed to be animated to match the mask in his movement. Press “m” to reveal the mask properties in the timeline window, and click on the stopwatch. This will add a keyframe which records the shape of the mask at the 3:00 point.

It is important to note that only masks is needed to define the shapes which are going to be morphed, there is no need masks which act as masks cut out the background. So where it says “add”, select “none” from the mask menu to turn off the mask, otherwise clip fine detail from the edge of Jock’s face. Clicking on the name of the mask, which by default is “Mask 1” and then pressing “enter” will allow to rename the mask to avoid confusion later, so call it “Jock shape”.



Figure 13.59: Adding keyframe

Step5: Press the “o” key to go to the out-point of the Jock layer, which is 3:24. Using the selection tool, adjust the mask to match Jock’s position in this frame. He hasn’t moved very much and it’s really only the profile of his face which needs to be changed. After Effects will automatically add another keyframe for the new mask shape, and it will animate the shape over time.

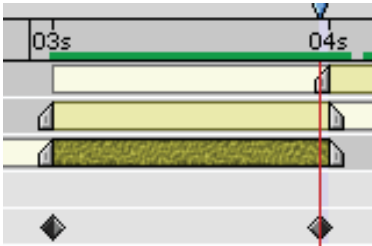

Figure 13.60: Adjusting the mask to match Jock's position in his frame

If the timeline is scrubbed, the mask animates over the one-second period, it matches Jock pretty well. It is not necessary to adjust the mask any further.

Step6: The next step is to do the same thing for the Sheep layer. Draw a closed mask around the Sheep, enable mask animation with a keyframe at 3:00 and then move to 3:24 and adjust the mask to match.

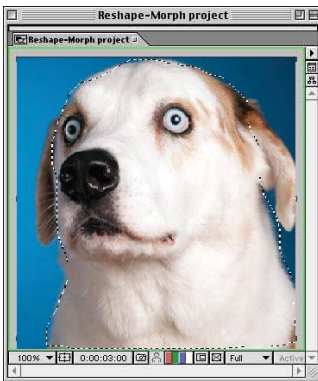

Figure 13.61: Mask the Sheep layer

Unlike Jock, the mask with only two keyframes doesn't fit the Sheep that accurately as it animates, so at 3:10 and 3:20, tweak the shape of the mask to match the Sheep's movement. Rename the mask to "Sheep Shape" and ensure the mask mode is "none" and not "add".

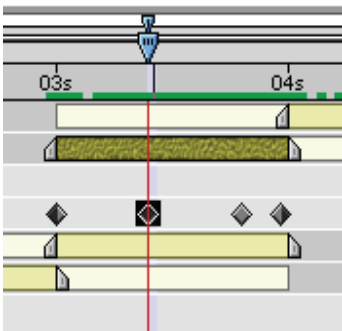

Figure 13.62: tweak the shape of the mask to match the Sheep's movement

Once masks are outline two subjects and animate over time to match their movement, begin on the actual morph effect.

Step7: Copy and paste each mask onto the other layer, so that both layers have both masks. Rename the layers once pasted them (they default back to “Mask 2”) and turn them off by selecting “none” from the mask menu.

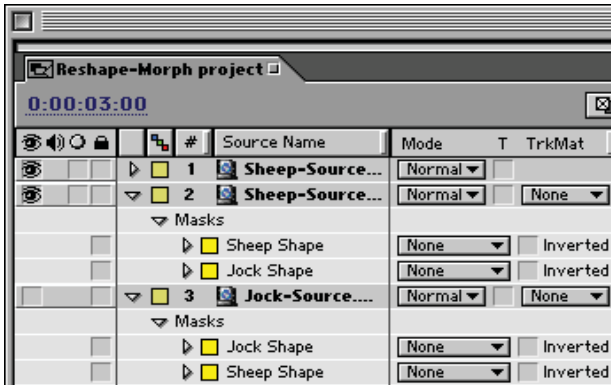

Figure 13.63: Copy and paste each mask onto the other layer

In the composition window, you should now see the shapes of the two masks overlapping the footage items.

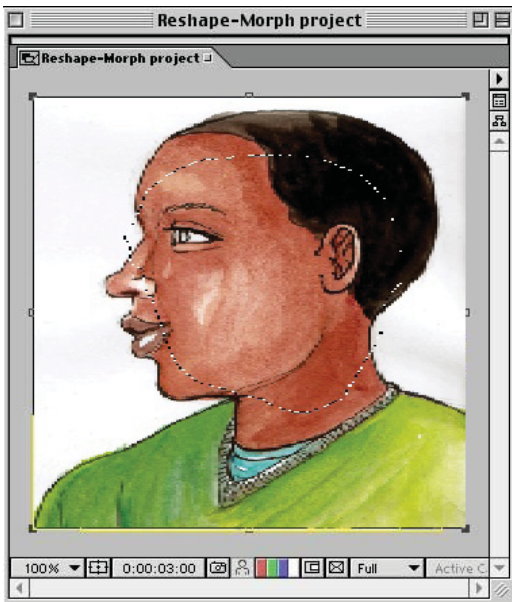

Figure 13.64: the two masks overlapping the footage items.

Turn off the visibility of the Sheep layer, select the Jock layer and apply the Reshape effect from the “Distort menu”.

Step8: Change the defaults. Change the “source mask” to “Jock Shape”. This is the starting point which is defining the parts of the image to be morphed.



Figure 13.65: Changing the source mask

Step9: Change the “destination mask” to “Sheep Shape” everything that is inside the “Jock Shape” masks namely Jock to be wrapped into the shape defined by the Sheep Shape mask. Change the boundary mask to “none” this can be used to confine the area which is effected by the Reshape effect, but because the footage is on a keyed unused background. If the Reshape effect is used on images which are not keyed, add boundary mask to prevent the background from becoming distorted by the Reshape effect.

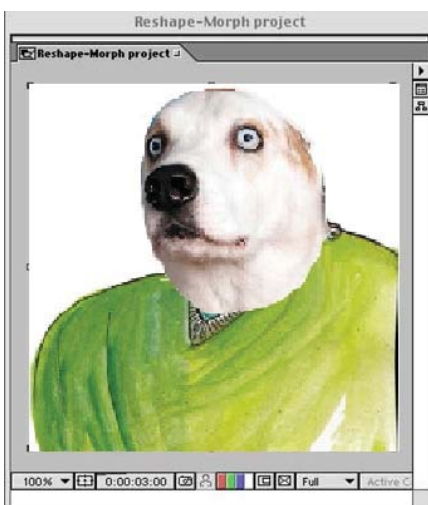

Figure 13.66: Morphed image

Application Activity 13.6.

1. In computer lab, download adobe flash software, movie maker and install it in your computer and do the following:
 - a. Use a smartphone/ digital camera to record a simple video
 - b. Import the recorded video and do all necessary operation to be an audible or quality video.
 - c. Create animation from static object
 - d. Set different frames for creating Video clips
 - e. Delete unwanted clips
 - f. Create morphing
2. Make a movie where you show the life of students at your school

End unit assessment

Question 1: What are advantages and disadvantages of Multimedia?

Question 2: How many production teams are needed in Multimedia Production?
State them

Question 3: Download an image of a Sheep. Using multimedia editing software, animate from frame 0 to 80 by drawing the line where it will pass through.

Question 4: How 2-D animations are classified?

Question 5: What are the uses of hyperlinks?

Question 6: What are the uses of Morphing and Warping?



UNIT 14

FILE HANDLING IN C++

UNIT 14: FILE HANDLING IN C++

Key unit competency

Open, close, create a data file in C++ and read, write and append data to Files

Introductory Activity

Observe the figure below and answer the following questions.

1. What do you understand by file?
2. Provide two examples of files.
3. How do we store files?
4. What do you understand by file size?
5. Create "BOOK.txt" file.
6. Put some text in the file created above
7. Write a function in C++ to count the number of uppercase alphabets present in a text file "BOOK.txt".
8. Write a function in C++ to count letters present in a text file "BOOK.txt".
9. Write a function in C++ to count digits present in a text file "BOOK.txt".
10. Write a function in C++ to count white spaces present in a text file "BOOK.txt"
11. Write a function in C++ to count vowels present in a text file "BOOK.txt".

14.1. Understanding files

Learning Activity 14.1.

1. Explain the types of files
2. Provide one example of each file type
3. Discuss the role of file name
4. Differentiate text file from binary files

Every program or sub-program consists of two major components: algorithm and data structures.

The algorithm takes care of the rules and procedures required for solving the problem and the data structures contain the data. The data is manipulated by the procedures for achieving the goals of the program.

A data structure is volatile by nature in the sense that its contents are lost as soon as the execution of the program is over. Similarly, an object also loses its states after the program is over. To store permanently the data or to create persistent objects it becomes necessary to store the same in a special data structure called file. The file can be stored on a second storage media such as hard disk. In fact, vary large data is always stored in a file.

14.1.1. File

A file is a self-contained piece of information available to the operating system and any number of individual programs. A computer file can be thought of much like a traditional file that one would find in an office's file cabinet. Just like an office file, information in a computer file could consist of basically anything.

Whatever program uses an individual file is responsible for understanding its contents. Similar types of files are said to be of a common "format." In most cases, the easiest way to determine a file's format is to look at the **file's extension**.

Each individual file in Windows will also have a file attribute which sets a condition to the specific file. For example, you can't write new information to a file that has the read-only attribute turned on.

A file name is just the name that a user or program gives the file to help identify what it is. An image file may be named something (example of file name with extension: kids-lake-2017.jpg). The name itself doesn't affect the contents of the file, so even if a video file is named something like image.mp4, it doesn't mean it's suddenly a picture file.

Files in any operating system are stored on hard drives, optical drives, and other storage devices. The specific way a file is stored and organized is referred to as a file system.

Examples of Files:

An image copied from a camera to a computer may be in the **JPG** or **TIF** format. These are files in the same way that videos in the **MP4** format, or **MP3** audio files, are files. The same holds true for **DOC/DOCX** files used with Microsoft Word, **TXT** files that hold plain text information, etc.

Though files are contained in folders for organization (like the photos in your Pictures folder or music files in your iTunes folder), some files are in compressed folders, but they're still considered files. For example, a **ZIP** file is basically a folder that holds other files and folders but it actually acts as a single file.

Another popular file type similar to **ZIP** is an **ISO** file, which is a representation of a physical disc. It's just a single file but it holds all the information found on a disc, like a video game or movie.

From these few examples, it is clear that not all files are alike, but they all share a similar purpose of holding information together in one place.

14.1.2. Types of files:

a. A. Binary Files

Binary files typically contain a sequence of bytes, or ordered groupings of eight bits. When creating a custom file format for a program, a developer arranges these bytes into a format that stores the necessary information for the application. Binary file formats may include multiple types of data in the same file, such as image, video, and audio data. This data can be interpreted by supporting programs, but will show up as garbled text in a text editor. Below is an example of a .PNG image file opened in an image viewer and a text editor.

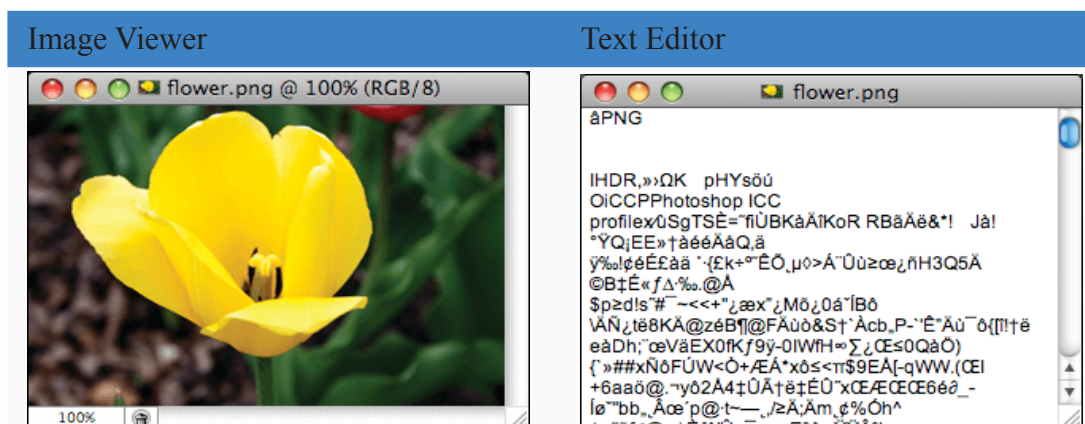

As it is seen, the image viewer recognizes the binary data and displays the picture. When the image is opened in a text editor, the binary data is converted to unrecognizable text. However, some of the text is readable. This is because the PNG format includes small sections for storing textual data. The text editor, while not designed to read this file format, still displays this text when the file is opened. Many other binary file types include sections of readable text as well. Therefore, it may be possible to find out some information about an unknown binary file type by opening it in a text editor.

Binary files often contain headers, which are bytes of data at the beginning of a file that identifies the file's contents. Headers often include the file type and other descriptive information. For example, in the image above, the "PNG" text indicates the file is a PNG image. If a file has invalid header information, software programs may not open the file or they may report that the file is corrupted.

b. Text Files

Text files are more restrictive than binary files since they can only contain textual data. However, unlike binary files, they are less likely to become corrupted. While a small error in a binary file may make it unreadable, a small error in a text file may simply show up once the file has been opened. This is one of reasons Microsoft switched to a compressed text-based XML format for the Office 2007 file types.

Text files may be saved in either a plain text (.TXT) format or rich text (.RTF) format. A typical plain text file contains several lines of text that are each followed by an End-of-Line (EOL) character. An End-of-File (EOF) marker is placed after the final character, which signals the end of the file. Rich text files use a similar file structure, but may also include text styles, such as bold and italics, as well as page formatting information. Both plain text and rich text files include a (character encoding| character encoding) scheme that determines how the characters are interpreted and what characters can be displayed.

Since text files use a simple, standard format, many programs are capable of reading and editing text files. Common text editors include Microsoft Notepad and WordPad, which are bundled with Windows, and Apple TextEdit, which is included with Mac OS X.

c. The difference between binary and text files

All files can be categorized into **one of two file formats**: binary or text. The two file types may look the same on the surface, but they encode data differently. While both binary and text files contain data stored as a series of bits (binary values of 1s and 0s), the bits in text files represent characters, while the bits in binary files represent custom data.

While text files contain only textual data, binary files may contain both textual and custom binary data.

Application Activity 14.1.

1. Discuss text files and provide two examples.
2. Describe binary files and provide two examples.
3. Explain the role of file extension
4. Where are files stored?

14.2. File Streams

Learning Activity 14.2.

1. Define a stream
2. Compare input and output stream
3. List any 3 basic operations of streams
4. Interpret the following code segment and explain what should be its output once executed

```
void readfile()
{
    ifstream fin;
    fin.open("Text1.Txt");
    if (!fin)
    { cout<<"error in opening file";
      exit(1); }
    char ch;
    while(!fin.eof())
    {
        fin.getc(ch);
        cout<<ch;}
    fin.close();
    getch(); }
```

5. Interpret the following code segment and explain what should be its output once executed
- ```
void readword()
```

```
{
 ifstream fin;
 fin.open("Text1.Txt");
 if(!fin)
 { cout<<"error in opening file";
 exit(1); }
 char w[20];
 while(!fin.eof())
 {
 fin>>w;
 if(isupper(w[0]))
 cout<<w<<' ';
 }fin.close();
 }
 getch(); }
```

### 14.2.1. Introduction

One of the great strengths of C++ is its I/O system, IO Streams. As Bjarne Stroustrup says in his book "The C++ Programming Language", "Designing and implementing a general input/output facility for a programming language is notoriously difficult". He did an excellent job, and the C++ IOstreams library is part of the reason for C++'s success. IO streams provide an incredibly flexible yet simple way to design the input/output routines of any application.

**IOstreams can be used for a wide variety of data manipulations to the following features:**

A 'stream' is internally nothing but a series of characters. The characters may be either normal characters (char) or wide characters (wchar\_t). Streams provide users with a universal character-based interface to any type of storage medium (for example, a file), without requiring the to know the details of how to write to the storage medium. Any object that can be written to one type of stream, can be written to all

types of streams. In other words, as long as an object has a stream representation, any storage medium can accept objects with that stream representation.

Streams work with built-in data types, and the user can make user-defined types work with streams by overloading the insertion operator (<<) to put objects into streams, and the extraction operator (>>) to read objects from streams.

The stream library's unified approach makes it very friendly to use. Using a consistent interface for outputting to the screen and sending files over a network makes life easier. The programs below will show what is possible.

### **14.2.2. Meaning of input and output**

The input is whatever the user enters through a keyboard or any other input devices while output what is written (displayed) on a output device being screen, printer or file. The information input or output is considered as a stream of characters. Suppose that the user enters the number 7479. The set of 4 characters: '7', '4', '7' and '9' taken as input can be considered as numbers or a string. the input characters must be put into a recognizable data type for them to be of any use other than as a character array.

IO streams not only define the relation between a stream of characters and the standard data types but also allows the user to define a relationship between a stream of characters and its classes. It also allows the user nearly limitless freedom to manipulate those streams both using object oriented interfaces and working directly on character buffers when necessary

### **14.2.3. Working with streams**

Streams are serial interfaces to storage, buffers files, or any other storage medium. The difference between storage media is intentionally hidden by the interface; the user may not even know what kind of storage he/she is working with but the interface is exactly the same.

The "serial" nature of streams is a very important element of their interface. The user cannot directly make random access: random reads or writes in a stream (unlike, say, using an array index to access any wanted value) although he/she can seek to a position in a stream and perform a read at that point.

Using a serial representation gives a consistent interface for all devices. Many devices have the capability of both producing and consuming data at the same time; if data is being continually produced, the simplest way to think about reading that data is by doing a fetch of the next characters in a stream. If that data hasn't been produced yet (the user hasn't typed anything, or the network is still busy processing a packet), he/she waits for more data to become available, and the read will return that data. Even if he/she tries to seek past the end (or beginning) of a stream, the stream pointer (i.e. get or put pointer) will remain at the boundary, making the situation safe. (Compare this with accessing data off the end of an array, where the behavior is undefined.)

The underlying low-level interface that corresponds to the actual medium very closely is a character buffer (the stream buffer, technically called the streambuf), which can be thought of as the backbone of the stream. Being a buffer, it does not hold the entire content of the stream, if the stream is large enough, so you can't use it for random access.

#### **14.2.4. The most important of the basic stream operations are**

First, the stream is initialized with the appropriate type (like a `std::string` for a `stringstream` and the filename for an `fstream`) of values and suitable modes (like `ios::in` for input and `ios::out` for output and many more depending on the type of the stream).

After that, the user can specify where the I/O should occur, through the get and put pointers. Depending on how the stream is opened, the location may already be set appropriately (for example, if a file is opened with `ios::app`, the get pointer sets at the end of the stream, allowing appends).

#### **14.2.5. Functions of file stream classes**

##### **14.2.5.1. Introduction**

In this brief introduction, the basic operations on both text and binary files are discussed so that the functions to carry out these tasks are well understood.

##### ***The Basic File Operations on Text Files are:***

- **Creating an empty file** – First time when a file is created with some valid



filename it is empty therefore it contains only EOF marker and a location pointer pointing to it.

- **Opening a file** – A file is opened for reading/writing or manipulation of data on it. If a file exists then only it can be opened, when a file is opened the location pointer points to the Beginning of file.
- **Closing a file** – After the file operations done, the file should be closed. If we don't close the file it gets automatically closed when the program using it comes to an end.
- **Writing text into file** – Once a file is created, data elements can be stored to it permanently. The already existing contents are deleted if we try to write data to it next time, rather we can append data to it and keep the existing data.
- **Reading of text from an already existing text file** (accessing sequentially)
- **Manipulation of text file from an already existing file** – An existing file is opened first and then the manipulation is done in sequential order. for example – counting of words.
- **Detecting EOF** – When the data from the file is read in sequential order, the location pointer will reach to the end of file. After reaching at the EOF no attempt should be made to read data from the file.
- **Copying of one text file to other text file**

***The Binary file operations are:***

1. **Creation of file** – A binary file is always opened in binary mode for both reading or writing. Upon successful creation, the pointer is set to the beginning of the file.
2. **Writing data into file** – A binary file is opened in output mode for writing data in it. A binary file contains non readable characters and write() function is used to write the records into file.
3. **Searching for required data from file** – a binary file is opened in input mode for searching data. The file can be read sequentially one by one each record or randomly by going to that particular location.
4. **Appending data to a file** – appending means addition of new records to an already existing file.
5. **Insertion of data in sorted file**
6. **Deletion of data**
7. **Modification/Updation of data**

### 14.2.6. Components of c++ to be used with file handling

In C++ file input/output facilities are performed by a header file `fstream.h`, which exists in the C++ standard library. C++ provides specific classes for dealing with user defined streams. Every file in C++ is linked to a stream. A stream must be obtained before opening a file. The file `fstream.h` is inherited from `iostream.h`, thus includes all the classes included in `iostream.h`.

#### **User defined streams – The four classes for file Input/Output are :**

- a. `ifstream` – derived from `istream` and used for file input(reading). It inherits the functions `get()`, `getline()` and `read()` and functions supporting random access(`seekg()` and `tellg()`) and `>>` operator. It also contains `open()`,`close()` and `eof()`.
- b. `ofstream` – derived from `ostream` and used for file output(writing). It inherits the functions `put()` and `write()` functions along with functions supporting random access (`seekp()` and `tellp()`) from `ostream` class. It also contains `open()`,`close()` and `eof()`.
- c. `fstream` – derived form `iostream` and used for both input and output. It inherits all the functions from `istream` and `ostream` classes through `iostream.h`.
- d. `Filebuf` – it sets the buffers to read and write and contains `close()` and `open()` member functions in it.

### 14.2.7. Text File Operations

#### 14.2.7.1. Reading Operation

- a. **Reading a File Character by character (including space,'\\n','\\t')**

#### **Example:**

Observe the following C++ program, interpret it and thereafter run it.

```
#include <iostream>
#include <fstream>
#include <string>
using namespace std;
int main () {
 string line;
 ifstream myfile ("example.txt");
```

```

if (myfile.is_open())
{
while (getline (myfile,line))
{
cout << line <<'\n';
}
myfile.close();
}
else cout <<"Unable to open file";
return 0;
}

```

Explanations on how to write a program that reads from a file.

| Example                                                                                                                                                                                                             | Descriptions                                                                                                                                                                                                                                                                                                                                               |
|---------------------------------------------------------------------------------------------------------------------------------------------------------------------------------------------------------------------|------------------------------------------------------------------------------------------------------------------------------------------------------------------------------------------------------------------------------------------------------------------------------------------------------------------------------------------------------------|
| <pre> void readfile() { ifstream fin; fin.open("Text1.Txt"); if(!fin) { cout&lt;&lt;"error in opening file"; exit(1); } char ch; while(!fin.eof()) { fin.getc(ch); cout&lt;&lt;ch; } fin.close(); getch(); } </pre> | <p>Create input file object</p> <p>Open the file, input and text mode is default mode</p> <p>Check for file opening</p> <p>Declare a character</p> <p>Reading the file until end of file encountered</p> <p>Read the character from file and the character is stored in the memory.</p> <p>Display the character on the screen.</p> <p>Close the file.</p> |

**b. Reading a text file character by character excluding space.**

Step 1 to 5 from the previous question is same, only the file name to be opened can be changed. To read only character >> **operator is used i.e. fin>>ch will only read a single character.** Once the character is read from the file it gets stored in the variable, and can be used according to question. Some of the possibilities are given below:

1. Uppercase character – if(isupper(ch))
2. Lowercase Character – if(islower(ch))
3. Digit – if(isdigit(ch))
4. Vowel/Consonant/any single character

The question can be asked to count/display the desired character.

Example:

**c. Reading a text file word by word which starts with uppercase letter**

```
void readword()
{
 ifstream fin;
 fin.open("Text1.Txt");
 if(!fin)
 { cout<<"error in opening file";
 exit(1); }
 char w[20];
 while(!fin.eof())
 {
 fin>>w;
 if(isupper(w[0]))
 cout<<w<<' ';
 }
 fin.close();
 getch(); }
```

Description:

Step 1 to 5 are same.

6. read word from file.

7, Display on the screen.

Note :- Once the word is in memory desired operation can be done for ex. counting of words, counting of words starting with vowel/uppercase/lowercase/any specific character or ending with vowel/uppercase/lowercase/any specific character.

Never compare string(word) with == sign use strcmp/strcmpi function.

|                                                                                                                                                                                                                                                                                                                                                                                                               |                                                                                                                                                                                                                                                                                                                                                                                                                                              |
|---------------------------------------------------------------------------------------------------------------------------------------------------------------------------------------------------------------------------------------------------------------------------------------------------------------------------------------------------------------------------------------------------------------|----------------------------------------------------------------------------------------------------------------------------------------------------------------------------------------------------------------------------------------------------------------------------------------------------------------------------------------------------------------------------------------------------------------------------------------------|
| <p>Example:</p> <p><b>D. Reading text file line by line and count the number of lines.</b></p> <pre> void readline() {     ifstream fin;     fin.open("Text1.Txt");     if(!fin)     { cout&lt;&lt;"error in opening file";       exit(1); }     char line[80];     while(!fin.eof())     {         fin.getline(line,80);         cout&lt;&lt;line&lt;&lt;"\n ";     }     fin.close();     getch(); } </pre> | <p>Description:</p> <p>Step 1 to 5 are same.</p> <p>6. read a line from file.<br/>7, Display on the screen.</p> <p>Note :- Once the line comes in memory desired operation can be done for ex. counting of lines, counting of lines starting with vowel/uppercase/lowercase/any specific character or ending with vowel/uppercase/lowercase/any specific character. Never compare string(word) with == sign use strcmp/strcmpi function.</p> |
|---------------------------------------------------------------------------------------------------------------------------------------------------------------------------------------------------------------------------------------------------------------------------------------------------------------------------------------------------------------------------------------------------------------|----------------------------------------------------------------------------------------------------------------------------------------------------------------------------------------------------------------------------------------------------------------------------------------------------------------------------------------------------------------------------------------------------------------------------------------------|

#### 14.2.7.2. Writing in Text File

##### Example:

Observe the following C++ program, interpret it and thereafter run it:

```

#include <iostream>
#include <fstream>
using namespace std;
int main () {
 ofstream myfile;
 myfile.open ("example.txt");
 myfile <<"Writing this to a file.\n";
 myfile.close();
 return 0;
}

```

|                                                                                                                                                                                                                                                                           |                                                                                                                                                                                                                                                                                                                          |
|---------------------------------------------------------------------------------------------------------------------------------------------------------------------------------------------------------------------------------------------------------------------------|--------------------------------------------------------------------------------------------------------------------------------------------------------------------------------------------------------------------------------------------------------------------------------------------------------------------------|
| <p>Example:</p> <pre> void writefile() { ofstream fout; fout.open("Text1.Txt"); if(!fout) { cout&lt;&lt;"error in opening file"; exit(1); } char line[80]; cout&lt;&lt;"enter a line"; cin.getline(line,80); fout&lt;&lt;line&lt;&lt;\n'; fout.close(); getch(); } </pre> | <p>Description:</p> <p>Create output file object using ofstream class.</p> <p>Open the file, output and text mode is default mode</p> <p>Check for file opening</p> <p>Declare a line/word/character</p> <p>Accept the variable.</p> <p>Write to file.(Similar to write to screen using cout)</p> <p>Close the file.</p> |
|---------------------------------------------------------------------------------------------------------------------------------------------------------------------------------------------------------------------------------------------------------------------------|--------------------------------------------------------------------------------------------------------------------------------------------------------------------------------------------------------------------------------------------------------------------------------------------------------------------------|

Example:

Observe the following C++ program, interpret it and thereafter run it:

```

#include <iostream>
#include <fstream>
using namespace std;
int main () {
 ofstream myfile ("example.txt");
 if (myfile.is_open())
 {
 myfile <<"This is a line.\n";
 myfile <<"This is another line.\n";
 myfile.close();
 }
 else cout <<"Unable to open file";
 return 0;
}

```

|                                                                                                                                                                                                                                                                                                                                                                                                                           |                                                                                                                                                                                                                                                                                                               |
|---------------------------------------------------------------------------------------------------------------------------------------------------------------------------------------------------------------------------------------------------------------------------------------------------------------------------------------------------------------------------------------------------------------------------|---------------------------------------------------------------------------------------------------------------------------------------------------------------------------------------------------------------------------------------------------------------------------------------------------------------|
| <p><b>Example:</b></p> <p><b>Copying of text file to another file (only lines which start with uppercase characters)</b></p> <pre>void copyline() {     ifstream fin;     fin.open("Text1.Txt");//file to be read     if(!fin)     { cout&lt;&lt;"error in opening file";       exit(1); }     ofstream fout;     fout.open("Text2.Txt");     if(!fout)     { cout&lt;&lt;"error in opening file";       exit(1); }</pre> | <pre>char line[80]; while(!fin.eof()) {     fin.getline(line,80);     if(isupper(line[0]))     fout&lt;&lt;line&lt;&lt;"\n "; } fin.close(); fout.close(); getch(); }</pre> <p>Read the file until eof() and read character/word/line from file , apply the condition if asked and write to another file.</p> |
|---------------------------------------------------------------------------------------------------------------------------------------------------------------------------------------------------------------------------------------------------------------------------------------------------------------------------------------------------------------------------------------------------------------------------|---------------------------------------------------------------------------------------------------------------------------------------------------------------------------------------------------------------------------------------------------------------------------------------------------------------|

Binary Files are also called fixed length files or packed files as all the fields in a binary file occupy fixed number of bytes.

**For Opening files C++ provides mechanism for opening file in different modes:**

| Mode          | Behavior                                                   |
|---------------|------------------------------------------------------------|
| ios::in       | Opens the file for reading.                                |
| ios::out      | Open for writing(previous contents erased)                 |
| ios::ate      | Go to end of the file at the time of opening the file.     |
| ios::app      | If the file already exists , then its contents get erased. |
| ios::nocreate | If the file does not exist then open operation fails.      |
| ios :: binary | File is opened in binary file.                             |

**Note:**

A file can be opened in more than one modes by making use of pipe sign as follows:

```
fstream file("ABC",ios::in|ios::binary|ios::out);
```

### 14.2.7.3. Writing class object to binary File

|                                                                                                                                                                                                                                                                                                                                                                                    |                                                                                                                                                                                                                                                                                                                                                                                                                          |
|------------------------------------------------------------------------------------------------------------------------------------------------------------------------------------------------------------------------------------------------------------------------------------------------------------------------------------------------------------------------------------|--------------------------------------------------------------------------------------------------------------------------------------------------------------------------------------------------------------------------------------------------------------------------------------------------------------------------------------------------------------------------------------------------------------------------|
| <p>Example:</p> <pre>void writefl() { ofstream                                fout("Stud. dat",ios::binary ios::out ios::app); If(!fout) { cout&lt;&lt;"error in opening file"; exit(1); } Stud s; char choice='y'; do{ s.getdata(); fout.write((char*)&amp;s,sizeof(s)); cout&lt;&lt;"do you want to add more records"; cin&gt;&gt;choice; }while(ch=='y'); fout.close(); }</pre> | <p>Description:</p> <p>Steps:</p> <ol style="list-style-type: none"><li>1. Open the file in output and binary mode.(append mode for addition of records)</li><li>2. Create class Objects</li><li>3. Call the class function which accepts data from keyboard.</li><li>4. Write the records using write function.</li><li>5. Do steps 3,4 repeatedly until user wants to add records</li><li>6. Close the file.</li></ol> |
|------------------------------------------------------------------------------------------------------------------------------------------------------------------------------------------------------------------------------------------------------------------------------------------------------------------------------------------------------------------------------------|--------------------------------------------------------------------------------------------------------------------------------------------------------------------------------------------------------------------------------------------------------------------------------------------------------------------------------------------------------------------------------------------------------------------------|

#### a. Writing class object to binary File (assuming student class ) and function is a member function

|                                                                                                                                                                                                                                                                                                                                                                                                                                                                   |                                                                                                                                                                                                                                                                                                                                                                                                                          |
|-------------------------------------------------------------------------------------------------------------------------------------------------------------------------------------------------------------------------------------------------------------------------------------------------------------------------------------------------------------------------------------------------------------------------------------------------------------------|--------------------------------------------------------------------------------------------------------------------------------------------------------------------------------------------------------------------------------------------------------------------------------------------------------------------------------------------------------------------------------------------------------------------------|
| <p>Example:</p> <pre>void student::writefl() { ofstream                                fout("Stud. dat",ios::binary ios::out ios::app); If(!fout) { cout&lt;&lt;"error in opening file"; exit(1); } Stud s; char choice='y'; do{ cout&lt;&lt;"Enter name"; gets(name); cout&lt;&lt;"Enter average"; cin&gt;&gt;avg; fout.write((char*)&amp;s,sizeof(s)); cout&lt;&lt;"do you want to add more records"; cin&gt;&gt;choice; }while(ch=='y'); fout.close(); }</pre> | <p>Description:</p> <p>Steps:</p> <ol style="list-style-type: none"><li>1. Open the file in output and binary mode.(append mode for addition of records)</li><li>2. Create class Objects</li><li>3. Call the class function which accepts data from keyboard.</li><li>4. Write the records using write function.</li><li>5. Do steps 3,4 repeatedly until user wants to add records</li><li>6. Close the file.</li></ol> |
|-------------------------------------------------------------------------------------------------------------------------------------------------------------------------------------------------------------------------------------------------------------------------------------------------------------------------------------------------------------------------------------------------------------------------------------------------------------------|--------------------------------------------------------------------------------------------------------------------------------------------------------------------------------------------------------------------------------------------------------------------------------------------------------------------------------------------------------------------------------------------------------------------------|



## b. Writing Structure object to binary File (assuming student is structure, containing name and avg as members)

|                                                                                                                                                                                                                                                                                                                                                                                                                                        |                                                                                                                                                                                                                                                                                                                                                                                                                          |
|----------------------------------------------------------------------------------------------------------------------------------------------------------------------------------------------------------------------------------------------------------------------------------------------------------------------------------------------------------------------------------------------------------------------------------------|--------------------------------------------------------------------------------------------------------------------------------------------------------------------------------------------------------------------------------------------------------------------------------------------------------------------------------------------------------------------------------------------------------------------------|
| <p>Example:</p> <pre>void writefl() { ofstream          fout("Stud. dat",ios::binary ios::out ios::app); If(!fout) { cout&lt;&lt;"error in opening file"; exit(1); } Stud s; char choice='y'; do{ cout&lt;&lt;"Enter name"; gets(s.name); cout&lt;&lt;"Enter average"; cin&gt;&gt;s.avg; fout.write((char*)&amp;s,sizeof(s)); cout&lt;&lt;"do you want to add more records"; cin&gt;&gt;choice; }while(ch=='y'); fout.close(); }</pre> | <p>Description:</p> <p>Steps:</p> <ol style="list-style-type: none"><li>1. Open the file in output and binary mode.(append mode for addition of records)</li><li>2. Create class Objects</li><li>3. Call the class function which accepts data from keyboard.</li><li>4. Write the records using write function.</li><li>5. Do steps 3,4 repeatedly until user wants to add records</li><li>6. Close the file.</li></ol> |
|----------------------------------------------------------------------------------------------------------------------------------------------------------------------------------------------------------------------------------------------------------------------------------------------------------------------------------------------------------------------------------------------------------------------------------------|--------------------------------------------------------------------------------------------------------------------------------------------------------------------------------------------------------------------------------------------------------------------------------------------------------------------------------------------------------------------------------------------------------------------------|

### 14.2.7.4. Reading a Binary File

#### Example:

Observe the following program, interpret it and run it:

```
#include <iostream>
#include <fstream>
usingnamespace std;
int main () {
streampos size;
```

```

char * memblock;
ifstream file ("example.bin", ios::in|ios::binary|ios::ate);
if (file.is_open())
{
size = file.tellg();
memblock = newchar [size];
file.seekg (0, ios::beg);
file.read (memblock, size);
file.close();
cout <<"the entire file content is in memory";
delete[] memblock;
}
else cout <<"Unable to open file";
return 0;
}

```

### a. Sequential reading

Sequential reading means reading record one by one until end of file and all the records are displayed.

|                                                                                                                                                                                                                                                                |                                                                                                                                                                                                                                                                                                                                                                                                           |
|----------------------------------------------------------------------------------------------------------------------------------------------------------------------------------------------------------------------------------------------------------------|-----------------------------------------------------------------------------------------------------------------------------------------------------------------------------------------------------------------------------------------------------------------------------------------------------------------------------------------------------------------------------------------------------------|
| <p>Example:</p> <pre> void readfl() { ifstream fout("Stud.dat",ios::binary ios::in); If(!fin) { cout&lt;&lt;"error in opening file"; exit(1); } Stud s; while(!fin.eof()) { fin.read((char*)&amp;s,sizeof(Stud)); s.display(); getch(); } fin.close();} </pre> | <p>Description:</p> <p>Steps:</p> <ol style="list-style-type: none"> <li>2. Open the file in input and binary mode.</li> <li>3. Check for file opening, if error then exit</li> <li>4. Create class Object.</li> <li>5. Read the file until End of file</li> <li>6. Call display function of class</li> <li>7. Do steps 4, 5 repeatedly until end of file reached.</li> <li>8. Close the file.</li> </ol> |
|----------------------------------------------------------------------------------------------------------------------------------------------------------------------------------------------------------------------------------------------------------------|-----------------------------------------------------------------------------------------------------------------------------------------------------------------------------------------------------------------------------------------------------------------------------------------------------------------------------------------------------------------------------------------------------------|

**Displaying selected records** -This is condition based display, where the condition is checked after reading. If the reading is concerned with reading class objects then there will be a function in class as a public member which will return that particular value that is to be evaluated. If the structure instance is to be read from file then the normal comparison can be done after executing the file read statement. If the condition is true then call display function or display the record.

### Display Records from file where average marks are greater than 60

```
void readfl()
{
ifstream fout("Stud.dat",ios::binary|ios::in);
If(!fin)
{
cout<<eror in opening file"; exit(1); }
Stud s;
while(!fin.eof())
{ fin.read((char*)&s,sizeof(Stud));
if(s.retavg(>60) // here the condition can be specified
s.display(); getch(); }
fin.close(); }
```

#### b. Random Access

Up till now we had been writing and reading the files in sequential manner but binary files, being fixed length files, provides liberty to perform read and write operations randomly. C++ provides functions for it. When you open a file operating system assigns two exclusive pointers to file object. In C++ these pointers are called get pointer(input) and put pointer(output) . These pointers provide you the facility to move to the desired place in the file to perform read, write operations. The get pointer specifies a location from where the current reading operation is initiated. The put pointer specifies a location where the current write operation will take place.

#### 14.2.7.5. Functions for manipulating file pointers

| Function | Class Members | Action Performed                                |
|----------|---------------|-------------------------------------------------|
| seekg()  | ifstream      | Moves get pointer to a specific location.       |
| seekp()  | Ofstream      | Moves put pointer to a specific location.       |
| tellg()  | ifstream      | Returns the current position of the get pointer |

| tellp()                                                                                                                                                                                                                                                   | Ofstream                                 | Returns the current position of the put pointer                                                                                                                                                                                                                                                                                                                                                             |              |           |           |                             |           |                                          |           |                       |
|-----------------------------------------------------------------------------------------------------------------------------------------------------------------------------------------------------------------------------------------------------------|------------------------------------------|-------------------------------------------------------------------------------------------------------------------------------------------------------------------------------------------------------------------------------------------------------------------------------------------------------------------------------------------------------------------------------------------------------------|--------------|-----------|-----------|-----------------------------|-----------|------------------------------------------|-----------|-----------------------|
| <p>The general syntax for seekg() and seekp() is :</p> <pre>file_object.seekg(location,origin); file_object.seekp(location,origin);</pre> <p>where location is the byte position, origin is the position from where the location is to be calculated.</p> |                                          | <table border="0"> <thead> <tr> <th>Origin Value</th> <th>Seek From</th> </tr> </thead> <tbody> <tr> <td>ios::beg:</td> <td>seek from beginning of file</td> </tr> <tr> <td>ios::cur:</td> <td>seek from current position in the stream</td> </tr> <tr> <td>ios::end:</td> <td>seek from end of file</td> </tr> </tbody> </table> <p>f.seekg(-10,ios::end) – will move 10 bytes back from end position.</p> | Origin Value | Seek From | ios::beg: | seek from beginning of file | ios::cur: | seek from current position in the stream | ios::end: | seek from end of file |
| Origin Value                                                                                                                                                                                                                                              | Seek From                                |                                                                                                                                                                                                                                                                                                                                                                                                             |              |           |           |                             |           |                                          |           |                       |
| ios::beg:                                                                                                                                                                                                                                                 | seek from beginning of file              |                                                                                                                                                                                                                                                                                                                                                                                                             |              |           |           |                             |           |                                          |           |                       |
| ios::cur:                                                                                                                                                                                                                                                 | seek from current position in the stream |                                                                                                                                                                                                                                                                                                                                                                                                             |              |           |           |                             |           |                                          |           |                       |
| ios::end:                                                                                                                                                                                                                                                 | seek from end of file                    |                                                                                                                                                                                                                                                                                                                                                                                                             |              |           |           |                             |           |                                          |           |                       |

### a. Random record reading

File pointer position is set according to the record number to be displayed. The file pointer directly can be set to the position using seekg().

Note:- when file is opened in input or output mode the file pointer is at the starting i.e. at 0 position. In append mode the file pointer is at the end of file, and the writing continues by adding the records.

```
void readrec()
{
ifstreamfin("stud.dat",ios::binary|ios::in);
stud s;
int rec;
cout<<"enter the record you want to display";
cin>>rec;
fin.seekg((rec-1)*sizeof(stud),ios::beg); // by default ios::beg is default argument
fin.read((char*)&s,sizeof(stud));
s.display();
getch();
}
```

### **b. Updation of record in existing file**

In this the record to be updated is asked from the user, then appropriate position of file pointer is obtained and pointer is set and writes operation is performed.

Eg.– writing a program to update structure/class object to update.

### **c. Insertion in Sorted file**

The record to be inserted in a sorted file is accepted as a separate object. The file in which the record is to be inserted, is opened in input mode. The records with record key smaller than the record key to be inserted are copied to temporary file and then record to be inserted is copied, following with rest of the records if any. After that original file is removed using `remove()` and temporary file is renamed with the original name with `rename()`.

### **d. Deletion of record from file**

The logic of deleting record is:

1. Accept the record key for the record you want to delete.
2. Read the file sequentially , from which the record is to be deleted and copied down the records to temporary file except the record you want to delete (by comparing the record value)
3. Remove the original file and rename the temporary file with the original file name.

Sorting the records of an existing file - First the records in the file are counted . an array of objects is created dynamically / statically with the approx. index value as compared to number of records.

And read the file using the following statement:

```
while (fin.read(char*)&obj[i++],sizeof(class));
```

After reading the file , sort the array with any sorting technique(Bubble/Insertion/Selection) Then write the sorted array in to the file opened in output mode.

### **Notes:-**

1. Multiple File Handling-

In this case the point to remember is:

a)Identify the file mode to be opened .

b) One object can open only one file at a time.

2. `sizeof()` operator gives the `sizeof` data type.
3. The data written to a file using `write()` can only be read accurately using `read()`.
4. The files are closed using destructor of file object, if not closed using `close()`. It is must to close the file. If the file pointer is opening another file in the same program otherwise it is a good practice to use `close()`.

### Learning Activity 14.2.

1. Write a C++ program to open and read text from a text file character by character in C++. We have a file named "test.txt", this file contains following text:

Hello friends, how are you?

I hope you are fine and learning well.

Thanks.

We will read text from the file character by character and display it on the output screen.

2. Using C++, create a file and then write some text into that file, after writing text file it will be closed and again file will open in read mode, read all written text.
3. Provide a C++ program to write and read variable's values in/from text file. Here you will show how to write values in file and how to access them.
4. Give a C++ program to write and read values through object in/from text files. Demonstrate how to write object value in file and how to access them.
5. The function `tellg()` and `tellp()` are predefined functions which tells (returns) the position of the get and put pointers. Write a C++ program to demonstrate example of `tellg()` and `tellp()` function.

### 14.2.7.6. Closing a file

#### a. Detecting the End of a File

The eof() member function reports when the end of a file has been encountered.

```
if (inFile.eof())
 inFile.close();
```

A File is closed by disconnecting it with the stream it is associated with. The close() function is used to accomplish this task.

Syntax:

```
Stream_object.close();
```

Example :

```
fout.close();
```

#### eof ( ) Function

This function determines the end-of-file by returning true (non-zero) for end of file otherwise returning false(zero).

#### Syntax

```
Stream_object.eof();
```

Example :

```
fout.eof();
```

#### b. Testing for Open Errors

```
dataFile.open("cust.dat", ios::in);
if (!dataFile)
{
 cout << "Error opening file.\n";
}
```

#### Another way to Test for Open Errors

```
dataFile.open("cust.dat", ios::in);
if (dataFile.fail())
{
 cout << "Error opening file.\n";
}
```

## Note on eof():

In C++, “end of file” doesn’t mean the program is at the last piece of information in the file, but beyond it. The eof() function returns true when there is no more information to be read.

### Application activity 14.3.:

1. Write a C++ program that demonstrates the declaration of an fstream object and the opening of a file.
2. Write a C++ program that demonstrates the opening of a file at the time the file stream object is declared.
3. Write a C++ program that demonstrates the close function.
4. Write C++ program that uses the << operator to write information to a file. The Program Screen Output will display:

File opened successfully.

Now writing information to the file.

Done.

And the Output to file demofile.txt will be:

Jones

Smith

Willis

Davis

5. This program writes information to a file, closes the file, then reopens it and appends more information.
6. Write a program to create a binary file ‘student.dat’ using structure.
7. Program to read a binary file ‘student.dat’ display records on monitor.
8. Write the program that writes the information to a file, closes the file, then reopens it and appends more information.
9. Provide a C++ program that will demonstrate how to write and read time in/from binary file using fstream. Remember that there will be two functions: writeTime() - that will write time into the file and readTime() - that will read time from the file. In the program, there are two things to be noticed, how time will be formatted into a string (using sprintf) and how time values will be extracted from the string (using sscanf).



10. Write a C++ program to read an employee's details from keyboard using class and object then write that object into the file. The program will also read the object and display employee's record on the screen. This program is using following file stream (file handling) functions.

There will be the following functions:

- `file_stream_object.open()` to open a file
- `file_stream_object.close()` to close the file
- `file_stream_object.write()` to write an object into the file
- `file_stream_object.read()` to read object from the file

In this program there are following details to be read through Employee class

- Employee ID
- Employee Name
- Designation
- Date of joining
- Date of birth

Observe the program segment carefully and answer the question that follows:

```
class stock
{
 int Ino, Qty; Char Item[20];
public:
 void Enter() { cin>>Ino; gets(Item); cin>>Qty;}
 void issue(int Q) { Qty+=Q;}
 void Purchase(int Q) {Qty-=Q;}
 int GetIno() { return Ino;}
};

void PurchasItem(int Pino, int PQty)
{ fstream File;
 File.open("stock.dat", ios::binary|ios::in|ios::out);
 Stock s;
 int success=0;
 while(success= 0 && File.read((char *)&s,sizeof(s)))
 {
 If(Pino== ss.GetIno())
 {
```

```

s.Purchase(PQty);
_____ // statement 1
_____ // statement 2
Success++;
}
}
if (success == 1)
cout<< "Purchase Updated"<<endl;
else
cout<< "Wrong Item No"<<endl;
File.close();
}

```

- a. Statement 1 to position the file pointer to the appropriate place so that the data updating is done for the required item.
  - b. Statement 2 to perform write operation so that the updating is done in the binary file.
1. Write C++ program that uses the file stream object's eof() member function to detect the end of the file.

## Summary:

Let us talk briefly about some key concepts of file streams discussed here above:

### **filebuf**

It sets the buffer to read and write, it contains close() and open() member functions on it.

### **fstreambase**

This is the base class for fstream and, ifstream and ofstream classes. therefore it provides the

common function to these classes. It also contains open() and close() functions.

### **ifstream**

Being input class it provides input operations it inherits the functions get( ), getline( ), read( ),

and random access functions seekg( ) and tellg( ) functions.

### **ofstream**

Being output class it provides output operations it inherits put( ), write( ) and random access

functions seekp( ) and tellp( ) functions.

### **fstream**

It is an I/O class stream, it provides simultaneous input and output operations.

### **File modes**

Meaning of file mode:

The file mode describes how a file is to be used ; to read from it, write to it, to append and so on

Syntax

```
Stream_object.open("filename",mode);
```

File Modes are briefly discussed here below:

**ios::out:** It open file in output mode (i.e write mode) and place the file pointer in beginning, if

file already exist it will overwrite the file.

**ios::in:** It open file in input mode (read mode) and permit reading from the file.

**ios::app:** It open the file in write mode, and place file pointer at the end of file i.e to add new

contents and retains previous contents. If file does not exist it will create a new file.

**ios::ate:** It open the file in write or read mode, and place file pointer at the end of

file i.e input/

output operations can be performed anywhere in the file.

**ios::trunc:** It truncates the existing file (empties the file).

**ios::nocreate:** If file does not exist this file mode ensures that no file is created and `open()` fails.

**ios::noreplace** If file does not exist, a new file gets created but if the file already exists, the `open()` fails.

**ios::binary** Opens a file in binary mode.

### Logic to read a text file:

- 1. Open file in read/input mode using `std::in`
- 2. Check file exists or not, if it does not exist terminate the program
- 3. If file exist, run a loop until EOF (end of file) not found
- 4. Read a single character using `cin` in a temporary variable
- 5. And print it on the output screen
- 6. Close the file

## End unit assessment

1. Write a function in C++ to search for details (Phoneno and Calls) of those Phones which have more than 800 calls from binary file "phones.dat". Assuming that this binary file contains records/ objects of class Phone, which is defined below.

```
class Phone
```

```
{
```

```
Char Phoneno[10]; int Calls;
```

```
public:
```

```
void Get() {gets(Phoneno); cin>>Calls;}
```

```
void Billing() { cout<<Phoneno<<"#"<<Calls<<endl;}
```

```
int GetCalls() {return Calls;}
```

```
};
```

2. Write a function in C++ to add new objects at the bottom of a binary file "STUDENT.DAT", assuming the binary file is containing the objects of the following class:

```

class STUD
{
int Rno;
char Name[20];
public:
void Enter()
{cin>>Rno;gets(Name);}
void Display(){cout<<Rno<<Name<<endl;}
};

```

3. Given a binary file PHONE.DAT, containing records of the following class type

```

class Phonlist
{
char name[20];
char address[30];
char areacode[5];
char Phoneno[15];
public:
void Register()
void Show();
void CheckCode(char AC[])
{return(strcmp(areacode,AC);
};

```

Write a function TRANSFER( ) in C++, that would copy all those records which are having areacode as "DEL" from PHONE.DAT to PHONBACK.DAT.

4. Given a binary file SPORTS.DAT, containing records of the following structure type:

```

struct Sports
{
char Event[20]; char Participant[10][30];
};

```

Write a function in C++ that would read contents from the file SPORTS.DAT and creates a file named ATHLETIC.DAT copying only those records from SPORTS.DAT where the event name is "Athletics".

5. 5. Given a binary file TELEPHON.DAT, containing records of the following

```
class Directory :
class Directory { char Name[20]; char Address[30];
char AreaCode[5]; char phone_No[15]; public;
void Register(); void Show();
int CheckCode(char AC[])
{ return strcmp(AreaCode, AC);
}
};
```

Write a function COPYABC( ) in C++, that would copy all those records having AreaCode as "123" from TELEPHON.DAT to TELEBACK.DAT.

## BIBLIOGRAPHY

1. National Curriculum Development Centre(NCDC). (2011). ICT Syllabus for Upper Secondary. Kigali.
2. applications, D. M., Tumkur, S. I., & Bangalore., V. B.-P. (n.d.). Visual Basic 6.0 A simple Approach . 3rd Main Road, Gandhinagar, Bangalore- 5600 009: Sapna Book House.
3. Byron S. GOTTFRIED, P. (n.d.). schaum's ouTlines Visual Basic.
4. Chopra, R. (2009). OPERATING SYSTEM (A PRACTICAL APP). New Delhi: S Chand & Company Pvt Ltd.
5. Dhamdhere, D. (2006). OPERATING SYSTEMS: A CONCEPT- BASED APPROACH, 2E. New Delhi: Tata McGraw Hill Publishing Company Limited.
6. Dhotre, I. A. (2009). OPERATING SYSTEMS. New Delhi: Technical Publications Pune.
7. Garrido, Schlesinger, Hoganson. (2013). MODERN OPERATING SYSTEMS 2ND EDITION. USA: Library of Congress Cataloging in Publication Data.
8. Godbole. (2011). OPERATING SYSTEM 3E. New Delhi: Tata McGraw Hill Education Private Limited.
9. Haggard, G., & Shibata, w. H. (2013). Introduction: Visual Basic6.0. bookboon.com.
10. Halvorson, M. (1999). Learn Microsoft Visual Basic 6.0 Now.
11. Khurana, R. (2011). OPERATING SYSTEMS (FOR ANNA). New Delhi: Vikas Publishing Pvt Ltd.
12. McGrath, M. (2008). Visual Basic in Easy Steps.
13. MINEDUC. (2008). Geographic and Information Systems(GIS). Kigali.
14. MINEDUC. (2013). Education Sector Strategic Plan . Kigali.
15. MINEDUC. (2014). ICT in Education Policy. Kigali: MINEDUC.
16. Ministry of Education, Sengapore,2007. (2007). Computer Applications Syllabus(Lower Secondary Technical). Sengapore: Curriculum Planning& Development Division.
17. MYICT. (2011). National ICT strategy and plan NICI III-2015.Kigali.
18. National Curriculum Development Centre(NCDC). (2006). ICT syllabus for Lower Secondary Education. Kigali.
19. Norton, P. (1998). Guide to Visual Basic 6.0.
20. Pearson Education. (2010). Computer Concepts.
21. Sharma, Varshney, Shantanu. (2010). DESIGN AND IMPLEMENTATION OF OPERATING SYSTEM. New Delhi: University Science Press.
22. University, M. (n.d.). Project NameSystem User Requirements. Project NameSystem User Requirements; Projects Office.
23. University, O. S. (2018). Single Processor Scheduling Algorithms. Retrieved March Tuesday, 2018, from Department of Computer Science and Engineering: <http://web.cse.ohio-state.edu/~agrawal.28/660/Slides/jan18.pdf>

